



Installation & Maintenance Manual



<i>1 Introduction</i>	<i>1</i>
Notices.....	1
<i>FCC Information</i>	2
About This Manual.....	3
<i>Related Documents</i> :.....	3
<i>Notes</i> :.....	4
<i>2 System Configuration</i>	<i>5</i>
System Hardware	6
<i>KSU</i>	6
<i>System Peripheral Connections</i>	7
<i>Configuration Options</i>	8
<i>Main System KSU</i>	9
<i>Expansion Module 3 x 8</i>	10
<i>Option Module</i>	11
<i>Small Business Voice Processing System</i>	12
<i>3 System Specifications</i>	<i>13</i>
Specifications	13
<i>Power Requirements</i>	13
<i>Dimensions</i>	13
<i>Mounting</i>	13
<i>Notes</i> :.....	16
<i>4 Installation</i>	<i>17</i>
Installation	17
<i>Basic Tools and Supplies</i>	17
<i>Product safety and safety guidelines</i>	17
<i>Installation Planning</i>	18
<i>Module Installation</i>	19
<i>3 x 8 Expansion Module</i>	19
<i>Option Module</i>	19
<i>Voice Processing System</i>	21
<i>Wiring and Connectors</i>	23
<i>Connecting Extensions</i>	25
<i>Station Message Detail Recording (SMDR)</i>	26
<i>Initialization Procedure</i>	27

Notes: 28

5 Telephone Operation 29

Introduction	29
<i>Navigation Keys</i>	30
<i>Feature Codes</i>	31
Feature Code Operation.....	34
<i>Accessing Specific CO Lines</i>	34
<i>Account Code</i>	34
<i>Answering Machine Emulation</i>	34
<i>Attendant</i>	35
<i>Attendant Administration (Admin.)</i>	36
<i>Authority Code (Traveling Class of Service)</i>	40
<i>Automatic Hold</i>	41
<i>Automatic Record</i>	42
<i>Automatic Selection (CO/Intercom)</i>	43
<i>Auxiliary Lamp LED Status Bar</i>	43
<i>Background Music (BGM)</i>	44
<i>Barge-In (Intrusion)</i>	44
<i>Busy Lamp Field (BLF) / Direct Station Select (DSS)</i>	45
<i>Busy Ring Allow/Deny</i>	45
<i>Call Attendant (Operator)</i>	46
<i>Call Back – Extension</i>	46
<i>Call Duration Timer (Incoming/Outgoing)</i>	47
<i>Call Forward Extension</i>	48
<i>Call Park / Call Park Answer</i>	49
<i>Call Pickup Group</i>	50
<i>Caller ID (Standard on all CO Lines)</i>	51
<i>Caller Identification - Call Log</i>	51
<i>Call Waiting</i>	52
<i>Camp On – CO Line</i>	52
<i>Conference</i>	53
<i>Data Rate</i>	54
<i>Day and Night Modes</i>	54
<i>Default Flexible Buttons</i>	55
<i>Default Settings</i>	55
<i>Directed Call Pickup</i>	56
<i>Distinctive Ring</i>	56
<i>Do Not Disturb</i>	56
<i>Do Not Disturb - Override</i>	57
<i>Enhanced Lettering Scheme</i>	58
<i>Extension Feature Status Check</i>	59

<i>Extension Groups</i>	60
<i>Extension Password / Phone Lock</i>	60
<i>Extension Pick Up Groups</i>	61
<i>Extension Programming Copy</i>	61
<i>Extension Reminder</i>	62
<i>Extension Swapping</i>	62
<i>Extension User Name</i>	63
<i>External Music Source</i>	64
<i>External Paging</i>	64
<i>FAX Detection with Automatic Transfer</i>	65
<i>Feature Key Allow</i>	65
<i>Flash Recognition – Analog Port SLT</i>	67
<i>Flash – CO Line</i>	68
<i>Flash - PBX Line</i>	68
<i>Flexible Feature Button Programming</i>	69
<i>Forced Intercom Tone Ring</i>	70
<i>Group Call Pickup</i>	71
<i>Headset Jack</i>	71
<i>Hold, System (Common) & I – Hold Indication</i>	71
<i>“Hold” Remind Time</i>	72
<i>Holding Call Answer – Select</i>	72
<i>Hot Key Enable / Disable</i>	73
<i>Hour Mode Selection 12/24</i>	74
<i>Hunt Groups</i>	74
<i>Intercom Calling - Non Blocking - Intercom Button</i>	75
<i>Intercom Call Back</i>	76
<i>Intrusion - Extension</i>	77
<i>Intrusion Tone</i>	77
<i>Last Number Redial</i>	78
<i>Least Cost Routing</i>	79
<i>Loud Bell</i>	79
<i>Messaging – Premises</i>	80
<i>Message Waiting</i>	81
<i>Modem (“Extension 55”)</i>	81
<i>Monitor - Extension</i>	82
<i>Music-on-Hold</i>	83
<i>Mute</i>	83
<i>Off Hook Voice Announce</i>	84
<i>On Hook Dialing (Hot Key Pad)</i>	84
<i>One Touch Transfer</i>	85
<i>Page</i>	85
<i>Page (Allow / Deny)</i>	86
<i>Page (Meet Me)</i>	86
<i>Pause / Pause Insertion</i>	87

<i>Phone Lock / Unlock</i>	87
<i>Privacy</i>	88
<i>Private To</i>	89
<i>Pulse to Tone (DTMF) Conversion</i>	89
<i>Recall</i>	90
<i>Reminder Tones</i>	90
<i>Ringling Level / Muted Ringing</i>	91
<i>Ringling Line Priority</i>	91
<i>Relay Control</i>	92
<i>Save Dialed Number (SDN)</i>	93
<i>Single Line Telephone - Flash</i>	93
<i>Single Line Telephone - CO Line Flash</i>	94
<i>Speakerphone</i>	95
<i>Security Control</i>	95
<i>Speed Dial (ABBR) – Extension /System</i>	96
<i>Status Message</i>	97
<i>System Reminder</i>	98
<i>Text Messages</i>	99
<i>Touch Tone On/Off</i>	100
<i>Transfer</i>	100
<i>Transfer Beep</i>	101
<i>Voice Announce / Hands-free Reply</i>	102
<i>Voice Call Recorder (One Touch Record)</i>	103
<i>Voice Processing Digital (Integration)</i>	104
<i>Volume Control</i>	105
<i>Warning Tone / CO Line Call Limiter</i>	106

6.0 Database Programming..... 107

Database Administration	107
<i>Programming Mode</i>	109

6.1 Extension Programming 111

<i>Day Class</i>	112
<i>Night Class</i>	112
<i>Monitor COS</i>	112
<i>Line Assignment</i>	113
<i>Receive Assignment</i>	113
<i>Ring Assignment</i>	114
<i>Extension Group</i>	114
<i>Warning Tone</i>	114

<i>Outgoing Drop</i>	115
<i>Incoming Drop</i>	115
<i>Location</i>	116
<i>Extension Position</i>	116
<i>Feature Key Allow</i>	116
<i>System Abbr (Speed Bin) Check</i>	117
<i>ICM Mode</i>	117
<i>Record Allow</i>	117
<i>CFW Auxil Lamp</i>	118
<i>Default Settings</i>	118
<i>Do Not Disturb (DND) Function Allow</i>	118
<i>BEEP 2 Allow</i>	119
<i>Pre-CFW</i>	119
<i>Pre-CFW Timer</i>	119
<i>ECF Allow</i>	120
<i>IVR Prompt</i>	120
<i>Forced LCR</i>	121
<i>Notes:</i>	122

6.2 CO Line 123

<i>Day Class</i>	123
<i>Night Class</i>	124
<i>Hunt Group Answer</i>	124
<i>Dialing [Type]</i>	124
<i>Line Type</i>	125
<i>Loud Bell</i>	125
<i>Line Group (CO Line Groups)</i>	126
<i>Private To</i>	126
<i>Distinct Tone (Distinctive Ring)</i>	126
<i>Fax XFR To</i>	127
<i>Gain (RX)</i>	127
<i>Gain (TX)</i>	128
<i>DTMF Disable</i>	128
<i>CID Mode</i>	128
<i>Pre-CFW</i>	128
<i>Privacy Rls</i>	129
<i>Notes:</i>	130

6.3 Call Handling..... 131

<i>Intrusion</i>	131
------------------------	-----

Intrusion Tone..... 131
Exclusive Hold Time..... 132
PBX Flash 132
CO Flash 132
Remind Time..... 133
Pause Time 133
PBX Code 133
PBX Auto Pause 134
Tone Time 134
Voice Mail Dialing Ratio (Feature No Longer Used) 134
Warning Time 135
Recall Time..... 136
Alternate Ring Time..... 136
Tone Sender 137
Single Line Telephone –Hook-Switch Flash..... 137
Operator Code..... 138
SMDR Time 138
SMDR Output 138
Hunt Method..... 139
BB Call Pause 139
VM MON TIME..... 140
Voice Mail Reserve Port..... 140
DTMF Tone 140
Wait CID_T (CID Feature) 141
International Prefix (CID Feature) 141
Country Code (CID Feature) 141
Long Distance Prefix (CID Feature)..... 142
Local Area Code(s) (CID Feature) 142
SYS External Call Forward..... 143
Talk Abandon Timer 144
LCR Time..... 144

6.4 Resource 145

Ring Scheme 145
Letter Type..... 145
Attendant 146
Alternate 147
Modem Number 147
System Reminder 147
Time Switching..... 148
DB Password..... 149
User Password 149

<i>User Name</i>	150
<i>Preprogrammed Message</i>	151
<i>System ABBR No.</i>	153
<i>Line Copy</i>	154
<i>Extension Copy</i>	155
<i>System Time</i>	157
<i>RMT X_RATE</i>	157
<i>SMDR X_RATE</i>	158
<i>Hour Mode</i>	158
<i>Dial Tone Detection</i>	158
<i>Dial Tone Wait</i>	159
<i>Music Source</i>	159
<i>KSU Revision</i>	159
<i>Feature Key Copy</i>	160
<i>UART Type</i>	160
<i>CID Repeater Modulation</i>	161
<i>Volume Limit</i>	161
<i>Service Mode</i>	162
<i>Option Port Function—SLT/Door Phone</i>	162
<i>Option Sensor Function</i>	164
<i>Security Alarm Action</i>	165
<i>Option Relay Function</i>	166
<i>Incoming Filter</i>	167

6.5 Restriction 169

Call Restriction	169
<i>Line Call Discrimination</i>	169
<i>Password Dial Table (Traveling COS)</i>	171
<i>Least Cost Routing</i>	173

6.6 Control..... 177

Control	177
<i>Data Auto Answer</i>	177
<i>Extension Hunt Group</i>	178
<i>Voice Mail</i>	180
<i>Control Contact (Dry Contact)</i>	181
<i>Location to Directory</i>	182
<i>Directory to Location</i>	184
<i>System Warm Start</i>	185
<i>System Cold Start</i>	185

Notes: 186

A Appendix A 187

Extension 55 187
 Remote Programming Connect 187
 Remote Programming Disconnect 189
 Troubleshooting Screens 189

7 Voice Processing System 191

Automated Attendant 192
Shutdown Procedure 193
voice processing Call Flow 194
Administrative Programming 195
Voice Processing Programming Menu 195
Main Menu Programming Flow 196

1 General Settings 197

1 = *Admin Password* 198
2 = *Record Greetings* 198
3 = *System Time* 199
4 = *Holiday Schedule* 200
5 = *System Interface Codes* 200
6 = *Operator Operations* 200
7 = *Extension Programming* 201
8 = *Department Programming* 202
9 = *Mailbox Settings* 204

2 Advanced Settings 205

1 = *Language* 206
2 = *Out Calling* 206
3 = *Call Record Reminder Tone* 206
4 = *Storage Length* 206
5 = *Incorrect Input* 206
6 = *LAN Port* 206
7 = *Broadcast Groups* 207

Programming Using TCP/IP 207

TCP/IP Login 213
Main Programming Menu 214
Extension 217
DSP 218

<i>Department</i>	219
<i>Version</i>	220
<i>Email Delivery Setup</i>	221
<i>Voice Processing Programming Flow</i>	225
<i>Notes:</i>	226

1 Introduction

Notices

The Contents of this manual are subject to change without notice and do not constitute a commitment on the part of the Manufacturer or reseller. Every effort has been made to ensure the accuracy of this document, however, due to ongoing product improvements and revisions neither the manufacturer nor the reseller can guarantee the accuracy of printed material after the date of publication nor can it accept the responsibility for errors or omissions. This document will be updated and revise as needed.

Reproduction, publication, or duplication of this manual, or any part thereof, in any manner, mechanically, electronically, or photographically, is strictly prohibited.

© Copyright All rights reserved.

Warning: This service information is designed for experienced repair technicians only and is not designed for use by the general public. It does not contain warnings or cautions to advise non-technical individuals of potential dangers in attempting to service a product. Products powered by electricity should be serviced or repaired only by experienced professional technicians. Any attempt to service or repair the product or products dealt with in this service information by anyone else could result in serious injury or death.

The information contained in this document is subject to change without notice and should not be construed as a commitment by the manufacturer or the reseller. reserves the right, without notice, to make changes to equipment design as advances in engineering and manufacturing methods warrant. The software and hardware described in this document may be used or copied only in accordance with the terms of the license pertaining to said software or hardware. Reproduction, publication, or duplication of this manual, or any part thereof, in any manner, mechanically, electronically, or photographically, is prohibited without permission from manufacturer.

This equipment generates, uses, and can radiate radio frequency energy, and if not installed and used properly, that is, in strict accordance with the instruction manual, may cause interference to radio and television reception. This equipment has been tested and found to comply with the limits for a Class A computing device in Subject J of Part 15 of FCC Rules, which are designed to provide reasonable protection against such interference. However, there is no guarantee that interference will not occur in a particular installation.

If this equipment does cause interference by one or more of the following measures:

1. Reorient the receiving antenna,
2. Relocate the key service unit and key telephones with respect to the receiver,
3. Move the equipment from the receiver,
4. Plug the key service unit into a different outlet so that the equipment and receiver are on different branch circuits.

FCC Information

Provide the Telephone Company with the following FCC information:

TABLE 1.1 FCC Information

ITEM	Specification
Type of Service	The system is designed for use with standard telephone lines. Direct connection to party lines or coin-operated phones is prohibited.
FCC Registration Number	D6XMF00B924
Ringer Equivalence	0.0B
Network Address Signaling	Code E
Service Order Code	9.0F
Facility Interface Code	02LS2
Required Network Interface	Code RJ11C

About This Manual

This manual provides installation instructions for the System. The following table summarizes the sections in this manual:

TABLE 1.2 Chapters

Chapter	Title	Purpose
1	Notices and FCC	
2	System Overview	Provides an overview of the system with the model numbers, components, and various configuration
3	Specifications	Provides systems specification.
4	Installation	Describes physical installations requirements, module installation, and wiring for the system.
5	Initialization	Describes the process for initializing the software for database programming.
6	Database Administration	Describes the process of programming the system software and customizing the database to meet customer requirements.
7	Voice Processing System	Installation and Programming the Voice Processing System.
Appendix A	Remote Programming Modem	Create a remote programming terminal by "joining" two system together.
Appendix B	Menu Bypass Codes	Listing of all the programming codes, sorted by category.

Related Documents:

TABLE 1.3 Documentation

Part Number	Document
45PCD	Compact Disk of all Documents
45PDPAUG	Digital Port Quick Reference Card
45PDPUG	Digital Port User Guide (Full)
45PAPUG	Analog Port User Guide
45PQSG	Quick Start System Guide
45PIM	Installation Manual

Notes:

Notes:

1

2 System Configuration

This Hybrid Telephone System has a modular single shelf flat-pack design, which comes configured with 3 Central Office lines by 8 Digital Extensions and 2 analog extensions and can expand to a 9 Central Office lines by 24 Digital Extensions and 4 analog extension ports. In addition, The system comes equipped to receive Caller ID from the telephone company, if it is supplied, and any analog telephone with Caller ID capability will also receive Caller ID.

Additional components include an Option module which provides 2 analog ports, BGM, Relays (four), Security Sensors (four), External Paging Port, Loud Bell Contact and one RS232c for SMDR/PC Programming Software. An integrated Door Phone and an Optional 8 Port Flash Voice Processing System (VPS) are available.

The following is a list of available models and their corresponding model numbers:

TABLE 2.1 Part Numbers and Descriptions

Part Number	Model	Description
45PKSU	3 x 8 Base KSU	3 x 8 Base Cabinet
45P308	3 x 8 Expansion module	3 x 8 Expansion module
45POPT	Option module	Provides 2 additional Analog ports, BGM, 4 Secure Area Alert Relays and 4 door sensor Relays, SMDR, Page Port and Loud Bell Contact.
45PEKT	Digital Display Telephone	3-Line LCD Digital Speakerphone with Handsfree Communications
45PDRP	Door Phone	Integrated Door Phone with Handsfree Response
45PFV6	Voice Mail	8 Port, 6 Hour, Integrated Flash Voice Mail with Auto Attendant

System Hardware

KSU

An external AC/DC power supply provides power for this stylish compact cabinet and the Motherboard which is equipped to operate 3 Central Office Lines, 8 Digital Extensions, and 2 Analog ports. The additional 3 x 8 module and option module as well as the voice mail system connects to the Motherboard via special "Mate Lock" connectors and flat ribbon cables. Once powered up, the system will automatically identify each additional module that is installed.

Figure 1. Illustrates how the additional modules are installed.

FIGURE 1. Installing Additional Modules

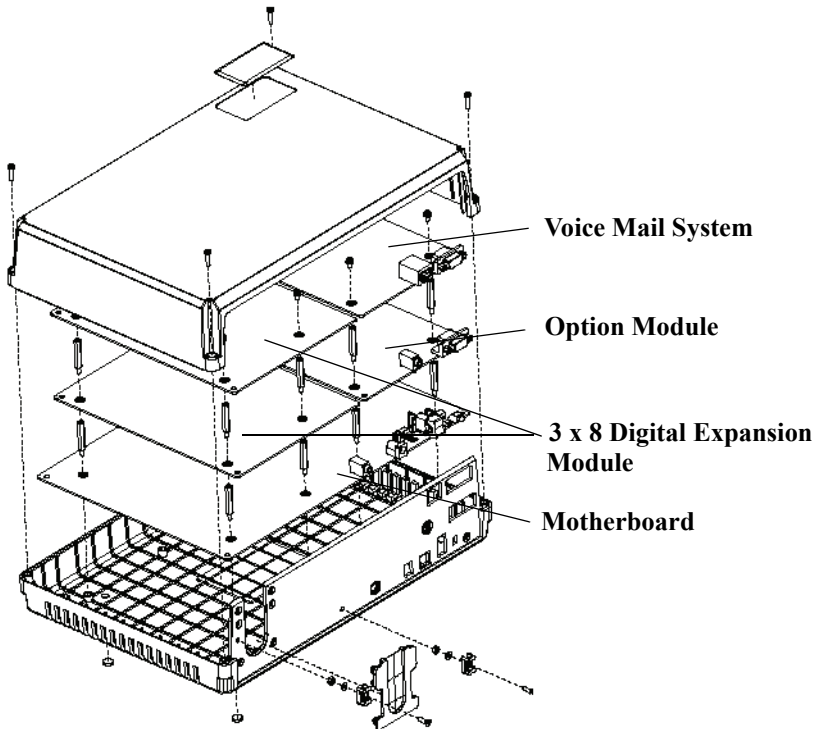

System Peripheral Connections

The system is equipped with many of the necessary peripheral connections required to operate other resources in conjunction with the system.

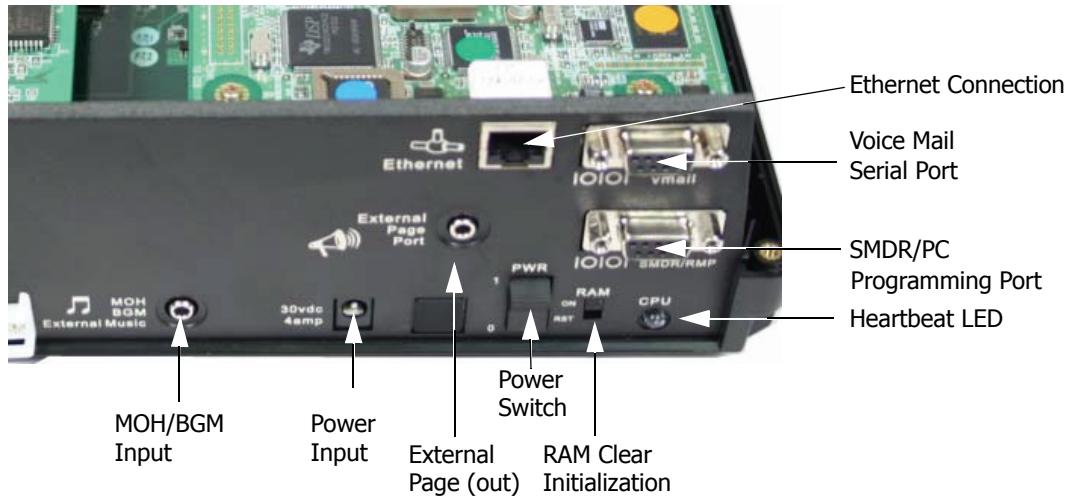

Configuration Options

At default, the system comes equipped with 3 Central Office Lines with Caller ID, 8 Digital Extensions and 2 Analog Extensions which can also receive Caller ID. Due to its modular design, the system can be equipped with affordable modules to increase the system size to a maximum of 9 Central Office Lines, 24 Digital Extensions and 4 Analog Extensions. In addition, an 8 port integrated Voice Mail System can also be added.

The following table describes the building block structure of the system:

TABLE 2.2 System Configuration

	3 x 8	6 x 16	9 x 24
3 x 8 KSU	1	1	1
3 x 8 Expansion Module	N/A	1	2
Power Fail Port	1	2	3
Analog Ports Standard (2)	2	2 SLT Ports on the Motherboard	
Analog Port Expansion (2)	2	2 SLT Ports on the Option Module	
		Total of 4 SLT Ports per System	
Option Module	1	1 - Option Module Per System	
Door Phone	2	2 Door Phones total (Option Module) Replaces 2 SLT Ports	
Integrated Voice Mail	1	1 8-Port Voice Mail Per System	

Main System KSU

The basic system comes with a power supply, and a motherboard configured as a 3 x 8 x 2 (analog). The Motherboard has an integrated Main Distribution Frame (MDF), designed to eliminate costly ancillary products, such as M66 split blocks, and is used like a patch panel.



- *Common control circuit with 80188 CPU*
- *Memory span: 1Meg ROM, 512KB RAM*
- *3 analog CO line ports plus 1 Power Failure port on port-1*
- *Caller ID detection (Type 1)*
- *8 digital extension ports*
- *2 analog extension ports, with Caller ID pass through*
- *Built-in interface for remote programming via EKT*
- *DSP control for multi-party conference, tone plant and tone detector*
- *External Music on Hold Connection using 1/8" mini-mono plug (provided)*
- *Battery Back Up for RAM*

* System shown configured as a 616, with the option module and voice processing system. Special Quick Connection Terminations are included in the packing carton.

Expansion Module 3 x 8

A 3 x 8 expansion module can be installed in the KSU, growing it from its initial 3 x 8 configuration to 6 x 16. Add an additional 3 x 8 expansion Module brings the system up to its maximum capacity of 9 x 24.

Like the Motherboard, each 3 x 8 expansion module comes with an integrated Patch Panel - MDF, conserving wall space which makes installation quick and easy. Each module is connected to the Motherboard using a ribbon cable which is inserted into the "E308" pin connector. The second 3 x 8 expansion module is stacked above the lower 3 x 8 expansion module, and the ribbon cable is inserted into the lower 3 x 8 module.

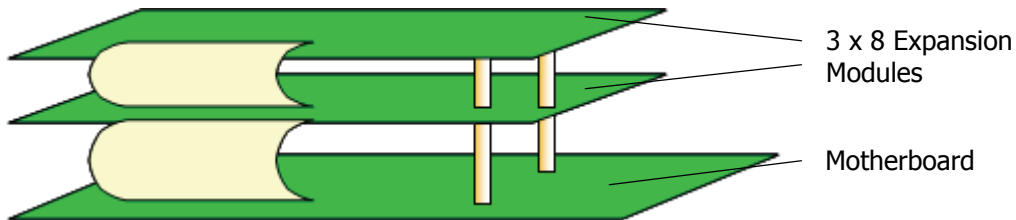

Each 3 x 8 Module comes equipped with 3 Central Office terminations, one Power Fail Transfer termination and 8 Digital Extension terminations.

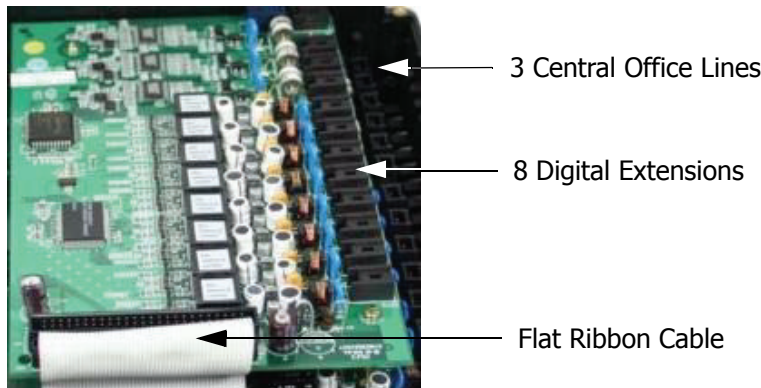

- 3 analog CO line ports plus 1 Power Failure port on port-1
- Dual mode caller ID detection (FSK and DTMF)
- 8 digital extension ports

* Each expansion module comes with the quick connectors, and the needed stands off posts.

Option Module

The Option Module interfaces with the following ancillary devices:

- 2 Single Line Telephone Ports that double as Door Phones
- External Page Port to connect to an external paging unit (amplifier).
- Loud Bell Contact to connect an external bell or strobe light.
- RS232C (SMDR/RMP) Port to connect an SMDR Serial Printer, or Call Accounting Software or Remote Programming and Maintenance (RMP) Software Application.
- 4 – Door Relays which supply a momentary contact closure, which can be used to release an electronic door lock interface. Connects using a screw terminal interface.
- 4 – Door Sensors (Secure Area Alert) which are used to detect an opening of a device with a contact closure on it, such as an open door.

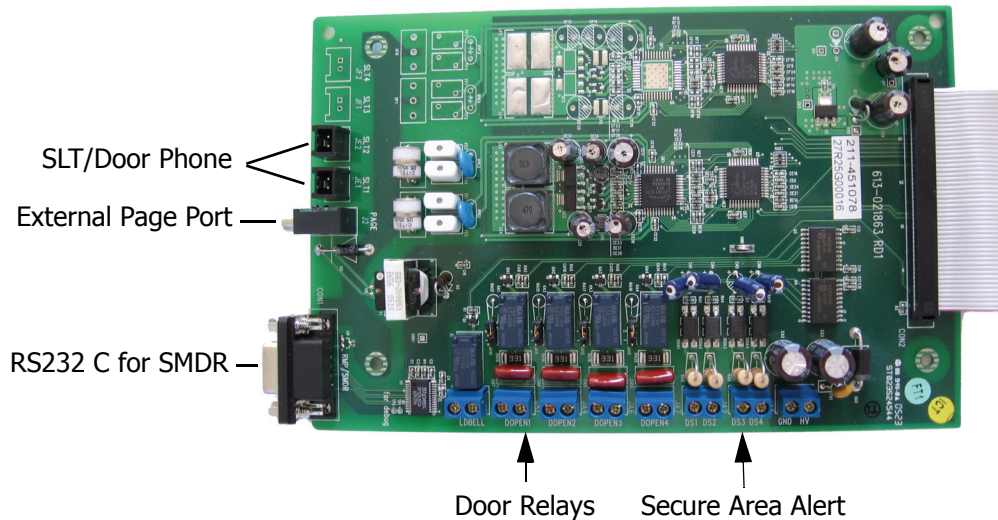

The single line device ports are “double duty” ports; they can be programmed as a Single Line Device, or a Door Phone but not both simultaneously. The door phone can be programmed to integrate with a door opening relay. A ribbon cable connects the Option Module to the motherboard and is inserted into the Option board pin connector.

- Over-voltage Protection per CO Circuit
- Polarity Guard per CO Circuit

* Each option module comes with the quick connectors, 1 mini-mono plug, and the needed stands off posts.

Small Business Voice Processing System

The Integrated Small Business Voice Processing System (SBVPS) can be added to the system to provide Voice Mail functionality as well as Automated Attendant. The SBVPS can be programmed using DTMF tones, or using an Internet Browser such as Windows Internet Explorer. In addition, it can be programmed to copy voice mail messages to an E-mail account using SMTP. See Chapter 7 for details.

- Support Ethernet port for Administration Management
- RS232C Serial Port for Troubleshooting and Trace Information



Ethernet Port
for SMTP and
Programming

Serial Port
troubleshooting
and system trace

3 System Specifications

Specifications

Power Requirements

TABLE 3.1 Power

A.C. Power	110 or 220 V AC (Selectable)
Frequency	60 Hz
Power Consumption	100 Watts max
Current Rating (Max)	1 Amp AC, 3 Amp DC
Loud Bell Contact	1 Amp DC (Do not use AC!)

Dimensions

TABLE 3.2 System Dimensions - Measurement in Inches

KSU	12 1/2" L x 9 1/4" W x 3 7/8" H
-----	---------------------------------

Mounting

TABLE 3.3 Mounting Methods

Mounting Methods	Wall Mount Table Mount
------------------	---------------------------

Operating Environment:

TABLE 3.4 Environmental Conditions

Temperature	32° to 95° degrees Fahrenheit
Relative Humidity	5 to 90 percent Non-Condensing

Wiring:

TABLE 3.5 Cable Layout

Digital Telephone	2 Wire - Star Type
Single Line Telephone	2 Wire - Star Type

Maximum System Configurations:

TABLE 3.6 System Maximums

CO Lines (Analog Type) equipped for Caller ID	3 on Motherboard 3 on each Expansion Module (Max 2)
Each CO Line Module has 1 Power Fail Circuit	9 Max CO Lines in a fully configured system
Digital Telephones	8 on Motherboard 8 on Each Expansion Module (Max 2) 24 Max Digital Extension in a fully configured system
Single Line Telephone Ports	2 on the Motherboard, which can be programmed as either Single Line Telephone ports or Door Phones. 2 on the Option Module 4 Maximum SLT Extensions in a fully configured system
Option Module	1 Option Module may be installed a system
Door Phone	2 Door Phones may be installed in the system and take the place of the 2 SLT ports on the option module. At default, the door phone ports are programmed to ring. If a door phone is connected, but not programmed correctly all inbound calls will automatically be answer by the connected door phone.
Requires the Option Module	
Voice Mail	One - 8 Port, 6 hour Voice Mail may be installed

CO Line Interface Specifications:

TABLE 3.7 CO Line Interface Specifications

Signaling	DC Loop
Dialing	Pulse/DTMF (Touch Tone)

Switching Technology:

TABLE 3.8 Switching Matrix

Digital	Time Division Multiplex (TDM), Pulse Code Modulation (PCM)
---------	--

Extension Interface Specifications:

TABLE 3.9 CO Line Interface Specifications

Dialing	Pulse or DTMF (Touch Tone)
Loop Length	80 Ohms for SLT Maximum
Ringer	70V AC, 35 Hz SLT
SLT Voltage	-48V DC

Maximum Cable Length:

TABLE 3.10 Digital Extension Wiring

26 AWG	650 Ft.
24 AWG	1133 Ft.
22 AWG	1586 ft.

TABLE 3.11 Single Line Telephone Extension Wiring

26 AWG	850 Ft.
24 AWG	1416 Ft.
22 AWG	1983 Ft.

Notes:

4 *Installation*

Installation

Basic Tools and Supplies

1. Minimum of Category 3 - 3 or 4 twisted pair cable run from the MDF to each telephone terminal device.
2. 4 or 6 conductor modular jack assemblies for all extension terminals.
3. Uninterrupted Power Supply (UPS) system to protect the system in the even of a voltage spike or commercial power outage.
4. Standard telephone hand tools and test equipment, mounting hardware for the KSU, MDF backboard, terminal blocks, modular jack assemblies, etc.

Product safety and safety guidelines

1. Never perform any wiring in a wet location or while standing in water.
2. Do not perform telephone wiring during a lightning storm.
3. To maintain the system in good operation, an isolated, dedicated outlet for the system is needed. The outlet should be AC power supply with 120 ~ 240V \pm 10% at 50 ~ 60Hz.
4. The install location should be well ventilated, have an optimum temperature range of 40° ~ 95° F and a relative humidity range of 20 ~ 80%.
5. For cooling purposes, ample air space should be provided for the KSU, the KSU should not be exposed to direct sunlight, heat or dust.
6. Do not install the system in a strong magnetic field, such as those generated by heavy motors, television, copy machine or some kitchen appliances.
7. The system should be located in an electrically noise-free environment to avoid interference.
8. To reduce interference, use independent wiring for extensions connected to this system.

9. Do not include connections for antenna, power supplies and/or internet connections in the same sheath (cable).
10. Earth ground for the KSU should less than 3 Ohms.

Note:

The manufacturer warranty does not cover damage caused by power line surges or lightning damage.

Installation Planning

1. The system should be located within 5 feet of the isolated dedicated 120 ~ 240V \pm 10% at 50 ~ 60Hz, and connected to a UPS. Do not use an extension cord!
2. Locate the Telephone Company demarcation point and extend them to the MDF.
3. The system (MDF) should be mounted on a painted (white or black) 3/4 inch plywood back board. Be sure that the back board is level and at least 24 inches off the floor. Also, be sure that it is large enough for the system and all of the peripheral equipment.

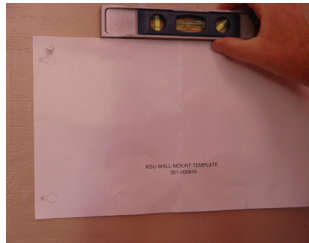

4. Locate a suitable, known good, earth ground such as a cold water pipe - preferably within 10 feet of the MDF. It is suggested that a cold water pipe, when used as a ground, is traced to its point of origin to ensure that there are no non-metallic sections, which may compromise the ground.



Module Installation

It may be easier to install all expansion modules into the system before mounting the system on the Backboard. DO NOT install modules when the system is powered up.

3 x 8 Expansion Module

1. Remove the KSU cover.
2. Locate the pin connector socket labeled "308EXP".
3. Insert the module, but before securing it, plug the ribbon cable into the pin connector socket labeled "308EXP".
4. Use the supplied stand-offs to secure the module.
5. Replace the cover, and power the system up.

Option Module

1. Remove the KSU cover
2. Remove the plastic protective cover from inside the KSU.
3. Insert the Module, and plug the ribbon cable into the pin connector socket labeled "Option Board".
4. Use the supplied stand-offs to secure the Option Module or place the standoffs that are supplied with the Voice Mail system.
5. Replace the cover, and power the system up.

Adding Loud Bell Control

One "dry-contact" RELAY 24VDC/1A is provided on the Option Module for use with external ringing devices. The system can be programmed to activate the dry contact whenever programmed CO Lines ring.

Caution

DO NOT USE AN AC Power supply, the bell will ring continuously.

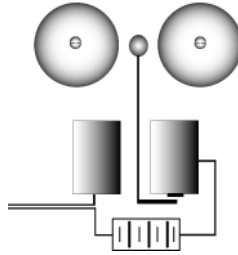





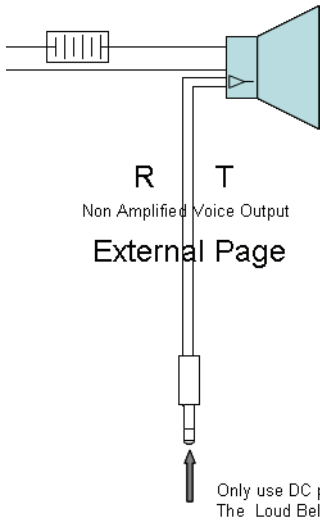

Adding an External Page

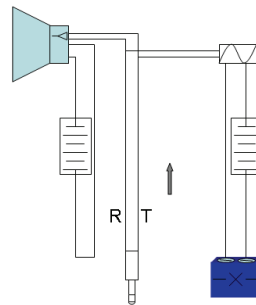
The External Page Port is designed to receive an external paging unit (amplifier) to allow voice paging over external speakers. The amplifier interface should be 600 ohms.



Loud Bell over the Paging Port



-  1/8th inch Mono-Phono Plug
-  Tone Generator
-  Dry Relay Closure
-  Low voltage amplified paging device
-  Battery/Power source
-  One Way Paging

Single Line Telephones or Door Phones

Extensions 36 and 37 found on the Option Module can be programmed as either Single Line Telephone devices or Door Phones.

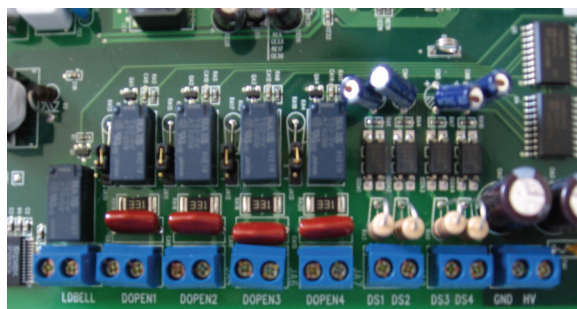

Door Relay

Door Sensor

Door Sensor

Four security sensors with screw terminations, activate when an electronic sensor device circuit is open, sending an alert to the programmed extensions and external telephone numbers.

Door Relay

Four door relays with screw terminations are provided and will send a (programmable) momentary closure to release electronic door lock device.

Voice Processing System

1. Only after installing the Option Module. If the Option Module is not installed, use the special spacers that come with the Voice Processing System.



2. Remove the plastic protective cover from inside the KSU.
3. Insert the Module, and plug the ribbon cable into the pin connector socket labeled "VM/B".
4. Secure the card using the brass-colored stand-off posts, which are supplied with the voice mail system.
5. Replace the cover, and power the system up.

When the voice mail comes on line, the display will update and show how many "N" new and how many "S" saved messages each extension has in their voice mailbox.

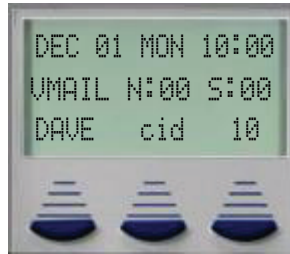

Note:

The fully integrated voice mail will be fully operational shortly after the system is powered on. To properly maintain database integrity it is important to understand the proper shut-down procedure.

1. From any digital telephone enter Feature #0
2. Followed by the attendant password (at Default the password is 9999)
3. Press back
4. The display will update SHUT DOWN VM
5. Press show
6. Press go
7. When the display returns to SHUT DOWN VM
8. The system can be safely powered down

System Grounding

A good earth ground may be necessary to ensure proper operation of the system. Carefully check that the system is connected to a reliable grounding path. Generally, the gauge of the ground wire should directly correlate with the distance from the ground source (i.e., a greater distance from the grounding source requires a larger gauge of grounding wire).

The ground wire should be connected to the ground lug located on the motherboard in the cabinet. The distance of ground wire should be kept as short as possible.



Lightning Protection

It is good practice to protect all CO Lines and Extensions with proper lightning surge arrestors, such as gas discharge tubes, which guards against damaging surges caused by non-direct lightning strikes. Failure to provide proper lightning protection may cause damage to the system.

Central Office (CO) Line Installation

The system connects to the telephone company lines using a two-wire (single pair) cable, connected to a RJ11 or RJ21X, then connected to the built in MDF Patch Panel on the motherboard.

Surge Protection Considerations

Transitory voltage spikes, if induced onto CO lines, can travel through the cable and into the common equipment. The telephone company offers basic protection against this condition, but it is usually designed to protect the CO circuits and should, therefore, not be relied upon for total protection. To help protect the system from external voltage surges, the manufacturer recommends that gas discharge tubes, or similar primary protection devices, be installed and properly grounded on all lines.

Adding a Music Source

A music source can be connected to the MOH/BGM (External Music) port using the supplied 1/8" mini-mono plug.

Wiring and Connectors

Maximum Cable Length

TABLE 4.1 Digital and Door Phone Extension Wiring

26 AWG	650 Ft.
24 AWG	1133 Ft.
22 AWG	1586 ft.

TABLE 4.2 Single Line Telephone Extension Wiring

26 AWG	850 Ft.
24 AWG	1416 Ft.
22 AWG	1983 ft.

Wiring Procedure 2 – Single Pair

All CO Lines and Digital, Single Line and Door Phones extensions connect to the system using the supplied connectors. These connectors incorporate a MDF Patch Panel that makes Moves, Adds and Changes quickly and easily. Use the following steps to connect the extensions to the system.

1. Insert wires into the supplied Quick Connect Connector

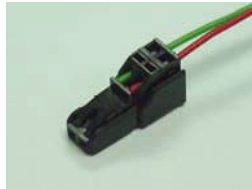

2. Make sure that the wires are lined up with the cable end guide and then press the connector until you hear it click. The connector is self stripping and the wires should fit snugly into the connector. Be sure not to over crimp the connector as it may sever the wires and create erratic operation.

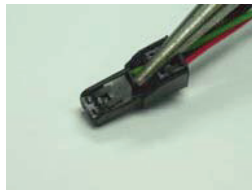

3. Complete Wiring



4. Once the wiring is complete insert the connector into the appropriate port.

Connecting Extensions

Digital Extensions

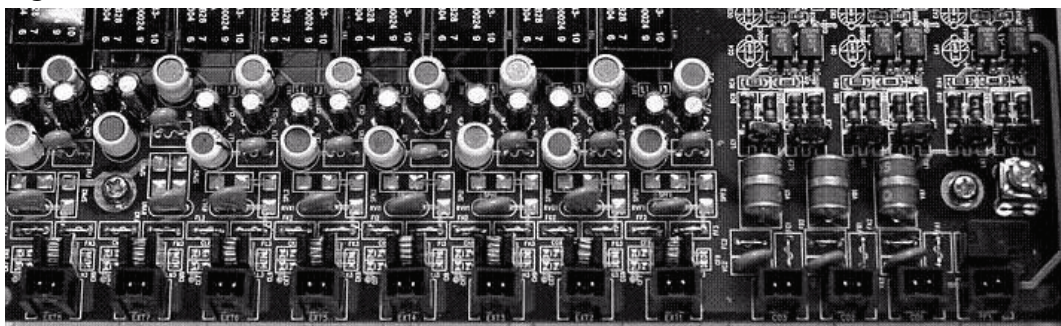

8 7 6 5 4 3 2 1 3 2 1 PF

TABLE 4.3 CO Line and Digital Extension Numbers

CO Lines 1 - 9				Digital Extensions 10 - 33								
Module	PF	1	2	3	1	2	3	4	5	6	7	8
KSU	Y	1	2	3	10	11	12	13	14	15	16	17
Exp 1	Y	4	5	6	18	19	20	21	22	23	24	25
Exp 2	Y	7	8	9	26	27	28	29	30	31	32	33

Analog Extensions

TABLE 4.4 Connections and Analog Extension Numbers

Module	SLT1	SLT2
KSU	34	35
Option	36*	37*
* Door Phone or SLT		

Station Message Detail Recording (SMDR)

Station Message Detailed Recording, monitors and reports, via serial printer or call accounting software, telephone calls, which can be either inbound, outbound or both, for desired extensions.

SMDR Output

TABLE 4.5 SMDR Output

EXT	TRK	D	DIG DIALED	RING	DATE	TIME	DURATION	ACCOUNT	BR	CMT
12	02	O	15551212		01/01	08:03:01	00:15:10		\$	TRC
12	03	I	6025555885	00:05	01/01	08:45:38	00:32:17		\$	TRH
			AZ Info							
12	03	I	8544881212	00:09	01/01	10:15:44	00:00:59		\$	
			Out Of Area							

TABLE 4.6 SMDR Format

Field	Field Position	Description
Ext	01-02	The last Extension Number - connected to the CO Line.
TRK	05-06	CO Line Number used.
D	09	"I" for Inbound or "O" for outbound calls
Digit Dialed	11-29	Digit dialed outbound or Caller ID received Inbound
Ring	30-34	The amount of time it took to answer an inbound call.
Date	36-40	The date the call was received in mm/dd
Time	42-49	Time of the call in 24 hour format hh:mm:ss
Duration	51-58	Total Length of the call in hh:mm:ss
Account	61-67	The Account code used
BR	70	\$ Indicates that the system has detected a polarity reversal signal.
CMT	73-75	Call Monitor Trunks TRC - CO lines that are conferenced together TRH - CO lines that were placed on hold before being transferred
Blank	76-80	Not used at this time

Initialization Procedure

Once all of the Modules are installed into the system, and it is properly mounted, grounded and cross connected it is time to initialize and power up the system. It is important to initialize the system to ensure the integrity of the database.

1. Make Sure that the power is turned off.

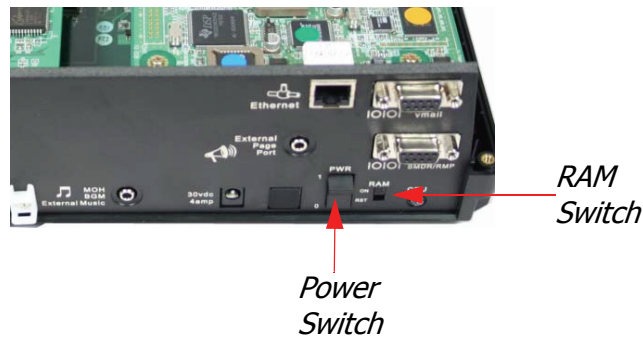

2. Locate the "RAM" switch on the front panel and turn it to the off position. If the RAM switch is already in the off position, skip directly to step 3.
3. Leave the RAM Switch in the off position for 30 seconds and then switch it to the on position.
4. The system has now been restored to factory default.
 - All CO Lines will ring extensions, including SLT extensions.
 - All extensions can take and place calls and the Toll Restriction is at Default

Notes:

Notes:

4

5 Telephone Operation

Introduction

This telephone is a high quality, full featured, speakerphone with programmable feature buttons, which allows the user to customize the operation of their telephone.

Telephone Basics



Navigation Keys

The Navigation Keys, located at the right of the Display, allows quick access to commonly used features. There are 4 navigation keys which circle the activation key. For example, to use the Navigation keys, begin by pressing the Right navigation key, to access Call Log, and then press the down navigation key to view incoming and the up navigation key to view outgoing calls. Press the center activation key to dial the displayed telephone number.

Press the left navigation key to scroll forward, and the right to scroll backwards through the navigation feature list.

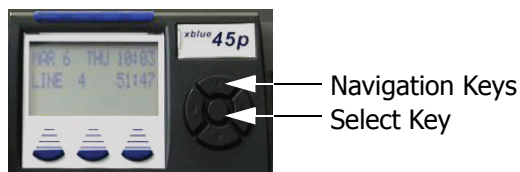

TABLE 5.1 Navigation Buttons

Feature	Navigation Key	Result
Call Log	Up - Outgoing Numbers	Press the Select Key to dial the displayed telephone number.
	Down - Incoming Numbers	
System Speed Dial	Up - Access Bins 99 - 20	Press the Select Key to dial the displayed telephone number.
	Down - Access Bins 20 - 99	
Feature Code List	Up - Directory List	Press the Select Key to select between Directory and Feature. Press down button to scroll forward, and the up button to scroll backwards through the selected list.
	Down - Feature List	
Call Extension	UP - Scroll from highest to lowest extension number	Press the Select Key to dial the displayed telephone number.
	Down - Scroll from lowest to highest extension number	
Page	Up - All Call Page	Press the Select Key to page the displayed Page Group or All Call Page.
	Down - Page Groups 1 - 6	
Music	UP - N/A	Press the Select Key to enable or Disable Background Music
	Down - N/A	
Door Phone	Up - Answer Door Phone 1	The Door Phone must be connected and active to access
	Down - Answer Door Phone 2	

Feature Codes

Feature codes may be dialed at the time of operation or they may be stored on a programmable feature button. Once stored, the feature can be easily accessed by pressing the button. If applicable, the associated LED will light, indicating that the feature is currently operational. For example, Program Do Not Disturb on a feature button, when pressed the associated LED will illuminate, indicating that the extension is in DND mode.

TABLE 5.2 Telephone Feature Codes

Feature	Digital Telephone	Single Line telephone	Page
Access Specific CO Line	F 0(x) (x=line 1-9)	# 0(x)	Page 34
Account Code	4	4	Page 34
Answering Machine Emulation	F 64		Page 34
Attendant	0	0	Page 35
Attendant Administration	F#0		Page 36
Authority Code	F 55	# 55	Page 40
Automatic Hold Allow	F 94		Page 41
Automatic Selection	F 95	#95 + 0 Intercom #95 + 1 + lg (line group) #95 + 2 + CO (CO Line)	Page 43
Background Music	F 52		Page 44
Busy Ring Allow/Deny	F #2		Page 45
Call Back	F 91	#91	Page 46
Call Forward	F 2	#2(y) Y = 0 - Idle Forward 1 - Busy/ No Answer 2 - Direct Forward 3 - Follow Me 4 - No Answer 5 - Busy 6 - External	Page 48
Call Park	F 73		Page 49
Call Pickup Directed	F 54	#54	Page 50
Call Pickup Group	F 53	#53	Page 50

TABLE 5.2 Telephone Feature Codes

Feature	Digital Telephone	Single Line telephone	Page
Caller ID (CID)	Press CID (Center Interactive Button)		Page 51
Call Wait Allow/Deny	F 99		Page 52
Camp On (Busy Extension)		Ext + 2	Page 52
Camp On (Busy CO Line)	F 93	#	Page 52
CO Line Group Access	9	9	
Conference	F 60		Page 53
Data Rate	F 75		Page 54
Day/Night Mode	F 63 + PPPP PPPP=Attendant Password		Page 54
Default Flexible Buttons	F 58		Page 55
Default Setting	F 69		Page 55
Directed Call Pick Up	F 53	# 53	Page 56
Distinctive Ring	F #7		Page 56
Do Not Disturb (DND)	F 4	# 4	Page 56
Extension Feature Status	F #8		Page 59
Extension Password - Phone Lock	F97	#97	Page 87
Extension Reminder	F 92	#92	Page 62
Extension Reminder Delete	F*92	#*92	Page 62
Flash (PBX/CO)	F 3	# 3	Page 68
Flexible Feature button Programming	F #3		Page 69
Group Call Pickup	F 54	# 54	Page 71
Headset Enable/Disable	F 9#		Page 71
Hot Dial	F #6		Page 73
Hold Retrieve (SLT) Same Extension		* 6	Page 72
Hold Retrieve (SLT) Different Extension		* 7 EE EE=Extension	Page 72
Intercom Call Back	F 91		Page 76
Last Number Redial	F 8	#8	Page 78

TABLE 5.2 Telephone Feature Codes

Feature	Digital Telephone	Single Line telephone	Page
Least Cost Routing	F 68		Page 79
Message Waiting	F 96	# 96 Send #*96 Cancel	Page 81
Monitor - Extension	F 7*		Page 82
Multiple Mailbox Button	F66 + 0 or F66 + 70~79		
Mute	F 76		Page 83
Night Mode (Attendant)	F 63		Page 36
Page	F 50	# 50(Z) Z= 0 - All Call 1 - External Page Only 2 - System All Call 3 + g - Group All Call g = 1 - 9	Page 85
Page Allow/Deny	F #9		Page 86
Page Answer (Meet Me)	F 59	# 59	Page 86
Pause	F 70		Page 87
Phone Lock	F 97	# 97	Page 87
Pulse to Tone	*	*	Page 89
Relay Control	F 61		Page 92
Save Dialed Number	F 51		Page 93
Security Control	F 62		Page 95
Speed Dialing (Abbr Dialing)	F 1		Page 96
Speed Dialing (SLT)		# 1 to store * 1 to Dial	Page 96
Status Message	F 90		Page 97
Touch Tone on/off	F #1		Page 100
Transfer Beep	F 79		Page 101
Voice Call Allow/Deny	F 98		Page 102
Voice Mail	F 64	#64	Page 104
Voice Recording	F 67		Page 103

Feature Code Operation

Accessing Specific CO Lines

Feature  (X)

Accessing Individual CO Lines may be accessed directly by pressing the Feature button followed by 0(x), where (x) = the CO Line 1 - 9. This allows both Single Line and Digital Key telephones the ability to access specific CO Lines rather than dialing the line group code.

Conditions:

1. The CO Line hardware must be installed or the CO Line will not be available.
2. The CO Line must be connected to the telephone company facility or error tone will be heard.

Account Code

Feature 

Account Codes can be forced, which requires an extension to enter the account code before placing a CO Line call, or unforced, allowing the user to decide if/when they will enter the account code. All account codes are verified against the "*Password Dial Table*" (MBC - 5-02) in Restriction.

Answering Machine Emulation

Feature  

Answering Machine Emulation requires the voice mail (VM) System. This feature 'Mimics' the call screening feature of a simple analog answering machine. Within a specified time after a call is answered by an extension user's Voice Mailbox, that user can monitor/screen callers as they leave a message.

The extension user will receive a warning tone that indicates when a caller has been answered by their voice mailbox. They then have the option to monitor the caller or ignore the alert and allow the caller to leave a message. Once the user has selected to monitor the caller, they then have the option to leave the caller undisturbed (leaving a message) or

to retrieve the caller from the voice mail box and be connected to the caller for a live conversation.

Associated Features	Associated Programming
Voice Mail	Extension Predefined Forward 1-EN-21 Call Handling Voice Mail Monitor Time 3-22

Conditions:

1. To Monitor or Answer a call, action must be taken before the "Monitor Time" expires.
2. Monitor Time starts at the time the caller is connected to the user's voice mailbox.
3. For Answering Machine Emulation to operate, the extension must be forwarded to the Voice Mail System.
4. Predefined Call Forward or Extension Call Forward can be used for this purpose.

Attendant

Any Digital Key Telephone may serve as the Attendant. The Attendant supports several general system functions like Line Recall, Forced Incoming ICM Call Forward and manual evening or alternate service mode operation as well as Voice Mail Shutdown. The attendant will receive all intercom calls directed to the Attendant Directory Number, ("0" at default).

A second (alternate) attendant position may be selected for common sharing of incoming CO line calls or load sharing during peak traffic periods.

The attendant's extension password allows for control of the system service mode (Day/Evening/Alternate/Time), time of day settings, (Abbr) System Speed Dial number programming, and recording of the optional Auto Attendant greetings. The attendant extension may be connected to any system extension port and be assigned any intercom extension number in the numbering plan.

Attendant Administration (Admin.)

Feature  

Attendant Administration (Admin.) is used to set or modify the features:

- Service Mode (Day/Alt/Eve/Time)
- System ABBR No
- CFW AUXI Lamp
- Incoming Filter Unring (Will not Ring)
- Incoming Filter Ring (Will Ring)
- Opt. Sensor Function
- Voice Mail Shutdown

Attendant Administration can be done at any digital key telephone. The Attendant Administration password is the same as the user's password of the assigned Attendant Extension.

Associated Features	Associated Programming
Service Mode	Resource - Alternate Attendant 4-04
Speed Dial System	Resource - ABBR. Speed Dial Bin 4-12
Automated Attendant	Resource - User Password 4-09
Auxiliary Lamp CFW	Resource - Time Switching 4-07
	Resource - Incoming Filter Ring/NonRing 4-32
	Resource - Opt. Sensor Function 4-29

Service Mode Switching:

The system can run in one of three modes, Day, Night and Timed. Day mode is used during the day time hours and night mode is used during the night time hours. The timed mode is used to automatically switch between day and night mode using the times set in Time settings. "Time Switching 4-07.

Attendant Mode Administration allows any extension with the Attendant password to program the system in either day, night or timed mode. If the system is placed into day or night mode, using this programming parameter, it will remain in that mode until it is programmed into another mode.

In addition, the Attendant, which is the extension that rings when zero "0" is dialed, and the alternate attendant, may dial the feature access code "Feature 63" to switch between modes. However, the system will remain in the last mode until it is placed back into timed mode.

Associated Features	Associated Programming
	Resource: Attendant 4-03 Attendant Alternate 4-04 User Password 4-09

Conditions:

1. The extension User Password programmed for the Attendant extension is required for entry into Attendant Administration programming areas.
2. Only the designated Attendant or Alternate Attendant extensions may manually change the system Ring Mode using the feature code Feature 63.

Programming System Speed Dial

The system has 80 speed bins 20 - 99 which may be programmed with commonly dialed telephone numbers. Any extension, with a class of service of 0 through 6 may access a system speed bin to dial a telephone number. Some numbers require special handling, so special features, such as "CO Line Flash and Pause" may be embedded into a speed dial bin.

1. To enter a CO Line Flash ("hook-flash") in a System Speed number, press Feature 3. The stored "hook-flash" is indicated by a "/" character at telephones with displays. For example to enter "FLASH 1389" in a system speed number the entry would be: "Feature 3 + 1389". The displayed system speed number would be "/1389".
2. To enter a "Pause" in a System Speed Dial, press Feature 70. A stored pause is indicated by a "P" character. For example to enter "9P01188635773141" into a system speed number the entry would be "9 + Feature 70 + 001188635773141". The displayed system speed number would be "9P01188635773141".
3. To chain one speed dial number to another, press Feature 1 the speed dial number location to dial. For example; if a very long telephone number will not fit into one speed number location, split the number into two locations. To store the number "12345678901234567890", for example, into locations 20 and 21:
 - Enter into location 20: "1234567890Feature 121".
 - Enter into 21: "1234567890"
 - Dial this sequence of numbers by accessing only Speed bin location "20."
 - A maximum of 16 digits can be entered into any one speed bin.

CFW AUXI Lamp

Each extension comes equipped with an Auxiliary Status Lamp at the top of the telephone. This lamp is lit in several different ways to signify the status of the extension. One of which is call forwarding. Once an extension user forwards their telephone using "Feature 2" the status light will be lit solid. The attendant may "turn off" the light on the status bar extinguishing it when calls are forwarded. However, it will work for all other status changes.



Incoming filter U (unring or no ringing)

Incoming Filter allows the attendant to filter inbound telephone numbers from ringing into the telephone system. This requires Caller ID.

- No Ring Mode - There are five ringing assignments that can be achieved with the Incoming filter. They are never, always, day, night and noon. Once selected the telephone number will not ring at that time. Any other time that the system matches the number the system will present the call with one alert tone, but no other ringing will be heard.
- Filter index - Enter the database filter index number 01 - 50. 01 is the first entry in the filter index database, and 50 would be the last entry in the database.

Incoming filter R (ringing)

Incoming Filter allows the attendant to filter inbound telephone numbers from ringing into the telephone system. This requires Caller ID.

- Ring Mode - There are five ringing assignments that can be achieved with the Incoming filter. They are never, always, day, night and noon. Once selected the telephone number will only ring at that time. Any other time that the system matches the number the system will present the call with one alert tone, but no other ringing will be heard.
- Filter index - Enter the database filter index number 01 - 50. 01 is the first entry in the filter index database, and 50 would be the last entry in the database.

Associated Features	Associated Programming
	Resource: Incoming Ring Filter 4-32

Conditions:

1. Incoming ring and incoming unring filters are used together when entries are in both tables. The Incoming ring filter is checked first, if a match is found the call will ring, if no match is found the call will not ring.
2. Be as specific as possible with the entries because a non-specific entry may result in no lines ringing into the system.

Optional Sensor Function

The system can be equipped with up to 4 security sensor connections, which when programmed, can show if a device is left open. This requires the option module and ancillary equipment such as door sensors. The Attendant can set and reset following sensor programming.

1. SC. AL. DELAY - A sensor will activate every time the contact is opened. This means that the sensor alarm will be activate several times, which may not be desirable. Therefore, the delay, which is measured in minutes, will allow a preset time to pass before the alarm sensor activates.
2. SC. AL. Cancel - Like an alarm system the telephone system can alert internal or external parties of an open sensor. The Security Alarm Cancel is a timer which allows the situation to be investigated before sending the alert notification. This timer is adjustable from 0 (immediate) to 120 seconds. If the password is not enter in the correct time, the system will begin the alert procedure.
3. SC. AL. Period - This is the period of time that the internal extension will be alerted of an open sensor. Any external numbers will continue until the notification is complete or the Call Out Timer is reached (The Out Call Timer is set in the system administration programming).
4. SC. PSWD: 0000 - Sensor Control Password is used to reset an alarm sensor once is has been activated.

Associated Features	Associated Programming
	Resource: Security Alarm Action 4-29 Option relay Function 4-30

Conditions:

1. For Voice to function, an optional voice mail system must be installed.
2. This function requires the Option Module.

Voice Mail Shutdown Procedure

The voice mail system uses an embedded Linux processor, which requires it to be shut-down properly. Failure to do so may scramble the voice mail database files and requiring it to be sent in for repair. In addition, it is a good idea to use an Uninterrupted Power Supply (USP) system in front of the system to ensure that the voice mail does not experience any unscheduled power failures or power fluctuations such as brownouts.

Authority Code (Traveling Class of Service)

Feature  

Authority Codes are used to bring a more privileged Class of Service to an extension with a less privileged Class of Service. When using Authority Codes, the extension password must be entered.

Associated Features	Associated Programming
Toll Restriction Digit Intervals 5-01 Toll Restriction Password codes 5-02 Extension Day/Night Class of Service 1-EN-01/02 CO Line Day/Night Class of Service 2-LN-01/02	Extension Toll Restriction 1-EN-01/02 Resource - Time Switching 4-07 Station Message Detail Recording 3-18

Conditions:

1. Error tone is heard when an invalid account code is entered, and the telephone will return to an idle state.
2. When a valid account code is dialed, the extension is connected to a CO Line, and the Account Code’s Class of Service is verified before a call is placed.



Automatic Hold

Feature  

This feature enhances extension users' productivity and helps eliminate accidental "lost calls" by automatically placing the current call on hold, while answering another CO Line call. For example, when a user is on CO Line 1, and presses CO Line 2, CO Line 1 will be placed on "Exclusive Hold" automatically. Similarly, while on an intercom call and talking with another extension, by pressing a CO Line button, the intercom call will be placed on Exclusive Hold. The need to press Hold is eliminated, except if you want to place a call on System Hold.



Associated Features	Associated Programming
CO Line Group 2-LN-07 Exclusive Hold Feature 	Call Handling EX_Hold Time 3-03 Recall Time 3-13

Conditions:

1. The Feature Code (Feature  ) may be programmed under a flexible button on a Digital Speakerphone. To enable/disable the feature, press the flexible button.
2. If you access an idle line and skip to another line before dialing, the first line will not be automatically placed on Hold. (Once a digit is dialed, the line is considered in use, so the automatic hold feature is active.)
3. The Automatic Hold feature places a call on Exclusive Hold.
4. If you have the Automatic Hold feature programmed on a feature button, the feature button lamp will light when the feature is enabled.

Automatic Record

Feature  



When a voice mail is installed, the system will permit 8 extensions to be placed into an Automatic Recording group. When this feature is enabled for an extension, the system will record all Central Office conversations automatically whenever the user is on call. The recording will be deleted automatically after the call is released or placed on hold unless the user presses Voice Record Button (Feature  ). All recording are stored in the extension user's mailbox.

Note:

Requires the Voice Mail System

Associated Features	Associated Programming
Voice Mail Digital Integration	Voice Mail Automatic Record Member 6-3-2

Conditions:

1. The Feature Code "Feature  
1. Outgoing call recording begins after the Call Duration Timer has expired.
2. Placing a call on hold constitutes completing a call and ends the recording function. If the recorded conversation prior to pressing hold is to be kept, the Voice Record button must be pressed prior to pressing Hold.
3. Auto Record and Voice Record occupy one voice channel on the Voice Mail system during the record operation. This resource consuming function should be deployed with careful consideration of the total available voice mail channels and the overall impact on other voice mail/auto attendant Associated functions.
4. Only eight (8) digital key telephones may be assigned for use with the Auto Record feature.
5. Requires the Integrated Voice Mail system.

Automatic Selection (CO/Intercom)

Feature  

This feature automatically selects a specific outside line or intercom (ICM) when the handset or the speakerphone button is pressed.

A line will not be accessed automatically when a telephone is receiving an incoming (outside or intercom) call or when a line is recalling at the telephone. However, the automatic line selection feature may be overridden by pre-selecting an outgoing line, or dialing an extension before lifting the handset, or pressing the speaker button.

Associated Features	Associated Programming
Private Line CO Line Group Ringing Line Priority	Extension Line Assignment 1-LN-04 CO Line CO Line Group 2-LN-07

Conditions:

1. SLT ports use #950 for Intercom, #95 + 1 + lg for line group and #95 + 2 + CO Line for individual lines. To release a CO Line or Line group an SLT must press Flash and then dial #950.
2. The system will not allow invalid directory numbers to be programmed during setup.
3. An Extension must have CO Line Access to any CO Line or Line group trying to be accessed.

Auxiliary Lamp LED Status Bar



Each Digital Key Telephone is equipped with dual colored LED's and an Auxiliary Lamp/LED Status Bar to assist users in recognizing the extensions' status. The LED will operate and indicate active CO line ringing, Intercom ringing, Mute, Message Waiting, Speakerphone/Headset Mode and Call Forward conditions.

Conditions:

1. The lamp may have more than one indication flashing or steady at one time as features are utilized in the system.
2. When "Extension Call Forward" is enabled, the Status Bar will be lit solid.
3. The LED status bar indicates several different functions such as Call Forward, Do Not disturb, or line ringing.

Background Music (BGM)

Feature  

The system comes equipped with one external music source input for Music-On-Hold and Background Music. When a Digital telephone is idle and this feature is activated, the user can monitor background music (BGM) through the telephone speaker. This feature can be activated using a feature code or press the programmed feature button (Feature  ). In addition, the Navigation Key can be used to enable and disable the Music-On-Hold feature.

Associated Features	Associated Programming
Music on Hold System and Extension Reminder	Resource - Music Source 4-21

Conditions:

1. When a flexible button is programmed to activate or deactivate BGM, the associated LED will not light.
2. BGM automatically turns off when an extension user receive or make a call.
3. BGM automatically turns on again when the telephone returns to an idle status.
4. Users with BGM enabled will not hear a system alarm reminder.

Barge-In (Intrusion)

See Intrusion - Extension

Busy Lamp Field (BLF) / Direct Station Select (DSS)

Depending on user requirements, any Programmable Feature Button can be programmed as a BLF button to monitor an extension's status; when an extension is off hook the programmed BLF button LED for that extension lights. When that extension is in Do Not Disturb, the LED will flash. This same button is used as a one-button Direct Station Selection (DSS) call button for quick transfer of calls or intercom calling.

Associated Features	Associated Programming
Do Not Disturb Flexible Feature Button Programming One Touch Transfer Feature Key Programming	Feature Key allow 1-EN-13 System Application Feature Key Copy 4-23

Conditions:

1. BLF/DSS buttons may be assigned to any of the 18 User Programmable Flexible Buttons.
2. Extensions in Do Not Disturb mode will cause the LED associated to that extension to flash.
3. Extensions that are busy will cause the LED associated to that extension to light steady.
4. The DSS function can be used to transfer calls to other extensions.

Busy Ring Allow/Deny

Feature

This feature allows the extension user the ability to turn on or off muted ringing of incoming or transferred calls when the user is in a busy status. When a CO Line is ringing or transferred to a busy extension and Busy Ring is allowed, the user will hear muted ringing. When a CO Line is ringing or transferred to a busy extension and Busy Ring is denied, the user will hear a single burst of warning tone. All programmed call forwarding and recall conditions apply in either Busy Ring condition.

Associated Features	Associated Programming
Transfer Transfer Beep Enable (Feature)	

Conditions:

1. This feature will toggle on/toggle off when it is programmed under a flexible button on the Digital Speakerphone.
2. The LED will not light when the feature is enabled, or disabled.

Call Attendant (Operator)



The extension that is programmed as the Attendant may receive multiple internal calls via the programmed Operator Code "0".

Associated Features	Associated Programming
N/A	Resource Attendant 4-03 Resource Alternate Attendant 4-04

Conditions:

1. The Operator Code (0) is in addition to the default assigned two-digit intercom number for the extension.
2. The attendant two-digit extension number can be assigned to any feature button.

Call Back – Extension

Feature or Press "cbck"

This feature allows the user to queue an extension, which is busy, in Do Not Disturb (DND) or idle. When a user sends a Call Back to a busy extension, the Call Back process will begin when the busy extension hangs up. When Call Back is sent to an idle extension, the Call Back process will begin once the user performs an operation at that extension and then hangs up.

When the Call Back process begins the user will hear bursts of tone signaling them to pick up the handset or press the LCD soft key under 'reply'. Then the queued extension begins ringing.

Associated Features	Associated Programming
Intercom Mode Selection (F ^{INT} 9 5) Forced Intercom Tone Ring (F ^{INT} *) Flexible Button (F# 3) Interactive Soft Buttons Voice Announce / Handsfree Reply F ^{INT} 9 8	

Conditions:

1. If the user presses [del] during the Call Back Alert ringing, the Call Back will be cancelled and the display will read "CBCK DELETE". The user's extension returns to an idle status.
2. To invoke a Call Back at an extension that is in the Voice Announce mode, the user must press Force Tone Ringing (F^{INT} *).
3. When a Call Back alert is not answered at the extension that invoked the Call Back, the display message "CBCK TO EXT" be displayed until either they [reply] or [del].
4. The Call Back process begins when both the user's extension and the called party's extension are idle, on-hook.

Call Duration Timer (Incoming/Outgoing)

This feature is enabled in the Database Programming on a per extension basis. When enabled, any outgoing CO Line call will be automatically timed, then when the system "Warning Tone" time expires, the call is released. This feature is normally used to control outgoing call traffic.

Associated Features	Associated Programming
Warning Tone 1-EN-08 Warning Time 3-12	Outgoing Drop 1-EN-09 Incoming Drop 1-EN-10

Conditions

1. After the Call Duration Time has expired, the Call Timer begins.

Call Forward Extension







Feature

There are several call forward options to choose from; each extension user can customize their own call forwarding. However, no call can forward to more than one destination.

- “Idle” Forward all calls,
- “Busy” Forward calls only when the extension is busy.
- “Follow Me” Use the follow me feature to receive calls at a temporary location and activate the feature remotely from another extension.
- “No Answer” Forward calls that go unanswered at an extension.
- “External” Forward incoming calls to another location or different telephone number. (This feature must be enabled for your extension in database administration.)

Forward conditions may be set as follows for each call forward type:

- Intercom calls only.
- Intercom and CO Line (including transferred CO Lines) calls.
- CO Line calls only.



Associated Features	Associated Programming
Do Not Disturb (F ) Call Forward (F ) Message Waiting (F  ) Forced Intercom Tone Ring () Intercom Mode Selection (F  )	Extension Receive Assignment 1-EN-05 Predefined CFW 1-EN-21 ECF Allow 1-EN-22

Conditions:



1. Intercom calls to a forwarded extension will receive a special tone signifying that the extension called is forwarded.
2. The Auxiliary Lamp will not light in call forward mode if it has been disabled by the attendant in Attendant Administration.
3. If any of the Call Forward features are programmed on a flexible button, the LED associated with that button will light indicating that call forward is active.
4. External call forward is programmed in Attendant Administration programming, allowing one inbound CO Line to forward to a preprogrammed, outbound CO Line.

Call Park / Call Park Answer

Feature  

This feature allows calls to be placed in “Park” at any extension. It also is used to retrieve a parked call from any extension. Calls are parked and retrieved by dialing the Call Park code (Feature  ) followed by the extension number where the call was parked.

Call Park is similar to transferring a call to a hold location, that is accessible from any extension in the system.

Associated Features	Associated Programming
Flexible Button Programming (F#   Pick up Groups CO Line Transfer (idle/Busy)	Call Handling Recall 3-13

Conditions:

1. Each telephone/extension has one personal extension number used to park one CO Line call.
2. Any extension can park a call at another (installed) extension.
3. The Call Park feature code may be programmed on any programmable feature button.
4. Calls can be retrieved from any extension.
5. Parked CO Lines are on Transfer or Exclusive Hold at the extension that placed the call in parked.
6. Any extension can retrieve a “parked” CO line, even if the extension is normally not allowed to access or receive a call on that line.
7. A user invokes “Call Park Answer” and has no CO Line button for the line retrieved from call park may use Hold Call Answer to place the call on hold and retrieve the call from hold.
8. The Call Park Answer feature code may be programmed on any programmable feature button.
9. Calls that are parked follow the Transfer Recall Timer and will ring the initiating extension when that timer has elapsed.

Call Pickup Group

Feature   / Feature  

An extension can answer calls ringing at another extension by using the Call Pickup Group feature. This feature allows users to easily access calls ringing within a group by dialing the pickup code or pressing the preprogrammed button.

If multiple calls are ringing at an extension, a priority list determines which call will be answered first.

Call Pick Up Priority List:

- Camped - On CO Line Calls
- Recalling CO Line Calls
- Transferred CO Line Calls
- Incoming CO Line Calls
- Tone Ringing Intercom Calls

Associated Features	Associated Programming
Intercom Tone Ringing	Extension Pickup Group 1-EN-07

Conditions:

1. If the call at the dialed extension has stopped ringing, before the call is picked up, the user will hear error tone and the display on a Digital Speakerphone will show "PICKUP FAILURE."
2. An extension that doesn't have the outside line appearing on a button or doesn't have CO Line Receive programmed may still answer the ringing line by the Call Pick Up procedure.
3. The Call Pick Up feature code may be programmed on any programmable feature button.
4. If several calls of the same priority are ringing at the extension, the calls are answered in the order they are received.

Caller ID (Standard on all CO Lines)

The Caller ID feature requires Incoming Caller Identification as facilitated by the local telephone company. This telephone company feature requires a subscription to the telephone company service to operate.

The system is equipped standard to receive Type 1 Caller ID data from the telephone company on all CO Line interfaces. This data when received by the telephone company will be displayed on all ringing digital display telephones.

Associated Features	Associated Programming
Call Log SMDR	

Conditions:

1. CID data will only be displayed when it is received from the telephone company as part of the service subscription.
2. Using the navigation buttons, select "Call Log". Press the Up button, for outgoing, and the down button for incoming call logs.

Caller Identification - Call Log

Each extension is equipped with a Call Log that stores both inbound (received) and out-bound (dialed) calls. Using the navigation buttons, select "Call Log". Press the up button to view outgoing and the down button to view incoming calls placed to/from the extension. The Call Log is stored in reverse order, from newest to oldest. If the name is not supplied, only the number will be listed, if the name is supplied, the name will be displayed. Press the "Activation" button to initiate a call back to the displayed telephone number.

Associated Features	Associated Programming
	Call Handling Country Code 3-27 Long Distance Prefix 3-28 Local Area Code 3-29 Resource CID RPT MOD 4-25

Conditions:

1. All digital display telephones have a Caller ID Table
2. If no name is delivered from the telephone company, the number only will be displayed.
3. Proper programming of local area code(s) and the long distance prefix are required to assure accurate redial of CID numbers from the call log Table.

Call Waiting

Feature  

When enabled, the user will hear an alert tone when an internal call is waiting. Toggle the feature on and off when it is programmed on a Flexible Button.

Associated Features	Associated Programming
N/A	N/A

Conditions:

N/A

Camp On – CO Line

Feature  

Whenever a busy CO Line is accessed, either directly by pressing a button or through a dial codes, such as “9”, this feature allows the caller to queue a busy CO line and reserve that line for use when it becomes available. This feature eliminates the need for you to continually observe the line status for availability. You may only have one Call Back active at any time.

Associated Features	Associated Programming
N/A	N/A

Conditions:

1. During call back alert tones, lifting the handset will directly connect the extension user to the selected CO Line calling back.
2. Every CO Line can have Call Back requests by all extensions at the same time.
3. Every extension may Call Back only one busy CO Line at the same time.
4. The Call Back Alerting Ring Time is 10 seconds. If the call back goes unanswered during the 10 seconds ring time the call back is canceled.
5. CO Lines that have Call Back requests will recall the Call Back initiator. The Call Back CO Line will become available to other extensions if the call back extension doesn't answer within 10 seconds.
6. Call Back from an extension using a Pooled Group button for access of CO Lines will set the call back to all the lines in the Pooled Group. When any one of the lines in the Pooled Group becomes available the user must lift the handset or press the reply soft key to be connected to the available line from the Pooled Group.
7. During the time that the Call Back is recalling the initiator, a new incoming call will take precedence over Call Back and will be answered when the extension goes off hook.

Conference

Feature 

The system can accommodate up to eight (8), 4 member (party) conferences, simultaneously. Conference combinations, all conferences require one extension and can support up to three additional CO Lines or Extensions, to a maximum of 4 conference members. One inside key telephone extension is considered the controller of the conference, and constitutes one conference member.

Associated Features	Associated Programming
N/A	N/A

Conditions

1. While establishing a conference or privately talking to one party all extensions involved in the conference will be placed on Exclusive Hold.
2. If the initiator exits the conference the most recently invited, internal party, will automatically become the new controlling party.
3. If the Conference Tone is enabled, a burst of tone will be heard by all participants each time a new participant joins the conference.

- A three party conference must be established before adding the fourth party. The initiator makes the first two calls, and places them on hold, then presses the conference button. This creates a three party conference. To add the additional conference member, the initiator presses hold, makes the final call, and presses the conference button.

Data Rate

Feature **7** **5**

The Data Rate setting is used with extension 55, and should not be changed.

Associated Features	Associated Programming
N/A	N/A

Day and Night Modes

Feature **6** **3**

The system can be programmed to follow a seven day, twenty-four hour time schedule that will automatically switch the system from Day to Night modes. These modes will affect the incoming call ringing assignment by sending them to their programmed day or night destinations. In addition, the Attendant can change the system manually from Day to Night mode. Doing so will leave the system in that mode until it is manually changed. The Feature code (Feature **6** **3**) is used to toggle between these modes.

Associated Features	Associated Programming
Attendant Administration (F# 0) Night Service Mode (F 6 3)	Extension Ring Assignment 1-EN-06 Hunt Group Answer 2-LN-03 Resource - Time Switching 4-07 CO Line Class of Service 2-LN-01/02 Extension Class of Service 2-LN-01/02

Conditions:

- At default, no CO Lines (CO Lines) are programmed to ring an extension.
- The system operation Mode must be set to "Time Mode" for the system to automatically switch from day to night mode ringing.

- When programming Time Service Mode switching, the input time represents the time of day that the service mode will change to the associated Service Mode.

Default Flexible Buttons

Feature  

Use the default flexible button feature to bring the telephone's flexible button back to factory default. This will require the extension users password.

Associated Features	Associated Programming
N/A	N/A

Default Settings

Feature  

This feature is a quick way to deactivate any features which have been changed from factory default at an extension. For example, it will disable any Call forwarding, DND, etc. with one entry code. No Button programming is defaulted.

TABLE 5.3 Settings that are defaulted with Feature 69

Feature	Default Settings
LNR	Empty
SNR	No Save Number
Auto Hold	No
Phone Lock	No
Voice Call	Allow
Call Wait	Deny
Page Receive	Yes
Busy Ring	Yes
XFR Beep	Enabled
Touch Tone	Off
Headset	Disable

Conditions

1. No Flexible Buttons will be changed
2. Any Activated or deactivated feature will be set back to default, but no database parameters such as Class of Service, Predefined Forwarding etc., will be changed.

Directed Call Pickup

See "Call Pickup Group" on page 50

Distinctive Ring

Feature  

At default, all extensions ring the same way. However, each extension may select between four distinctive ring tones.

Associated Features	Associated Programming
N/A	N/A

Conditions:

1. The Telephone must be idle when the code is entered.

Do Not Disturb

Feature 

When invoked, Do-Not-Disturb (DND) prevents all calls, intercom or CO Line, from ringing at an extension in Do Not Disturb. DND may be activated while the telephone is in use or is idle. Some extensions with a more privileged Class of Service (COS) may have the ability to override an extension's DND setting.

A short stutter tone is audible when DND is active. The speakerphone is capable of having the DND feature assigned to a programmable button which will light whenever DND is active. Other extensions with a programmed DSS/BLF button of the extension that is in Do Not Disturb, will flash indicating that the extension is in DND. The Do Not Disturb feature,

found in Extension programming 1-EN-19, must be enabled or the system will not have the ability to activate the DND feature.

Associated Features	Associated Programming
Call Forward (F ²)	Extension DND allow 1-EN-22
Feature Button Disable 1-EN-13	Extension Class of Service 1-EN-01/02
Do Not Disturb Override	Extension Monitor Class of Service 1-EN-03
Flexible Button Programming (F# ³)	Feature Button Disable 1-EN-13

Conditions:

1. Do Not Disturb cannot be enabled if any form of extension Call Forward is active
2. To redirect a ringing call to the attendant, press the preprogrammed "DND" feature button while the call is ringing.
3. When an extension is in DND, all other extensions with a DSS/BLF of that extension, will flash to indicate that the extension is in DND.
4. The DND feature code may be programmed on a programmable feature button.
5. A feature button programmed for the DND code will light steady whenever DND is active
6. When an extension is in DND the LED Status Bar over the display is lit solid.

Do Not Disturb - Override

DND - Override is used to intercom an extension which has been placed in DND. At default no extension has the ability to override another extension that is in DND mode. If available to an extension "override" will be displayed in the LCD when an extension has activated DND. Press the associated interactive button to override DND.

Associated Features	Associated Programming
Call Forward (F ²)	Extension Class of Service 1-EN-01/02
Voice Announce Hands Free	Feature Button Disable 1-EN-13
	DND Allow 1-EN-19
	ICM Mode 1-EN-15

Conditions:

1. An extension in DND that has been overridden will tone ring indicating the override.
2. An extension in DND that has been overridden may invoke Forced Intercom Call Forward, which will redirect the call to the attendant.
3. The DND feature code may be programmed on a programmable feature button.
4. Only extensions with a more privileged (0 being the highest and 9 being the lowest) Class of Service will override an extension in Do Not Disturb.

Enhanced Lettering Scheme

The Enhanced Lettering Scheme is used to accommodate special characters that may be needed when entering an extension user names or when editing any of the preprogrammed messages. There are five different lettering schemes to choose from, but only one can be selected for an installation. Use the "1" key to select one of the special characters, when entering a name or preprogrammed message.

Character for nth depressions of dial key "1".

	1 st	2 nd	3 rd	4 th	5 th	6 th
Scheme 0	Æ	Œ	ø	Ø	á	Á
Scheme 1	Ç	Ā	Ō	Ū	Ā	Ă
Scheme 2	ò	é	é	è	à	ù
Scheme 3	č	š	é	ŋ	ō	ř
Scheme 4	Á	É	Ó	Ū	Ú	
Scheme 5	Ł	Ż	Ŕ	Ŗ		

Associated Features	Programming
Name in Display Text Messaging	Resource Preprogrammed Message 4-11-1 Premises Message 4-11-2 User Name 4-10

Conditions

1. This is a system wide feature, so only one letter scheme can be selected at each installation.

Extension Feature Status Check

Feature  

Extension Feature Status Check allows digital telephone users to quickly view the setting and status for all user controlled features. It is also a great troubleshooting tool for technicians, allowing them to determine the status of specific features which are programmable by the user.



- LNR = empty or the last number dialed
- SNR = No Saved Number
- Day COS = 0
- Night COS = 0
- Monitor COS = 5
- Auto Hold = Deny
- Phone Unlocked
- Voice Call = Allow
- Call Wait = Deny
- Paged = Allow
- Busy Ring = Allow
- XFR Beep = Enable
- Data Rate = 9600
- Forced LCR = N (N0)
- Touch Tone = Off
- ECF = Disable

Conditions:

1. Listed here are the default (factory) values for each of the displayed features. Therefore, the actual values may appear different.

Extension Groups

Extension Groups are used to group extension that have something in common, such as a sales group, so that they receive the same group pages and announcements. There are eight (8) extension groups; an extension can only be a member of one Group.

Associated Features	Programming
Extension Paging	Extension EXT_Group 1-EN-07





Conditions

1. Extensions may be assigned to only one Extension Page Group.
2. Pages are heard over the speaker of an idle digital extension.
3. Busy extensions, extensions in DND, and extensions that have invoked Page Deny, at their extension will not receive page announcements.
4. Extensions that are receiving page announcements are busy for other intercom calls.
5. Extensions that are receiving page announcements will show busy on DSS/BLF buttons at other extensions.

Extension Password / Phone Lock

Feature  

Each extension has a User Password which is needed to access certain features such as; Follow Me Forward, Authority Code, and Phone Lock features.

Associated Features	Programming
Phone Lock/Unlock (F  ) Call Forward (F ) Authority Code (F  )	Resource User Password 4-09

Conditions

1. Each extension can customize their password at any time.
2. The password of the extension that is programmed as the attendant, becomes the "Attendant Password".

Extension Pick Up Groups

Feature  

Extension pickup groups allows the user to dial a code and pick up an actively ringing call within their group. The digital telephone will give a short double tone burst and update the display to say "Pickup Failure" when attempting to pick up a call that is not within the group.

Associated Features	Programming
	Extension Group 1-EN-07 Ringing Assignment 1-EN-05 Receive Assignment 1-EN-06

Conditions

1. Extensions may be assigned to only one Extension Pick Up Group.
2. Requires the Option Module.

Extension Programming Copy

Extension Programming Copy allows the programmed settings from one extension to be applied to other extensions. The settings may be copied from the source extension to an individual extension or to a group. Individual extensions to be programmed must be selected one at a time. When copying to a group, a Pick Up Group is selected and all extensions assigned to that group will receive the copy.

Associated Features	Programming
N/A	Resource CO Line Copy 4-13 Extension Copy 4-14 Feature Key Copy 4-23



Conditions

1. The source extension must have all programming changes completed prior to invoking a copy. When using Group Copy, all extensions to receive the copy must be programmed for the same Pick Up Group - this will associate them with the other extensions to receive this copy.

Extension Reminder

Feature  

Each extension has a private alarm that can be used to remind them of special appointments, events, etc. When the alarm activates the user will hear ring tone for a programmable period of time ranging from 10 to 60 seconds. After the programmed period the alarm is automatically canceled. The extension user can program the alarm to be activated once or always (repeated). When programmed for always, the alarm will sound at the same time everyday.

Associated Features	Associated Programming
Distinctive Ring 2-LN-09 Attendant Administration (F  )	Call Handling Remind Time 3-06

Conditions:

1. The Alarm Clock feature code may programmed under any programmable flexible feature button.
2. The alarm clock will be automatically canceled after the programmed Alarm Play Time.
3. The display will be unchanged until [ack] is pressed or when the telephone is used for another call.

Extension Swapping

Extension Swapping allows extension directory numbers to be exchanged from one port to another. This feature can be used to simplify moves and changes of extensions at any specific location. Extension directory numbers which are swapped will retain their designated programming.

TABLE 5.4 Directory Number List

Module	Circuit	Type	DN	Module	Circuit	Type	DN	Circuit	Circuit	Type	DN
Main 01	01	D	10	Exp1 - 02	01	D	21	Exp2 - 03	01	D	21
Main 01	02	D	11	Exp1 - 02	02	D	22	Exp2 - 03	02	D	22
Main 01	03	D	12	Exp1 - 02	03	D	23	Exp2 - 03	03	D	23
Main 01	04	D	13	Exp1 - 02	04	D	24	Exp2 - 03	04	D	24
Main 01	05	D	14	Exp1 - 02	05	D	25	Exp2 - 03	05	D	25
Main 01	06	D	15	Exp1 - 02	06	D	26	Exp2 - 03	06	D	26
Main 01	07	D	16	Exp1 - 02	07	D	27	Exp2 - 03	07	D	27
Main 01	08	D	17	Exp1 - 02	08	D	28	Exp2 - 03	08	D	28
Main 01	09	A	34					Option 04	01	A	36
Main 01	10	A	35	Modem		Hybrid	55	Option 04	02	A	37

DN = Directory Number, Type = D for Digital and A for Analog Port

Associated Features	Programming
N/A	Control Dir to Location 6-6 Location to DIR 6-5

Conditions

1. Extension directory numbers can only be swapped with other valid numbering plan defined extension directory numbers.

Extension User Name

Each extension in the system may have an alphanumeric designation. This extension name may be up to 6 characters in length. Each name may contain upper and lower case letters, numbers and special characters which are available through the Enhanced Lettering Scheme feature. The Extension User Name is programmed in Database Programming.

Associated Features	Programming
Intercom Calls	Resource - Letter Type 4-02 Resource - User Name 4-10

Conditions

1. The programmed Extension User Name will be displayed at called extensions whenever intercom calls are made for one extension to another.
2. Whenever there is no Extension User Name programmed, the characters "EXT" are displayed.
3. When a User Name is programmed for extensions the "EXT" normally displayed at that idle extension will be replaced with the programmed name.
4. Names may be six (6) or fewer characters.

External Music Source

The system comes equipped with one 3.5mm mini-phono jack that supports one External Music Source. The source of the music can be a CD player, radio, tape deck, or other Message/Music On Hold source. Additionally, each digital speakerphone can monitor the music source by enabling the Music-on-Hold feature, "Feature **5 2**"

It is the user's responsibility to complying with all applicable music industry restrictions and copyright laws.

Associated Features	Programming
Background Music (F 5 2)	Resource Music Source 4-21

External Paging

Feature **JKL 5 OPER 0**

External Paging allows the user to make announcements over an ancillary paging device (amplifier and speakers). When paging, one-way access is provided to an external page amplifier or multi-zone page controller. Multi-zone operation is possible when an ancillary multi-zone controller is connected to the system. The controller must accept/respond to industry standard DTMF signaling.

Another way to access this feature is by using the Navigation Keys. Press the Left Navigation Key three times, or the Right one 5 times, until PAGE is displayed. Press the Up Navigation Key for All Call Page, and the Down Navigation Key to select a group to page.

Associated Features	Programming
Paging (F 5 0 x) Meet Me Page (F 5 9) Page Allow (F # 9)	Extension Paging Group 1-EN-07

Conditions

1. The External Page access code may be programmed on any feature button.

FAX Detection with Automatic Transfer

Standard FAX Detection with Automatic Transfer is available on all CO Lines in the system. When programmed the system will listen for the FAX's CNG tone, if detected, the system will automatically transfer the call to a programmed extension within the system.

Associated Features	Programming
CO Line Fax Transfer to 2-LN-10 Single Line Telephone	

Feature Key Allow

All Digital Extensions can have their Feature Key enabled or disabled. At default, the feature key is enabled. However, if disabled the extension will not have the ability to use any feature that is not programmed on a button or any feature that requires the feature key to operate correctly. Single Line Telephones with the Feature Key disabled, will not have access to features that require the "#" key to be activated.

Associated Features	Programming
All features accessed using the Feature button.	Extension Feature Button Disable 1-EN-13

Conditions

1. The only feature that does not require the feature key to be dialed first is "Account Code" which only requires the digit 4 to be dialed.

TABLE 5.5No Feature Key Required

01 – 20	Extension Speed Bins(ABBR)
20 – 99	System Speed Bins (ABBR)
82 – 89	Hunt Group
01 – 09	CO Lines
0	Attendant
9	CO Line Group Access
4	Account Code
* (After Ext)	Force Tone Ringing

TABLE 5.6Feature Access Codes - Alphabetical:

Alphabetical Feature Code List			
Access Specific CO Line	F0x	Flexible Feature Button Programming	F#3
Answering Machine Emulation	F64	Group Call Pick up	F54
Attendant Administration	F#0	Headset Enable/Disable	F9#
Authority Code	F55	Hot Dial Disable	F#6
Automatic Selection	F95	Intercom Call Back	F91
Automatic Line Deactivate	F*95	Intrusion	F72
Automatic Record	F67	Last Number Redial	F8
Automatic Hold	F94	Least Call Routing (LCR)	F68
Background Music	F52	Message Waiting	F96
Busy Ring Allow/Deny	F#2	Monitor	F7*
Call Forward	F2	Multiple Mailbox Button	F66
Call Park (Park or Answer)	F73	Mute	F76
Caller ID Review	F6#	Page	F50
Call Wait Allow	F99	Page Allow/Deny	F#9
Conference	F60	Page Meet Me	F59
Data Rate	F75	Pause	F70
Day/Night Mode	F63	Phone Lock/Unlock	F97
Default Flexible Buttons	F58	Relay Control	F61
Default Setting (Extension)	F69	Saved Dialed Number	F51
Directed Call Pickup	F53	Security Control	F62
Distinctive Ringing (Ring Type)	F#7	Speed Dialing (abbr. Dialing)	F1
Do Not Disturb (DND)	F4	Status Message	F90
Extension Feature Status	F#8	Touch Tone Off/On	F#1
Extension Password - Phone Lock	F97	Transfer Beep Enable/Disable	F79
Extension Reminder	F92	Voice Call Allow/Deny	F98
Extension Reminder Delete	F*92	Voice Mail	F64
Flash (CO/PBX)	F3		

Flash Recognition – Analog Port SLT

Flash refers to the command issued at an analog device to invoke system features. Flash is the momentary operation of the hook-switch at an analog device. Conversely, the on-hook command at an analog device signifies an on-hook disconnect/hang-up request.

The momentary operation of the hook-switch at the analog device is deciphered by the system in such a way that the previous call in progress is held, or placed in a status of transfer awaiting further instructions from the user.

Flash Recognition is the specific timing associated to a user flash request. There must be setup to decipher a flash command from an on-hook command where the user may go on-hook then immediately off-hook again to place a call. There are two settings in the flash recognition timing. The Start Time and the End Time.

Associated Features	Programming
Call Park – SLT	Call Handling 3-16
Transfer – SLT	SLT Hook Flash Start
System Hold – SLT	SLT Hook Flash End

Conditions

1. The Start Time can be set very low to detect very fast operation of the hook-switch but care should be taken when using low Start settings since the timing may allow line noise to trigger a flash command.
2. The End Time can be set very high to detect very slow hook-flash operations but care should be taken when using high End settings since the timing may not allow the triggering of On-Hook commands in an acceptable period for the user.
3. Use the default Start and End timing wherever possible.

Flash – CO Line

Feature

Flash – CO Line, is a programmed setting that will determine what flash timing will be presented to the telephone company central office when the user issues a Hook-Flash command while connected to a CO Line. The Flash command is very important when using Centrex CO Lines. For easy access it is recommended, in these two cases, the Flash feature code should be programmed onto a Flexible Feature Button.

The CO Line Flash Feature is used to access a second call using the telephone company provided Call Waiting service.

Associated Features	Programming
Last Number Redial Speed Dial (ABBR) System Speed Dial (ABBR) Individual	Call Handling CO Flash Time 3-05

Conditions

1. The Flash code may be stored in any speed dial bin.
2. The Flash code may be stored in the Last Number Redial buffer.
3. The Speakerphone will display “/” to indicate the Flash.
4. The Flash time is programmable from 100ms to 1500ms in increments of 100ms (1/10th of a second) increments.
5. When the flash is dialed, the “CO Line” will be displayed temporarily.
6. Single line extensions must generate a hook-flash on the analog port then dial  to generate a hook-flash on a CO Line.

Flash - PBX Line

Flash - PBX Line is a programmed setting that will determine what flash timing will be presented to the Host PBX System when the user issues a Hook-Flash command, while connected to a CO Line. The Flash command is very important when using Centrex CO Lines. For easy access it is recommended, in these two cases, the Flash feature code should be programmed onto a Flexible Feature Button.

The CO Line Flash Feature is used to access a second call using the telephone company provided Call Waiting service.

Related Features	Programming
Last Number Redial Speed Dial (ABBR) System and extension	Call Handling - PBX Flash Time 3-04

Conditions

1. The Flash code may be stored in any speed dial location.
2. The Flash code may be stored in the Last Number Redial buffer.
3. When you activate redial, a Digital Speakerphone display will show a “✓” to indicate the Flash.
4. The Flash time is programmable from 100ms to 1500ms in increments of 100ms (1/10th of a second).
5. When the flash is dialed, the “CO Line” will be displayed temporarily.
6. Single line extensions must generate a hook-flash on the analog port, then dial **#3** to generate a hook-flash on a PBX Line.

Flexible Feature Button Programming

Feature **#** **DEF 3**

Each Digital telephone has dual-color Flexible Feature Buttons that can be programmed as a CO Line, extension, or feature. These are termed flexible since each telephone is individually programmed, and the programming may be changed at any time.

Flexible Feature Buttons offer convenient, one-button access when activating desirable features. Some programmed feature buttons will light when activated (Call Forward, DND, DSS/BLF, etc.), while others do not (Background Music, Call Pick-Up, Last Number Redial, etc.).

Related Features	Programming
DSS Button Programming Feature Button Disable Extension - Line Assignment Feature Look-up	Extension - Feature Button Disable 1-EN-13 Resource Feature Key Copy 4-23

Conditions

1. If an invalid code is dialed a single tone burst (error tone) will be heard and the display will show "CODE UNAVAILABLE."
2. Users may program any CO Line even if they have no access to the Line in Database programming. Having a programmed button, will not give them access to the restricted line.
3. Valid feature codes must be in the form of either "Fn" or "Fnn" where "F" is the feature button and "n" is either a single-digit or two-digit code, including asterisk * and pound # dialed from the dial pad.
4. Any feature button programmed with a code previously assigned to a different feature button will cause the previously programmed feature button to become unassigned.
5. Flexible Feature Buttons can be cleared of any feature code/directory number by pressing "save" before entering a code/number.

Forced Intercom Tone Ring



When an extension is in Hands Free - Voice Announce mode, intercom calls will not forward, so the system allows callers to dial "*" to activate Forced Intercom Tone Ring which allows callers to ring the extension.

Related Features	Programming
Intercom Mode Selection	Extension - ICM Mode 1-EN-15

Conditions

1. It is not possible to force an extension from Tone Ring mode to Voice Announce mode if the extension is set to Tone Ring mode.
2. When an extension leaves a Callback, the alert signal will ring.

Group Call Pickup

Feature  

See "Call Pickup Group" on page 50

Headset Jack

Feature  

The headset jack on all Digital Speakerphones is a standard 2.5 mm jack, which will accept industry-standard headsets.

A headset connected to the headset jack operates as an integral component of the digital speakerphone.

Associated Features	Associated Programming
N/A	N/A

Conditions

1. The Headset Jack can be found next to the Handset Cord jack.

Hold, System (Common) & I – Hold Indication

Extension users can place any call on hold, by pressing the hold button. If the line place on hold is a CO Line, the line button will flash slowly at the phone that placed it on hold. On all other phones this line button will be lit solid.

"I – Hold Indication" refers to the color difference of the LED's. When an extension places a CO Line on Hold, I – Hold identifies that the call is holding for that extension with a flashing LED. A CO Line placed on hold by a different extension will change colors and be lit solid.

Related Features	Programming
Call Transfer Hold Reminder	Call Handling Recall 3-13 Remind Time 3-06

Conditions

1. When the conference initiator presses , the conference parties will be placed on Exclusive Hold. This feature is used when adding conference participants. The LED will flash green at the conference initiator's extension, and red everywhere else.
2. Calls placed on Hold will hear Music-on-Hold, only if an external music source is connected.
3. Calls placed on Exclusive (private) Hold, which have exceeded the programmed "Exclusive Hold time", will be automatically converted to System Hold.
4. There is a distinctive slow flash rate for a CO Line that is on System Hold.
5. There is a distinctive rapid flash rate for a CO Line that is on Exclusive Hold.

"Hold" Remind Time

When the programmable "Hold Reminder" timer is exceeded, a single ring tone is heard at the extension that placed the call on hold. This reminder, will be repeated each time the timer expires.

Related Features	Programming
Hold System/Exclusive	Call Handling Remind Time 3-06

Conditions

1. Hold Reminder applies to both intercom and CO Line calls.
2. Hold Reminder applies to CO Line calls that are on System Hold or Exclusive Hold.

Holding Call Answer – Select



Holding Call Answer allows a user to place and retrieve calls on and off hold by pressing the  button. When several calls are holding at an extension, Holding Call Answer will access the CO line that has been holding for the longest period of time while placing the current call on hold.

Holding Call Answer works for all CO Lines regardless of the extension's CO Line button programming. It is possible to retrieve calls that do not appear on a button at an extension via Holding Call Answer.

Single Line Extensions will use ***6** to answer a call placed on hold at their extension and ***7** to answer a call placed on hold at a different extension.

Related Features	Programming
CO Line Assignment Hold - Exclusive Hold – System (Common)	Call Handling Recall Time 3-13 Ex_Hold Time 3-03

Conditions

1. Holding Call Answer will also operate for intercom calls placed on hold.
2. If the person on Hold hangs up, the system will automatically release the held CO Line.

Hot Key Enable / Disable

Feature **#** **MNO 6**

At default, all digital telephones have the Hot Key Pad set to enabled. This allows the user to dial an extension or accessing a CO Line by dialing the number without lifting the hand-set or pressing the speaker button. If this feature is disabled, the speaker button or hand-set must be used to activate the dial pad.

Related Features	Programming
All "dial-access" features Intercom calling	

Conditions

1. It is not recommended to disable the Hot Key Pad when Auto Line Select (Prime Line Pickup) Feature **95** is set to a CO Line or Line Group, because it will make internal calling problematic.

Hour Mode Selection 12/24

Select the either 12-hour or 24-hour format to be display on all digital telephones.

Related Features	Programming
Alarm Clock – Extension Alarm Clock - System SMDR Attendant Administration System Time/Date 4-15	Resource Hour Mode 4-18 System Time 4-15

Conditions

1. When programming time related features, 24-hour format is always used for input.
2. SMDR output is in 24-hour format regardless of the settings of Hour Mode.
3. The correct system time is entered in database programming along with the Hour Mode Selection, from any Digital Speakerphone extension using the database-programming password.
4. The "AM" and "PM" indications are not displayed.

Hunt Groups



There are eight (8) Hunt groups that can be assigned up to 24 members. There are three (3) types of hunt groups: All Ring, Linear Hunt, and Voice Mail. Hunt groups 1 through 8 correspond to extensions (dial codes) 82 – 89. At default, Hunt group 6, Dial Code 87, is reserved for Voice Mail and already contains the voice mail extension numbers 56 ~ 63. In addition, at default Hunt groups 88 and 89 have all extensions preprogrammed into them, and Door phones 1 and 2 (SLT Ports on the Option Module 36 and 37) are programmed to ring those hunt groups.

Linear Hunt

Extensions in a linear hunt group will ring in the order that they are programmed. If a member in the sequence is busy, the next available member will ring, if all members are busy, the calling will get ring no answer. For instance, if Member 1 and Member 2 are busy, Member 3 will ring. As soon as the busy members are no longer busy, they are placed back into queue. When a pilot hunt group is dialed the members are always called in sequence, always starting with member 1.

All Ring

When the pilot number for an all ring hunt group is dialed, all idle extensions within the group will ring.

Voice Mail Hunt Group

When connected to an integrated voice mail designating a hunt group as voice mail type will allow the system to send or dial digits, known as In-band signaling or digits, required by the voice mail system.

Related Features	Related Programming
CO Line Ring Assignment	CO Line
Voice Mail (F ⁶ 4)	Hunt group Answer 2-LN-03
Call Forwarding	Control
Voice Mail Hunt Group (87)	Extension Hunt Group members 6-2-1-2

Conditions

1. Hunt group members should be entered in the order that they should ring. If the first entered extension is idle forwarded, it could cause all calls programmed to ring the hunt group, to forward.
2. When using a Linear Hunt Group, calls will only "hunt" to the next extension if the previous extension is busy.
3. When a call is presented to an all ring hunt group, and all extensions are busy, the caller will receive a busy signal.

Intercom Calling - Non Blocking - Intercom Button

Intercom Calling allows a user to place an intercom call by dialing the intercom number corresponding to the extension to be called. A DSS/BLF button can be programmed for placing an ICM call by pressing one button. Hands-free intercom calls can be placed without using the handset. Background noise may restrict the suitability of hands-free connections.

Each extension is capable of independently selecting how intercom calls are received. Either: Voice Announce Hands-Free or Tone Ringing mode Feature ⁹ 8. See intercom Mode Selection.

Related Features	Programming
Forced Intercom Call Forward Auxiliary Lamp Forced Intercom Tone Ring Intercom Mode Selection Flexible Feature Button Programming Intercom - Non Blocking	User programming only Flexible Feature Button Programming

Conditions

1. Intercom calls to telephones in Voice Announce - Hands-free are “logically” answered by the system at the called extension. Therefore these calls cannot be picked up by other extensions using Group Call Pickup. Auto Line Selection is set to “ICM” Intercom at default. So, intercom dial tone is heard automatically upon lifting the handset or when pressing the  button. If a called extension does not answer you can invoke a callback to that extension by pressing the soft button under the “cbck” button.

Intercom Call Back

Feature  

The Intercom Call Back feature is used to queue for an extension that may be busy or unattended.

The next time the extension, with an active call back queued becomes idle, this feature will automatically ring the telephone that initiated the Call Back. When the initiator presses the speaker button or lifts the handset, the extension with the queued Call Back will automatically begin ringing.

Related Features	Programming
Intercom Ringing Auto Line Select	User Programming Only Flexible Feature Button Programming

Conditions

1. An Extension can initiate one Call Back
2. No one Extension can have more than 5 Call Back queued at one time.

Intrusion - Extension

If "Intrusion" is allowed, an extension can join an active call by accessing the extension's DSS/BLF. This feature can be very effective for observing or training new personnel or any-time multiple people may want to be on one active call.

LEGAL NOTICE: This feature may violate privacy laws if used in a manner that is inconsistent with requirements of these laws. Manufacturer assumes no responsibility with regard to the use of this feature. It is provided for the virtue of ethical use only. YOU are responsible for using this feature appropriately considering all applicable laws.

Related Features	Programming
Extension Monitor COS	

Conditions

1. Your extension must have Intrusion Active set to "Y" yes for this feature to operate.
2. An Intrusion Tone will be presented to all parties when Intrusion is invoked extensions and CO Lines.
3. This feature may violate privacy laws if used in a manner that is inconsistent with requirements of these laws. Manufacturer assumes no responsibility with regard to the use of this feature. It is provided for the virtue of ethical use only. YOU are responsible for using this feature appropriately considering all applicable laws.

Intrusion Tone

If "Intrusion" is allowed, an Intrusion Tone will be heard by all parties. This tone can be turned off, allowing parties to intrude without a tone announcing the party. Be sure to check with the appropriate law enforcement agencies before disabling the intrusion tone.

LEGAL NOTICE: This feature may violate privacy laws if used in a manner that is inconsistent with requirements of these laws. Manufacturer assumes no responsibility with regard to the use of this feature. It is provided for the virtue of ethical use only. YOU are responsible for using this feature appropriately considering all applicable laws.

Related Features	Programming
	Extension Monitor COS 1-EN-03

Conditions

1. Your extension must have Intrusion Active set to "Y" yes for this feature to operate.
2. An Intrusion Tone will be presented to all parties when Intrusion is invoked extensions and CO Lines.
3. This feature may violate privacy laws if used in a manner that is inconsistent with requirements of these laws. Manufacturer assumes no responsibility with regard to the use of this feature. It is provided for the virtue of ethical use only. YOU are responsible for using this feature appropriately considering all applicable laws.

Last Number Redial

Feature

Last Number Redial (LNR) allows the user to automatically dial the last number dialed from their telephone. The LNR feature will retain up to twenty 20 digits for each extension. The user can select a specific CO Line to be used with LNR, by first pressing that CO Line button, or the user can allow the system to select a line to be used.

Related Features	Programming
Automatic Busy Redial	Resource Dial Wait Time 4-20 Dial Tone Detect 4-19

Conditions

1. Last Number Redial only works with CO Line calls.
2. When LNR is activated the system will first select the previously used CO Line to dial. If that CO Line is busy, any idle CO Line in the same group will be selected. If all CO Lines are busy, a busy tone is heard and "ALL CO Lines BUSY" will be displayed.
3. The database programming data fields Dial Wait Time and Dial Tone Detection directly affect the performance of LNR. When these features are enabled, the telephone will either wait until dial tone is detected on a CO Line, or wait for a preprogrammed period of time before digits are dialed from the LNR memory on the CO Line.
4. To LNR immediately depends on whether tone detection is allowed or pause timers apply. If tone detection is allowed, the system will redial the last number after CO Line dial tone is detected. Otherwise, the system will redial the last number only after the pause time for tone detection is exceeded.
5. The LNR feature code may be programmed on a programmable feature button.

6. LNR will repeat a hook-flash in the same sequence as it was first dialed. If a speed dial number was first dialed LNR will dial the speed dial number and any subsequent manually dialed digits.
7. If the Last Number Redial memory is empty, the telephone will receive error tone and the telephone will display: "LNR EMPTY"

Least Cost Routing

Feature  

This allows the system to determine which Line Group, and whether to insert or delete specific digits. Extension can be forced to use LCR when making Central Office Telephone calls. In addition, extensions can select to use LCR or they can be forced to use LCR.

Related Features	Programming
	Extension - Forced 1-EN-23 LCR Time 3-31 Restriction LCR Enabled 5-2-2

Conditions

1. This must be enabled in Database Programming

Loud Bell

The Option Module provides one loud bell dry contact which is rated at 24vdc, 1 Amp. Loud Bell Control: If the system is installed in high noise environments, there is often a requirement to equip a loud high-gain ringing device or flashing strobe light. Using the contact in this way provides for control of an optional, ancillary loud ringing device. The device is connected to the contact as a trigger. When ringing occurs on CO Lines in CO Line Groups designated as Loud Bell CO Line Groups, the contact closure operates and controls the connected device.

Related Feature	Programming
Extension Ringing	CO Line 2-LN-06 Control - Dry Contact 6-4

Conditions

1. The Loud Bell or Strobe light will be activated each time the associated CO Line rings.

Messaging – Premises

Messaging – Premises, allows extensions to program an extension status message that is displayed on other digital extensions, calling. For example, an extension can set their status to "Out to Lunch", so when other extensions call, this is displayed. Thus, the displayed message informs other users of the current status for the extension they are contacting. The user may select from six pre-programmed messages or they may create their own customized message.



Related Features	Programming
Intercom Calling	Resource Preprogrammed Message 4-11 Premises Message 4-12

Conditions

1. Dial Pad Key 1 is used to select special characters. Refer to the *Lettering Scheme* feature
2. Dial "*" before any dial pad key to insert the numeral on the dial pad key instead of a letter in this character position. Pressing the "*" after the letter is entered to get lower case letters.
3. When "#" is pressed after a letter has been selected for this character position, the selected letter is forced to lower case, Use to insert a space.
4. Messages can be 16 letters/symbols maximum.
5. The Message – Premises feature code can be stored on an available Flexible Feature Button.
6. When the Message – Premises feature code is stored on a Flexible Feature Button, that button is used to activate and deactivate the status message.
7. The Status Message will only update if the called telephone is ringing. If the extension answers handsfree, press the "*" key to activate ringing and received the status message.

Message Waiting

Feature  



When an extension calls a busy or unattended extension, they have the option to send a message waiting indication. The calling extension can select to use the interactive or dial the feature code Feature  .

Related Features	Programming
N/A	N/A

Conditions

1. Feature    is used to disable a Message Waiting Indication.

Modem (“Extension 55”)

The system comes equipped with an internal modem that is designed to attach a “Programming Terminal” to a remote system. A CO Line call, from one system to another, must be transferred to the modem extension () by either an Automated or Live Attendant. The remote extension dials “Feature”   and becomes the remote programming terminal. All system and extension features, with the exception of flexible buttons, can be programmed remotely.

Note: Refer to Appendix A for step by step instructions

Related Features	Programming
	Resource Modem Number 4-05

Conditions

1. To activate the modem, the call must be transferred.
2. All settings are automatic, no need for modem programming.

Monitor - Extension

Feature  

The Monitor feature may be useful for purposes of quality assurance, and allows conversations to be monitored at other extensions. The extension which is monitoring the busy extension or CO Line must have a higher priority setting for its Monitor Class of Service than the extension which is being monitored.

Since this feature is very similar to Intrusion, it is possible to “shift” between these two features when Monitor has been invoked. The monitoring extension may press the “Mute” button to join in on an existing “Monitored” telephone call.

LEGAL NOTICE: This feature may violate privacy laws if used in a manner that is inconsistent with requirements of these laws. Manufacturer assumes no responsibility with regard to the use of this feature. It is provided for the virtue of ethical use only. YOU are responsible for using this feature appropriately considering all applicable laws.

Related Features	Programming
Intrusion	Extension Class of Service 1-EN-01/02 Monitor Class of Service 1-EN-03

Conditions

1. The most privileged Class of Service is “0”, therefore, “9” is the least privileged level. At default all extensions have a Monitor Class of Service of “5”.
2. Extensions with the same monitor Class of Service, may not monitor each other.
3. Monitor is only allowed if the called extension’s Monitor Class of Service is less privileged than the calling extension’s Monitor Class of Service.

Music-on-Hold

There is one Music-On-Hold (MOH) input that comes standard with the system. If connected, all calls placed on hold will hear the music being played. In addition, digital extension users may monitor MOH as Background Music (F )

Related Features	Programming
Background Music (F )	Resource Music Source 4-21

Conditions

1. To use external Music-on-Hold, a music source must be connected to the MOH connection which comes standard with each system.
2. The connection is a Mono-mini plug, which is supplied with every system.
3. This is a standard 600 Ohm connection

Mute

Feature  

The mute feature, which appears on a fixed button, allows the user to temporarily disable their microphone, which allows them to have a private conversation with someone in their office. Additionally, the "Mute" key is used to enable two-way communications when the "Off-Hook Voice Announce is being used.

If the digital telephone is set to receive intercom calls using voice announce (Hands Free) and you are having a private conversation, simply press the mute key and the calling party can make an announcement, but will not be able to hear your conversation. You must press the mute button to talk to the calling party. When the call is terminated, the mute button must be pressed again.

Related Features	Programming
OHVA	

Conditions

1. When MUTE is active, the display updates and the Auxiliary Lamp is lit solid.

Off Hook Voice Announce

Off-Hook Voice Announce (OHVA) allows the user to receive a voice announcement from another extension while they are using the handset on their telephone. The user's speakerphone is used to provide a second conversation path. Using the interactive button under the display, an extension user may reject an OHVA if the user chooses to not be interrupted from their current call.

Related Features	Programming
LCD Interactive Button Intercom Calling Camp On Call Back	

Conditions

1. The Called Extension must be off hook, on the handset, for OHVA to work.
2. When placing an OHVA call to an extension that is busy using the speakerphone, the display options will not include the "ohva" option.
3. If the extension user has the "Mute" function activated, the line will remain muted until the Off-Hook Voice Announce is complete.

On Hook Dialing (Hot Key Pad)

Feature  

On Hook Dialing allows the user to monitor the dialing of an outgoing call through the built-in speaker. The user may place an outgoing call without lifting the handset, allowing for hands-free operation.

Related Features	Programming
Automatic Line Selection Hot Key	

Conditions

1. It is not recommended to disable the Hot Key Pad when Auto Line Select (Prime Line Pickup) Feature **9** **5** is set to a CO Line or Line Group because it will make internal calling problematic.

One Touch Transfer

Extensions with a flexible button programmed as an extension can transfer a call by pressing the button and hanging up.

Related Features	Programming
Feature Button programming Feature #3	Feature Button Allow 1-EN-13

Conditions

1. Extension User may customize their telephones using Feature **#** **3**

Page

Feature **JKL** **5** **OPER** **0**

Extension users may initiate various one-way page announcements:

- All Paging - All paging zones internal and external.
- External Paging - Only external ancillary paging equipment.
- Internal Paging - Specific page groups
- Internal Paging - A system-wide internal page.

Related Features	Programming
Meet Me Page (F 5 9) Paging Allow F(# 9)	Extension - Group 1-EN-07





Conditions

1. Only one page will work at a time, if a second page is attempted, "PAGE BUSY" will be displayed.
2. Single Line Telephone may initiate a Page, and use the Meet Me Page feature, but they will not receive a page announcement.

Page (Allow / Deny)

Feature 

The Page Allow/Deny feature allows a user to enter a code to toggle between allowing or denying pages at their extension. Background music programmed to play from this extension is not affected. When in Page Deny mode, the telephone is still capable of initiating a page and use the "Meet Me" page feature. However, it will not be able to receive a page.



Related Features	Programming
Meet Me Page (F   Paging Allow F( 	Extension - Group 1-EN-07





Conditions

1. The Page Allow/Deny feature code may be stored on a feature button.
2. This does not affect Intercom Calls or Voice Announce Private.

Page (Meet Me)

Feature 

Meet me page allows the user to locate a person that is away from their desk or have no office location. Once paged, the party can answer the page, using any telephone in the system, by entering the "Meet Me" (Feature  ) code. Once the code is entered, the system creates a private intercom call and releases the page port.

Related Features	Programming
Meet Me Page (F   Paging Allow (F  	Extension - Group 1-EN-07

Conditions

1. A page may be answered at any telephone, by dialing Meet Me Page code, even if the page announcement is not heard over the telephone speaker.
2. The page may be a zone page or a system wide "all page".
3. The Meet Me Page code may be programmed on any available flexible button.

Pause / Pause Insertion

Feature  

The Pause/Pause Insertion feature places a deliberate delay in dialing when placing an outgoing CO Line call from a stored number. Pause is useful in allowing access to special services where a delay is required. When entering a pause it will appear as a “P” on the telephone display. A pause may be inserted in a number stored as an extension Speed Dial number or in a System (Common) Speed Dial bin. In addition, a pause should be inserted at the beginning of any External Call Forward feature.

Related Features	Programming
Automatic Busy Redial Last Number Redial Saved Number Redial Speed Dial (ABBR) Extension System	Call Handling - Pause Time 3-07 Resource - System Speed (ABBR) 4-12

Conditions



1. A pause occupies one digit position when stored in speed dial.

Phone Lock / Unlock

Feature  

The Phone Lock/Unlock feature allows a user to prevent ANY outgoing CO Line calls from their extension. The extension password is used to lock/unlock the telephone. This feature code is also used to program your private four-digit extension password.

The use of the feature (Phone Lock) will block all CO Line calls, including emergency calls such as "911". Therefore, it is not recommended that any telephone be locked.

Related Features	Programming
Extension Password (F  	Resource - User Password 4-09

Conditions

1. When an extension is locked it can only make intercom calls; answer and retrieve calls on hold are not affected.
2. If a user forgets their password it may be retrieved via the system database administration.
3. The programmed Attendant's Private Password is used to enter Attendant Administration.
4. If a CO Line or CO Line call is attempted from a locked telephone, error tone will be heard and the display will show "PHONE LOCKED".
5. The Phone Lock feature code may be programmed on a Flexible Feature Button.

Privacy

All calls in the system are considered Private. However, in some cases, it is desirable to allow other extensions to join in on an existing CO Line conversation. Therefore, each CO Line may select between privacy and Privacy Release (MBC 02-LN-16). Care should be taken when disabling Privacy because some automatic features, such as Last Number Redial, System and extension Speed Dial and Saved Number Redial to name a few, may accidentally dial over the existing conversation.

Related Features	Programming
CO Line Calling Monitor Intercom Calling Monitor COS Intrusion	Privacy Release 2-LN-16

Conditions

1. Monitor can be used to listen-in on existing conversations.
2. Intrusion can be used to Barge-in on existing conversations.
3. If Intrusion is set to "Y" another extension will be able to enter in an monitor another extension's conversation.

Private To

The Private To feature allows one or more CO Lines to be programmed for access by only one extension. Once programmed as a Private To, no other extensions will be able to access the CO Line for either inbound or outbound calls. However, once the call is answered, it may be transferred to another extension. Any extension with a flexible button programmed with that Line will show busy when it is in use, but access to the line will be denied. This restricted access includes calls on hold, incoming and outgoing calls.

Related Features	Programming
	CO Line - Private To 2-LN-08

Conditions

1. Incoming calls signaling on a private CO Line will only ring its associated extension regardless of whether the CO Line ring assignment is allowed in programming.
2. Private to programming will override CO Line - Answer Position and CO Line Receive Assignments.
3. CO Lines which are programmed as "Private To", will follow call forward modes as set by the "Private To" extension. If set to voice mail, the incoming call will go directly to the extension's mailbox. No call may be forwarded to more than one destination.

Pulse to Tone (DTMF) Conversion



The Pulse to Touch Tone (DTMF) conversion feature enables the system to use Dial Pulse rotary outgoing CO Lines and access special services which require DTMF tones. A limited number of applications may still only support Pulse dialing for outgoing calls, but after reaching an outside party the use of Touch Tone mode may be required.

Related Features	Programming
Speed Dial Extension System	CO Line Dialing

Conditions

1. The dialing conversion can only be from pulse mode to tone DTMF mode, not from DTMF back to pulse mode.
2. The Pulse-to-Tone code can be programmed in any speed dial bin.
3. When making a call on a CO Line with Pulse Rotary dialing, the digits following "*" will be sent in DTMF tone mode.

Recall

The Recall feature pertains to calls that are parked, on hold, or calls that have been transferred to another extension. Calls which go unanswered after a preset period of time are "recalled" to the extension which initiated the park, hold or transfer. Recall reduces the possibility that a call will go unattended.

Recall

5

Related Features	Programming
Call Forward Transfer Hold Park	Call Handling Recall time 3-13

Conditions

1. Recalling CO Lines will follow Call Forward destination settings.
2. Recalls are not directed to the programmed Alternate Attendant extension.
3. When a holding or transferred call begins to recall, the outside party will hear transfer ring-back tone.
4. During recall, the CO line returns to System Hold allowing any extension with normal CO Line receive privileges to retrieve the recalling line.

Reminder Tones

Reminder Tones are heard when accessing an intercom dial tone from an extension that has Call Forward or Do Not Disturb is enabled. This "stutter" dial tone is actually a rapid, recurring break in the intercom dial tone which reminds the user of the current extension availability status. If Call Forward or Do Not Disturb is activated, this reminder tone will be heard when the extension user places an intercom call.

Related Features	Programming
Call Forward Do Not Disturb	

Conditions

1. Once a digit is dialed the reminder tone is removed until the next time intercom dial tone is heard.

Ringling Level / Muted Ringing

Ringling Level

The ringing volume at each speakerphone may be adjusted to one of four volume levels.

Muted Ringing

Incoming CO Line and intercom calls ring at the lowest ring volume level when the extension is active. This muted condition applies only when the extension is busy.

Conditions

1. Ringing levels can be adjusted from the lowest level 1 to the highest level 4.
2. An audible tone representing the volume loudness selected is heard after each ring level is selected, when the maximum and minimum volume levels have been reached.
3. As ringing levels are adjusted the current setting is displayed on the LCD.

Ringling Line Priority

The Ringling Line Priority feature follows an established priority schedule when connecting incoming calls. This system wide parameter will automatically connect incoming calls based upon this priority when there are multiple incoming calls to an extension. The user may override priority answering by directly pressing the direct appearing CO Line line, CO Line group, feature button or by dialing an intercom number before going off-hook. The user may simply lift the handset to have the system assign the highest priority call to that extension.

Ringing Line Priority is: (Highest to Lowest)

- Callback - Extension
- Callback - CO Line Recalling
- CO Line call
- Transferred CO Line call
- Incoming CO Line call
- Incoming ICM call

Related Features	Programming
N/A	N/A

Conditions

1. This is not a programmable parameter

Relay Control

Feature ^{MNO}6 1 (X)

(x) = Relay 1 - 4

There are 4 relays on the Option Module which can be programmed to close when the code Feature ^{MNO}6 1 plus the relay 1 - 4 is dialed. For example, this closure can be used to open electronic door latches.

Related Features	Programming
	Opt Relay Function 4-28

Conditions

1. The option module must be installed.
2. A Flexible button may be programmed to activate a specific relay. When the relay is activated, the LED on the button will be lit solid.
3. Each Relay can be programmed as a Relay or a Sensor, but not both.

Save Dialed Number (SDN)

Feature **5** **1**

Saved Number Redial (SDN) is used to retain a telephone number, which was just dialed, to be used later. Once stored the number can be recalled by dialing the SDN feature code, regardless of what feature operations or numbers have been dialed at that extension since the number was saved. Only one number can be stored at a time.

Related Features	Programming

Conditions

1. Saved Dial Number can store a maximum of sixteen 16 digits.
2. If all CO Lines are busy when the redial is attempted, the display will show "ALL CO LINES BUSY".
3. The Save Dialed Number feature code may be stored on any Flexible Feature Button for one-button storing and dialing operation.

Single Line Telephone - Flash

Single Line Telephones and similar analog devices connected to analog ports of the system must use unsophisticated signaling to administer call-processing operations like transfer and hold. This fundamental call control is handled in the form of specific hook-switch operations. These are known as Hook-switch Flash or just Flash commands.

Whenever a system feature is to be invoked at a single line telephone, the user must operate the hook-switch in a fashion that is distinguishable from an on-hook hang up request. This becomes essential for proper handling of calls considering the single line telephone user may operate the hook-switch quickly – desiring to hang up and place a new call. Yet this fast operation of the hook-switch might be interpreted as a Hook-switch Flash operation.

Considering these factors the system provides for customizing of the hook-switch command monitoring in system software. The database configuration may be adjusted to ignore hook-switch operations that are considered too short to be any valid request and to limit the time allotted.

Related Features	Programming
N/A	Call Handling - SLT Hook Flash 3-16

Conditions

1. If the analog device/SLT does not have a Hook-Flash operation button, operation of the hook-switch must fall within the time periods "Start" and "End" in order to be processed as a valid hook-flash operation.
2. Hook-switch operations that are shorter than the "Start" time are ignored.
3. Hook-switch operations that are longer than the "End" time are considered to be On-Hook hang up commands.

Single Line Telephone - CO Line Flash

The Single Line Telephone - CO Line Flash command is necessary for a single line device to send a Flash command to the connected CO Line. Applications for this operation include PBX circuits and Centrex.

Related Features	Programming
Flash – CO Line Single Line Telephone – Flash	Call Handling CO Flash Time 3-05 SLT Flash Time 3-13 PBX Flash Time 3-04

Conditions

1. The successful operation of features for the host PBX is dependant upon proper operation of host system features. Refer to the information provided with the host equipment for more information.

Speakerphone

The Speakerphone allows users to place and receive calls 'hands-free'.

Related Features	Programming

Conditions

1. The speakerphone function is impacted by environmental conditions.
2. Operation of the speakerphone in high-noise areas may yield less than adequate results. If this is the case in the area where your telephone is located, the handset may be used to improve connection conditions.
3. To dial intercom numbers directly from an idle condition, the Hot Key setting must be enabled. Otherwise, the extension user must press a programmed Intercom Button or press the ON/OFF button prior to dialing the extension number.

Security Control

Feature **6** **2** (X)

(X) = Sensor 1 - 4

There are 4 sensors on the Option Module which can be programmed to set off an alarm indication. Once tripped, the alarm can be programmed to alert internal extension with a special ring as well as calling an external location. To deactivate the alarm - dial Feature **6** **2**, enter the password, plus the relay **1** - **4**. For example, this closure can be used to open electronic door latches.

Related Features	Programming
	Option Sensor Function 4-29

Conditions

1. The option module must be installed.
2. A Flexible button may be programmed to activate a specific relay. When the relay is activated, the LED on the button will be lit solid.
3. Each Relay can be programmed as a Relay or a Sensor, but not both.

Speed Dial (ABBR) – Extension /System

Feature 1

The Speed Dial feature allows users to store frequently dialed numbers. Each extension may store up to twenty (20) personal numbers 00 - 19 in the speed dial directory. Digital Telephones enter and store their speed dial number using Feature 1, to dial a stored number, press a CO Line and enter Feature 1, followed by the bin number 00 - 19. A short cut has been added to allow users to dial speed bins 00 - 11 quickly and easily. The user presses the Feature Button followed by one of the 12 flexible buttons (not Line buttons), which are preprogrammed with extension speed bins 00 - 11.

Single Line Telephones can also store up to 20 extension speed bins using the #1 feature code. To dial a speed bin a Single Line Telephone uses the *1 feature code.

The system may store eighty (80) numbers 20 - 99 for system-wide access. System Speed Dial numbers can be programmed by Attendant Administration (Feature #0) or customer database programming.

The system can be programmed to allow System Speed Dial Numbers to override Toll Restriction settings both CO Line and Extension Classes of Service.

Related Features	Programming
Attendant Administration Pause Class of Service – Extension Class of Service – CO Lines Pulse to DTMF Conversion Flash Toll Restriction Extension ABBR Number (F1)	Extension System ABBR Check 1-EN-14 Resource - System Speed dial (ABBR) 4-12

Status Message

Feature  

Digital Extension users may set a status message to alert intercom calls of the extension users current status. The user may select between 6 preprogrammed messages, or customize one each time it is used. Preprogrammed messages include:

TABLE 5.7 Preprogrammed Status Messages

Number	Message	Number	Message
1	Out for Lunch	5	Out of Office
2	Be Back Soon	6	On Vacation
3	Left for the Day	7	Empty - Customizable
4	In a Meeting		

Conditions

1. The Status message will work even if the extension is in DND
2. The called extension must be ringing to see the status message. If answered in hands-free mode, the status does not display.
3. When customizing number 7. Empty, use the standard keypad entry process.

TABLE 5.8 Key Pad Entry Procedure

Digits	Depression 1	Depression 3	Depression 2	Depression 4
1	Special Characters			
2	A	B	C	
3	D	E	F	
4	G	H	I	
5	J	K	L	
6	M	N	O	
7	P	Q	R	S
8	T	U	V	
9	W	X	Y	Z
*	enters numeric if press before, lower case if after			
#	Space or go to the next character			

System Reminder

The system may be set to alert all idle Digital Extensions at predetermined intervals during the day. Eight (8) intervals are available for predetermined operation. The System Reminder will use the external music source, if connected, or if "Music Source" is set to "Ton", an internal reminder tone will be played.

Associated Features	Associated Programming
Attendant Administration (F# 0)	Resource - System Reminder 4-06 Resource - Music Source 4-21

Conditions:

1. A System Reminder in progress is canceled at an extension when another function is invoked.
2. If no ancillary music source is connected to the system, and the Music Source (MBC 4-21) is set to "Ext", and the System Reminder time is reached, silence will be played.
3. Extensions monitoring Background Music channel MC1 will not recognize the System Reminder.
4. The music alarm will not play at an extension that is busy on a call (handset or speakerphone), or in Do Not Disturb (DND) mode.

Text Messages

The interactive LCD Display gives the user several options when calling a busy or unattended extension. For example, the user may press "cbck" to leave a generic call back message or press msg and select "PREPROG" and leave a preprogrammed text message. There are 6 preprogrammed messages:

TABLE 5.9 Preprogrammed Messages

Preprogrammed Messages
Have a good Day
Call Operator
Call Home
Call Back
Friend Visiting
Urgent
Empty - Customizable

Conditions

1. The called extension must be ringing to see the status message. If answered in hands-free mode, the status does not display.
2. When customizing number 7. Empty, use the standard keypad entry process.

TABLE 5.10 Key Pad Entry Procedure

Digits	Depression 1	Depression 3	Depression 2	Depression 4
1	Special Characters			
2	A	B	C	
3	D	E	F	
4	G	H	I	
5	J	K	L	
6	M	N	O	
7	P	Q	R	S
8	T	U	V	
9	W	X	Y	Z
*	enters numeric if press before, lower case if after			
#	Space or go to the next character			

Touch Tone On/Off

Feature **# 1**

Touch Tone On/Off can be used to customize a users' telephone tactile response of dial pad key operation. The factory setting is; Touch Tone "Off". While ON; operation of the dial pad button/keys will cause a subtle beep tone to be emitted from the telephone speaker as an assurance that this button operation was successful.

Related Features	Related Programming
All dialing from the keypad	N/A

Conditions: N/A

Transfer

Transfer is used to deliver calls at one extension to another extension while maintaining the privacy of the connection. This means that calls can be routed to system destinations (Extensions, Hunt Group, Voicemail Group, etc.) in such a way that the wrong party cannot easily intercept them.

There are two (2) types of transfer you may use: Screened (talk) Transfer and Unscreened Transfer.

Screened Transfer – means that before the transfer is completed, the call is announced to the destination extension. This transfer method provides the transferring party with the option to reroute the call being transferred if the selected destination is determined not appropriate.

Unscreened Transfer – simply delivers the call to the destination selected regardless of the destination readiness to accept the call.

Until the transfer is complete, the outside line is placed on Exclusive Hold and can only be retrieved by the transferring telephone or the receiving telephone.

Calls that are transferred are subject to a unique transfer recall time. Transferred calls that go unanswered at the destination will recall (ring) to the transferring party when this timer expires. There are two recall timers that affect transferred calls; Transfer Busy Recall Time and Transfer Idle Recall Time. Idle and Busy represent the status of an extension for unsu-

pervised transfer scenarios. (If the extension destination is busy the Transfer-Busy Timer is used. If the extension destination is idle the Transfer-Idle Timer is used.)

Related Features	Related Programming
Recall Transfer Beep Enable (F ^{PQRS} 7 ^{WXYZ} 9) Call Forward (F ²) Forced Intercom Tone Ring (F ^{PQRS} 9 ^{WXYZ} 8)	Call Handling - Recall 3-13

Conditions

1. Transferred CO Lines that recall are placed on system hold at the time the recall occurs.
2. When a transferred CO Line recalls, the line number and extension number where the call was transferred will be displayed.
3. The transferred connection party will hear ring-back tone while the call is transfer ringing.
4. CO Line calls and intercom calls may be transferred.
5. In screened transfer, if the destination extension answers the intercom call in Voice Announce Hands-free mode and does not go off hook, the transferred connection will transfer ring at that extension.
6. In screened transfers, if the destination extension answers the intercom call by lifting the handset, the transferred connection is connected to the destination extension immediately when the transfer operation is complete.

Transfer Beep

Feature ^{PQRS}7^{WXYZ}9

When a call is transferred an audible tone is heard. Dial Feature 79 to disable this tone.

Related Features	Related Programming
N/A	N/A

Conditions

N/A





Voice Announce / Hands-free Reply

Feature  



The telephone provides the ability to receive incoming intercom calls three different ways, Voice Announce – Hands-free and Ringing are programmable. An optional method requires the user to press the mute button when in a private conversation. This will allow an extension user to call the party and make announcements, but the private conversation cannot be heard by the calling party because the mute button remains active.



The user can select between these modes as their needs change.

- Voice Announce – Hands Free Mode: Hands free, gives the extension user the ability to receive incoming intercom calls, without having to press any buttons. The user receives a tone burst; the user and the intercom caller are instantly connected, and can converse freely.
- Tone Ring mode – All calls to this extension will ring. The user must press either the speaker button or the lift the handset.
- Voice Announce Private – Once the mute button is activated the next call will be considered private so the calling party cannot hear the private conversation. The mute button must be reactivated after each call.

Related Features	Programming
Call Forward (F  Voice Announce (F   Flexible Button Programming (F #  Forced Intercom Tone Ring (	Extension Page 1-EN-15

Conditions

1. Extensions programmed for Hands-free (Voice Call Allowed) are automatically answered so calls will not automatically forwarded.
2. Extensions in Ring or Page Mode with Voice Call Allowed, can still receive Voice Calls if the calling Extension presses the "  " key while the extension is ringing.
3. Extensions in Ring or Page Mode with Voice Announce Denied Cannot receive Voice Announce calls.
4. During Tone Ringing, the LED associated to the  button will flash.

5. If a Flexible Feature Button has been programmed with the Intercom Mode Selection Code Feature   the LED associated to that button will indicate the current mode selection as follows:

Voice Call - Hands Free
Tone Ringing Mode

LED will light steady
LED will Flash



Voice Call Recorder (One Touch Record)

Feature  

The Voice Call Recorder (Once Touch Record) function requires the digitally integrated Voice Mail system. This feature allows users to record external (CO Line) conversations. When the Voice Recorder is activated, a connection is established between the extension and the Voice Mail system. The conversation is recorded in the extension's voice mailbox and stored in the "Clip Board" area.

Note:

Requires the integrated Voice Mail System

Related Features	Related Programming
Recorder Button (One Touch Record) - (F  )	Control Automatic Record Member 6-3-2

Conditions

1. The feature may programmed on a Flexible Feature button.
2. If a Flexible Feature Button is used for this feature... During recorder setup the associated LED (lamp) for that button will light steady. When the recording begins the lamp will change color but it will remain lit solid.
3. Extensions programmed into the Automatic Record Group, will not begin recording until Call Duration Timer has expired.
4. Placing a call on hold constitutes completing a call and ends the recording function. Therefore, the feature code saving the recording must be dialed before placing the call on hold.

Voice Processing Digital (Integration)

The system may be equipped with the optional Voice Processing system. This voice processing solution is fully integrated with the system. Performance of the digitally integrated Voice Mail is notably superior to that of a regular analog integration.

The digital integration Voice Mail system also eases installation effort by automating setup of the three primary functions users wish to deploy in a voice processing system; Voice Messaging, Automated Attendant, and Menu Routing. Just install the Voice Mail and when the power is turned back on, the system configures itself for the addition of the detected Voice Processing system.

To transfer a caller to the Auto Attendant Main Greeting dial *Transfer*,  , *Transfer*

Some of the capabilities that the Voice Mail adds are:

- Automated Attendant supported
- Extension unique voice mailboxes
- Call Forward to extension voice mailboxes
- All Call Handling conditions supported
- Answering Machine Emulation supported
- Menu Routing supported
- Voice Record supported
- Automatic Voice Record supported

Related Features	Related Programming
CO Line Ringing Modes Voice Call Recorder Auto Record Messaging – Voice Call Forward Automated Attendant (part of the voice mail system)	Extension - Record Allow 1-EN-16 Extension - Ring Assignment 1-EN-06 CO Line - Hunt Group Answer 2-LN-03

Conditions

1. Calls that are forwarded or transferred to voice mail, if no mailbox number is entered (In-Band) the call will be routed to the voice mail main greeting (e.g., Auto Attendant greeting.)
2. If no voice mail channels are available at the time a call is placed the call into voice mail will hear ring-back tone until a port is available.
3. Heavy voice channel use can impact message indication updates.
4. When VM messages are waiting, the Auxiliary Lamp will flash.
5. The voice mail code (Feature **6** **4**) can be programmed on any available Flexible Feature Button.
6. When the voice mail code is programmed on a Feature Button, the associated LED will flash when VM messages are waiting.
7. When a call is forwarded to a voice mailbox, the Feature Button will flash green, indicating that the call may be monitored, similar to an answer machine, and if desired, the call may be answered.

Volume Control

The digital speakerphone is equipped with a volume control that is used to adjust the various volume settings of the telephone. The following functions can be adjusted:

- Background Music
- Paging
- Headset Mode
- Speakerphone
- Handset
- Ringer volume

Adjustment for each function is made while that function is in use. The digital phone remembers the volume level selected for each function the next time that function is used. The Ringer volume adjustments allow for 4 (four) volume levels.

Whenever the various mode is active, press the Volume UP or DOWN Keys as necessary. The volume for this mode/function is now set.

Related Features	Associated Programming
N/A	N/A

Conditions

1. Users may adjust the ringing volume while the Digital Speakerphone is not in use or while it is ringing.
2. When adjusting the ring volume, the display will temporarily show the current setting.
3. When attempting to adjust the ringing volume beyond the highest or lowest setting, a single ring burst is heard to indicate that further adjustment is not possible.
4. Volume settings do not affect the transmit volume, only the receive volume.
5. Any conversation with an outside party will not be able to detect volume is increases or decreases.

Warning Tone / CO Line Call Limiter

Using the *Warning Tone (1-EN-08, Incoming Drop (1-EN-09)* and/or the *Outgoing Drop (1-EN-10)* call timer, the length of both inbound and outbound calls can be limited to the length of the *Warning Time (3-12)*. Once the timer is reached the caller will receive a tone 20 seconds prior to being disconnected. This feature is useful in a lobby or retail environment where lengthy calls are to be discouraged.

Related Features	Related Programming
CO Line Speed Dial Last Number Redial Auto Redial Saved Number Redial	Extension: Warning Tone 1-EN-08 Drop Call In 1-EN-09 Drop Call Out 1-EN-10 Call Handling: Warning Time Outgoing Call 3-12-1 Warning Time Incoming Call 3-12-2

Conditions

1. This feature is not recommended as a "Toll Saver" option and should be used only for specific applications.
2. Additional calls can be made at the extension following the expiration of the *Warning Tone/Drop Call operation*.

6.0 Database Programming

Database Administration

Database programming can be done from any digital display telephone. Once in programming, there are two methods of navigation. The first, and most common, is the Basic Programming Navigation which allows the programmer to scroll through each menu and then select the programming parameter to be modified. This is a comprehensive way to ensure that every parameter is verified while stepping through the database. The second method eliminates the need to step through every menu parameter by entering a Menu Bypass Code (MBC).

The Menu Bypass Code (MBC) allows the programmer to enter a code to go directly to a programming item. This is a quicker and more efficient way to program; once the programmer is familiar with general Programming, it is likely that the MBC will be used when programming a system.

A MBC is created or built using the menu numbers 01 ~ 06, followed by the number of times the "Next" button would be pressed while in a programming Menu. For example, to program the time and date the MBC is 4-07 (the system automatically places the "-". A complete list of Menu Bypass Codes are included at the end of this manual in Appendix "A".

TABLE 6.0.1 Menu Bypass Code Number and Description

Number	Description
01	Extension
02	CO Line
03	Call Handling
04	Resource
05	Restriction
06	Control

Each category has already been assigned a default value in the system. Each programming item following these instructions will tell you the default value for that program item as well as the available ranges for the item. The default items should allow you the basic system operation as they are, however, some changes may be required by the customer.

Programming Navigation:



Primary Navigation Keys

Interactive Soft Keys 1, 2 and 3 - These three buttons are the Primary Navigation Keys. Their functions change depending on the programming mode.

Volume Up/Down Keys - Are used to access the Menu Bypass Codes (MBC).

Hold Key - Used to back up one level from your current programming position.

Speaker Button - Used to exit programming.

Programming Mode

To enter programming mode:

Press the [Feature] **#** *****

Default Password is: **0** **0** **0** **0** **0** **0**



Press F2 - The middle Soft button which should now be labeled show



The initial display, which appears to be blank is the **Menu Bypass Code (MBC)** Entry screen.



This screen allows the programmer to enter a MBC and then Press `show` and jump directly to the programming parameter. For example to set the System Time and Date enter 415, the display will show 4-15, and then press `show`.

If the actual MBC Code is not know, just enter something close, like 410, and press next until the desired parameter is found.



Press the
Volume Up or
Volume Down
To reenter the
MBC Input Screen

A full list of MBC Codes can be found in the back of the manual.

6.1 Extension Programming

This chapter defines each of the Extension programming items, and lists the factory setting and other possible settings that can be selected. Once in the Extension programming category, select F2 *show*. Enter the Extension directory number you would like to program.

The MBC for Extension will begin with 1-EN-xx, where "SN" equals a valid extension number.

The following is a list of all the Extension directory numbers available

Digital Extensions

TABLE 1.1 Valid Digital Extension Numbers

	1	2	3	4	5	6	7	8
KSU (01)	10	11	12	13	14	15	16	17
Exp 1 (02)	18	19	20	21	22	23	24	25
Exp 2 (03)	26	27	28	29	30	31	32	33

Analog Extensions

TABLE 1.2 Valid Analog Extension Numbers

Module	SLT1	SLT2
KSU	34	35
Option	36*	37*
* Door Phone or SLT		

Day Class

MBC - 1-EN-01

This Class Of Service setting associates the selected extension to specific dialing rule set up in Toll Restriction for the system Service Mode "DAY".

Data Range: 0—7

Factory Setting: 5

Press **chg** to select to scroll through the classes of service 0~7.

Night Class

MBC - 1-EN-02

This Class Of Service setting associates the selected extension to specific dialing rules set up in Toll Restriction for the system Service Mode "NIGHT".

Data Range: 0—7

Factory Setting: 5

Press **chg** to select to scroll through the night classes of service 0~7.

Monitor COS

MBC - 1-EN-03

Defines if a station can monitor other extensions and which stations can monitored. Monitoring is based on a privilege level where:

0 = Most Privileged

9 = Least Privileged.

To monitor another extension the privilege class must be set at a higher level (lower number). Example—An extension with a Monitor Class of "0—Most Privileged" can monitor all extensions on the system with a Monitor Class of 1 or higher. An extension with a Monitor Class of "9—Least Privileged" cannot monitor any other extension. Stations with the same Monitor Class cannot monitor each other.

Data Range: 0—9

Factory Setting: 5

Note:

The manufacturer assumes no liability for inappropriate or possibly illegal use of this feature. It is the users responsibility to use this feature in accordance with local laws and regulations.

Press **chg** to select to scroll through the night classes of service 0~7.

Line Assignment

MBC - 1-EN-04

CO Line (CO Lines) are assigned to each extension for access when making outbound calls. CO Lines not assigned to an extension cannot be accessed by that extension.

Data Range: Y—N (By CO Line)

Factory Setting: Y

Press **Show** to enter programming area. Press **chg** to select "Y" to allow or "N" to deny the entered extension from accessing the entered CO Line when making an outside call. Press **next** to select the next CO Line.

Receive Assignment

MBC - 1-EN-05

CO Lines are assigned to each extension for access when receiving inbound calls. CO Lines not assigned to an extension cannot be accessed by that extension.

Data Range: Y—N (By CO Line)

Factory Setting: Y

Press **Show** to enter programming area. Press **chg** to select "Y" to allow or "N" to deny the entered extension from accessing the selected CO Line when receiving an outside call. Press **next** to select the next CO line.

Ring Assignment

MBC - 1-EN-06

Ring Assignment establishes CO Line ringing for Day and Night for the entered extension for incoming calls. Ring assignment is assigned by extension and by CO Line for both day and night modes.

Data Range: Y-N (By CO Line)

Factory Setting: Y

Press `show` to enter the programming area. Press `next` to scroll from Day Allowed to Night Allowed. Press `show` to select Day or Night mode. Press `chg` to select "Y" to allow or "N" to deny the selected CO Line from ringing at the entered extension.

Extension Group

MBC - 1-EN-07

Each extension is part of an extension group. Extensions within the group will receive group pages and have the ability to pick up an actively ringing call within the group.

Data Range: 1— 8

Factory Setting: 1

Press `chg` to scroll through the extension group assignments.

Warning Tone

MBC - 1-EN-08

If an extension has been restricted to call length by the Warning Time for either Incoming Drop or Outgoing Drop functions the Warning Tone function becomes active. This setting determines if the system will provide a Warning Tone when this extension has reached the maximum allowed call time. This is also based on the parameter: Warning Time - Outgoing/Incoming Calls.

Outgoing Drop - MBC 1-EN-09

Incoming Drop - MBC 1-EN-10

Warning Time - Outgoing - MBC 3-12-1

Warning Time - Incoming - MBC 3-12-2

Data Range: Y—N

Factory Setting: N

Press `chg` to select "Y" to allow or "N" to deny the use of the warning tone.

Outgoing Drop

MBC - 1-EN-09

Outgoing Drop terminates an Outgoing call which has exceeded the Warning Time timer.

Warning Time - Outgoing - MBC 3-12-1

Warning Time - Incoming - MBC 3-12-2

Data Range: Y—N

Factory Setting: N

Press `chg` to select "Y" to allow or "N" to deny the use of outgoing drop feature.

Incoming Drop

MBC - 1-EN-10

Incoming Drop terminates an Incoming call which has exceeded the Warning Time timer.

Warning Time - Outgoing - MBC 3-12-1

Warning Time - Incoming - MBC 3-12-2

Data Range: Y—N

Factory Setting: N

Press `chg` to select "Y" to allow or "N" to deny the use of the incoming drop feature.

Location

MBC - 1-EN-11

This display only parameter shows the physical location of the entered extension. The location is displayed as C-SS (Cabinet, Slot), for example extension at default extension 10 is located at 1-01

Data Range: C=1—3, S= 1– 8

Factory Setting: N/A

Extension Position

MBC - 1-EN-12

An extension number can be exchanged (swapped) with another extension number. This will cause the system to “Systemically” relocate the extension, but not physically. Therefore, the punch down location does not change, but in the system, the extension number assumes the identity of the “Swapped” extension. For example, if extension to swap extension 10 for extension 23, enter 1-10-11 - Programming parameters for extension 10 - at this point, enter the new extension number 23, and 10 becomes 23 and 23 becomes 10.

Data Range: 10—37

Factory Setting: N/A

Press **chg** and enter the new extension number. It must be a valid extension number, which will “Swap” with the entered extension number. For example, if extension 10 is entered, (1-10-12) and extension 23 is entered as the new directory number then extension 10 becomes 23 and 23 becomes 10. Press **save** retain the entered information.

Feature Key Allow

MBC - 1-EN-13

Each extension can be allowed or denied the ability to use the Feature Key. If denied, the extension is unable to activate any features/functions that begin with the “Feature key”. This includes any function/features saved under a programmable button or pressing the Feature key.

Data Range: Y—N

Factory Setting: Y

Press **chg** to select "Y" to allow or "N" to deny the use of the Feature key.

System Abbr (Speed Bin) Check

MBC - 1-EN-14

When set to "YES" any System Abbr (Speed Bin) numbers dialed by the extension will be checked against the Extension's class of service. If the class of service does not allow the call, the call will be denied.

Data Range: Y—N

Factory Setting: Y

Press **chg** to select "Y" to allow or "N" to deny the use of the System ABBR Check.

ICM Mode

MBC - 1-EN-15

Select Ring, or Page mode for the entered extension. This parameter is used in conjunction with extension feature 98 (F98)— voice call deny. If the extension is set to "Voice Call Deny" and this is set to "Ring" the extension is forced to ring at all times.

Data Range: Ring, Page

Factory Setting: Page

Press **chg** to select either ring or page mode for the entered extension.

Record Allow

MBC - 1-EN-16

Record Allow determines if this extension will be able to activate the One Touch Record feature while on a call. (Optional Voice Mail system required.)

Data Range: Y—N

Factory Setting: Y

Press **chg** to select "Y" to allow or "N" to deny the Record Allow feature.

CFW Auxil Lamp

MBC - 1-EN-17

Telephone with an auxiliary lamp can be programmed to light when the extension is "Call Forwarded" to another destination. When set to "N" no, the auxiliary lamp will not illuminate when the extension is forwarded, otherwise, it will remain lit.

Data Range: Y—N

Factory Setting: Y

Press **chg** to select "Y" to allow or "N" to deny the CFW Auxil Lamp feature.

Default Settings

MBC - 1-EN-18

This will reset all of the programming parameters for the entered extension to the default settings.

Data Range: N/A

Factory Setting: N/A

Press **Set** to default the settings of the entered extension number.

Do Not Disturb (DND) Function Allow

MBC - 1-EN-19

An extension can be allowed or denied the ability to be placed into Do-Not-Disturb mode. If denied, the extension cannot be placed into DND mode.

Data Range: Y—N

Factory Setting: Y

Press **chg** to select "Y" to allow or "N" to deny the extension from using the Do-Not-Disturb feature.

BEEP 2 Allow

MBC - 1-EN-20

This feature determines whether the system will allow, the entered extension, the ability to activate External Call FWD. External Call Forward will route calls that are transferred to this extension to an outside telephone number. All calls will be subject to toll restriction.

Data Range: Y—N

Factory Setting: Y

Press `chg` to select "Y" to allow or "N" to deny the extension from using the Beep 2 Allow feature.

Pre-CFW

MBC - 1-EN-21

Predefined Call Forward (Extension) is used to set a "fixed" forward destination for the entered extension so that calls are routed to that destination when they go unanswered. This setting does not require any action by the user. This feature is normally set when using voice mail to forward extensions to the voice mail system. Manual Call Forward set at the station will override Predefined Call Forward.

Data Range: 10~37, 82~89

Factory Setting: NULL

Forward extensions to the internal Voice Mail group: 87

Press `chg` and enter the extension or hunt group number. Press `save` to enter.

Pre-CFW Timer

MBC - 1-EN-22

The Predefined Call Forward Timer is adjustable from 6 to 30 seconds. At default, the timer is set to 12 seconds.

Data Range: 6 ~ 30 seconds

Factory Setting: 12 seconds

Press `chg` to scroll through the timer.

ECF Allow

MBC - 1-EN-23

External Call Forward— allows calls transferred to an extension to be forwarded to a remote telephone number, such as a home or cellular telephone. It is important to note, that only transferred calls will be forwarded and a CO line must be available, or the call will not forward. The user sets and updates this number when “Ext” forward is activated. This option either allows or denies a telephone extension the ability to use External Call Forward. All telephone numbers enter, will be checked by any Toll Restriction before allowing the call.

Data Range: Y—N

Factory Setting: N

Press **chg** to select “Y” to allow or “N” to deny the extension from using External Call Forward.

IVR Prompt

MBC - 1-EN-24

Users may select to play a pre-prompt when calls are forwarded to their voice mailbox. When set to “Y” (yes) the prompt “that extension does not answer, to leave a message Press 2; you may also dial another extension now or press 0 for the attendant. After this prompt plays, the extension users personal greeting will play. When set to no, only the extension users personal greeting will play.

Data Range: Y—N

Factory Setting: Y

Press **chg** to select “Y” to play the pre-prompt or “N” to eliminate the pre-prompt.

Forced LCR

MBC - 1-EN-25

Each extension can be forced to use LCR when dialing an outside telephone number. When set to "Y" yes, all telephone numbers dialed will be verified using LCR. When set to "N" no, the numbers are not verified before being presented to the CO facilities.

Data Range: Y—N

Factory Setting: N

Press `chs` to select "Y" to allow or "N" to deny the extension from being forced to use LCR when dialing an outside telephone number.

Notes:

Notes:

6.1

6.2 CO Line

This chapter defines each of the parameters of the Central Office Line data category, and lists the factory setting and other possible settings that can be selected During Display Menu programming scroll through the menu options until you are at program "CO Line".

Note:

To ensure that all CO Line features work correctly any CO Line that is not connected to a live telephone copy line should be identified as "EMPTY".

To enter the CO Line Programming area press the "Show" key.

Enter a valid CO Line Number. Valid CO Line numbers are 01 through 09.

Day Class

MBC - 2-LN-01

This Class Of Service associates the selected CO Line to specific dialing rules set up in Toll Restriction for the system Service Mode "DAY".

Data Range: 0—7

Factory Setting: 0

Press `chg` to select.

Night Class

MBC - 2-LN-02

This Class Of Service associates the selected CO Line to specific dialing rules set up in Toll Restriction for the system Service Mode "Night".

Data Range: 0—7

Factory Setting: 0

Press **chg** to select.

Hunt Group Answer

MBC - 2-LN-03

CO Line can be programmed to ring directly into the desired Hunt Group. Once entered, this parameter will override all other ringing assignments. Select between 1 and 7 representing Hunt Groups 82 – 89. 0 disables the ringing.

Data Range: 0 –7

Factory Setting: 0

For Integrated Voice Mail—Set to Group 6 (87)

Press **chg** to select.

Dialing [Type]

MBC - 2-LN-04

This is the dialing mode for CO Lines. It can be Tone (DTMF) or Pulse (Rotary). Data Range: Tone, Pulse

Factory Setting: Tone

Press **chg** to select.

Line Type

MBC - 2-LN-05

To ensure that all CO Line features work correctly any CO Line that is not connected to a live telephone company lines should be identified as "EMPTY".

CO Line Type: Select from the following: CO, PBX, EMPTY, PAGE, HOTLN.

- **CO** is a standard CO Line (CO).
- **PBX** identifies the CO Line as a station line from a host PBX; special automatic dialing rules are then applied.
- **HOTLN** Hotline; Marks this CO Line port as being connected to an outside CO service (e.g. Hotlines). DTMF signaling is supported and two-way communications are established for this port when accessed. This CO Line Type is identified as not accessible to automatic access features such as Last Number Redial or dial 9 access.
- **PAGE** marks this CO Line port as being connected to ancillary devices (like paging equipment). DTMF signaling is supported and two-way communications are established for this port when accessed. This CO Line Type is identified as not accessible to automatic access features such as Last Number Redial or dial 9 access.
- **EMPTY** identifies a CO Line position that is equipped but not used. (Vacant port.) This is a quick way to mark it to be skipped for automatic access features.

Data Range: CO, PBX, Hotln, Page and Empty

Factory Setting: CO

Press **chg** to select.

Loud Bell

MBC - 2-LN-06

When a CO Line is programmed to loud bell "Y" the system closes a relay that can activate an ancillary loud bell unit or activate an ancillary strobe light.

Data Range: Y—N

Factory Setting: N

Press **chg** to select.

Line Group (CO Line Groups)

MBC - 2-LN-07

The CO Line being programmed may be assigned in one of 8 CO Line Groups. This association of CO Line circuits is used to group lines of similar type and function.

Data Range: 1—8

Factory Setting: 1

Press **chg** to select.

Private To

MBC - 2-LN-08

Use this setting to identify a CO Line as a private CO Line which will be assigned at a specific extension. A CO Line assigned as "Private to" will not follow the extension forwarding, nor can it be accessed using group or direct ringing line pickup.

Data Range: 10—37, Null

Factory Setting: Null

Press **chg** and Input the extension directory number to which this CO Line will be private to. Press **save** to select.

Distinct Tone (Distinctive Ring)

MBC - 2-LN-09

There are four Ring Types (1~4) that can be assigned to a CO Line to provide an audible indication of ringing for this specific CO Line. The data range is 0~4. "0" is used to set no specific Ring Type for this CO Line. This means that the Ring Type selected at the extension will be followed. If a Ring Type is selected here for the CO Line - the CO Line Ring Type supersedes the Extension

Ring Type.

Data Range: 0—4

Factory Setting: 0

Press **chg** to select.

Fax XFR To

MBC - 2-LN-10

CO Lines can be programmed to detect the CNG Fax Tone, which is transmitted by Fax machines, and automatically transfer that call to one of the four Single Line Telephone ports 34, 35, 36 and 37. When there is an incoming call, the system will automatically “answer” the call, after 5 seconds, which gives the calling party one full ring back tone from the Central Office. Once off hook, the system will listen for the CNG tone for 4.5 seconds. Once CNG tone is detected, the call is transferred to the programmed SLT port. If there is no CNG tone detected, the call will follow the ring assignment for this line. The Ringing priorities are “Hunt Group Answer (2-LN-03) if nothing is defined, all extensions will ring. If the CO line goes unanswered, it will follow the Predefined Call Forward (2-LN-03-01) parameter. If the CO line goes unanswered after it is diverted to the predefined call forward destination, it will ring for 25 seconds and then drop.

Note:

This feature cannot be used with CO Line voice mail products because the system actually answers the call to listen for the CNG Tone.

Data Range: 10—37, Null

Factory Setting: Null

Press **chg** and enter the extension directory number where the FAX machine is installed. Press **save**.

Gain (RX)

MBC - 2-LN-11

The system is DSP processor based and has the ability to adjust audio levels for all CO Line connections. Use Gain (Rx) to adjust the receive audio level of internal extensions on CO Lines.

Data Range: -00 dB— -12 dB

Factory Setting: -03 dB

Press **chg** to select.

Gain (TX)

MBC - 2-LN-12

The system is DSP processor based and has the ability to adjust audio levels for all CO Line connections. Use Gain (Rx) to adjust the transmit audio level of internal extensions on CO Lines.

Data Range: -00 dB — -12 dB

Factory Setting: -03 dB

Press **chg** to select.

DTMF Disable

MBC - 2-LN-13

Not used at this time — Do not change from Default Setting (00)

CID Mode

MBC - 2-LN-14

Caller ID signals from the CO can be received in two transfer methods; DTMF or FSK. The system can detect both but must be set for the method used by the CO to which it is connected.

Data Range: FSK—DTMF

Factory Setting: FSK

Press **chg** to select.

Pre-CFW

2-LN-15-1 Day

2-LN-15-2 - Night

2-LN-15-3 - Timer

Predefined Call Forward (CO Line) is used to set a “fixed” forward destination for a CO Lines that go unanswered and will be routed to a specific destination. This is often called Delay

Answer. Generally, this feature is used to forward CO Lines to the voice mail system for Automated Attendant use.

Data Range: 10~37, 82~89

Factory Setting: NULL

To Set to Internal Voice Mail: 87

Press `chg` and enter the extension or hunt group number. Press `save`.

Privacy Rls

2-LN-16

Privacy Release allows a user to join an existing conversations. When a CO Line is set to Privacy Release—"Yes", an additional extension may press a CO Line that is in use at another extension and will join the ongoing conversation (Conference).

Data Range: Y—N

Factory Setting: N

Press `chg` to select. Press `chg` to select.

Notes:

Notes:

6.2

6.3 Call Handling

This chapter defines each of the parameters of the Call Handling programming parameters, and lists the factory setting and other possible settings that can be selected During Display Menu programming scroll through the menu options until you are at program "Call Handling". To enter the Call Handling Programming area press the "show" key.

Intrusion

MBC - 3-01

All conversations are considered private. However, on occasion it maybe necessary to listen to, or join in on an existing conversation. When set to "Y" an extension with a higher Class of Service (COS) will have the ability to "Intrude" on the conversation. COS 0 is the highest and 9 the lowest, Extension with equal COS's are blocked from intrusion. (See Extension Monitor COS - 1-ext-03 - in Extension Programming)

Data Range: Y—N

Factory Setting: Y

Press `chg` to select.

Intrusion Tone

MBC - 3-02

When set to "Y" (Yes) an Intrusion Tone is played whenever an extension intrudes on another extensions conversation. When set to "N" (no) no tone will be played. Be sure to verify all laws regulating this feature before it is disabled.

Data Range: Y—N

Factory Setting: Y

Press `chg` to select.

Exclusive Hold Time

MBC - 3-03

Calls placed on Exclusive Hold will recall (ring) to the extension that placed them on hold when this timer expires. Selecting "0" disables the operation of this feature.

Data Range: 0—8

Factory Setting: 1

Press **chg** to select.

PBX Flash

MBC - 3-04

When a Hook-switch Flash is invoked by a user on a CO Line marked as CO Line Type "PBX". The hook switch flash duration ranges from 0.1~3.0 seconds (100ms~3000ms).

Data Range: 0.1—3.0 Seconds

Factory Setting: 0.3

Press **chg** to select.

CO Flash

MBC - 3-05

This timer is used when an extension drops an outside CO Line call allowing it to dial out on another CO Line or dial an internal extension or feature. The CO Flash timer ranges from 0.1 ~ 3.0 seconds (100ms~3000ms).

Data Range: 0.1—3.0 Seconds

Factory Setting: 0.7

Press **chg** to select.

Remind Time

MBC - 3-06

When a call is placed on hold, a reminder tone will be heard at the originating extension each time this timer expires Note: Setting this parameter to zero (0) will disable the feature

Data Range: 0—90 Seconds

Factory Setting: 60

Press `chg` to select.

Pause Time

MBC - 3-07

The Pause time is used with special dialing features such as ABBR (Speed Dial) bins. To input a "Pause" in a dial string enter F70.

Data Range: 0—90 Seconds

Factory Setting: 1.5 Seconds

Press `chg` to select.

PBX Code

MBC - 3-08

Select between a single or double digit entry to access a PBX CO Line.

Data Range: 0—99

Factory Setting: 9

Press `chg` to select.

PBX Auto Pause

MBC - 3-09

When a PBX Line port is connected to a CO Line port, specific digit(s) (e.g. "9") are required to access a PBX CO Line. The system will automatically insert a pause between these digits when redial features are invoked. This timer determines how long (duration) the pause will be.

Data Range: 1—9 seconds

Factory Setting: 2 Seconds

Press `chg` to select.

Tone Time

MBC - 3-10

The Tone time is the length of time that the system will transmit a "DTMF" tone when a CO Line is accessed.

Data Range: 70—120 milliseconds

Factory Setting: 70 milliseconds

Press `chg` to select.

Voice Mail Dialing Ratio (Feature No Longer Used)

MBC - 3-11-1 Tone Time

MBC - 3-11-2 Int_Dgt Time

Two sub fields exist for the Voice Mail Dialing Ratio parameter:

- **Tone Time:** This timer is relevant only for analog interface voice processing systems connected to the system analog ports. The Tone Time is the minimum duration of DTMF tone delivered to the Voice Mail analog port for voice processor - call processing.
- **Int_Dgt Time (Interdigit Timer):** This timer is relevant only for analog interface voice processing systems connected to the system analog ports. The Int_Dgt Time is the minimum duration of time between DTMF tones delivered to the Voice Mail analog port for voice processor – call processing.

Tone Time

Data Range: 60, 90, 120, 150 milliseconds

Factory Setting: 90 milliseconds

Int_Dgt Time (Interdigit Timer)

Data Range: 60, 90, 120, 150 milliseconds

Factory Setting: 90 milliseconds

Press `show` to get to sub fields

Press `chg` to select.

Press `next` to advance or `back` to return to the previous subfield.

Warning Time

MBC - 3-12-1 Outgoing

MBC - 3-12-2 Incoming

These Parameters are directly associated with the Drop Call – Out/In and Warning Tone parameters in Extension programming. A Warning Timer is provided for the two call conditions:

- Outgoing call (1-ext-09)
- Incoming call (1-ext-10)

These timers govern the how long an extension programmed for either of these features may be connected on an Outgoing/Incoming CO call before hearing the Warning Tone. An extension can also be disconnected in association with the Drop Call function.

Outgoing

Data Range: 01—10, 15, 20, 25, 30

Factory Setting: 05

Incoming

Data Range: 01—10, 15, 20, 25, 30

Factory Setting: 05

Press `show` to get to sub fields

Press `chg` to select.

Press `next` to advance or `back` to return to the previous subfield.

Recall Time

MBC - 3-13

The recall time is a system wide parameter that determines the amount of time that a call will remain on hold before recalling at the station that placed it on hold.

Data Range: 10, 16, 30, 60, 90, 120 seconds

Factory Setting: 30 seconds

Press `chg` to select.

Alternate Ring Time

MBC - 3-14

When an initially ringing CO Line is programmed to ring the alternate attendant, and the inbound CO Line call goes unanswered, the call will automatically switch to "Active Alert Ring Status."

Data Range: 10, 20, 30, 40, 50, 60 seconds

Factory Setting: 30 seconds

Press `chg` to select.

Tone Sender

MBC - 3-15

The Tone sender analyzes all outgoing CO Line calls to ensure proper operation. Changing this parameter to "No" could result in improper operation; in the unlikely event of glare, the call status will be one-way only.

Data Range: Y—N

Factory Setting: Y

Press `chg` to select.

Single Line Telephone –Hook-Switch Flash

MBC - 3-16

This is a compensation timer that allows the programmer to adjust signaling characteristics of SLT telephones so that they are properly interpreted by the system. Programming provides a timer with a start and end time.

- Hook-switch operations shorter than the start time will be ignored
- Hook-Switch operations longer than the start time but shorter than the end time will be interpreted as a Hook-switch Flash
- Hook-Switch operations longer than the end time will be interpreted as a disconnect.

Start Time

Data Range: 60—1400 milliseconds

Factory Setting: 200 milliseconds

End Time

Data Range: 100—1500 milliseconds

Factory Setting: 1500 milliseconds

Press `show` to get to sub fields

Press `chg` to select.

Press `next` to advance or `back` to return to the previous subfield.

Operator Code

MBC - 3-17

The Operator code is definable between 0 and 9 and represents the 1 digit telephone number for the Operator. By default the operator code is "0".

Data Range: 0, 9

Factory Setting: 0

Press **chg** to select.

SMDR Time

MBC - 3-18

This timer determines the number of seconds between the last digit dialed and the start of the "Talk Time" timer which is reported in SMDR. If this time is not reached before the call is terminated, the call will not be reported in SMDR.

Data Range: 01—25 seconds

Factory Setting: 10 seconds

Press **chg** to select.

SMDR Output

MBC - 3-19

This programming parameter is used to select which call types (Incoming Calls and/or Outgoing Calls) will generate an output to the SMDR port. Includes two subfields.

Outgoing Call:

Data Range: Y/N

Factory Setting: Y

Incoming Call:

Data Range: Y/N

Factory Setting: N

Press `show` to get to sub fields

Press `chg` to select.

Press `next` to advance or `back` to return to the previous subfield.

Hunt Method

MBC - 3-20

There are three different hunt methods: SEQL, RAN, SEQF, which are used to determine how a CO Line is accessed when using features such as redial, and ABBR (Speed dial) call.

- SEQL – Selects the last line in the system first.
- RAN – Selects the next available CO Line line in the system.
- SEQF – Selects the first available CO Line line in the system.

Data Range: SEQL, RAN, SEQF

Factory Setting: SEQL

Press `chg` to select.

BB Call Pause

MBC - 3-21

BB Call Pause is the timer used to allocate how much time elapses between the time a Pager (Beeper) number is dialed and when the digits to be displayed are sent.

Data Range: 0—9

Factory Setting: 0

Press `chg` to select.

VM MON TIME

MBC - 3-22

Voice Mail Monitor Time is used to adjust how long the user has to invoke the monitor function when a caller is leaving a message in that user's voice mailbox.

Data Range: 0—60 Seconds

Factory Setting: 20

Press **chg** to select.

Voice Mail Reserve Port

MBC - 3-23

A single Voice Mail port may be allocated as reserved for voice processor system functions. (Lighting and extinguishing message waiting lamps.) Default setting of 0 disables this feature. This feature is for external voice mail systems only

Data Range: 0—48

Factory Setting: 0

Press **chg** to select.

DTMF Tone

MBC - 3-24

This parameter when set to "Y" (Yes) transmits (so the dialer can hear) the numbers being dialed on outgoing CO Line calls. When set to "No" the user will not hear the digits dialed.

Data Range: Y/N

Factory Setting: Y

Press **chg** to select.

Wait CID_T (CID Feature)

MBC - 3-25

This parameter delays the extension from ringing until this timer expires. Once expired, the first Audible ring and the incoming Caller ID is presented to the extension simultaneously

Note:

This feature should not be changed unless directed to do so by a trained technical support representative.

Data Range: 0—8 seconds

Factory Setting: 0.5 seconds

Press **chg** to select.

International Prefix (CID Feature)

MBC - 3-26

This parameter is a Caller ID feature that affects calls placed using the CID data received. To dial back a number that originated outside of the country where the system is installed an international prefix must be dialed. The International Prefix must be programmed here so that the system can dial this prefix automatically when a user uses CID callback operation.

Data Range: 4 digits maximum, 0 to 9, Null

Factory Setting: Null

Press **chg** to select.

Country Code (CID Feature)

MBC - 3-27

This parameter is a Caller ID feature that is programmed with the country code where the system is installed (In the USA the code is "01".)

Data Range: 4 digits maximum, 0 to 9, Null

Factory Setting: Null

Press **chg** to select.

Long Distance Prefix (CID Feature)

MBC - 3-28

This parameter is a Caller ID feature that is programmed with the code required at the installed location to make long distance calls (In the United States the entry will be 1). When CID calls from a location that are long distance are dialed back, the prefix programmed here is pre-inserted before the collected digits are dialed.

Data Range: 3 digits maximum, 0 to 9, Null

Factory Setting: 1

Press `chg` to select.

Local Area Code(s) (CID Feature)

MBC - 3-29

This Caller ID parameter must be programmed with any Area Code(s) that can be dialed without a "1" as the first digit. These Area Code(s) identify numbers that will not be dialed with the Long Distance Prefix.

- The local Area Code is programmed into Local Area Code "1".
- This identifies the number as a local number.
- This also causes the system to remove the Area Code from the digits received.
- If the local Area Code received must be dialed to place a CID Call Back, the local Area Code must be programmed into the Local Area Prefix "1" so that it is dialed.

Data Range: 5 digits maximum, 0 to 9, Null

Factory Setting: Null

Press `show` to get to sub fields

Press `chg` to select.

Press `next` to advance or `back` to return to the previous subfield.

SYS External Call Forward

MBC - 3-30

External Call Forward has three subfields

- **Active Line:** Selects the that will be used for External Call Forward
- **Service:** This system-wide programming parameter determines the Service Mode for which the External Calling feature will operate.
- **Talk Time:** This system-wide programming parameter determines how long a user engaged in an External Forwarded connection will be able to talk on the circuit before the call is disconnected.

Active Line

Data Range: 01—09, Null

Factory Setting: Null

Service

Data Range: Always, Never, Day, Night

Factory Setting: Always

Talk Time

Data Range: 01—99 minutes

Factory Setting: 05

Press `show` to get to sub fields

Press `chg` to select.

Press `next` to advance or `back` to return to the previous subfield.

Talk Abandon Timer

MBC - 3-31

For CO Line provider compliance; The talk abandon (CO Line Disconnect) timer gives the system the ability to match the CO Line providers' disconnect timer. The system requires a voltage reading of "Zero" 0 Vdc for the duration of this timer. Therefore, if a CO Line provider takes 200 milliseconds to go from off hook voltage, about 9 Vdc, to 0 Vdc then this timer must be set 200 milliseconds shorter than the CO Line providers timer. If this timer is set too short, the system may inadvertently disconnect an active call.

Data Range: 120 milliseconds — 1020 milliseconds

Factory Setting: 660 milliseconds

Press **chg** to select.

LCR Time

MBC - 3-32

The LCR Time is the time that elapses between when the last digit is dialed and when the LCR tables are referenced for establishing a CO Line call.

Data Range: 1—8 seconds

Factory Setting: 3 seconds

Press **chg** to select.

6.4 Resource

This chapter defines each of the parameters of the system Resource data category, and lists the factory setting and other possible settings that can be selected. During Display Menu programming scroll through the menu options until you are at program "Resource". To enter the Resource Programming area press the "show" key.

Ring Scheme

MBC - 4-01

Ring Scheme is used to customize the ring cadence of the system. This setting will affect CO Line and Intercom ring cadences.

Data Range: 0~9

Factory Setting: 3

Press **chg** to select.

Letter Type

MBC - 4-02

Letter type is used to customize the characters for the messaging and name in display features. Beyond the normal letters and numbers that may be used for display, there are specialized characters that can be used. This is used to accommodate special characters and language requirements. When programming characters to be displayed for text messages or names in the display, the dial pad key "1" is used to select the character desired. The Letter Type database parameter is used to select the scheme of special characters that will be used when the user inputs the data using the "1" key. Use the table for mapping of which characters are used in each scheme.

Character for n th depressions of dial key "1".						
	1 st	2 nd	3 rd	4 th	5 th	6 th
Scheme 0	Æ	Ē	ø	Ø	à	À
Scheme 1	Ç	Ā	ō	Ń	Á	Ä
Scheme 2	ò	é	é	è	à	ù
Scheme 3	č	ð	é	Ń	ō	ř
Scheme 4	Á	É	Ó	Ú	Ú	
Scheme 5	Ł	Ž	Ř	Ě		

Data Range: 0—5

Factory Setting: 0

Press `chg` to select.

Attendant

MBC - 4-03

The Attendant database parameter defines which extension will be assigned as the system's attendant. This designation allows this extension to be called by dialing 0 (zero) when dialing on the intercom.

Data Range: 10—37

Factory Setting: 10

Press `chg` to select.

Input the extension number that will serve as the system Attendant Extension.

Press `save`

Alternate

MBC - 4-04

The Alternate Attendant will receive CO Line Ringing Calls in an over-flow fashion from the Attendant Extension. Calls that ring longer than the ring Alternate Position Timer (3-14), will begin ringing at the Alternate Attendant Position as well as the Attendant Position.

Data Range: 10—37

Factory Setting: "Null" (None)

Press **chg** to select.

Input the extension number that will serve as the system Attendant extension.

Press **save**

Modem Number

MBC - 4-05

The system can be accessed remotely for system programming. This is done using a second system at the remote location. When programming changes are required, the remote system user accesses a CO Line and dials the system where programming changes are to be made {LOCAL}. When the call is answered, the LOCAL system user transfers the remote system caller to the built-in modem using this extension or Modem Number. That Modem Number is assigned here.

Data Range: 55 (Do Not Change from Default)

Factory Setting: 55

System Reminder

MBC - 4-06

The system has eight (8) system alarms that can be set to alert all digital station users on the system of preprogrammed event times. When the time is reached, all idle station users will hear one minute of background music (BGM). If no BGM is connected to the system extensions will hear the same tone used for holding callers. (Beep tone repeated — one second on/one second Off.) These alarms will function daily. Extensions listening to BGM will not be able to differentiate between the reminder alarm and the BGM already playing. Use 24 hour format when you input reminder times.

Data Range: 00:00 to 23:59

Factory Setting (1—8): Null

Press `show`

Use `next` and `back` to select the alarm (1~8) to change.

Press `chg`

Enter the time for this Alarm/Reminder in 24-hour format.

Press `save`

Notes:

Erase Alarm/Reminder times by pressing “`save`” immediately after “`chg`”.

Time Switching

MBC - 4-07

Time switching is used when the Service Setting is set to “Time”. When the system is in the “Time” mode, the system will automatically switch between Lunch Modes and Day/Night mode. This can be overridden only at the attendant extension using the feature code Feature 63 and entering the attendant extension password. Time Switching is programmed for each of the seven days, Monday through Sunday. All times must be entered in 24 hour format.

Data Range: 00:00—23:59

Factory Setting: All Days — Noon Start, Null — Noon End, Null — Night Start — 17:00, Night End — 08:00

Press `show`

Use `back` and `next` to select the Day to change.

Press `show`

The current programming of “Noon Start” is displayed.

Use `back` and `next` to select between time options

Press `change`

Input the time for this mode change in 24-hour format.

Press `save`

DB Password

MBC - 4-08

The system has a programmable 6-digit Programming Database password that can be changed from the default of six-zeros (000000), to another number between 000000 and 999999.

Data Range: 000000~999999

Factory Setting: 000000

Press `chg`

Input New Password

Press `save`

User Password

MBC - 4-09

Each user can have a unique 4-digit user password. Passwords are programmed at each extension. This programming parameter is used to view (only) the programmed password. This can be helpful when a user forgets his password.

Data Range 0000~9999

Factory Setting 0000 (except the attendant extension which is 9999)

Press `show`

Input the extension number for which the password is to be displayed. Press `show`. The password for that extension is displayed. Press `back` to enter another extension number for password display or press `next` to advance to the next database parameter.

User Name

MBC - 4-10

Using the Key Pad Entry Procedure, each extension can have the user's name programmed to appear in the display. Each name can be up to 6 digits in length. Characters from the chosen Letter type (MBC 4-02) can be inserted for specialized characters as required.

Data Range: Alpha-numeric entries up to six characters in length

Factory Setting: Empty

TABLE 6.4.1 Key Pad Entry Procedure

Digits	Depression 1	Depression 3	Depression 2	Depression 4
1	Special Characters (See Character Type MBC 4-02)			
2	A	B	C	
3	D	E	F	
4	G	H	I	
5	J	K	L	
6	M	N	O	
7	P	Q	R	S
8	T	U	V	
9	W	X	Y	Z
*	enters numeric if press before, lower case if after			
#	Space or go to the next character			

Press `show` Input the extension number to program the displayed user name.

Press `show` (Current Programming is displayed)





Press `chg`

Use the Dial Pad keys to input the name that will be displayed.

Press `save`

Press `Back` to enter another extension number for user name programming or press `next` to advance to the next database parameter.

Notes:

- Press the dial pad button for the letter until that letter appears.
- Any letter can be switched from upper case to lower case by pressing  AFTER the letter desired is displayed.
- Any numeral can be input by pressing  BEFORE the dial pad button is pressed.
- The  key MUST be pressed after each character/number input for display.
- The  key can also be used to insert a space character.
- After all characters are entered and  is input at the end character, `save` will then save all characters for display.
- Seven characters maximum can be programmed for User Name display.

Preprogrammed Message

MBC - 4-11

The system has two types of preprogrammed messages; **Outgoing** and **Status** (premises) notification.

- **Outgoing** (text messaging) works to communicate to an extension by sending a message that can be displayed. When a user that is making an intercom call to an extension that is busy or does not answer, they can send a text message to that extension that will be show on the telephone display.
- **Status** (premises) notification allows extensions to place a temporary message at their extension that will be displayed at extensions that call them. This is helpful in situations where an extension user may be away from their telephone or is not taking calls. Other extensions that call the extension with Status Notification enabled will see the Status message in their display, giving them immediate information about the extension user that they have called.

Data Range: Alpha-numeric entries up to sixteen characters in length

Outgoing Messages:

- 1. Have a Good Day
- 2. Call Operator
- 3. Call Home
- 4. Call Back
- 5. Friend Visiting
- 6. Urgent

NOTE:

A seventh message is available during setup at the extension, It cannot be programmed through system programming. The seventh is "Empty" and can be customized on-the-fly by the user.

Status (Premises) Messages:

- 1. Out for Lunch
- 2. Be Back Soon
- 3. Left for the Day
- 4. In a Meeting
- 5. Out of Office
- 6. On Vacation

NOTE:

A seventh message is available during setup at the extension, It cannot be programmed through system programming. The seventh is "Empty" and can be customized on-the-fly by the user.

Press `show`

Use the `back` and `next` buttons to select Outgoing Message or Premises Message.

Press `show`. [The message for the group selected is displayed]

Use the `back` and `next` buttons to select the message to be changed.

Press `chg`

Use the Dial Pad keys to input the message that will be displayed when the user selects this option.

Press `save`

Use the `Back` and `Next` to navigate through the various programmable messages and repeat programming instructions for each desired change.

System ABBR No

MBC - 4-12

The system has 80 (20~99) Abbreviated Dialing Numbers (system speed dial bins) that are available to all system users. Some extensions will not be able to use some speed dial bins based on their Class Of Service as defined in the system Toll Restriction programming. The extension Class Of Service governs the use of System Speed Dial as follows:

- COS 0~5 Can access all 80
- COS 6 Can only access 20~39
- COS 7 Cannot use ABBR dialing

Data Range: Any combination of digits and system commands up to 16 characters maximum per bin.

Factory Setting: All bins are Empty

Press `show`

Input the bin number to change (20~99), then press `show` [The current content is displayed.] Press `chg`

Input the new number to be stored in this bin, then press `save` [The contents are then displayed.]

Press `back` to return step 3 above or press `next` to advance to the next Resource programming parameter.

Notes:

Input all numbers that are to be dialed when this Abbreviated Number (Speed Dial) bin is accessed. * and # are valid numeral entries.

Sixteen characters maximum can be programmed into any one Abbreviated bin. When numbers to be dialed exceed 16 digits, one bin can be linked to another. For example we will use bins 20 and 21 linked together to dial the complete telephone number:

"1 2 3 4 5 6 {hook-flash} {pause} 7 8 9 0 1 2 3 4 5 6 7 8 9 0 1 2"

The entry in bin 20 is: 1 2 3 4 5 6 /P@ 2 1

The entry in bin 21 is: 7 8 9 0 1 2 3 4 5 6 7 8 9 0 1 2

Three special handling codes:

- Flash command = Feature 3; displayed as "\/" (a FLASH may be required to operate specific line features as are sometimes required by the host PBX.)
- Pause Insertion = Feature 7 0; displayed as "P" (when a pause is needed between the digits prior to the pause insertion and the digits after the pause insertion.)
- Linking = Feature 1; displayed as "@" plus the bin to link. The linked bin must be entered after the "@". (In the example bin 21 is the linked bin.) To dial this number, the user accesses bin #20 only. The special handling codes ("/", "P", and "@") occupy a character position.

Line Copy

MBC - 4-13

Use the "Line Copy" feature to copy the attributes of one CO line to another line. Begin by creating a "Template" line, one that has the attributes to be shared, and then do a "Copy From" that line to another line using "Copy To" for each line that should have these attributes.

The following attributes will be copied:

Data Range: 01—09

Factory Setting: N/A

Program one CO Line for all data parameters as desired. This CO Line will be the *template* for all data that will be copied to other CO Lines.

Select: Resource Line Copy

Press **show**

Input the CO Line number in two-digits (01~09) that is currently programmed as desired for others that will be copied with the data.

Press **save**

Input the CO Line number in two-digits (01~09) to which this data will be copied.

Press **save**

Repeat as necessary for all CO Lines to be copied.

Extension Copy

MBC - 4-14

Use the "Extension Copy" feature to copy the attributes of one Extension to another Extension. Begin by creating a "Template" Extension, one that has the attributes to be shared, and then do a "Copy From" that extension to another extension using "Copy To" for each extension that should have these attributes. The following attributes will be copied:

Data Range: 10—37

Factory Setting: N/A

- Day COS
- Night COS
- Hunt Group Answer
- Dialing
- Line Type
- Loud Bell
- Line Group
- Private To
- Day COS
- Night COS
- Monitor COS
- CO Line Assignment
- Receive Assignment
- Ring Assignment
- Extension Group

- Warning Tone
- Outgoing Drop
- Incoming Drop
- Function Key Allow
- Sys Abbr Check
- ICM Mode
- Record Allow
- Forced LCR

Program one Extension for all data parameters as desired. This Extension will be the *template* for all data that will be copied to other Extensions.

Select: Resource Extension Copy

Press `show`

Input the Extension number that is currently programmed as desired for others that will be copied with the data.

Press `save`

Input the Extension number to which this data will be copied.

Press `save`

Repeat as necessary for all Extensions to be copied.

System Time

MBC - 4-15

System Time is displayed on all digital display telephones. The Date and Time programmed here are also the settings applied to the voice mail system when it is installed.

Data Range: 00:00 ~ 23:59

Factory Setting: 00:00

Press `show`

Use the `back` and `next` buttons to navigate to the setting to be changed.

- Year
- Month
- Day
- Weekday
- Hour
- Minute

For the settings of: Year, Day, Hour and Minute, you must press `chg` and then input the data using the dial pad and then press `save`

For the settings of Month and Weekday, press `chg` until the desire value is displayed.

RMT X_RATE

MBC - 4-16

RMT sets the data transmission rate of the RS232 serial port when used with PC programming software. (Not currently available.)

Data Range: 9600, 19200, 38400

Factory Setting: 9600

Press `chg` until the desired data rate is shown.

SMDR X_RATE

MBC - 4-17

SMDR sets the data transmission rate of the RS232 serial port when used to collect extension calling data. (Station Message Detailed Recording.)

Data Range: 9600, 19200, 38400

Factory Setting: 9600

Press **chg** until the desired data rate is shown.

Hour Mode

MBC - 4-18

Digital Display Telephones can display the system time in either 12 or 24 hour format. When set to 24 hour format the time will be displayed as 00:00 to 23:59.

Data Range: 12—24

Factory Setting: 24

Press **chg** until the desired data rate is shown.

Dial Tone Detection

MBC - 4-19

This parameter, when set to "Y" (Yes) is used to detect central office dial tone before transmitting the DTMF digits. When set to "N" (No) the digits are transmitted directly to the Central office when they are dialed.

Data Range: Y/N

Factory Setting: N

Press **chg** to select.

Dial Tone Wait

MBC - 4-20

This Parameter is used with older central office equipment. It will delay the DTMF digits from being dialed directly to the central office when dialed. The digits are not sent to the central office until this timer expires. A Setting of "0" disables this feature.

Data Range: 0~8 seconds

Factory Setting: 0

Press **chg** to select.

Music Source

MBC - 4-21

The System is equipped with an internal tone source as well as an external music connector. This setting selects what is heard when intercom or Line callers are placed on hold. Additionally, digital speakerphones can dial Feature 52 and listen to the programmed music source as background music.

Data Range: TON, EXT

Factory Setting: TON (Tone)

Press **chg** to select.

KSU Revision

MBC - 4-22

This function is made available for diagnostics only. When accessed the software version in use in the main system memory is displayed.

Data Range: N/A

Factory Setting: N/A

Press **show** to select.

Feature Key Copy

MBC - 4-23

Use "Feature Key Copy" to copy the Programmed Flexible Feature Buttons from one Extension to another Extension. Begin by creating a "Template" Extension, one that has the attributes to be shared, and then do a "Copy From" and a "Copy To" for each Extension that should have these attributes.

Data Range: Copy From / Copy To

Factory Setting: N/A

Press **show** to select.

Input the Extension number that is currently programmed with Feature Key data as desired for others that will be copied with the data.

Press **save**

Input the Extension number to which this Feature Key data will be copied.

Press **save**

Repeat as necessary for all Extensions to be copied.

UART Type

MBC - 4-24

This parameter is used to set the signaling protocol for the RS232 port on the Option Board. Select between "SMDR" or "RMP". When using RMP, SMDR will be disabled, likewise when SMDR is enabled, RMP will be disabled.

Data Range: SMDR/RMP

Factory Setting: SMDR

Press **chg** to select

CID Repeater Modulation

MBC - 4-25

This parameter affects the coding method for which Caller ID data is detected on CO Lines. The system is capable of detecting CID on CO Lines for incoming (ringing) call. The system can detect either FSK or DTMF signaling for CID but cannot be set for both simultaneously. Choose the method required for your application and set that value here. (Usually the modulation method is "FSK".)

Data Range: FSK/DTMF

Factory Setting: FSK

Press **ch9** to select

Volume Limit

MBC - 4-26

This parameter is used to determine allowable volume (gain) adjustment settings for the function modes: "Page Level", "Speaker Limit", and "Handset Limit". This can be used to control overall office noise levels and to set maximum allowable settings for the benefit of the users.

- Data Range:
- Page Level: 1 ~ 8
- Speaker Limit: 1 ~ 8
- Handset Limit: 1 ~ 8
- Factory Settings:
- Page Level: 6
- Speaker Limit: 8
- Handset Limit: 8

Press **show**

Use **back** and **next** to select the parameter to change.

Press **chg** to select

Service Mode

MBC - 4-27

CO Line ring assignment, Class of Service and Extension Class of Service are activated by setting the system into one of two modes of service (*Service Mode*) - Day and Night. A third setting in this programming parameter which allows the programmer to set the system for "*Time Switching mode*" (MBC 4-07). When the system is placed into *Time Switching mode* the system automatically adjust the *Service Mode* from Day to Night.

The *Timed Switching Mode* (MBC 4-07) will follow a seven day, twenty-four hour schedule that will automatically switch the system from day to night mode, or night to day mode.

Data Range: Day, Night, Time

Factory Settings: Day

Press **CH9** to select

Notes:

- The Service Mode can also be adjusted using the System Administrator access (F#0) and password.
- The Attendant assigned extension (04-03) may also adjust the Service Mode using the Day/Night mode code (Feature 63) with the attendant extension password.
- The Attendant Day/Night Service Mode code can be programmed on an available Feature Button, but it will only function at the attendant (MBC 4-03) or alternate attendant (MBC 4-04) extensions.
- The Programmed button may contain the password for one touch day/night mode operation.

Option Port Function—SLT/Door Phone

MBC - 4-28

Note:

At default, extensions 36 and 37, are assigned as single line telephones that rings, so once a door phone is connected it will automatically answer the inbound call.

There are two *dual* use ports on the Option Board. These two ports can be set for use as a Door Phone interface or a Single Line Telephone (SLT) extension interface (analog port).

They cannot be used as both at the same time. When set as SLT extensions, they will operate as a standard analog line telephone for use with fax machines and modems, etc. When set to Door Phone, they will integrate with the systems' proprietary Door Phone. The programming parameters for the two Option Port Functions are:

- *Utility* – Single Line Telephone (analog port) or Door Phone.
- *Ring Type* – Ring (the only option available)
- *Ring Position (Day)* – When the port has been selected for Door Phone use, this parameter assigns the Day Mode ringing destination whenever the Door Phone Call Button is pressed. Ringing destinations can be extensions or Hunt Groups.
- *Ring Position (Night)* – When the port has been selected for Door Phone use, this parameter assigns the Night Mode ringing destination whenever the Door Phone Call Button is pressed. Ringing destinations can be extensions or Hunt Groups.
- *Maximum Ring Time* – Once the Door Phone Call Button is pressed, ringing at the extensions/hunt groups will continue until this timer has elapsed. This is provided to cancel ringing when the call goes unanswered.
- *Unlock code* – This code is used with a contact closure provided on the Option Board. It is often used to trigger a solenoid-activated door lock whereby the telephone user can open the door by dialing this code while connected to the Door Phone.
- *Open Indication* – Open indication is the amount of time that a door phone may remain connected once it places a call. Open indication can be limited from 01-60 seconds. A setting of "00" removes the limit function.
- *Door Relay* – Use this setting to link any of the four available relay contacts to this port. (When a Relay is associated to the port, the relay will operate when the user dials the Unlock Code.)

Data Range (Default Range in Bold) "p" 1 or 2 (N/A) "o" =

Utility: **SLT** 36/37, Door

Ring Type: **Ring**

. Ring Position (Day): 10 ~ 37, 82 ~ 87, **88**, 89

. Ring Position (Night): 10 ~ 37, 82 ~ 87, **88**, 89

Maximum Ring Time: 10, **16**, 30, 60, 90, 120

Unlock Code: #, *, 1 ~ 9

Open Indication: **00**, 01 ~ 60

Door Relay #1~4: Y/N - #1 "Y" for port 1, #2 "Y" for port 2

Press `show`

Input the port # to adjust (1 or 2), then press `show`

Use `back` and `next` to select the option to be programmed.

Press `chg` to select

Notes:

1. Door Phones are weather-resistant - not water proof.
2. There are contact closures on the Option Board that can be allocated for use with the Door Phones for actuation of a solenoid-activated door/gate lock.

Option Sensor Function

MBC - 4-29

There are four dual use contacts on the Option Board. These contacts can be set for use as a Door Phone Lock opener or Door Sensor. They cannot be used as both at the same time. When set as Door Lock Opener, they will operate according to a set of parameters to provide a contact closure to operate a solenoid and door lock control. When set as Secure, the contacts can be connected to a variety of devices to monitor the status of that device. (E.g. Inhouse security system, electronically controlled door.) The programming parameters for the four Option module connectors are:

- Utility – **Door Lock** (1~4), Secure (1~4).
- Secure Password – Password used to reset the alert condition.

Data Range (Default Range in Bold)

Utility: **Door Lock**, Secure

SC. Password: **0000**, 0001 ~ 9999

Press `show`

Input the sensor # to adjust (1, 2, 3 or 4), then press `show`

Use `back` and `next` to select the option to be programmed.

Press `chg` to select

Security Alarm Action

MBC - 4-30

For each of the four sensor contacts on the Option Board, a trigger of any of the sensors will cause action to be taken based on the programming in this category. Action here will occur only when the alert condition has not been reset (actual alarm condition exists).

Alert Mode can be set to one of three actions:

- Ring all extensions.
- Make a voice announcement to all extensions (requires the optional voice mail)
- N (No additional action)

An additional action *OutCall* may be programmed to place an outgoing call using these parameters:

- Outgoing Phone Number to call
- MSG Launch (requires the optional voice mail)
- Out Call Duration
- Out Call tries

The programming parameters are:

- Security circuit to setup (1~4).
- Alert Mode; as above (3 choices).
- Outcall—CO Line Selection
- Out Call Phone Number (Remote telephone number to dial, such as a —cellular telephone)
- Message Launch (how long after dialed number to send message)
- Out Call Duration (How long does the Outcall alert continue)
- Out Call Tries (How many times to attempt an out call should a failure occur)
- Relay Control—determines if Relay 1 ~ 4 is triggered with this action

Data Range (Default Range in Bold)

Alert Mode: **Ring**, Voice, N

Outcall— Tr. Sel: Null, **Group 1**, Group 2 ~ Group 6

OC. Phone No. **Empty**, 16 digits

MSG Launch: 01, 02, **03** ~ 60

OC. Duration: 0.5, 1, 2, **3** ~ 9

OC. Tries: 01 ~ **05** ~ 20

Relay Control— Relay # 1 ~ 4: Y/N

Press `show`

Input the sensor # to adjust (1, 2, 3 or 4), then press `show`

Use `back` and `next` to select the option to be programmed.

Press `chg` to select the desired value.

Option Relay Function

MBC - 4-31

There are four contacts available on the Option Board for use with door openers and door status signals. These contacts can be programmed to Monitor the status of a door (open closed), open a door, or to provide an indication that the door is secure.

The programming parameters for the two Option Port Functions are:

- D. Open – Door Opener
- Monitor—Monitor the status of the door.

Secure — Monitor the door for “secure” status.

4-31-r-o (where “r” = relay #, and “o” = option)

Data Range (Default Range in Bold)

Utility: **D. Open**, Monitor, Secure

D.Open On—300ms, **500ms**, 700ms, 1s, 2s, 3s, 5s, 8s, 10s (applies only to “D. Open” utility)

Press `show`

Input the relay # to program (1, 2, 3 or 4), then press `show`

Use `back` and `next` to select the option to be programmed.

Press `chg` to select the desired value.

Incoming Filter

MBC - 4-32

The system provides a means to block ringing, of up to 50 different numbers, based on the CID data received. When a number is entered into the Incoming Filter table it is associated to one or all Service Modes (Day, Night or Both) so that ringing for this call is cancelled only during the modes of operation desired.

A second table (also with a maximum of 50 entries) is available to single-out telephone numbers that may be desired from among larger groups of number that are not desired. For instance, perhaps all numbers from area code "976" are to be rejected, yet there is one number

from 976—xxxx-xxxxx; that should be allowed. This can be entered in the receive table.

The programming parameters are:

- Incoming Filter No Ring (MBC - 4-32-1)
 - No Ring Mode (MBC - 4-32-1-1)
 - Filter Phone No (MBC - 4-32-1-2)
 - Filter Index (MBC - 4-32-1-3)
- Incoming Filter Ring (MBC - 4-32-2)
 - Ring Mode (MBC - 4-32-2-1)
 - Filter Phone No (MBC - 4-32-2-2)
 - Filter Index (MBC - 4-32-2-3)

Data Range (Default Range in Bold)

Incoming Filter No Ring

Mode: **Never**/Day/Night

Filter Phone No—Filter Index 01-50: Empty

Incoming Filter Ring

Mode: **Never**/Day/Night

Filter Phone No—Filter Index 01-50: Empty

Press `show`

Use the `back` and `next` button to select “Incoming Filter—No Ring” or “Incoming Filter Ring”

Press `chg` to select the Service Mode (Day/Night) when this table will be active.

Press `next` (to Filter Number)

Input the table Index to program (01 ~ 50) and then `show`

Press `chg` to input telephone number in this table position.

Press `save` to store the number.

1. The system checks the “Filter U” (Unring table), if it is active, and if a match is found, then the action is taken otherwise, the system will check Ring table if a match is found it will take that action, otherwise no action is taken.

6.5 Restriction

Call Restriction

This chapter defines each of the parameters of the Restriction data category, and lists the factory setting and other possible settings that can be selected

During Display Menu programming scroll through the menu options until you are at program "Restriction". To enter the Restriction Programming area press the "show" key.

Line Call Discrimination

Line Call Discrimination refers to the ability of an extension user to place certain calls on CO Lines. The guidelines defined in these parameters can be applied to an extension by means of its Class Of Service. Allowed dialing is input in ranges. In its simplest form an extension can be allowed to dial any number beginning with a digit from 0 to 9. In the same way an extension can be restricted to dialing only numbers beginning with digits 2 through 9.

There are 100 table entries that can be set up in ranges called "*Intervals*". Each Interval provides for digits in the "*From*" and "*To*" parameters. Intervals are programmed with the digit sequences that are to be allowed at the extensions with the associated Class Of Service. Given this brief example, if an extension is to be limited to calls that do not begin with 0 or 1, the table Interval entry would be From 2, To 9. Each Interval "*From*" parameter and "*To*" parameter has the capacity for up to 10 digits. In the example below extensions with Class Of Service "4" can dial telephone numbers beginning with "50" and "51" but are not able to dial telephone numbers beginning with "52"~"58".

Intervals are assigned to Classes Of Service for extensions and CO Lines. Therefore an extension that is allowed to dial a telephone number on one CO Line may not be able to dial that same number on a different CO Line. Class Of Service settings are applied in both the Day and Night Service Modes. Therefore dialing characteristics can be different for Extensions and CO Lines based on the time of day and operating mode of the system.

Restriction

Data Range: Digit Interval 001 ~ 100, "From", "To": any digits up to ten in length

Digit Interval 001 ~ 100, Extension COS: Day Y/N, Night Y/N

Digit Interval 001 ~ 100, Line COS: Day Y/N, Night Y/N

Factory Setting: Digit Interval 001: From "0", To "#" (No restrictions)

Digit Interval 001: Extension COS: Day = Y, Night = Y

Digit Interval 001: Line COS: Day = Y, Night = Y

Digit Interval 002~100: From "Empty", To "Empty"

Digit Interval 001: Extension COS: Day = N, Night = N

Digit Interval 001: Line COS: Day = N, Night = N

Press show, Line Discrimination is displayed. Press show Input the Interval to Program and then press show. The first input screen is the "From" parameter. If this is to be changed press Chg. Input the desired digits that will begin this interval and then press save. Press next. The "To" parameter for this interval is shown. Press chg to input digits and continue using this convention for further interval programming.

TABLE 6.5.2 Default Classes of Service

No.	Allowed Intervals		Extension										CO Line																
	From	To	Day					Night					Day					Night											
			0	1	2	3	4	5	6	7	0	1	2	3	4	5	6	7	0	1	2	3	4	5	6	7			
001	0	#	Y	N	N	N	N	N	N	N	Y	N	N	N	N	N	N	Y	Y	Y	Y	Y	Y	Y	Y	Y	Y	Y	Y
002	2	#	N	Y	N	N	N	N	N	N	N	Y	N	N	N	N	N	Y	Y	Y	Y	Y	Y	Y	Y	Y	Y	Y	Y
003	2	#	N	N	Y	N	N	N	N	N	N	N	Y	N	N	N	N	Y	Y	Y	Y	Y	Y	Y	Y	Y	Y	Y	Y
004	1	1	N	N	Y	N	N	N	N	N	N	Y	N	N	N	N	N	Y	Y	Y	Y	Y	Y	Y	Y	Y	Y	Y	Y
005	2	#	N	N	Y	N	N	N	N	N	N	N	Y	N	N	N	N	Y	Y	Y	Y	Y	Y	Y	Y	Y	Y	Y	Y
006	0	0	N	N	N	Y	N	N	N	N	N	N	Y	N	N	N	N	Y	Y	Y	Y	Y	Y	Y	Y	Y	Y	Y	Y
007	0	0	N	N	N	Y	N	N	N	N	N	N	Y	N	N	N	N	Y	Y	Y	Y	Y	Y	Y	Y	Y	Y	Y	Y
008	1	1	N	N	N	N	Y	N	N	N	N	N	Y	N	N	N	N	Y	Y	Y	Y	Y	Y	Y	Y	Y	Y	Y	Y
	--	--	--	--	--	--	--	--	--	--	--	--	--	--	--	--	--	--	--	--	--	--	--	--	--	--	--	--	
100	-	-	N	N	N	N	N	N	N	N	N	N	N	N	N	N	N	N	N	N	N	N	N	N	N	N	N	N	N

- 1. Class of Service 0 = Unlimited Dialing 0 - #
- 2. Class of Service 1 = Local Only with * and # as the first digit.
- 3. Class of Service 2 = Unlimited Dialing without 0 as the first digit.
- 4. Class of Service 3 = Local Only without 1 as the first digit.
- 5. Class of Service 4 = Can only Dial 0 as the first digit.
- 6. Class of Service 5 = Can only dial 1 as the first digit.

Password Dial Table (Traveling COS)

The system allows users to roam from one extension to another while retaining their dialing privileges. This is accomplished with the Password Dial Table. When a user attempts to place a Line call at an extension where that call is restricted, he may use the Password Dial Feature to override the prevailing extension COS and make the call. To use this feature the person making the call enters the Password Dial access code "4", he is then prompted to input a password. The password that is entered is matched to a password in this table. If there is a match, the caller may place a call as allowed by the dialing privileges assigned to that password. Any table entry may also be assigned to LCR (Least Cost Routing) for automatic CO Line selection.

TABLE 6.5.3 Password Table (Traveling Class of Service)

No.	Password	COS	LCR E Enable	Length
1	NULL	0	N	3
2	NULL	0	N	
⋮		⋮	⋮	
⋮		⋮	⋮	
600	NULL	0	N	

There are 150 Password Dial Tables

Address: 5-02 Password Dial Table

Data Range: Password Length: 2 ~ 8 digits

Password Table 001 ~ 150: any digits 0~9 up to the total length possible

Password Table 001 ~ 150, COS: 0~7

Password Table 001 ~ 150, LCR Enable: Y/N

Factory Setting: Password Length: 3 digits

Password Table 001 ~ 150: Empty

Password Table 001 ~ 150, COS: 0

Password Table 001 ~ 150, LCR Enable: N

Press **show**

Press **chg** until the desired Password Length is shown.

Press **next** to Password, then press **show**

Input the table number (001~150) of the password to program then press **show**

Press **chg** and input the password desired.

Press **save**, the password entered is shown, now press **next**.

Press **chg** until the desired COS is shown (COS for this password use).

Press **next** to LCR Enable.

Press **chg** to select Yes or No. If set to Yes, this will route the call dialed via LCR programming.

Least Cost Routing

When users can't easily make call cost decisions on their own, Least Cost Routing can be implemented to assure that calls being placed are utilizing the most cost-efficient method. LCR works by analyzing the number dialed by a user before any digits are "sent" (dialed) on the line. The detailed programming of LCR during setup is essential to assure that the system selects the best possible resource available to make a call.

The Digit Comparison Table is the primary tool in LCR that must be programmed. This table is comprised of From and To Intervals as is the Call Discrimination Table. This configuration allows for a very flexible means of entering digits for comparison and routing. The From and To parameters may contain a single digit or a group of digits up to ten maximum in length. The illustrations on the next page show the default (factory) programming of the

LCR Digit Comparison Table and Digit Modification Table. In this configuration only the first three digits of any number dialed are compared to the table—all other are insignificant. If the user dials any number within the range of 001~999, one-digit in length or longer, the call can be routed in this LCR configuration. However if the number begins with a "#" or "*" it cannot be routed via LCR with the default programming.

Depending on what route is to be taken for a call, based on the number dialed the digits may need to be modified. Modification can be anything from deleting to adding digits to those collected from the user.

TABLE 6.5.4 LCR Digit Comparison Table

No.	Dialed Number																				Line Group	DMT	
	From										To												
	0	1	2	3	4	5	6	7	8	9	0	1	2	3	4	5	6	7	8	9			10
001	0	0	1								9	9	9									1	01
002	N	U	L	L							N	U	L	L								NULL	01
003	N	U	L	L							N	U	L	L								NULL	01
004	N	U	L	L							N	U	L	L								NULL	01
005	N	U	L	L							N	U	L	L								NULL	01
006	N	U	L	L							N	U	L	L								NULL	01
007	N	U	L	L							N	U	L	L								NULL	01
008	N	U	L	L							N	U	L	L								NULL	01
100	N	U	L	L							N	U	L	L								NULL	01

Once a number is dialed, the LCR table is checked, if a match is found the Line Group is determined, and the Digit Modification Table is consulted. The DMT is the Number that directs the caller to the DMT reference Table seen below

DMT Reference Number	Digits to Delete	Prefix Digits																				Insert Digits										Insert Position
		1	2	3	4	5	6	7	8	9	10	11	12	13	14	15	16	17	18	19	20	1	2	3	4	5	6	7	8	9	10	
		01	N	O	N	E																	N	O	N	E						
02	N	O	N	E																	N	O	N	E								
03	N	O	N	E																	N	O	N	E								
04	N	O	N	E																	N	O	N	E								
05	N	O	N	E																	N	O	N	E								
06	N	O	N	E																	N	O	N	E								
07	N	O	N	E																	N	O	N	E								
08	N	O	N	E																	N	O	N	E								
		
24	N	O	N	E																N	O	N	E									

Data Range: Digit Comparison 001 ~ 100, "From", "To": any digits up to ten in length

Digit Comparison 001 ~ 100, Line Group: Null (None), 1~6

Digit Comparison 001 ~ 100, Digit Modification Table assignment: 01~24

Digit Modification Table 01~24, Delete Digits: Null, 01~32

Digit Modification Table 01~24, Prefix Digits: Empty, any digits up to 20

Digit Modification Table 01~24, Insert Digits: Empty, any digits up to ten

Digit Modification Table 01~24, Insert Position: Null, 01~32

Factory Setting: Digit Comparison 001: From "001", To "999"

Digit Comparison 001: Line Group: 1

Digit Comparison 001: Digit Modification Table: 01

Digit Comparison 002~100: From "Empty", To "Empty"

Digit Comparison 001: Line Group: Null

Digit Comparison 001: Digit Modification Table: Null

Digit Modification Table 01~24, Delete Digits: Null

Digit Modification Table 01~24, Prefix Digits: Empty

Digit Modification Table 01~24, Insert Digits: Empty

Digit Modification Table 01~24, Insert Position: Null

Press `show`, Digit Comparison Table is displayed.

Press `show`

Input the Interval to Program and then press `show`. The first input screen is the "From" parameter. If this is to be changed press `chg`. Input the desired digits that will begin this interval and then press `save`

Press `next` to go to the "To" parameter for this interval.

Press `chg` to input digits and continue using this convention for further interval programming.

Press `next` to Line Group, the current Line Group to be used for this Interval is shown.

Press `chg` to select the desired Line Group or NULL for none.

Press `next` to DMT (Digit Modification Table), the current DMT assigned to this Interval is shown. A DMT MUST BE ASSIGNED regardless if changes to dialed digits are necessary or not.

The default DMT is table 01. This table is reserved as the de facto—no changes required DMT assignment.

To input a new DMT for this Interval press `chg`, input the new DMT and `save`. Programming Digit Modification Table:

Select: Restriction-Least Cost Route—DGT. MOD. TABLE.

Press `show`

Input the Digit Modification Table to be programmed.

Press `show`. Delete Digit programming is shown.

If there are digits to delete at the beginning of what the user dialed, input the quantity of digits to delete starting with the first, then press `save`.

Press `next` to Prefix Digits.

If there are digits that weren't dialed by the user that need to be inserted before any of the actual digits dialed, program them here. These digits will be output prior to those that were dialed—excluding those deleted in the previous step.

Press `next` to Insert Digits.

If there are digits that weren't dialed by the user that need to be inserted at some point in the digit sequence as it is now (from the user and as modified in the previous steps), program them here. These digits will be output with the digit sequence at the Insertion Point (next step).

After the first two steps of Delete Digits and Prefix Insert Digits, the Insert Digits must be placed into the remaining sequence. Simply count the remaining digits up to where the "Insert Digits" must be placed. Input that number here so that the system can insert these Insert Digits at that point when sending the entire digit sequence.

6.6 Control

Control

This chapter defines each of the parameters of the Control data category, and lists the factory setting and other possible settings that can be selected During Display Menu programming scroll through the menu options until you are at program "Control". To enter the Control Programming area press the "show" key.

Data Auto Answer

MBC - 6-01

This parameter establishes the answering procedure for the internal modem. The internal modem which is used to call from one system to another or remote programming. The internal modem extension number is 55. When set to "Y" (Yes), the modem will automatically answer CO Line calls that are transferred to this extension number.

Data Range: Y/N

Factory Setting: Y

Press **ctrl** to select

Extension Hunt Group

MBC - 6-02

The system is equipped with 8 hunt groups, each can have 24 members. There are three (3) types of hunt groups:

- Hunt—Stations ring in the order that they are programmed. If a member in the group is busy, the next available member will ring, if all members are busy, the caller will hear ringing while they waits in queue for a hunt group extension to become available.
- All Ring—All stations ring simultaneously.
- VM—voice mail (This is a system specific designation for voice mail use only. Only Hunt Group 6 can be designated as the Voice Mail Hunt Group.)

Hunt groups provide a way to link extensions together for handling callers as a group. Calls can be programmed to ring directly or be transferred into a hunt group. There are pseudo extension numbers assigned to these hunt groups so that they can be dialed directly.

TABLE 6.6.5 Hunt Group Numbering

Hunt Groups
Hunt Group 1 = 82
Hunt Group 2 = 83
Hunt Group 3 = 84
Hunt Group 4 = 85
Hunt Group 5 = 86
*Hunt Group 6 = 87
Hunt Group 7 = 88
Hunt Group 8 = 89
* Default Voice Mail Group

Data Range: Groups: 1—9

Group Type: Hunt / All / VM

Group Members 01~24: any extension or voice mail port (An extension can be a member of more than one hunt group.)

Factory Setting

HG 1~5: Group Type: Hunt

HG 6: Group Type: VM

HG 7~8: Group Type: All

HG 1~5: NULL

HG 6: Members 1~8: 56~63,

Members 9~24: NULL

HG 7~8: Members 1~24: 10~33

Press `show`

Input the desired Hunt Group number to program (1~8) then press `show`

Group Type is displayed, press `chg` until the desired value is shown.

Press `next` to Group Member then press `show`

Member 1 is shown for this HG, press `chg` to input an extension number.

Input the extension number to be this HG Member and then press `save`

Use the `back` and `next` buttons to continue programming HG Members.

Voice Mail

MBC - 6-03

One of the Hunt Groups can be set for use with the integrated voice mail system. The

Voice Mail is fully integrated and usually requires no programming since it will automatically configure itself when installed. One of the Hunt Groups must be used to facilitate the integrated voice mail. The automatic configuration assigns this to HG 6. In addition, the Automatic Record feature is programmed here. When an extension user's calls are to be recorded on an ongoing basis for the majority of all calls at that extension, that extension number can be programmed here so that every CO Line call made and received initiates a recording. (The recording can be cancelled at the extension anytime during the conversation.) Up to eight maximum extensions can be assigned as Auto Record Extensions

Address: 6-3

Data Range:

VM Hunt Group: 1~8

Auto Record Extension: 10~37

Factory Setting

VM Hunt Group: 6

Auto Record Extension (1~8): NULL

Press **show**

Press **chg** until the desired Hunt Group is shown (usually not to be changed)

Press **next** to Auto Record Extension.

Press **show** #1 is displayed.

Press **chg**

Input the extension number for automatic record operation.

Press **show** Repeat for other extensions as required

Control Contact (Dry Contact)

MBC - 6-04

The system has one contact (referred to as a “Dry Contact”) that can be used to trigger ancillary devices for various applications. (E.g. Loud Bell Control—the ringing of an auxiliary bell for system ringing conditions.) The contact can be programmed to operate in association with the following system functions:

- Loud Bell Control
- External Music Source Switch
- External Page Interface Control

Data Range:

Dry Contact: L.B./EXT/PAGE

Factory Setting

Dry Contact: L.B.

Press  to select

Notes:

The contact is rated at 0.5A & 24V DC. When set for LBC operation, the CO Lines that are to activate the contact when ringing must also be programmed for “Loud Bell Y”. A Loud Bell requires an external power source. When set for External Music Source Switch, the contact will “Make” (close) whenever a CO Line is placed on hold to control external messaging-on-hold devices. When set for External Page Interface Control, the contact will “Make” (close) whenever a system user accesses the External Paging port. This allows the ancillary amplifier to be switched on and off.

Location to Directory

MBC - 6-5

All of the resources of the system are identified for access using a directory numbering system. This numbering system has been overlaid upon the various resources according to the location of that resource in the system architecture. Use this database parameter to swap the identify of a resource allocation based on location for any of the system extensions.

The system location mapping is as follows:

TABLE 6.6.6 Location to Directory - Locations

Location of each module
Location 1 = Main Board
Location 2 = 308E (first)
Location 3 = 308E (second)
Location 4 = Option Board
Location 5 = Voice Mail Board

The various circuits of each location are numeric references beginning with 1 and ending with the last possible port for the location (e.g. Main Board has extension ports 1~10). The default (factory) allocation of directory numbers for the resources are charted on the next page:

TABLE 6.6.7 Default Location to Directory Number for the Main Board and 1st 3x8 Module

Location	Location ID	Circuit #	Port Type	Directory Designation	Location	Location ID	Circuit #	Port Type	Directory Designation
Main Board	1	01	Digital	10	1st 3x8	2	01	Digital	18
	1	02	Digital	11		2	02	Digital	19
	1	03	Digital	12		2	03	Digital	20
	1	04	Digital	13		2	04	Digital	21
	1	05	Digital	14		2	05	Digital	22
	1	06	Digital	15		2	06	Digital	23
	1	07	Digital	16		2	07	Digital	24
	1	08	Digital	17		2	08	Digital	25
	1	09	Analog	34					
	1	10	Analog	35					

TABLE 6.6.8 Default location to Directory Number for the 2nd 3x8 module and the Analog Expansion

Location	Location ID	Circuit #	Port Type	Directory Designation	Location	Location ID	Circuit #	Port Type	Directory Designation
2nd 3x8	3	01	Digital	26	Analog Module	4	01	Analog/Door-phone	36
	3	02	Digital	27		4	02	Analog/Door-phone	37
	3	03	Digital	28					
	3	04	Digital	29					
	3	05	Digital	30					
	3	06	Digital	31					
	3	07	Digital	32					
	3	08	Digital	33					

TABLE 6.6.9 Default Location to Directory Number for the Digital Voice mail

Location	Location ID	Circuit #	Port Type	Directory Designation
Digital Voice Mail	5	01	Digital VM	56
	5	02	Digital VM	57
	5	03	Digital VM	58
	5	04	Digital VM	59
	5	05	Digital VM	60
	5	06	Digital VM	61
	5	07	Digital VM	62
	5	08	Digital VM	63

Data Range:10~63

Factory Setting: tables 6.3, 6.4 and 6.5

Press Show

Input the location to display/change and then press **Show**

Press **chg**

Input the desired number then press **Save**

Notes:

When a resource directory number has been changed, the original directory number is automatically assigned to the resource location from where the selected directory number was taken.

Directory to Location

MBC - 6-06

All of the resources of the system are identified for access using a directory numbering system. This numbering system has been overlaid upon the various resources according to the location of that resource in the system architecture. Use this database parameter to view the location of a resource allocation based on the system directory number assignment.

Data Range: N/A (Review Only)

Factory Setting: N/A (Review Only)

Press **Show**

Input the directory number to display and then press "**Show**". The Physical location is displayed.

System Warm Start

MBC - 6-07

As a diagnostic tool and service aid, the system has the ability to perform a system restart. This function should only be used by an experienced technician that understands the nuances of start-up sequences. The "Warm Start" will reset the system without changing any of the customer-specific database information.

Data Range: N/A

Factory Setting: N/A

Press **Show**

Input the Database password (default = "000000").

When prompted; "Are you sure?", press **YES** if you wish to perform a Warm Restart

System Cold Start

MBC - 6-08

As a diagnostic tool and service aid, the system has the ability to perform a system restart/reset. This function should only be used by an experienced technician that understands the nuances of start-up sequences in the system.

The "**Cold Start**" will **reset** the system **AND revert all customer-specific programming back to its default (factory) values**.

Caution:

All unique customer programming will be lost!

Data Range: N/A

Factory Setting: N/A

Press **Show**

Input the Customer Database password (default = "000000").

When prompted; "Are you sure?", press **YES** if you want to perform a System Cold Start and reset all system data.

Note:

This operation is non-recoverable once invoked. All data will be reset.

Notes:

Notes:

6.6

A Appendix A

Extension 55

Extension 55 is a directory location (extension) that emulates a system “modem” using FSK protocol. This allows a local telephone, to call into a remote system and become the programming extension on the remote system.

From a digital extension on a local server, dial the remote system to be programmed. Using the Auto Attendant or Live Attendant, asked to be transferred to Extension 55. While Extension 55 is ringing, Dial *Feature* # #.

Remote Programming Connect

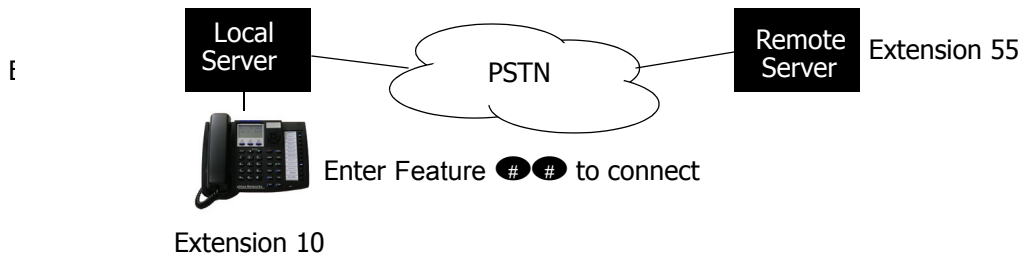

The telephone's display will update as the systems begin to connect:



The telephone's display will update to reveal the KSU and Software versions:



Once Connected, the telephone must enter the remote system's password:



Press `show`

Once the password is accepted the Menu Bypass Code Entry Screen is displayed:



Programming as normal.

When the programming is complete, press the **hold** (hold) button until the upper level menu is displayed. 1. Extension, 2. CO Line, 3. Call Handling, 4. Resource, 5. Restriction, or 6. Control, and then simply hang up to terminate the remote programming session.

Remote Programming Disconnect

Press hold until returning to the upper level menu, which will show 1.Extension, 2.CO Line, 3. Call Handling, 4. Resource, 5. Restriction, 6. Control and then hang up.

Troubleshooting Screens

The Password must be entered within 30 seconds of the systems will disconnect:



If an incorrect password is entered:



Database Setup failure is displayed when someone else is already in database or Attendant Administration programming.



If someone else is already using the modem, Modem busy will be displayed.



7 *Voice Processing System*

The optional 8-Port 6 hour voice processing system uses solid state flash technology to ensure the best quality of message recording and playback.



The optional Voice Processing System is programmed, using DTMF tones, through a digital telephone which is connected to the system. Using prerecorded prompts, the voice processing walks the installer through programming process.

This chapter outlines technical programming parameters (Administrative Programming) for the integrated Voice processing system. Subscribers should refer to the User Guide and Quick Reference Card to fully understand their new voice processing system.









Automated Attendant

Front End Auto Attendant

Front End Auto Attendant is when calls are directed to the voice processing before ringing any extensions in the system. Once a call is answered, the voice processing's Auto Attendant module plays the appropriate greeting and allows the caller to dial their desired destination using the touch tone key pad on their telephone.

The following programming steps are used when programming a Front End Auto Attendant:

In the telephone system:

1. Enter Feature #*
2. Enter the System Password; at default 
3. Press `show`
4. Enter 2-LN-03 (LN = Line Number 1 - 9)
5. Press `show`
6. The Display will read HUNT GROUP ANS
7. Press `show`
8. The display will read DAY POS:
9. Press `chg` Until 6 is displayed
10. Press `next`
11. The display will read NIGHT POS:
12. Press `chg` Until 6 is displayed
13. Press the Volume up or Volume down button and repeat steps 4 - 12 for all CO Lines that will be answered using the Front End Auto Attendant.

Overflow Auto Attendant

An Overflow Auto Attendant, sometimes called Delayed Auto Attendant Answer, rings the extensions before the call overflows to the voice processing's Auto Attendant.

The following programming steps are used when programming an Overflow Auto Attendant:

In the telephone system:

1. Enter Feature **#*⁰⁰⁰⁰**
2. Enter the System Password; at default **00000000⁰⁰⁰⁰**
3. Press **show**
4. Enter 2-LN-15 (LN = Line Number 1 - 9)
5. Press **show**
6. The Display will read **PRESET CFW.**
7. Press **show**
8. The display will read **DAY POS. :**
9. Enter 87 (the default voice processing group)
10. Press **save** - The 87 changes to **VM**
11. The display will read **NIGHT POS. :**
12. Press the Volume up or Volume down button and repeat steps 4 - 11 for all CO Lines that will use the Overflow Auto Attendant Feature.

Shutdown Procedure

The integrated voice processing will be fully operational within minutes of system being powered up. Therefore, to maintain proper database integrity it is important to understand the proper shutdown procedure.

1. From any digital telephone enter Feature **#0⁰⁰⁰⁰**
2. Followed by the attendant password (at Default the password is **9999⁹⁹⁹⁹**)
3. Press **back**
4. The display will update **SHUT DOWN VM**
5. Press **show**
6. Press **go**
7. When the display returns to **SHUT DOWN VM**
8. The system can be safely powered down



voice processing Call Flow

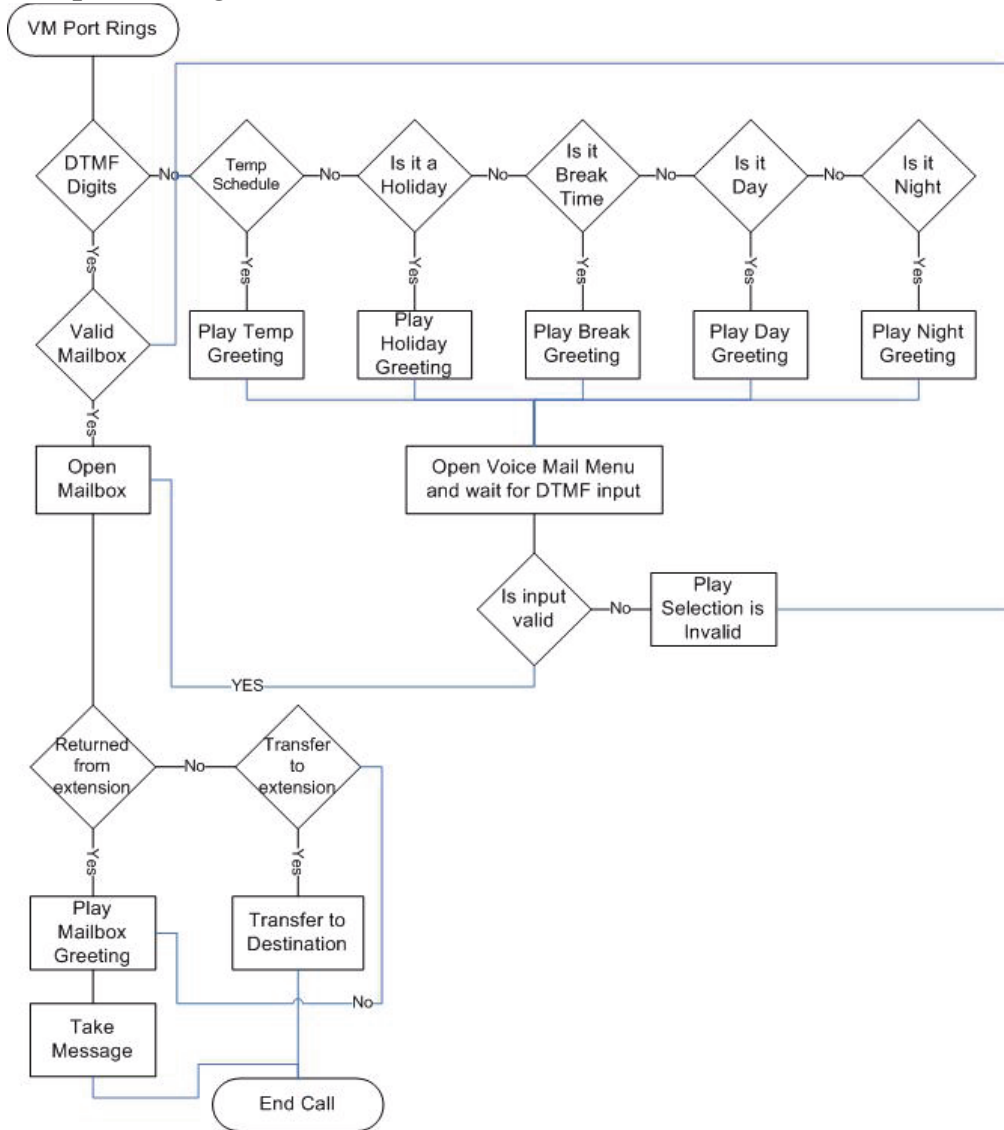

The voice processing system can be programmed to play 4 different greetings depending on the time of the day or if it is a holiday. A holiday greeting will be active from midnight, the day of the holiday, until 11:59 the day of the holiday, or the next time it is scheduled to change modes. There is one call routing menu, which allows callers to enter their desired destinations, such as a Department mailboxes or an individual extensions.

Administrative Programming

To enter Voice Processing Administration Programming, from an idle digital telephone;

1. Dial 7*
2. During the Main Auto attendant Greeting, enter 7 **
3. Enter 1 for the company ID (always use 1)
4. Enter 1 to confirm company ID
5. Enter 123456 for the Admin Password (Default Password)

Voice Processing Programming Menu

There are 4 areas of programming that can be accessed from the main programming menu:

- 1 General Settings
- 2 Advanced Settings
- 3 Not used
- 4 Broadcast Messages
- # Previous Menu

Main Menu Programming Flow

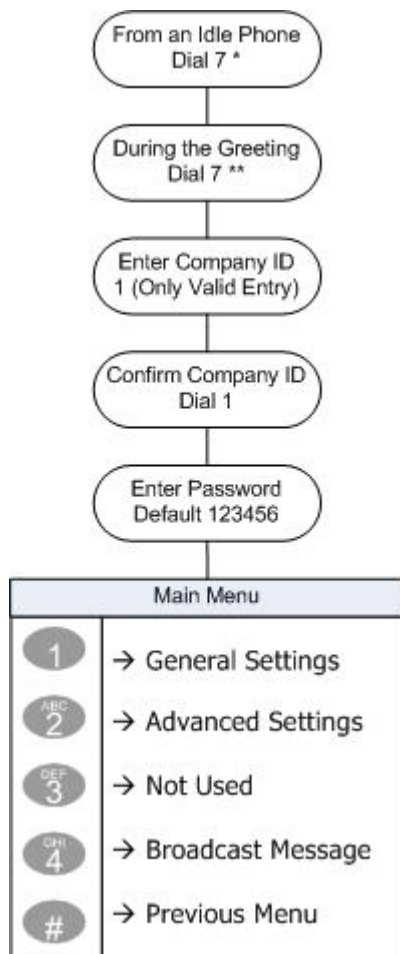

1 General Settings

General Settings are “basic” parameters which are used to guide the voice processing system through daily tasks.

The General Settings menu and submenus

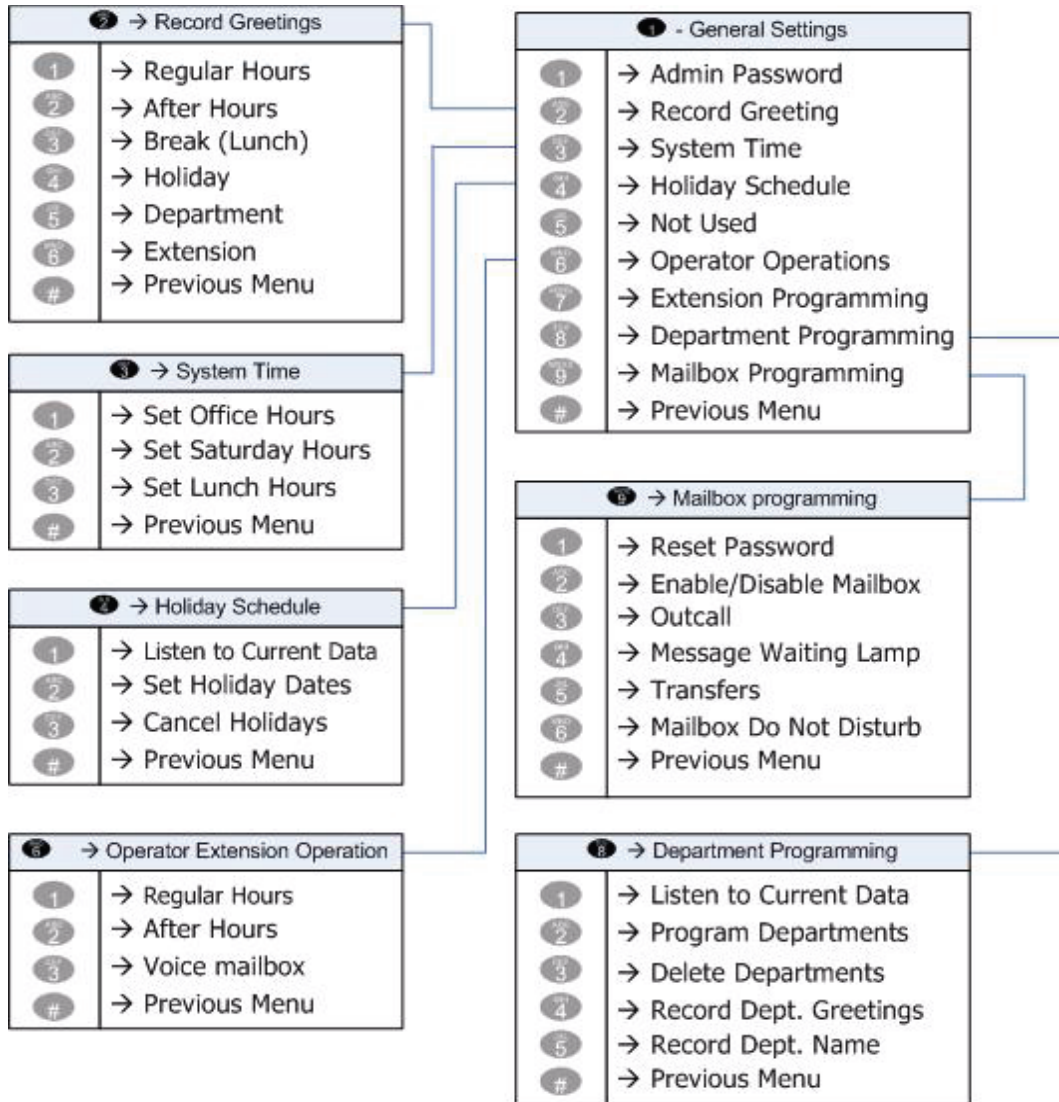

1 = Admin Password

At default the Admin Password is set to 123456, and can be changed to any number between 000000 and 999999, the password must be 6 Digits in length.

2 = Record Greetings

There are a total of 6 greetings in the voice processing system. Four of them - Regular Hours, After Hours, Break (Lunch) and Holiday are system greetings, which are played to callers when the voice processing answers. The final two - Department Directory and Extension Directory are played after the caller makes a selection, using the DTMF tones, from the main menu.

- 1 Regular Hours - This greeting will play during regular office hours, as defined in the "System Time" parameter. If no greeting is recorded, a generic greeting will play.
- 2 After Hours - This greeting will play after regular office hours, as defined in the "System Time" parameter. If no greeting is recorded, a generic greeting will play.
- 3 Break - This greeting will play during the regularly scheduled break, as defined in the "System Time" parameter. If no greeting is recorded, a generic greeting will play.
- 4 Holiday - This greeting will play during any programmed holiday as defined in the "Holiday Schedule" parameter. If no greeting is recorded, a generic greeting will play.
- 5 Department Directory Greeting - The department directory greeting is used to list the departments' name and extension numbers when a caller dials 7 1 1 from the Call Routing Menu. This greeting will be specific to each installation so no generic greeting is played. (Related Programming *Department Programming*)
- 6 Extension Menu Greeting - The extension directory greeting is used to list the extension names and numbers when a caller dials 7 1 2 from the Call Routing Menu. This greeting will be specific to each installation so no generic greeting is played.

3 = System Time

The System Time setting - often called the Open and Closed Schedule - is used by the voice processing system to determine when to play the holiday, night, or regular office hours greetings. The voice processing system verifies the current time and selects the appropriate greeting to be played. If no greeting is recorded then a generic greeting will be played. The following parameters are used when setting the system time:

- ① Set office Hours - This is the time during the day that the office is considered open. At default the time is set to 08:00 to 17:00 (5 pm) and can be changed by entering in a new 8 digit time. For example, to change the open schedule from 8:00 to 5:00 to 9:00 am to 6:00 pm the enter, in 24 hour format, will be 09001800. During that time the Regular Hours Greeting will play. Any time before 9:00 am and after 1800 (6:00pm) the after hours greeting will play.
- ② Set Saturday Hours - If the business is going to have Saturday hours, they should be programmed here, using the same 24 hour format. If no Saturday office hours are needed, just leave it at default. Sunday will play the holiday greeting, from Midnight Saturday (00:00) until Midnight Sunday (00:00). This allows the greeting to be customized for each installation.
- ③ Lunch Hours - At default no lunch hour(s) is defined. If a special lunch break greeting is desired then this time must be set. For example, to activate a lunch greeting from noon to 1 pm, the entry would be 12001300. This will activate the lunch greeting automatically at 12 noon and play it until 1 pm. At 1 pm, the voice processing will verify the open and closed schedule and play the appropriate greeting.

NOTE:

The voice processing system time and date, for envelope information, is synchronized with the telephone system. Therefore, once the KSU time and date is set, so too is the voice processing.

4 = Holiday Schedule

Up to 100 holidays can be predefined in the voice processing system. Once a holiday is defined, it will play a special Holiday Greeting, if it is recorded in the "Record Greetings" section. If no holiday greeting is recorded the generic after hours greeting will be played. The year, in 4 digit format, must be entered before each holiday.

- 1 Listen to current data - This will play all of the currently programmed holidays in the order that they were entered.
- 2 Set the holiday dates - Enter the dates for each holiday in 4 digit format. For example, enter January 1 as 0101, then press # to save the entry.

5 = System Interface Codes

- NOT USED AT THIS TIME

6 = Operator Operations

The Operator Operations parameters are referenced whenever a caller dials 0 while in the voice processing system. There are three programmable parameters that can be customized for each installation.

- 1 Operator extension regular hours - This parameter establishes the extension that rings during office hours when a caller dials 0. At default, extension 10 is defined as the operator.
- 2 Operator extension after hours - This parameter establishes the extension that rings after hours when a caller dials 0. At default, extension 10 is defined as the operator.
- 3 Operator's voice mailbox - The operator's voice mailbox 0 can be enabled or disabled. When disabled no messages can be recorded in mailbox 0. When enabled messages can be recorded.

Note:

Any number of digital telephones can be programmed with a flexible button to monitor mailbox 0. When a message is left in mailbox 0, all extensions with a programmed button will receive a flashing indication that a new message is in the mailbox. Unlike all other mailboxes, the Operator Mailbox does not require a password. The Message Waiting Indication (LED and Status Bar) will be turned off at all extensions when the mailbox is accessed.

Use the following steps to program mailbox 0 button:

1. At any idle extension press Feature **# 3**
2. Press an available flexible button
3. within three seconds press **ch9**
4. Press the interactive button associated with **feat**
5. Press the Feature button followed by 66 0 - 66 is a definable mailbox button and 0 is the mailbox that is being defined. For other mailboxes please refer to the department programming section.
6. Press the interactive button associated with **save**

7 = Extension Programming

At default, the voice processing system comes with 30 individual extensions and 9 department extensions. Additional extensions may be added for users that may not have a physical telephone, but would like to have voice mail messaged left at the office for them. They will have a "Virtual Extension".

- The system will confirm that it is using two digit extension numbers. Press **1** to confirm this but DO NOT CHANGE THIS PARAMETER!
- **1** Add multiple extensions - Enter the beginning and the end numbers of the group of extensions to be added. For example, 35 ~ 40.
- **2** Add one extension at a time - Enter the extension to be added.

Use the following steps to create a "Virtual Extension":

1. Enter Administrative programming
2. Make sure that the extensions have been created.
3. Enter the mailbox using **7 *** plus ***** and the mailbox number, and mailbox password. Select **6** for Direct Message Delivery.

From the Auto Attendant, if the extension number is dialed, the caller will go directly to the mailbox.

To transfer the caller directly to the mailbox, the attendant will dial, Transfer, **7 *** and the mailbox number and then hang up. The outside caller should hear the subscriber's personal greeting.

Subscriber without extensions will pick up their messages remotely by dialing ***** plus the mailbox number and then their password.

8 = Department Programming

The voice mail system has a comprehensive Call Routing Menu, which is available with all greetings. Once a greeting is played, the Call Routing Menu is presented to the caller allowing them to dial an individual extension or department mailbox.

There are a total of 20 department mailboxes 70 through 89. Each department mailbox may be associated with an extension or hunt group. Table 7.1 on page 202 shows the default associations.

A department mailbox can be used as a mailbox for an individual that does not have an extension on the telephone system or as a mailbox for a group of extensions. When a department mailbox is dialed, the telephone system transfers the caller to the associated extension or hunt group.

TABLE 7.1 Preassociated Department Mailboxes

Department Mailbox	Associated Hunt Groups
70	None
71	None
72 or 82	82
73 or 83	83
74 or 84	84
75 or 85	85
76 or 86	86
77 or 87	None
78 or 88	None
79 or 89	None

At default, there are no members (extensions) programmed into hunt groups 82~86. Therefore, if department mailboxes are going to be used, members must be entered into the group. The following procedure is used to add members into a hunt group.

In the telephone system:

1. Enter Feature # *
2. Enter the System Password; at default 000000
3. Press show
4. Enter 6-2
5. Press show

6. Enter the Hunt Group to program (82~86)
7. Press `show`
8. Press `next` until "Member" is displayed
9. Press `show`
10. Press `chg`
11. Enter the first member that should ring when the hunt group is dialed.
12. Press `next`.
13. Repeat steps 10 through 12 until all members are entered.

At the Telephone Extension:

1. At any idle extension press Feature `# 3`
2. Press an available flexible button
3. within three seconds press `chg`
4. Press the interactive button associated with `feat`.
5. Press the Feature button followed by 66 and then the department mailbox number [72~76], 66 is a definable mailbox button and [72~76] are the mailboxes that are being defined.
6. Press the interactive button associated with `save`

Record the Department Name and Greeting:

1. Dial 7*
2. Dial *
3. Dial the Department Mailbox Number 70~79
4. Input the mailbox password 0000
5. Dial 4 to record the mailbox greeting
6. Dial 2 to record the department mailbox greeting
7. Dial 5 to record the mailbox name
8. Dial 2 to record the department mailbox greeting

Record the Department mailbox directory 711:

Once the department mailboxes are established it is important to record the department mailbox directory.

1. Dial 7*
2. During the Main Auto attendant Greeting, enter 7 **
3. Enter 1 for the company ID (always use 1)

4. Enter 1 to confirm company ID
5. Enter 123456 for the Admin Password (Default Password)
6. Enter 1 for General Settings
7. Enter 2 to Record Greetings
8. Enter 1 to record the English Greeting (Only English is supported at this time)
9. Enter 5 to Record the department greeting Enter 1 to listen the current greeting
10. Enter 2 to record the department greeting.
11. This greeting should list all of the department mailboxes, and how to reach them. For example "For the Sales Department dial 72, for the Support Department dial 73, for Accounting dial 74, For all other inquires dial 75."

9 = Mailbox Settings

Mailbox settings will affect only the mailbox that is entered when accessing the Mailbox Settings programming parameters. There are six programming parameters which can be used to customer each individual or department mailbox.

- 1 Reset password - This allows the administrator to reset individual mailbox passwords back to factory default, which is 0000.
- 2 Enable/Disable - When a mailbox is disabled, no voice mail messages can be recorded. When the mailbox is enabled, it will play the greeting and take a message.
- 3 Out Calling Allow/Deny - If enabled the entered mailbox will have the ability to programmed the voice mail to call an external telephone after a new message is received. The voice mail will call the telephone number and allow the subscriber to enter their password and retrieve any new or saved messages. When using this feature the voice mail places the call and begins playing a message asking the subscriber to input thier password, and then it waits for a DTMF tone. If no tone is heard the voice mail will play a special "Invalid Input" prompt and then it will begin the cycle all over again. Therefore, it is possible for the subscriber to answer the call while the voice mail is in the middle of playing the message or when it is playing the *Invalid Input* prompt.
- 4 Message Wait Lamp - After every new message, the voice mail will set a visual indication, at digital extensions, lighting the LED associated with the "Voice Mail" button and the light bar. Although rare, it is possible for the two systems to lose synchronization causing the light to be on, even when there are no new messages. This parameter will extinguish the light.
- 5 Transfer - At default the system matches the telephone extension number with the mailbox number. For example, Extension 10 is associated with

mailbox 10. Although these default settings will be fine for most installation, this parameter allows the mailbox to be associated with any physical extension. For example, Extension 10 could be associated with mailbox 12.

- **6** Mailbox Do Not Disturb - Mailbox DND should be enabled when a subscriber has a voice mailbox but does not have a physical extension. For example, outside sales personnel may not have a physical telephone extension, but they can still receive voice mail messages.

2 *Advanced Settings*

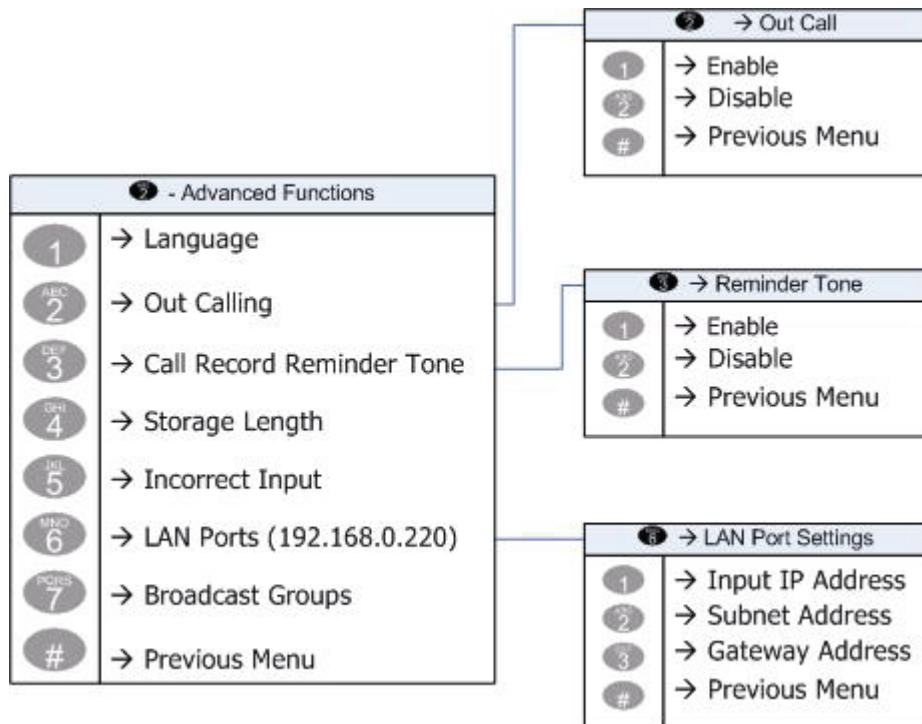

Advanced Settings are reserved for system wide settings parameters and advanced features.

1 = Language

Only English is supported at this time

2 = Out Calling

This system wide parameter will enable or disable the out calling feature for all mailboxes in the system. If this parameter is disabled, no mailboxes will be able to do any external notification to pagers (beepers) or cellular or home telephone numbers. When enabled, and configured by an individual or department mailbox, the external telephone numbers will be dialed when a new message is left in the mailbox.

3 = Call Record Reminder Tone

Not used at this time.

4 = Storage Length

This system wide setting determines how long a voice mail message can be stored before it is deleted. At default, a message can be stored for up to 30 days, and then it will be deleted. The voice mail does not give a warning before an expired message is deleted, and there is no way for it to be recovered.

5 = Incorrect Input

This parameter determines the number of times a digit can be entered before the voice mail disconnects the call.

6 = LAN Port

The voice mail can be programmed using an Internet Browser such as Internet Explorer. At default the voice mail's TCP/IP Address is set to 192.168.0.220, the Subnet Mask is set to 255.255.255.0 and no Default Gateway is defined. See ["Programming Using TCP/IP" on page 207](#).

7 = Broadcast Groups

The system allows the administrator to create up to nine broadcast message groups 01 - 09. A group, such as Sales Department, Support Department or even the Bowling or Softball team, will all receive the same message to multiple subscribers at one time.

Programming Using TCP/IP

Programming the Voice Processing System can be done using TCP/IP through a Local Area Network (LAN) connection or it can be done by connecting a PC directly to the voice mail Ethernet port using a cross-over cable. The Voice Processing System, at default is given a Class "C" IP address of 192.168.0.220, with a Subnet Mask of 255.255.255.0, which can be customized at each installation.

Cross Over Cable

Pin Out

PC	WO	OW	WG	OPEN	OPEN	GW	OPEN	OPEN
VPS	WG	GW	WO	OPEN	OPEN	OW	OPEN	OPEN
W=White, G=Green, O=Orange								

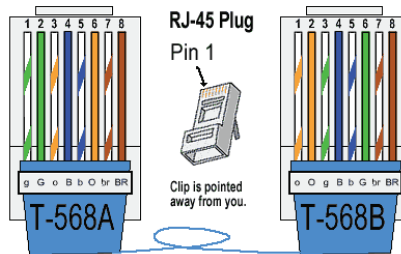

When using a Cross over cable, the cross over calbe connects directly from the PC Ethernet port to the voice mail Ethernet Port.

Your PC:

To access the Voice Mail using a cross over cable, you must create a fixed IP address on your PC that is similiar, but not the same, as the IP address assigned to the voice mail system. For example, the voice mail address is set to 192.168.0.220, so set your PC to 192.168.0.221.

1. On the PC go to Control Panel --> Double click on Network Connections --> and right click on the "Local Area Network" connection.
2. Double click on the "Local Area Connection" (Wired) - the Properties window be visible.
3. Scroll down to "TCP/IP" and double click to open the TCP/IP properties.

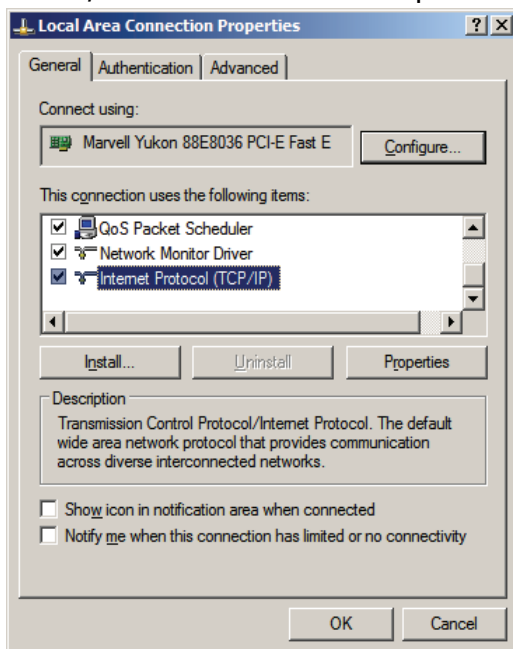

4. Select "Use the following IP Address" and enter (for example) 192.168.0.221

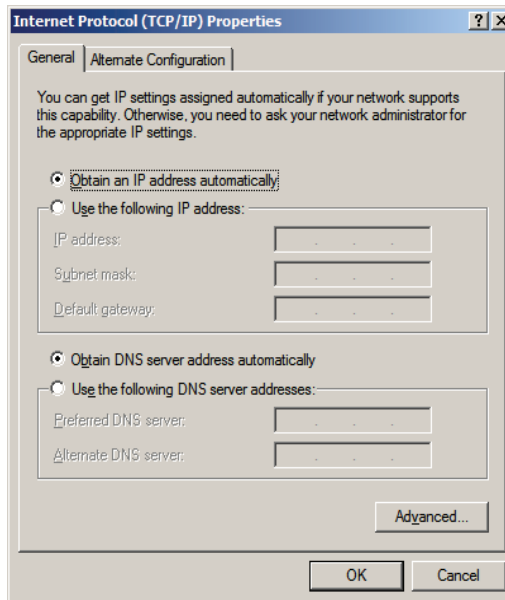

Internet Protocol (TCP/IP) Properties

General | Alternate Configuration

You can get IP settings assigned automatically if your network supports this capability. Otherwise, you need to ask your network administrator for the appropriate IP settings.

Obtain an IP address automatically:

Use the following IP address:

IP address: [. . .]

Subnet mask: [. . .]

Default gateway: [. . .]

Obtain DNS server address automatically:

Use the following DNS server addresses:

Preferred DNS server: [. . .]

Alternate DNS server: [. . .]

Advanced...

OK Cancel

5. The Subnet Mask should automatically fill in with 255.255.255.0

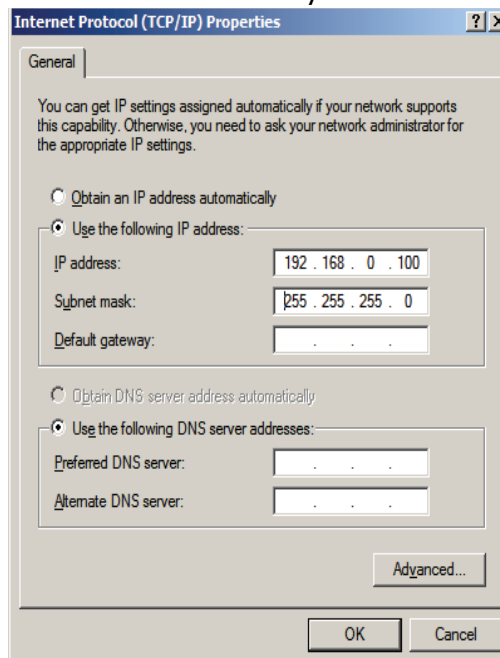

Internet Protocol (TCP/IP) Properties

General

You can get IP settings assigned automatically if your network supports this capability. Otherwise, you need to ask your network administrator for the appropriate IP settings.

Obtain an IP address automatically:

Use the following IP address:

IP address: [192 . 168 . 0 . 100]

Subnet mask: [255 . 255 . 255 . 0]

Default gateway: [. . .]

Obtain DNS server address automatically:

Use the following DNS server addresses:

Preferred DNS server: [. . .]

Alternate DNS server: [. . .]

Advanced...

OK Cancel

6. Click "OK" until all network connection windows are closed.
7. Open Internet Explorer and enter the voice mail's IP Address. The default is 192.160.0.220.

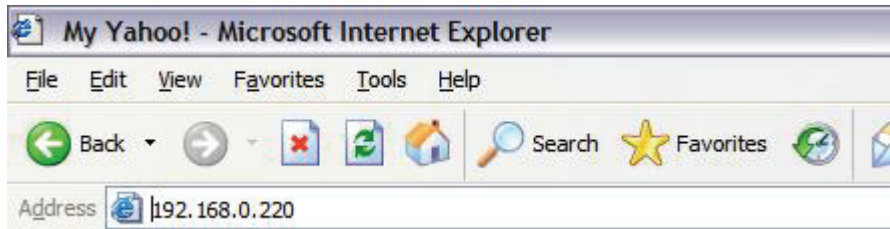

Using a Router

Pin Out

PC	WO	OW	WG	OPEN	OPEN	GW	OPEN	OPEN
VPS	WO	OW	WG	OPEN	OPEN	GW	OPEN	OPEN
W=White, G=Green, O=Orange								

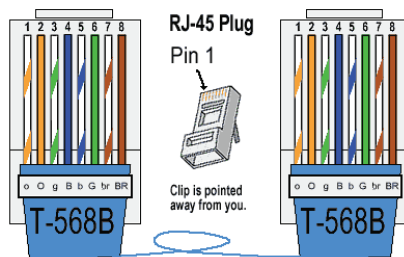

Both the PC and the voice mail is connected to the Local Area Network (LAN) using a standard Patch Cable.

Before the PC and voice mail can be connected to the LAN the following addresses must be known.

1. Network IP Address scheme (to establish a static IP Address for the voice mail)
2. Network Subnet Mask
3. Network Default Gateway

The following steps can be used to gather the needed IP Addresses if they are not known.

When connecting Internet Explorer to the voice mail system you will need to create a "Static" IP address and enter that information into the voice mail system. Use the following steps to find a suitable IP Address.

Step 1:

To find the network's addressing scheme do the following:

Choice a computer that is currently connected to the network -

Go to Start --> Run

When the Run Box comes up, enter CMD.

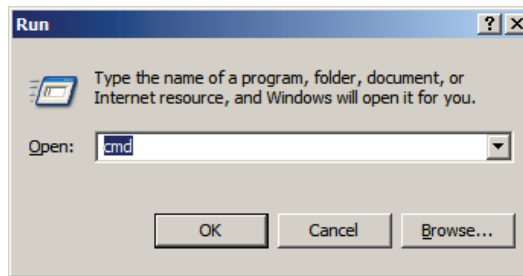

Press "OK"

In the "DOS" window type ipconfig /all [ipconfig (space) /all]

```

C:\WINDOWS\system32\cmd.exe
Microsoft Windows XP [Version 5.1.2600]
(C) Copyright 1985-2001 Microsoft Corp.

C:\Documents and Settings\Paul Lynch>ipconfig /all

Windows IP Configuration

Host Name . . . . . : Laptop_Plynch
Primary Dns Suffix . . . . . :
Node Type . . . . . : Broadcast
IP Routing Enabled. . . . . : No
WINS Proxy Enabled. . . . . : No

Ethernet adapter Wireless Network Connection:

Connection-specific DNS Suffix . :
Description . . . . . : Intel(R) PRO/Wireless 2200BG Network
Connection
Physical Address. . . . . : 00-16-6F-29-BE-09
Dhcp Enabled. . . . . : Yes
Autonomous Configuration Enabled. . . . . : Yes
IP Address. . . . . : 192.168.4.103
Subnet Mask . . . . . : 255.255.255.0
Default Gateway . . . . . : 192.168.4.1
DHCP Server . . . . . : 192.168.4.1
DNS Servers . . . . . : 167.206.3.139
                        167.206.3.138
                        167.206.3.205
Lease Obtained. . . . . : Friday, January 12, 2007 2:05:06 PM
Lease Expires . . . . . : Saturday, January 13, 2007 2:05:06 PM

Ethernet adapter Local Area Connection:

Media State . . . . . : Media disconnected
Description . . . . . : Marvell Yukon 88E8036 PCI-E Fast Eth
ernet Controller
Physical Address. . . . . : 00-A0-D1-32-7D-C8

C:\Documents and Settings\Paul Lynch>

```

In the example the address scheme is 192.168.4.xxx, This is known as a "Dot 4" network. The default gateway, which is the LAN's doorway to the internet is 192.168.4.1. The suggested static IP address for the voice mail system is 192.168.x.99. This is because most DHCP servers assign non-static IP addresses starting at 192.168.x.1 or 192.168.x.100 so 192.168.x.99 should not become a conflict. In almost all cases, the subnet mask address will be 255.255.255.0, and it should not be changed. Also, it is a good idea not to change the default DNS server which, at default is set to 168.95.1.1.

Step 2:

The following steps are used to update the voice mail's IP address. The default is 192.168.0.220 which is a "Dot Zero" network. If the network is already a Dot Zero, then you may skip this step, or you may reenter the IP Address as 192.168.0.99.

To enter Voice Processing Administration Programming, from an idle digital telephone;

1. Dial 7*
2. During the Main Auto attendant Greeting, enter 7 **
3. Enter 1 for the company ID (always use 1)
4. Enter 1 to confirm company ID
5. Enter 123456 for the Admin Password (Default Password)
6. Dial 2 for advanced settings
7. Dial 6 for LAN Port Assignment
8. Dial 1 to review the IP Address
9. Dial 1 to listen or 2 to enter a new address
10. Enter the new address - Dial 192*168*x*99# - where "x" equals the "Dot Network", at default the voice mails network scheme is a Dot Zero, the example shows a Dot 4 network scheme. The voice mail will announce the entry as one-nine-two-dot-one-sixty - eight-dot-x-ninty nine.
11. If the Networks' Subnet mask is 255.255.255.0, there is no need to access this setting.
12. There is no need to access the default gateway, it can be entered after connecting with an Internet Browser.

Step 3:

Using a standard Web browser such as Microsoft's Internet Explorer, enter the default or new IP Address. There is no need to put "www" just enter the number.

192.168.x.99

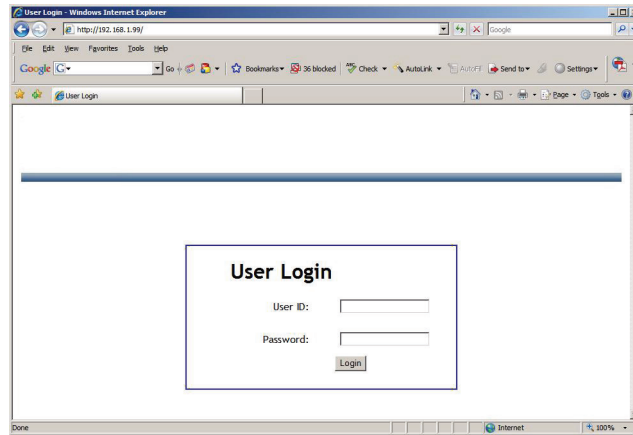
**TCP/IP Login**

Once connected to the voice processing system the Login Screen will be displayed:

User Name: admin

Password: 0000 (four zeros)

Main Programming Menu

There are nine menu options on the main menu which can be used to program the voice processing system.



System

Use the System Settings to change TCP/IP addresses and define a CO Line access code.

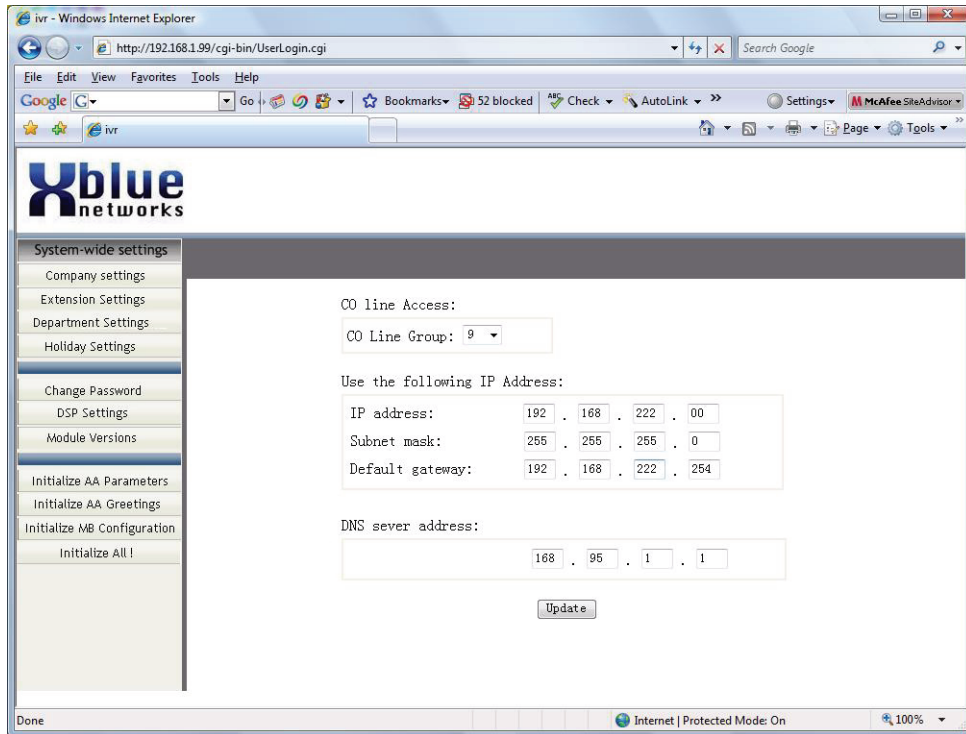

General

General Settings will affect all of the global settings in the voice processing system. This includes parameters such as the office schedule for Office Hours, Break Time, and Saturday Hours, the System Password, Language (only english is supported at this time), Day and night Operator extension.

General Company Settings

Company 1 Configuration.

Settings

	Start	End
Office Hours	08 :00	17 :00
Break Time	00 :00	00 :00
Saturday Hours	00 :00	00 :00
Emergency	Jan 01 00 :00	Jan 01 00 :00
Admin Password	•••••• (6 digits)	
Auto Attendant Language	English	
Operator Code	0	
Configuration Code	7**	
Voice Mail Access Code	*	
Dept Code	711	
Ext Code	712	
Language 1		
Language 2		
Language 3		
Language 4		
Language 5		
Language 6		
Day	10	
Night	10	
Operator Voice Mail	<input checked="" type="radio"/> Yes <input type="radio"/> No	
Digits Length	2	
Days to Keep Message	30	
After Message is Left	Operator	
Call Out Latch	Open	
MAX Error	5	
Error Max Exceeded	2 (1:hangup, 2:operator)	
SMTP Mail Servers	<input checked="" type="radio"/> Default Mail Server <input type="radio"/> User Defined Mail Server	

Update

Extension

The Phone extension parameters are set for individual extensions. The Extension that is to be programmed is located in the "EXT No. Drop down Table". If the extension does not exist, just press "Add New" and create the new extension.

Phone Extension Configuration Settings

Total Number of Extensions = 31 Company 1 Configuration.

Ext No.

Ext No. 10 Configuration Settings

Name	<input type="text" value="1"/>
Leave Message	<input type="radio"/> On <input checked="" type="radio"/> Off
Password	<input type="text" value="••••"/> (4 digits)
Language	English <input type="button" value="v"/>
Reject	<input type="radio"/> Reject <input checked="" type="radio"/> Allow
Ring Extension	<input type="text" value="10"/>
Assistant Extension	<input type="text"/>
Beeper Enable	<input type="radio"/> Enable <input checked="" type="radio"/> Disable
Beeper Number	<input type="text"/> (20 digits)
Beeper Call Delay	5 <input type="button" value="v"/>
Beeper Call Code	1 <input type="button" value="v"/>
Digits to Display On Beeper	<input type="text"/> (20 digits)
Mobile Enable	<input type="radio"/> Enable <input checked="" type="radio"/> Disable
Mobile Phone Number	<input type="text"/> (20 digits)
Voice Mail Enable	<input checked="" type="radio"/> Enable <input type="radio"/> Disable
Call Out Enable	<input checked="" type="radio"/> Enable <input type="radio"/> Disable
E-mail Address	<input type="text"/>

DSP

The DSP parameters should not be changed without the direction of a factory technical support Representative.

DSP Cadence And Frequency Settings

DSP Settings:

Channel: 1 2 3 4 5 6 7 8 9 10 11 12

Cadence and Frequency:

- Frequency dial-tone 350hz+440hz, busy-tone 480hz+620hz, ringback-tone to be filled.
- Frequency dial-tone 450hz, busy-tone 450hz, ringback-tone to be filled.
- Cadence dial-tone continuous, busy-tone 500ms on, 500ms off, ringback-tone 1sec on 3sec off.
- Cadence dial-tone continuous, busy-tone 250ms on, 250ms off, ringback-tone 1sec on 3sec off.

Change Admin Password

At default the admin password is 123456 and can be changed to any 6 digit number from 000000 to 999999.

Change Admin Password

Current Password	<input type="text"/>
New Password	<input type="text"/> (6 digits)
Re-Enter New Password	<input type="text"/>
<input type="button" value="Change"/>	

Department

At default there are 5 predefined Departments. These departments are used with the Auto Attendant to transfer callers to a group (Department) of extensions. The dial codes 82 ~ 86 represent hunt groups, which can be programmed in the telephone system. (See Hunt Group Programming 6-02)

Department Settings

Company 1 Configuration.

Dept No.

	Dept No.	Ext No. (HuntGroup)
1	72	82
2	73	83
3	74	84
4	75	85
5	76	86

Holiday

The system has one "Holiday Greeting" which can be played for any programmed holiday date. The message will begin playing at midnight, the evening of the programmed date, and continue until midnight the day of the holiday. Once the date are programmed, the holiday message will automatically play during the programmed dates.

Holiday Settings

Company 1 Configuration.

Jan ▾ 01 ▾ 2006 ▾ [View diff Year List](#) [Add](#)

Holiday of 2006 :

	Date	Delete
1	0101	<input type="radio"/>
2	0704	<input type="radio"/>

Version

The version parameter shows the software version levels of all four voice processing engines which make up the voice processing system.

IVR System Version: [IVRSYS2006Q1.F05](#)

IVR AA Version: [1.3.3-14a](#)

IVR Web Version: [IVRWEB2006Q1.F02](#)

IVR VOX Version: [IVRvox2006Q1.F04](#)

Email Delivery Setup

The voice mail system must be connected to the Local Area Network (LAN) and accessible using a standard Internet Browser such as Internet Explorer.

The default SMTP Server will work for many installations, as long as the Internet Service Providers (ISP) does not require their users to authenticate, login, before allowing them to send or receive an E-mail message. If the ISP does not require authentication, then skip directly to "Extension" and begin entering the users E-mail addresses.

Although there is no comprehensive list of which ISP requires authentication and which ones do not, so it is a good idea to understand how to set up the voice mail using both the default and user defined SMTP servers. To begin, the voice mail will need to have its own E-mail address and password, so that it can authenticate with the ISP.

Step 1:

Decide and establish, the email address that the voice mail system will use to authenticate on the ISP. The email address should be personalized, using something like voice-mail@yourcompanyname.com or myvoicemail@verizon.net. The next thing needed is the URL (Name) of the ISP's E-mail's log in screen as well as the name IP address, so that it can be entered into the voice mail system. This information can be found by looking at the E-mail setup on a computer connected to the Local Area Network.

If outlook is being used:

Open Outlook - select tools --> email accounts --> view or change existing email accounts --> select the view button and then select the change button. The following will be displayed. Make note of the "Outgoing mail server (SMTP) address. This is the address that will be entered into the voice mail system so that it can copy voice mail messages into the users email accounts.

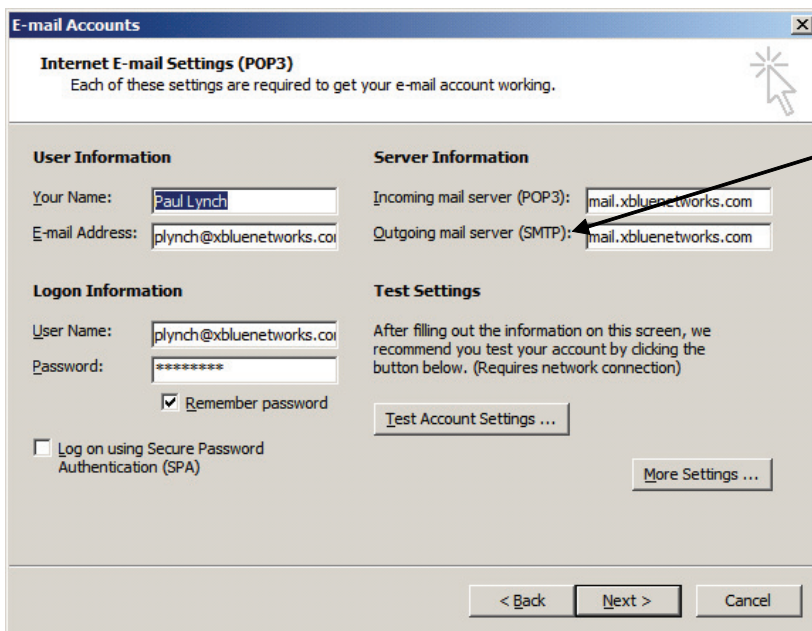

SMTP Address

Step 2:

It is possible to find the actual IP Address using the server information found in the "Outgoing mail server (SMTP):" Occasionally, the voice mail will not take the SMTP server's name that name must be converted to an actual IP Address. To convert a name such as netmail.verizon.net into an IP Address, use the following:

Go to Start --> Run

When the Run Box comes up, enter CMD.

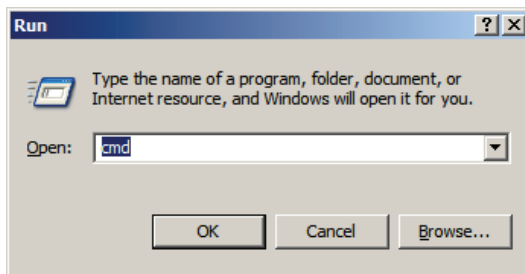

Press "OK"

In the "DOS" window type

In the "DOS" window type: Ping, and then the IPS's SMTP Address such as "netmail.verizon.net". Below, you will see "ping netmail.verizon.net [206.46.232.9] with 32 bytes of data:". This line confirms that the netmail.verizon.net is a valid location and it gives us the IP Address 206.46.232.9, which is the IP Address of netmail.verizon.net.

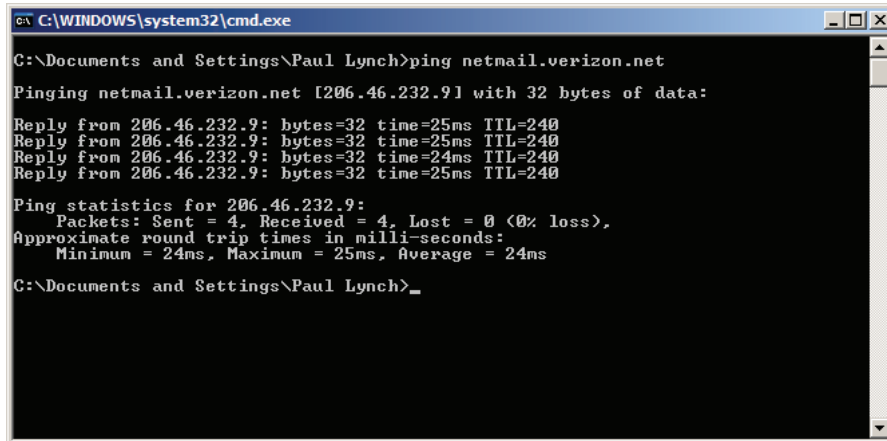

```

c:\ C:\WINDOWS\system32\cmd.exe
C:\Documents and Settings\Paul Lynch>ping netmail.verizon.net
Pinging netmail.verizon.net [206.46.232.9] with 32 bytes of data:
Reply from 206.46.232.9: bytes=32 time=25ms TTL=240
Reply from 206.46.232.9: bytes=32 time=25ms TTL=240
Reply from 206.46.232.9: bytes=32 time=24ms TTL=240
Reply from 206.46.232.9: bytes=32 time=25ms TTL=240

Ping statistics for 206.46.232.9:
    Packets: Sent = 4, Received = 4, Lost = 0 (0% loss),
    Approximate round trip times in milli-seconds:
        Minimum = 24ms, Maximum = 25ms, Average = 24ms
C:\Documents and Settings\Paul Lynch>_
  
```

The following is a list of known ISP IP Addresses:

TABLE 7.2 Known ISP IP Addresses

ISP	URL	IP Address
Comcast	smtp.comcast.net	204.127.3225.17
Embarq	smtp.embarqmail.com	208.41.184.3
Optonline	mail.optonline.net or webmail.optonline.net	197.206.5.250
Verizon	smtp.verizon.net or outgoing.verizon.net or netmail.verizon.net	209.46.232.9
AOL	mail.aol.com	64.12.50.151
Roadrunner	mail.adelphia.net	68.168.78.100

Step 3:

Using a web browser, Internet Explorer access the voice mail by entering the voice mail's IP Address 192.168.x.99.

Select the "Company Settings" button, which is found on the left hand side of the window. Scroll down and select "User Defined Mail Server" in the Email box. and click on the radio button, this will allow information to be entered into the boxes.

Email	
<input type="radio"/>	Default Mail Server
<input checked="" type="radio"/>	User Defined Mail Server

Click in the "User defined SMTP Mail Server" box and enter either the ISP name or IP Address.

User defined SMTP Mail Server	<input type="text"/>
Sender E-mail Address	<input type="text"/>
Sender E-mail Password	<input type="text"/>

Enter the voice mail's email login address, which must be established as described above, then enter the password that will authenticate the voice mail system as a "user". Then click on update.

Step 4:

Select the "Extension Settings" button and select the extension, at default extension 10 will be the first to be modified. Enter each extensions email address, and click update, and select the next email address until all of the email addresses have been entered. Remember to click "update" after each entry.

Voice Processing Programming Flow

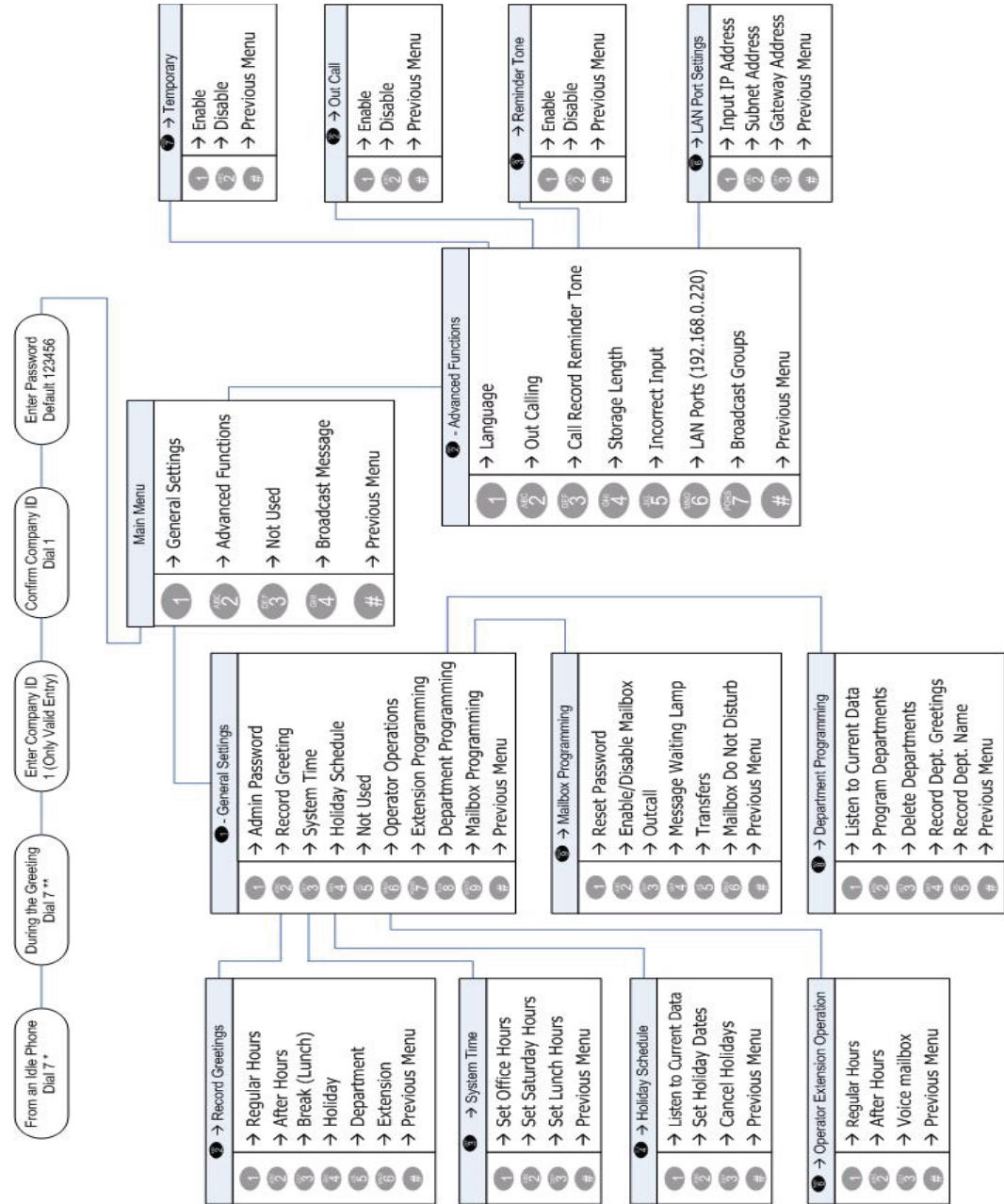

Notes:

Notes:

7

A

- Access Specific CO Line 531
- Accessing Individual CO Lines 534
- Account Code 531, 534, 5171
- Alarm 562
 - System 598
- All Ring Hunt Group 575
- Alternate Attendant 4147
- Alternate Ring Time 3136
- Analog Extensions 425
- analog extensions 25
- Answering Machine Emulation 531, 534
- Attendant 531, 535, 4146
 - Alternate 4147
- Attendant Administration 531, 536
- Authority Code 531
- Authority Codes 540
- Automatic Hold 541
- Automatic Hold Allow 531
- Automatic Record 542
- Automatic Selection 531, 543
- Auxiliary Lamp 543

B

- Background Music 530, 531, 544
- Basic Programming Navigation 0107
- Basic System 29
- Basic Tools 417
- BB Call Pause 3139
- Beep 2 Allow 1119
- BGM 25
- Busy Lamp Field (BLF) 545
- Busy Ring Allow/Deny 531, 545

C

- Cable Length 423
- Call Back 531, 546
- Call Duration Timer 547
- Call Extension 530
- Call Forward 531, 548
 - Busy 548
 - CO Lines Only 548
 - External 548
 - Follow Me 548
 - Idle 548
 - Intercom and CO Line 548
 - Intercom Only 548
 - No Answer 548
- Call Log 530, 551
- Call Park 531, 549
- Call Pickup Directed 531
- Call Pickup Group 531, 550

- Call Wait Allow/Deny 532
- Call Waiting Enable/Disable 552
- Caller ID 25, 551
- Caller ID (CID) 532
- Camp On
 - CO Line 552
- Camp On (Busy CO Line) 532
- Camp On (Busy Extension) 532
- Central Office lines 25
- CFW Auxil Lamp 1118
- CID
 - Country Code 3141
 - International Prefix 3141
 - Local Area Code 3142
 - Long Distance Prefix 3142
 - Repeater Modulation 4161
 - Wait CID_T 3141
- CID Mode 2128
- Class Of Service 1112, 5169
 - CO Line 2123, 2124
- CO Line 2123
 - Line Group 2126
- CO Line Class of Service 5169
- CO Line Copy 4154
- CO Line Flash 3132
- CO Line Group Access 532
- CO Line Installation 423
- CO Line Interface 315
- CO Line Type 2125
- CO Lines 425
- Conference 532, 553
- configuration 25
- Copy
 - CO Line 4154
 - Extension 4155
 - Feature Keys 4160
- Country Code 3141
- Cross-Over Cable 7207

D

- Data Rate 532, 554
- Day to Night Mode 554
- Day/Night Mode 532
- DB Password 4149
- Default Flexible Button 555
- Default Flexible Buttons 532
- Default Setting 532
- Default Settings 555, 1118
- Dial Tone Detection 4158
- Dial Tone Wait 4159
- Dialing Type 2124
- Digit Comparison Table 5173

Digit Modification Table 5173
Digital Extensions 25, 425
Dimensions 313
Direct Station Select (DSS) 545
Directed Call Pick Up 532
Distinct Tone
 Ringing 2126
Distinctive Ring 532
Distinctive Ring Tone 556
Do Not Disturb (DND) 532
Do Not Disturb Allow/Deny 1118
Do-Not-Disturb 556
 Override 557
Door Phone 530
Door Phones 421
Door Relay 421
Door Sensor 421
DTMF Tone 3140

E

Enhanced Lettering Scheme 558
Exclusive Hold 541
Exclusive Hold Time 3132
Expansion Module 419
Expansion Module (3x8) 210
Extension 55 A187
Extension Class of Service 5169
Extension Copy 4155
Extension Directory 1111
Extension Feature Status 532
Extension Feature Status Check 559
Extension Group 1114
Extension Groups 560
Extension Password - Phone Lock 532
Extension Pickup Groups 561
Extension Position 1116
Extension Programming Copy 561
Extension Reminder 532, 562
Extension Reminder Delete 532
Extension Swapping 562
Extension User Name 563
External Call Forward
 System 3143
External Music Source 564
External Page 420
External Paging 564
External Paging Port 25

F

FAX Detection 565
FAX XFR To 2127
FCC Registration 12

Feature Code List 530
Feature Codes 531
Feature Key 565
Feature Key Allow 1116
Feature Key Copy 4160
Flash
 CO Line 3132
 PBX 3132
 Single Line Telephone 593
Flash - PBX 568
Flash (PBX/CO) 532
Flash = CO Line 568
Flash CO Line
 SLT 594
Flash Recognition 567
Flexible Feature button Programming 532
Flexible Feature Buttons 569
Front End Auto Attendant 7192

G

Gain
 RX 2127
 TX 2128
General Settings 7197
Group Call Pickup 532

H

Headset Enable/Disable 532
Headset Jack 571
Hold
 System 571
Hold Reminder 572
Hold Retrieve (SLT) Different Extension 532
Hold Retrieve (SLT) Same Extension 532
Holding Call Answer 572
Hook Dialing 584
Hot Dial 532
Hot Key Pad 573, 584
Hour Mode Format 574
Hunt Group Answer 2124
Hunt Groups 574
Hunt Method 3139

I

ICM Mode 1117
Incoming Drop 1115
Incoming Filter 4167
Incoming Filter R 538
Incoming Filter U 538
Initialization Procedure 427
Installation Planning 418
Integrated Door Phone 25

Index

Intercom Call Back 532, 576
Intercom Calling 575
International Prefix 3141
Intrusion 577, 3131
Intrusion Tone 3131

K

KSU Revision 4159

L

Last Number Redial 532, 578
LCR 5173
LCR Time 3144
Least Cost Routing 533, 579, 5173
Letter Type 4145
Line Assignment 1113
Line Call Discrimination 5169
Line Copy 4154
Line Group 2126
Line Type 2125
Linear Hunt Group 574
Local Area Code 3142
Location 1116
Long Distance Prefix 3142
Loud Bell 579, 2125
Loud Bell Contact 25, 419

M

Maximum Cable Length 315
MDF Patch Panel 424
Menu Bypass Code 0107
Message
 Text 599
Message Waiting 533, 581
Messages
 Outgoing 4151
 Status 4151
Messaging
 Premises 580
Modem A187
Modem Extension 581
Modem Number 4147
Module Installation 419
Monitor 582
Monitor - Extension 533
Monitor Class of Service 1112
Mounting 313
Multiple Mailbox Button 533
Music On Hold 423
Music Source 4159
Music-On-Hold 583
Mute 533, 583

Muted Ringing 591

N

Navigation Keys 530
Night Mode (Attendant) 533

O

Off-Hook Voice Announce 584
One Touch Transfer 585
Operating Environment 314
Operator 546
Operator Code 3138
Option Module 211, 419, 592
Option module 25
Option Port Function 4162
Option Relay Function 4166
Option Sensor Function 4164
Outgoing Drop 1115
Overflow Auto Attendant 7193

P

Page 530, 533, 585
 All 585
 Allow/Deny 586
 External 585
 Internal 585
 Internal All Call 585
 Meet Me 586
Page Allow/Deny 533
Page Answer (Meet Me) 533
Part Numbers 25
Password Dial Table 5171
Pause 533, 587
Pause Insertion 587
Pause Time 3133
PBX Auto Pause 3134
PBX Code 3133
PBX Flash 3132
Peripheral Connections 27
Phone Lock 533, 560, 587
Phone Unlock 587
Power Requirements 313
Pre-CFW 1119
Predefined Call Forward 1119, 2128
Preprogrammed Messages 0108
Primary Navigation Keys 4151
Privacy Release 588, 2129
Private 588
Private To 589, 2126
Pulse to Tone 533
Pulse to Touch Tone 589

R

Recall Feature 590
Recall Time 3136
Receive Assignment 1113
Record Allow 1117
Relay Control 533, 592
Relays 25
Remind Time 3133
Reminder
 System 4147
Reminder Tones 590
Remote Programming Disconnect A189
Remote Programming Software 25
Ring Assignment 1114
Ring Scheme 4145
Ringer Equivalence 12
Ringing Level 591
Ringing Line Priority 591
RMT X_Rate 4157
RS232c 25

S

Safety Guidelines 417
Save Dialed Number 533
Saved Number Redial 593
Security Alarm Action 4165
Security Control 533
Security Control Sensor 595
Security Sensors 25
Sensor Function 539
Service Mode 4162
Service Mode Switching 536
Shutdown Procedure 7193
Shutdown Procedure VPS 7193
Single Pair 423
SLT
 Hook-Switch Flash 3137
Small Business Voice Processing System 212
SMDR 25
SMDR Output 3138
SMDR Time 3138
SMDR X_Rate 4158
Speakerphone 595
Speed Dial 596
Speed Dialing (Abbr Dialing) 533
Speed Dialing (SLT) 533
Station Copy 4155
Station Message Detailed Recording 426
Status Message 533, 597
Storage Length 7206
System
 External Call Forward 3143

Hold 571

System Abbr Check 1117
System Abbr Number 4153
System Configuration 28
System Configuration Maximum 314
System Ground 422
System Hardware 26
System Reminder 598, 4147
System Speed Dial 530
System Time 4157
System Time and Date 0110

T

TCP/IP Addresses 7212
TCP/IP Login 7213
TCP/IP Main Menu 7214
Text Message 599
Time Switching 4148
Toll Restriction 5169
Tone Sender 3137
Tone Time 3134
Touch Tone On/Off 5100
Touch Tone on/off 533
Transfer 5100
 Screened 5100
 Unscreened 5100
Transfer Beep 533, 5101

U

UART Type 4160
User Name 4150
User Password 4149

V

Voice Announce 5102
Voice Announce Mode, 570
Voice Call Allow/Deny 533
Voice Call Recorder 5103
Voice Mail 533
Voice Mail Call Flow 7194
Voice Mail Dialing Ratio 3134
Voice Mail Hunt Group 575
Voice Mail Monitor Time 3140
Voice Mail Reserve Port 3140
Voice Mail Shutdown 540
Voice Mail System 5104
Voice Processing
 Admin Password 7198, 7218
 Advanced Settings 7205
 After Hours Greeting 7198
 Break Greeting 7198
 Break Time 7215

Index

- Broadcast Groups 7207
 - Department Directory Greeting 7198
 - Department Extensions 7219
 - Department Mailboxes 7219
 - Department Programming 7202
 - DSP 7218
 - Extension Menu Greeting 7198
 - Extension Programming 7201
 - General Settings 7197, 7215
 - Holiday 7220
 - Holiday Greeting 7198
 - Holiday Schedule 7200
 - Incorrect Input 7206
 - LAN Port 7206
 - Language 7215
 - Mailbox Settings 7204
 - Enable/Disable 7204
 - Mailbox Do Not Disturb 7205
 - Message Wait Lamp 7204
 - Out Calling Allow/Deny 7204
 - Reset Password 7204
 - Transfer 7204
 - Main Menu 7196, 7214
 - Office Hours 7215
 - Operator Extension 7200, 7215
 - Operator Mailbox 7200
 - Operator Operations 7200
 - Out Calling 7206
 - Phone Extension 7217
 - Programming Flow 7225
 - Programming with TCP/IP 7207
 - Record Greetings 7198
 - Regular Hours Greeting 7198
 - Saturday Hours 7215
 - Set Lunch Hours 7199
 - Set Office Hours 7199
 - Set Saturday Hours 7199
 - Software Version 7220
 - System Password 7215
 - System Settings 7215
 - System Time 7199
 - Virtual Extension 7201
 - Voice Processing Menu 7195
 - Voice Processing System 25, 421, 5104, 7191
 - Voice Recording 533
 - Volume Control 5105
 - Volume Limit 4161
 - VPS
 - Administrative Programming 7195
- W**
- Wait CID_T 3141

- Warning Time 3135
- Warning Tone 5106, 1114
- Wiring 314
- Wiring Procedure 424



Copyright©

MENU / DATA FIELD	MBC Code	RANGE	Default
1.EXTENSION	1		
SHOW EXT			
DAY CLASS	1-SN-(10~37)		
NITE CLASS	1-SN-01	0~7	0
MONITOR COS	1-SN-02	0~7	0
LINE ASSIGNMENT	1-SN-03	0~9	5
LINE 1~9	1-SN-04-(01~09)	Y/N	Y
RECEIVE ASSIGNM	1-SN-05-		
LINE 1~6	1-SN-05-(01~09)	Y/N	Y
RING ASSIGNMENT	1-SN-06-		
DAY ALLOWED	1-SN-06-1	Y/N	Y
NITE ALLOWED	1-SN-06-1(01~09)	Y/N	Y
EXT GROUP	1-SN-06-2	Y/N	N
WARNING TONE	1-SN-07		1
OUTGOING DROP	1-SN-08	Y/N	N
INCOMING DROP	1-SN-09	Y/N	N
LOCATION	1-SN-10	Y/N	N
EXT POSITION	1-SN-11		
FTR KEY ALLOW	1-SN-12	Y/N	Y
SYS ABBR CHECK	1-SN-13	Y/N	Y
ICM MODE	1-SN-14	Y/N	Y
RECORD ALLOW	1-SN-15	PAGE/RING	PAGE
CFW AUX LAMP	1-SN-16	Y/N	Y
DEFAULT SETTING	1-SN-17	Y/N	Y
DND FUNC ALLOW	1-SN-18	Y/N	Y
BEEP 2 ALLOW	1-SN-19	Y/N	Y
PRE-CFW	1-SN-20	Y/N	Y
PRE-FWD TIMER	1-SN-21	NULL, 10~37, 82~89	87 (VM)
ECF ALLOW	1-SN-22	06~120	18
IVR PROMPT	1-SN-23	Y/N	N
FORCED LCR	1-SN-24	Y/N	Y
	1-SN-25	Y/N	N

2.CO LINE	2		
SHOW LINE			
DAY CLASS	2-LN-(01~09)		
NITE CLASS	2-LN-01	0~7	0
HUNT GROUP ANS	2-LN-02	0~7	0
DAY POSITION	2-LN-03-1	0~8	0
NIGHT POSITION	2-LN-03-2	0~8	0
DIALING	2-LN-04	TONE/PULSE	TONE
LINE TYPE	2-LN-05	CO/PBX/HOTLINE/PAGE/EMPTY	CO
LOUD BELL	2-LN-06	Y/N	N
LINE GROUP	2-LN-07	1~6	1
PRIVATE TO	2-LN-08	NULL, 10~37, 82~89	NULL
DISTINCT TONE	2-LN-09	0~8	0
FAX TRANSFER TO	2-LN-10	NULL, 34~37	NULL
GAIN (RX):	2-LN-11	-00db, -03db, -06db, -09db, -12db	-03db
GAIN (TX):	2-LN-12	-00db, -03db, -06db, -09db, -12db	-03db
DTMF DISABLE	2-LN-13	00, 05, 10, 15, 20, 30, 40, 50, 60, 70, 80, 90	00
CID MODE	2-LN-14	FSK/DTMF	FSK
PRESET CALL FORWARD	2-LN-15		
DAY POSITION	2-LN-15-1	NULL, 10~37, 82~89	NULL
NIGHT POSITION	2-LN-15-2	NULL, 10~37, 82~89	NULL
PRE-FWD TIMER	2-LN-15-3	06~120 seconds	12
PRIVACY RELEASE	2-LN-16	Y/N	N

MENU / DATA FIELD	MBC Code	RANGE	Default
3.CALL HANDLING	3		
INTRUSION	3-01	Y/N	Y
INTRUS. TONE	3-02	Y/N	Y
EX_HOLD TIME	3-03	1~8 MINUTES	1
PBX FLASH	3-04	0.1, 0.2, 0.3, 0.4, 0.5, 0.6, 0.7, 0.8, 0.9, 1.0, 1.1, 1.2, 1.3, 1.4, 1.5, 2.0, 2.5, 3.0	0.7
CO FLASH	3-05	0.1, 0.2, 0.3, 0.4, 0.5, 0.6, 0.7, 0.8, 0.9, 1.0, 1.1, 1.2, 1.3, 1.4, 1.5, 2.0, 2.5, 3.0	0.7
REMINd TIME	3-06	0, 10, 30, 60, 90	60
PAUSE TIME	3-07	1.5, 2, 3, 5, 5	1.5
PBX CODE	3-08	0~9, 00~99	9
PBX AUTO PAUSE	3-09	1~9	2
TONE TIME	3-10	70, 90, 120, 150, 200	70
VM DIALING RATIO	3-11		
TONE TIME	3-11-1	60, 90, 120, 150	90
INT_DGT TIME	3-11-2	60, 90, 120, 150	90
WARNING TIME	3-12		
OUTGOING	3-12-1	01, 02, 03, 04, 05, 06, 07, 08, 09, 10, 15, 20, 25, 30	05
INCOMING	3-12-2	01, 02, 03, 04, 05, 06, 07, 08, 09, 10, 15, 20, 25, 30	05
RECALL TIME	3-13	10, 16, 30, 60, 90, 120	30
ALT RING TIME	3-14	10, 20, 30, 40, 50, 60	30
TONE SENDER	3-15	Y/N	Y
SLT HOOK FLASH	3-16		
START	3-16-1	60, 100~1400	200
END	3-16-2	300~1500	1500
OPERATOR CODE	3-17	0, 9	0
SMDR TIME	3-18	01~25	10
SMDR OUTPUT	3-19	38795	
OUTGOING CALL	3-19-1	Y/N	Y
INCOMING CALL	3-19-2	Y/N	N
HUNT METHOD	3-20	SEQL, RAN, SEQF	SEQUENTIAL LAST (SEQL)
BB CALL PAUSE	3-21	0~9	0
VM MON TIME	3-22	0, 10, 20, 30, 40, 50, 60	20
VM RESRV PORT	3-23	0, 01~48	0
DTMF TONE	3-24	Y/N	Y
WAIT_CID_T	3-25	0, 0.5, 1~8	0.5
INTER. PREFIX	3-26		
COUNTRY CODE	3-26-1	0000~9999	NULL
	3-27		
LONG DIST PREFIX	3-27-1	0000~9999	NULL
	3-28		

MENU / DATA FIELD	MBC Code	RANGE	Default
3.CALL HANDLING (cont.)			
	3		
LOCAL AREA CODE	3-29		
AREA CODE 1	3-29-01	00000-99999	NULL
AREA PREFIX 1	3-29-02	00000-99999	NULL
AREA CODE 2	3-29-03	00000-99999	NULL
AREA PREFIX 2	3-29-04	00000-99999	NULL
AREA CODE 3	3-19-05	00000-99999	NULL
AREA PREFIX 3	3-29-06	00000-99999	NULL
AREA CODE 4	3-29-07	00000-99999	NULL
AREA PREFIX 4	3-29-08	00000-99999	NULL
AREA CODE 5	3-29-09	00000-99999	NULL
AREA PREFIX 5	3-29-10	00000-99999	NULL
AREA CODE 6	3-29-11	00000-99999	NULL
AREA PREFIX 6	3-29-12	00000-99999	NULL
AREA CODE 7	3-29-13	00000-99999	NULL
AREA PREFIX 7	3-29-14	00000-99999	NULL
AREA CODE 8	3-29-15	00000-99999	NULL
AREA PREFIX 8	3-29-16	00000-99999	NULL
EXTERNAL CFW	3-30		
ACTIVE LINE	3-30-1	NULL, 01-09	NULL
SERVICE	3-30-2	ALWAYS, NEVER, DAY, NIGHT	ALWAYS
TALK TIME	3-30-3	00-99	05
LCR TIME	3-31	1, 0, 1.5, ..., 8.0	3.0
4.RESOURCE			
	4		
RING SCHEME	4-01	0-9	3
LETTER TYPE	4-02	0-5	0
ATTENDANT	4-03	10-37	10
ALTERNATE	4-04	NULL, 10-37	NULL
MODEM NO.	4-05	NULL, 10-37	55
SYSTEM REMINDER (ALARM)	4-06		
ALARM (1~8)	4-06-(1~8)	NULL, 00:00-23:59	NULL
TIME SWITCHING	4-07		
MONDAY	4-07-1	NULL, 00:00-23:59	
NOON START	4-07-1-1	NULL, 00:00-23:59	NULL
NOON END	4-07-1-2	NULL, 00:00-23:59	NULL
NIGHT START	4-07-1-3	NULL, 00:00-23:59	17:00
NIGHT END	4-07-1-4	NULL, 00:00-23:59	08:00
TUESDAY	4-07-2-x		
WEDNESDAY	4-07-3-x		
THURSDAY	4-07-4-x		
FRIDAY	4-07-5-x		
SATURDAY	4-07-6-		
NIGHT START	4-07-6-1	NULL, 00:00-23:59	NULL
NIGHT END	4-07-6-2	NULL, 00:00-23:59	NULL
SUNDAY	4-07-7-		
NIGHT START	4-07-7-1	NULL, 00:00-23:59	NULL
NIGHT END	4-07-7-2	NULL, 00:00-23:59	NULL
DB Password	4-08	000000 ~ 9999999	0
USER PASSWORD	4-09		
EXTENSION	4-09-SN	0000-9999	0
ATTENDANT	4-09-Attendant ext #	0000-9999	9999
USER NAMES	4-10		
EXTENSION	4-10-SN	NULL, Aa-Zz, 0-9	NULL

MENU / DATA FIELD		MBC Code	RANGE	Default
4.RESOURCE (cont.)				
4				
PREPROG MESSAGE	4-11			
OUTGOING MESSAGE	4-11-1-1		NULL, Aa~Zz, 0~9	HAVE A GOOD DAY
	4-11-1-2		NULL, Aa~Zz, 0~9	CALL OPERATOR
	4-11-1-3		NULL, Aa~Zz, 0~9	CALL HOME
	4-11-1-4		NULL, Aa~Zz, 0~9	CALL BACK
	4-11-1-5		NULL, Aa~Zz, 0~9	FRIEND VISITING
	4-11-1-6		NULL, Aa~Zz, 0~9	URGENT
PREMISES MESSAGE	4-11-2-1		NULL, Aa~Zz, 0~9	OUT FOR LUNCH
	4-11-2-2		NULL, Aa~Zz, 0~9	BE BACK SOON
	4-11-2-3		NULL, Aa~Zz, 0~9	LEFT FOR THE DAY
	4-11-2-4		NULL, Aa~Zz, 0~9	IN A MEETING
	4-11-2-5		NULL, Aa~Zz, 0~9	OUT OF OFFICE
	4-11-2-6		NULL, Aa~Zz, 0~9	ON VACATION
SYSTEM ABBR. NO	4-12-(20-99)		EMPTY, 0~9 (20 DIGITS MAX.)	NULL
LINE COPY	4-13			
EXTENSION COPY	4-14			
SYSTEM TIME	4-15			
YEAR	4-15-1		00~99	2005
MONTH	4-15-2		JAN~DEC	JAN
DAY	4-15-3		01~31	01
WEEKDAY	4-15-4		MON~SUN	MON
HOUR	4-15-5		00~23	01
MINUTE	4-15-6		00~59	01
RMT X_RATE	4-16		9600, 19200, 38400	9600
SMDR RATE	4-17		9600, 19200, 38400	9600
HOUR MODE	4-18		12/24	12
DIAL TONE DET.	4-19		Y/N	N
DIAL WAIT TIME	4-20		1~8	1
MUSIC SOURCE	4-21		EXT	EXT/TON
KSJ REVISION	4-22			
FEATURE KEY COPY	4-23			
UART TYPE	4-24		SMDR/RMP	SMDR
CID RPT MODE	4-25		FSK/DTMF	FSK
VOLUME LIMIT	4-26			
PAGE LEVEL	4-26-1		1~8	6
SPEAKER LIMIT	4-26-2		1~8	8
HANDSET LIMIT	4-26-3		1~8	8
SERVICE MODE	4-27		DAY, NIGHT, TIME	DAY
OPTION PORT FUNCTION	4-28-			
OPTION PORT # (1~2)	4-28-(1~2)			
UTILITY	4-28-x-1		SLT/DOOR	SLT
RING TYPE	4-28-x-2		RING	RING
RING POS(D)	4-28-x-3		10~37, 82~89	88
RING POS(N)	4-28-x-4		10~37, 82~89	88
MAX RING T	4-28-x-5		10, 16, 30, 60, 90, 120	16
UNLOCK CODE	4-28-x-6		1~9, *, #	#
OPEN ANNOUNCE	4-28-x-7		00-60	0
DOOR RELAY (1~4)	4-28-x-8 (show 1~4)		Y/N	N

MENU / DATA FIELD	MBC Code	RANGE	Default
4.RESOURCE (cont.)	4		
OPTION SENSOR FUNCTION	4-29-		
OPTION SENSOR NUMBER (1~4)	4-29-(1~4)		
UTILITY	4-29-x-1	DOOR LOCK1 ~ DOOR LOCK4, SECURITY1 ~ SECURITY4	DOOR LOCK (1~4)
SECURITY PASSWORD	4-29-x-2	0000~9999	0000
SECURITY ALERT DETAILS (ONLY FOR "SECURITY" SETTING)	4-29-x-3-(1~3)		
SECURITY ALARM DELAY	4-29-x-3-1	0~9	0
SECURITY ALARM CANCEL	4-29-x-3-2	0, 10, 16, 30, 60, 90, 120	30
SECURITY ALARM PERIOD	4-29-x-3-3	1~10	1
SECURITY ALARM ACTION	4-30		
SECURITY ALARM ACTION #	4-30-(1~4)		
ALERT MODE	4-30-x-1	RING/VOICE/N	RING
OUTCALL	4-30-x-2-(1~5)		
TRUNK SELECTION	4-30-x-2-1		GROUP 1
OUT CALL PHONE NUMBER	4-30-x-2-2	EMPTY, 0~9 (20 DIGITS MAX.)	EMPTY
MESSAGE LAUNCH	4-30-x-2-3	01~29	03
OUT CALL DURATION	4-30-x-2-4	0.5, 1~9	3
OUT CALL TRIES	4-30-x-2-5	01~19	05
RELAY CONTROL	4-30-x-3-(1~4)	Y/N	N
OPTION PORT RELAY FUNCTION	4-31-(1~4)		
UTILITY	4-31-x-1	D.OPEN, MONITOR, SECURE	DOOR OPEN
DOOR OPEN ON TIME	4-31-x-2	300ms, 500ms, 700ms, 1s, 2s, 3s, 5s, 8s, 10s	500ms
INCOMING FILTER	4-32		
INCOMING FILTER UNRING	4-32-1-(1~2)		
NORING MODE (when NOT to ring)	4-32-1-1	ALWAYS,NEVER, DAY, NIGHT, NOON	NEVER
FILTER PHONE NUMBER	4-32-1-2		
FILTER INDEX NUMBER	4-32-1-2-(0~49)		
PHONE NUMBER	4-32-1-2-xx	0~9, *, # (20 DIGITS MAX.)	EMPTY
INCOMING FILTER RING	4-32-2-(1~2)		
RING MODE (when to ring)	4-32-2-1	ALWAYS,NEVER, DAY, NIGHT, NOON	
FILTER PHONE NUMBER	4-32-2-2		
FILTER INDEX NUMBER	4-32-2-2-(0~49)	0~9, *, # (20 DIGITS MAX.)	EMPTY

MENU / DATA FIELD	MBC Code	RANGE	Default
5.RESTRITION	5		
LINE CALL DISCRIMINATION	5-		
DIGIT INTERVAL	5-1-(001~100)-		
FROM DGT	5-1-001-1	0~9, *, #	0
TO DGT	5-1-001-2	0~9, *, #	#
EXTENSION COS	5-1-001-3		
DAY ALLOWED	5-1-001-3-1	0~7 = Y/N	0=Y, 1~7=N
NIGHT ALLOWED	5-1-001-3-2	0~7 = Y/N	0=Y, 1~7=N
LINE COS	5-1-001-4		
DAY ALLOWED	5-1-001-4-1	0~7 = Y/N	0~7=Y
NITE ALLOWED	5-1-001-4-2	0~7 = Y/N	0~7=Y
FROM DGT	5-1-002-1	0~9, *, #	2
TO DGT	5-1-002-2	0~9, *, #	#
EXTENSION COS	5-1-002-3		
DAY ALLOWED	5-1-002-3-1	0~7 = Y/N	0=N, 1=Y, 2~7=N
NIGHT ALLOWED	5-1-002-3-2	0~7 = Y/N	0=N, 1=Y, 2~7=N
LINE COS	5-1-002-4		
DAY ALLOWED	5-1-002-4-1	0~7 = Y/N	0~7=Y
NITE ALLOWED	5-1-002-4-2	0~7 = Y/N	0~7=Y
FROM DGT	5-1-003-1	0~9, *, #	2
TO DGT	5-1-003-2	0~9, *, #	#
EXTENSION COS	5-1-003-3		
DAY ALLOWED	5-1-003-3-1	0~7 = Y/N	0~1=N, 2=Y, 3~7=N
NIGHT ALLOWED	5-1-003-3-2	0~7 = Y/N	0~1=N, 2=Y, 3~7=N
LINE COS	5-1-003-4		
DAY ALLOWED	5-1-003-4-1	0~7 = Y/N	0~7=Y
NITE ALLOWED	5-1-003-4-2	0~7 = Y/N	0~7=Y
FROM DGT	5-1-004-1	0~9, *, #	1
TO DGT	5-1-004-2	0~9, *, #	1
EXTENSION COS	5-1-004-3		
DAY ALLOWED	5-1-004-3-1	0~7 = Y/N	0~1=N, 2=Y, 3~7=N
NIGHT ALLOWED	5-1-004-3-2	0~7 = Y/N	0~1=N, 2=Y, 3~7=N
LINE COS	5-1-004-4		
DAY ALLOWED	5-1-004-4-1	0~7 = Y/N	0~7=Y
NITE ALLOWED	5-1-004-4-2	0~7 = Y/N	0~7=Y
FROM DGT	5-1-005-1	0~9, *, #	2
TO DGT	5-1-005-2	0~9, *, #	#
EXTENSION COS	5-1-005-3		
DAY ALLOWED	5-1-005-3-1	0~7 = Y/N	0~2=N, 3=Y, 4~7=N
NIGHT ALLOWED	5-1-005-3-2	0~7 = Y/N	0~2=N, 3=Y, 4~7=N
LINE COS	5-1-005-4		
DAY ALLOWED	5-1-005-4-1	0~7 = Y/N	0~7=Y
NITE ALLOWED	5-1-005-4-2	0~7 = Y/N	0~7=Y
FROM DGT	5-1-006-1	0~9, *, #	0
TO DGT	5-1-006-2	0~9, *, #	0
EXTENSION COS	5-1-006-3		
DAY ALLOWED	5-1-006-3-1	0~7 = Y/N	0~2=N, 3=Y, 4~7=N
NIGHT ALLOWED	5-1-006-3-2	0~7 = Y/N	0~2=N, 3=Y, 4~7=N
LINE COS	5-1-006-4		
DAY ALLOWED	5-1-006-4-1	0~7 = Y/N	0~7=Y
NITE ALLOWED	5-1-006-4-2	0~7 = Y/N	0~7=Y

MENU / DATA FIELD	MBC Code	RANGE	Default
5.RESTRICTION (cont.)			
5			
FROM DGT	5-1-007-1	0~9, *, #	0
TO DGT	5-1-007-2	0~9, *, #	0
EXTENSION COS	5-1-007-3		
DAY ALLOWED	5-1-007-3-1	0~7 = Y/N	0~3=N, 4=Y, 5~7=N
NIGHT ALLOWED	5-1-007-3-2	0~7 = Y/N	0~3=N, 4=Y, 5~7=N
LINE COS	5-1-007-4		
DAY ALLOWED	5-1-007-4-1	0~7 = Y/N	0~7=Y
NITE ALLOWED	5-1-007-4-2	0~7 = Y/N	0~7=Y
FROM DGT	5-1-008-1	0~9, *, #	1
TO DGT	5-1-008-2	0~9, *, #	1
EXTENSION COS	5-1-008-3		
DAY ALLOWED	5-1-008-3-1	0~7 = Y/N	0~4=N, 5=Y, 6~7=N
NIGHT ALLOWED	5-1-008-3-2	0~7 = Y/N	0~4=N, 5=Y, 6~7=N
LINE COS	5-1-008-4		
DAY ALLOWED	5-1-008-4-1	0~7 = Y/N	0~7=Y
NITE ALLOWED	5-1-008-4-2	0~7 = Y/N	0~7=Y
FROM DGT	5-1-xxx-1	0~9, *, #	EMPTY
TO DGT	5-1-xxx-2	0~9, *, #	EMPTY
EXTENSION COS	5-1-xxx-3		
DAY ALLOWED	5-1-xxx-3-1	0~7 = Y/N	0~7=Y
NIGHT ALLOWED	5-1-xxx-3-2	0~7 = Y/N	0~7=Y
LINE COS	5-1-xxx-4		
DAY ALLOWED	5-1-xxx-4-1	0~7 = Y/N	0~7=Y
NITE ALLOWED	5-1-xxx-4-2	0~7 = Y/N	0~7=Y
PASSWOR DIAL TABLE			
PASSWOR LENGTH	5-2-1	2~8	3
PASSWORD	5-2-2-(001~150)-		
PSWD	5-2-2-xxx-1	0~9 UPTO MAX.	EMPTY
COS	5-2-2-xxx-2	0~7	0
LCR ENABLE	5-2-2-xxx-3	Y/N	N
LEAST COST ROUTE			
DGT. COMP. TABLE	5-3-1-(001~100)-		
FROM	5-3-1-001-1	001~999, *, #	001
TO	5-3-1-001-2	001~999, *, #	999
LINE GROUP	5-3-1-001-3	1	1
DMT. NO.	5-3-1-001-4	01~24	01
FROM	5-3-1-xxx-1	001~999, *, #	EMPTY
TO	5-3-1-xxx-2	001~999, *, #	EMPTY
LINE GROUP	5-3-1-xxx-3	1	NULL
DMT. NO.	5-3-1-xxx-4	01~24	NULL
DGT. MOD. TABLE	5-3-2-(01~24)-		
DELETE DGT.	5-3-2-xx-1	NULL, 0~9 (2 DIGITS MAX.)	NULL
PREFIX DIGITS	5-3-2-xx-2	0~9, *, # (20 DIGITS MAX.)	EMPTY
INSERT DIGITS	5-3-2-xx-3	0~9 (10 DIGITS MAX.)	EMPTY
INS. POS.	5-3-2-xx-4	NULL, 01~29	NULL

MENU / DATA FIELD	MBC Code	RANGE	Default
6.CONTROL	6		
DATA AUTO ANS	6-1	Y/N	Y
EXT HUNT GROUP	6-2-1-		
HUNT GROUP NUMBER	6-2-1~8-		
GROUP TYPE	6-2-1-1	HUNT, ALL, VM	HUNT
GROUP MEMBER	6-2-1-2(01~24)	NULL, 10~37, 56~67	NULL
GROUP TYPE	6-2-2-1	HUNT, ALL, VM	HUNT
GROUP MEMBER	6-2-2-2(01~24)	NULL, 10~37, 56~67	NULL
GROUP TYPE	6-2-3-1	HUNT, ALL, VM	HUNT
GROUP MEMBER	6-2-3-2(01~24)	NULL, 10~37, 56~67	HUNT
GROUP TYPE	6-2-4-1	HUNT, ALL, VM	HUNT
GROUP MEMBER	6-2-4-2(01~24)	NULL, 10~37, 56~67	NULL
GROUP TYPE	6-2-5-1	HUNT, ALL, VM	HUNT
GROUP MEMBER	6-2-5-2(01~24)	NULL, 10~37, 56~67	NULL
GROUP TYPE	6-2-6-1	HUNT, ALL, VM	VM
GROUP MEMBER	6-2-6-2(01~24)	NULL, 10~37, 56~67	56~67
GROUP TYPE	6-2-7-1	HUNT, ALL, VM	ALL
GROUP MEMBER	6-2-7-2(01~24)	NULL, 10~37, 56~67	10~33
GROUP TYPE	6-2-8-1	HUNT, ALL, VM	ALL
GROUP MEMBER	6-2-8-2(01~24)	NULL, 10~37, 56~67	10~33
VOICE MAIL	6-3		
VM HUNT GROUP	6-3-1	0~8	6
AUTO RECORD EXT	6-3-2-		
1~8	6-3-2(1~8)	NULL, 10~37	NULL
DRY CONTACT	6-4	L.B. / EXT / PAGE	LOUD BELL
LOCATION TO DIR	6-5	10~37	
DIR TO LOCATION	6-6	NA	
SYS WARM START	6-7	NA	ARE YOU SURE?
SYS COLD START	6-8	NA	WHOA DUDE