

Go to
businessphones.vtech.com
to register your product for
enhanced warranty support and
latest VTech product news.

UP416
ErisBusinessSystem™
4-Line Office Phones
Main Console



vtech®
User's manual

Congratulations

on your purchase of this VTech product. Before using this VTech product, please read the **Important safety information**.

For customer service or product information, visit our website at **businessphones.vtech.com** or call **1 (800) 595-9511**. In Canada, please dial **1 (800) 267-7377**.

Model number: ErisBusinessSystem™ UP416
Type: 4-Line Office Phones Main Console
Serial number: _____
Purchase date: _____
Place of purchase: _____

Both the model and serial numbers of your VTech product can be found on the bottom of the console.

Save your sales receipt and original packaging in case it is necessary to return your telephone for warranty service.

Compatible with
Hearing Aid T-Coil



TIA-1083

Telephones identified with this logo have reduced noise and interference when used with most T-coil equipped hearing aids and cochlear implants. The TIA-1083 Compliant Logo is a trademark of the Telecommunications Industry Association. Used under license.

Important safety information



This symbol is to alert you to important operating or servicing instructions that may appear in this user's manual. Always follow basic safety precautions when using this product to reduce the risk of injury, fire, or electric shock.

Safety information

- Read and understand all instructions in the user's manual. Observe all markings on the product.
- Avoid using a telephone during a thunderstorm. There may be a slight chance of electric shock from lightning.
- Do not use the telephone to report a gas leak in the vicinity of the leak. Under certain circumstances, a spark may be created when the adapter is plugged into the power outlet, or when the handset is replaced in its cradle. This is a common event associated with the closing of any electrical circuit. The user should not plug the phone into a power outlet, and should not put a charged handset into the cradle, if the phone is located in an environment containing concentrations of flammable or flame-supporting gases, unless there is adequate ventilation. A spark in such an environment could create a fire or explosion. Such environments might include: medical use of oxygen without adequate ventilation; industrial gases (cleaning solvents; gasoline vapors; etc.); a leak of natural gas; etc.
- Do not use this product near water, or when you are wet. For example, do not use it in a wet basement or shower, or next to a swimming pool, bathtub, kitchen sink, or laundry tub. Do not use liquids or aerosol sprays for cleaning. If the product comes in contact with any liquid, unplug any line or power cord immediately. Do not plug the product back in until it has dried thoroughly.
- Install this product in a protected location where no one can trip over any line or power cords. Protect cords from damage or abrasion.
- If this product does not operate normally, see the **Troubleshooting** section on pages 106-112 of this user's manual. If you cannot solve the problem, or if the product is damaged, refer to the **Limited warranty** section on pages 116-117. Do not open this product except as directed in your user's manual. Opening the product or reassembling it incorrectly may expose you to hazardous voltages or other risks.
- This power adapter is intended to be correctly oriented in a vertical or floor mount position. The prongs are not designed to hold the plug in place if it is plugged into a ceiling, an under-the-table or cabinet outlet.



Caution: Use only the power adapter provided with this product. To obtain a replacement, visit our website at businessphones.vtech.com or call **1 (800) 595-9511**. In Canada, please dial **1 (800) 267-7377**.

Important safety information

Especially about cordless telephones

- **Electrical power:** The telephone base must be connected to a working electrical outlet. The electrical outlet should not be controlled by a wall switch. Calls cannot be made from the handset if the telephone base is unplugged, switched off or if the electrical power is interrupted.
- **Power adapter:** The power adapter is intended to be correctly oriented in a vertical or floor mount position. The prongs are not designed to hold the plug in place if it is plugged into a ceiling, under-the-table or cabinet outlet.

Precautions for users of implanted cardiac pacemakers

Cardiac pacemakers (applies only to digital cordless telephones):

Wireless Technology Research, LLC (WTR), an independent research entity, led a multidisciplinary evaluation of the interference between portable wireless telephones and implanted cardiac pacemakers. Supported by the U.S. Food and Drug Administration, WTR recommends to physicians that:

Pacemaker patients

- Should keep wireless telephones at least six inches from the pacemaker.
- Should NOT place wireless telephones directly over the pacemaker, such as in a breast pocket, when it is turned ON.
- Should use the wireless telephone at the ear opposite the pacemaker.

WTR's evaluation did not identify any risk to bystanders with pacemakers from other persons using wireless telephones.

Especially about telephone answering systems

Two-way recording: This unit does not sound warning beeps to inform the other party that the call is being recorded. To ensure that you are in compliance with any federal or state regulations regarding recording a telephone call, you should start the recording process and then inform the other party that you are recording the conversation.

SAVE THESE INSTRUCTIONS

Table of contents

Getting started

Console overview	1
Console screen icons	4
Alert tones and lights	5
Alert tones	5
Lights	5
Introduction	6
Planning your system	7
Method 1: Install the console as a system telephone	7
Planning your system	8
Method 2: Install the console as a stand-alone telephone	9
Installation	10
Console installation	11
For installation with use of UP406 deskset in the system - auto set IP	15
For installation with use of UP406 deskset in the system - set static IP ...	16
Console installation (stand-alone telephone)	17
Wall mount installation	18
To mount the console on the wall	18
Wall mount to tabletop installation	22
Connecting desksets	23
To connect a deskset to your UP416 console	23
Adding and registering a cordless handset	25
To register an UP407 cordless handset to your UP416 console	25
Adding and registering a cordless headset	26
To register an IS6100 cordless headset to your UP416 console	26
Deregistering cordless handset and cordless headset	27
To deregister the cordless handset and headset from the UP416 console	27

Adding a corded headset	28
To add a corded headset to the console	28
System setup	29
Menu settings	29
Set extension number	29
Release extension number	30
Prime line	31
Line group	32
Network setup	33
Discovery method	36
Network info	37

Telephone settings

Telephone setup	38
Ringer volume	38
Ringer tone	39
Set date/time	40
LCD language	41
Home area code	42
Key tone	43
LCD contrast	43
Dial mode	44
Call privacy	44
Music on hold	45
Hold reminder	45
Phone rename	46
Set default	46
Customer support	47

Telephone operation

Telephone operation	48
Line indicators	48
Making and ending a call	48
On hook dialing (predialing)	49
Full-duplex speakerphone	49
Answering a call	49
Temporary ringer silencing	49

Options while on calls	50	Directory	
Call waiting	50	About the directory	68
Volume control	50	Capacity	68
Mute	50	Exit the directory	68
Temporary tone dialing.....	50	Create directory entries.....	69
Hold.....	51	Create a new directory entry.....	69
Switching between lines.....	51	Review directory entries.....	70
Call privacy.....	52	Search directory	71
Recording a call	53	Search by name	71
Chain dialing	54	Dial, delete or edit entries	72
Redial	55	Display dial.....	72
To view the 10 most recently dialed numbers	55	Delete an entry.....	72
To redial a number	55	Edit an entry	73
To copy a redial entry to directory.....	55	Copy a directory entry to one touch....	74
To copy a redial entry to one-touch memory	56	Caller ID	
To delete a number	56	About the caller ID.....	75
Auto-redial.....	57	Information about caller ID with call waiting	75
Conference call	58	Caller ID information.....	76
A. Inviting parties using Intercom.....	58	How the caller ID information (call log) works	76
B. Join a call in progress.....	59	Caller ID operation	77
Call scenario	60	Memory match	77
Intercom	61	Missed (new) calls indicator.....	77
Make an intercom call to an extension...61		Review the caller ID information	77
Answer an intercom call.....	61	View dialing options	78
End an intercom call	61	Dial a call history entry.....	78
Answer an incoming call during an intercom call.....	61	Save a caller ID entry to the directory...79	
Call transfer	62	Copy a caller ID entry to one touch	80
Blind transfer	62	Delete entries	80
Call transfer using intercom	63	Reasons for missing caller ID information	81
Transfer a call and speak to the receiving party	63	Answering system	
One touch.....	64	About the answering system.....	82
Assign a one-touch entry	64	Answering system capacity	82
Review the one-touch entry	66	Auto attendant setup.....	83
To dial a one-touch entry.....	66	Auto attendant on/off.....	83
Edit the one-touch key	66	Auto attendant delay	83
Delete an one-touch key	67		

Announcement.....	84
Night mode.....	85
Record the auto attendant announcement.....	85
Set the start and end time of auto attendant announcement.....	86
Play the auto attendant announcement.....	87
Reset the auto attendant announcement.....	87
Reset auto attendant.....	88
Private mailbox setup.....	89
Private mailbox on/off	89
Private mailbox delay.....	89
Announcement.....	90
Call intercept	92
Answering system setup	93
Remote access code	93
Message date/time.....	93
Message alert	94
Message Length	94
Call screening	95
Recording time.....	95
Auto attendant operation.....	96
Using the auto attendant	96
Auto attendant (AA) flow chart.....	97
Answering system operation.....	98
New message indication.....	98
Call screening	98
Call intercept	98
Message playback	98
Options during playback	99
Delete all central mailbox messages...	99
Delete all private mailbox messages...	100
Record memo	100
Remote access	101

Appendix

Console display screen messages	103
Troubleshooting.....	106
Maintenance.....	113
FCC part 68 and ACTA	114
FCC part 15.....	115
Limited warranty.....	116
Technical specifications.....	118

Index	119
--------------------	------------

Getting started

Console overview

CALL HISTORY

- Press to view caller ID information (page 77).

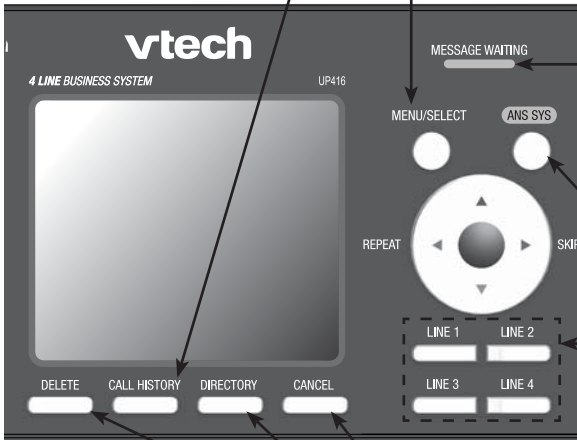

MENU/SELECT

- Press to enter the menu.
- While in the menu, press to select an item or save an entry or setting.

MESSAGE WAITING indicator

- Flashes when there are new messages in the central mailbox or private mailbox (page 98).

ANS SYS

- Press to enter the answering system setup menu.

LINE 1-LINE 4 keys

- Press to make or answer a call on the desired line (pages 48-49).

CANCEL

- While in a menu, press to cancel an operation and exit the menu display.

DELETE

- While playing a message, press to delete the message (page 99).
- While reviewing the caller ID information, press to delete an individual entry (page 80).
- While predialing, press to delete digits (page 49).

DIRECTORY

- Press to view directory information (page 70).

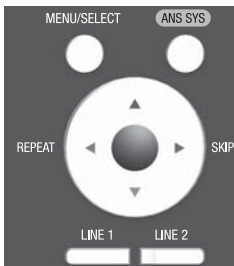

Navigation keys

- While in menus, press ▲ or ▼ to scroll through the menus, highlight items or change settings. Press ►/SKIP to enter the highlighted item, or press ◀/REPEAT to return to the previous menu.
- While entering names or numbers, press ◀/REPEAT or ►/SKIP to move the cursor to the left or right.
- While playing back messages, press ◀/REPEAT to repeat the message, or press ►/SKIP to skip to the next message.

Getting started

Console overview



One-touch keys

- Press to dial the desired one-touch number (page 66).

Directory card

To write names on the directory card, follow the steps below:

1. Pull out the directory card.
2. Write the information on the directory card.
3. Replace the directory card under the plastic cover.

SPEAKER

- Press to turn on the speakerphone. Press again to turn it off (page 49).

MIC

FLASH

- During a call, press to answer an incoming call when you receive a call waiting alert (page 50).

HOLD

- Press to place an outside call on hold (page 51).

INTERCOM

- When in idle mode, press to initiate an intercom call (page 61).

MUTE

- During a call, press to mute the microphone (page 50).

HEADSET

- When a corded headset is connected to the console, press to make, answer or hang up a call (page 49).

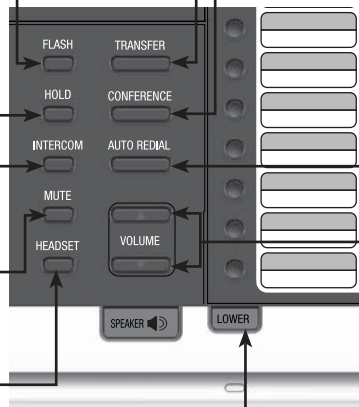

TRANSFER

- Press to transfer a call to an extension (pages 62 and 63).

CONFERENCE

- Press to add another extension or outside line to an existing call (pages 58-60).

AUTO REDIAL

- Press to view the last 10 numbers dialed (page 55 and page 57).

▲/VOLUME/▼

- During a call, press to adjust the listening volume (page 50).
- During message playback, press to adjust the playback volume (page 99).
- Press to adjust the ringer volume when in idle mode (page 38).

LOWER

- When assigning or dialing a one-touch number, press to switch to the lower location (the second 16 locations) of a one-touch key (pages 64-67).

Getting started

Console overview

Main menu

The > symbol highlights a menu item.

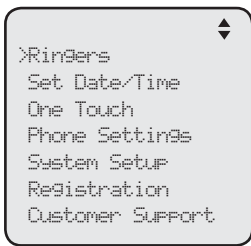

Main menu

- Ringers (pages 38-39)
- Set Date/Time (page 40)
- One Touch (pages 64-67)
- Phone Settings (pages 41-46)
- System Setup (pages 29-37)
- Registration (pages 23-27)
- Customer Support (page 47)





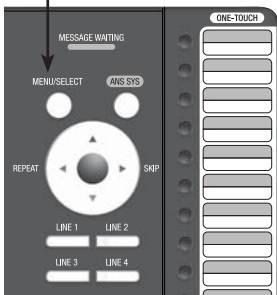

Using menus

- Press **MENU/SELECT** to show the main menu.
- Press **▲** or **▼** to scroll through menu items.
- Press **MENU/SELECT** or press **▶/SKIP** to select a highlighted menu item.
- Press **MENU/SELECT** to save changes.
- Press **CANCEL** to cancel an operation, exit the menu display or return to the idle screen.



Getting started

Console screen icons

L1 L2 L3 L4	Telephone lines -On when this console is selected under the corresponding line group setting.
	Ringer off - On steadily when the ringer volume is set to OFF .
	Headset - On steadily when using a corded headset.
	Speakerphone - On steadily when using the speakerphone.
MUTE	Mute - Microphone is muted.
PRIV	Call privacy - On steadily when the call privacy feature is set to On .
REC	Record a call - On steadily when recording a call.
	New private mailbox message - New message in the private mailbox.
	Private mailbox on - The private mailbox is turned on.
	New central mailbox message - New message in the central mailbox.
NEW	New caller ID log - Missed and new calls.

Getting started

Alert tones and lights

Alert tones

- | | |
|-----------------|---|
| <p>One beep</p> | <p>You have set the hold reminder on.
 -OR-
 The telephone is recording a memo.
 -OR-
 You have set the message alert tone on.
 -OR-
 There is an incoming call waiting.</p> |
|-----------------|---|

Lights

LINE 1/LINE 2/LINE 3/LINE 4

- On when the telephone line is in use.
- Flashes when the telephone line is on hold.
- Flashes quickly when there is an incoming call or a transfer call.

MESSAGE WAITING

- Flashes when there are new private or central messages.

ANS SYS

- On when the private mailbox is on.
- Flashes when the auto attendant is answering or directing calls and the private mailbox is off.
- Flashes when the answering system is playing or recording announcements or messages.

INTERCOM

- On when the console is on an intercom call.
- Flashes when there is an incoming intercom call.

MUTE

- On with the microphone is muted.

HEADSET

- On when the corded headset is in use.

HOLD

- Flashes when a telephone line is on hold.

SPEAKER

- On when the speakerphone is on.

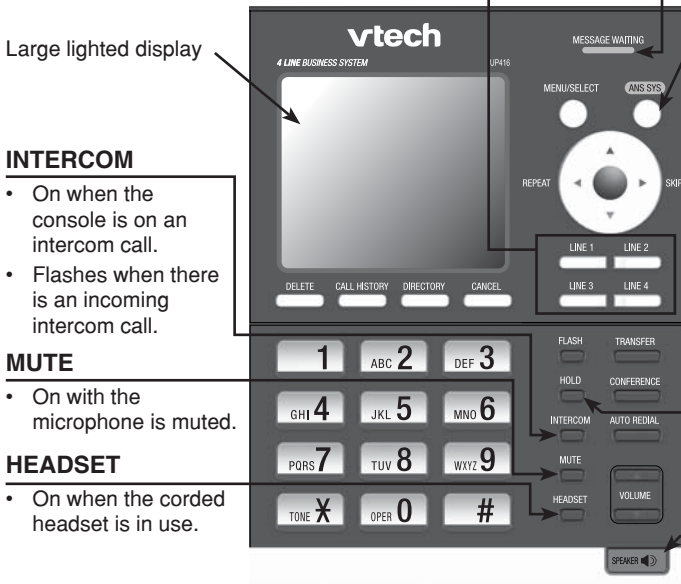

Getting started

Introduction

This UP416 is the console of a 4-line telephone system. It is expandable to a maximum of 15 UP406 desksets, a UP407 cordless handset and a VTech IS6100 cordless headset. Expanding your system requires you to connect and register each new device first (see pages 23-26). This system is not compatible with any other VTech 4-line small business telephones, except for the UP406 deskset and UP407 handset. The console can also be used as a stand-alone telephone without connecting it to system desksets via an Ethernet network.

The UP416 telephone is hearing-aid compatible and can be connected to four telephone lines. This telephone features a speakerphone for handsfree use and a headset jack compatible with most headsets using two-band 2.5mm headset plugs (sold separately).

There are two network ports, known as the Ethernet port and PC port, at the back of the console. The Ethernet port allows the UP416 telephone to connect with UP406 desksets via an Ethernet wall jack, Ethernet switch or router. The PC port is for another device such as a personal computer to connect to the Ethernet network through the console.

The UP416 console supports intercom and call transfers between system extensions and is capable of connecting five parties on the same conference call.

This telephone also features a 32-number one- and two-touch memory for faster dialing and has a directory that can store up to 50 additional numbers with names. This telephone has a caller ID feature that supports caller ID with call waiting service. Caller ID services are subscriber services available from many telephone service providers for a fee. The telephone can store up to 200 caller ID entries.

Your UP416 console also features a built-in digital answering system with a central mailbox and private mailbox. This UP416 telephone is equipped to function as an auto attendant in a multi-telephone system. An auto attendant telephone can pick up and redirect incoming calls to other extensions in your telephone system. For details, see the **Auto attendant operation** section (pages 96-97). This user's manual contains detailed instructions for using your UP416 console. Please read this user's manual before using this telephone.

Getting started

Planning your system

The UP416 package includes only the console. You have to purchase UP406 deskset, UP407 cordless handset, and IS6100 cordless headset separately to expand your system.

To order them, visit our website at businessphones.vtech.com or call **1 (800) 595-9511**. In Canada, please dial **1 (800) 267-7377**.

There are two installation methods:

Method 1: Install the console as a system telephone so that it can be connected to UP406 desksets via your Ethernet network.

-OR-

Method 2: Install the console as a stand-alone telephone so that it can function as an independent 4-line telephone without connecting it to desksets.

Method 1: Install the console as a system telephone

You must install and set up the UP416 console first before expanding your system with UP406 deskset, UP407 cordless handset or IS6100 cordless headset.

Make sure you connect the console and all desksets to the Ethernet network. You can use the existing Ethernet wall jack to which your computer is already connected, or set up a new network. Refer to pages 11-16 for installation instructions.

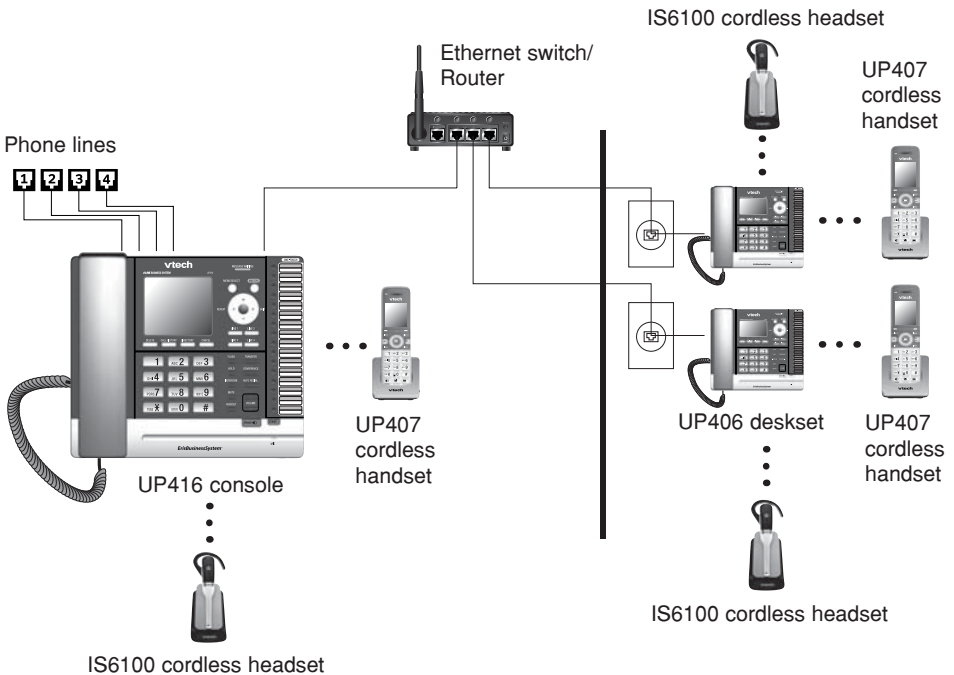

Getting started

Planning your system

Use the existing Ethernet wall jack:

Use the PC port on the console as an Internet pass-through.

1. Unplug your Ethernet cable of your computer from the existing Ethernet wall jack.
2. Plug one end of the Ethernet cable into the Ethernet port (E) at the back of the console and the other end into the Ethernet wall jack.
3. Connect your computer to the Ethernet network through the PC port (PC) of this console.

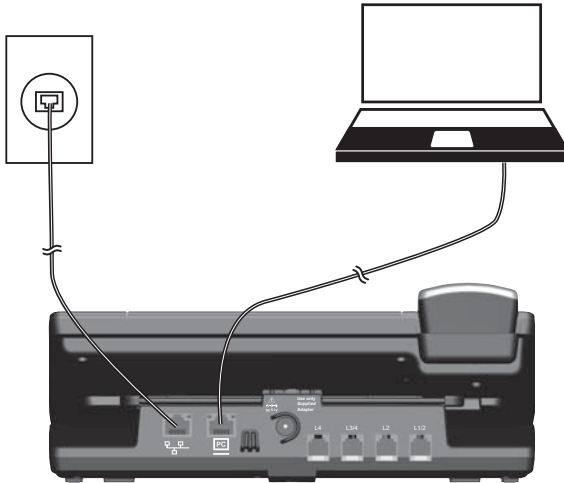

NOTES:

- The PC port does not function when there is no power connected to this console. Refer to pages 11-16 for installation instructions.
- This telephone system does not support Power over Ethernet (PoE).
- If you are using the Gigabit Ethernet system, the connection speed of your computer will be slower.

Set up a new network:

Contact your technical support for the Ethernet network setup.

Make sure your Ethernet switch or router has enough slots to accommodate the console, each deskset and your computers. Refer to pages 11-16 for installation instructions.

Getting started

Planning your system

Method 2: Install the console as a stand-alone telephone

You can install the console without connecting it to UP406 desksets via an Ethernet network. You must install and set up the UP416 console first before expanding your system with UP407 cordless handset or IS6100 cordless headset. Refer to pages 11-14 and page 17 for installation instructions.

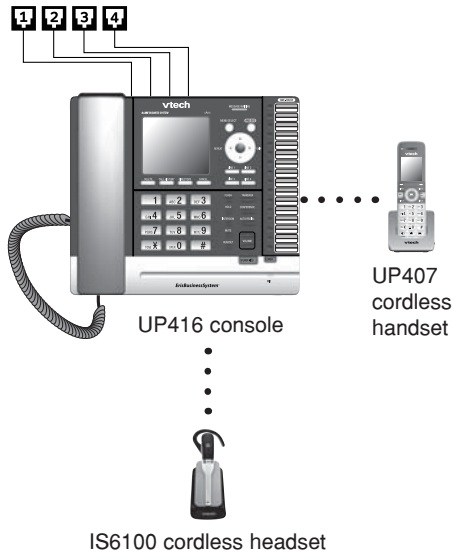

NOTES:

- Make sure you connect only one telephone system to the desired telephone lines.
- You must have telephone jacks and electrical outlet not controlled by wall switch near where you install the console.
- You can have only one console in a system.
- Make sure you assign a unique extension number to each individual phone in your telephone system. See **Set extension number** on page 29.
- You can register only one UP407 cordless handset and one VTech IS6100 cordless headset to a UP416 console or a UP406 deskset. For optimal performance, make sure you do not register more than five cordless accessories. More cordless accessories still work, but you might experience degradation in various performances.
- When the console or a deskset has cordless accessories, the accessories are all part of the same extension.
- Only one device with the same extension can be used at a time.
- If you have cordless accessories, for optimum range and better reception, place the console in a central and open location.

Getting started

Installation

Install the console close to the telephone jacks, an Ethernet wall jack (if necessary), and a power outlet not controlled by a wall switch. The telephone can be placed on a flat surface or vertically mounted on the wall (pages 18-22).



TIP: If you subscribe to high-speed Internet service (DSL - digital subscriber line) through your telephone lines, you must install DSL filters between the telephone line cords and the telephone wall jacks (see page 13 or 14). The filter prevents noise and caller ID problems caused by DSL interference. Please contact your DSL service provider for more information about DSL filters.

Your product may be shipped with a protective sticker covering the console display - remove it before use.

For customer service or product information, visit our website at **businessphones.vtech.com** or call **1 (800) 595-9511**. In Canada, please dial **1 (800) 267-7377**.

Avoid placing the console too close to:

- Communication devices such as television sets, VCRs, or other cordless telephones.
- Excessive heat sources.
- Noise sources such as a window with traffic outside, motors, microwave ovens, refrigerators, or fluorescent lighting.
- Excessive dust sources such as a workshop or garage.
- Excessive moisture.
- Extremely low temperature.
- Mechanical vibration or shock such as on top of a washing machine or work bench.

Getting started

Console installation



- Do not power up the console until you have plugged in all telephone lines and the Ethernet cable as instructed in steps 4-5.
- The power adapter is intended to be correctly oriented in a vertical or floor mount position. The prongs are not designed to hold the plug in place if it is plugged into a ceiling, under-the-table or cabinet outlet.

1. Plug the end of the coiled handset cord into the (jack on the left side of the telephone.



2. Lift the kickstand as the arrows indicate below to release it from the groove. There are seven pairs of grooves designed to hold the console at different angles for optimum visibility.

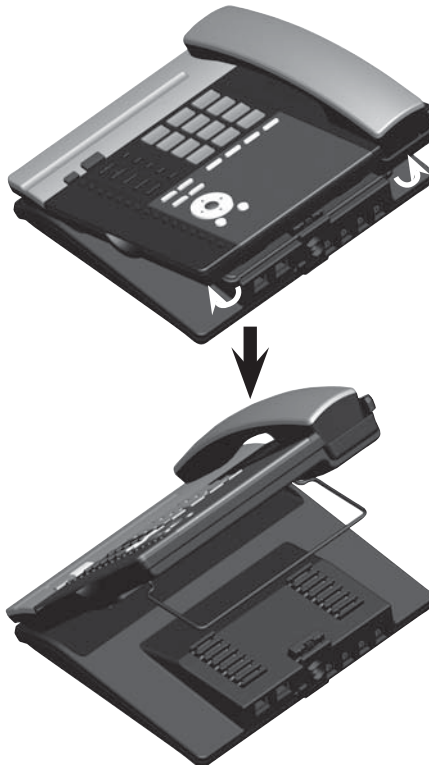

Getting started

Console installation

3. Snap the kickstand into the desired grooves until it locks into place.



4. Connect the telephone lines, Ethernet cable (if necessary) and power adapter.
See the illustration on the next page to connect to four single-line wall jacks;
or see page 14 to connect to two 2-line wall jacks.

Getting started

Console installation

Option 1: Connect to four single-line wall jacks

NOTES:

- Use only the power adapter supplied with this product. To order a replacement power adapter, visit our website at businessphones.vtech.com or call 1 (800) 595-9511. In Canada, please dial 1 (800) 267-7377.
- Plug the black telephone line cords into the **L1/2** and **L3/4** jacks of the console, and plug the gray telephone line cords into the **L2** and **L4** jacks of the console respectively.
- If you are installing less than four telephone line cords to the console, plug the telephone line cords starting from the **L1/2** jack. Avoid having unoccupied telephone jack between other occupied telephone jacks.
- If you want to use an occupied Ethernet wall jack, use the PC port on the console as an Internet pass-through. For details, see **Use the existing Ethernet wall jack** on page 8.

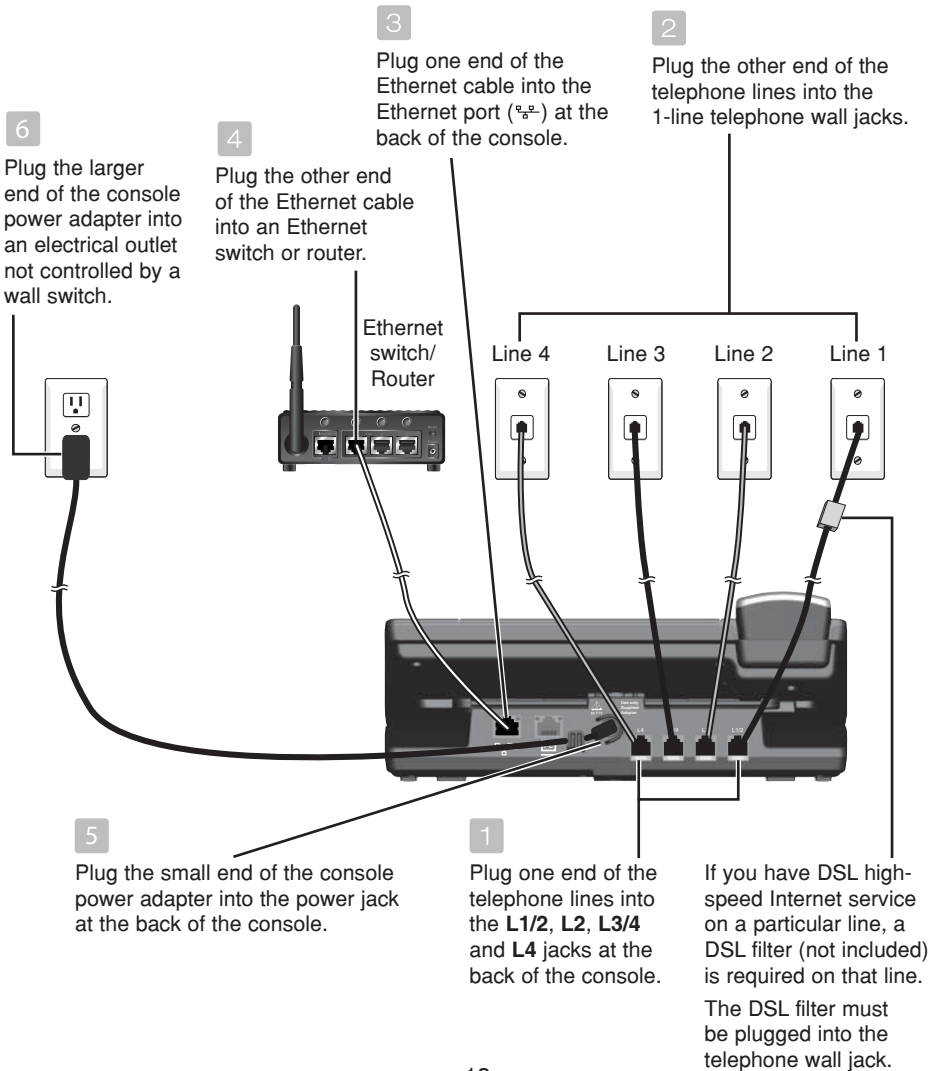

Getting started

Console installation

Option 2: Connect to two 2-line wall jacks



NOTES:

- Use only the power adapter supplied with this product. To order a replacement power adapter, visit our website at businessphones.vtech.com or call 1 (800) 595-9511. In Canada, please dial 1 (800) 267-7377.
- A 2-line wall jack supports two telephone numbers in one wall jack. Contact your telephone service provider for details. You must plug the black telephone line cords into the 2-line wall jacks and the L1/2 and L3/4 jacks of the console for the lines to work properly.
- If you want to use an occupied Ethernet wall jack, use the PC port on the console as an Internet pass-through. For details, see **Use the existing Ethernet wall jack** on page 8.

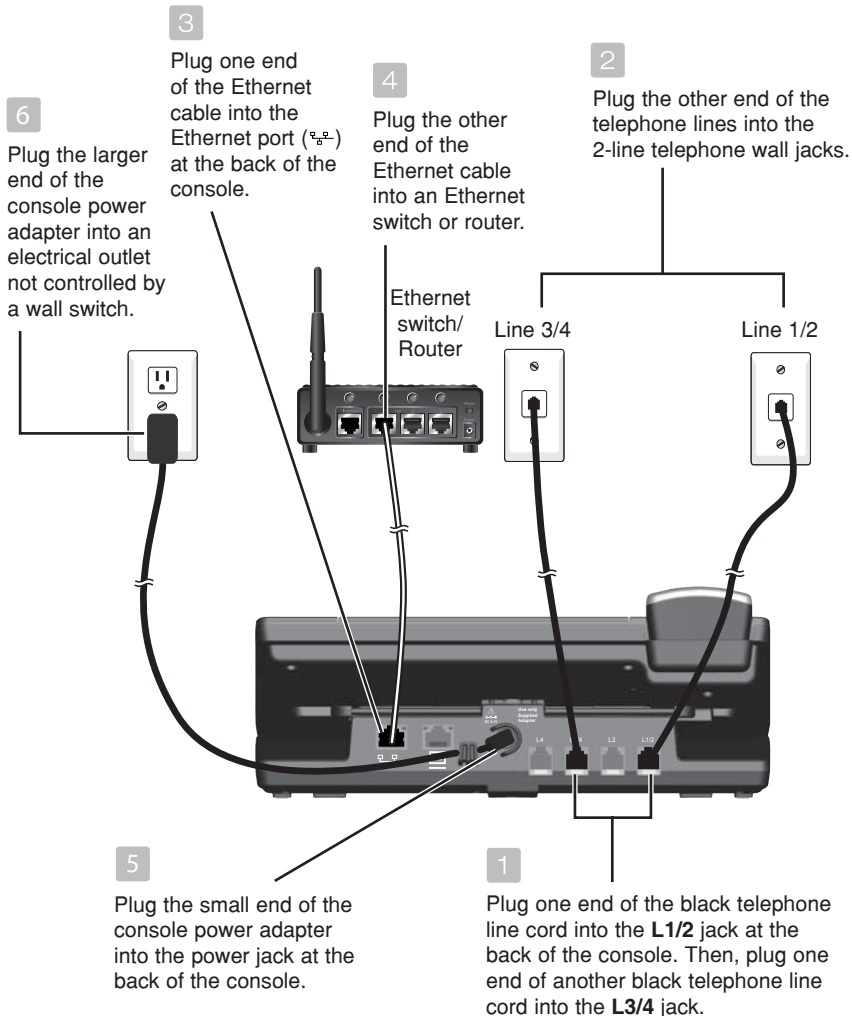

Getting started

Console installation

For installation with use of UP406 deskset in the system - auto set IP



If you want to use the console as a stand-alone telephone, skip to page 17.

After the console is powered up, it takes at least one minute to start up the system and the screen displays **booting....** during startup. The screen displays **Is this Console going to register UP406 Desksets? 'SELECT': Yes 'CANCEL': No.** Press **SELECT**. The screen shows **Console is in system mode.**

The console is set to obtain an IP address automatically by default. The screen displays **Obtaining IP from DHCP server Please wait...** while the console is obtaining an IP address from the Ethernet switch or router. After an IP address is obtained, the screen displays **IP obtained: XXX.XXX.X.XXX Please set an extension number to this phone.**

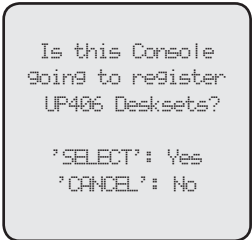

If the console cannot obtain IP address automatically, it displays **No IP obtained. Check network.** and then the **Network setup** menu. You may need to enter the IP address manually under the **Set static IP** menu. See the instructions on the next page for details.



To set an extension number:

1. When the console displays **IP obtained: XXX.XXX.X.XXX Please set an extension number to this phone,** press **MENU/SELECT**.
2. Press **◀/REPEAT** or **▶/SKIP** to choose the desired extension number.
3. Press **MENU/SELECT** to save.
4. The console displays **Please wait...** and then **Starting...** It takes a while for the system to finish the startup and the console enters idle screen when the startup is done. The console is named **Console** by default.
5. Wait for approximately one minute for console to synchronize, then lift the handset. If you hear a dial tone, the installation was successful.

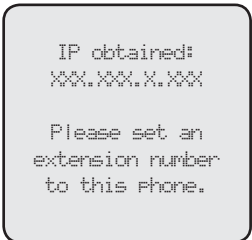

Getting started

Console installation (system telephone)

For installation with use of UP406 deskset in the system - set static IP



Instructions on this page are for users to enter static IP to set up the console, due to a failure in obtaining IP from the Ethernet switch or router automatically. If you have successfully obtained the IP from your Ethernet switch or router, you do not need to perform the steps below.

To set static IP when initially setting up the console:

1. If the console cannot obtain an IP address from the Ethernet switch or router after you power it up, the screen displays **No IP obtained. Check network.** and then displays the network setup menu.
2. Press ▲ or ▼ to scroll to **Set static IP**, then press **MENU/SELECT**.
3. The screen displays **Enter static IP**. Use the dialing keys to enter a specific IP.
 - Press **DELETE** to delete a character.
 - Press **#** to add a dot.
 - Press **◀/REPEAT** or **▶/SKIP** to move the cursor to the left or right.When entering a specific IP, make sure the IP range is not blocked by the Ethernet switch or router.
4. Press **MENU/SELECT**. The screen displays **Subnet mask**: Use the dialing keys to enter a specific subnet mask.
 - Press **DELETE** to delete a character.
 - Press **#** to add a dot.
 - Press **◀/REPEAT** or **▶/SKIP** to move the cursor to the left or right.
5. Press **MENU/SELECT**. The screen displays **Router/Gateway**: Use the dialing keys to enter a specific gateway.
 - Press **DELETE** to delete a character.
 - Press **#** to add a dot.
 - Press **◀/REPEAT** or **▶/SKIP** to move the cursor to the left or right.
6. Press **MENU/SELECT** to save. The screen displays **IP obtained: XXX.XXX.XXX.X** **Please set an extension number to this phone.**
7. Press **MENU/SELECT**. Press **◀/REPEAT** or **▶/SKIP** to choose the desired extension number.
8. Press **MENU/SELECT** to save. The screen displays **Please wait...** and then **Starting...** It takes a while for the system to finish the startup. The console enters the idle screen when the startup is done.
9. Lift the handset. If you hear a dial tone, the installation was successful.



NOTE: Make sure the static IP you entered is not occupied by other network devices. You can check the occupied IP addresses in your router menu.

Getting started

Console installation (stand-alone telephone)

This UP416 console can be used as a stand-alone telephone without connecting it to UP406 desksets via an Ethernet network.

Follow the steps below to set up the console if you do not connect it to an Ethernet network.

1. Follow the steps on pages 11-14 to connect the line cords and adjust the console's viewing angle.
2. When the screen displays **Is this Console going to register UP406 Desksets? 'SELECT': Yes 'CANCEL': No**, press **CANCEL**. The screen displays **Console is in standalone mode**.
3. The screen displays **Starting...** It takes a while for the system to finish the startup. The console enters the idle screen when the startup is done.
4. Lift the handset. If you hear a dial tone, the installation was successful.

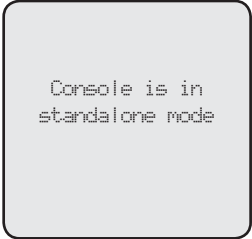
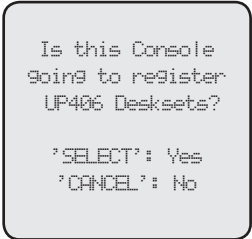

You may change the stand-alone telephone to a system telephone (with use of UP406 deskset) at a later stage. Follow the steps below if you want to do so.

1. Connect the Ethernet cable between the console and the Ethernet switch or router (see pages 13-14 for details).
2. Follow steps 1-8 in **To enable the Auto set IP** under the **Network setup** section on page 33 to obtain an IP automatically.

-OR-

If you cannot obtain an IP automatically and need to enter one manually, see steps 1-8 in **To enable the Set static IP** under the **Network setup** section on pages 34-35 for details.

3. You may now connect UP406 deskset to the console. See **Connecting desksets** on pages 23-24 for installation instructions.

Getting started

Wall mount installation

To mount the console on the wall

1. Unplug the power adapter from the outlet, the telephone line cords from the wall jacks (or DSL filters), and the Ethernet cable from the Ethernet switch or router.
2. Put the corded handset aside. Use a coin to rotate the handset tab 180 degrees. The protruding edge holds the corded handset when the phone is mounted on the wall.

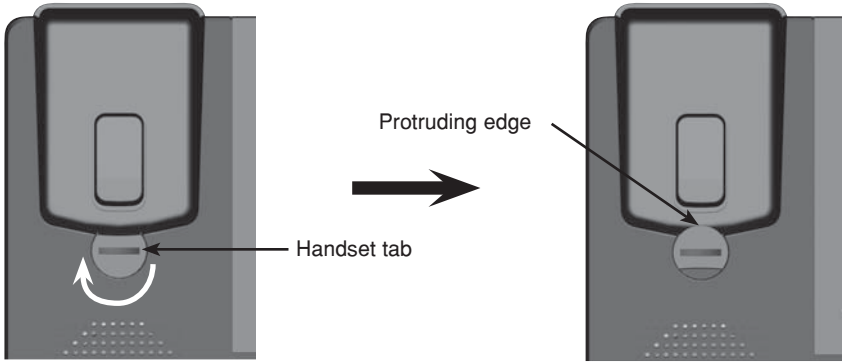

3. Lift the kickstand as indicated by the arrows below to release it from the grooves.



Getting started

Wall mount installation

4. Snap the kickstand into the outermost groove until it locks into place.



Getting started

Wall mount installation

5. Install the wall mount bracket to the console as shown below. Insert the upper tabs of the mounting bracket into the upper slots at the back of the console. Press the lower tabs of the mounting bracket into the lower slots at the back of the console until they lock into place.

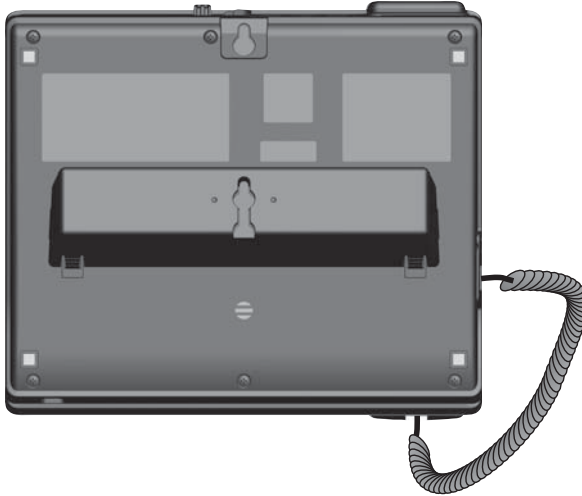

6. Connect the telephone line cords, Ethernet cable (if necessary) and power adapter as shown below.

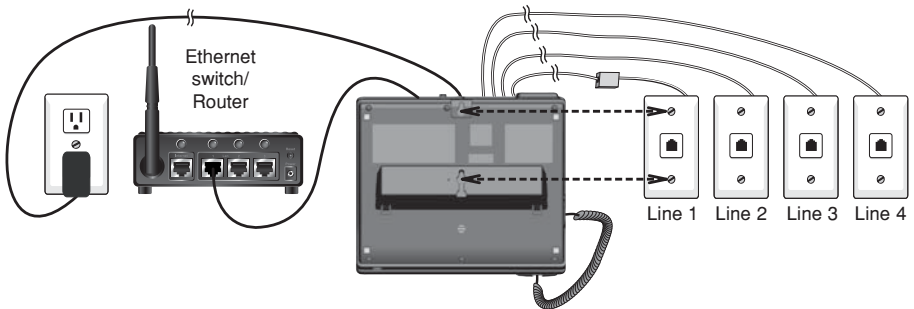

To connect to two 2-line wall jacks, refer to the **Option 2: Connect to two 2-line wall jacks**, illustration on page 14.

Getting started

Wall mount installation

7. Align the upper wall mounting hole on the back of the console with the upper tab of the standard wall plate. Make sure the lower wall mounting hole on the mounting bracket also aligns with the lower tab of the standard wall plate. Push the console down until it clicks securely in place.

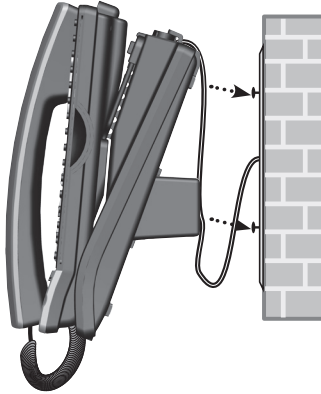

8. Bundle the telephone line cord and power adapter cord neatly with twist ties.

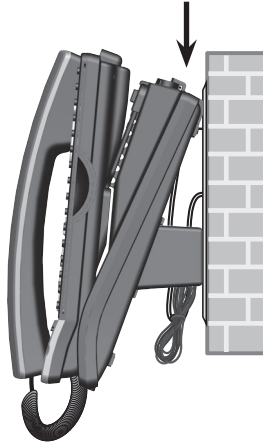

Getting started

Wall mount installation

Wall mount to tabletop installation

To change the console from the wall mount position to tabletop position, follow the steps below.

1. If the telephone line cords and power adapter cord are bundled, untie them first.
2. Push the console up to remove it from wall. Unplug the telephone line cords (or DSL filters) from the wall, the power adapter from the power outlet, and the Ethernet cable from the Ethernet switch or router.
3. See **Console installation** on pages 11-12.

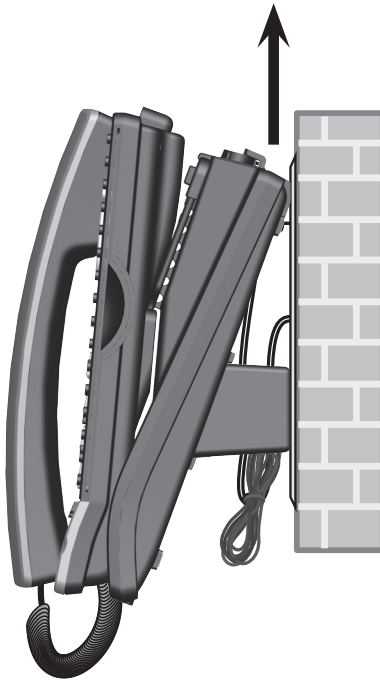

Getting started

Connecting desksets

Your telephone can support up to 15 UP406 desksets. The desksets must be connected to the console before use. You must connect each deskset separately.

Make sure your deskset is installed properly. Refer to the UP406 deskset user's manual for details. Start the connection when the deskset screen shows **IP obtained: XXX.XXX.X.X Press SELECT to proceed.**

To connect a deskset to your UP416 console

1. The deskset should display **IP obtained: XXX.XXX.X.X Press SELECT to proceed** before you begin connection.
2. On the deskset, press **MENU/SELECT**.
3. The deskset screen displays **Enter the name of the Console connecting to this phone.** Press **MENU/SELECT**.
4. The screen displays **Console's name:**. The console's name is set as **Console** by default. If you have changed your console's name, enter the same name using dialing keys on the deskset. Otherwise, skip to step 5 to continue.
 - Press **DELETE** to delete a character.
 - Press **◀/REPEAT** or **▶/SKIP** to move the cursor to the left or right.
5. Press **MENU/SELECT** to save. The deskset screen displays **Please set an extension number to this phone.** Press **MENU/SELECT**.
6. Press **◀/REPEAT** or **▶/SKIP** to choose the desired extension number. The extension number ranges from **11** to **26**. Press **MENU/SELECT** to confirm.
7. The deskset screen displays **Connecting to Console...** It takes up to 60 seconds to complete the connection. The deskset screen displays **Connected to Console** when the connection is successful.

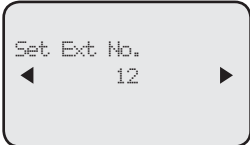
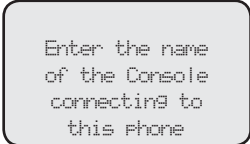

Getting started

Connecting desksets

To connect a deskset to your UP416 console (continued)

8. The deskset screen displays **Starting...** It takes a while for the system to finish the startup. The deskset enters the idle screen when the startup is done.
9. Lift the handset. If you hear a dial tone, the connection was successful.

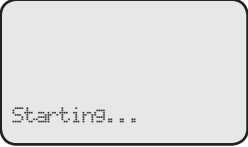

Starting...



NOTES:

- If the connection is not successful, the deskset returns to the previous screen. Try the connection process again.
- Make sure you assign a unique extension number to the deskset.
- If you want to replace a deskset and keep the same extension number, make sure you release its extension number after disconnected from the console. See **Release extension number** on page 30.

Getting started

Adding and registering a cordless handset

You can add a cordless handset (**UP407**, purchased separately) to your console. The cordless handset must be registered with the UP416 console before use. When first purchased, the handset shows **Choose Handset in Registration at base menu. Put handset on cradle to register.**

Make sure the cordless handset is properly installed before you begin registration. Refer to the user's manual of the cordless handset for details. If the handset does not have enough power to proceed with the registration, you need to charge the new handset for at least five minutes.

To register an UP407 cordless handset to your UP416 console



NOTE: Register each cordless handset or headset separately.

1. Make sure the cordless handset is out of the charger and the screen shows **Choose Handset in Registration at base menu. Put handset on cradle to register.**
2. On the UP416 console, press **MENU/SELECT**.
3. Press **▲** or **▼** to scroll to **Registration** and press **MENU/SELECT** or **▶/SKIP**.
4. Press **MENU/SELECT** again or press **▶/SKIP** to select **Handset**. The console screen shows **Registering handset... (Put handset on cradle to start)**.
5. Place the unregistered cordless handset into the charger. The handset screen displays **Registering... Please wait**. The handset beeps once and begins registering to the UP416 console. It takes up to 60 seconds to complete the registration. The UP416 console shows **Handset registered** and the handset shows **Ext Handset**. To change the handset name and the extension number shown on the handset screen, refer to the **Phone rename** and **Extension no.** sections in the user's manual of the cordless handset.

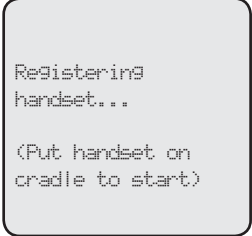
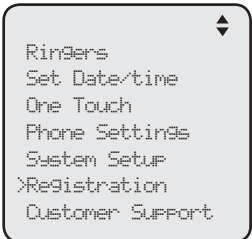

If the registration is not successful, the UP416 console screen returns to the previous screen. Wait for about two minutes, then try the registration process again with step 1.

Getting started

Adding and registering a cordless headset

You can use this console handsfree when you register a DECT 6.0 cordless headset (VTEch model IS6100) to the console. You can only register one cordless headset to the console. Make sure the headset is charged before use. Refer to the user's manual of the cordless headset for details.

Place the headset in the headset charger and note the color of the  button. If the button flashes in red and blue alternately, the headset is unregistered. If the button shows a constant red light (charging) or blue light (fully charged), the headset is registered to other device. Deregister the headset before you can register it to the console. See the deregistration instructions in the user's manual of the telephone to which it is currently registered.

To register an IS6100 cordless headset to your UP416 console



NOTE: Register each cordless handset or headset separately.

1. Place the headset in the headset charger and allow it to charge for at least five minutes before beginning registration. Make sure the headset is out of the headset charger before you begin registration.
2. On the UP416 console, press **MENU/SELECT**.
3. Press **▲** or **▼** to scroll to **Registration**, then press **MENU/SELECT** or **▶/SKIP**.
4. Press **▲** or **▼** to scroll to **DECT Headset**, then press **MENU/SELECT** or **▶/SKIP**. The UP416 console shows **Registering DECT Headset... (Put DECT headset in charger)**. It takes up to 60 seconds to complete the registration.
5. Place the headset into the cradle. When the registration is successful, the UP416 console shows **DECT Headset registered**.
6. Lift the headset, then press  on the headset. If you hear a dial tone, the registration was successful.

If there is no dial tone, or the  light on the headset flashes in red and blue alternately, the registration was not successful. Remove the headset from the headset charger. Wait for about two minutes, then repeat the registration process again, starting with Step 2 above.

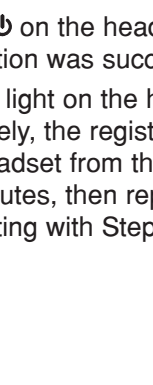

```
Ringers
Set Date/time
One Touch
Phone Settings
System Setup
>Registration
Customer Support
```

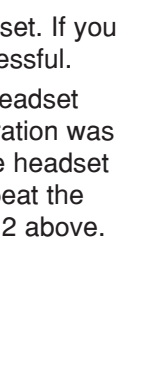

```
Registration
Handset
>DECT Headset
Deregistration
```

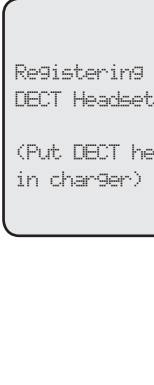

```
Registering
DECT Headset...

(Put DECT headset
in charger)
```

Getting started

Deregistering cordless handset and cordless headset

If you have a registered handset and/or headset, and need to replace one of them or both, you will have to deregister both devices first, then register each device to the deskset separately. **Please read all the instructions on this page before beginning the deregistration process.**

Please make sure the telephone system is not in use before deregistration.

To deregister the cordless handset and headset from the UP416 console

1. On the console, press **MENU/SELECT**.
2. Press **▲** or **▼** to scroll to **Registration** and press **MENU/SELECT** or **▶/SKIP**.
3. Press **▲** or **▼** to scroll to **Deregistration** and press **MENU/SELECT** or **▶/SKIP**.
4. The console screen shows **Deregister all devices?** Press **'SELECT'** to confirm. Press **MENU/SELECT** to confirm.
5. The process takes up to 10 seconds to complete. The console shows **Handset deregistered. DECT Headset deregistered.** when the deregistration is successful. The console returns to the **Registration** menu. To return to the idle screen, press **CANCEL** twice.



NOTES:

- To register a cordless handset again, refer to the registration information on page 25.
- To register a cordless headset again, refer to the registration information on page 26.

Getting started

Adding a corded headset

You can use this console handsfree when you install any industry-standard 2.5mm corded telephone headset (purchased separately).

To add a corded headset to the console

Side view of the console

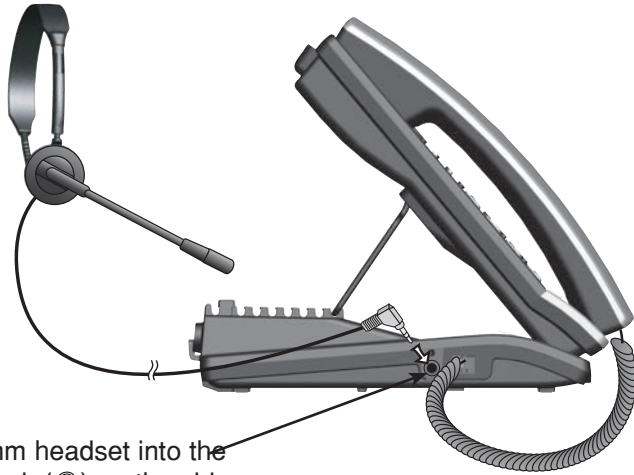

Plug a 2.5 mm headset into the **HEADSET** jack (🎧) on the side of the console.



NOTE: The **HEADSET** button on the console controls only the corded headset. For more details on the operation of the corded headset, refer to the user's manual of the corded headset.

Getting started

System setup

Menu settings

Use this menu to change the telephone system settings.

1. Press **MENU/SELECT** when in idle mode (when the console is not in use) to enter the main menu.
2. Press **▲** or **▼** to scroll to the feature to be changed. The **>** symbol indicates the selected menu item.
3. Press **MENU/SELECT** or **▶/SKIP** to select the menu item.
4. Press **CANCEL** to exit setup without making changes.



NOTE: Press **CANCEL** to cancel an operation, exit the menu display, or return to idle mode.

Set extension number

Each individual phone (console or deskset) in the telephone system **MUST** be assigned a unique extension number for the intercom feature to work. The assignment is done when the console is initially setup. If you have to set a new extension number to this console after initial setup, you are recommended to do so before connecting any system desksets.

To change the extension number:

1. When the console is idle, press **MENU/SELECT**.
2. Press **▲** or **▼** to scroll to **System Setup**, then press **MENU/SELECT** or **▶/SKIP**.
3. Press **MENU/SELECT** again or **▶/SKIP** to select **Set Ext. No.**
4. The screen displays **Set Ext No.** Press **◀/REPEAT** or **▶/SKIP** to choose the desired extension number (11-26).
5. Press **MENU/SELECT** to save the setting and return to the previous menu. To exit without making changes, press **CANCEL**.
6. You have to release the old extension number from the console to make it available for other desksets. See **Release extension number** on page 30 for details.

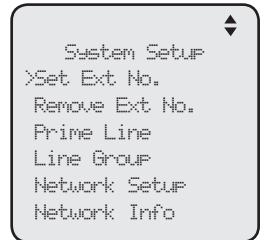
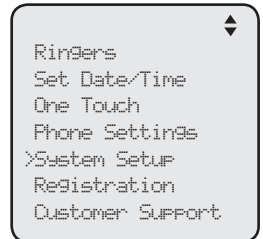

NOTE: If you want to assign an extension number that is already being used, see **Release extension number** on page 30 to replace the number.

Getting started

System setup

Release extension number

You have to release an extension number that is already being used from the telephone system to make it available for other desksets. You cannot release the console's extension number. You need to assign an extension number (see **Set extension number** on page 29) to any released deskset again for the intercom feature to work on that deskset. After you release a deskset's extension number, its screen flashes **Set Ext No.**

To release an extension number:

1. When the console is idle, press **MENU/SELECT**.
2. Press **▲** or **▼** to scroll to **System Setup**, then press **MENU/SELECT** or **►/SKIP**.
3. Press **▲** or **▼** to scroll to **Remove Ext No.**, then press **MENU/SELECT** or **►/SKIP**.
4. The screen displays **Remove Ext No.** Press **◀/REPEAT** or **►/SKIP** to choose the desired extension number (**11-26**), then press **MENU/SELECT**.
5. The screen displays **Remove Ext No. XX from phone: Deskset ?** (**Deskset** represents the name of the deskset) Press **MENU/SELECT** to confirm.



NOTE: The released extension number will no longer appear in the intercom menu.

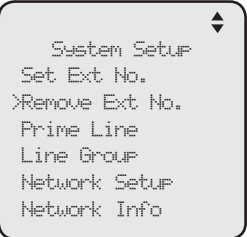

Getting started

System setup

Prime line

Use this feature, also known as automatic line selection, to choose which line is automatically selected each time you make an outside call. If you select **Auto**, the console selects any available telephone line starting from Line 1.

To set the prime line:

1. When the console is idle, press **MENU/SELECT**.
2. Press ▲ or ▼ to scroll to **System Setup**, then press **MENU/SELECT** or ►/SKIP.
3. Press ▲ or ▼ to scroll to **Prime Line**, then press **MENU/SELECT** or ►/SKIP.
4. Press ▲ or ▼ to choose the desired line, then press **MENU/SELECT** or ►/SKIP. To exit without making changes, press **CANCEL**.

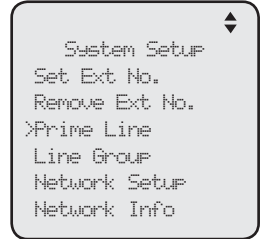

NOTE: If you install less than four telephone line cords to the console and select **Auto** as your **Prime line** setting, make sure you plug in your telephone line cords starting from L1/2 jack. Avoid having any unoccupied telephone jack between other occupied telephone jacks.

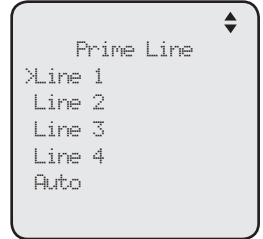

Getting started

System setup

Line group

You can set an extension or several extensions to receive the incoming calls from a specific telephone line. Other non-selected extensions will not ring when there is an incoming call from that specific line.

1. When the console is idle, press **MENU/SELECT**.
2. Press **▲** or **▼** to scroll to **System Setup**, then press **MENU/SELECT** or **►/SKIP**.
3. Press **▲** or **▼** to scroll to **Line Group**, then press **MENU/SELECT** or **►/SKIP**.
4. Press **▲** or **▼** to choose the desired line, then press **MENU/SELECT** or **►/SKIP**.
5. The screen displays **Set Ext to Ring**. Press **▲** or **▼** to scroll to the desired extension, then press **MENU/SELECT**. Repeat this step until all desired extensions are selected.
 - The extensions marked with a tick will ring when there is an incoming call from the line chosen in Step 4.
 - The extensions not marked with a tick do not ring when there is an incoming call from the line chosen in Step 4, unless the caller specifically tries to reach the extension through the auto attendant (see **Auto attendant setup** on page 83).
6. Press **▲** or **▼** to scroll to **Done**, then press **MENU/SELECT** to save the setting. To exit without making changes, press **CANCEL**.

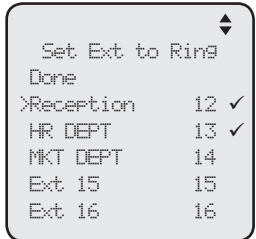
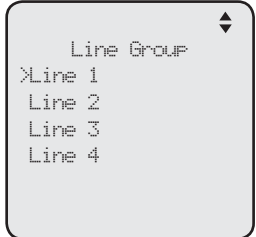
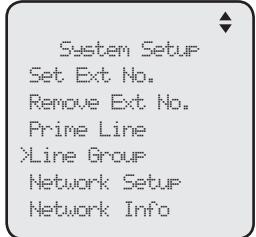

Getting started

System setup

Network setup

The console must have an IP address locating its connection with the Ethernet switch or router. You can set the console to obtain the IP from a DHCP server automatically or assign a specific IP on your own. The console obtains the IP from the Ethernet switch or router automatically by default. You are not recommended to change the IP assigned to this console after you have connected other desksets. If you do so, the entire system may need to be reset.

To enable the Auto set IP:

1. When the console is idle, press **MENU/SELECT**.
2. Press **▲** or **▼** to scroll to **System Setup**, then press **MENU/SELECT** or **▶/SKIP**.
3. Press **▲** or **▼** to scroll to **Network Setup**, then press **MENU/SELECT** or **▶/SKIP**.
4. Press **▲** or **▼** to scroll to **Auto set IP**, then press **MENU/SELECT** or **▶/SKIP**.
5. Press **▲** or **▼** to scroll to **Yes**, then press **MENU/SELECT** or **▶/SKIP**.
6. The screen displays **Obtain IP from DHCP server?**
Press **MENU/SELECT** to save the setting.
7. The screen displays **Obtaining IP from DHCP server Please wait...** It takes up to one minute to obtain the IP address.
8. The screen displays **IP obtained: XXX.XXX.X.XXX Check network info?** when the IP is successfully assigned. Press **MENU/SELECT** to read the network info, or press **CANCEL** to return to the previous menu.
 - If the system fails to assign an IP automatically, the screen briefly displays **Unable to obtain IP. Please check DHCP server.** and then **Set static IP to this extension?** You may press **MENU/SELECT** to enter the Static IP setting menu.
9. Reboot the console to update the IP.

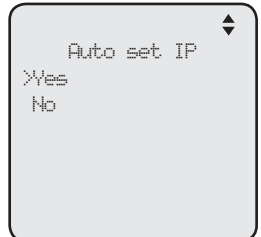
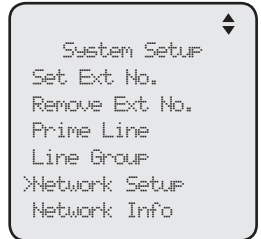

Getting started

System setup

Network setup (continued)

If you want to switch from **Auto set IP** to **Set static IP**, you have to disable the **Auto set IP** setting first.

To disable Auto set IP:

1. When the console is idle, press **MENU/SELECT**.
2. Press **▲** or **▼** to scroll to **System Setup**, then press **MENU/SELECT** or **▶/SKIP**.
3. Press **▲** or **▼** to scroll to **Network Setup**, then press **MENU/SELECT** or **▶/SKIP**.
4. Press **▲** or **▼** to scroll to **Auto set IP**, then press **MENU/SELECT** or **▶/SKIP**.
5. Press **▲** or **▼** to scroll to **No**, then press **MENU/SELECT** or **▶/SKIP** to save the setting. To exit without making changes, press **CANCEL**.

```
Network Setup
>Auto set IP
  Set static IP
  Discovery method
```

```
Auto Set IP
Yes
>No
```

To enable Set static IP:

1. When the console is idle, press **MENU/SELECT**.
2. Press **▲** or **▼** to scroll to **System Setup**, then press **MENU/SELECT** or **▶/SKIP**.
3. Press **▲** or **▼** to scroll to **Network Setup**, then press **MENU/SELECT** or **▶/SKIP**.
4. Press **▲** or **▼** to scroll to **Set static IP**, then press **MENU/SELECT** or **▶/SKIP**.
5. The screen displays **Enter static IP**. Use the dialing keys to enter a specific IP.
 - Press **DELETE** to delete a character.
 - Press **#** to add a dot.
 - Press **◀/REPEAT** or **▶/SKIP** to move the cursor to the left or right.

```
Network Setup
Auto set IP
>Set static IP
  Discovery method
```

```
Enter static IP
192.168.1._
<'#' = Add dot>
```

When entering a specific IP, make sure the IP range is not blocked by the Ethernet switch or router.

Getting started

System setup

Network setup (continued)

6. Press **MENU/SELECT** to proceed. The screen displays **Subnet mask: XXX.XXX.X.X**. Use the dialing keys to enter a specific subnet mask.
 - Press **DELETE** to delete a character.
 - Press **#** to add a dot.
 - Press **◀/REPEAT** or **▶/SKIP** to move the cursor to the left or right.
7. Press **MENU/SELECT** to proceed. The screen displays **Router/Gateway: XXX.XXX.X.XXX**. Use the dialing keys to enter a specific gateway.
 - Press **DELETE** to delete a character.
 - Press **#** to add a dot.
 - Press **◀/REPEAT** or **▶/SKIP** to move the cursor to the left or right.
8. Press **MENU/SELECT** to save. The screen displays **IP obtained: XXX.XXX.X.XXX Check network info?** Press **MENU/SELECT** to read the network info, or press **CANCEL** to return to the main menu.
 - If the IP entered is invalid, the screen displays **IP is invalid**. briefly and then returns to the **Enter static IP** screen.
9. Reboot the console to update the IP.

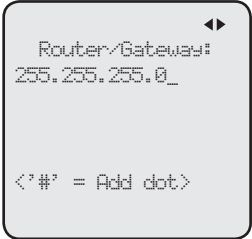

Getting started

System setup

Discovery method

Use this feature to change the connection of the console if you cannot connect an existing deskset to a newly purchased console, or when you changed to a different router. By default, the discovery method is set to Mode B.

To change the discovery method:

1. When the console is idle, press **MENU/SELECT**.
2. Press **▲** or **▼** to scroll to **System Setup**, then press **MENU/SELECT** or **▶/SKIP**.
3. Press **▲** or **▼** to scroll to **Network Setup**, then press **MENU/SELECT** or **▶/SKIP**.
4. Press **▲** or **▼** to scroll to **Discovery method**, then press **MENU/SELECT** or **▶/SKIP**.
5. Press **▲** or **▼** to scroll between **Mode A** or **Mode B (Default)**, then press **MENU/SELECT** or **▶/SKIP** to save the setting. To exit without making changes, press **CANCEL**.

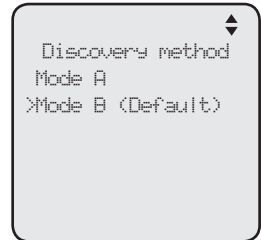
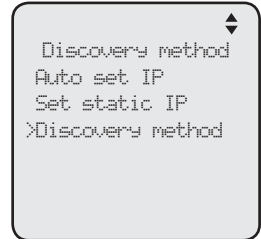
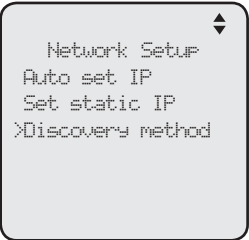

Getting started

System setup

Network info

Use this feature to view the information of the IP address, subnet mask, router/gateway, DNS servers, and DHCP server of this console.

To check the network information:

1. When the console is idle, press **MENU/SELECT**.
2. Press **▲** or **▼** to scroll to **System Setup**, then press **MENU/SELECT** or **▶/SKIP**.
3. Press **▲** or **▼** to scroll to **Network Info**, then press **MENU/SELECT** or **▶/SKIP**.
4. Press **▲** or **▼** to browse through the network information.

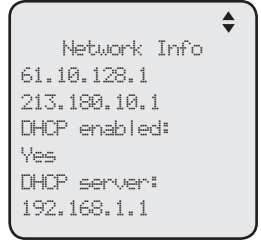
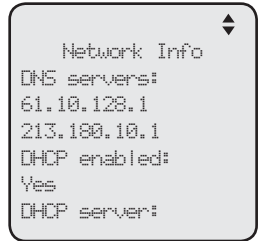
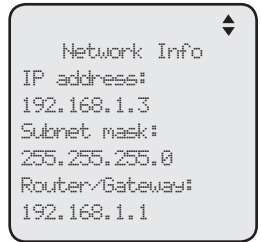
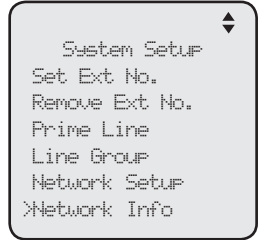

Telephone settings

Telephone setup

Ringer volume

Use this feature to set the ringer volume to one of six levels or turn the ringer off. When the ringer is off, the  icon appears on the console screen. The UP416 console stores the volume setting for all lines.

1. When the console is idle, press **MENU/SELECT**.
2. Press **MENU/SELECT** or **▶/SKIP** to select **Ringers**.
3. Press **MENU/SELECT** again or **▶/SKIP** to select **Ringer Volume**.
4. Press **▲**, **▼**, **◀/REPEAT**, **▶/SKIP**, or **▲/VOLUME/▼** on the console to adjust the ringer volume.
5. Press **MENU/SELECT** to save the setting and return to the previous menu. To exit without making changes, press **CANCEL**.

-OR-

When the console is idle, press **▲/VOLUME/▼** to adjust the ringer volume, then press **MENU/SELECT** to save.



NOTE: The ringer volume also determines the ringer volume for intercom calls. If the console ringer volume is set to off, it is silenced for all incoming calls, including intercom calls.

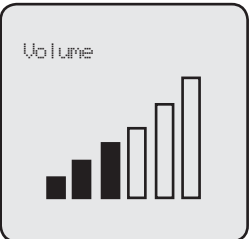
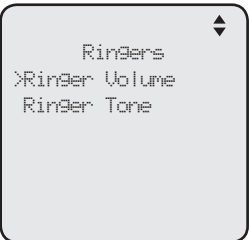
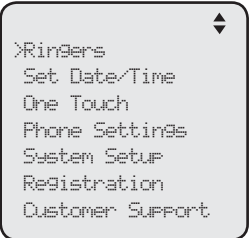

Telephone settings

Telephone setup

Ringer tone

Use this feature to choose one of the ten ringer tones for incoming calls. You can choose different ringer tones for different lines so you can easily identify which line is calling.

1. When the console is idle, press **MENU/SELECT**.
2. Press **MENU/SELECT** or **▶/SKIP** to select **Ringers**.
3. Press **▲** or **▼** to scroll to **Ringer Tone**, then press **MENU/SELECT** or **▶/SKIP**.
4. Press **▲** or **▼** to select the desired line (**Line 1**, **Line 2**, **Line 3** or **Line 4**), then press **MENU/SELECT** or **▶/SKIP**.
5. Press **▲** or **▼** to select the desired ringer tone.
6. Press **MENU/SELECT** or **▶/SKIP** to save the setting and return to the previous menu. To exit without making changes, press **CANCEL** or **◀/REPEAT**.
7. Repeat steps 4-6 above to choose ringer tones for other lines if desired.

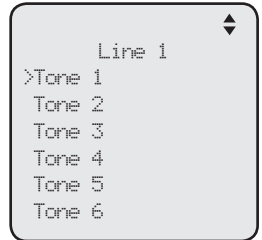
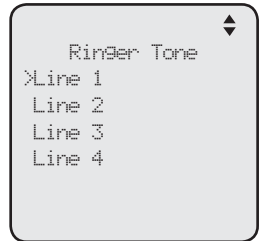
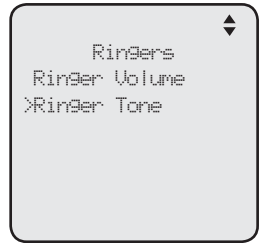

Telephone settings

Telephone setup

Set date/time

The answering system displays the date and time of the message while playing messages. Before using the answering system, set the date and time as follows.

Follow the steps below to set the month, day, year and time:

1. When the console is idle, press **MENU/SELECT**.
2. Press **▲** or **▼** to scroll to **Set Date/Time**, then press **MENU/SELECT** or **►/SKIP**.
3. Use the dialing keys to enter the month (MM), day (DD) and year (YY). Press **◀/REPEAT** or **►/SKIP** to scroll between month, day and year.
4. Press **MENU/SELECT** to move to the time setting.
5. Use the dialing keys to enter the hour and minute.
6. Press **◀/REPEAT** or **►/SKIP** to select **AM** or **PM**.
7. Press **MENU/SELECT** to save the setting and return to the previous menu. To exit without making changes, press **CANCEL**.



```
Ringers
>Set Date/Time
One Touch
Phone Settings
System Setup
Registration
Customer Support
```



```
Set Date
01/01/14
MM/DD/YY
```



```
Set Time
12:00 ◀ AM ▶
```



Telephone settings

Telephone setup

LCD language

This feature allows you to change the language used for all screen displays. The language settings on the console and desksets are independent. By default, the language is set to **English**.

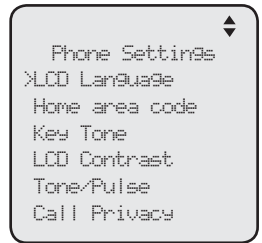
1. When the console is idle, press **MENU/SELECT**.
2. Press ▲ or ▼ to scroll to **Phone Settings**, then press **MENU/SELECT** or ►/SKIP.
3. Press **MENU/SELECT** again or ►/SKIP to select **LCD Language**.
4. Press ▲ or ▼ to select **English**, **Français** or **Español**.
5. Press **MENU/SELECT** or ►/SKIP again to save the setting and return to the previous menu. To exit without making changes, press **CANCEL**.



Telephone settings

Telephone setup

Home area code

Use this feature to program this console to recognize your home area code. This feature makes it easy for you to place a call from the caller ID log.

When you receive a call from within your home area code, the caller ID information only displays the seven digits of the telephone number, and when you dial from the call log, only seven digits are dialed.

1. When the console is idle, press **MENU/SELECT**.
2. Press **▲** or **▼** to scroll to **Phone Settings**, then press **MENU/SELECT** or **▶/SKIP**.
3. Press **▲** or **▼** to scroll to **Home area code**, then press **MENU/SELECT** or **▶/SKIP**.
4. The console displays **Home area code**. Use the dialing keys to enter a three-digit area code.
 - Press **◀/REPEAT** or **▶/SKIP** to move the cursor to the left or right.
 - Press **DELETE** to delete a digit.
5. Press **MENU/SELECT** to save the setting and return to the previous menu. To exit without making changes, press **CANCEL**.

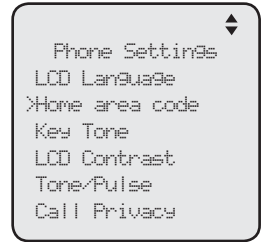

Telephone settings

Telephone setup

Key tone

The console is set to beep with each key press. If you turn off the key tone, there are no beeps when you press keys.

1. When the console is idle, press **MENU/SELECT**.
2. Press **▲** or **▼** to scroll to **Phone Settings**, then press **MENU/SELECT** or **▶/SKIP**.
3. Press **▲** or **▼** to scroll to **Key Tone**, then press **MENU/SELECT** or **▶/SKIP**.
4. Press **▲** or **▼** to choose **On** or **Off**.
5. Press **MENU/SELECT** or **▶/SKIP** to save the setting and return to the previous menu. To exit without making changes, press **CANCEL** or **◀/REPEAT**.

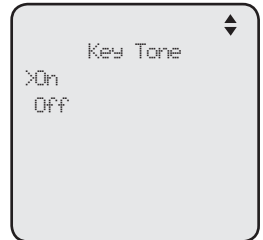
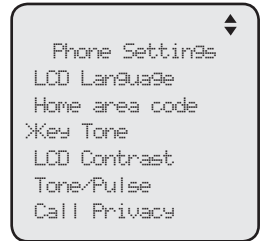

LCD contrast

Use this feature to adjust the screen contrast to one of eight levels to optimize readability in different lighting conditions.

1. When the console is idle, press **MENU/SELECT**.
2. Press **▲** or **▼** to scroll to **Phone Settings**, then press **MENU/SELECT** or **▶/SKIP**.
3. Press **▲** or **▼** to scroll to **LCD Contrast**, then press **MENU/SELECT** or **▶/SKIP**.
4. Press **▲** or **▼** to choose the desired screen contrast level (**Level 1 - Level 8**).
5. Press **MENU/SELECT** or **▶/SKIP** to save the setting and return to the previous menu. To exit without making changes, press **CANCEL** or **◀/REPEAT**.

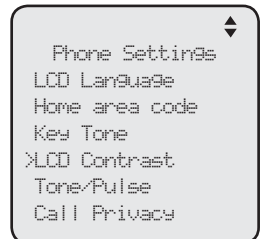

Telephone settings

Telephone setup

Dial mode

The dial mode is preset to tone dialing. If you have pulse (rotary) service, you must change the dial mode to pulse dialing before using the telephone.

1. When the console is idle, press **MENU/SELECT**.
2. Press **▲** or **▼** to scroll to **Phone Settings**, then press **MENU/SELECT** or **▶/SKIP**.
3. Press **▲** or **▼** to scroll to **Tone/Pulse**, then press **MENU/SELECT** or **▶/SKIP**.
4. Press **▲** or **▼** to choose **Tone** or **Pulse**.
5. Press **MENU/SELECT** or **▶/SKIP** to save the setting and return to the previous menu. To exit without making changes, press **CANCEL** or **◀/REPEAT**.

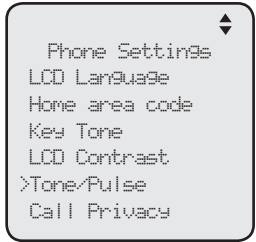

Call privacy

The call privacy is set to **Off** by default. The console allows other extensions to join a call in progress. You can turn this setting on to ensure that only one device uses a line at a time.

To turn this feature on or off:

1. When the console is idle, press **MENU/SELECT**.
2. Press **▲** or **▼** to scroll to **Phone Settings**, then press **MENU/SELECT** or **▶/SKIP**.
3. Press **▲** or **▼** to scroll to **Call Privacy**, then press **MENU/SELECT** or **▶/SKIP**.
4. Press **▲** or **▼** to scroll to **On** or **Off**.
5. Press **MENU/SELECT** or **▶/SKIP** to save the setting and return to the previous menu. To exit without making changes, press **CANCEL** or **◀/REPEAT**.

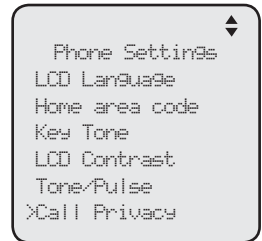

NOTE: To temporarily change the call privacy setting during a call, see page 52.

Telephone settings

Telephone setup

Music on hold

Music on hold (M.O.H) is available on this console. When this feature is turned on and you put a call on hold, the far end of the call will hear the music that comes with the console. You can select a desired built-in music for this feature.

When this feature is turned off and you put a call on hold, the far end of the call will hear a beep every 10 seconds.

1. When the console is idle, press **MENU/SELECT**.
2. Press **▲** or **▼** to scroll to **Phone Settings**, then press **MENU/SELECT** or **▶/SKIP**.
3. Press **▲** or **▼** to scroll to **Music on Hold**, then press **MENU/SELECT** or **▶/SKIP**.
4. Press **▲** or **▼** to select a desired music or **Off** if you want to turn this feature off.
5. Press **MENU/SELECT** or **▶/SKIP** to save the setting and return to the previous menu. To exit without making changes, press **CANCEL** or **◀/REPEAT**.

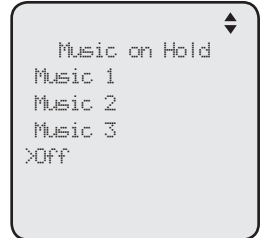
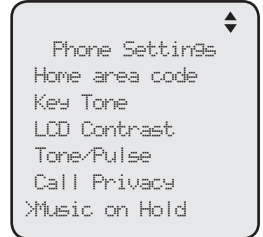

NOTE: Source of music files: FreeMusicArchive.org. Used under open license.

Hold reminder

When this feature is on and there is a call on hold, the console beeps once every 30 seconds.

To turn this feature on or off:

1. When the console is idle, press **MENU/SELECT**.
2. Press **▲** or **▼** to scroll to **Phone Settings**, then press **MENU/SELECT** or **▶/SKIP**.
3. Press **▲** or **▼** to scroll to **Hold Reminder**, then press **MENU/SELECT** or **▶/SKIP**.
4. Press **▲** or **▼** to scroll to **On** or **Off**.
5. Press **MENU/SELECT** or **▶/SKIP** to save the setting and return to the previous menu. To exit without making changes, press **CANCEL** or **◀/REPEAT**.

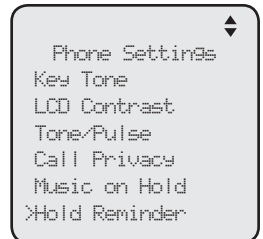

Telephone settings

Telephone setup

Phone rename

Use this feature to rename the console. If you have to rename your console after initial setup, you are recommended to do so before connecting any system desksets.

To change the name:

1. When the console is idle, press **MENU/SELECT**.
2. Press **▲** or **▼** to scroll to **Phone Settings**, then press **MENU/SELECT** or **▶/SKIP**.
3. Press **▲** or **▼** to scroll to **Phone Rename**, then press **MENU/SELECT** or **▶/SKIP**.
4. Use the dialing key keys to change the name (up to 12 characters).
 - Press **◀/REPEAT** or **▶/SKIP** to move the cursor to the left or right.
 - Press **DELETE** to delete a character.
5. Press **MENU/SELECT** to save the setting and return to the previous menu. To exit without making changes, press **CANCEL**.

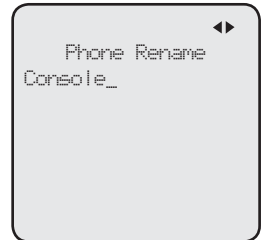
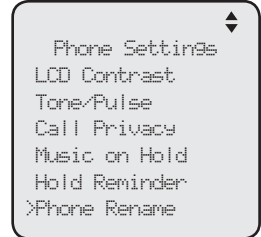

Set default

Use this feature to reset all settings of this console to their default settings. All phone settings, directory, caller ID history, redial list, one-touch memory, central and private mailbox messages will be reset.

To reset all feature settings to default:

1. When the console is idle, press **MENU/SELECT**.
2. Press **▲** or **▼** to scroll to **Phone Settings**, then press **MENU/SELECT** or **▶/SKIP**.
3. Press **▲** or **▼** to scroll to **Set Default**.
4. Press **MENU/SELECT** or **▶/SKIP**. The screen displays **Set phone to default settings? Press 'SELECT' to confirm**.
5. Press **MENU/SELECT** to confirm. The console reboots to reset all settings.

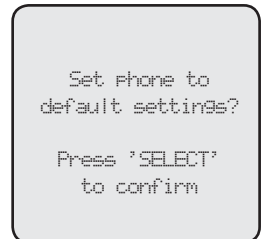
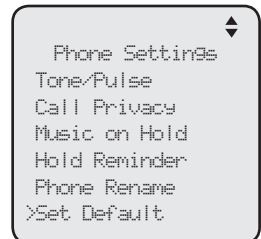

NOTE: After you reset the console to default, you will have to assign the extension numbers of all your system desksets again. Refer to the **Set extension number** section in the UP406 user's manual for instructions.

Telephone settings

Telephone setup

Customer support

Use this feature to display the VTech website.

1. When the console is idle, press **MENU/SELECT**.
2. Press ▲ or ▼ to scroll to **Customer Support**, then press **MENU/SELECT** or ►/**SKIP**.
3. Press **CANCEL** to return to the main menu.



```
businessphones.  
vtech.  
com
```

Telephone operation

Telephone operation

The telephone comes programmed to select a line automatically for calls when you do not press a line key. To override the automatic line selection setting, see **Prime line** on page 31 for details. When you answer a call, the telephone automatically selects the ringing line.

Line indicators

Each of the four indicators on **LINE 1-LINE 4** indicate the state of the corresponding telephone line.

- On when the corresponding line is in use.
- Flashes slowly when the line is on hold.
- Flashes rapidly when there is an incoming call on the corresponding line.

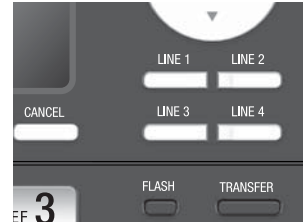

Making and ending a call

To make a call using the console:

1. Lift the handset or press **SPEAKER** .

-OR-

To override automatic line selection, press **LINE 1-LINE 4** for the desired line, then lift the handset.

2. Wait for a dial tone, then enter the telephone number.
The screen displays the elapsed time as you talk (in hours, minutes and seconds).

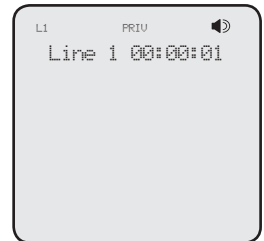

To end a call using the console:

- Place the handset on the console to hang up.

-OR-

- Press the corresponding line key (**LINE 1-LINE 4**).

-OR-

- If you are using the speakerphone, press **SPEAKER**  to hang up.



NOTE: The elapsed time is not affected by accessing services from your telephone service provider.

Telephone operation

Telephone operation



To make a call using a corded headset:

Make sure a corded headset is connected to the console (page 28).

1. Press **HEADSET** on the console.
2. Wait for a dial tone, then dial the number.
3. To hang up, press **HEADSET**.

To make a call using a cordless headset:

You can make a call using a registered cordless headset (see **Adding and registering a cordless headset** on page 26). For more details on the cordless headset operation, refer to the IS6100 user's manual.

1. Enter the telephone number. Press **DELETE** to make corrections.
2. Lift the handset or press **SPEAKER**  to dial.
3. Press  on the cordless headset.
4. To hang up, press .



On hook dialing (predialing)

1. Enter the telephone number. Press **DELETE** to make corrections.
2. Lift the handset or press **SPEAKER**  to dial.



-OR-

To override automatic line selection, press **LINE 1-LINE 4** for the desired line, then lift the handset.

Full-duplex speakerphone

During a call, press **SPEAKER**  to switch between handsfree speakerphone and normal handset use. Press **SPEAKER**  again if you are using speakerphone or place the handset on the console to hang up.

Answering a call

Lift the handset, or press the corresponding line key (**LINE 1-LINE 4**), **SPEAKER** , **HEADSET** on the console or press  on a registered cordless headset to answer an incoming call.

Temporary ringer silencing

When the telephone is ringing, you can temporarily silence the ringer of the console without disconnecting the call. Press **MUTE** to silence the ringer. The next call rings normally at the preset volume.

Telephone operation

Options while on calls

Call waiting

If you subscribe to call waiting service with your telephone service provider, you hear a beep if someone calls while you are in the middle of a call.

- Press **FLASH** to put your current call on hold and take the new call.
- Press **FLASH** at any time to switch back and forth between calls.

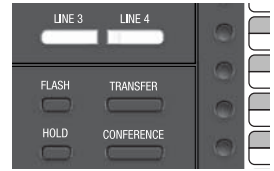

Volume control

Use this feature to set the listening volume to one of six levels for each of the listening options (corded handset, corded headset and speakerphone). All settings are independent. While on a call, press **▲/VOLUME/▼** to adjust the listening volume.

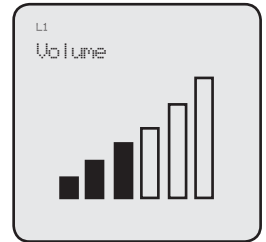

Mute

Use this feature during a telephone conversation to silence the microphone. You can hear the caller, but the caller cannot hear you.

To mute a call:

- Press **MUTE**. When mute is on, the **MUTE** button lights up; the screen also displays **MUTE**.

To take a call off mute:

- Press **MUTE** again and resume speaking.

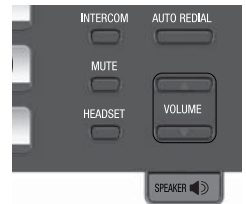

Temporary tone dialing

If you have pulse (rotary) service only, use this feature to temporarily switch pulse to touch-tone dialing during a call by pressing **TONE ✕**.

1. Press **TONE ✕** during a call.
2. Use the dialing keys to enter the desired number. The telephone sends touch-tone signals.

The telephone automatically returns to pulse dialing mode after you end the call.

Telephone operation

Options while on calls

Hold

Use this feature to hold one line while accessing another, or as part of the conference and call transfer features.

While on a call, press **HOLD**. The corresponding line key (**LINE 1-LINE 4**) indicator for the line on hold flashes slowly. After the call has been put on hold, a beep sounds every 30 seconds. (To turn off the reminder beep, see **Hold reminder** on page 45).

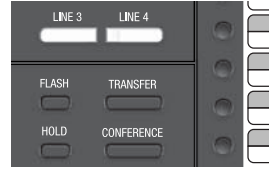

If you are using the speakerphone, the speakerphone turns off and the **SPEAKER**  key turns off automatically after you press **HOLD**. If you are using the corded headset, the headset turns off and the **HEADSET** key turns off automatically after you press **HOLD**.

To release the hold, press the line key (**LINE 1-LINE 4**) of the line being put on hold.

Music on hold (M.O.H) is available on this console if you have turned on the **Music on hold** setting (page 45). When you put a call on hold, the far end of the call will hear the selected music that comes with the console.



NOTES:

- You cannot put an intercom call on hold.
- The call privacy setting remains unchanged after the call is put on hold.
- The call ends automatically after it is put on hold for 10 minutes.

Switching between lines

Use this feature to switch between lines during an outside call:

1. Press the desired line key (**LINE 1-LINE 4**) of the telephone line you want to make or answer call. The current call is put on hold automatically.
2. To return to the first call, press the line key (**LINE 1-LINE 4**) of the original call. The second line is put on hold automatically.

Telephone operation

Options while on calls

Call privacy

During a call, you can temporarily change the call privacy setting to allow or disallow other extensions to join the call. The original setting is automatically restored after you hang up.

To turn call privacy off during a call:

1. While on a call, press **MENU/SELECT**.
2. Press **MENU/SELECT** to select **Call Privacy**.
3. Press **▲** or **▼** to choose **Off**, then press **MENU/SELECT**.

Other extensions can now join the call by pressing the corresponding line key (**LINE 1-LINE 4**).

To turn call privacy back on during a call:

1. While on a call, press **MENU/SELECT**.
2. Press **MENU/SELECT** to select **Call Privacy**.
3. Press **▲** or **▼** to choose **On**, then press **MENU/SELECT**. The console displays **PRIV**.

No extension can join the call now. If another extension tries to access the line you are using, it displays **Line is not available at this time**.

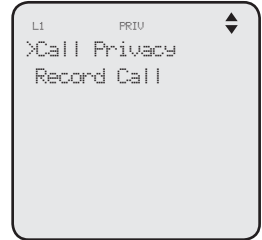

NOTES:

- You cannot set call privacy during intercom calls.
- To set call privacy for every incoming and outgoing call, see page 44.

Telephone operation

Options while on calls

Recording a call

Use this feature to record a phone conversation during a call. The recording is treated the same as memos and is marked as a new message in the private mailbox. You cannot record a conference call nor an intercom call and you cannot use another line while you are recording a phone conversation. Listen to recorded conversation the same way as incoming messages or memos (see **Message playback** on page 98).

To record a call:

1. While on a call, press **MENU/SELECT**.
2. Press ▲ or ▼ to scroll to **Record Call**, then press **MENU/SELECT**.
3. Press **MENU/SELECT** to choose **Start recording**.
4. The recording starts and the screen shows **REC**. There is a beep sound.



NOTE: To ensure that you are in compliance with any federal or state regulations regarding recording a telephone call, you should start the recording process and then inform the other party that you are recording the call.

To stop recording:

Place the handset back to the console, or press **SPEAKER**  to hang up if you are using the speakerphone.

-OR-

1. Press **MENU/SELECT** during the recording.
2. Press ▲ or ▼ to scroll to **Record Call**, then press **MENU/SELECT**.
3. Press **MENU/SELECT** to choose **Stop recording**. The system saves the conversation into the private mailbox.



Telephone operation

Options while on calls

Chain dialing

While you are on a call, you can initiate a dialing sequence from the numbers in the directory, caller ID history, redial list or one-touch memory.

Chain dialing can be useful if you wish to access other numbers (such as bank account numbers or access codes) from the directory, caller ID history, redial list or one-touch memory.

To access the directory while on a call:

1. Press **DIRECTORY**, then press ▲ or ▼ to scroll to the desired entry.
2. Press **MENU/SELECT** to dial the desired number. To exit without making changes, press **CANCEL** and continue with the conversation.

To access the call history while on a call:

1. Press **CALL HISTORY**, then press ▲ or ▼ to scroll to the desired entry.
2. Press **MENU/SELECT** to dial the desired number. To exit without making changes, press **CANCEL** and continue with the conversation.

To access the redial list while on a call:

1. Press **AUTO REDIAL**, then press ▲ or ▼ to scroll to the desired entry.
2. Press **MENU/SELECT** to dial the desired number. To exit without making changes, press **CANCEL** and continue with the conversation.

To access the one-touch memory while on a call:

Press the desired one-touch key for the number in the upper location.

-OR-

Press **LOWER**, then press the desired one-touch key for the number in the lower location.

Telephone operation

Redial

The last 10 telephone numbers dialed (up to 30 digits) are stored in the console.

To view the 10 most recently dialed numbers

1. Press **AUTO REDIAL** to enter the redial list and display the most recently called number.
2. Press **▲** or **▼** to view other recently called numbers.
3. Press **CANCEL** to exit the redial list.

To redial a number

When the desired number displays on the screen:

- Lift the handset.

-OR-

- Press **SPEAKER**  or **HEADSET**.

To override automatic line selection, press **LINE 1-LINE 4** for the desired line, then lift the handset.

To copy a redial entry to directory

1. Press **AUTO REDIAL** to enter the redial list and display the most recently called number.
2. Press **▲** or **▼** to view other recently called numbers.
3. Press **◀/REPEAT** or **▶/SKIP** to choose **Copy to DIR**, then press **MENU/SELECT**.
4. The console displays **Enter Name**. Use the dialing keys to enter the name (up to 15 characters).
 - Press **◀/REPEAT** or **▶/SKIP** to move the cursor to the left or right.
 - Press **DELETE** to delete a character.
5. Press **MENU/SELECT** to save. The console displays **Enter Number**. Use the dialing keys to enter the number (up to 30 digits).
 - Press **DELETE** to delete a digit.
 - Press **◀/REPEAT** or **▶/SKIP** to move the cursor to the left or right.
 - You can include a pause while storing a dialing sequence that requires one during actual dialing. Press **▲** or **▼** to choose **Add pause**, then press **MENU/SELECT**. A **P** appears on the screen.
 - Store a signal for switching to temporary tone signaling. If you have dial pulse (rotary) service, this signal is required for some special services. Press **▲** or **▼** to choose **Send tone**, then press **MENU/SELECT**. A **T** appears on the screen. All numbers you enter after this will send touch-tone signals during dialing.

Telephone operation

Redial

To copy a redial entry to directory (continued)

- You can store the flash signal required by some special services as part of a dialing sequence. Press ▲ or ▼ to choose **Add flash**, then press **MENU/SELECT**. An **F** appears on the screen.
6. Press ▲ or ▼ to choose **Done**, then press **MENU/SELECT**. To exit without making changes, press ▲ or ▼ to choose **Cancel** and then press **MENU/SELECT**, or press **CANCEL** to return to the previous menu.

To copy a redial entry to one-touch memory

1. Press **AUTO REDIAL** to enter the redial list and display the most recently called number.
2. Press ▲ or ▼ to view other recently called numbers.
3. Press ◀/REPEAT or ▶/SKIP to choose **Copy to 1-touch**, then press **MENU/SELECT**.
4. The console displays **Press a 1-touch key to save the number**.
 - Press the one-touch button for the destination party in the upper location (the first 16 one-touch locations).
 - OR-
 - Press **LOWER**, then the one-touch button for the destination party in the lower location (the second 16 one-touch locations).
5. The console displays **Number saved to 1-touch key**.

To delete a number

While the screen displays the desired number, press **DELETE** to delete the number from the redial memory. The screen displays **Redial deleted**.

Telephone operation

Redial

Auto-redial

Use this feature to automatically redial a number up to ten times.

1. Press **AUTO REDIAL** to enter the redial list and display the most recently called number.
2. Press **▲** or **▼** to view other recently called numbers.
3. While the screen displays the desired number, press **◀/REPEAT** or **▶/SKIP** to choose **Auto redial**, then press **MENU/SELECT**.
4. The telephone calls the desired number using the speakerphone. The screen displays **Redial in XX sec.**
5. When the other party answers, you will need to take an action to speak with the other party and stop the auto-redial attempts. Press **MUTE** on the console, then lift the handset, press **SPEAKER** **◀▶** or **HEADSET** to speak with the other party.
 - After a call is placed, if the line is busy, you will hear a busy tone for a few seconds before the console hangs up. The call will be redialed 30 seconds later. This process repeats up to 10 times or until the called number is no longer busy. If the line is still busy after 10 attempts, no more attempts are made.
 - If the line is ringing but no party answers after two attempts, no more attempts are made.
 - If you want to turn off the auto-redial feature during the 30-second waiting time, press **CANCEL**.

Telephone operation

Conference call

The system can support 5-way conference with a maximum of one outside call and four system extensions (including the initiating party), or two outside calls and three system extensions (including the initiating party). The outside call must be established first because an intercom call cannot be placed on hold.

There are two ways to establish a conference call.

A. Inviting parties using Intercom

The party who initiates the conference invites other system extensions to join the conference by using intercom after establishing the first outside call.

-OR-

B. Join a call in progress

Other system extensions can join the call in progress by pressing the line key which is currently in use for the conference to join the call.

A. Inviting parties using Intercom

1. Make or answer an outside call.
2. Press another available line key to make another outside call. The original outside call is put on hold. When the external party picks up, you can have a private conversation with that party.

-OR-

Press **INTERCOM**. The outside call is put on hold. Press **▲** or **▼** to scroll to the desired extension, or enter the desired extension number directly. The called extension picks up the intercom call. You can now have a private conversation with that extension.

3. Press **CONFERENCE** at any time to begin the conference call.
4. If necessary, repeat step 2 (Intercom method) and step 3 above to invite another system extension to join the conference until the maximum capacity is reached.
5. Place the corded handset on the console or press **SPEAKER**  if you are using the speakerphone to hang up. If the party who initiates the conference call hangs up, the conference call will be ended. The call will also be ended when all parties hang up.

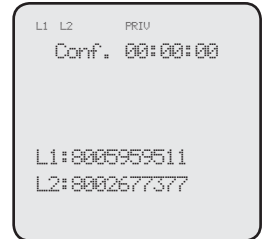

NOTE: If you want to start a conference with two outside calls, make sure you have invited two outside calls before inviting any system extensions.

Telephone operation

Conference call

To drop an outside line:

- Press the corresponding line key (**LINE 1-LINE 4**).

-OR-

- If there are two outside calls, press **MENU/SELECT** and then press ▲ or ▼ to choose **End Line X**. Press **MENU/SELECT** to confirm.

-OR-

- If the other end of the outside line hangs up the call, press the corresponding line key (**LINE 1-LINE 4**) to release that line for other system extension use.

B. Join a call in progress

1. Make or answer an outside call on the console, then press **MENU/SELECT**.
2. If the call privacy of your console is set to **On**, follow the instructions of **To turn call privacy off during a call** on page 52 to turn off the setting temporarily.
3. Any system extension can join the call by pressing the line key currently in use to join the conference until the maximum capacity is reached.
4. Place the corded handset on the console or press **SPEAKER**  if you are using speakerphone to hang up. The call will be ended when all parties hang up.



NOTES:

- If the system extension which initiated the call does not turn off the call privacy setting and you try to join that call, your deskset screen displays **Line is not available at this time**.
- If you have answered another outside call during a conference and want to resume the original call, end the existing call first, then lift the corded handset, or press **SPEAKER** , or press **CONFERENCE**.

Telephone operation

Conference call

Call scenario

The table below provides you with more information on the number of outside lines available for use during a conference call under different call scenarios.

A. Inviting parties using Intercom

Device that starts a conference call	Number of outside calls in a conference	Number of system extensions in a conference	Outside lines available for other extension to use
Console	1	1	2
	1	2	1
	2	1	1
	2	2	0
Deskset	1	1	3
	1	2	3
	2	1	2
	2	2	2

B. Join a call in progress

Device that starts a conference call	Number of outside calls in a conference	Number of system extensions joined in a conference	Outside lines available for other extension to use
Console/Deskset	1	1	2
		2	1
		3	0

Telephone operation

Intercom

You can use the intercom feature for conversations between the console and a system deskset, or between two system desksets.

The console and each deskset in the telephone system **MUST** be assigned a unique extension number for the intercom feature to work. The assignment is done when the console is initially set up.

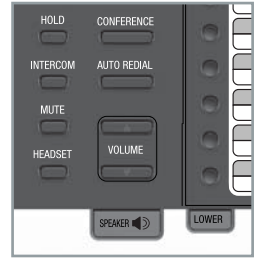

Make an intercom call to an extension

1. Press **INTERCOM** on the console when it is idle.
 2. Press ▲ or ▼ to scroll to a desired extension, then press **MENU/SELECT**.
- OR-**
- Use the dialing keys to dial the extension number.
3. The console displays **Intercom to: XX** (**XX** represents the extension number of the destination device).

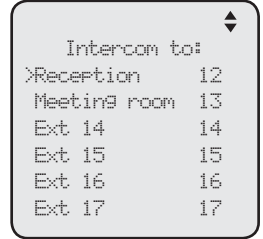

-OR-

If you have assigned extension numbers as one-touch entries (see **Assign a one-touch entry** on pages 64-65), you can initiate an intercom by pressing the desired one-touch button.

1. When the console is idle, press the desired one-touch button, or press **LOWER** followed by the desired one-touch button.
2. The console displays **Intercom to: XX** (**XX** represents the extension number of the destination device).



NOTES:

- Before the intercom call is answered, you can cancel the intercom by pressing **SPEAKER**  or **CANCEL**.
- You cannot intercom an extension that is on a call.
- If all four telephone lines are in use, the intercom feature is not available.

Answer an intercom call

When you receive an intercom call, you hear a ringing tone and your screen displays **Intercom from: XX** (**XX** represents the extension number of the calling device). Lift the handset or press **SPEAKER**  to answer.

End an intercom call

Place the handset back to the console or press **SPEAKER**  if you are using the speakerphone.

Answer an incoming call during an intercom call

If you receive an incoming outside call during an intercom call, there is an alert tone.

To answer the call, press the corresponding line key (**LINE 1-LINE 4**). The intercom call ends automatically.

Telephone operation

Call transfer

You can transfer a call to any other system telephone. Only the recipient extension can answer the transferred call; other extensions cannot seize the line at that moment.



Blind transfer

While on a call, you can transfer a call directly without notifying the desired extension:

1. Press **TRANSFER** on the console while on a call, the call is put on hold.
2. Press **▲** or **▼** to scroll to the desired extension, then press **MENU/SELECT**.

-OR-

Use the dialing keys to dial the extension number.

3. The destination device rings. Choose either option below.
 - Answer the call by lifting the corded handset or pressing **SPEAKER** .
 - You can resume the call by pressing the corresponding flashing line key (**LINE 1-LINE 4**) on the console before the destination device answers the call.
4. Put the handset on the console or press **SPEAKER**  to hang up.

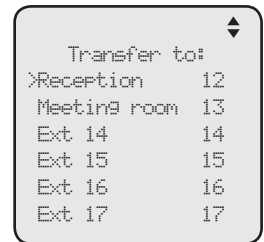
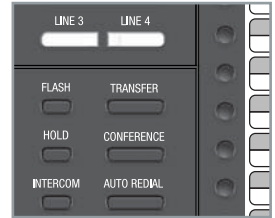

NOTES:

- If the private mailbox of the destination extension is off, the transferred call will only ring on the destination extension for five minutes. If the destination extension does not answer within that period, the transferred call ends.
- If the private mailbox of the destination extension is busy, the call ends.
- If the destination extension does not answer within five minutes, the extension which initiated the transfer can retrieve the call within five minutes after the call has been transferred by pressing the corresponding line key.

Telephone operation

Call transfer using intercom

Transfer a call and speak to the receiving party

You can transfer a call and speak to the receiving party before completing the transfer while on a call:

1. Press **INTERCOM** on the console while on a call. The call is put on hold.
2. Press ▲ or ▼ to scroll to a desired extension, then press **MENU/SELECT**.

-OR-

Use the dialing keys to dial the extension number.

3. The destination extension rings and the call can be answered by lifting the handset or pressing **SPEAKER** . You can now talk to the destination party privately.
4. Press **TRANSFER** to transfer the call to the destination extension. The console returns to idle.

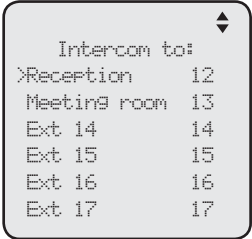

Intercom to:	
>Reception	12
Meeting room	13
Ext 14	14
Ext 15	15
Ext 16	16
Ext 17	17

Telephone operation

One touch

This telephone has 32 one- and two-touch memory locations (speed dial locations) where you can store the phone numbers or system extension numbers you wish to dial more quickly. You can store up to 30 digits in each location.

You can access the first 16 locations using only the one-touch buttons. To access the remaining 16 locations, press **LOWER** and then the one-touch button for the desired location. You might wish to write the names, telephone numbers, or extension numbers of the one-touch entries on the directory card, using the light gray spaces for the upper 16 locations and the white spaces for the lower 16 locations.

Assign a one-touch entry

Use the following steps to program the one-touch keys.

1. When the console is idle, press **MENU/SELECT**.
2. Press ▲ or ▼ to scroll to **One Touch**, then press **MENU/SELECT** or ►/SKIP.
3. Press ▲ or ▼ to scroll to **Program**, then press **MENU/SELECT** or ►/SKIP.
4. The screen displays **Enter Number:**
5. Use the dialing keys to enter a telephone number (up to 30 digits) or an extension number.
 - Press **DELETE** to delete a digit.
 - Press ◀/REPEAT or ►/SKIP to move the cursor to the left or right.
 - You can include a pause while storing a dialing sequence that requires one during actual dialing. Press ▲ or ▼ to choose **Add pause**, then press **MENU/SELECT**. A **P** appears on the screen.
 - Store a signal for switching to temporary tone signaling. If you have dial pulse (rotary) service, this signal is required for some special services. Press ▲ or ▼ to choose **Send tone**, then press **MENU/SELECT**. A **T** appears on the screen. All numbers you enter after this will send touch-tone signals during dialing.

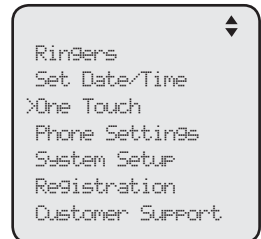

Telephone operation

One touch

Assign a one-touch entry (continued)

- You can store the flash signal required by some special services as part of a dialing sequence. Press ▲ or ▼ to choose **Add flash**, then press **MENU/SELECT**. An **F** appears on the screen. Continue storing the number as usual.
6. Press ▲ or ▼ to choose **Done**, then press **MENU/SELECT** to save the setting and return to the previous menu. To exit without making changes, press ▲ or ▼ to choose **Cancel**, then press **MENU/SELECT**, or press **CANCEL** to return to the previous menu.
 7. The screen displays **Press a 1-touch key to save the number**.
 8. Press the desired one-touch key to store the telephone number in the upper location.
-OR-
Press **LOWER**, then press the desired one-touch key to store the telephone number in the lower location.
 9. The screen displays **Number saved to 1-touch key** briefly, and then **One Touch #XX** (XX represents the one-touch location) and the telephone number or extension number.

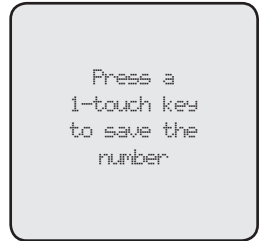

NOTE: If the one-touch location already has an assigned number, the screen displays **Replace 1-touch key memory?** Press **MENU/SELECT** to replace the old number with the new one.

Telephone operation

One touch

Review the one-touch entry

1. When the console is idle, press **MENU/SELECT**.
2. Press **▲** or **▼** to scroll to **One Touch**, then press **MENU/SELECT** or **▶/SKIP**.
3. Press **▲** or **▼** to scroll to **View**, then press **MENU/SELECT** or **▶/SKIP**.
4. Press **▲** or **▼** to scroll to the desired one-touch location. The screen displays the One-touch location number and the telephone number or extension number.



To dial a one-touch entry

When the console is idle, press the desired one-touch button for the destination party in the upper location.

-OR-

When the console is idle, press **LOWER** followed by the one-touch button for the destination party in the lower location.

The console dials the one-touch number using the speakerphone.

Edit the one-touch key

1. When the console is idle, press **MENU/SELECT**.
2. Press **▲** or **▼** to scroll to **One Touch**, then press **MENU/SELECT** or **▶/SKIP**.
3. Press **▲** or **▼** to scroll to **View**, then press **MENU/SELECT** or **▶/SKIP**.
4. Press **▲** or **▼** to scroll to the desired one-touch location.
5. Press **MENU/SELECT** to select **Edit**.
6. The screen displays **Edit Number**: Use the dialing keys to edit the number.
 - Press **DELETE** to delete a digit.
 - Press **◀/REPEAT** or **▶/SKIP** to move the cursor to the left or right.
 - You can include a pause while storing a dialing sequence that requires one during actual dialing. Press **▲** or **▼** to choose **Add pause**, then press **MENU/SELECT**. A **P** appears on the screen.



Telephone operation

One touch

Edit the one-touch key (continued)

- Store a signal for switching to temporary tone signaling. If you have dial pulse (rotary) service, this signal is required for some special services. Press ▲ or ▼ to choose **Send tone**, then press **MENU/SELECT**. A **T** appears on the screen. All numbers you enter after this will send touch-tone signals during dialing.
 - You can store the flash signal required by some special services as part of a dialing sequence. Press ▲ or ▼ to choose **Add flash**, then press **MENU/SELECT**. An **F** appears on the screen. Continue storing the number as usual.
7. Press ▲ or ▼ to scroll to **Done**, then press **MENU/SELECT** to save the setting.

Delete an one-touch key

1. When the console is idle, press **MENU/SELECT**.
2. Press ▲ or ▼ to scroll to **One Touch**, then press **MENU/SELECT** or ►/SKIP.
3. Press ▲ or ▼ to scroll to **View**, then press **MENU/SELECT** or ►/SKIP.
4. Press ▲ or ▼ to scroll to the desired one-touch location.
5. Press ►/SKIP to scroll to **Delete**, then press **MENU/SELECT**. The screen displays **Delete memory?**
6. Press **MENU/SELECT** to confirm. To exit without making changes, press **CANCEL**.



Directory

About the directory

Use the directory to store names and phone numbers. Directory entries are not shared with other extensions. The console and each deskset have their own directories.

Capacity

The directory of this console can store up to 50 entries, with a maximum of 15 alphanumeric characters (including spaces) for names and 30 digits for telephone numbers. A convenient search feature can help you quickly find and dial numbers (page 71).

If there are already 50 entries, the screen shows **Directory memory full** when you try to create a new directory entry. You cannot store a new number until you delete one. If you try to view the directory when there are no entries, the screen displays **Directory 0 entry**.

Exit the directory

On the console, press **CANCEL** to cancel an operation and return to previous screen.

Directory

Create directory entries

Create a new directory entry

Use the following steps to store a name and number in the directory.



1. When the console is idle, press **DIRECTORY**.
2. The console shows a summary with the number of directory entries stored. Press **MENU/SELECT** to add an entry.
3. The screen displays **Enter Name**. Use the dialing keys to enter the name (up to 15 characters). Each time you press a key, the character on that key appears. When entering a name in the directory, the first letter of each word is automatically capitalized. Additional key presses produce other characters on that key. See the chart below.

Dialing keys	Characters by number of key presses										
	1	2	3	4	5	6	7	8	9	10	11
1	1	.	-		()	*	#	&	/	,
2	a	b	c	A	B	C	2				
3	d	e	f	D	E	F	3				
4	g	h	i	G	H	I	4				
5	j	k	l	J	K	L	5				
6	m	n	o	M	N	O	6				
7	p	q	r	s	P	Q	R	S	7		
8	t	u	v	T	U	V	8				
9	w	x	y	z	W	X	Y	Z	9		
0	Space	0									
*											
#											

- Press **DELETE** to delete a character.
 - Press **◀/REPEAT** or **▶/SKIP** to move the cursor to the left or right.
 - Press **0** to add a space.
4. Press **MENU/SELECT** to save. The screen displays **Enter Number**. Use the dialing keys to enter the number (up to 30 digits).



- Press **DELETE** to delete a digit.
- Press **◀/REPEAT** or **▶/SKIP** to move the cursor to the left or right.

Directory

Create directory entries

Create a new directory entry (continued)

- You can include a pause while storing a dialing sequence that requires one during actual dialing. Press ▲ or ▼ to choose **Add pause**, then press **MENU/SELECT**. A **P** appears on the screen.
 - Store a signal for switching to temporary tone signaling. If you have dial pulse (rotary) service, this signal is required for some special services. Press ▲ or ▼ to choose **Send tone**, then press **MENU/SELECT**. A **T** appears on the screen. All numbers you enter after this will send touch-tone signals during dialing.
 - You can store the flash signal required by some special services as part of a dialing sequence. Press ▲ or ▼ to choose **Add flash**, then press **MENU/SELECT**. An **F** appears on the screen.
5. Press ▲ or ▼ to scroll to **Done**, then press **MENU/SELECT**. To exit without making changes, press **CANCEL**, or press ▲ or ▼ to scroll to **Cancel**, then press **MENU/SELECT**.



Review directory entries

1. When the console is idle, press **DIRECTORY**. The screen displays a summary with the number of directory entries stored.
2. Press ▲ or ▼ to browse through the directory. Entries appear alphabetically by the first letter in the name.
3. Press **CANCEL** to cancel an operation and press **CANCEL** again to return to idle mode.



Directory

Search directory

Search by name

The names appear in alphabetical order. Follow the steps below to search for directory entries on the console.

1. Press **DIRECTORY** on the console. The screen displays a summary with the number of directory entries stored.
2. Press ▲ or ▼ to browse through the directory.
3. Use the dial pad keys (**2-9**) to enter a letter to start a name search.
 - If there is an entry matching the letter you press, the directory shows the first name beginning with that letter.
 - If there is no entry matching the letter you press, the directory shows the next closest entry or the last entry.

For example, if you have the names **Jennifer**, **Jessie**, **Kevin** and **Linda** in your directory:

- If you press **5 (JKL)** once, you see **Jennifer**.
- If you press **5 (JKL)** twice, you see **Kevin**.
- If you press **5 (JKL)** three times, you see **Linda**.
- To view **Jessie**, press ▼ while **Jennifer** is displayed.

Directory

Dial, delete or edit entries

You can dial, delete or edit a directory entry (name and number) when it is shown on the console screen. You can use the directory review (page 70) or name search (page 71) to show an entry.

Display dial

When a number is displayed on the screen, you can dial the number by lifting the corded handset, or pressing **⏻ SPEAKER** or the desired line key (**LINE 1-LINE 4**).

Delete an entry

1. When a directory entry appears, press **MENU/SELECT**.
2. Press **▲** or **▼** to choose **Delete**, then press **MENU/SELECT**.
3. The console displays **Delete contact?** Press **MENU/SELECT** to confirm.

-OR-

When a directory entry appears, press **DELETE**, then press **MENU/SELECT** to confirm.



Directory

Dial, delete or edit entries

Edit an entry

1. When a directory entry appears, press **MENU/SELECT**.
2. Press **▲** or **▼** to choose **Edit**, then press **MENU/SELECT**.
3. The screen displays **Enter Name**. Use the dialing keys to edit the name. If you only want to edit the number, skip to step 4.
 - Press **DELETE** to delete a character.
 - Press **◀/REPEAT** or **▶/SKIP** to move the cursor to the left or right.
4. Press **MENU/SELECT** to save. The screen displays **Enter Number**. Use the dialing keys to edit the number.
 - Press **DELETE** to delete a digit.
 - Press **◀/REPEAT** or **▶/SKIP** to move the cursor to the left or right.
 - You can include a pause while storing a dialing sequence that requires one during actual dialing. Press **▲** or **▼** to choose **Add pause**, then press **MENU/SELECT**. A **P** appears on the screen.
 - Store a signal for switching to temporary tone signaling. If you have dial pulse (rotary) service, this signal is required for some special services. Press **▲** or **▼** to choose **Send tone**, then press **MENU/SELECT**. A **T** appears on the screen. All numbers you enter after this will send touch-tone signals during dialing.
 - You can store the flash signal required by some special services as part of a dialing sequence. Press **▲** or **▼** to choose **Add flash**, then press **MENU/SELECT**. An **F** appears on the screen. Continue storing the number as usual.
5. Press **▲** or **▼** to scroll to **Done**, then press **MENU/SELECT**. To exit without making changes, press **CANCEL**, or press **▲** or **▼** to scroll to **Cancel**, then press **MENU/SELECT**.



Directory

Dial, delete or edit entries

Copy a directory entry to one touch

1. When a directory entry appears, press **MENU/SELECT**.
2. Press **▲** or **▼** to choose **Copy to 1-touch**, then press **MENU/SELECT**.
3. The screen displays **Enter Number**. Use the dialing keys to edit the number.
 - Press **DELETE** to delete a digit.
 - Press **◀/REPEAT** or **▶/SKIP** to move the cursor to the left or right.
 - You can include a pause while storing a dialing sequence that requires one during actual dialing. Press **▲** or **▼** to choose **Add pause**, then press **MENU/SELECT**. A **P** appears on the screen.
 - Store a signal for switching to temporary tone signaling. If you have dial pulse (rotary) service, this signal is required for some special services. Press **▲** or **▼** to choose **Send tone**, then press **MENU/SELECT**. A **T** appears on the screen. All numbers you enter after this will send touch-tone signals during dialing.
 - You can store the flash signal required by some special services as part of a dialing sequence. Press **▲** or **▼** to choose **Add flash**, then press **MENU/SELECT**. An **F** appears on the screen. Continue storing the number as usual.
4. Press **▲** or **▼** to scroll to **Done**, then press **MENU/SELECT**.
5. The console displays **Press a 1-touch key to save the number**.
 - Press the one-touch button for the destination party in the upper location.

-OR-

 - Press **LOWER**, then press the one-touch button for the destination party in the lower location.
6. The console displays **Number saved to 1-touch key**.

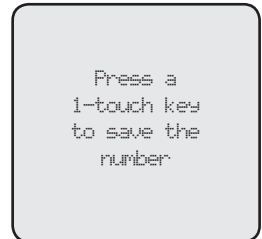

Caller ID

About the caller ID

This telephone supports caller ID services that most telephone service providers offer. Caller ID allows you to see the name, number, date and time of calls. Depending on your service subscription, you might see the caller's number, or the caller's name and number from the telephone service provider after the first or second ring. Caller ID information might not be available for every incoming call. Callers may intentionally block their names and/or telephone numbers.

This product can provide information only if both you and the caller are in areas offering caller ID service and if both telephone service providers use compatible equipment.

Information about caller ID with call waiting

Caller ID with call waiting lets you see the name and telephone number of the caller before answering the telephone, and while on another call.

It might be necessary to change telephone service to use this feature. Contact your telephone service provider if:

- You have both caller ID and call waiting, but as separate services (you might need to combine these services).
- You only have caller ID service, or only call waiting service.
- You do not subscribe to caller ID or call waiting services.

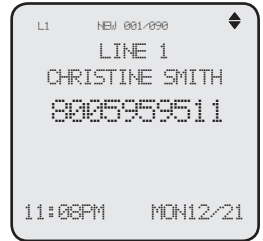

There are fees for caller ID services. In addition, services may not be available in all areas.

This product can provide information only if both you and the caller are in areas offering caller ID service and if both telephone service providers use compatible equipment. The time and date, along with the call information, are from the telephone service provider.

NOTES:

- You can use this product with regular caller ID service, or you can use this product's other features without subscribing to caller ID or combined caller ID with call waiting service.
- The format of telephone numbers displayed depends on the home area code you set (See **Home area code** on page 42 for explanations and instructions on area code settings).

Caller ID

Caller ID information

How the caller ID information (call log) works

The telephone stores caller ID information for the last 200 incoming calls in the console. Entries are stored in reverse chronological order. The telephone deletes the oldest entry when the log is full to make room for new calls.

Each extension has independent caller ID information. Deleting the caller ID information on any one extension does not affect the caller ID information on other extensions.

If you answer a call before the information appears on the screen, it does not show in the caller ID information.

Review the caller ID information to determine who called, to easily return the call, or to copy the caller's name and number into your directory or one-touch memory.

The time and date of the call and the caller's name and telephone number are included in the display.

Caller ID information appears on the screen as the telephone rings, or until the caller hangs up, or until the call has been answered at another extension, or until the call ends.

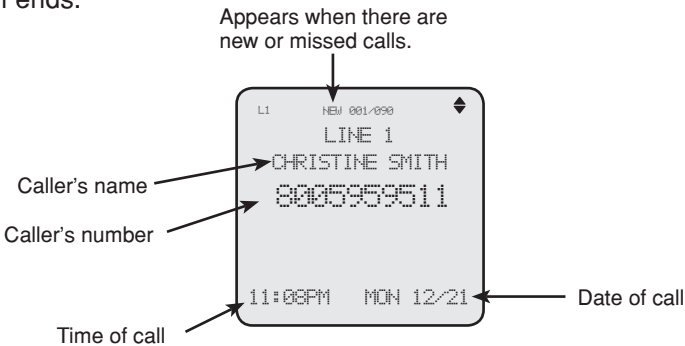
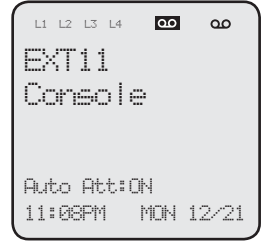

If you subscribe to caller ID service, this phone automatically resets the time and date using the caller ID information from the first incoming call after initial setup, or each time the power resumes after a power outage.



NOTES:

- The caller ID information might not be available for every incoming call. Callers might intentionally block their names and/or telephone numbers.
- Each entry can store up to 30 digits for the telephone number and 15 characters for the name.

Caller ID

Caller ID operation

Memory match

If the incoming telephone number is an exact match with a telephone number in your directory, the name that appears on the screen matches the corresponding name in your directory.

For example, if Christine Smith calls, her name appears as Chris if this is how you entered it into your directory.

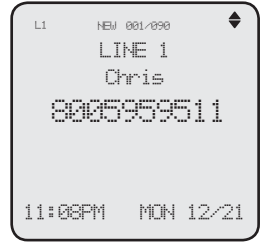

NOTE: The number you see on your caller ID is in the format from the telephone service provider. It usually delivers 10-digit telephone numbers (area code plus telephone number). The telephone system ignores the area code when searching for a match and displays the name of the first corresponding number from the directory.

Missed (new) calls indicator

When there are new or missed calls and you try to review the caller ID log by pressing **CALL HISTORY**, the screen shows **XX New call(s)**.

All new or missed entries are counted as new calls. Each time you review a call history entry with the icon **NEW**, the number of missed calls decreases by one. When all the entries in the caller ID information become old (have been reviewed), the system removes the missed calls alert from the display, and the **NEW** indicator turns off.

Review the caller ID information

1. When the console is idle, press **CALL HISTORY**. The console displays **XX New calls** (the number of missed call) and **XX calls** (the total number of missed calls and reviewed calls).
2. Press ▲ or ▼ to review the caller ID information. The caller ID entries are stored in reverse chronological order starting with the most recent entry.
3. To exit without making changes, press **CANCEL**.



Caller ID

Caller ID operation

View dialing options

Although the incoming call history entries have 10 digits (the area code plus the seven-digit number), in some areas, you may need to dial the seven digits only, 1 plus the seven digits, or 1 plus the area code plus the seven digits. You can change and store the number of digits that you dial in the call history.

While reviewing the call history, press # (pound key) repeatedly on the console to show different dialing options for local and long distance numbers before dialing or saving the telephone number in the directory.

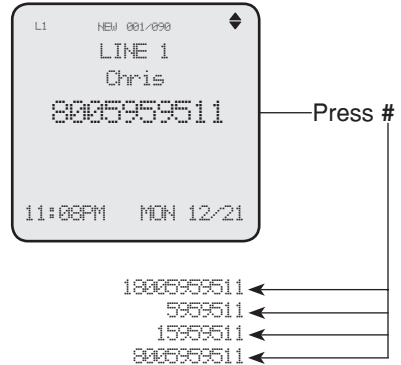

Dial a call history entry

1. When in the caller ID history, press ▲ or ▼ to browse the number you wish to call.
2. Lift the handset or press **SPEAKER** .

-OR-

To override automatic line selection, press the desired line key (**LINE 1-LINE 4**), then lift the handset to call.

Caller ID

Caller ID operation

Save a caller ID entry to the directory

1. When in the caller ID history, press ▲ or ▼ to browse to the number you wish to save.
2. Press **MENU/SELECT**, then press ▲ or ▼ to choose **Copy to DIR**.
3. Press **MENU/SELECT**. The screen displays **Enter Name**. Use the dialing keys to edit the name.
 - Press **DELETE** to delete a character.
 - Press ◀/REPEAT or ▶/SKIP to move the cursor to the left or right.
4. Press **MENU/SELECT** to save. The screen displays **Enter Number**. Use the dialing keys to edit the number.
 - Press **DELETE** to delete a digit.
 - Press ◀/REPEAT or ▶/SKIP to move the cursor to the left or right.
 - You can include a pause while storing a dialing sequence that requires one during actual dialing. Press ▲ or ▼ to choose **Add pause**, then press **MENU/SELECT**. A **P** appears on the screen.
 - Store a signal for switching to temporary tone signaling. If you have dial pulse (rotary) service, this signal is required for some special services. Press ▲ or ▼ to choose **Send tone**, then press **MENU/SELECT**. A **T** appears on the screen. All numbers you enter after this will send touch-tone signals during dialing.
 - You can store the flash signal required by some special services as part of a dialing sequence. Press ▲ or ▼ to choose **Add flash**, then press **MENU/SELECT**. An **F** appears on the screen. Continue storing the number as usual.
5. Press ▲ or ▼ to scroll to **Done**, then press **MENU/SELECT**. To exit without making changes, press **CANCEL**, or press ▲ or ▼ to scroll to **Cancel**, then press **MENU/SELECT**.



NOTE: You will need to change how a caller ID number is dialed if the entry does not appear in the correct format. Caller ID numbers might appear with an area code that might not be necessary for local calls, or without a 1 that may be necessary for long distance calls (see **View dialing options** on the previous page for more information).

Caller ID

Caller ID operation

Copy a caller ID entry to one touch

1. When the desired number appears, press **MENU/SELECT**.
2. Press **▲** or **▼** to choose **Copy to 1-touch**, then press **MENU/SELECT**.
3. The console displays **Press a 1-touch key to save the number**.
 - Press the one-touch button for the destination party in the upper location.

-OR-

 - Press **LOWER**, then press the one-touch button for the destination party in the lower location.
4. The console displays **Number saved to 1-touch key**.



Delete entries

To delete a call history entry:

1. When in the caller ID history, press **▲** or **▼** to scroll to the number you wish to delete.
2. Press **DELETE** to delete the shown entry from the caller ID history.
3. The screen displays **Caller ID deleted**.

-OR-

1. When in the caller ID history, press **▲** or **▼** to scroll to the desired number you wish to delete.
2. Press **MENU/SELECT**, then press **▲** or **▼** to choose **Delete**.
3. Press **MENU/SELECT**, the screen displays **Caller ID deleted**.



To delete all caller ID history entries:

1. When the console is idle, press **CALL HISTORY**.
2. Press **DELETE**. The screen displays **All calls history deleted**.

Caller ID

Reasons for missing caller ID information

Reasons for missing caller ID information

There are also occasions when other information or no information shows for various reasons:

On-screen message	Reason
PRIVATE NAME	The caller prefers not to show the name.
PRIVATE NUMBER	The caller prefers not to show the phone number.
PRIVATE CALLER	The caller prefers not to show the phone number and name.
UNKNOWN NAME	Your telephone service provider cannot determine the caller's name.
UNKNOWN NUMBER	Your telephone service provider cannot determine the caller's number.
UNKNOWN CALLER	No information is available about this caller.

Answering system

About the answering system

The answering system of this console has two mailboxes, namely the central (auto attendant) mailbox and private mailbox.

When the auto attendant feature is turned on, it can be used to answer calls, record messages, direct incoming calls to other system extensions, or enter the remote access menu.

When the auto attendant feature is turned off and the private mailbox is turned on, you can leave messages in the private mailbox if nobody picks up the call.

Only this UP416 console can serve as an auto attendant in the telephone system and redirect incoming call to other extensions in the system.

Answering system capacity

You can record up to three outgoing announcements and a directory announcement for the auto attendant, and one announcement for the private mailbox of this console. Each announcement can be up to 150 seconds.

The maximum message recording time of the console is 60 minutes. This includes 40 minutes for the central mailbox and 20 minutes for the private mailbox. The actual recording time depends on individual message characteristics. Messages remain available for review until you delete them.

If the system memory is full, you cannot record new messages until old ones have been deleted. Check the remaining recording time frequently to maintain availability of space for incoming messages.



NOTE: You cannot record announcement when the telephone system is out of space.

Answering system

Auto attendant setup

You can set up the auto attendant to answer outside calls, provide callers with a company directory, direct calls to a specified extension, and enable callers to record voice messages. You can use the default announcement or record up to three outgoing announcements and one directory announcement. For details on how to use the auto attendant features, see the **Auto attendant operation** on page 96 of this user's manual.

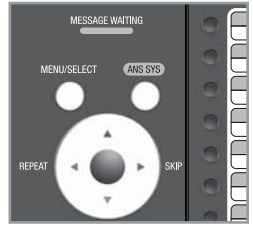

Auto attendant on/off

You can turn the auto attendant on or off. The screen displays **Auto Att: ON** when the auto attendant is turned on.

1. When the console is idle, press **ANS SYS**.
2. Press ▲ or ▼ to scroll to **Auto Attendant**, then press **MENU/SELECT** or ►/SKIP.
3. Press ▲ or ▼ to scroll to **Auto Att ON/OFF**, then press **MENU/SELECT** or ►/SKIP.
4. Press ▲ or ▼ to choose **On** or **Off**.
5. Press **MENU/SELECT** or ►/SKIP to save the setting.



Auto attendant delay

Use this feature to choose how long this console rings before the auto attendant picks up a call.

1. When the console is idle, press **ANS SYS**.
2. Press ▲ or ▼ to scroll to **Auto Attendant**, then press **MENU/SELECT** or ►/SKIP.
3. Press ▲ or ▼ to scroll to **Auto Att Delay**, then press **MENU/SELECT** or ►/SKIP.
4. Press ▲ or ▼ to choose the desired time (**8 seconds** to **30 seconds**).
5. Press **MENU/SELECT**.



Answering system

Auto attendant setup

Announcement

Use this feature to record up to three new announcements so that you can have a general announcement, different announcements for daytime and after hours, and an announcement for the company directory. You can easily switch among the recorded announcements. Each announcement can be up to 150 seconds.

Besides the directory announcement (**Directory OGM**), in which you can record an extension list of your company, the availability of other announcements are dependent on the night mode setting of the auto attendant. When the night mode is turned off, you can only record a general announcement (**General OGM**), which plays regardless of the time of a day. When the night mode is turned on, you can record an announcement for daytime recording (**Day OGM**) and an announcement for after hours recording (**Night OGM**).

The system has four default announcements:

General OGM - *“Thank you for calling our company. If you know your party’s extension, you may dial it at any time, then press # (pound). For a company directory, please dial 0. To leave a message, please dial 9.”*

Day OGM - *“Thank you for calling our company. If you know your party’s extension, you may dial it at any time, then press # (pound). For a company directory, please dial 0. To leave a message, please dial 9.”*

Night OGM - *“Thank you for calling our company. We are currently closed. If you would like to leave a message and you know your party’s extension, you may dial it now, then press # (pound). For a company directory, please dial 0. To leave a message, please dial 9.”*

Directory OGM - *“Please enter the extension number.”*

If you have many extensions, record a separate extension list in the **Directory OGM** menu item and reference it in your auto attendant announcement as shown in **Sample announcement 1** below. If you have only a few extensions, you can list them in the auto attendant announcement as shown in **Sample announcement 2** below without the separate extension list.

Sample announcement 1: *“Hello, you have reached XYZ Corp. Please enter your party’s extension. To hear a list of extensions, dial 0.”*

Sample announcement 2: *“Hello, you have reached XYZ Corp. For sales, press 12; for service, press 13; for shipping, press 14; or press 15 for the receptionist.”*

Answering system

Auto attendant setup

Night mode

You can turn the night mode on or off. When it is off, only General OGM is available in the announcement submenu; when it is on, both Day and Night OGMs are available in the Announcement submenu.

1. When the console is idle, press **ANS SYS**.
2. Press ▲ or ▼ to scroll to **Auto Attendant**, then press **MENU/SELECT** or ►/SKIP.
3. Press ▲ or ▼ to scroll to **Night Mode**, then press **MENU/SELECT** or ►/SKIP.
4. Press ▲ or ▼ to choose **On** or **Off**.
5. Press **MENU/SELECT** or ►/SKIP to save the setting.

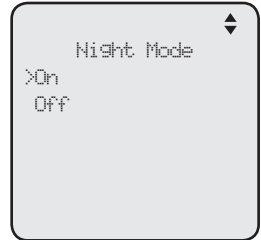

NOTE: When night mode is set to off, the auto attendant always plays the General OGM to callers of the system regardless of the time of the day.

Record the auto attendant announcement

To record the announcement:

1. When the console is idle, press **ANS SYS**.
2. Press ▲ or ▼ to scroll to **Auto Attendant**, then press **MENU/SELECT** or ►/SKIP.
3. Press ▲ or ▼ to scroll to **Announcement**, then press **MENU/SELECT** or ►/SKIP.
4. When the night mode is turned off, press ▲ or ▼ to choose **General OGM** or **Directory OGM**. When the night mode is turned on, press ▲ or ▼ to choose **Day OGM**, **Night OGM** or **Directory OGM**, then press **MENU/SELECT** or ►/SKIP.
5. Press ▲ or ▼ to scroll to **Record**, then press **MENU/SELECT** or ►/SKIP.
6. Lift the handset or face the console to record your announcement. The screen displays **Record OGM** and the time elapsed. Press **MENU/SELECT** to stop recording.



NOTE: When you are recording your announcement and there are incoming calls, you can press ▲ or ▼ to view the caller ID information. To answer the call, lift the handset, or press the corresponding line key (**LINE 1-LINE 4**), **SPEAKER** , or **HEADSET** on the console.

Answering system

Auto attendant setup

Set the start and end time of auto attendant announcement

When the night mode is turned on, you can set the start and end time of the **Day OGM** and **Night OGM**.

1. When the console is idle, press **ANS SYS**.
2. Press ▲ or ▼ to scroll to **Auto Attendant**, then press **MENU/SELECT** or ►/SKIP.
3. Press ▲ or ▼ to scroll to **Announcement**, then press **MENU/SELECT** or ►/SKIP.
4. Press ▲ or ▼ to choose **Day OGM** or **Night OGM**, then press **MENU/SELECT** or ►/SKIP.
5. Press ▲ or ▼ to scroll to **Start/End Time**, then press **MENU/SELECT** or ►/SKIP.
6. Press ▲ or ▼ to scroll to the item you want to edit, and press the dialing keys to enter the correct digit.
7. Press ◀/REPEAT or ►/SKIP to select **AM** or **PM**.
8. Press **MENU/SELECT** to save the setting.

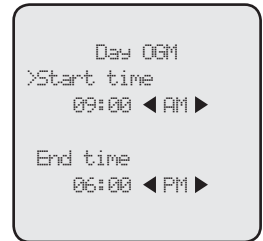

The end time of the **Night OGM** will be applied to the start time of the **Day OGM** with one minute offset.

For example, if **Night OGM** is set to end at 07:00 AM, the **Day OGM** will start at 07:01 AM. Similarly, the end time of the **Day OGM** will be applied to the start time of the **Night OGM** with one minute offset.

Answering system

Auto attendant setup

Play the auto attendant announcement

To play the announcement:

1. When the console is idle, press **ANS SYS**.
2. Press ▲ or ▼ to scroll to **Auto Attendant**, then press **MENU/SELECT** or ►/SKIP.
3. Press ▲ or ▼ to scroll to **Announcement**, then press **MENU/SELECT** or ►/SKIP.
4. When the night mode is turned off, press ▲ or ▼ to choose **General OGM** or **Directory OGM**. When the night mode is turned on, press ▲ or ▼ to choose **Day OGM**, **Night OGM** or **Directory OGM**, then press **MENU/SELECT** or ►/SKIP.
5. Press ▲ or ▼ to scroll to **Play**, then press **MENU/SELECT** or ►/SKIP.
6. The screen displays **Play OGM** and the time elapsed. During playback, press **MENU/SELECT** to stop.



NOTE: When you are playing the announcement and there are incoming calls, you can press ▲ or ▼ to view the caller ID information. To answer the call, lift the handset, or press the corresponding line key (**LINE 1-LINE 4**), **SPEAKER** (📞), or **HEADSET** on the console.

Reset the auto attendant announcement

To reset the announcement:

1. When the console is idle, press **ANS SYS**.
2. Press ▲ or ▼ to scroll to **Auto Attendant**, then press **MENU/SELECT** or ►/SKIP.
3. Press ▲ or ▼ to scroll to **Announcement**, then press **MENU/SELECT** or ►/SKIP.
4. When the night mode is turned off, press ▲ or ▼ to choose **General OGM** or **Directory OGM**. When the night mode is turned on, press ▲ or ▼ to choose **Day OGM**, **Night OGM** or **Directory OGM**, then press **MENU/SELECT** or ►/SKIP.
5. Press ▲ or ▼ to scroll to **Reset**, then press **MENU/SELECT**. The screen displays **Reset XXX OGM to default announcement?**
6. Press **MENU/SELECT** to confirm.



Answering system

Auto attendant setup

Reset auto attendant

Use this feature to reset the auto attendant settings and announcements to default.

1. When the console is idle, press **ANS SYS**.
2. Press ▲ or ▼ to scroll to **Auto Attendant**, then press **MENU/SELECT** or ►/SKIP.
3. Press ▲ or ▼ to scroll to **Reset Auto Att**, then press **MENU/SELECT** or ►/SKIP.
4. The screen displays **Reset Auto Attendant to default settings?** Press **MENU/SELECT** to confirm.
5. The screen displays **Auto Attendant is reset to default**.

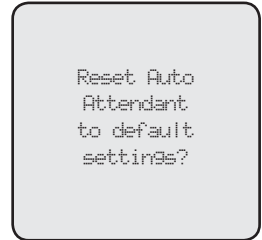
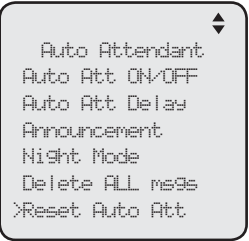

Answering system

Private mailbox setup

This console has a private mailbox that can answer calls and record messages when it is turned on.

The private mailbox answers the call after the ring delay time you set in the **Private mailbox delay** section below.

Private mailbox on/off

You can turn the private mailbox on or off. The console displays **MB** when the private mailbox is set to **On**.

1. When the console is idle, press **ANS SYS**.
2. Press **▲** or **▼** to scroll to **Private Mailbox**, then press **MENU/SELECT** or **▶/SKIP**.
3. Press **▲** or **▼** to scroll to **Priv MB ON/OFF**, then press **MENU/SELECT** or **▶/SKIP**.
4. Press **▲** or **▼** to choose **On** or **Off**.
5. Press **MENU/SELECT**.



Private mailbox delay

Use this feature to choose how long this phone rings before the private mailbox picks up a call.

1. When the console is idle, press **ANS SYS**.
2. Press **▲** or **▼** to scroll to **Private Mailbox**, then press **MENU/SELECT** or **▶/SKIP**.
3. Press **▲** or **▼** to scroll to **Priv MB Delay**, then press **MENU/SELECT** or **▶/SKIP**.
4. Press **▲** or **▼** to choose the desired time (**6** seconds to **40** seconds).
5. Press **MENU/SELECT**.



Answering system

Private mailbox setup

Announcement

An announcement plays when calls are answered by the private mailbox. The system has a default announcement, *"Hello, please leave a message after the tone."* You can use this announcement or record your own.

You can record an announcement up to 150 seconds.

To record the announcement:

1. When the console is idle, press **ANS SYS**.
2. Press **▲** or **▼** to scroll to **Private Mailbox**, then press **MENU/SELECT** or **▶/SKIP**.
3. Press **▲** or **▼** to scroll to **Announcement**, then press **MENU/SELECT** or **▶/SKIP**.
4. Press **▲** or **▼** to scroll to **Record**, then press **MENU/SELECT** or **▶/SKIP**.
5. Lift the handset or face the console to record your announcement. The screen displays **Record OGM** and the time elapsed. Press **MENU/SELECT** to stop recording.

To play an announcement:

1. When the console is idle, press **ANS SYS**.
2. Press **▲** or **▼** to scroll to **Private Mailbox**, then press **MENU/SELECT** or **▶/SKIP**.
3. Press **▲** or **▼** to scroll to **Announcement**, then press **MENU/SELECT** or **▶/SKIP**.
4. Press **▲** or **▼** to scroll to **Play**, then press **MENU/SELECT** or **▶/SKIP**.
5. The screen displays **Play OGM** and the time elapsed. During playback, press **MENU/SELECT** to stop.

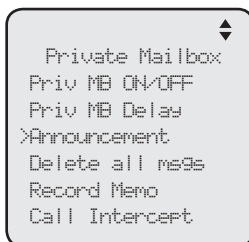

Private Mailbox
Priv MB ON/OFF
Priv MB Delay
>Announcement
Delete all mess
Record Memo
Call Intercept



Announcement
Play
>Record
Reset



Record OGM
00:15

Press SELECT to:
STOP



Play OGM
00:15

Press SELECT to:
STOP



NOTE: When you are recording or playing your announcement and there are incoming calls, you can press **▲** or **▼** to view the caller ID information. To answer the call, lift the handset, or press the corresponding line key (**LINE 1-LINE 4**), **SPEAKER** , or **HEADSET** on the console.

Answering system

Private mailbox setup

To reset the announcement:

1. When the console is idle, press **ANS SYS**.
2. Press ▲ or ▼ to scroll to **Private Mailbox**, then press **MENU/SELECT** or ►/SKIP.
3. Press ▲ or ▼ to scroll to **Announcement**, then press **MENU/SELECT** or ►/SKIP.
4. Press ▲ or ▼ to scroll to **Reset**, then press **MENU/SELECT** or ►/SKIP. The screen displays **Reset announcement to default?**
5. Press **MENU/SELECT** to confirm.



Answering system

Private mailbox setup

Call intercept

When a caller is leaving a message on your private mailbox, you can stop the recording and talk to the caller by pressing the corresponding line key (**LINE 1-LINE 4**). Choose whether private incoming messages can be intercepted by the console during recording.

1. When the console is idle, press **ANS SYS**.
2. Press ▲ or ▼ to scroll to **Private Mailbox**, then press **MENU/SELECT** or ►/SKIP.
3. Press ▲ or ▼ to scroll to **Call Intercept**, then press **MENU/SELECT** or ►/SKIP.
4. Press ▲ or ▼ to choose **On** or **Off**.
5. Press **MENU/SELECT** to save the setting and return to the previous menu. To exit without making changes, press **CANCEL**.

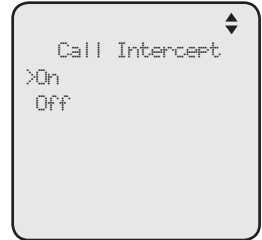

Answering system

Answering system setup

All feature settings below apply to both central (auto attendant) and private mailboxes.

Remote access code

Use this code to select a three-digit number to allow remote access of the answering system from another telephone. You can change the code to any number from **000-999**. This code is **333** by default.

1. When the console is idle, press **ANS SYS**.
2. Press ▲ or ▼ to scroll to **Ans Sys Setup**, then press **MENU/SELECT** or ►/SKIP.
3. Press ▲ or ▼ to scroll to **Remote Code**, then press **MENU/SELECT** or ►/SKIP.
4. The screen displays **Remote Code**. Use the dialing keys to enter a three-digit remote code.
 - Press **DELETE** to delete a digit.
 - Press ◀/REPEAT or ►/SKIP to move the cursor to the left or right.
5. Press **MENU/SELECT** to save the setting and return to the previous menu. To exit without making changes, press **CANCEL**.

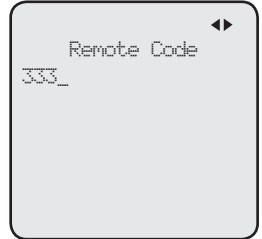
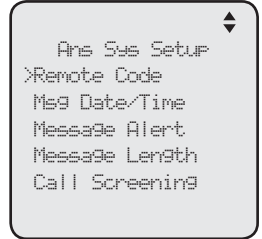

Message date/time

The message date and time is set to **Announce** by default. During message playback, you hear the date and time the message was received. You can change this setting to skip the date and time information.

1. When the console is idle, press **ANS SYS**.
2. Press ▲ or ▼ to scroll to **Ans Sys Setup**, then press **MENU/SELECT** or ►/SKIP.
3. Press ▲ or ▼ to scroll to **Msg Date/Time**, then press **MENU/SELECT** or ►/SKIP.
4. Press ▲ or ▼ to choose **Announce** or **Skip**.
5. Press **MENU/SELECT** to save the setting and return to the previous menu. To exit without making changes, press **CANCEL**.

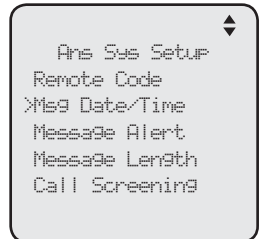

Answering system

Answering system setup

Message alert

Use this feature to turn the audible message alert on or off.

If the message alert tone is on, the console beeps every 30 seconds when there are new messages in the central mailbox and/or private mailbox.

1. When the console is idle, press **ANS SYS**.
2. Press **▲** or **▼** to scroll to **Ans Sys Setup**, then press **MENU/SELECT** or **►/SKIP**.
3. Press **▲** or **▼** to scroll to **Message Alert**, then press **MENU/SELECT** or **►/SKIP**.
4. Press **▲** or **▼** to choose **On** or **Off**.
5. Press **MENU/SELECT** to save the setting and return to the previous menu. To exit without making changes, press **CANCEL**.

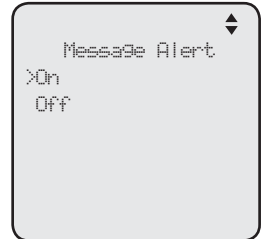
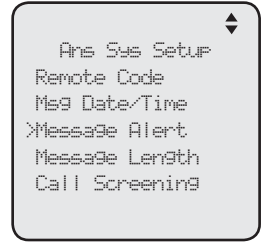

Message Length

Use this feature to set the maximum length of each recorded message.

If you choose **Greeting only**, the caller hears the selected announcement but is not able to record a message. If you choose **1 minute**, **2 minutes** or **3 minutes**, the caller can record a message up to that specific time period. If you choose **Unlimited**, the caller can record a message of any length, up to the remaining time for all messages and memos.

1. When the console is idle, press **ANS SYS**.
2. Press **▲** or **▼** to scroll to **Ans Sys Setup**, then press **MENU/SELECT** or **►/SKIP**.
3. Press **▲** or **▼** to scroll to **Message Length**, then press **MENU/SELECT** or **►/SKIP**.
4. Press **▲** or **▼** to choose **Greeting only**, **1 minute**, **2 minutes**, **3 minutes**, or **Unlimited**.
5. Press **MENU/SELECT** to save the setting and return to the previous menu. To exit without making changes, press **CANCEL**.

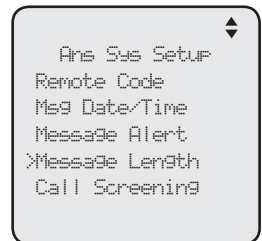

Answering system

Answering system setup

Call screening

Use this feature to choose whether incoming messages can be heard over the speaker when they are being recorded. If you turn call screening on, you hear the incoming message on your console when a call comes in.

1. When the console is idle, press **ANS SYS**.
2. Press ▲ or ▼ to scroll to **Ans Sys Setup**, then press **MENU/SELECT** or ►/SKIP.
3. Press ▲ or ▼ to scroll to **Call Screening**, then press **MENU/SELECT** or ►/SKIP.
4. Press ▲ or ▼ to choose **On** or **Off**.
5. Press **MENU/SELECT** to save the setting and return to the previous menu. To exit without making changes, press **CANCEL**.

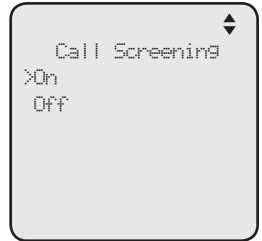
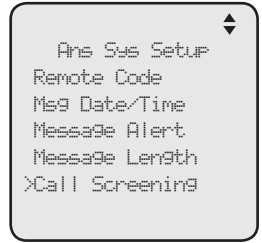

Recording time

Use this feature to check the remaining recording time in the system.

1. When the console is idle, press **ANS SYS**.
2. Press ▲ or ▼ to scroll to **Record Time**, then press **MENU/SELECT** or ►/SKIP.
3. Press **CANCEL** to return to the previous menu.



Answering system

Auto attendant operation

Using the auto attendant

When auto attendant is on, it automatically picks up the ringing line after the delay time you programmed (see **Auto attendant delay** on page 83), and plays the appropriate auto attendant announcement. You can choose from one of the following options.

- Enter the extension number you want to call after the auto attendant announcement is played. The system plays, *“Calling that extension, Please wait.”*
 - ◇ If the private mailbox of the destination extension is off and the call is not picked up after about 45 seconds, the system announces, *“That extension is not answering. Enter a new extension number, or, to leave a general message in the central mailbox, please dial 9.”*
 - ◇ If the private mailbox on the destination extension is on and the call is not picked up after the programmed delay time (See **Private mailbox delay** on page 89), the extension announces, *“Hello, please leave a message after the tone,”* then you can record a private message in that extension mailbox.
 - ◇ If the private mailbox on the destination extension is on but busy, the system announces, *“That extension is not answering. Enter a new extension number, or, to leave a general message in the central mailbox, please dial 9.”*
- Press **9** to enter the central mailbox and leave a message.
- Press **0** to play the directory announcement. The caller can enter the desired extension number anytime during the directory announcement is being played.
- Enter the remote access code when the auto attendant announcement is being played to access the answering system remotely.

If the caller does not enter a command after about 3 seconds, the auto attendant announcement will replay. If no command is entered after about 3 seconds following the auto attendant announcement replay, the call will be dropped.

Answering system

Auto attendant operation

Auto attendant (AA) flow chart

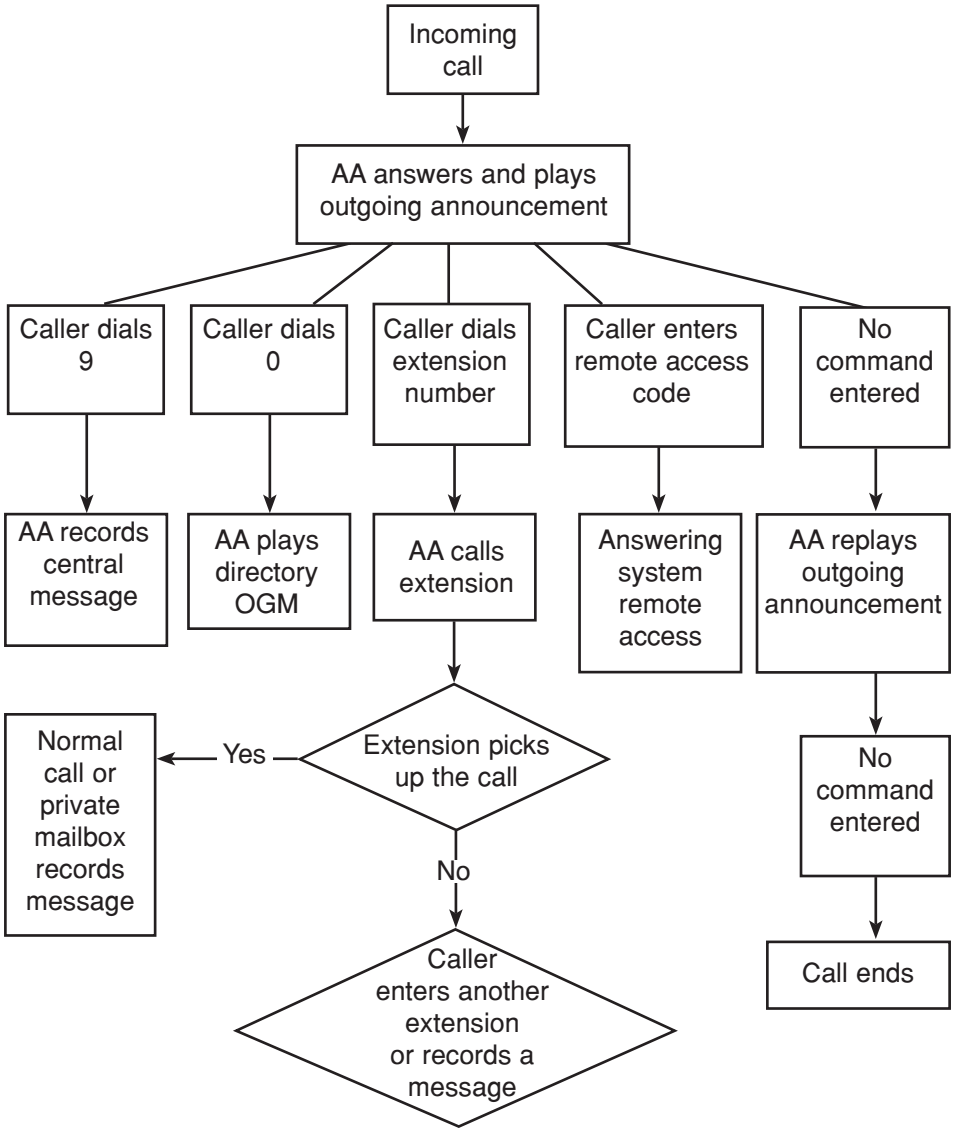

Answering system

Answering system operation

New message indication

The  icon displays on the console when there are new messages in the central mailbox.

The  icon displays on the console when there are new messages and/or memos in the private mailbox.

The **MESSAGE WAITING** indicator on the console flashes when there are new messages in either the central or private mailbox.

Call screening

If the answering system and call screening are turned on (see **Call screening** on page 95), the announcement and the incoming message broadcast at the console when a call arrives. During message recording, press **▲/VOLUME** or **VOLUME/▼** to adjust the volume.

Call intercept

When a caller is leaving a message on your central or private mailbox, you can stop the recording and talk to the caller by pressing the corresponding line key (**LINE 1-LINE 4**). This feature is enabled for the central mailbox by default. For the private mailbox, you can turn this feature on or off (see page 92).

Message playback

From the console, you can play the messages in both the central and private mailboxes.

You can choose to play the new messages only or play all messages (new messages and old messages).

By default, the system announces the date and time of the recording before playing each message. After the last message, you hear, *“End of the messages.”*

To listen to messages in the mailbox:

1. While the console is idle, press **ANS SYS**.
2. Press **▲** or **▼** to choose **Play Messages**, then press **MENU/SELECT** or **►/SKIP**.
3. Press **▲** or **▼** to choose **Central Mailbox** or **Private Mailbox**, then press **MENU/SELECT** or **►/SKIP**.
4. Press **▲** or **▼** to choose **Play new msgs** to play the new messages only or **Play all msgs** to play all the messages in the mailbox.
5. Press **MENU/SELECT** or **►/SKIP** to play the messages.
6. The system announces the number of messages, date and time the message was received, then starts playing the messages. If there are no messages in the mailbox, the system announces, *“No new messages.”* if you have chosen **Play new msgs**, or *“No messages.”* if you have chosen **Play all msgs**.



Answering system

Answering system operation



NOTES:

- If you want to play the messages without hearing the date and time information, set the **Msg Date/Time** option to **Skip**. See **Msg Date/Time** on page 93 for details.
- When you are playing the messages and there are incoming calls, you can press **▲** or **▼** to view the caller ID information. To answer the call, lift the handset, or press the corresponding line key (**LINE 1-LINE 4**), **SPEAKER** , or **HEADSET** on the console.

Options during playback

When a message is playing, you can adjust the playback volume, skip, repeat, delete the message, or switch between speakerphone and handset earpiece.

When a message is playing on the console:

- Press **▲/VOLUME** or **VOLUME/▼** to adjust the message playback volume.
- Press **▶/SKIP** after the date and time announcement to skip to the next message.
- Press **◀/REPEAT** to repeat the current message. Immediately press **◀/REPEAT** after the date and time announcement to hear the previous message.
- Press **▼** to stop the message playback. Press **▲** to start the message playback.
- Press **DELETE** after the date and time announcement to delete the message. The system announces “*Message deleted.*”
- Lift the handset to listen to the message playback through the handset earpiece. Place the handset on the console or press **SPEAKER**  to switch back to speakerphone.

Delete all central mailbox messages

Use this feature to delete all messages stored in the central mailbox.

1. When the console is idle, press **ANS SYS**.
2. Press **▲** or **▼** to scroll to **Auto Attendant**, then press **MENU/SELECT** or **▶/SKIP**.
3. Press **▲** or **▼** to scroll to **Delete all msgs**, then press **MENU/SELECT** or **▶/SKIP**.
4. The screen displays **Delete all messages?** Press **MENU/SELECT** to confirm. The screen displays **All messages are deleted**. To exit without making changes, press **CANCEL**.

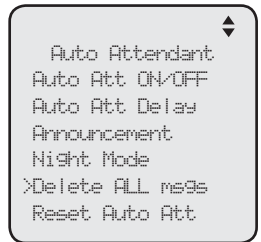

Answering system

Answering system operation

Delete all private mailbox messages

You can use this feature to delete all messages stored in the private mailbox.

1. When the console is idle, press **ANS SYS**.
2. Press **▲** or **▼** to scroll to **Private Mailbox**, then press **MENU/SELECT** or **▶/SKIP**.
3. Press **▲** or **▼** to scroll to **Delete all msgs**, then press **MENU/SELECT** or **▶/SKIP**.
4. The screen displays **Delete all messages?** Press **MENU/SELECT** to confirm. The screen displays **All messages are deleted**.

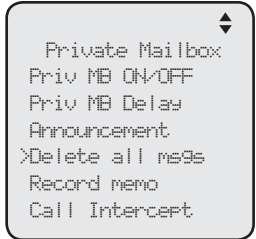

Record memo

Memos are messages you record as reminders for yourself. Play and delete them the same way as incoming messages.

1. When the console is idle, press **ANS SYS**.
2. Press **▲** or **▼** to scroll to **Private Mailbox**, then press **MENU/SELECT** or **▶/SKIP**.
3. Press **▲** or **▼** to scroll to **Record Memo**, then press **MENU/SELECT** or **▶/SKIP**.
4. Lift the handset or face the console to record your memo. The screen displays **Record memo** and the time elapsed. Press **◀/REPEAT** or **▶/SKIP** to select **STOP**, then press **MENU/SELECT** to stop recording.



NOTE: When you are recording a memo and there are incoming calls, you can press **▲** or **▼** to view the caller ID information. To answer the call, lift the handset, or press the corresponding line key (**LINE 1-LINE 4**), **SPEAKER** , or **HEADSET** on the console.

Answering system

Remote access

Use this feature to reach your answering system remotely by calling any telephone line connected this console from any touch-tone telephone. Make sure the auto attendant feature or the private mailbox of the console is turned on for this feature to work. Remote access can only play messages stored in the private mailbox.

To remotely reach the answering system:

1. Dial any telephone line connected to this console from any touch-tone telephone.
2. When the system answers, enter the extension number.
3. When the private mailbox of the extension answers, enter the three-digit remote access code (**333** is the default code; see **Remote access code** on page 93 to change it).
4. You can enter the following remote commands.

Remote commands:

1	Press to play new messages in the private mailbox.
1*	Press to play all messages in the private mailbox.
2	Press within three seconds of the message playing to go back to the previous message. Press after three seconds of the message playing to repeat the message currently playing.
3	Press to skip the current message (during playback).
41	Press to play the auto attendant announcement General OGM . <ul style="list-style-type: none">• Press 9 to record and wait for the beep before speaking.• Press # to stop recording.
42	Press to play the auto attendant announcement Day OGM . <ul style="list-style-type: none">• Press 9 to record and wait for the beep before speaking.• Press # to stop recording.
43	Press to play the auto attendant announcement Night OGM . <ul style="list-style-type: none">• Press 9 to record and wait for the beep before speaking.• Press # to stop recording.
6	Press to play current auto attendant directory announcement. <ul style="list-style-type: none">• Press 9 to record and wait for the beep before speaking.• Press # to stop recording.

Answering system

Remote access

7	Press to play current private mailbox announcement. <ul style="list-style-type: none">• Press 9 to record and wait for the beep before speaking.• Press # to stop recording.
8	Press to stop the playing message.
9	Press to start recording a memo. <ul style="list-style-type: none">• Press # to stop recording.
0	Press to turn the private mailbox on or off.
#	Press during a message playback to delete current message.
X	Press during a message playback to delete all messages.

5. Hang up to end the call.



NOTES:

- If you do not enter a valid remote access code, the auto attendant announces, *“The system does not recognize that extension. Please check it, and enter it again”*.
- If you do not enter any remote access command after you enter the remote access menu successfully, the answering system announces, *“Remote operation”*. The call ends when the announcement is repeated three times.
- If the memory is full, the system announces, *“Memory is full”* when you try to record a memo by pressing 9. You cannot record new memo until some old messages in the mailboxes are deleted. Check the system remaining space frequently to maintain availability of space (page 95).

Appendix

Console display screen messages

All messages are deleted	All messages in the central mailbox are erased. All messages in the private mailbox are erased.
Auto Att: ON	The auto attendant is on.
Auto Attendant is reset to default	The auto attendant settings are reset to default settings.
Call History EMPTY	There are no entries in the caller ID history.
Caller ID deleted	A caller ID history is deleted.
Check network	The console or deskset is not connected to the network.
Contact saved to Directory	A number is saved to the directory.
DECT Headset registered	The cordless headset registration was successful.
DECT Headset deregistered	The cordless headset is deregistered from the telephone system.
Directory 0 entry	There are no directory entries.
Directory memory full	The directory is full. You cannot save new entries unless you delete some current entries.
Ended	You have just ended a call.
Extension busy. Please try again later	The deskset extension is on a call.
Int.	The console is on an intercom call.
Intercom from:	There is an intercom call coming in.
Intercom to:	The console is making an intercom call.

Appendix

Console display screen messages

Line is not available at this time	<p>The telephone line cord is not plugged into the console.</p> <p>The line you are trying to reach is on a conference call.</p> <p>Call privacy is turned on on the line you are trying to reach.</p> <p>Other system extension is recording an incoming message.</p>
Line X	The telephone line X is in use.
Line X Incoming call	There is an incoming call from Line X.
No answer. Please try again later	The destination extension does not answer the intercom call.
No IP obtained. Check network.	There is no IP assigned to the console.
Number already saved	The telephone number you have entered is already stored in the directory.
Number saved to 1-touch key	The number is saved to the one-touch memory.
Obtain IP from DHCP server?	The console will obtain an IP address from the DHCP server.
Phone is set to default	All settings in the console are reset to default settings.
Redial deleted	A redial list entry is deleted.
Redial empty	The redial list is empty.
Registering DECT Headset...	The console is registering a cordless headset.

Appendix

Console display screen messages

Registering handset... (Put handset on cradle to start)	The console is registering a cordless handset.
Registration failed	Registration of a cordless handset or a DECT headset is failed.
System busy. Please try again later	All telephone lines are in use.
Transfer from:	There is a transferred call from a deskset extension.
Transfer Line X to:	The console is transferring a call to a deskset extension.
Unable to obtain IP. Please check DHCP server.	The console is unable to obtain an IP address. You may need to check the DHCP server.
XX New calls	There are new calls in the caller ID history.
XX New messages	There are new messages in either the central or private mailbox.

Appendix

Troubleshooting

If you have difficulty with your telephone, please try the suggestions below. For customer service, visit our website at **businessphones.vtech.com** or call **1 (800) 595-9511**. In Canada, please dial **1 (800) 267-7377**.

The console fails to obtain an IP from the router.

- Make sure your router is properly installed and plugged into the Ethernet network.
- Make sure the DHCP server is enabled on your router, so that it can allocate IP automatically.
- You may need to enter a static IP to the console. Refer to **Network setup** on page 33 for details.

The console displays Check Network.

- Make sure your console is connected to the Ethernet switch or router properly.
- If you have set a static IP manually, you need to reboot the console to apply the new setting.
- Your router may have reassigned a new IP address to the console. Reboot the console to update.
- If you changed to a new router, make sure the discovery method matches with the console. Refer to **Discovery method** on page 36 to set the discovery method.
- Your Ethernet cable may be defective. Try installing a new one.



My telephone base doesn't work at all.

- Make sure the power cord is securely plugged in.
- Make sure you plug the telephone line cords securely and firmly into the console and the telephone wall jacks.
- Make sure you plug the Ethernet cable securely and firmly into the console and an Ethernet switch or router.
- Refer to **Console installation** on pages 11-15 to reset the system. Allow at least one minute for the console to reset.
- This system is not compatible with any other VTech 4-line small business telephones, except for the UP406 telephone.

Appendix

Troubleshooting

There is no dial tone.

- First try all the suggestions above.
- Make sure you plug the handset cord securely and firmly into the  jack on the telephone base and the corded handset.
- If the previous suggestions do not work, disconnect the telephone line from the console and connect it to a different telephone. If there is no dial tone on that telephone either, the problem is in your wiring or local service. Contact your telephone service provider.
- Your telephone line cords or Ethernet cable might be defective. Try installing new ones.
- Make sure a line is selected. Press a line key (**L1-L4**) or **SPEAKER** .
- If there is no dial tone when you press **HEADSET**, make sure the corded headset is firmly connected to the  jack.

I cannot dial out.

- First try all the suggestions above.
- Make sure you have a dial tone before dialing. The corded handset might take a second or two to connect the console and produce a dial tone. This is normal. Wait an extra second before dialing.
- Make sure the telephone is set to the correct dial mode (pulse dial or tone dial) for the service in your area. Refer to **Dial mode** on page 44 to set the dial mode.
- If the other telephones in your building are having the same problem, contact your telephone service provider.

My computer can't connect to the network after plugging the Ethernet cable through the PC port (.

- Make sure the console is connected to power. The PC port () does not work when the console does not have power source or during a power outage.
- Make sure you plug the Ethernet cable connecting to the Ethernet switch or router into the Ethernet port and the Ethernet cable connecting to the computer into the PC port.

The network connection speed on my computer drops significantly after plugging the Ethernet cable through the PC port (.

- If you are using Gigabit Ethernet system, the connection speed drops to 100M after plugging the Ethernet cable through the PC port (.

Appendix

Troubleshooting

I cannot make intercom calls.

- Make sure you choose the correct extension.
- The destination telephone might be on an external call. Wait and try again.
- Make sure the **INTERCOM** light is off before you make an intercom call. If the light is on, the system is busy or the intercom is unavailable. Try again when the intercom light goes off.
- Check to make sure that each system extension has a unique extension number. Refer to **Set extension number** on page 29 for details.
- You cannot use intercom when all four outside lines are in use.

I cannot transfer outside calls.

- If you are on a conference call with another telephone in the same system, the call cannot be transferred.
- If the destination telephone is on an outside call or intercom call with another system telephone, the call cannot be transferred.
- Check to make sure that each system extension has a unique extension number. Refer to **Set extension number** on page 29 for details.
- The destination party is busy, try again later.

I cannot join a conversation in progress.

- The call privacy feature prevents another set on the system from interrupting a conversation. Make sure you turn off call privacy during a call. See **Call privacy** on page 44 and 52.

I hear a double-beep sound every 30 seconds.

- There is a call on hold at this extension. Press and release the **LINE** key of the call on hold to return to the call and turn off the reminder beep.

Operation during a power failure.

- This phone operates with limited features during a power failure. You are able to make and answer calls using the corded handset only. No other features available until power is restored. All feature settings and memory are retained during a power failure.

The console display screen is blank.

- Make sure the power cord is connected to both the console and an electrical outlet not controlled by a wall switch.

Appendix

Troubleshooting

My calls fade in and out while I'm using my corded handset.

- If you have a corded headset plugged into the telephone, try unplugging it and firmly plugging it in again.
- Disconnect the console from the modular jack and plug in another corded telephone. If calls are still not clear, the problem is probably in the wiring or local service. Contact your local service company (charges may apply).
- If you are using the speakerphone when this problem occurs, eliminate any background noise. Noise from the television, radio, or other appliances might cause the speakerphone to cut in and out. Try engaging the **MUTE** button when you are not speaking or eliminating the background noise.

I hear other calls while using my telephone.

- Disconnect the telephone line from the console, and plug it into a different telephone. If you still hear other calls, call your telephone service provider.

My console does not ring when I receive a call.

- Make sure that the ringer is not off. Refer to **Ringer volume** on page 38 in this user's manual.
- Make sure the telephone line cords, power cord and Ethernet cable are plugged in securely.
- Make sure the system is properly set up. Refer to **Console installation** on pages 11-17 for details.
- If the other telephones in your building are having the same problem, contact your telephone service provider.
- Test a working telephone at the telephone jack. If another telephone has the same problem, contact your telephone service provider.
- The telephone line cord might be defective. Try installing a new line cord.
- Make sure that the Line group assignment is correct. See **Line group** on page 32 for more details.

My caller ID isn't working.

- Caller ID is a subscription service. You must subscribe to this service from your telephone service provider for this feature to work on your telephone base.
- The caller must be calling from an area that supports caller ID.
- Both your and your caller's telephone service providers must use caller ID compatible equipment.
- Make sure the area codes are set correctly on the console. See **Home area code** on page 42 for details.

Appendix

Troubleshooting

- If you subscribe to high-speed Internet service (DSL - digital subscriber line) through your telephone lines, you must install a DSL filter between each telephone line cord and telephone wall jack. The filter prevents noise and caller ID problems resulting from DSL interference. Please contact your DSL service provider for more information about DSL filters.

System does not receive caller ID when on a call.

- Make sure you subscribe to caller ID with call waiting features from your telephone service provider. Caller ID feature works only if both you and the caller are in areas offering caller ID service, and if both telephone service providers use compatible equipment.

The outgoing announcement is not clear.

- When recording the announcement, make sure you speak in a normal tone of voice about nine inches from the console.
- Make sure there is no background noise (television, music, traffic, etc.) when recording.

The auto attendant does not record messages.

- Make sure the auto attendant is turned on (page 83).
- Make sure the memory of the answering system is not full. Please refer to the **Call screening** on page 95 in the user's manual. If the memory is full, the system announces "*Memory full*" and then hangs up. You need to delete some old messages in order to make room for new messages.
- If **Greeting only** is selected in the **Message length** menu (page 94), the answering system only plays the outgoing announcement. It does not record incoming message.

The auto attendant announcement is not correct.

- Make sure the day/night announcements are set up and recorded (page 85).
- Make sure that the DAY and NIGHT times that you entered are appropriate. See **Set the start and end time of auto attendant announcement** on page 86.

Appendix

Troubleshooting

The auto attendant does not respond when callers dial an extension.

- Make sure directory announcement is recorded correctly to suit your company's needs (page 85).
- Make sure the caller is calling from a touch-tone telephone. If the caller hears clicks rather than tones, the commands are not recognized.
- The auto attendant might not detect the callers' commands when the announcement plays. Wait until the announcement is over before entering the code.
- There might be interference on the telephone line callers are using. Press the dial pad keys firmly when dialing.

The answering system is recording incomplete messages.

- If the message length is not set to unlimited and a caller leaves a very long message, part of it may be lost when the system disconnects the call after the set message length. See **Message alert** on page 94 for details.
- If the caller pauses for longer than seven seconds, the system stops recording and disconnects the call.
- If the system's memory becomes full during message recording, the system stops recording and disconnects the call.
- If the caller's voice is very soft, the system may stop recording and disconnect the call.

I have difficulty hearing messages.

- Press **▲/VOLUME** to increase the speaker volume on the console.

The answering system does not respond to remote access commands.

- Make sure you are using the correct remote access code (page 93).
- Make sure you are calling from a touch-tone telephone (away from home). When dialing a number, you should hear tones. If you hear clicks, then it is not a touch-tone telephone and cannot activate the answering system.
- The answering system might not detect the remote access code when your announcement is playing. Wait until the announcement is over before entering the code.
- There might be interference on the telephone line you are using. Press the dial pad keys firmly when dialing.

Appendix

Troubleshooting

I subscribe to a nontraditional telephone service that uses my computer to establish connections, and my telephone doesn't work.

- Make sure your computer is powered on.
- Make sure your Internet connection is working properly.
- Make sure that the software is installed and running for your nontraditional telephone service.
- Make sure to plug your USB telephone adapter into a dedicated USB port on your computer. Do not plug it into a multiple port USB hub (USB splitter) that is not powered.
- In a few rare instances, the USB port on your computer may not have enough power. Try using a USB hub with its own external power supply.
- If you are using a firewall, it may prevent access to your nontraditional telephone service provider. Contact your service provider for more information.

Common cure for electronic equipment.

If the telephone base does not seem to be responding normally, do the following (in the order listed):

1. Disconnect the power from the console.
2. Wait a few minutes.
3. Connect power to the console.
4. Wait for the console to synchronize its connection. This will take at least one minute to finish.

Appendix

Maintenance

Taking care of your telephone

- Your telephone base contains sophisticated electronic parts, so you must treat it with care.
- Avoid rough treatment.
- Place the corded handset down gently.
- Save the original packing materials to protect your telephone base if you ever need to ship it.

Avoid water

- You can damage your telephone base if it gets wet. Do not use the corded handset in the rain, or handle it with wet hands. Do not install the telephone base near a sink, bathtub or shower.

Electrical storms

- Electrical storms can sometimes cause power surges harmful to electronic equipment. For your own safety, take caution when using electric appliances during storms.

Cleaning your telephone

- Your telephone base has a durable plastic casing that should retain its luster for many years. Clean it only with a soft cloth slightly dampened with water or a mild soap.
- Do not use excess water or cleaning solvents of any kind.

Remember that electrical appliances can cause serious injury if used when you are wet or standing in water. If the telephone base should fall into water, DO NOT RETRIEVE IT UNTIL YOU UNPLUG THE POWER CORD AND TELEPHONE LINE CORDS FROM THE WALL, then pull the unit out by the unplugged cords.

Appendix

FCC part 68 and ACTA

This equipment complies with Part 68 of the FCC rules and with technical requirements adopted by the Administrative Council for Terminal Attachments (ACTA). The label on the back or bottom of this equipment contains, among other things, a product identifier in the format US:AAAEQ##TXXXX. This identifier must be provided to your telephone service provider upon request.

The plug and jack used to connect this equipment to premises wiring and the telephone network must comply with the applicable Part 68 rules and technical requirements adopted by ACTA. A compliant telephone cord and modular plug is provided with this product. It is designed to be connected to a compatible modular jack that is also compliant. An RJ11 jack should normally be used for connecting to a single line and an RJ14 jack for two lines. See Installation Instructions in the user's manual.

The Ringer Equivalence Number (REN) is used to determine how many devices you may connect to your telephone line and still have them ring when you are called. The REN for this product is encoded as the 6th and 7th characters following the US: in the product identifier (e.g., if ## is 03, the REN is 0.3). In most, but not all areas, the sum of all RENs should be five (5.0) or less. For more information, please contact your telephone service provider.

This equipment may not be used with Party Lines. If you have specially wired alarm dialing equipment connected to telephone line, ensure the connection of this equipment does not disable your alarm equipment. If you have questions about what will disable the alarm equipment, consult your telephone service provider or a qualified installer.

If this equipment is malfunctioning, it must be unplugged from the modular jack until the problem has been corrected. Repairs to this telephone equipment can only be made by the manufacturer or its authorized agents. For repair procedures, follow the instructions outlined under the **Limited Warranty**.

If this equipment is causing harm to the telephone network, the telephone service provider may temporarily discontinue your telephone service. The telephone service provider is required to notify you before interrupting service. If advance notice is not practical, you will be notified as soon as possible. You will be given the opportunity to correct the problem and the telephone service provider is required to inform you of your right to file a complaint with the FCC. Your telephone service provider may make changes in its facilities, equipment, operation, or procedures that could affect the proper functioning of this product. The telephone service provider is required to notify you if such changes are planned.

If this product is equipped with a corded or cordless handset, it is hearing aid compatible.

If this product has memory dialing locations, you may choose to store emergency telephone numbers (e.g., police, fire, medical) in these locations. If you do store or test emergency numbers, please:

Remain on the line and briefly explain the reason for the call before hanging up.

Perform such activities in off-peak hours, such as early morning or late evening.

Industry Canada

This device complies with Industry Canada licence-exempt RSS standard(s).

Operation is subject to the following two conditions: (1) this device may not cause harmful interference, and (2) this device must accept any interference received, including interference that may cause undesired operation.

The term "IC:" before the certification/registration number only signifies that the Industry Canada technical specifications were met.

The Ringer Equivalence Number (REN) for this terminal equipment is 0.1. The REN is an indication of the maximum number of devices allowed to be connected to a telephone interface. The termination on an interface may consist of any combination of devices subject only to the requirement that the sum of the RENs of all the devices does not exceed five.

This product meets the applicable Industry Canada technical specifications.

Appendix

FCC part 15

This equipment has been tested and found to comply with the limits for a Class A digital device, pursuant to Part 15 of the FCC Rules. These limits are designed to provide reasonable protection against harmful interference when the equipment is operated in a commercial environment. This equipment generates, uses, and can radiate radio frequency energy and, if not installed and used in accordance with the instruction manual, may cause harmful interference to radio communications. Operation of this equipment in a residential area is likely to cause harmful interference in which case the user will be required to correct the interference at his own expense.

This Class A digital apparatus complies with Canadian requirements:
CAN ICES-3 (A)/NMB-3(A)

Cet appareil numérique de classe A est conforme à l'exigence canadienne:
CAN ICES-3 (A)/NMB-3(A)

WARNING: Changes or modifications to this equipment not expressly approved by the party responsible for compliance could void the user's authority to operate the equipment.

Caution: To maintain the compliance with the FCC's RF exposure guideline, place the base unit at least 20cm from nearby persons.

Appendix

Limited warranty

1. What does this limited warranty cover?

The manufacturer of this VTech product warrants to the holder of a valid proof of purchase (“CONSUMER” or “you”) that the product and all accessories provided in the sales package (“PRODUCT”) are free from defects in material and workmanship, pursuant to the following terms and conditions, when installed and used normally and in accordance with the PRODUCT operating instructions. This limited warranty extends only to the CONSUMER for products purchased and used in the United States of America and Canada.

2. What will VTech do if the PRODUCT is not free from defects in materials and workmanship during the limited warranty period (“materially defective PRODUCT”)?

During the limited warranty period, VTech’s authorized service representative will repair or replace at VTech’s option, without charge, a materially defective PRODUCT. If we repair the PRODUCT, we may use new or refurbished replacement parts. If we choose to replace the PRODUCT, we may replace it with a new or refurbished PRODUCT of the same or similar design. We will retain defective parts, modules, or equipment. Repair or replacement of the PRODUCT, at VTech’s option, is your exclusive remedy. VTech will return repaired or replacement products to you in working condition. You should expect the repair or replacement to take approximately 30 days.

3. How long is the limited warranty period?

The limited warranty period for the PRODUCT extends for TWO (2) YEARS from the date of purchase. If VTech repairs or replaces a materially defective PRODUCT under the terms of this limited warranty, this limited warranty also applies to repaired or replacement PRODUCT for a period of either (a) 90 days from the date the repaired or replacement PRODUCT is shipped to you or (b) the time remaining on the original two-year limited warranty; whichever is longer.

4. What is not covered by this limited warranty?

This limited warranty does not cover:

- PRODUCT that has been subjected to misuse, accident, shipping or other physical damage, improper installation, abnormal operation or handling, neglect, inundation, fire, water, or other liquid intrusion; or
- PRODUCT that has been damaged due to repair, alteration, or modification by anyone other than an authorized service representative of VTech; or
- PRODUCT to the extent that the problem experienced is caused by signal conditions, network reliability or cable or antenna systems; or
- PRODUCT to the extent that the problem is caused by use with non-VTech accessories; or
- PRODUCT whose warranty/quality stickers, PRODUCT serial number plates or electronic serial numbers have been removed, altered or rendered illegible; or
- PRODUCT purchased, used, serviced, or shipped for repair from outside the United States of America or Canada, or used for commercial or institutional purposes (including but not limited to products used for rental purposes); or
- PRODUCT returned without a valid proof of purchase (see item 6 on the next page); or
- Charges for installation or setup, adjustment of customer controls, and installation or repair of systems outside the unit.

Appendix

Limited warranty

5. How do you get warranty service?

To obtain warranty service, visit businessphones.vtech.com or call **1 (800) 595-9511**. In Canada, please dial **1 (800) 267-7377**.

NOTE: Before calling for service, please review the user's manual; a check of the PRODUCT's controls and features may save you a service call.

Except as provided by applicable law, you assume the risk of loss or damage during transit and transportation and are responsible for delivery or handling charges incurred in the transport of the PRODUCT(s) to the service location. VTech will return repaired or replaced PRODUCT under this limited warranty to you. Transportation, delivery or handling charges are prepaid. VTech assumes no risk for damage or loss of the PRODUCT in transit. If the PRODUCT failure is not covered by this limited warranty, or proof of purchase does not meet the terms of this limited warranty, VTech will notify you and will request that you authorize the cost of repair prior to any further repair activity. You must pay for the cost of repair and return shipping costs for the repair of products that are not covered by this limited warranty.

6. What must you return with the PRODUCT to get warranty service?

You must:

- Return the entire original package and contents including the PRODUCT to the VTech service location along with a description of the malfunction or difficulty; and
- Include a "valid proof of purchase" (sales receipt) identifying the PRODUCT purchased (PRODUCT model) and the date of purchase or receipt; and
- Provide your name, complete and correct mailing address, and telephone number.

7. Other limitations

This warranty is the complete and exclusive agreement between you and VTech. It supersedes all other written or oral communications related to this PRODUCT. VTech provides no other warranties for this PRODUCT. The warranty exclusively describes all of VTech's responsibilities regarding the PRODUCT. There are no other express warranties. No one is authorized to make modifications to this limited warranty and you should not rely on any such modification.

State/Provincial Law rights: This warranty gives you specific legal rights, and you may also have other rights which vary from state to state or province to province.

Limitations: Implied warranties, including those of fitness for a particular purpose and merchantability (an unwritten warranty that the PRODUCT is fit for ordinary use) are limited to one year from date of purchase. Some states/provinces do not allow limitations on how long an implied warranty lasts, so the above limitation may not apply to you. In no event shall VTech be liable for any indirect, special, incidental, consequential, or similar damages (including, but not limited to lost profits or revenue, inability to use the PRODUCT or other associated equipment, the cost of substitute equipment, and claims by third parties) resulting from the use of this PRODUCT. Some states/provinces do not allow the exclusion or limitation of incidental or consequential damages, so the above limitation or exclusion may not apply to you.

Please retain your original sales receipt as proof of purchase.

Appendix

Technical specifications

RF frequency band	1921.536MHz - 1928.448MHz
Channels	5
Operating temperature	32 F - 122 F 0 C - 50 C
Telephone base voltage (AC adapter output)	5.1VDC @1200mA
Ethernet Network Ports	10/100 Mbps RJ-45 Port
PSTN Jacks	1-4 (FXO ports)

Index

A

- Add a handset 25
- Add a headset 26, 28
- Alert tones 5
- Announcement 84–87, 90
- Answer a call 49
- Answer an intercom call 61
- Auto-redial 57
- Auto attendant 96–97
- Auto set IP 33

B

- Blind transfer 62

C

- Caller ID 75–81
- Call history 77
- Call intercept 92, 98
- Call privacy 44, 52
- Call screening 95, 98
- Call transfer 62, 63
- Call waiting 50, 75
- Capacity 68, 82
- Cardiac pacemakers ii
- Chain dialing 54
- Change the extension number 29
- Conference call 58–60
- Connect a deskset 23–24
- Contrast 43

D

- Date 40
- Default settings 46
- Delay 83, 89
- Deregister a headset 27
- Deregistering a handset 27
- Deskset connection 23–24
- Dialing options 78
- Dial mode 44

- Directory 68–74
- Directory card 2
- Display dial 72

E

- End a call 48
- End a conference call 58, 59
- End an intercom call 61

F

- FCC, ACTA and IC regulations 114
- Flash 50

H

- Handset registration 25
- Handsfree use 49
- Hold 51
- Hold reminder 45
- Home area code 42

I

- Icons 4
- Important safety information i–ii
- Indication 4, 5, 48, 98
- Installation 11–17
- Intercom 61, 63

J

- Join a call 59

K

- Key tone 43

L

- Language 41
- Lights 5
- Limited warranty 116–117
- Line group 32
- Line indicators 48
- Listening volume 50

Index

M

Maintenance 113
Make a call 48
Make an intercom call 61
Memo 100
Memory match 77
Menu settings 29
Message Date/Time 93
Message indication 98
Message playback 98
Missed (new) calls indicator 77
Music on hold 45, 51
Mute 50

N

Navigation keys 1
Network information 37
New message indication 98
Night mode 85

O

One-touch 64–67
One-touch keys 2
On hook dialing (predialing) 49
Operation 48–67
Overview 1–3

P

Pacemaker patients ii
PC port 8
Phonebook (directory) 68–74
Predialing 49
Prime line 31
Privacy 44, 52
Private mailbox 89–92
Pulse dialing 44

R

Record a call 53
Recording time 95
Redial 55
Register a handset 25
Register a headset 26
Remote access 101–102
Rename console 46
Review call history 77
Review directory 70
Ringer tone 39
Ringer Volume 38

S

Search by name 71
Search for a contact 71
Set Date/Time 40
Set default 46
Set static IP 16, 34–35
Settings 38–47
Share a call 59
Speakerphone 49
Switch between lines 51
System setup 29–37

T

Technical specifications 118
Telephone operation 48–67
Temporary ringer silencing 49
Temporary tone dialing 50
Time 40
Transfer a call 62, 63
Troubleshooting 106–112
Two-way recording ii

Index

V

Volume 38, 50

Volume control 50

W

Wall mount 18–22

Warranty 116–117

Website 47

Source of music files for the Music on hold feature:
FreeMusicArchive.org. Used under open license.



Designed to fit you home.
And your life.

VTech Communications, Inc.
A member of THE VTECH GROUP OF COMPANIES.
VTech is a registered trademark of VTech Holdings Limited.
Specifications are subject to change without notice.
© 2014 VTech Communications, Inc.
All rights reserved. 04/14. UP416_WEB CIB_V1.0
Document order number: 91-007440-010-100