

Go to
www.vtechphones.com
to register your product for
enhanced warranty support and
the latest VTech product news.

CM18445

4-Line
Small Business System
Main Console



vtech[®]
User's manual

Congratulations

on your purchase of this VTech product. Before using this product, please read the **Important safety information**.

This user's manual provides you with the complete installation, setup and operation instructions.

For customer service or product information, visit our website at **www.vtechphones.com** or call **1 (800) 595-9511**. In Canada, please dial **1 (800) 267-7377**.

Model number: CM18445

Type: 4-Line Small Business System Main Console

Serial number: _____

Purchase date: _____

Place of purchase: _____

Both the model and serial numbers of your VTech product can be found on the bottom of the console.

Save your sales receipt and original packaging in case it is necessary to return your telephone for warranty service.



Telephones identified with this logo have reduced noise and interference when used with most T-coil equipped hearing aids and cochlear implants. The TIA-1083 Compliant Logo is a trademark of the Telecommunications Industry Association. Used under license.

Introduction

Planning your system

The CM18445 is the main console of your new 4-line telephone system. It can be used as a standalone telephone when a single user monitors up to four telephone lines provided by your telephone service provider.

You can also expand the system by adding a combination of up to nine cordless handsets (VTech model CM18045), cordless desksets (VTech model CM18245), cordless headsets (VTech model IS6100) and cordless speakerphones (AT&T model TL80133).

As the cordless devices communicate with the console over the wireless DECT technology, there is no need to plug telephone lines into the cordless devices. All telephone lines only connect to the console.

Purchase up to nine cordless accessories:

- Cordless handsets (VTech model CM18045)
- DECT 6.0 expansion desksets (VTech model CM18245)
- Cordless headsets (VTech model IS6100)
- Cordless speakerphones (AT&T model TL80133)

To order them, visit our website at www.vtechphones.com or call **1 (800) 595-9511**. In Canada, please dial **1 (800) 267-7377**.

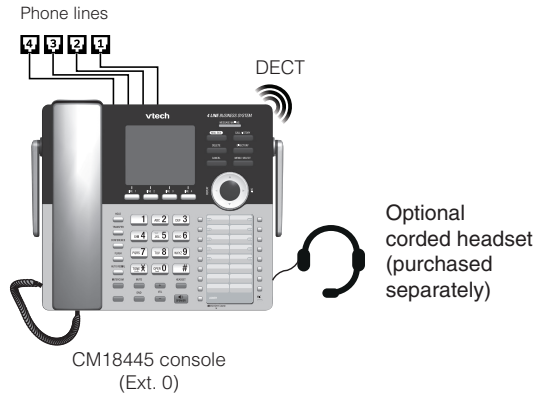

Optional corded headset (purchased separately)



CM18245 deskset (Ext. 1, 2, 3...)



CM18045 handset (Ext. 1, 2, 3...)



IS6100 headset (Ext. 9, 8, 7...)



TL80133 speakerphone (Ext. 9, 8, 7...)

- Each telephone system contains a maximum of 10 stations, consisting of one console and up to any nine of the mentioned cordless DECT devices. Each station has a unique extension number, used to identify each device for system operations such as intercom, paging, and call transfer.
- Each system supports up to four traditional POTs or PSTN lines. To allow proper operation of the digital answering system and auto attendant, you should connect only one telephone system to the desired telephone lines.
- If you have cordless accessories, for optimum range and better reception, place the console in a central and open location.

Important safety information



This symbol is to alert you to important operating or servicing instructions that may appear in this user's manual. Always follow basic safety precautions when using this product to reduce the risk of injury, fire, or electric shock.

Safety information

- Read and understand all instructions in the user's manual. Observe all markings on the product.
- Avoid using a telephone during a thunderstorm. There may be a slight chance of electric shock from lightning.
- Do not use the telephone to report a gas leak in the vicinity of the leak. Under certain circumstances, a spark may be created when the adapter is plugged into the power outlet, or when the handset is replaced in its cradle. This is a common event associated with the closing of any electrical circuit. The user should not plug the phone into a power outlet, and should not put a charged handset into the cradle, if the phone is located in an environment containing concentrations of flammable or flame-supporting gases, unless there is adequate ventilation. A spark in such an environment could create a fire or explosion. Such environments might include: medical use of oxygen without adequate ventilation; industrial gases (cleaning solvents; gasoline vapors; etc.); a leak of natural gas; etc.
- Do not use this product near water, or when you are wet. For example, do not use it in a wet basement or shower, or next to a swimming pool, bathtub, kitchen sink, or laundry tub. Do not use liquids or aerosol sprays for cleaning. If the product comes in contact with any liquid, unplug any line or power cord immediately. Do not plug the product back in until it has dried thoroughly.
- Avoid placing the telephone system in places with extreme temperature, direct sunlight, or other electrical devices. Protect your phone from moisture, dust, corrosive liquids and fumes.
- Install this product in a protected location where no one can trip over any line or power cords. Protect cords from damage or abrasion.
- If this product does not operate normally, see the **Troubleshooting** section on pages 94-100 of this user's manual. If you cannot solve the problem, or if the product is damaged, refer to the **Limited warranty** section on pages 106-107. Do not open this product except as directed in your user's manual. Opening the product or reassembling it incorrectly may expose you to hazardous voltages or other risks.
- This power adapter is intended to be correctly oriented in a vertical or floor mount position. The prongs are not designed to hold the plug in place if it is plugged into a ceiling, an under-the-table or cabinet outlet.
- For PLUGGABLE EQUIPMENT, the socket-outlet shall be installed near the equipment and shall be easily accessible.



Cautions:

- Use only the power adapter provided with this product. To obtain a replacement, visit our website at www.vtechphones.com or call 1 (800) 595-9511. In Canada, please dial 1 (800) 267-7377.
- To prevent risk of fire or battery explosion, replace with the correct battery type. Dispose of used batteries according to the instructions.

Important safety information

Especially about cordless telephones

- **Electrical power:** The console must be connected to a working electrical outlet. The electrical outlet should not be controlled by a wall switch. Calls cannot be made from the handset if the console is unplugged, switched off or if the electrical power is interrupted.
- **Power adapter:** The power adapter is intended to be correctly oriented in a vertical or floor mount position. The prongs are not designed to hold the plug in place if it is plugged into a ceiling, under-the-table or cabinet outlet.

Precautions for users of implanted cardiac pacemakers

Cardiac pacemakers (applies only to digital cordless telephones):

Wireless Technology Research, LLC (WTR), an independent research entity, led a multidisciplinary evaluation of the interference between portable wireless telephones and implanted cardiac pacemakers. Supported by the U.S. Food and Drug Administration, WTR recommends to physicians that:

Pacemaker patients

- Should keep wireless telephones at least six inches from the pacemaker.
- Should NOT place wireless telephones directly over the pacemaker, such as in a breast pocket, when it is turned ON.
- Should use the wireless telephone at the ear opposite the pacemaker.

WTR's evaluation did not identify any risk to bystanders with pacemakers from other persons using wireless telephones.

Especially about telephone answering systems

Two-way recording: This unit does not sound warning beeps to inform the other party that the call is being recorded. To ensure that you are in compliance with any federal or state regulations regarding recording a telephone call, you should start the recording process and then inform the other party that you are recording the conversation.

SAVE THESE INSTRUCTIONS

Parts checklist

Your telephone package contains the following items. Save your sales receipt and original packaging in the event warranty service is necessary.



User's manual



Quick start guide



Addendum sheet (IS6100 & TL80133)



Handset with coiled cord installed



Console



Power adapter



Audio cable (Music On Hold)



Four telephone line cords (4-conductor)



Mounting bracket



Two directory cards



Extension number label for cordless headset and speakerphone

Table of contents

Getting started

Installation	1
Backup battery installation.....	2
Console installation	3
Wall mount installation (optional).....	6
Tabletop to wall installation	6
Wall to tabletop installation.....	9
Adding and registering a cordless deskset.....	10
Adding and registering a cordless handset	11
Adding and registering other cordless accessories	12
Adding a corded headset (optional).....	13
System setup.....	14
Line mode.....	14
Set date and time	15
Ring group.....	16
Music on hold (M.O.H.)	17
Console overview	20
Table 1 - Main menu (Press MENU/SELECT in idle screen).....	23
Table 2 - Answering system setup sub-menu (Select Ans sys setup in main menu)	25
Console screen icons	26
Alert tones and lights	27

Settings

Console setup.....	28
Menu settings	28
Ringer volume	28
Ringer tone.....	29
Do not disturb (DND).....	29
LCD contrast	30
Key tone	30
Language	31
Primary line	31
Call privacy.....	32

Area codes	33
Console name	34
Hold reminder.....	34
Dial mode	35
Factory reset	35
User support.....	35

Operation

Console operation	36
Line indicators	36
Making and ending a call.....	36
On hook dialing (predialing)	37
Full-duplex speakerphone	37
Answering a call	37
Temporary ringer silencing.....	37
Options while on calls.....	38
Call waiting.....	38
Volume control	38
Mute	38
Temporary tone dialing.....	38
Hold.....	39
Switching between lines.....	39
Call privacy.....	40
Recording a call.....	41
Chain dialing.....	42
Redial	43
View the 10 most recently dialed numbers	43
Redial a number	43
Copy a redial entry to directory	43
Delete a number.....	44
Auto-redial	44
Conference call.....	45
Establish a conference call.....	45
Options during a conference call.....	46
Intercom.....	47
Make an intercom call to an extension.....	47

Answer an intercom call	47
End an intercom call	47
Answer an incoming call during an intercom call	48
Hold an intercom call	48
Handle an intercom call by the general mailbox	48
Call transfer	49
Blind transfer	49
Call transfer using intercom	50
Transfer a call and speak to the receiving party	50
Paging	51
Make a paging call to an extension	51
Make a paging call to multiple extensions	51
Set and edit a group for paging calls	52
Delete the group settings	52
End a paging call	52
Speed dial	53
Assign a speed dial entry	53
Dial a speed dial entry	55
Delete a speed dial entry	55
COVM	56
COVM (central office voicemail)	56
COVM reset	56

Directory

About the directory	57
Capacity	57
Exit the directory	57
Create directory entries	58
Create a new directory entry	58
Review directory entries	59
Search directory	60
Search by name	60
Dial, delete or edit entries	61
Display dial	61
Delete an entry	61
Edit an entry	61

Call history

About the caller ID	62
Information about caller ID with call waiting	62
Caller ID information	63
How the caller ID information works	63
Caller ID operation	64
Memory match	64
Missed (new) calls indicator	64
Review the caller ID information	64
View dialing options	65
Dial a call history entry	65
Save a caller history entry to the directory	66
Delete entries	66
Reasons for missing caller ID information	67

Answering system

About the answering system	68
Answering system capacity	69
Auto attendant setup	70
Activate auto attendant	70
Number of rings (auto attendant)	70
Announcement (auto attendant)	71
General mailbox setup	75
Activate general mailbox	75
Number of rings (general mailbox)	75
Announcement (general mailbox)	76
Announce only setup	78
Activate announce only	78
Number of rings (announce only)	78
Announcement (announce only)	79
Answering system setup	81
Call screening	81
Message length	81
Call intercept	82
Set remote access code	82
Message alert tone	83

Auto attendant operation	84
Using the auto attendant	84
Auto attendant (AA) flow chart	85
Answering system operation	86
New message indication	86
Call screening.....	86
Call intercept	86
Message playback.....	86
Options during playback.....	87
Transfer messages.....	87
Delete all general mailbox messages...	88
Record and deliver memos	88
Remaining time	88
Remote access.....	89

Appendix

Deregistering extensions.....	90
Console display screen messages	91
Troubleshooting.....	94
Maintenance.....	101
FCC part 68 and ACTA	102
FCC part 15.....	103
For C-UL compliance only	104
Limited warranty	106
Technical specifications.....	108

Index.....	109
-------------------	------------

Getting started

Installation

Install the console close to the telephone jacks and a power outlet not controlled by a wall switch. The console can be placed on a flat surface or vertically mounted on the wall (pages 6-9).



NOTE: If you subscribe to high-speed Internet service (DSL - digital subscriber line) through your telephone lines, you must install DSL filters between the telephone line cords and the telephone wall jacks (see page 4 or page 5). The filter prevents noise and caller ID problems caused by DSL interference. Please contact your DSL service provider for more information about DSL filters.

Your product may be shipped with a protective sticker covering the console display - remove it before use.

For customer service or product information, visit our website at **www.vtechphones.com** or call **1 (800) 595-9511**. In Canada, please dial **1 (800) 267-7377**.

Avoid placing the console too close to:

- Communication devices such as television sets, VCRs, or other cordless telephones.
- Excessive heat sources.
- Noise sources such as a window with traffic outside, motors, microwave ovens, refrigerators, or fluorescent lighting.
- Excessive dust sources such as a workshop or garage.
- Excessive moisture.
- Extremely low temperature.
- Mechanical vibration or shock such as on top of a washing machine or work bench.

Getting started

Backup battery installation

To maintain normal system operation in the event of a power failure, please purchase and install four AA alkaline batteries to this console before use. If power fails with working batteries installed, all functions work properly except for the display illumination.

Install the batteries, as shown below:



1. Press the tab and pull to remove the battery compartment cover. Insert four AA alkaline batteries (purchased separately) following the polarity markings in the battery compartment.

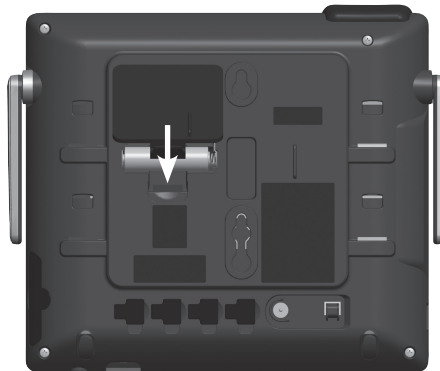

2. Align the cover flat against the battery compartment, then press down until it clicks into place.



NOTES:

-  appears steadily on the screen when backup batteries are installed.
- When the backup battery is running low, the screen displays the low battery icon .

Getting started

Console installation

1. Install the mounting bracket for tabletop use.

Low tabletop position: Insert the fixed tabs of the mounting bracket into slots (A) and (B). Press the flexible tabs into slots (C) and (D) until they click into place.



High tabletop position: Insert the fixed tabs of the mounting bracket into slots (A) and (B). Press the flexible tabs into slots (C) and (D) until they click into place.



2. Connect the telephone line cord(s) and the power cord to the console. See the illustration on the next page to connect to four single-line wall jacks; or see page 5 to connect to two 2-line wall jacks.

Getting started

Console installation

Option 1: If you have four single-line wall jacks, install your console, as shown below.

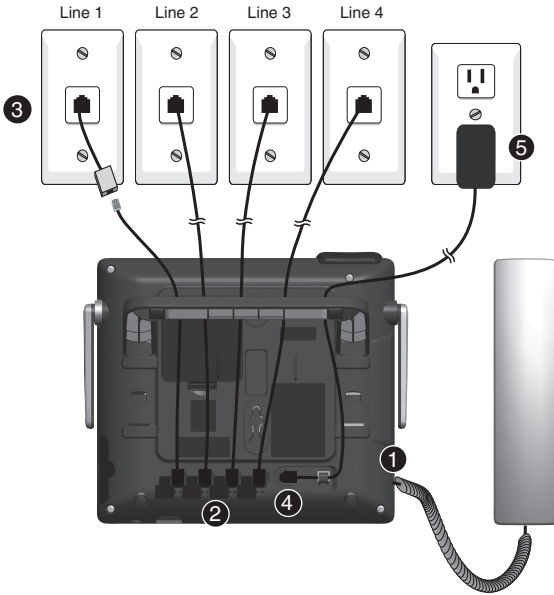

1. One end of the coiled telephone line cord has already been plugged into the handset. Make sure it is plugged in firmly. Plug the other end of the coiled handset cord into the left side of the console.
2. Open the line jack covers and plug one end of the telephone line cords into the telephone line jacks of the console.
3. Plug the other end of the telephone line cords into the single-line telephone wall jacks, as shown above.
4. Insert the connector of the power adapter to the power jack on the back of the console.
5. Connect the plug head of the power adapter to the power outlet that is not controlled by a wall switch.

Once the installation is successful, you can make and receive calls on the console. Now, you can also register your cordless devices or skip to page 14 to configure your console.

NOTES:

- Use only the power adapter supplied with this product. To order a replacement power adapter, visit our website at www.vtechphones.com or call 1 (800) 595-9511. In Canada, please dial 1 (800) 267-7377.
- If you are installing less than four telephone line cords to the console, plug the telephone line cords in ascending order starting from the L1/2 jack. Avoid having unoccupied telephone jack between other occupied telephone jacks.

Getting started

Console installation

Option 2: If you have two 2-line wall jacks, install your console, as shown below.

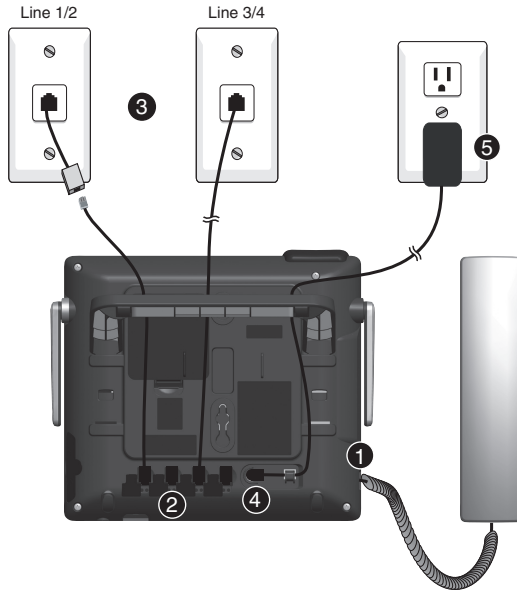

1. One end of the coiled telephone line cord has already been plugged into the handset. Make sure it is plugged in firmly. Plug the other end of the coiled handset cord into the left side of the console.
2. Open the line jack covers and plug one end of the telephone line cords into the **L1/2** and **L3/4** jacks on the back of the console.
3. Plug the other end of the telephone line cords into the 2-line telephone wall jacks.
4. Insert the connector of the power adapter to the power jack on the back of the console.
5. Connect the plug head of the power adapter to the power outlet that is not controlled by a wall switch.

Once the installation is successful, you can make and receive calls on the console. Now, you can also register your cordless devices or skip to page 14 to configure your console.

NOTES:

- Use only the power adapter supplied with this product. To order a replacement power adapter, visit our website at www.vtechphones.com or call **1 (800) 595-9511**. In Canada, please dial **1 (800) 267-7377**.
- A 2-line wall jack supports two telephone numbers in one wall jack. Contact your telephone service provider for details.
- The spared **L2** and **L4** jacks can be connected to non-system telephones, sharing those particular telephone lines. Do not connect a fifth or sixth telephone line to the **L2** and **L4** jacks as it is not the intended purpose of those jacks.

Getting started

Wall mount installation (optional)

Tabletop to wall installation

To install your console in the wall installation position, make sure you first unplug the power adapter from the electrical outlet and the telephone line cords from the wall outlet.

1. Place your corded handset aside. Use a coin to rotate the handset tab 180 degrees. The protruding edge holds the corded handset when the console is mounted on the wall.

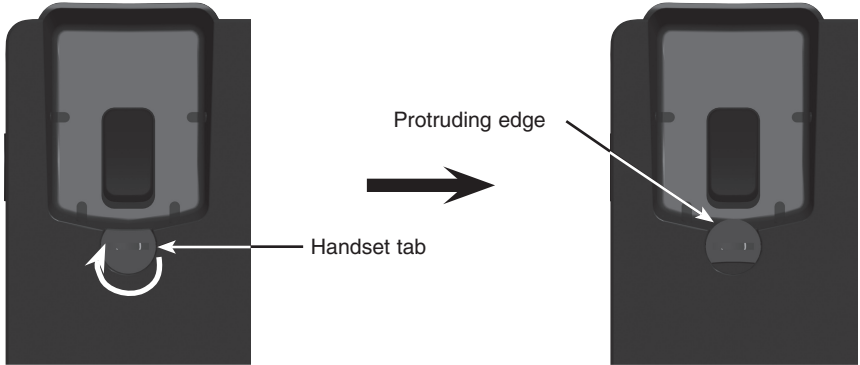

2. Press in the direction indicated by the arrows to release and remove the mounting bracket from the console.

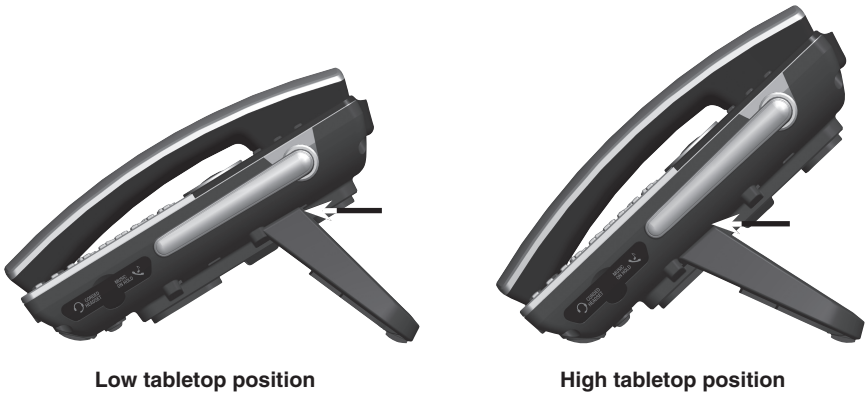

3. Place the corded handset back to the console. Plug the small end of the power adapter cord into the power jack on the back of the console.

Getting started

Wall mount installation (optional)

4. Plug the telephone line cords into the wall jacks.

Option 1: If you have four single-line wall jacks, connect the telephone line cords, as shown below.

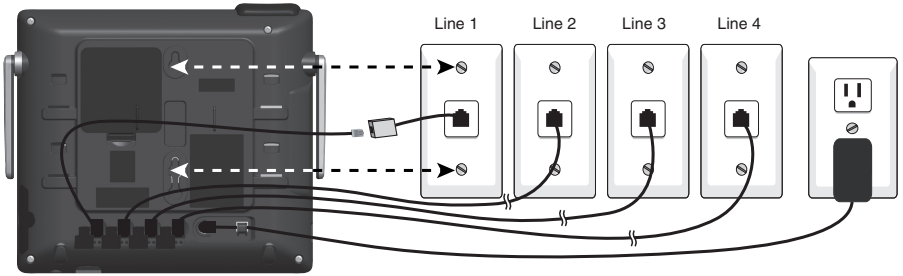

Option 2: If you have two 2-line wall jacks, connect the telephone line cords, as shown below.

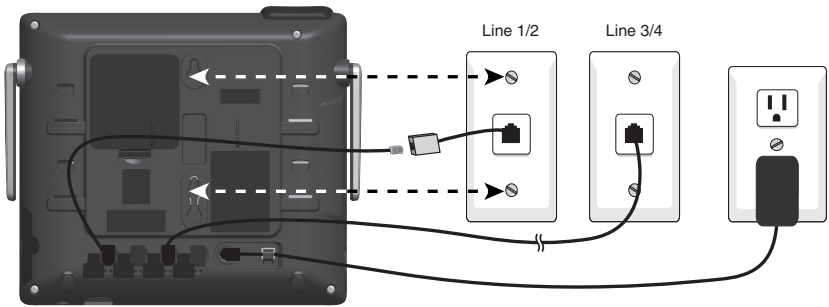

Getting started

Wall mount installation (optional)

5. Wrap the telephone line cords, as shown below. Mount the telephone on the mounting plate until it is held securely into position. Plug the large end of the power adapter into an electrical outlet not controlled by a wall switch.

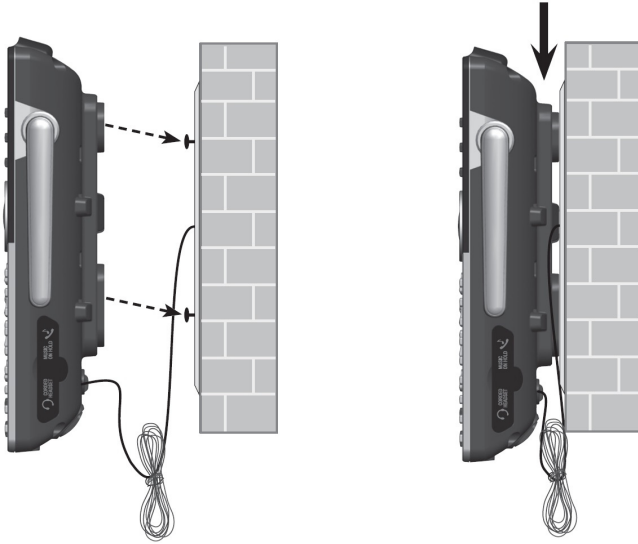

Getting started

Wall mount installation (optional)

Wall to tabletop installation

To return the console from wall installation to tabletop position:

1. Unwrap the telephone line cords. Remove the console from the wall. Unplug the telephone line cords from the telephone wall jack and the power adapter cord from the electrical outlet.

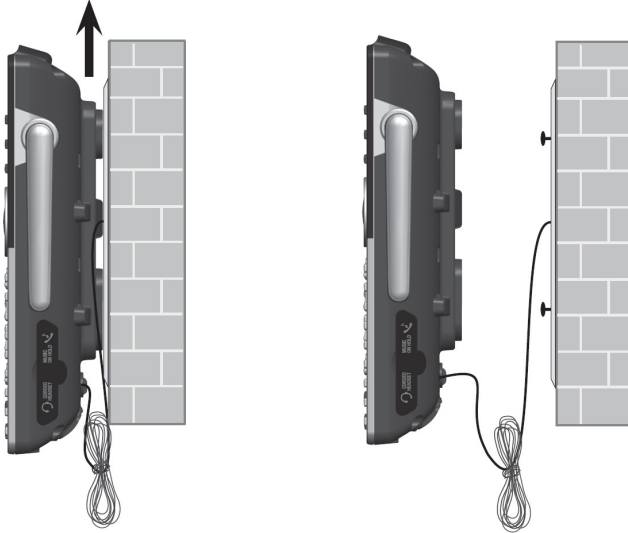

2. Place the corded handset aside. Use a coin to rotate the handset tab 180 degrees.

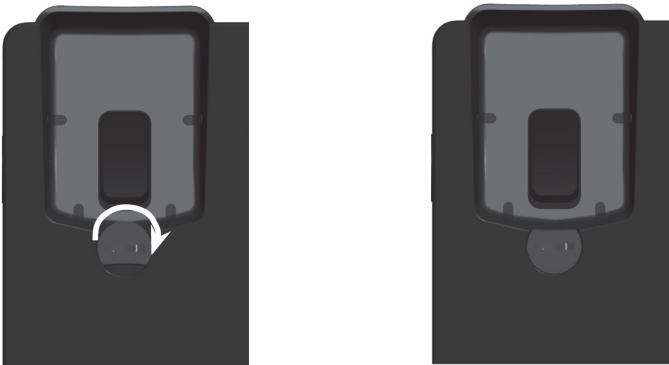

3. Follow the steps in **Console installation** on pages 3-5 to install your console for tabletop use.

Getting started

Adding and registering a cordless deskset

You can add desksets (CM18245, purchased separately) to your console. Each deskset must be registered with the console before use.

The desksets are assigned with available extension numbers starting from 1 in ascending order (1 to 9). You can register a maximum of nine cordless devices to the console.



To register a deskset to your console

The CM18245 deskset shows **1) Press MENU on Console ->Registration ->Register Ext.** and **2) Press # on this extension to register.** alternately before you begin registration.

1. On the console, press **MENU/SELECT**.
2. Press **▲** or **▼** to scroll to **Registration**, then press **MENU/SELECT** or **SKIP▶**.
3. Press **MENU/SELECT** or **SKIP▶** again to select **Register Ext.**
4. On the deskset, press **#**. The deskset shows **Registering....**
5. You hear a beep when the registration is successful. Both the console and the deskset show **Deskset X registered.** (X represents the extension number 1-9). It takes up to 60 seconds to complete the registration.



NOTES:

- If the registration is not successful, the console screen displays **Registration failed.** Try the registration process again.
- You can continue to register a second deskset by following step 3 on the console and step 4 on the deskset. If no action is taken, the console will return to idle mode.

CM18245:

```
1) Press MENU
on Console
->Registration
->Register Ext.
```

```
2) Press # on
this extension
to register.
```

CM18445:

```

  ▲
Directory
Call history
Ringer setting
Console setup
Line mode
Ans evs setup
>Registration
```

```

  ▲
Registration:
>Register Ext
Deregistration
```

Getting started

Adding and registering a cordless handset

You can add cordless handsets (CM18045, purchased separately) to your console. Each handset must be registered with the console before use. The handsets are assigned with available extension numbers starting from 1 in ascending order (1 to 9).



Make sure the cordless handset is properly installed before you begin registration. Refer to the user's manual of the cordless handset for details. If the handset does not have enough power to proceed with the registration, you need to charge the new handset for at least five minutes.

To register a handset to your console

Make sure the CM18045 handset is out of the charger and the screen shows **1) Press MENU on Console ->Registration ->Register Ext. 2) Press # on this extension to register.** before you begin registration.

1. On the console, press **MENU/SELECT**.
2. Press **▲** or **▼** to scroll to **Registration**, then press **MENU/SELECT** or **SKIP▶**.
3. Press **MENU/SELECT** or **SKIP▶** again to select **Register Ext.**
4. On the handset, press **#**. The handset shows **Registering....**
5. The handset beeps once and begins registering to the console. It takes up to 60 seconds to complete the registration. There is a beep sound when the registration is successful. Both the console and the handset show **Handset X registered.** (X represents the extension number 1-9).

CM18045:

```
1) Press MENU on Console  
->Registration  
->Register Ext.  
2) Press # on this extension to register.
```

CM18445:

```
Directory  
Call history  
Ringer setting  
Console setup  
Line mode  
Ans sus setup  
>Registration
```

```
Registration:  
>Register Ext  
Deregistration
```

NOTES:

- If the registration is not successful, the console screen displays **Registration failed**. Try the registration process again.
- You can continue to register a second handset by following step 3 on the console and step 4 on the handset. If no action is taken, the console will return to idle mode.

Getting started

Adding and registering other cordless accessories

You can add cordless headsets (VTEch model IS6100), or cordless speakerphones (AT&T model TL80133) to the console. The cordless accessories are sold separately.

Make sure the cordless headset or speakerphone is charged before use. Refer to the corresponding user's manual for details. You can register a maximum of nine cordless devices to the console. The registered cordless headsets and speakerphones are assigned with available extension numbers starting from 9 in descending order (**9 to 1**), and they behave as individual stations.

After registration, you have an option to link them with the console, deskset or cordless handset. As cordless headsets and speakerphones rely on other stations within the system to make outgoing calls, linking them with other extensions allows you to make a call handsfree. Besides, information about which line the cordless headset or speakerphone is operating will display on the screen of the linked extension.

For details about registration, linking and operations of the cordless accessories, refer to the separate addendum sheet that comes with the package.



VTEch IS6100



AT&T TL80133

Getting started

Adding a corded headset (optional)

You can use this console handsfree when you install any industry-standard 2.5mm corded telephone headset (purchased separately). See page 37 for instructions on using the corded headset with this telephone.

To add a corded headset to the console



Side view of the console

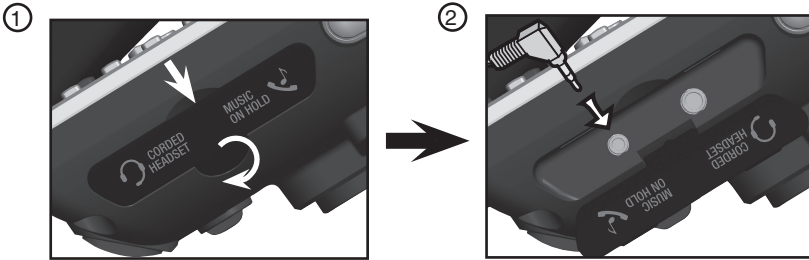

1. Lift open and rotate the plastic cover.
2. Plug a 2.5 mm headset into the **CORDED HEADSET** (📞) jack on the side of the console.



NOTE: If you have corded and cordless headsets connected to your console, the **HEADSET** button only controls the corded headset. For more details on the operation of the corded headset, refer to the user's manual for the corded headset.

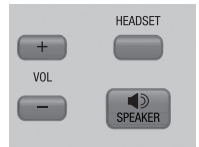

Getting started

System setup

Line mode

Use this feature to set each of the telephone lines to respond to incoming calls in one of the four possible line modes, as shown in the chart below.

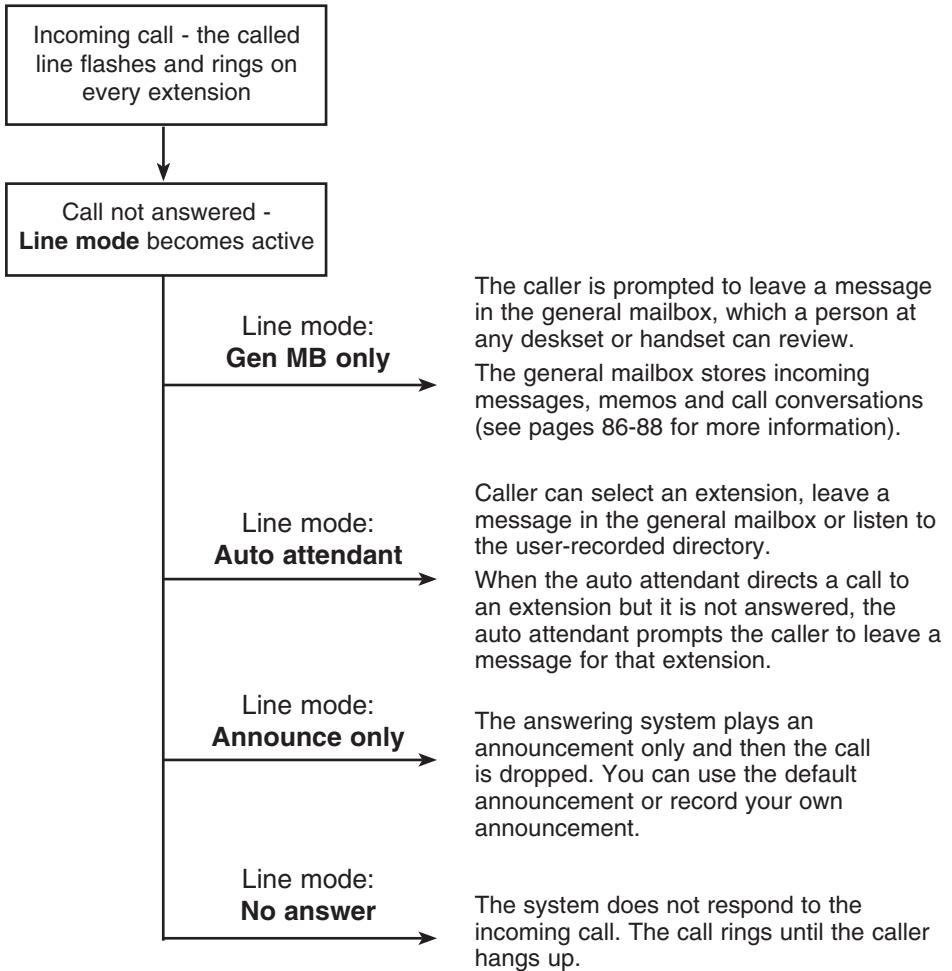

To select the line mode:

1. When the console is idle, press **MENU/SELECT**.
2. Press **▲** or **▼** to scroll to **Line mode**, then press **MENU/SELECT** or **►/SKIP**.
3. Press **▲** or **▼** to select the desired line (**Line 1**, **Line 2**, **Line 3** or **Line 4**) or **All lines**, then press **MENU/SELECT** or **►/SKIP**.
4. Press **▲** or **▼** to choose the desired line mode (**Gen MB only**, **Auto attendant**, **Announce only** or **No answer**).
5. Press **MENU/SELECT** or **►/SKIP** to confirm. To exit without making changes, press **CANCEL** or **◀/REPEAT**.

Getting started

System setup

Set date and time

The answering system displays the date and time of the message while playing messages. Before using the answering system, follow the steps below to set the month, day, year and time.

1. When the console is idle, press **MENU/SELECT**.
2. Press **▲** or **▼** to scroll to **Date and time**, then press **MENU/SELECT** or **▶/SKIP**.
3. Use the dialing keys to enter the month (MM), day (DD) and year (YY), or press **▲** or **▼** to increase or decrease the digits. Press **◀/REPEAT** or **▶/SKIP** to scroll between month, day and year.
4. Press **MENU/SELECT** to move to the time setting.
5. Use the dialing keys to enter the hour and minute, or press **▲** or **▼** to increase or decrease the digits and toggle between **am** and **pm**. Press **◀/REPEAT** or **▶/SKIP** to scroll between the hour (HH), minute (MM) and **am/pm**.
 - If you enter digits larger than 12 in the hour field, the system automatically converts to the 12-hour time format.
6. Press **MENU/SELECT** to save the setting and return to the previous menu. To exit without making changes, press **CANCEL**.



NOTES:

- If the date and time are not set when a message is recorded, the system does not display date and time on the screen while playing messages.
- The date and time settings on the console are synchronized with other extensions automatically.

Getting started

System setup

Ring group

Use this feature to specify which extensions ring and display the caller ID information when there is incoming call on a certain telephone line. By default, all extensions ring on all lines. You can exclude some extensions from the ring group, however, they can still be used to make outgoing calls on the non-ringing line.

1. When the console is idle, press **MENU/SELECT**.
2. Press **▲** or **▼** to scroll to **Ringer setting**, then press **MENU/SELECT** or **▶/SKIP**.
3. Press **▲** or **▼** to scroll to **Ring group**, then press **MENU/SELECT** or **▶/SKIP**.
4. Press **▲** or **▼** to review the ring groups of different line (**Line 1-Line 4**).
5. Press **MENU/SELECT** or **SKIP▶** to edit the group member. Use the dial pad to press the number of the extension (**0, 1, 2, 3, 4, 5, 6, 7, 8, 9**) that you want to remove, or press the number again to add it back to the ring group. The non-existing extensions are represented by **X**.
6. Press **MENU/SELECT** or **SKIP▶** to save the setting and return to the previous menu. To exit without making changes, press **CANCEL**.



NOTES:

- **0** represents the console.
- All registered cordless headsets or speakerphones are bound to be in all ring groups.

Getting started

System setup

Music on hold (M.O.H.)

You can choose what callers hear when being placed on hold.

You have four options:

- If you want callers to hear the hold reminder tone, select **Hold tone** in the M.O.H. source menu (page 17).
- If you want callers on hold to hear one of the three default music that comes with the telephone, select the desired music (**M.O.H. 1 - M.O.H. 3**) in the M.O.H. source menu (page 17).
- If you want callers on hold to hear audio or music from an audio source that you recorded in the console using the audio cable, select **Recorded M.O.H.** in the M.O.H. source menu (pages 18-19).
- If you want callers to hear audio directly streamed into the telephone, connect an audio source, such as a computer, mobile phone or MP3 player, to the console using the audio cable (page 17).



NOTES:

- Source of default music files: FreeMusicArchive.org. Used under open license.
- If user of other extension holds a call while the console is reviewing or recording M.O.H., the far end will hear the double-beep hold tone. Release the hold and hold the call again to apply the M.O.H..

Review and select music on hold source:

1. When the console is idle, press **MENU/SELECT**.
2. Press **▲** or **▼** to scroll to **Music on hold**. Press **MENU/SELECT** or **▶/SKIP**.
3. Press **▲** or **▼** to scroll to **M.O.H. source**, then press **MENU/SELECT** or **▶/SKIP**.
4. The default music or tone plays while you press **▲** or **▼** to highlight a music on hold source.
5. Press **MENU/SELECT** or **▶/SKIP** to select a highlighted M.O.H. source and return to the previous menu.
 - If you select **Aux. in device** but no audio device is connected to the **MUSIC ON HOLD (🔊)** jack, the screen displays **No device is connected to the M.O.H. jack at console**. Connect an audio device to the **MUSIC ON HOLD (🔊)** jack (page 18), then choose **Aux. in device** again.
 - If you select **Recorded M.O.H.** but no recorded music is available, the screen displays **Record M.O.H.: [SELECT] to rec..** Refer to pages 18-19 for details on recording music.
6. To exit without making changes, press **CANCEL** or **◀/REPEAT**.



NOTE: You cannot make any changes to the settings of M.O.H. source while a call is currently on hold. The screen displays **M.O.H. currently in use. Please try again later**.

Getting started

System setup

Record music or a voice message:

You can record audio or music from an audio source such as a computer, mobile phone or MP3 player with a 3.5mm audio jack using the audio cable provided. The recording can be up to three minutes long and plays repeatedly while a call is on hold.



NOTE: It is the user's responsibility to comply with the copyright laws and to provide lawfully acquired music for the music on hold feature. Unlawful use of copyright protected music and/or lyrics may subject the user to fines and other legal action.

Record music or a message using an audio device:

1. When the console is idle, press **MENU/SELECT**.
2. Press **▲** or **▼** to scroll to **Music on hold**, then press **MENU/SELECT** or **▶/SKIP**.
3. Press **MENU/SELECT** or **▶/SKIP** again to select **Record M.O.H.**
4. Plug one end of the audio cable into the **MUSIC ON HOLD** (🔊) jack on the console and plug the other end of the audio cable into the 3.5mm audio output jack on your audio device, as shown below.

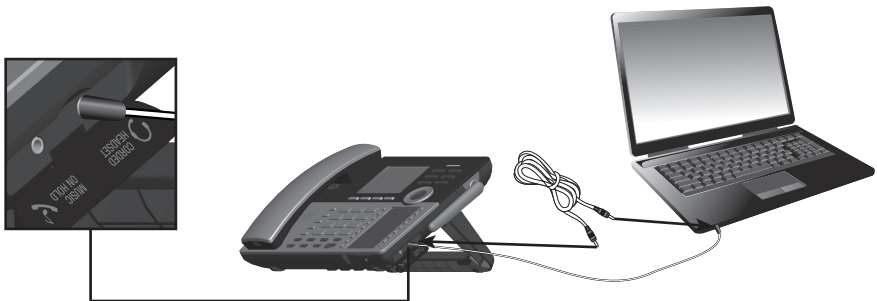

5. When your audio device is ready to play, press **MENU/SELECT** on the console. You hear the voice prompt *"Record after the tone. Press SELECT when you are done."* Start playing the music or message on your audio device after the beep. The audio plays through the speakerphone and a counter on the screen shows the elapsed time. The maximum record time is three minutes, at which time the console automatically stops recording. You can press **CANCEL** or **◀/REPEAT** to abort recording without saving.
6. Press **MENU/SELECT** to stop recording. You hear the playback of the recording.
7. Press **▲** or **▼** to choose **OK** to save the recording, or choose **Change** to record again if desired. Press **MENU/SELECT** or **▶/SKIP**.

Getting started

System setup



NOTES:

- If you want to record a piece of new music while the music on hold is in use, **M.O.H. currently in use. Please try again later.** displays on the screen.
- If you fail to record a message, ensure that the audio cable is fully plugged into the **MUSIC ON HOLD** (🎧) jack.

Change the music on hold volume:

The music on hold volume can only be changed at the audio device.

1. Place a call to your console.
2. Press **HOLD** on the console to place the call on hold. Listen to the music on hold to determine if the volume is desirable.
3. If you are want to make adjustments to the volume on the audio device and record the audio again, start again with step 1 of **Record music or a message using an audio device.**

-OR-

If you get streaming audio from a device and want to make adjustments to the volume, change the volume on the audio device while the call is on hold until you find the desired volume. When you finish listening to the audio, hang up both telephones.

Getting started

Console overview

LINE 1-LINE 4 keys

- Press to make or answer a call on the desired line.

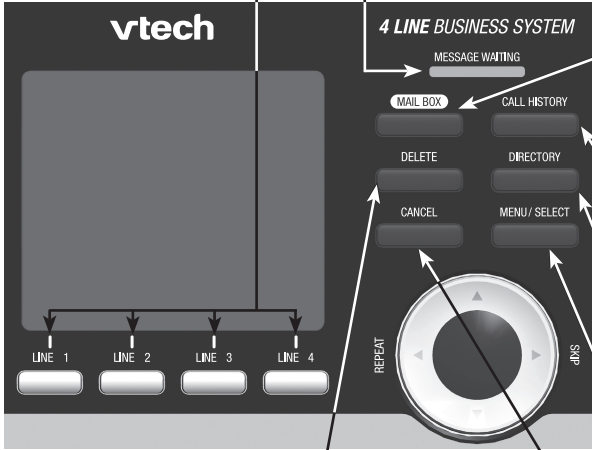

DELETE

- While playing a message, press to delete the message.
- While reviewing the call history, press to delete an individual entry.
- While predialing, press to delete digits.

MESSAGE WAITING indicator

- Turns on when there are new messages in the general mailbox.

MAIL BOX

- When in idle mode, press to enter the general mailbox menu.

CALL HISTORY

- Press to view caller ID information.

DIRECTORY

- Press to view directory information.

MENU/SELECT

- Press to enter the menu.
- While in the menu, press to select an item or save an entry or setting.

CANCEL

- While in a menu, press to cancel an operation and exit the menu display.

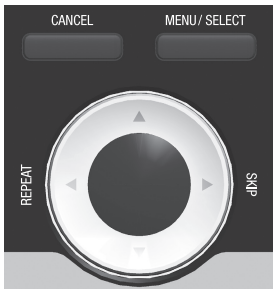

Navigation keys

- While in menus, press ▲ or ▼ to scroll through the menus. Press ►/SKIP to enter the highlighted item or save changes, or press ◀/REPEAT to return to the previous menu.
- While entering names or numbers, press ◀/REPEAT or ►/SKIP to move the cursor to the left or right.
- While playing back messages, press ◀/REPEAT to repeat the message, or press ►/SKIP to skip to the next message.

Getting started

Console overview

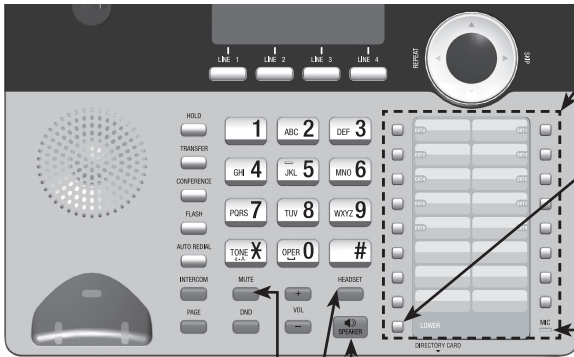

Speed dial keys

- Press to dial the desired speed dial number.

LOWER

- When assigning or dialing a speed dial number, press to switch to the lower location (the second 16 locations) of a speed dial key.

MIC

🔊 SPEAKER

- Press to turn on the speakerphone. Press again to turn it off.

MUTE

- During a call, press to mute the microphone.

HEADSET

- When a corded headset is connected to the console, press to make, answer or hang up a call.

HOLD

- Press to place an outside call or intercom call on hold.

FLASH

- During a call, press to answer an incoming call when you receive a call waiting alert.

TRANSFER

- Press to transfer a call to an extension.
- During message playback, press to transfer the message to an extension.

AUTO REDIAL

- Press to view the last 10 numbers dialed.

CONFERENCE

- Press to add another extension or outside line to an existing call.

INTERCOM

- When in idle mode, press to initiate an intercom call.

+ /VOL/-

- During a call, press to adjust the listening volume.
- During message playback, press to adjust the playback volume.
- Press to adjust the ringer volume when in idle mode.

PAGE

- Press to begin a one-to-one or one-to-group broadcast.

DND (do not disturb)

- Press to turn the feature on. Press again to turn off.

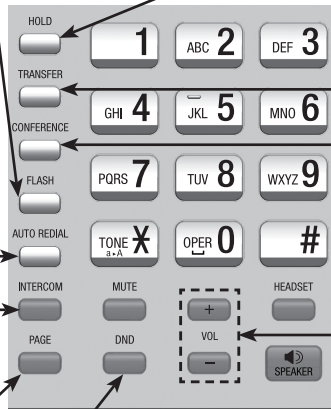

Getting started

Console overview

Directory card

To write names on the directory card, follow the steps mentioned below:

1. Write the information on a directory card that comes with the package.
2. Insert the edge of the directory card in the slot at the front of the console, under the plastic cover.



Main menu

The > symbol highlights a menu item.

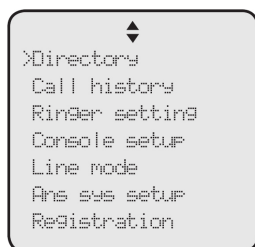

Main menu

- Directory
- Call history
- Ringer setting
- Console setup
- Line mode
- Ans sys setup
- Registration
- Music on hold
- COVM
- Date and time
- Speed dial
- Dial mode
- User support
- HDST/SPK
- Factory reset

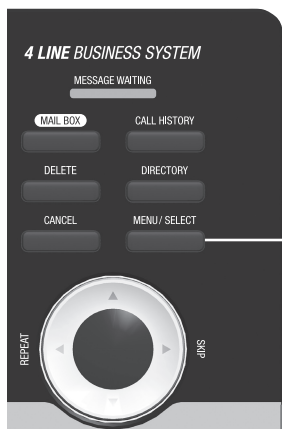

Using menus

- Press **MENU/SELECT** to show the main menu.
- Press ▲ or ▼ to scroll through menu items.
- Press **MENU/SELECT** or press ▶/**SKIP** to select a highlighted menu item.
- Press **MENU/SELECT** to save changes.
- Press **CANCEL** to cancel an operation, exit the menu display or return to the idle screen.

Getting started

Console overview

The following tables provides you with more details on the main menu and answering system setup sub-menu of the console.

Table 1 - Main menu (Press MENU/SELECT in idle screen)

Menu	Description	Reference
Directory	Review, add or delete directory entries.	Pages 57-61
Call history	Review, delete call history entries, or copy an entry to directory.	Pages 62-67
Ringer setting	Set the ringer volume, ringer tone, and ring group*. *Ring group defines which extension(s) will ring when there is an incoming call.	Pages 16, 28-29
Console setup	Set LCD contrast, key tone, language, primary line*, call privacy**, area codes, console name, and hold reminder. *Primary line defines which line is automatically selected each time you pick up the corded handset or press the speakerphone. **Call privacy defines whether other extensions can barge in to join a call in progress.	Pages 30-34
Line mode	Set how the answering system responds to incoming calls on each line: <ul style="list-style-type: none"> • General mailbox for callers to leave messages on the console's general mailbox. • Auto attendant for directing incoming calls to different extensions. • Announce only for informing callers that no one is available to answer the call. • No answer for turning off both the general mailbox and auto attendant. 	Page 14
Ans sys setup	Set up the answering system of the console, including general mailbox, auto attendant and announce only. Refer to Table 2 for details.	Pages 70-82
Registration	Add cordless deskset, cordless handset or other cordless accessories into the system.	Pages 10-12
Music on hold	Select different music for far end callers to hear during a hold call, and record your own music.	Pages 17-19

Getting started

Console overview

Table 1 - Main menu (Press MENU/SELECT in idle screen) (Continued)

Menu	Description	Reference
COVM	Set whether the console will display if Central Office has voicemail for you.	Page 56
Date and time	Set the date and time of the console. If you have subscribed to Caller ID Type I service, you can ignore this setting.	Page 15
Speed dial	Program the desired telephone numbers or extension numbers into the speed dial keys.	Pages 53-55
Dial mode	Set pulse dialing or tone dialing.	Page 35
User support	Display a website for you to get extra support.	Page 35
HDST/SPK	Review, change or remove the linkage of cordless headset or speakerphone with any system extensions.	Addendum sheet
Factory reset	Reset all settings of the console to the factory default.	Page 35

Getting started







Console overview

Table 2 - Answering system setup sub-menu (Select Ans sys setup in main menu)

Menu	Description	Reference
Gen MB setup	<p>Set up the console's general mailbox.</p> <p>This mode allows callers on a particular line to leave messages in the console's general mailbox. You can set the number of rings before the system answers the incoming calls and record your own greeting announcements.</p> <p>Line mode has to be set to Gen MB only for these features to function.</p>	Pages 75-77
Auto att setup	<p>Set up the auto attendant.</p> <p>This mode allows callers on a particular line to reach any extensions within the system without the need to forward the call manually. You can set the number of rings before the system picks up the call, and record your own greeting announcements and company directory.</p> <p>Line mode has to be set to Auto attendant for the features to function.</p>	Pages 70-74
Annc only setup	<p>Set up the announce only answer mode.</p> <p>This mode allows playing an announcement to callers that no one is available to take the call. You can set the number of rings before the system picks up the call and record your own greeting announcements.</p> <p>Line mode has to be set to Announce only for the features to function.</p>	Pages 78-80
Call screening	<p>Set whether the console user hears the caller whenever a voice recording is taking place.</p>	Page 81
Message length	<p>Set the maximum duration allowed for any voice messages recorded.</p>	Page 81
Call intercept	<p>Set whether users of other system extensions can intercept and stop a recording in console's general mailbox and talk to the caller.</p>	Page 82
Set access code	<p>Modify the passcode for users to access console's general mailbox remotely by making a call to one of the telephone lines.</p>	Page 82
Msg alert tone	<p>Set whether a tone is played in idle mode when there are unattended messages in the general mailbox.</p>	Page 83

Getting started

Console screen icons

	On when any corresponding extensions are in use.
	Ringer off - On steadily when the ringer volume is set to off or the do not disturb function is on.
	Headset - On steadily when using a corded headset.
COVM	There is new voicemail for the telephone line(s) next to the COVM indicator.
	Announce only is on for the telephone line below the Annc indicator.
	Auto attendant is on for the telephone line below the AuAt indicator.
	The general mailbox is turned on for the telephone line below the MB indicator.
	On when the console is running on backup battery.
-Mute	Microphone is muted.
-Priv	Call privacy is on.
-Rec	A call is being recorded.
Conf.	A conference call is active.
LOWER	The lower location of the speed dial keys is active.

Getting started

Alert tones and lights

Alert tones

One beep	The console is recording an announcement or memo.
Two beeps	You have set the hold reminder on; a call has been on hold for more than three minutes. -OR- You have set the message alert tone on. -OR- There is an incoming call waiting.

Lights

MESSAGE WAITING

- Turns on when there are new messages.

LINE 1/LINE 2/LINE 3/LINE 4

INTERCOM

- On when the console is on an intercom call.
- Flashes slowly when the console is holding an intercom call.
- Flashes quickly when there is an incoming intercom call.

MUTE

- On when the microphone is muted.

PAGE

- On when a one-to-one or one-to-group broadcast is established.



HEADSET

- On when the corded headset is in use.

SPEAKER

- On when the speakerphone is on.

DND

- On when the do not disturb function is on.

Settings

Console setup

Menu settings

Use this menu to change the telephone system settings.

1. Press **MENU/SELECT** when in idle mode (when the console is not in use) to enter the main menu.
2. Press **▲** or **▼** to scroll to the feature to be changed. The **>** symbol indicates the selected menu item.
3. Press **MENU/SELECT** or **▶/SKIP** to select the menu item.
4. Press **CANCEL** to exit setup without making changes.



NOTE: Press **CANCEL** to cancel an operation, exit the menu display, or return to idle mode.

Ringer volume

Use this feature to set the ringer volume to one of the six levels or turn the ringer off. When the ringer is off, the  icon appears on the console screen. The console stores the volume setting for all lines.

1. When the console is idle, press **MENU/SELECT**.
2. Press **▲** or **▼** to scroll to **Ringer setting**, then press **MENU/SELECT** or **▶/SKIP**.
3. Press **MENU/SELECT** or **▶/SKIP** again to select **Ringer volume**.
4. Press **▲**, **▼**, or **+VOL/-** on the console to adjust the ringer volume.
5. Press **MENU/SELECT** or **▶/SKIP** to save the setting and return to the previous menu. To exit without making changes, press **CANCEL** or **◀/REPEAT**.

-OR-

When the console is idle, press **+VOL/-** to adjust the ringer volume, then press **MENU/SELECT** to save.



NOTE: The ringer volume also determines the ringer volume for intercom calls. If the console ringer volume is set to off, it is silenced for all incoming calls, including intercom calls.

Settings

Console setup

Ringer tone

Use this feature to choose one of the ten ringer tones for incoming calls. You can choose different ringer tones for different lines so you can easily identify which line is calling.

1. When the console is idle, press **MENU/SELECT**.
2. Press **▲** or **▼** to scroll to **Ringer setting**, then press **MENU/SELECT** or **▶/SKIP**.
3. Press **▲** or **▼** to scroll to **Ringer tone**, then press **MENU/SELECT** or **▶/SKIP**.
4. Press **▲** or **▼** to select the desired line (**Line 1-Line 4**), then press **MENU/SELECT** or **▶/SKIP**.
5. Press **▲** or **▼** to select the desired ringer tone.
6. Press **MENU/SELECT** or **▶/SKIP** to save the setting and return to the previous menu. To exit without making changes, press **CANCEL** or **◀/REPEAT**.
7. Repeat steps 4-6 above to choose ringer tones for other lines if desired.

Do not disturb (DND)

Use this feature to silence your console. When you activate the do not disturb function, the  icon appears on the console screen. You will not receive any paging call and you will not hear rings of incoming call or intercom call.

Instead, the **LINE 1-LINE 4** indicator flashes to signal an incoming call. If you receive an intercom call, the extension number of that intercom call appears on the screen display.

1. Press **DND** to prevent interruptions. The **DND** indicator turns on.
2. Press **DND** again to resume normal call alerts. The **DND** indicator turns off.

Settings

Console setup

LCD contrast

Use this feature to adjust the screen contrast to one of five levels to optimize readability in different lighting conditions.

1. When the console is idle, press **MENU/SELECT**.
2. Press **▲** or **▼** to scroll to **Console setup**, then press **MENU/SELECT** or **▶/SKIP**.
3. Press **▲** or **▼** to scroll to **LCD contrast**, then press **MENU/SELECT** or **▶/SKIP**.
4. Press **▲** or **▼** to choose the desired screen contrast level.
5. Press **MENU/SELECT** or **▶/SKIP** to save the setting and return to the previous menu. To exit without making changes, press **CANCEL** or **◀/REPEAT**.

Key tone

The console is set to beep with each key press. If you turn off the key tone, there are no beeps when you press keys.

1. When the console is idle, press **MENU/SELECT**.
2. Press **▲** or **▼** to scroll to **Console setup**, then press **MENU/SELECT** or **▶/SKIP**.
3. Press **▲** or **▼** to scroll to **Key tone**, then press **MENU/SELECT** or **▶/SKIP**.
4. Press **▲** or **▼** to choose **On** or **Off**.
5. Press **MENU/SELECT** or **▶/SKIP** to save the setting and return to the previous menu. To exit without making changes, press **CANCEL** or **◀/REPEAT**.

Settings

Console setup

Language

This feature allows you to change the language used for all screen displays of the console and voice prompts used in the system. The language setting on the console also dictates voice prompts used in the registered desksets and cordless handsets. By default, the language is set to **English**.

1. When the console is idle, press **MENU/SELECT**.
2. Press ▲ or ▼ to scroll to **Console setup**, then press **MENU/SELECT** or ►/SKIP.
3. Press ▲ or ▼ to scroll to **Language**, then press **MENU/SELECT** or ►/SKIP.
4. Press ▲ or ▼ to select **English**, **Francais** or **Espanol**.
5. Press **MENU/SELECT** or ►/SKIP again to save the setting and return to the previous menu. To exit without making changes, press **CANCEL** or ◀/REPEAT.



NOTE: This setting does not change the LCD language of desksets and cordless handsets.

Primary line

Use this feature, also known as automatic line selection, to choose which line is automatically selected each time you make an outside call. The console comes factory set for **Auto** selectable line, which chooses any available line starting from **Line 1**.

1. When the console is idle, press **MENU/SELECT**.
2. Press ▲ or ▼ to scroll to **Console setup**, then press **MENU/SELECT** or ►/SKIP.
3. Press ▲ or ▼ to scroll to **Primary line**, then press **MENU/SELECT** or ►/SKIP.
4. Press ▲ or ▼ to select **Auto**, **Line 1**, **Line 2**, **Line 3** or **Line 4**.
5. Press **MENU/SELECT** or ►/SKIP again to save the setting and return to the previous menu. To exit without making changes, press **CANCEL** or ◀/REPEAT.

Settings

Console setup

Call privacy

The call privacy is set to **Off** by default. The console allows other extensions to join a call in progress. You can turn this setting on to ensure that only one device uses a line at a time.

1. When the console is idle, press **MENU/SELECT**.
2. Press ▲ or ▼ to scroll to **Console setup**, then press **MENU/SELECT** or ►/SKIP.
3. Press ▲ or ▼ to scroll to **Call privacy**, then press **MENU/SELECT** or ►/SKIP.
4. Press ▲ or ▼ to scroll to **On** or **Off**.
5. Press **MENU/SELECT** or ►/SKIP to save the setting and return to the previous menu. To exit without making changes, press **CANCEL** or ◀/REPEAT.



NOTE: To temporarily change the call privacy setting during a call, see page 40.

Settings

Console setup

Area codes

Use this feature to program this system to recognize one home area code and up to four local area codes. This feature makes it easy for you to place a call from the caller ID log.

If you dial seven digits to make a local call (no area code required), enter your area code into the telephone as the home area code. When you receive a call from within your home area code, the caller ID information only displays the seven digits of the telephone number, and when you dial from the call log, only seven digits are dialed.

If you must dial 10 digits (the area code and telephone number) for local calls, enter **000** for the home area code and enter your area code as a local area code. Then, if you receive a call from within your area code, the screen displays all 10 digits of the telephone number, and when you dial from the call log, all 10 digits are dialed.

If you have more than one area code for your region, enter those area codes as local area codes.

1. When the console is idle, press **MENU/SELECT**.
2. Press **▲** or **▼** to scroll to **Console setup**, then press **MENU/SELECT** or **►/SKIP**.
3. Press **▲** or **▼** to scroll to **Area codes**, then press **MENU/SELECT** or **►/SKIP**.
4. Press **▲** or **▼** to scroll to **Home area** or **Local area 1- Local area 4**. Press **MENU/SELECT** to edit it.
5. Use the dial pad keys to enter a three-digit area code. Enter **000** for your home area code if you always dial ten-digit numbers.
 - Press **DELETE** to delete a digit.
 - Press and hold **DELETE** to delete all digits.
 - Press **◀/REPEAT** or **►/SKIP** to move the cursor to the left or right.
 - Press **▲** or **▼** to move the cursor to the beginning or end.
6. Press **MENU/SELECT** to save the setting and return to the previous menu. To exit without making changes, press **CANCEL**.

Settings

Console setup

Console name

Use this feature to rename the console.

1. When the console is idle, press **MENU/SELECT**.
2. Press **▲** or **▼** to scroll to **Console setup**, then press **MENU/SELECT** or **▶/SKIP**.
3. Press **▲** or **▼** to scroll to **Console name**, then press **MENU/SELECT** or **▶/SKIP**.
4. Use the dialing keys to change the name (up to 10 characters).
 - Press **DELETE** to delete a character.
 - Press and hold **DELETE** to delete all characters.
 - Press **◀/REPEAT** or **▶/SKIP** to move the cursor to the left or right.
 - Press **▲** or **▼** to move the cursor to the beginning or end.
 - Press **0** to add a space.
5. Press **MENU/SELECT** to save the setting and return to the previous menu. To exit without making changes, press **CANCEL**.

Hold reminder

When the console holds an outside call or an intercom call for more than three minutes, it gives you a double beep every 30 seconds. You can set its volume to one of the six levels or mute the hold reminder.

1. When the console is idle, press **MENU/SELECT**.
2. Press **▲** or **▼** to scroll to **Console setup**, then press **MENU/SELECT** or **▶/SKIP**.
3. Press **▲** or **▼** to scroll to **Hold reminder**, then press **MENU/SELECT** or **▶/SKIP**.
4. Press **▲**, **▼**, or **+ /VOL/-** to choose the desired volume or mute the feature.
5. Press **MENU/SELECT** or **▶/SKIP** to save the setting and return to the previous menu. To exit without making changes, press **CANCEL** or **◀/REPEAT**.

Settings

Console setup

Dial mode

The dial mode is preset to tone dialing. If you have pulse (rotary) service, you must change the dial mode to pulse dialing before using the telephone.

1. When the console is idle, press **MENU/SELECT**.
2. Press **▲** or **▼** to scroll to **Dial mode**, then press **MENU/SELECT** or **▶/SKIP**.
3. Press **▲** or **▼** to scroll to **Touch-tone** or **Pulse**.
4. Press **MENU/SELECT** or **▶/SKIP** to save the setting and return to the previous menu. To exit without making changes, press **CANCEL** or **◀/REPEAT**.

Factory reset

Use this feature to reset all settings of this console to their default settings. All phone settings, directory, call history, redial list, speed dial memory, and general mailbox messages will be reset. All cordless devices will also be deregistered.

Make sure the telephone system is idle before you reset the console.

1. When the console is idle, press **MENU/SELECT**.
2. Press **▲** or **▼** to scroll to **Factory reset**.
3. Press **MENU/SELECT** or **▶/SKIP**. The screen displays **Are you sure to reset console?**
4. Press **▲** or **▼** to scroll to **Yes** or **No**.
5. Press **MENU/SELECT** or **▶/SKIP** to confirm. The console reboots upon completion of the reset process.



NOTES:

- The reset process may take up to 10 minutes to complete, depending on the number of voice messages across the whole system.
- The whole system is not functional while the console is resetting. Do not power off the console during this period.

User support

Use this feature to display the VTech website.

1. When the console is idle, press **MENU/SELECT**.
2. Press **▲** or **▼** to scroll to **User support**, then press **MENU/SELECT** or **▶/SKIP**.
3. Press **CANCEL** or **◀/REPEAT** to return to the main menu.

Operation

Console operation

The console comes programmed to select a line automatically for calls when you do not press a line key. To override the automatic line selection setting, see **Primary line** on page 31 for details. When you answer a call, the console automatically selects the ringing line.

Line indicators

Each of the four indicators on **LINE 1-LINE 4** indicate the state of the corresponding telephone line.

- On when the corresponding line is in use.
- Flashes slowly when the line is on hold.
- Flashes quickly when there is a transferred call on the corresponding line.
- Flashes quickly when there is an incoming auto attendant transferred call on the corresponding line.
- Flashes quickly when there is an incoming call on the corresponding line.

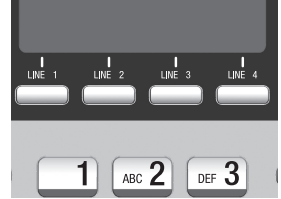

Making and ending a call

To make a call using the console:

1. Lift the handset or press **SPEAKER** .
- OR-**

To override automatic line selection, press **LINE 1-LINE 4** for the desired line, then lift the handset.

2. Wait for a dial tone, then enter the telephone number. The screen displays the elapsed time as you talk (in hours, minutes and seconds).

To end a call using the console:

- Place the handset on the console to hang up.
- OR-**
- If you are using the speakerphone, press **SPEAKER**  to hang up.



NOTE: The elapsed time is not affected by accessing services from your telephone service provider.

Operation

Console operation

To make a call using a corded headset:

Make sure a corded headset is connected to the console (page 13).

1. Press **HEADSET** on the console.
2. Wait for a dial tone, then dial the number.
3. To hang up, press **HEADSET**.

To make a call using a cordless headset or speakerphone:

You can make a call using a registered cordless headset or speakerphone after it is linked with an extension device. For more details, refer to the addendum sheet that comes with the package.



On hook dialing (predialing)

1. Enter the telephone number. Press **DELETE** to make corrections.
2. Lift the handset or press **SPEAKER**  to dial.

-OR-

To override automatic line selection, press **LINE 1-LINE 4** for the desired line, then lift the handset.

Full-duplex speakerphone

During a call, press **SPEAKER**  to switch between handsfree speakerphone and normal handset use. Press **SPEAKER**  again if you are using speakerphone or place the handset on the console to hang up.

Answering a call

Lift the handset, or press the corresponding line key (**LINE 1-LINE 4**), **SPEAKER** , **HEADSET** on the console to answer an incoming call.

Temporary ringer silencing

When the console is ringing, you can temporarily silence the ringer of the console without disconnecting the call. Press **MUTE** to silence the ringer. The next call rings normally at the preset volume.

Operation

Options while on calls

Call waiting

If you subscribe to call waiting service with your telephone service provider, and someone calls while you are in the middle of a call, you hear two beeps.

- Press **FLASH** to put your current call on hold and take the new call.
- Press **FLASH** at any time to switch back and forth between calls.

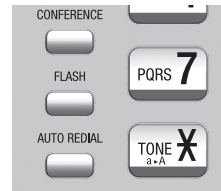

Volume control

Use this feature to independently set the listening volume to one of six levels for each of the listening options (corded handset, corded headset and speakerphone).

All settings are independent. While on a call, press **+VOL/-** to adjust the listening volume.



Mute

Use this feature during a telephone conversation to silence the microphone. You can hear the caller, but the caller cannot hear you.

To mute a call:

- Press **MUTE**. When mute is on, the **MUTE** button lights up; the screen also displays **MUTE**.

To take a call off mute:

- Press **MUTE** again and resume speaking.

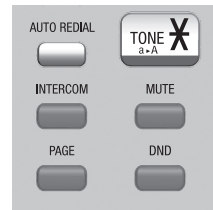

Temporary tone dialing

If you have pulse (rotary) service only, use this feature to temporarily switch pulse to touch-tone dialing during a call by pressing **TONE X**.

1. Press **TONE X** during a call.
2. Use the dialing keys to enter the desired number. The telephone sends touch-tone signals.

The telephone automatically returns to pulse dialing mode after you end the call.

Operation

Options while on calls

Hold

Use this feature to hold one line while accessing another, or as part of the conference feature.

While on a call, press **HOLD**. The corresponding line key (**LINE 1-LINE 4**) indicator for the line on hold flashes slowly. After the call has been put on hold for more than three minutes, a double beep sounds every 30 seconds. (To adjust the volume or turn off the reminder beep, see **Hold reminder** on page 34).

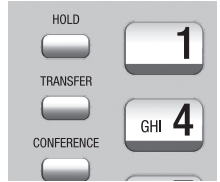

If you are using the speakerphone, the speakerphone turns off and the **SPEAKER** key turns off automatically after you press **HOLD**. If you are using the corded headset, the headset turns off and the **HEADSET** key turns off automatically after you press **HOLD**.

To release the hold, press the line key (**LINE 1-LINE 4**) of the line being put on hold.

Music on hold (M.O.H.) feature is available. When you put a call on hold, the caller will hear the music you set in the console. To change the setting and for more details, see **Music on hold** on pages 17-19.

Apart from holding outside lines, you can also hold internal intercom calls. See page 48 for details.



NOTES:

- The call privacy setting in **Console setup** menu remains unchanged after the call is put on hold.
- The call ends automatically after it is put on hold for 15 minutes.

Switching between lines

Use this feature to switch between lines during an outside call:

1. Press the desired line key (**LINE 1-LINE 4**) of the telephone line you want to make or answer call. The current call is put on hold automatically.
2. To return to the first call, press the line key (**LINE 1-LINE 4**) of the original call. The second line is put on hold automatically.

Operation

Options while on calls

Call privacy

During a call, you can temporarily change the call privacy setting to allow or disallow other extensions to join the call. The original setting is automatically restored after you hang up or resume the call you put on hold.

To turn call privacy off during a call:

1. While on a call, press **MENU/SELECT**.
2. Press **▲** or **▼** to choose **Private**, then press **MENU/SELECT** or **▶/SKIP**.

Other extensions can now join the call by pressing the corresponding line key (**LINE 1-LINE 4**).

To turn call privacy back on during a call:

1. While on a call, press **MENU/SELECT**.
2. Press **▲** or **▼** to choose **Private**, then press **MENU/SELECT** or **▶/SKIP**. The console displays **-Priv**.

No extension can join the call now. If another extension tries to access the line you are using, it displays **Private call**.



NOTE: To set call privacy for every incoming and outgoing call, see page 32.

Operation

Options while on calls

Recording a call

Use this feature to record two-way phone conversations, conferences or intercom calls. The recording is treated the same as memos and is marked as a new message in the general mailbox. Listen to recorded conversation the same way as incoming messages or memos (see **Message playback** on page 86).

To record a call:

1. While on a call, press **MENU/SELECT**.
2. Press **MENU/SELECT** or **▶/SKIP** to start recording.
3. The recording starts and the screen shows **-Rec.** Both the console user and the far-end party hear a beep sound.



NOTE: To ensure that you are in compliance with any federal or state regulations regarding recording a telephone call, you should start the recording process and then inform the other party that you are recording the call.

To stop recording:

Place the corded handset back to the console, or press **SPEAKER**  to hang up if you are using the speakerphone.

-OR-

Press **MENU/SELECT** twice during the recording. The system saves the conversation into the general mailbox.

Operation

Options while on calls

Chain dialing

While you are on a call, you can initiate a dialing sequence from the numbers in the directory, caller ID history, redial list or speed dial memory.

Chain dialing can be useful if you wish to access other numbers (such as bank account numbers or access codes) from the directory, caller ID history, redial list or speed dial memory.

To access the directory while on a call:

1. Press **DIRECTORY**, then press ▲ or ▼ to scroll to the desired entry.
2. Press **MENU/SELECT** to dial the desired number. To exit without making changes, press **CANCEL** and continue with the conversation.

To access the call history while on a call:

1. Press **CALL HISTORY**, then press ▲ or ▼ to scroll to the desired entry.
2. Press **MENU/SELECT** to dial the desired number. To exit without making changes, press **CANCEL** and continue with the conversation.

To access the redial list while on a call:

1. Press **AUTO REDIAL**, then press ▲ or ▼ to scroll to the desired entry.
2. Press **MENU/SELECT** to dial the desired number. To exit without making changes, press **CANCEL** and continue with the conversation.

To access the speed dial memory while on a call:

Press the desired speed dial key for the number in the upper location.

-OR-

Press **LOWER**, then press the desired speed dial key for the number in the lower location.

Operation

Redial

The last 10 telephone numbers dialed (up to 32 digits) are stored in the console.

View the 10 most recently dialed numbers

1. Press **AUTO REDIAL** to enter the redial list and display the most recently called number.
2. Press ▲ or ▼ to view other recently called numbers.
3. Press **CANCEL** to exit the redial list.

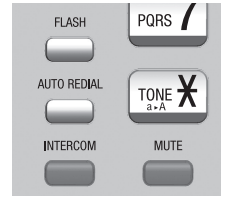

Redial a number

1. Lift the handset, press **SPEAKER** or the corresponding line key (**LINE 1-LINE 4**), then press **AUTO REDIAL** to enter the redial list.
2. Press ▲ or ▼ to select desired number, then press **MENU/SELECT** to dial.

-OR-

1. Press **AUTO REDIAL** to enter the redial list.
2. Press ▲ or ▼ to select desired number, then lift the handset, press **SPEAKER** or the corresponding line key (**LINE 1-LINE 4**) to dial.

Copy a redial entry to directory

1. Press **AUTO REDIAL** to enter the redial list and display the most recently called number.
2. Press ▲ or ▼ to view other recently called numbers.
3. Press ◀/REPEAT or ▶/SKIP to choose **Add to DIR**, then press **MENU/SELECT**.
4. The console displays **Edit number**. Use the dialing keys to enter the number (up to 32 digits).
 - Press **DELETE** to delete a digit.
 - Press and hold **DELETE** to delete all digits.
 - Press ◀/REPEAT or ▶/SKIP to move the cursor to the left or right.
 - Press ▲ or ▼ to move the cursor to the beginning or end.
5. Press **MENU/SELECT** to save. The console displays **Enter Name**. Use the dialing keys to enter the name (up to 24 characters).
 - Press **DELETE** to delete a character.
 - Press and hold **DELETE** to delete all characters.
 - Press ◀/REPEAT or ▶/SKIP to move the cursor to the left or right.
 - Press ▲ or ▼ to move the cursor to the beginning or end.
 - Press **0** to add a space.

Operation

Redial

Copy a redial entry to directory (continued)

6. Press **MENU/SELECT** to save. To exit without making changes, press **CANCEL** to return to the previous menu.

Delete a number

While the screen displays the desired number, press **DELETE** to delete the number from the redial memory.

Auto-redial

Use this feature to automatically redial a number twice, with a 30-second countdown in between the two dials.

1. Press **AUTO REDIAL** to enter the redial list and display the most recently called number.
2. Press **▲** or **▼** to view other recently called numbers.
3. While the screen displays the desired number, press **◀/REPEAT** or **▶/SKIP** to choose **Auto redial**, then press **MENU/SELECT**.
4. The telephone calls the desired number using the speakerphone.
5. When the other party answers, you will need to take an action to speak with the other party and stop the auto-redial attempts. Press **MUTE** on the console, then lift the handset to speak with the other party.
 - After a call is placed, if the line is busy, you will hear a busy tone for a few seconds before the console hangs up. The console returns to idle screen and displays **Auto redial -XXs**. The call will be redialed 30 seconds later. If the line is still busy at the second attempt, no more attempts are made.
 - If the line is ringing but no party answers, the console hangs up, returns to idle screen and displays **Auto redial -XXs**. The call will be redialed 30 seconds later. If there is no answer at the second attempt, no more attempts are made.
 - If you want to turn off the auto-redial feature during the 30-second waiting time, press **CANCEL**.

Operation

Conference call

The system can support 6-party conference with a maximum of four outside calls and two system extensions (including the initiating party).

Establish a conference call

There are two ways to establish a conference call.

A. Hold an intercom call

After establishing an intercom call with another system extension, the initiating party holds the intercom call and invites an external party to join the conference by making an outside call. Only one pair of intercom call can be held.

1. Press **INTERCOM**. Press ▲ or ▼ to scroll to the desired extension, then **MENU/SELECT** or ►/SKIP. The called extension picks up the intercom call.
-OR-
Press the speed dial key assigned with the desired extension number. The called extension picks up the intercom call.
2. Press an available line key to make an outside call. The original intercom call is put on hold. When the external party picks up, you can have a private conversation with that party.
3. Press **CONFERENCE** at any time to begin the conference call.
4. If necessary, repeat step 2 and step 3 above to invite another external party to join the conference until the maximum capacity is reached.

B. Hold an outside call or join a call in progress

After establishing the first outside call, the party can invite another system extension to join the conference by using intercom. Any system extension can also join a call in progress by pressing the line key which is currently in use to set up a conference.

1. Make or answer an outside call on the console.
2. Press another available line key to make another outside call. The original call is put on hold. When the external party picks up, you can have a private conversation with that party.

-OR-

Press **INTERCOM**. Press ▲ or ▼ to scroll to the desired extension, then **MENU/SELECT** or ►/SKIP. The called extension picks up the intercom call.

-OR-

Any system extension can press the line key currently in use to create a conference with the console and the external party.

- If the call privacy of your console is set to **On**, follow the instructions of **To turn call privacy off during a call** on page 40 to turn off the setting temporarily.

Operation

Conference call

Establish a conference call (Continued)

3. Press **CONFERENCE** at any time to begin the conference call.
4. If necessary, repeat step 2 (make another outside call) and step 3 above to invite another external party to join the conference until the maximum capacity is reached.



NOTES:

- After a conference call is established, other extensions are not allowed to actively barge-in the conference in progress.
- The flash signal in a dialing sequence is not available during a conference call.
- The system does not support an internal conference of more than two system extensions.

Options during a conference call

To talk privately with one external party:

1. Press **LINE 1-LINE 4** to talk privately with the person on that line. The intercom call is automatically placed on hold.
2. Press **CONFERENCE** to resume the conference call.

To talk privately with one internal party:

1. Press **INTERCOM** to talk privately with the person on that extension. The external line(s) is/are automatically placed on hold.
2. Press **CONFERENCE** to resume the conference call.

To drop an outside line:

1. Press **MENU/SELECT** twice to choose **End line**.
2. Press **▲** or **▼** to choose **End Line X** (**X** represents the line number that you want to drop. Press **MENU/SELECT** or **►/SKIP** to confirm).

To drop an intercom call:

1. Press **INTERCOM** to activate the intercom call that you want to drop. The external line(s) is/are automatically placed on hold. Place the corded handset on the console or press **SPEAKER** .
2. If there is only one external line on hold, press **LINE 1-LINE 4** to resume the external call and lift the corded handset on the console. If there are multiple external lines on hold, press **CONFERENCE** to resume the conference call.

To end a conference call:

- Place the corded handset on the console or press **SPEAKER** . The call does not terminate until all parties hang up.

Operation

Intercom

You can use the intercom feature for conversations between the console and an accessory device, or between two accessory devices. When the system is on one or more external calls, accessory devices can make intercom calls with each other. If you have a cordless headset or speakerphone, it can only receive intercom calls.



Each device that is registered to the console is assigned an extension. Cordless desksets and handsets are assigned numbers in the order they are registered (**1 to 9**), whereas cordless headsets and speakerphones are assigned numbers starting from 9 in descending order (**9 to 1**). See pages 10-12 for information on adding and registering devices to your console.

Make an intercom call to an extension

1. Press **INTERCOM** on the console when it is idle.
2. Press **▲** or **▼** to scroll to a desired extension, then press **MENU/SELECT** or **►/SKIP**.
3. The screen displays **Calling: XX** (**XX** represents the name and extension number of the destination device).

-OR-

If you have assigned extension numbers as speed dial entries (see **Assign a speed dial entry** on pages 53-54), you can initiate an intercom by pressing the desired speed dial key.

1. When the console is idle, press the desired speed dial key, or press **LOWER** followed by the desired speed dial key.
2. The console displays **Calling: XX** (**XX** represents the name and extension number of the destination device).



NOTES:

- If there is only one registered extension, pressing **INTERCOM** immediately calls the extension.
- Before the intercom call is answered, you can cancel the intercom by pressing **SPEAKER**  or lifting and resetting the corded handset on the console.
- Press **MUTE** to temporarily silence the intercom ringer.
- If a line is in use, pressing **INTERCOM** places the line on hold and activates the intercom call.
- You cannot intercom an extension that is currently on an intercom call.

Answer an intercom call

When you receive an intercom call, you hear a ringing tone and your screen displays **---Intercom--- XX** (**XX** represents the name and extension number of the calling device). Press **INTERCOM**, **SPEAKER**  or lift the corded handset to answer.

End an intercom call

Place the corded handset back to the console or press **SPEAKER**  if you are using the speakerphone.

Operation

Intercom

Answer an incoming call during an intercom call

If you receive an incoming outside call during an intercom call, there is an alert tone.

To answer the call, press the corresponding line key (**LINE 1-LINE 4**). The intercom call is hold automatically.

Hold an intercom call

During an intercom call, press **HOLD**.

After the call has been put on hold for more than three minutes, a double beep sounds every 30 seconds. (To adjust the volume or turn off the reminder beep, see **Hold reminder** on page 34).

The far-end party of the held intercom call will hear the music on hold (M.O.H) you set in the console. To change the setting and for more details, see **Music on hold** on pages 17-19.



NOTES:

- You can only hold one pair of intercom call.
- The intercom call on hold is dropped after 15 minutes.

Handle an intercom call by the general mailbox

The console's general mailbox handles unanswered intercom calls as to how it handles calls forwarded from the auto attendant.

When the console receives an intercom call and there is no answer after the programmed number of rings (see **Number of rings (general mailbox)** on page 75), the caller is prompted to leave a message in the general mailbox.

Operation

Call transfer

You can transfer a call to any other system telephone. Only the recipient extension can answer the transferred call.

Blind transfer

While on a call, you can transfer a call directly without notifying the desired extension:

1. Press **TRANSFER** on the console while on a call.
2. Press ▲ or ▼ to scroll to the desired extension, then press **MENU/SELECT** or ►/SKIP. The outside call is automatically transferred to the desired extension.
3. The destination device rings. You can resume the call by pressing the corresponding flashing line key (**LINE 1-LINE 4**) on the console before the destination device answers the call.



NOTES:

- If the mailbox of the destination extension is off, the transferred call will only ring five times on the destination extension. If the destination extension does not answer within that period, the transferred call rings back the initiating device. If the initiating device does not answer the call. The call ends after it has been in the transfer process for 10 minutes.
- The selection of line mode does not affect this process.

Operation

Call transfer using intercom

Transfer a call and speak to the receiving party

You can transfer a call and speak to the receiving party before completing the transfer while on a call:

1. Press **INTERCOM** on the console while on a call.
2. Press ▲ or ▼ to scroll to a desired extension, then press **MENU/SELECT** or ►/SKIP. The outside call is put on hold.
3. The destination extension rings and the call is answered. You can now announce the call. This is an intercom call between the console and the extension.
4. Press **TRANSFER** to transfer the call to the destination extension. The console returns to idle.



NOTE: If you decide not to transfer the call and end the intercom call, press the corresponding flashing line key (**LINE 1-LINE 4**) to resume the outside call.

Operation

Paging

You can directly broadcast messages to the speakerphone of any extension deskset and handset. The extension(s) you called can respond by pressing the **PAGE** key to begin a two-way communication.

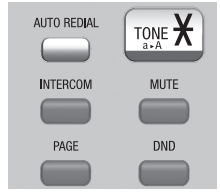

Make a paging call to an extension

1. Press **PAGE** on the console when it is idle.
2. Press ▲ or ▼ to scroll to a desired extension, then press **MENU/SELECT**.
3. The screen displays **Paging....** When the connection is made, both the caller and the destination party hear a beep. Both devices display **Press and hold [PAGE] to talk**.
4. Press and hold the **PAGE** key. A chirp indicates your microphone is on. Speak towards the console while continuing to hold down the **PAGE** key. Your voice is broadcast to the desired extension. While you are speaking, the console displays **Paging... Ext X (X represents the extension number of the destination party)**.
5. Release the **PAGE** key after speaking. Both devices beep again and the screens display **Press and hold [PAGE] to talk**, then you can press and hold PAGE to continue speaking or the destination party can respond.



NOTES:

- Before the paging call is answered, you can cancel the paging by pressing **CANCEL**.
- You cannot page an extension that is on a call.
- If all four telephone lines are in use, the paging feature is not available.

Make a paging call to multiple extensions

1. Press **PAGE** on the console when it is idle.
2. Press ▲ or ▼ to scroll to **Group** or **All**, then press **MENU/SELECT** or ►/**SKIP**.
 - If you choose **Group**, press ▲ or ▼ to scroll to a desired group of extensions. Then, press **MENU/SELECT** or ►/**SKIP**.
3. When the connection is made, the caller and the destination parties hear a beep and their screens display **Press and hold [PAGE] to talk**.
4. Press and hold the **PAGE** key when you want to speak. Your voice is broadcast to the desired extensions.
5. Release the **PAGE** key after speaking. Any destination extension can reply.



NOTES:

- Paging all extensions will create a paging call that only involves the console and the first five system devices.
- If any of the first five system devices is busy, it will not receive the paging call.

Operation

Paging

Set and edit a group for paging calls

Use the group setting if you want to broadcast your voice to a group of extensions. When you page a group, only the selected extensions hear your voice. You can create up to three paging groups.

1. Press **PAGE** on the console when it is idle.
2. Press **▲** or **▼** to scroll to **Group**, then press **MENU/SELECT** or **▶/SKIP**.
3. Press **▲** or **▼** to scroll to **Define groups**, then press **MENU/SELECT** or **▶/SKIP**.
4. Press **▲** or **▼** to select a desired group (**Group 1-Group 3**), then press **MENU/SELECT** or **▶/SKIP**.
5. The registered extensions (apart from cordless headset and speakerphone) display. Use the dial pad to press an extension number if you want to add it to the group.
 - To remove an extension number, press the same number again.
6. Press **MENU/SELECT** to save the setting and return to the previous menu. To exit without making changes, press **CANCEL**.

-OR-

1. Follow steps 1-2 above.
2. Press **▲** or **▼** to select a desired empty group, then press **MENU/SELECT** or **▶/SKIP**.
3. Press **MENU/SELECT** to set the group.
4. The registered extensions (apart from cordless headset and speakerphone) display. Use the dial pad to press an extension number if you want to add it to the group.
 - To remove an extension number, press the same number again.
6. Press **MENU/SELECT** to save the setting and return to the previous menu. To exit without making changes, press **CANCEL**.



NOTE: Each group can contain a maximum of four other system extensions (excluding the initiating extension).

Delete the group settings

1. Press **PAGE** on the console when it is idle.
2. Press **▲** or **▼** to scroll to **Group**, then press **MENU/SELECT** or **▶/SKIP**.
3. Press **▲** or **▼** to scroll to **Clear groups**, then press **MENU/SELECT** or **▶/SKIP**.
4. The console displays **Clear all group settings?**. Press **▲** or **▼** to select **Yes**, then press **MENU/SELECT**. To exit without making changes, press **CANCEL** or **◀/REPEAT**.

End a paging call

Press **CANCEL** to end the paging call.

Operation

Speed dial

This console has 32 speed dial locations where you can store and dial phone numbers or system extension numbers. You can store up to 32 digits in each location.

You can access the first 16 locations using only the speed dial keys. To access the remaining 16 locations, press **LOWER** and then the speed dial key for the desired location. You might wish to write the names, telephone numbers, or extension numbers of the speed dial entries on the directory card, using the light gray spaces for the upper 16 locations and the white spaces for the lower 16 locations.



NOTE: By default, pressing speed dial keys 1 to 10 will make an intercom call to the corresponding registered extension, as shown on the directory card.

Assign a speed dial entry

You can assign speed dial entries to dial a number in directory or call an extension. If you add a new phone number, it will also be saved to directory.

To copy an entry from directory or select an extension:

1. When the console is idle, press **MENU/SELECT**.
2. Press **▲** or **▼** to scroll to **Speed dial**, then press **MENU/SELECT** or **▶/SKIP**.
3. The screen displays **Speed dial: Press a speed dial key to edit**.
4. Press the desired speed dial key, or press **LOWER** followed by the desired speed dial key, then press **MENU/SELECT**.
5. Press **▲** or **▼** to choose **Add from DIR** or **Call extension**, then press **MENU/SELECT** or **▶/SKIP**.
6. Press **▲** or **▼** to choose a desired entry.
7. Press **MENU/SELECT** or **▶/SKIP** to save the setting and return to the previous menu. To exit without making changes, press **CANCEL** or **◀/REPEAT**.

Operation

Speed dial

Assign a speed dial entry (continued)

To add a new phone number:

1. When the console is idle, press **MENU/SELECT**.
2. Press **▲** or **▼** to scroll to **Speed dial**, then press **MENU/SELECT** or **►/SKIP**.
3. The screen displays **Speed dial: Press a speed dial key to edit**.
4. Press the desired speed dial key, or press **LOWER** followed by the desired speed dial key, then press **MENU/SELECT**.
5. Press **MENU/SELECT** again to choose **New number**.
6. Use the dialing keys to enter a telephone number (up to 32 digits).
 - Press **DELETE** to delete a digit.
 - Press and hold **DELETE** to delete all digits.
 - Press **◀/REPEAT** or **►/SKIP** to move the cursor to the left or right.
 - Press **▲** or **▼** to move the cursor to the beginning or end.
7. Press **MENU/SELECT** to move on to the name.
 - The display shows **Number already saved** if the number is already in the directory. Go to the previous step and choose **Add from DIR** to assign the speed dial entry.
8. When the screen displays **Enter name**, use the dialing keys to enter the name (up to 24 characters).
 - Press **DELETE** to delete a character.
 - Press and hold **DELETE** to delete all characters.
 - Press **◀/REPEAT** or **►/SKIP** to move the cursor to the left or right.
 - Press **▲** or **▼** to move the cursor to the beginning or end.
 - Press **0** to add a space.
9. Press **MENU/SELECT** to save and return to the previous menu. To exit without making changes, press **CANCEL** or **◀/REPEAT**.



NOTES:

- The newly added phone number will also be saved to the directory.
- If you want to edit the phone number of the speed dial entry, you need to edit it in directory.

Operation

Speed dial

Dial a speed dial entry

When the console is idle, press the desired speed dial key for the destination party in the upper location.

-OR-

When the console is idle, press **LOWER** followed by the speed dial key for the destination party in the lower location.

The console dials the speed dial number using the speakerphone.

Delete a speed dial entry

1. When the console is idle, press **MENU/SELECT**.
2. Press **▲** or **▼** to scroll to **Speed dial**, then press **MENU/SELECT** or **▶/SKIP**.
3. Press the desired speed dial key, or press **LOWER** followed by the desired speed dial key.
4. Press **DELETE** to remove the speed dial entry. To exit without making changes, press **CANCEL** or **◀/REPEAT**.



NOTES:

- Deleting a speed dial entry will not delete the corresponding entry in the directory.
- If you delete the speed dial entry for keys 1 to 10, it will reset to the default setting and serve as an intercom key to the corresponding registered extension.

Operation

COVM

COVM (central office voicemail)

If you subscribe to voicemail service with your telephone service provider, turn on the **COVM** feature. When the console receives new voicemail messages on a particular line, the screen displays **COVM Line X** in idle mode (**X** represents the line number).

If you do not subscribe to voicemail service or want to disable the indicator, turn off the **COVM** feature.

1. When the console is idle, press **MENU/SELECT**.
2. Press **▲** or **▼** to scroll to **COVM**. Press **MENU/SELECT** or **▶/SKIP**.
3. Press **MENU/SELECT** or **▶/SKIP** again to select **COVM On/Off**.
4. Press **▲** or **▼** to select **On** or **Off**.
5. Press **MENU/SELECT** or **▶/SKIP** to save the setting and return to the previous menu. To exit without making changes, press **CANCEL** or **◀/REPEAT**.

COVM reset

Use this feature when the console indicates there is new voicemail but there is none. For example, when you have accessed your voicemail while away from the building. This feature only turns off the **COVM** indicator; it does not delete your voicemail messages. As long as you have new voicemail messages, your telephone service provider continues to send the signal to turn on the indicator. You can reset **COVM** indicators individually or for all the telephone lines using the **All COVM reset** command.

1. When the console is idle, press **MENU/SELECT**.
2. Press **▲** or **▼** to scroll to **COVM**. Press **MENU/SELECT** or **▶/SKIP**.
3. Press **▲** or **▼** to scroll to **COVM reset**. Press **MENU/SELECT** or **▶/SKIP**.
4. Press **▲** or **▼** to scroll to **COVM 1 reset-COVM 4 reset** to clear the **COVM** indicator of a telephone line, or scroll to **All COVM reset** to clear the indicators for all the lines.
5. Press **MENU/SELECT** or **▶/SKIP** to execute the command and return to the previous menu. To exit without making changes, press **CANCEL** or **◀/REPEAT**.



NOTE: For information about using your voicemail service, contact your telephone service provider for assistance.

Directory

About the directory

Use the directory to store names and phone numbers. Directory entries are not shared with other extensions. The console and each deskset have their own directories.

Capacity

The directory of this console can store up to 100 entries, with a maximum of 24 alphanumeric characters (including spaces) for names and 32 digits for telephone numbers. A convenient search feature can help you quickly find and dial numbers (page 60).

If there are already 100 entries, the screen shows **Directory full** when you try to create a new directory entry. You cannot store a new number until you delete one. If you try to view the directory when there are no entries, the screen displays **Directory empty**.

Exit the directory

On the console, press **CANCEL** to cancel an operation and return to previous screen.

Directory

Create directory entries

Create a new directory entry

Use the following steps to store a name and number in the directory.

- When the console is idle, enter the telephone number (up to 32 digits).
- Press **MENU/SELECT**. Use the dialing keys to edit the number, if necessary.
 - Press **DELETE** to delete a digit.
 - Press and hold **DELETE** to delete all digits.
 - Press **◀/REPEAT** or **▶/SKIP** to move the cursor to the left or right.
 - Press **▲** or **▼** to move the cursor to the beginning or end.
- Press **MENU/SELECT** to save. The screen displays **Enter name**. Use the dialing keys to enter the name (up to 24 characters). Each time you press a key, the character on that key appears. When entering a name in the directory, the first letter of each word is automatically capitalized. Additional key presses produce other characters on that key. See the chart below.
 - Press **DELETE** to delete a character.
 - Press and hold **DELETE** to delete all characters.
 - Press **◀/REPEAT** or **▶/SKIP** to move the cursor to the left or right.
 - Press **▲** or **▼** to move the cursor to the beginning or end.
 - Press **0** to add a space.

Dialing keys	Characters by number of key presses										
	1	2	3	4	5	6	7	8	9	10	11
1	1	.	-	'	()	*	#	&	/	,
2	a	b	c	A	B	C	2				
3	d	e	f	D	E	F	3				
4	g	h	i	G	H	I	4				
5	j	k	l	J	K	L	5				
6	m	n	o	M	N	O	6				
7	p	q	r	s	P	Q	R	S	7		
8	t	u	v	T	U	V	8				
9	w	x	y	z	W	X	Y	Z	9		
0	Space	0									
*											
#											

- Press **MENU/SELECT** to save.

Directory

Create directory entries

Create a new directory entry (continued)

-OR-

1. When the console is idle, press **MENU/SELECT**.
2. Press **MENU/SELECT** or **▶/SKIP** to choose **Directory**.
3. Press **▲** or **▼** to scroll to **Add contact**, then press **MENU/SELECT** or **▶/SKIP**.
 - If the directory is empty, press **MENU/SELECT**.
4. The screen displays **Enter number**. Use the dialing keys to enter the number (up to 32 digits).
5. Press **MENU/SELECT** to save. The screen displays **Enter name**. Use the dialing keys to enter the name (up to 24 characters).
6. Press **MENU/SELECT** to save. To exit without making changes, press **CANCEL** to return to the previous menu.

Review directory entries

1. When the console is idle, press **DIRECTORY**. The screen displays the first entry in the directory.
2. Press **▲** or **▼** to browse through the directory. Entries appear alphabetically by the first letter in the name.
3. Press **CANCEL** to return to idle mode.

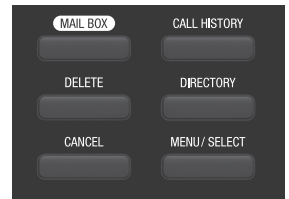

-OR-

1. When the console is idle, press **MENU/SELECT**.
2. Press **MENU/SELECT** or **▶/SKIP** to choose **Directory**.
3. Press **MENU/SELECT** or **▶/SKIP** to choose **Review**. The screen displays the first entry in the directory.
4. Press **▲** or **▼** to browse through the directory. Entries appear alphabetically by the first letter in the name.
5. Press and hold **CANCEL** to return to idle mode.

Directory

Search directory

Search by name

The names appear in alphabetical order. Follow the steps below to search for directory entries on the console.

1. Press **DIRECTORY** on the console. The screen displays the first entry in the directory.
2. Press **▲** or **▼** to browse through the directory.
3. Use the dial pad keys (**2-9**) to enter a letter to start a name search.
 - If there is an entry matching the letter you press, the directory shows the first name beginning with that letter.
 - If there is no entry matching the letter you press, the directory shows the next closest entry or the last entry.

For example, if you have the names **Jennifer**, **Jessie**, **Kevin** and **Linda** in your directory:

- If you press **5 (JKL)** once, you see **Jennifer**.
- If you press **5 (JKL)** twice, you see **Kevin**.
- If you press **5 (JKL)** three times, you see **Linda**.
- To view **Jessie**, press **▼** while **Jennifer** is displayed.

Directory

Dial, delete or edit entries

You can dial, delete or edit a directory entry (name and number) when it is shown on the console screen. You can use the directory review (page 59) or name search (page 60) to show an entry.

Display dial

When a number is displayed on the screen, you can dial the number by lifting the corded handset, or pressing **◀** **SPEAKER** or the desired line key (**LINE 1-LINE 4**).

Delete an entry

When a directory entry appears, press **DELETE**, then press **MENU/SELECT** to confirm.

Edit an entry

1. When a directory entry appears, press **MENU/SELECT**.
2. The screen displays **Edit number**. Use the dialing keys to enter the number (up to 32 digits). If you only want to edit the name, skip to step 3.
 - Press **DELETE** to delete a digit.
 - Press and hold **DELETE** to delete all digits.
 - Press **◀/REPEAT** or **▶/SKIP** to move the cursor to the left or right.
 - Press **▲** or **▼** to move the cursor to the beginning or end.
3. Press **MENU/SELECT** to save. The screen displays **Edit name**. Use the dialing keys to edit the name (up to 24 characters).
 - Press **DELETE** to delete a character.
 - Press and hold **DELETE** to delete all characters.
 - Press **◀/REPEAT** or **▶/SKIP** to move the cursor to the left or right.
 - Press **▲** or **▼** to move the cursor to the beginning or end.
 - Press **0** to add a space.
4. Press **MENU/SELECT** to save. To exit without making changes, press **CANCEL**.

Call history

About the caller ID

This console supports caller ID services that most telephone service providers offer. Caller ID allows you to see the name, number, date and time of calls. Depending on your service subscription, you might see the caller's number, or the caller's name and number from the telephone service provider after the first or second ring. Caller ID information might not be available for every incoming call. Callers may intentionally block their names and/or telephone numbers.

This product can provide information only if both you and the caller are in areas offering caller ID service and if both telephone service providers use compatible equipment.

Information about caller ID with call waiting

Caller ID with call waiting lets you see the name and telephone number of the caller before answering the telephone, and while on another call.

It might be necessary to change telephone service to use this feature. Contact your telephone service provider if:

- You have both caller ID and call waiting, but as separate services (you might need to combine these services).
- You only have caller ID service, or only call waiting service.
- You do not subscribe to caller ID or call waiting services.



There are fees for caller ID services. In addition, services may not be available in all areas.

This product can provide information only if both you and the caller are in areas offering caller ID service and if both telephone service providers use compatible equipment. The time and date, along with the call information, are from the telephone service provider.



NOTES:

- You can use this product with regular caller ID service, or you can use this product's other features without subscribing to caller ID or combined caller ID with call waiting service.
- The format of telephone numbers displayed depends on the home area code you set (See **Area codes** on page 33 for explanations and instructions on area code settings).

Call history

Caller ID information

How the caller ID information works

The console stores caller ID information for the last 50 incoming calls in the console. Entries are stored in reverse chronological order. The console deletes the oldest entry when the log is full to make room for new calls.

Each extension has independent caller ID information. Deleting the caller ID information on any one extension does not affect the caller ID information on other extensions.

If you answer a call before the information appears on the screen, it does not show in the caller ID information.

Review the caller ID information to determine who called, to easily return the call, or to copy the caller's name and number into your directory or speed dial memory.

The time and date of the call and the caller's name and telephone number are included in the display.

Caller ID information appears on the screen as the telephone rings, the caller hangs up, the call has been answered at another extension, or until the call ends.

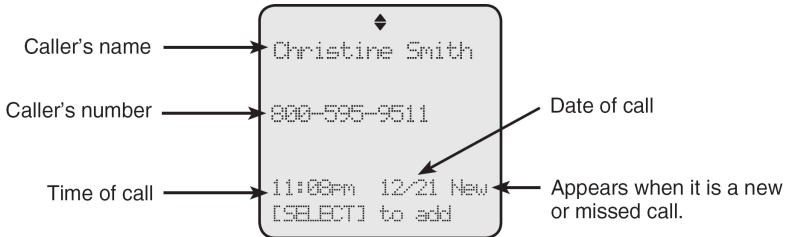

If you subscribe to caller ID service, this phone automatically resets the time and date using the caller ID information from the first incoming call after initial setup, or each time the power resumes after a power outage.

NOTES:

- The caller ID information might not be available for every incoming call. Callers might intentionally block their names and/or telephone numbers.
- Each entry can store up to 24 digits for the telephone number and 16 characters for the name.

Call history

Caller ID operation

Memory match

If the incoming telephone number is an exact match with a telephone number in your directory, the name that appears on the screen matches the corresponding name in your directory.

For example, if Christine Smith calls, her name appears as Chris if this is how you entered it into your directory.



NOTE: The number you see on your caller ID is in the format from the telephone service provider. It usually delivers 10-digit telephone numbers (area code plus telephone number). The telephone system ignores the area code when searching for a match and displays the name of the first corresponding number from the directory.

Missed (new) calls indicator

When there are new or missed calls and you try to review the caller ID log by pressing **CALL HISTORY**, the screen shows **XX Missed call(s)**.

All new or missed entries are counted as new calls. Each time you review a call history entry with the icon **New**, the missed calls message goes away.

Review the caller ID information

1. When the console is idle, press **CALL HISTORY**.
The console displays **XX Missed calls**.
2. Press **▲** or **▼** to review the caller ID information.
The caller ID entries are stored in reverse chronological order starting with the most recent entry.
3. To exit without making changes, press **CANCEL** or **◀/REPEAT**.

-OR-

1. When the console is idle, press **MENU/SELECT**.
2. Press **▲** or **▼** to scroll to **Call history**, then press **MENU/SELECT** or **▶/SKIP**.
The screen displays the **XX Missed calls**.
3. Press **▲** or **▼** to review the caller ID information. The caller ID entries are stored in reverse chronological order starting with the most recent entry.
4. Press **CANCEL** twice to return to idle mode.



Caller history

Caller ID operation

View dialing options

Although the incoming call history entries have 10 digits (the area code plus the seven-digit number), in some areas, you may need to dial the seven digits only, 1 plus the seven digits, or 1 plus the area code plus the seven digits. You can change and store the number of digits that you dial in the call history.

While reviewing the call history, press # (pound key) repeatedly on the console to show different dialing options for local and long distance numbers before dialing or saving the telephone number in the directory.

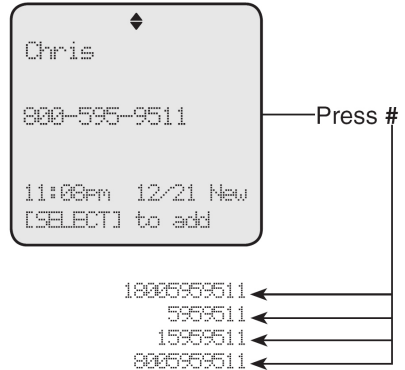

Dial a call history entry

1. When in the caller ID history, press ▲ or ▼ to browse the number you wish to call.
2. Lift the handset or press **SPEAKER** .

-OR-

To override automatic line selection, press the desired line key (**LINE 1-LINE 4**), then lift the handset to call.

Call history

Caller ID operation

Save a caller history entry to the directory

1. When in the caller ID history, press ▲ or ▼ to browse the number you wish to save.
2. Press **MENU/SELECT**. The screen displays **Edit number**. Use the dialing keys to enter the number (up to 32 digits).
 - Press **DELETE** to delete a digit.
 - Press and hold **DELETE** to delete all digits.
 - Press **◀/REPEAT** or **▶/SKIP** to move the cursor to the left or right.
 - Press ▲ or ▼ to move the cursor to the beginning or end.
3. Press **MENU/SELECT** to save. The screen displays **Edit name**. Use the dialing keys to edit the name (up to 24 characters).
 - Press **DELETE** to delete a character.
 - Press and hold **DELETE** to delete all characters.
 - Press **◀/REPEAT** or **▶/SKIP** to move the cursor to the left or right.
 - Press ▲ or ▼ to move the cursor to the beginning or end.
 - Press **0** to add a space.
4. Press **MENU/SELECT** to save. To exit without making changes, press **CANCEL**.



NOTE: You will need to change how a caller ID number is dialed if the entry does not appear in the correct format. Caller ID numbers might appear with an area code that is not necessary for local calls, or without a 1 that is necessary for long distance calls (see **View dialing options** on the previous page for more information).

Delete entries

To delete a call history entry:

1. When in the caller ID history, press ▲ or ▼ to scroll to the number you wish to delete.
2. Press **DELETE** to delete the shown entry from the caller ID history.
3. The screen displays **Deleted**.

To delete all caller ID history entries:

1. When the console is idle, press **CALL HISTORY**.
2. Press **DELETE**, then press ▲ or ▼ to scroll to **Yes**.
3. Press **MENU/SELECT** or **▶/SKIP** to confirm. The screen displays **All calls deleted**.

Call history

Reasons for missing caller ID information

Reasons for missing caller ID information

There are also occasions when other information or no information shows for various reasons:

On-screen message	Reason
PRIVATE NUMBER	The number has been set as private.
PRIVATE NAME	The name has been set as private.
PRIVATE CALLER	Both the name and number have been set as private.
UNKNOWN NUMBER	The number has been set as out of area.
UNKNOWN NAME	The name has been set as out of area.
UNKNOWN CALLER	Both the name and number have been set as out of area.

Answering system

About the answering system

Your console has separate indicators for two different types of voice messages: those left on its built-in answering system and those left at your service provider's voicemail (fees may apply). Your console's built-in answering system messages and voicemail messages are separate. Each alerts you to new messages differently.

- If you turn on the **COVM** feature (See **COVM** on page 56 for more information) and the **COVM** message displays on the console screen, your telephone service provider is indicating that it has new voicemail for you. To listen to your voicemail, dial an access number provided by your telephone service provider, followed by a security code or PIN.
- To listen to messages recorded on your digital answering system, press **MAIL BOX** on the console (page 86).

Some service providers bundle or combine multiple services like voicemail and call waiting, so you may not be aware that you have voicemail. To check what services you have and how to access them, contact your telephone service provider.

To use your voicemail service rather than the answering system, turn off the answering system for that telephone line (see **Line mode** on page 14 for more information). To use the answering system rather than the voicemail service, contact your telephone service provider to deactivate the voicemail service. Use your telephone answering system and voicemail together by setting your built-in answering system to answer before voicemail, as described below. To learn how to program your voicemail settings, contact your telephone service provider. Then, if you are on a call, or if the answering system is busy recording a message and you receive another call, the second caller can leave a voicemail message.

Set your answering system to answer calls at least two rings earlier than your voicemail is set to answer. For example, if your voicemail answers after six rings, set your answering system to answer after four rings. Some voicemail providers may program the delay before answering calls in seconds instead of rings. In this case, allow six seconds per ring when determining the appropriate setting.

Answering system

About the answering system

Answering system capacity

Apart from the default announcements, you can record up to five new announcements for use in the answering system. Each announcement can be up to 90 seconds.

The announcements of auto attendant, announce only answer mode, and general mailbox all require system memory to record, so we suggest recording brief announcements in order to leave more space for messages.

The maximum recording time of all extensions is 180 minutes and the maximum number of messages for is 150 for general mailbox and 99 for each of the extension mailbox. The actual recording time depends on individual message characteristics. Individual messages can be up to three minutes. Messages remain available for review until you delete them.

If the system memory is full, the screen displays **Memory full**, and you cannot record new messages until old ones have been deleted. Check remaining system space frequently to maintain availability of space for incoming messages.



NOTE: You cannot record an announcement when the telephone system is out of space. You will hear a two-beep alert tone. Please refer to **Remaining time** on 88.

Answering system

Auto attendant setup

You can set up the auto attendant to answer outside calls, provide callers with a company directory, direct calls to a specified extension, and enable callers to record voice messages by forwarding the calls to the console's general mailbox. You can use the default announcement or record up to two outgoing announcements and one directory announcement. For details on how to use the auto attendant features, see the **Auto attendant operation** on page 84 of this user's manual.

Activate auto attendant

The console displays **AuAt** above the line key(s) when the auto attendant is turned on for the particular line(s).

1. When the console is idle, press **MENU/SELECT**.
2. Press ▲ or ▼ to scroll to **Line mode**, then press **MENU/SELECT** or ►/SKIP.
3. Press ▲ or ▼ to select the desired line (**Line 1**, **Line 2**, **Line 3** or **Line 4**) or **All lines**, then press **MENU/SELECT** or ►/SKIP.
4. Press ▲ or ▼ to scroll to **Auto attendant**, then press **MENU/SELECT** or ►/SKIP.



NOTE: The auto attendant settings, including number of rings and announcement, apply to all lines where the corresponding line mode is activated.

Number of rings (auto attendant)

Use this feature to set the number of times the system rings before the auto attendant picks up a call.

1. When the console is idle, press **MENU/SELECT**.
2. Press ▲ or ▼ to scroll to **Ans sys setup**, then press **MENU/SELECT** or ►/SKIP.
3. Press ▲ or ▼ to scroll to **Auto att setup**, then press **MENU/SELECT** or ►/SKIP.
4. Press **MENU/SELECT** or ►/SKIP again to select **No. of rings**.
5. Press ▲ or ▼ to choose the desired number of rings (**2-7** or **Toll saver**).
 - **Toll saver** - the answering system answers a call after two rings when there are new messages, and after four rings when there are no new messages. This enables you to check for new messages without paying for a toll call.
6. Press **MENU/SELECT** or ►/SKIP to save the setting and return to the previous menu.

Answering system

Auto attendant setup

Announcement (auto attendant)

Use this feature to record up to three new announcements so that you can have different announcements for daytime and after hours, and an announcement for the company directory. You can easily switch among the recorded announcements. Each announcement can be up to 90 seconds.

You can record an announcement for daytime recording (**Daytime annnc**) and an announcement for after hours recording (**Night time annnc**). You can also record a directory announcement, which provides an extension list of your company to the caller.

Daytime announcement - The default announcement is *“Hello. Thank you for calling our company. If you know any party’s extension, you may dial it followed by # (pound key). To leave a message at the general mailbox, press * (star key) twice.”*

Night time announcement - The default announcement is *“Hello. Thank you for calling our company. We are currently closed. If you know any party’s extension, you may dial it followed by # (pound key). To leave a message at the general mailbox, press * (star key) twice.”*

Directory announcement - If you have many extensions, record a separate extension list in the **Record directory** menu item and reference it in your auto attendant announcement as shown in **Sample announcement 1** below. If you have only a few extensions, you can list them in the auto attendant announcement as shown in **Sample announcement 2** below without the separate extension list.

Sample announcement 1: *“Hello, you have reached XYZ Corp. Please enter your party’s extension. To hear a list of extensions, dial # (pound key) twice.”*

Sample announcement 2: *“Hello, you have reached XYZ Corp. For sales, press 2 pound; for service, press 3 pound; for shipping, press 4 pound; or press 0 pound for the receptionist.”*

If you have recorded a directory announcement, the caller hears *“For company directory, dial # (pound key) twice”* after the daytime or night time announcement.

Answering system

Auto attendant setup

To record the daytime or nighttime announcement:

1. When the console is idle, press **MENU/SELECT**.
2. Press **▲** or **▼** to scroll to **Ans sys setup**, then press **MENU/SELECT** or **▶/SKIP**.
3. Press **▲** or **▼** to scroll to **Auto att setup**, then press **MENU/SELECT** or **▶/SKIP**.
4. Press **▲** or **▼** to choose **Daytime annnc**, **Night time annnc**, then press **MENU/SELECT** or **▶/SKIP**.
5. The pointer (**>**) indicates whether the default or user-recorded announcement is used currently. Press **▲** or **▼** to scroll to **User annncment**, then press **MENU/SELECT** or **▶/SKIP**.
 - If you have recorded your own announcement before, press **▲** or **▼** to scroll to **Change**, then press **MENU/SELECT** or **▶/SKIP**.
6. Press **MENU/SELECT** to start recording. Lift the handset or face the console to record your announcement.
7. Press **MENU/SELECT** again to stop recording. You hear the playback of the recording.
8. Press **▲** or **▼** to choose **OK** to save the recording, or choose **Change** to record again if desired. Press **MENU/SELECT** or **▶/SKIP**.

To record a directory announcement:

1. Follow steps 1-3 above.
2. Press **▲** or **▼** to choose **Record directory**, then press **MENU/SELECT** or **▶/SKIP**.
 - If you have recorded your own announcement before, press **▲** or **▼** to scroll to **Change**, then press **MENU/SELECT** or **▶/SKIP**.
3. Press **MENU/SELECT** to start recording. Lift the handset or face the console to record your announcement.
4. Press **MENU/SELECT** again to stop recording. You hear the playback of the recording.
5. Press **▲** or **▼** to choose **OK** to save the recording, choose **Change** to record again if desired, or choose **Clear** to clear the recording. Press **MENU/SELECT** or **▶/SKIP**.

Answering system

Auto attendant setup

To set the start and end time of auto attendant announcement:

You can set the start and end time of the daytime announcement. The system plays the nighttime announcement in the rest of the time.

1. When the console is idle, press **MENU/SELECT**.
2. Press **▲** or **▼** to scroll to **Ans sys setup**, then press **MENU/SELECT** or **▶/SKIP**.
3. Press **▲** or **▼** to scroll to **Auto att setup**, then press **MENU/SELECT** or **▶/SKIP**.
4. Press **▲** or **▼** to choose **Set ann time**, then press **MENU/SELECT** or **▶/SKIP**.
5. Press **◀/REPEAT** or **▶/SKIP** to scroll between the hour (**HH**), minute (**MM**) and **AM/PM** of start time and end time.
6. Press **▲** or **▼** to increase or decrease the digits and toggle between **am** and **pm**. You can also press the dialing keys to enter the correct digits.
 - If you enter digits larger than 12 in the hour field, the system automatically converts to the 12-hour time format.
7. Press **MENU/SELECT** to save the setting.



NOTE: The start time and the end time of the daytime announcement cannot be the same. Otherwise, the setting cannot be saved.

Answering system

Auto attendant setup

To play the recorded auto attendant announcement:

1. When the console is idle, press **MENU/SELECT**.
2. Press **▲** or **▼** to scroll to **Ans sys setup**, then press **MENU/SELECT** or **▶/SKIP**.
3. Press **▲** or **▼** to scroll to **Auto att setup**, then press **MENU/SELECT** or **▶/SKIP**.
4. Press **▲** or **▼** to choose **Daytime annnc**, **Night time annnc** or **Record directory**, then press **MENU/SELECT** or **▶/SKIP**.
 - If you choose **Record directory**, the current announcement plays.
 - If you select **Daytime annnc** or **Night time annnc**, press **▲** or **▼** to scroll to **User annncment**, then press **MENU/SELECT** or **▶/SKIP** to play the announcement.

To play and select the default auto attendant announcement:

1. When the console is idle, press **MENU/SELECT**.
2. Press **▲** or **▼** to scroll to **Ans sys setup**, then press **MENU/SELECT** or **▶/SKIP**.
3. Press **▲** or **▼** to scroll to **Auto att setup**, then press **MENU/SELECT** or **▶/SKIP**.
4. Press **▲** or **▼** to choose **Daytime annnc** or **Night time annnc**, then press **MENU/SELECT** or **▶/SKIP**.
5. Press **MENU/SELECT** or **▶/SKIP** again to choose **Default**. The default announcement plays.
6. Press **MENU/SELECT** or **▶/SKIP** to save the setting.

To clear the recorded directory announcement:

1. When the console is idle, press **MENU/SELECT**.
2. Press **▲** or **▼** to scroll to **Ans sys setup**, then press **MENU/SELECT** or **▶/SKIP**.
3. Press **▲** or **▼** to scroll to **Auto att setup**, then press **MENU/SELECT** or **▶/SKIP**.
4. Press **▲** or **▼** to choose **Record directory**, then press **MENU/SELECT** or **▶/SKIP**.
5. The current directory announcement plays. Press **▲** or **▼** to choose **Clear**, then press **MENU/SELECT** or **▶/SKIP** to clear the recording.

Answering system

General mailbox setup

This console has a general mailbox that can answer calls and record messages when it is turned on. It also picks up unanswered intercom calls and calls forwarded from the auto attendant. Apart from being the general mailbox of the system, it also acts as the extension mailbox of the console.

The general mailbox answers the call after the number of rings you set in the **Number of rings (general mailbox)** section below.

When the general mailbox is full, callers hear *“Hello. This is the general mailbox. Mailbox is full. Please call again later. Goodbye.”*

Activate general mailbox

The console displays **MB** above the line key(s) when the general mailbox is turned on for the particular line(s).

1. When the console is idle, press **MENU/SELECT**.
2. Press **▲** or **▼** to scroll to **Line mode**, then press **MENU/SELECT** or **▶/SKIP**.
3. Press **▲** or **▼** to select the desired line (**Line 1**, **Line 2**, **Line 3** or **Line 4**) or **All lines**, then press **MENU/SELECT** or **▶/SKIP**.
4. Press **MENU/SELECT** or **▶/SKIP** again to select **Gen MB only**.



NOTE: The general mailbox settings, including number of rings and announcement, apply to all lines where the corresponding line mode is activated.

Number of rings (general mailbox)

Use this feature to set the number of times the system rings before the general mailbox picks up a call.

1. When the console is idle, press **MENU/SELECT**.
2. Press **▲** or **▼** to scroll to **Ans sys setup**, then press **MENU/SELECT** or **▶/SKIP**.
3. Press **MENU/SELECT** or **▶/SKIP** to select **Gen MB setup**.
4. Press **MENU/SELECT** or **▶/SKIP** again to select **No. of rings**.
5. Press **▲** or **▼** to choose the desired number of rings (**2-7** or **Toll saver**).
 - **Toll saver** - the answering system answers a call after two rings when there are new messages, and after four rings when there are no new messages. This enables you to check for new messages without paying for a toll call.
6. Press **MENU/SELECT** or **▶/SKIP** to save the setting and return to the previous menu.

Answering system

General mailbox setup

Announcement (general mailbox)

An announcement plays when calls are answered by the general mailbox. The system has a default announcement, *"Hello. This is the general mailbox. Please leave a message after the tone."* You can use this announcement or record your own.

You can record an announcement up to 90 seconds.

To record the general mailbox announcement:

1. When the console is idle, press **MENU/SELECT**.
2. Press **▲** or **▼** to scroll to **Ans sys setup**, then press **MENU/SELECT** or **▶/SKIP**.
3. Press **MENU/SELECT** or **▶/SKIP** to select **Gen MB setup**.
4. Press **▲** or **▼** to choose **Annment setup**, then press **MENU/SELECT** or **▶/SKIP**.
5. The pointer (>) indicates whether the default or user-recorded announcement is used currently. Press **▲** or **▼** to scroll to **User annment**, then press **MENU/SELECT** or **▶/SKIP**.
 - If you have recorded your own announcement before, press **▲** or **▼** to scroll to **Change**, then press **MENU/SELECT** or **▶/SKIP**.
6. Press **MENU/SELECT** to start recording. Lift the handset or face the console to record your announcement.
7. Press **MENU/SELECT** again to stop recording. You hear the playback of the recording.
8. Press **▲** or **▼** to choose **OK** to save the recording, or choose **Change** to record again if desired. Press **MENU/SELECT** or **▶/SKIP**.

Answering system

General mailbox setup

To play the recorded general mailbox announcement:

1. When the console is idle, press **MENU/SELECT**.
2. Press **▲** or **▼** to scroll to **Ans sys setup**, then press **MENU/SELECT** or **▶/SKIP**.
3. Press **MENU/SELECT** or **▶/SKIP** to select **Gen MB setup**.
4. Press **▲** or **▼** to choose **Annmcment setup**, then press **MENU/SELECT** or **▶/SKIP**.
5. Press **▲** or **▼** to scroll to **User annmcment**, then press **MENU/SELECT** or **▶/SKIP**. The current announcement plays.

To play and select the default general mailbox announcement:

1. When the console is idle, press **MENU/SELECT**.
2. Press **▲** or **▼** to scroll to **Ans sys setup**, then press **MENU/SELECT** or **▶/SKIP**.
3. Press **MENU/SELECT** or **▶/SKIP** to select **Gen MB setup**.
4. Press **▲** or **▼** to choose **Annmcment setup**, then press **MENU/SELECT** or **▶/SKIP**.
5. Press **MENU/SELECT** or **▶/SKIP** again to choose **Default**. The default announcement plays.
6. Press **MENU/SELECT** or **▶/SKIP** to save the setting.

Answering system

Announce only setup

If announce only is turned on, when there is an incoming call, the system plays an announcement after the number of rings you set in the **Number of rings (announce only)** section below. Then, the call is dropped.

Activate announce only

The console displays **Annc** above the line key(s) when the announce only mode is turned on for the particular line(s).

1. When the console is idle, press **MENU/SELECT**.
2. Press **▲** or **▼** to scroll to **Line mode**, then press **MENU/SELECT** or **▶/SKIP**.
3. Press **▲** or **▼** to select the desired line (**Line 1**, **Line 2**, **Line 3** or **Line 4**) or **All lines**, then press **MENU/SELECT** or **▶/SKIP**.
4. Press **▲** or **▼** to select **Announce only**, then press **MENU/SELECT** or **▶/SKIP** to save the setting.



NOTE: The announce only settings, including number of rings and announcement, apply to all lines where the corresponding line mode is activated.

Number of rings (announce only)

Use this feature to set the number of times the system rings before the system picks up a call.

1. When the console is idle, press **MENU/SELECT**.
2. Press **▲** or **▼** to scroll to **Ans sys setup**, then press **MENU/SELECT** or **▶/SKIP**.
3. Press **▲** or **▼** to scroll to **Annc only setup**, then press **MENU/SELECT** or **▶/SKIP**.
4. Press **MENU/SELECT** or **▶/SKIP** again to select **No. of rings**.
5. Press **▲** or **▼** to choose the desired number of rings (**2-7** or **Toll saver**).
 - **Toll saver** - the answering system answers a call after two rings when there are new messages, and after four rings when there are no new messages. This enables you to check for new messages without paying for a toll call.
6. Press **MENU/SELECT** or **▶/SKIP** to save the setting and return to the previous menu.

Answering system

Announce only setup

Announcement (announce only)

An announcement plays when calls are answered by the announce only mode. The system has a default announcement, *"Hello. Thank you for calling our company. We are not available to answer your call right now. Please call again later. Goodbye."* You can use this announcement or record your own.

You can record an announcement up to 90 seconds.

To record the announce only announcement:

1. When the console is idle, press **MENU/SELECT**.
2. Press **▲** or **▼** to scroll to **Ans sys setup**, then press **MENU/SELECT** or **▶/SKIP**.
3. Press **▲** or **▼** to scroll to **Annc only setup**, then press **MENU/SELECT** or **▶/SKIP**.
4. Press **▲** or **▼** to choose **Anncment setup**, then press **MENU/SELECT** or **▶/SKIP**.
5. The pointer (>) indicates whether the default or user-recorded announcement is used currently. Press **▲** or **▼** to scroll to **User anncment**, then press **MENU/SELECT** or **▶/SKIP**.
 - If you have recorded your own announcement before, press **▲** or **▼** to scroll to **Change**, then press **MENU/SELECT** or **▶/SKIP**.
6. Press **MENU/SELECT** to start recording. Lift the handset or face the console to record your announcement.
7. Press **MENU/SELECT** again to stop recording. You hear the playback of the recording.
8. Press **▲** or **▼** to choose **OK** to save the recording, or choose **Change** to record again if desired. Press **MENU/SELECT** or **▶/SKIP**.

Answering system

Announce only setup

To play the recorded announce only announcement:

1. When the console is idle, press **MENU/SELECT**.
2. Press **▲** or **▼** to scroll to **Ans sys setup**, then press **MENU/SELECT** or **▶/SKIP**.
3. Press **▲** or **▼** to scroll to **Annc only setup**, then press **MENU/SELECT** or **▶/SKIP**.
4. Press **▲** or **▼** to choose **Anncment setup**, then press **MENU/SELECT** or **▶/SKIP**.
5. Press **▲** or **▼** to scroll to **User anncment**, then press **MENU/SELECT** or **▶/SKIP**. The current announcement plays.

To play and select the default announce only announcement:

1. When the console is idle, press **MENU/SELECT**.
2. Press **▲** or **▼** to scroll to **Ans sys setup**, then press **MENU/SELECT** or **▶/SKIP**.
3. Press **▲** or **▼** to scroll to **Annc only setup**, then press **MENU/SELECT** or **▶/SKIP**.
4. Press **▲** or **▼** to choose **Anncment setup**, then press **MENU/SELECT** or **▶/SKIP**.
5. Press **MENU/SELECT** or **▶/SKIP** again to choose **Default**. The default announcement plays.
6. Press **MENU/SELECT** or **▶/SKIP** to save the setting.

Answering system

Answering system setup

All feature settings below apply to the auto attendant, announce only and general mailbox answer modes.

Call screening

Use this feature to choose whether incoming messages can be heard over the speaker when they are being recorded. This feature is set to **On** by default. You hear the incoming message on your console when a call comes in.

1. When the console is idle, press **MENU/SELECT**.
2. Press **▲** or **▼** to scroll to **Ans sys setup**, then press **MENU/SELECT** or **▶/SKIP**.
3. Press **▲** or **▼** to scroll to **Call screening**, then press **MENU/SELECT** or **▶/SKIP**.
4. Press **▲** or **▼** to choose **On** or **Off**.
5. Press **MENU/SELECT** or **▶/SKIP** to save the setting and return to the previous menu. To exit without making changes, press **CANCEL** or **◀/REPEAT**.

Message length

Use this feature to set the maximum length of each recorded message. The caller can record a message up to that specific time period.

1. When the console is idle, press **MENU/SELECT**.
2. Press **▲** or **▼** to scroll to **Ans sys setup**, then press **MENU/SELECT** or **▶/SKIP**.
3. Press **▲** or **▼** to scroll to **Message length**, then press **MENU/SELECT** or **▶/SKIP**.
4. Press **▲** or **▼** to choose **1 minute**, **2 minutes** or **3 minutes**.
5. Press **MENU/SELECT** or **▶/SKIP** to save the setting and return to the previous menu. To exit without making changes, press **CANCEL** or **◀/REPEAT**.

Answering system

Answering system setup

Call intercept

When a caller is leaving a message on your general mailbox, you can stop the recording and talk to the caller by pressing the corresponding line key (**LINE 1-LINE 4**). Choose whether private incoming messages can be intercepted by the console during recording.

1. When the console is idle, press **MENU/SELECT**.
2. Press **▲** or **▼** to scroll to **Ans sys setup**, then press **MENU/SELECT** or **▶/SKIP**.
3. Press **▲** or **▼** to scroll to **Call intercept**, then press **MENU/SELECT** or **▶/SKIP**.
4. Press **▲** or **▼** to choose **On** or **Off**.
5. Press **MENU/SELECT** or **▶/SKIP** to save the setting and return to the previous menu. To exit without making changes, press **CANCEL** or **◀/REPEAT**.

Set remote access code

Use this code to select a three-digit number to allow remote access of the answering system from another telephone. You can change the code to any number from **000-999**. This code is **000** by default.

1. When the console is idle, press **MENU/SELECT**.
2. Press **▲** or **▼** to scroll to **Ans sys setup**, then press **MENU/SELECT** or **▶/SKIP**.
3. Press **▲** or **▼** to scroll to **Set access code**, then press **MENU/SELECT** or **▶/SKIP**.
4. Use the dialing keys to enter a three-digit remote code.
 - Press **DELETE** to delete a digit.
 - Press **◀/REPEAT** or **▶/SKIP** to move the cursor to the left or right.
5. Press **MENU/SELECT** to save the setting and return to the previous menu. To exit without making changes, press **CANCEL**.

Answering system

Answering system setup

Message alert tone

Use this feature to turn the audible message alert on or off.

If the message alert tone is on, the console beeps every 10 seconds when there are new messages in the general mailbox.

1. When the console is idle, press **MENU/SELECT**.
2. Press **▲** or **▼** to scroll to **Ans sys setup**, then press **MENU/SELECT** or **▶/SKIP**.
3. Press **▲** or **▼** to scroll to **Msg alert tone**, then press **MENU/SELECT** or **▶/SKIP**.
4. Press **▲** or **▼** to choose **On** or **Off**.
5. Press **MENU/SELECT** or **▶/SKIP** to save the setting and return to the previous menu. To exit without making changes, press **CANCEL** or **◀/REPEAT**.



NOTE: You can press any keys on the console to temporarily silence the message alert tone when it is playing. The message alert tone resumes when a new message is recorded.

Answering system

Auto attendant operation

Using the auto attendant

When auto attendant is on, it automatically picks up the ringing line after the number of rings you programmed (see **Number of rings (auto attendant)** on page 70), and plays the appropriate auto attendant announcement. You can choose from one of the following options.

- Enter the extension number you want to call after the auto attendant announcement is played. The system plays, *“Please wait.”*
 - ◇ If the mailbox of the destination extension is off and user does not pick up the call after five rings, the system announces, *“Extension X is not available to answer your call right now.”* The auto attendant announcement will replay. If no command is entered after the second replay of the auto attendant announcement, the call will be dropped.
 - ◇ If the mailbox on the destination extension is on and user does not pick up the call after the number of rings set in the extension, the extension announces, *“Extension X is not available to answer your call right now. Please leave a message after the tone,”* then you can record a private message in that extension mailbox.
 - ◇ If the mailbox on the destination extension is on and the **Announce only** answer mode is selected, the system announces, *“Extension X is not available to answer your call right now. Please call again later. Goodbye.”*
- Press * (star key) twice to enter the general mailbox and leave a message.
- If you have recorded a directory announcement, press # (pound key) twice to play the directory announcement. The caller can enter the desired extension number anytime during the directory announcement is being played.
- Enter the remote access code when the auto attendant announcement is being played to access the answering system remotely.

If the caller does not enter a command after about five seconds, the auto attendant announcement will replay. If no command is entered after the second replay of the auto attendant announcement, the call will be dropped.

Answering system

Auto attendant operation

Auto attendant (AA) flow chart

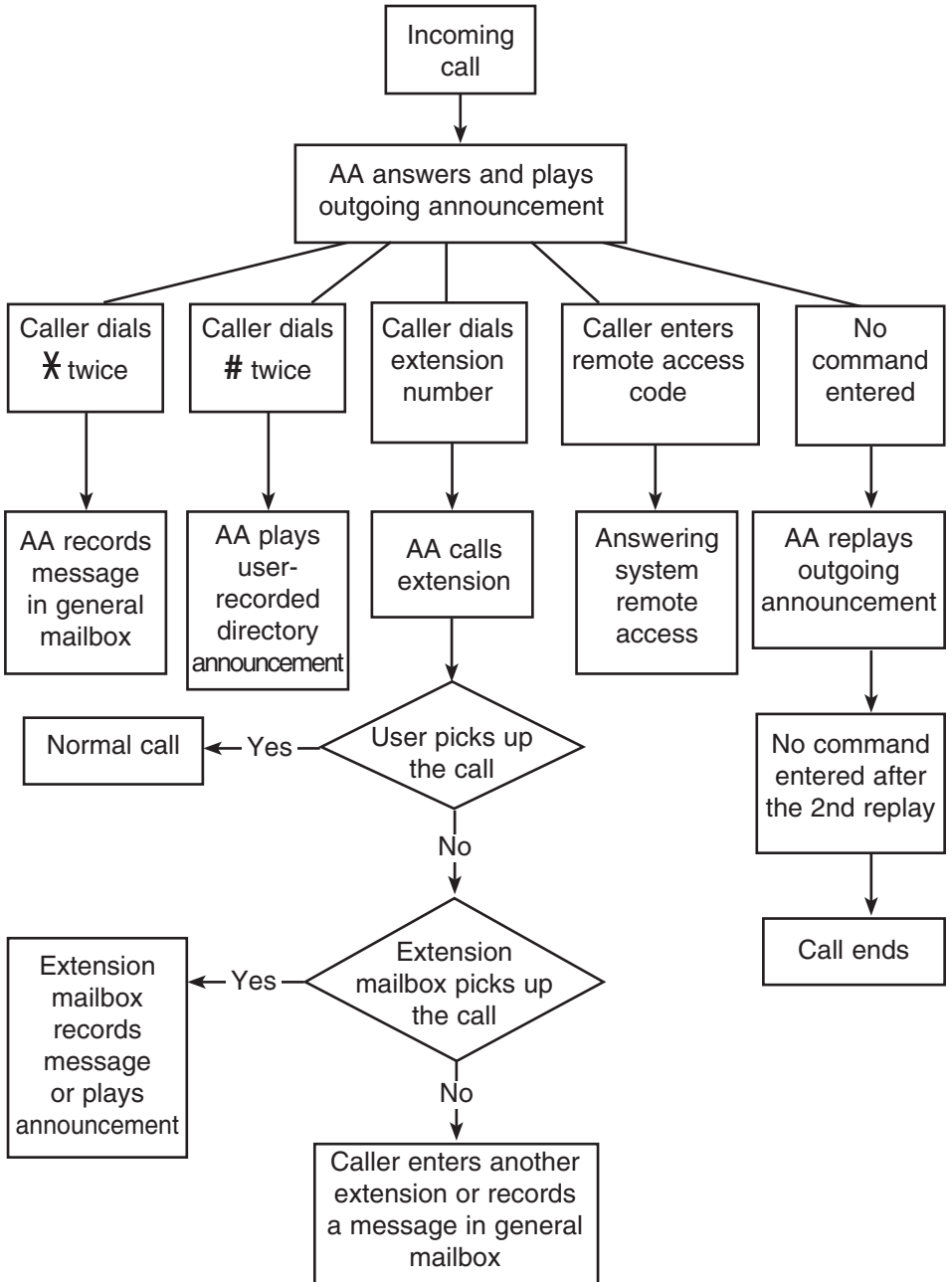

NOTE: Extension mailbox is not available in cordless headsets or speakerphones.

Answering system

Answering system operation

New message indication

The console displays **XX New messages** when there are new messages and/or memos in the general mailbox.

The **MESSAGE WAITING** indicator on the console turns on when there are new messages in the general mailbox.

Call screening

If the answering system and call screening are turned on (see **Call screening** on page 81), the incoming message broadcasts at the console when a call arrives. During message recording, press **+VOL/-** to adjust the volume, or press **CANCEL** to stop call screening. To resume screening the call, press **MENU/SELECT**.

Call intercept

When a caller is leaving a message on your general mailbox, you can stop the recording and talk to the caller by pressing the corresponding line key (**LINE 1-LINE 4**). To turn this feature on or off, see **Call intercept** on page 82.

Message playback

From the console, you can play the messages in the general mailbox.

You can choose to play the new or old messages.

When the playback begins, the total number of messages is announced. Before each message, the system announces the date and time of the recording before playing each message. After the last message, you hear, “*End of the messages.*”



NOTE: A maximum of two stations can listen to message playback in their mailbox at the same time.

To listen to messages in the general mailbox:

1. While the console is idle, press **MAIL BOX**.
2. Press **MENU/SELECT** or **▶/SKIP** to choose **Play messages**.
3. If you have only new messages or only old messages, the console plays the messages directly.

-OR-

If you have both new and old messages, press **▲** or **▼** to choose **New messages** to play the new messages only, or **Old messages** to play the old messages in the general mailbox. Press **MENU/SELECT** or **▶/SKIP**.

Answering system

Answering system operation

Options during playback

When a message is playing, you can adjust the playback volume, skip, repeat, delete the message, or switch between speakerphone and handset earpiece.

When a message is playing on the console:

- Press **+VOL/-** to adjust the message playback volume.
- Press **▶/SKIP** after the date and time announcement to skip to the next message.
- Press **◀/REPEAT** to repeat the current message. **Immediately press** **◀/REPEAT** after the date and time announcement to hear the previous message.
- Press **DELETE** after the date and time announcement to delete the message. The system announces “*Message deleted.*”
- Lift the corded handset to listen to the message playback through the handset earpiece. Press **SPEAKER** **◀▶** to switch back to speakerphone.

Transfer messages

When a message is playing, you can transfer the message to a desired extension.

When a message is playing on the console:

1. Press **TRANSFER**.
2. Press **▲** or **▼** to choose a desired extension, then press **MENU/SELECT** or **▶/SKIP**. The console displays **Message transferred to extension X** and announces, “*Message transferred to extension mailbox X.*”



NOTE: Messages transferred to another extension will not have a copy saved in the originated mailbox.

Answering system

Answering system operation

Delete all general mailbox messages

You can delete all messages stored in the general mailbox.

1. When the console is idle, press **MAIL BOX**.
2. Press **▲** or **▼** to scroll to **Delete all old**, then press **MENU/SELECT** or **▶/SKIP**.
3. The console displays **Delete all old messages?**. Press **▲** or **▼** to scroll to **Yes**, then press **MENU/SELECT** or **▶/SKIP** to confirm. The screen displays **All old msgs deleted**.

Record and deliver memos

Memos are messages you record into the general mailbox. You can save, play back, and delete them like incoming messages. You can record a memo as a reminder to yourself, or send a message to other extensions using the answering system.

1. When the console is idle, press **MAIL BOX**.
2. Press **▲** or **▼** to scroll to **Record memo**, then press **MENU/SELECT** or **▶/SKIP**.
3. Press **▲** or **▼** to scroll to a desired extension, then press **MENU/SELECT** or **▶/SKIP**.
4. Press **MENU/SELECT** to start recording. Lift the corded handset or face the console to record your memo.
5. Press **MENU/SELECT** again to stop recording. You hear the playback of the recording.
6. Press **▲** or **▼** to choose **OK** to save the recording, or choose **Change** to record again if desired. Press **MENU/SELECT** or **▶/SKIP**.



NOTES:

- Memos delivered to another extension will not have a copy saved in the originated mailbox.
- Only one station can record memo at a time.

Remaining time

You can check the amount of space currently in the system for the estimated remaining recording time and number of messages that can be recorded.

1. When the console is idle, press **MAIL BOX**.
2. Press **▲** or **▼** to scroll to **Remaining time**, then press **MENU/SELECT** or **▶/SKIP**. The remaining time and message capacity display.
3. After checking the screen display, press **CANCEL** or **◀/REPEAT** to return to the previous menu.

Answering system

Remote access

Use this feature to reach your answering system remotely by calling any telephone line connected this console from any touch-tone telephone. Make sure the auto attendant, the announce only mode, or the general mailbox of the console is turned on for this feature to work. Remote access can only play messages stored in the general mailbox.

To remotely reach the answering system:

1. Dial any telephone line connected to this console from any touch-tone telephone.
2. Once the system answers, enter the three-digit remote access code (**000** is the default code; see **Set remote access code** on page 82 to change it).
3. You can enter the following remote commands.

Remote commands:

1	Press to play all messages in the general mailbox.
2	Press to delete all old messages in the general mailbox.
3	Press to delete the current message (during playback).
4	Press to repeat the current message (during playback). Within five seconds of message playback, press 4 again to listen to the previous message (during playback).
5	Press to stop and return to the remote commands (during playback).
6	Press to skip the current message (during playback).
8	Press to transfer the current message (during playback).
#	Press to end the call.

5. Hang up to end the call.



NOTES:

- If you do not enter the valid remote access code after you enter the answering system successfully, the system responds according to the selected line mode.
- When there is no new message or all the new messages are played during remote access, you hear a help menu listing all features and commands. If there is no command after the help menu is played three times, the call ends automatically.

Appendix

Deregistering extensions

If you already have nine registered extensions and need to replace or add a new extension, you must first deregister the desired extension(s) first, then register the extension(s) you wish to use, one at a time. Deregistering a cordless handset or deskset will clear the extension mailbox on that device.

Please read all the instructions on this page before beginning the deregistration process.

Please make sure the telephone system is idle before deregistration. To deregister a single extension or all extensions registered to the console:

1. On the console, press **MENU/SELECT**.
2. Press **▲** or **▼** to scroll to **Registration**, then press **MENU/SELECT** or **▶/SKIP**.
3. Press **▲** or **▼** to scroll to **Deregistration**, then press **MENU/SELECT** or **▶/SKIP**.
4. Press **▲** or **▼** to choose a single extension, or choose **All** to deregister all extensions if desired. Press **MENU/SELECT** or **▶/SKIP**.
5. Deregistration will remove all existing mailbox messages saved in the selected extension(s). Press **▲** or **▼** to choose **Yes** to confirm, then press **MENU/SELECT** or **▶/SKIP**.
 - If there is no mailbox message in the extension(s), press **▲** or **▼** to choose **Yes** to continue the deregistration.
6. Deregistration starts after the existing mailbox messages are deleted.
 - When the deregistration of a single device is successful, there is a confirmation tone and the console shows the completion message.
 - If you selected to deregister all extensions, the console reboots upon completion of the deregistration process.



NOTES:

- You can also deregister all extensions by resetting the console to factory default (see **Factory reset** on page 35).
- If you want to replace the console in the system, make sure you deregistered all extensions first.
- If the deregistration process is not successful, you might need to reset the system and try again. To reset, unplug the power adapter from the console and then plug it back in.
- To register a cordless handset again, refer to the registration information on page 11.
- To register a cordless deskset again, refer to the registration information on page 10.
- To register a cordless headset or speakerphone again, refer to the addendum sheet that comes with the package.

Appendix

Console display screen messages

All calls deleted.	All Caller ID history entries are deleted.
All group settings clear.	All group settings for paging call are cleared.
All old msgs deleted.	All old messages in the general mailbox are deleted.
Call history empty	There are no entries in the caller ID history.
Calling:	The console is making an intercom call.
Contact deleted	A directory entry is deleted.
Contact saved	A number is saved to the directory.
Deleted	A Caller ID history entry is deleted.
Deleting msgs... Do not power off. This may take several minutes.	The console is deleting the mailbox messages of the selected extension(s) during deregistration. Do not power off the console during this period.
Deskset X deregistered	The cordless deskset is deregistered from the telephone system.
Deskset X registered.	The cordless deskset registration is successful.
Directory empty	There are no directory entries.
Directory full	The directory is full. You cannot save new entries unless you delete some current entries.
Ended	You have just ended a call.
Extension busy	The destination extension is on an intercom call.
Handset X deregistered	The cordless handset is deregistered from the telephone system.
Handset X registered.	The cordless handset registration is successful.
HDST/SPK X deregistered	The cordless headset or speakerphone is deregistered from the telephone system.
HDST/SPK X registered.	The cordless headset or speakerphone registration is successful.

Appendix

Console display screen messages

HDST/SPK X unlinked.	You have detached the cordless headset or speakerphone from an extension.
HDST/SPK X:LX	The cordless headset or speakerphone you linked with the console is in use on a telephone line.
HDST/SPK X:Conf	The cordless headset or speakerphone you linked with the console is in a conference call.
HDST/SPK X:INT	The cordless headset or speakerphone you linked with the console is in an intercom call.
Intercom	The console is on an intercom call.
—Intercom—	There is an intercom call coming in.
Intercom in use	The console is holding an intercom call and cannot barge-in a line.
Line in conf.	You cannot barge-in an established conference call.
Line user's intercom in use	The extension on the desired line is holding an intercom call. You cannot barge-in it at the moment.
Line X	The telephone line X is in use.
—Line X— Incoming call	There is an incoming call from Line X.
Line X transferred to	The console is transferring a call to a system extension.
M.O.H. currently in use. Please try again later.	The console, cordless deskset or handset is holding a call. You cannot change, review, record or change the M.O.H. source.
Message transferred to extension X	A message is transferred from the general mailbox to the private mailbox of extension X.
No answer. Please try again later	The destination extension does not answer the intercom call.
No device is connected to the M.O.H. jack at console.	The audio device is not connected to the MUSIC ON HOLD (🔇) jack while the M.O.H. source is set to Aux. in device .

Appendix

Console display screen messages

No registered HDST/SPK. Go to Registration, Register Ext to add HDST/SPK.	You select HDST/SPK in the main menu but there is no registered cordless headset or speakerphone.
Number already saved	The telephone number you have entered is already stored in the directory.
Paging...	A paging call is established to other system extensions.
Primary line: Line X no line	You set the primary line that is not plugged.
Private call	Call privacy is activated on the line you are trying to reach.
Rebooting to deregister all extensions...	The console is rebooting to complete deregistering all extensions.
Reset Console... Do not power off. This may take several minutes.	The console is resetting to default settings. Do not power off the console during this period.
Redial empty	The redial list is empty.
Registering...	The console is registering a cordless deskset, handset, headset or speakerphone.
Registration failed	Registration of a cordless deskset, handset, headset or speakerphone is failed.
System busy. Try again later	The telephone system is in use. You cannot deregister any extension at the moment. The general mailbox is in use or an extension is holding a call. You cannot reset the console settings to default.
XX Missed calls	There are new calls in the caller ID history.
XX New messages	There are new messages in the general mailbox.

Appendix

Troubleshooting

If you have difficulty with your telephone, please try the suggestions below. For customer service, visit our website at www.vtechphones.com or call **1 (800) 595-9511**. In Canada, please dial **1 (800) 267-7377**.

My console doesn't work at all.

- Make sure the power cord is securely plugged in.
- Make sure you plug the telephone line cord(s) securely and firmly into the console and the telephone wall jack.
- Reset the console. Unplug the electrical power. Wait approximately 15 seconds, then plug it back in. Allow up to one minute for the console to reset.
- Other electronic products such as HAM radios and other DECT phones, can cause interference with your cordless phone. Try installing your phone as far away as possible from these types of electronic devices.
- You may need to purchase four AA alkaline batteries as backup battery to make the console work in the event of a power failure. Please refer to **Backup battery installation** on page 2 in this user's manual.

I cannot get a dial tone from the corded handset.

- First try all the suggestions mentioned above.
- Make sure you plug the handset cord securely and firmly into the handset jack on the console and the corded handset.
- If the previous suggestions do not work, disconnect the console from the telephone jack and connect to a different telephone. If there is no dial tone on that telephone either, the problem is in your wiring or local service. Contact your telephone service provider.
- Your line cord might be malfunctioning. Try installing a new line cord.

I cannot dial out.

- First try all the suggestions mentioned above.
- Make sure you have a dial tone before dialing. The corded handset might take a second or two to connect the console and produce a dial tone. This is normal. Wait an extra second before dialing.
- Eliminate any background noise. Noise from a television, radio or other appliances might cause the telephone to not dial out properly. If you cannot eliminate the background noise, first try muting the corded handset before dialing, or dialing from another room by a cordless handset with less background noise.
- If the other telephones in your building are having the same problem, contact your telephone service provider.

Appendix

Troubleshooting

My console isn't performing normally.

- Make sure you plug the power cord securely into the console. Plug the power adapter into a different working electrical outlet without a wall switch.
- Reset the console. Unplug the electrical power and remove all the batteries. Wait 15 seconds, then plug the power adaptor back in and install the batteries again. Allow up to one minute for the console to reset.
- Other electronic products such as HAM radios and other DECT phones, can cause interference with your cordless phone. Try installing your phone as far away as possible from these types of electronic devices.

I get noise, static, or weak signals even when I'm near the console.

- If you subscribe to high-speed Internet service (DSL - digital subscriber line) through your telephone lines, you must install a DSL filter between each telephone line cord and telephone wall jack. The filter prevents noise and caller ID problems as a result of DSL interference. Please contact your DSL service provider for more information about DSL filters.
- You may be able to improve the performance of your console by installing your new console as far as possible from any other existing corded or cordless telephone system that may already be installed.
- Other electronic products such as HAM radios and other DECT phones, can cause interference with your cordless phone. Try installing your phone as far away as possible from these types of electronic devices.
- Do not install this console near a microwave oven or on the same electrical outlet. You might experience decreased performance while the microwave oven is operating.
- If you plug your telephone in with a modem or a surge protector, plug the console (or modem/surge protector) into a different location. If this does not solve the problem, relocate your console or modem farther apart from one another, or use a different surge protector.
- Relocate your telephone to a higher location. The telephone might have better reception in a high area.
- If the other telephones in your building are having the same problem, contact your telephone service provider.

I experience poor sound quality when using the speakerphone.

- For increased sound quality while using the telephone speakerphone, place the console on a flat surface.
- Excessive background noise will cause a speakerphone to fade in and out. Try controlling the background noise by turning off any audio devices near the speakerphone. Also, try to avoid interrupting the person at the other end of the conversation while they are speaking. If background noise cannot be controlled, you should stop speakerphone operation and return to normal corded handset mode.

Appendix

Troubleshooting

- When using a speakerphone, controlling background noise in your environment is essential. While you are listening to your party, press **MUTE** to temporarily turn your microphone off. When it is your turn to speak, remember to press **MUTE** again to turn the microphone on.

I hear other calls while using my telephone.

- Disconnect the telephone line from the console, and plug it into a different telephone. If you still hear other calls, call your telephone service provider.

My console does not ring when I receive a call.

- Make sure that the ringer is not off. Refer to **Ringer volume** on page 28 in this user's manual.
- Make sure the telephone line cords and power cord are plugged in securely.
- You may have too many extension telephones on your telephone line to allow all of them to ring simultaneously. Try unplugging some of the other telephones.
- If the other telephones in your building are having the same problem, contact your telephone service provider.
- Test a working telephone at the telephone jack. If another telephone has the same problem, contact your telephone service provider.
- Other electronic products such as HAM radios and other DECT phones, can cause interference with your cordless phone. Try installing your phone as far away as possible from these types of electronic devices.
- The telephone line cord might be defective. Try installing a new line cord.
- Make sure that the ring group assignment is correct. See **Ring group** on page 16 for more details.

My calls cut in and out while I'm using my corded handset.

- Other electronic products such as HAM radios and other DECT phones, can cause interference with your cordless phone. Try installing your phone as far away as possible from these types of electronic devices.
- Do not install this console near a microwave oven or on the same electrical outlet. You might experience decreased performance while the microwave oven is operating.
- If you plug your console in with a modem or surge protector, plug the console (or modem/surge protector) into a different location. If this does not solve the problem, relocate your console or modem farther apart from one another, or use a different surge protector.
- Relocate your console to a higher location. The console might have better reception when installed in a high area.

Appendix

Troubleshooting

- If the other telephones in your building are having the same problem, contact your telephone service provider.
- Excessive background noise will cause a speakerphone to fade in and out. Try controlling the background noise by turning off any audio devices near the speakerphone. Also, try to avoid interrupting the person at the other end of the conversation while they are speaking. If background noise cannot be controlled, you should stop speakerphone operation and return to normal handset mode.
- When using a console speakerphone, controlling background noise in your environment is essential. While you are listening to your party, press **MUTE** to temporarily turn your microphone off. When it is your turn to speak, remember to press **MUTE** again to turn the microphone on.

My caller ID isn't working.

- Caller ID is a subscription service. You must subscribe to this service from your telephone service provider for this feature to work on your console.
- The caller must be calling from an area that supports caller ID.
- Both your and your caller's telephone service providers must use caller ID compatible equipment.
- If you subscribe to high-speed Internet service (DSL - digital subscriber line) through your telephone lines, you must install a DSL filter between each telephone line cord and telephone wall jack. The filter prevents noise and caller ID problems resulting from DSL interference. Please contact your DSL service provider for more information about DSL filters.

System does not receive caller ID when on a call.

- Make sure you subscribe to caller ID with call waiting features from your telephone service provider. Caller ID feature works only if both you and the caller are in areas offering caller ID service, and if both telephone service providers use compatible equipment.

The answering system is recording incomplete messages.

- If a caller leaves a very long message, part of it may be lost when the system disconnects the call after the set message length. See **Message length** on page 81 for details.
- If the caller pauses for longer than seven seconds, the system stops recording and disconnects the call.
- If the system's memory becomes full during message recording, the system stops recording and disconnects the call.
- If the caller's voice is very soft, the system may stop recording and disconnect the call.

Appendix

Troubleshooting

I have difficulty hearing messages.

- Press **VOL+** to increase the speaker volume on the console.

System does not answer after the correct number of rings.

- Make sure that the answering system is on (page 14).
- If toll saver is selected, the number of rings changes to two when there are new messages waiting (page 70, page 75, page 78).
- If the memory is full or if the system is off, the answering system answers after 10 rings.
- In some cases, the answering system is affected by the ringing system used by your telephone service provider.
- If you subscribe to voicemail service, change the number of rings so that your answering system answers before your voicemail (page 68). To determine how many rings activate your voicemail, contact your telephone service provider.
- If there is a fax machine connected to the same telephone line, try disconnecting the fax machine. If that solves the problem, consult your fax machine documentation for information on compatibility with answering systems.

The auto attendant announcement is not correct.

- Make sure the daytime and night time announcements are set up and recorded (pages 71-72).
- Make sure that the day times that you entered are appropriate. See page 73.

The auto attendant does not respond when callers dial an extension.

- Make sure directory announcement is recorded correctly to suit your company's needs (page 72).
- Make sure the caller is calling from a touch-tone telephone. If the caller hears clicks rather than tones, the commands are not recognized.
- The auto attendant might not detect the callers' commands when the announcement plays. Wait until the announcement is over before entering the code.
- There might be interference on the telephone line callers are using. Press the dial pad keys firmly when dialing.

Appendix

Troubleshooting

The auto attendant does not record messages.

- Make sure the auto attendant is turned on (page 70).
- Make sure the memory of the answering system is not full. Please refer to the **Remaining time** on page 88 in the user's manual. If the memory is full, the system announces "*Memory full*" and then hangs up. You need to delete some old messages in order to make room for new messages.
- If Announce only is selected in the **Line mode** menu (page 14), the answering system only plays the outgoing announcement. It does not record incoming messages.
- If you subscribe to voicemail service, change the number of rings so that your answering system answers before your voicemail (page 68). To determine how many rings activate your voicemail, contact your local telephone service provider.
- If there is a fax machine connected to the same telephone line, try disconnecting the fax machine. If that solves the problem, consult your fax machine documentation for information on compatibility with answering systems.

The answering system does not respond to remote access commands.

- Make sure you are using the correct remote access code (page 89).
- Make sure you are calling from a touch-tone telephone (away from home). When dialing a number, you should hear tones. If you hear clicks, then it is not a touch-tone telephone and cannot activate the answering system.
- The answering system might not detect the remote access code when your announcement is playing. Wait until the announcement is over before entering the code.
- There might be interference on the telephone line you are using. Press the dial pad keys firmly when dialing.

The outgoing announcement is not clear.

- When recording the announcement, make sure you speak in a normal tone of voice about nine inches from the console.
- Make sure there is no background noise (television, music, traffic, etc.) when recording.

COVM shows on the screen display and I do not know why.

- Your telephone has voicemail indication that is separate from the built-in answering system. If COVM appears on the display, then your telephone has received a signal from your telephone service provider. Contact your telephone service provider for more information on how to access your voicemail.

Appendix

Troubleshooting

I cannot retrieve voicemail messages.

- Your telephone has both a built-in answering system and voicemail indication. They are independent features and each alerts you to new messages differently (page 68). If you subscribe to voicemail service from your telephone service provider, contact your telephone service provider for more information on how to access your voicemail.

I have problems recording music or voice messages.

- Make sure the audio cable has been firmly plugged into your console and your audio device.

I subscribe to a nontraditional telephone service that uses my computer to establish connections, and my telephone doesn't work.

- Make sure your computer is powered on.
- Make sure your Internet connection is working properly.
- Make sure that the software is installed and running for your nontraditional telephone service.
- Make sure to plug your USB telephone adapter into a dedicated USB port on your computer. Do not plug it into a multiple port USB hub (USB splitter) that is not powered.
- In a few rare instances, the USB port on your computer may not have enough power. Try using a USB hub with its own external power supply.
- If you are using a firewall, it may prevent access to your nontraditional telephone service provider. Contact your service provider for more information.

Common cure for electronic equipment.

If the console does not seem to be responding normally, do the following (in the order listed):

1. Disconnect the power from the console.
2. Wait a few minutes.
3. Connect power to the console.
4. Wait for the console to synchronize its connection. This will take at least one minute to finish.

Appendix

Maintenance

Taking care of your telephone

- Your console contains sophisticated electronic parts, so you must treat it with care.
- Avoid rough treatment.
- Place the corded handset down gently.
- Save the original packing materials to protect your console if you ever need to ship it.

Avoid water

- You can damage your console if it gets wet. Do not use the corded handset in the rain, or handle it with wet hands. Do not install the console near a sink, bathtub or shower.

Electrical storms

- Electrical storms can sometimes cause power surges harmful to electronic equipment. For your own safety, take caution when using electric appliances during storms.

Cleaning your telephone

- Your console has a durable plastic casing that should retain its luster for many years. Clean it only with a soft cloth slightly dampened with water or a mild soap.
- Do not use excess water or cleaning solvents of any kind.

Remember that electrical appliances can cause serious injury if used when you are wet or standing in water. If the console should fall into water, DO NOT RETRIEVE IT UNTIL YOU UNPLUG THE POWER CORD AND TELEPHONE LINE CORDS FROM THE WALL, then pull the unit out by the unplugged cords.

Appendix

FCC part 68 and ACTA

This equipment complies with Part 68 of the FCC rules and with technical requirements adopted by the Administrative Council for Terminal Attachments (ACTA). The label on the back or bottom of this equipment contains, among other things, a product identifier in the format US:AAAEQ##TXXXX. This identifier must be provided to your telephone service provider upon request.

The plug and jack used to connect this equipment to premises wiring and the telephone network must comply with the applicable Part 68 rules and technical requirements adopted by ACTA. A compliant telephone cord and modular plug is provided with this product. It is designed to be connected to a compatible modular jack that is also compliant. An RJ11 jack should normally be used for connecting to a single line and an RJ14 jack for two lines. See Installation Instructions in the user's manual.

The Ringer Equivalence Number (REN) is used to determine how many devices you may connect to your telephone line and still have them ring when you are called. The REN for this product is encoded as the 6th and 7th characters following the US: in the product identifier (e.g., if ## is 03, the REN is 0.3). In most, but not all areas, the sum of all RENs should be five (5.0) or less. For more information, please contact your telephone service provider.

This equipment may not be used with Party Lines. If you have specially wired alarm dialing equipment connected to telephone line, ensure the connection of this equipment does not disable your alarm equipment. If you have questions about what will disable the alarm equipment, consult your telephone service provider or a qualified installer.

If this equipment is malfunctioning, it must be unplugged from the modular jack until the problem has been corrected. Repairs to this telephone equipment can only be made by the manufacturer or its authorized agents. For repair procedures, follow the instructions outlined under the **Limited Warranty**.

If this equipment is causing harm to the telephone network, the telephone service provider may temporarily discontinue your telephone service. The telephone service provider is required to notify you before interrupting service. If advance notice is not practical, you will be notified as soon as possible. You will be given the opportunity to correct the problem and the telephone service provider is required to inform you of your right to file a complaint with the FCC. Your telephone service provider may make changes in its facilities, equipment, operation, or procedures that could affect the proper functioning of this product. The telephone service provider is required to notify you if such changes are planned.

If this product is equipped with a corded or cordless handset, it is hearing aid compatible.

If this product has memory dialing locations, you may choose to store emergency telephone numbers (e.g., police, fire, medical) in these locations. If you do store or test emergency numbers, please:

Remain on the line and briefly explain the reason for the call before hanging up.

Perform such activities in off-peak hours, such as early morning or late evening.

Industry Canada

This device complies with Industry Canada license-exempt RSS standard(s).

Operation is subject to the following two conditions: (1) this device may not cause harmful interference, and (2) this device must accept any interference received, including interference that may cause undesired operation.

Privacy of communications may not be ensured when using this telephone.

The term "IC:" before the certification/registration number only signifies that the Industry Canada technical specifications were met.

The Ringer Equivalence Number (REN) for this terminal equipment is 0.1. The REN is an indication of the maximum number of devices allowed to be connected to a telephone interface. The termination on an interface may consist of any combination of devices subject only to the requirement that the sum of the RENs of all the devices does not exceed five.

This product meets the applicable Industry Canada technical specifications.

Appendix

FCC part 15

This equipment has been tested and found to comply with the requirements for a Class B digital device under Part 15 of the Federal Communications Commission (FCC) rules. These requirements are intended to provide reasonable protection against harmful interference in a residential installation. This equipment generates, uses and can radiate radio frequency energy and, if not installed and used in accordance with the instructions, may cause harmful interference to radio communications. However, there is no guarantee that interference will not occur in a particular installation. If this equipment does cause harmful interference to radio or television reception, which can be determined by turning the equipment off and on, the user is encouraged to try to correct the interference by one or more of the following measures:

- Reorient or relocate the receiving antenna.
- Increase the separation between the equipment and receiver.
- Connect the equipment into an outlet on a circuit different from that to which the receiver is connected.
- Consult the dealer or an experienced radio/TV technician for help.

Changes or modifications to this equipment not expressly approved by the party responsible for compliance could void the user's authority to operate the equipment.

This device complies with Part 15 of the FCC Rules. Operation is subject to the following two conditions: (1) this device may not cause harmful interference, and (2) this device must accept any interference received, including interference that may cause undesired operation. Privacy of communications may not be ensured when using this telephone.

To ensure safety of users, the FCC has established criteria for the amount of radio frequency energy that can be safely absorbed by a user or bystander according to the intended usage of the product. This product has been tested and found to comply with the FCC criteria. The handset may be safely held against the ear of the user. The console shall be installed and used such that parts of the user's body other than the hands are maintained at a distance of approximately 20 cm (8 inches) or more. If you choose to use a clipping device, please make sure to only use the supplied VTech belt clip.

This Class B digital apparatus complies with Canadian requirement:
CAN ICES-3 (B)/NMB-3(B)

WARNING: Changes or modifications to this equipment not expressly approved by the party responsible for compliance could void the user's authority to operate the equipment.

Appendix

For C-UL compliance only

Mesures de sécurité importantes



This symbol is to alert you to important operating or servicing instructions that may appear in this user's manual. Always follow basic safety precautions when using this product to reduce the risk of injury, fire, or electric shock.

Information relative à la sécurité

- Veuillez lire et comprendre toutes les instructions du guide d'utilisation. Relectez toutes les inscriptions apparaissant sur le produit.
- Évitez d'utiliser le téléphone pendant un orage. Il pourrait y avoir un faible risque d'électrocution.
- N'utilisez pas un téléphone près d'une fuite de gaz. Dans certaines circonstances, une flammèche pourrait se produire lorsque l'adaptateur est branché à une prise de courant, ou lorsque le combiné est déposé sur son chargeur. Ceci est un événement fréquent associé avec la fermeture d'un circuit électrique. L'utilisateur ne devrait pas brancher un téléphone dans une prise de courant, et ne devrait pas déposer un combiné chargé dans le chargeur, si le téléphone se trouve dans un environnement comportant une concentration de gaz inflammables ou ignifuges, à moins de se trouver dans un endroit où la ventilation est adéquate. Une flammèche dans de tels environnements pourrait provoquer une explosion. De tels environnements peuvent comprendre : les endroits où de l'oxygène à des fins médicales est utilisé sans ventilation adéquate; des endroits où se trouvent des gaz industriels (dissolvants de nettoyage, des vapeurs de gazoline, etc.), une fuite de gaz naturel, etc.
- N'utilisez pas ce produit près de l'eau ou lorsque vous êtes mouillés. Par exemple, ne l'utilisez pas dans des sous-sols humides ou sous la douche, ou près d'une piscine, d'un bain, d'un évier de cuisine, ou d'une cuve de lavage. N'utilisez pas de liquides, ou de vaporisateurs aérosol de nettoyage. Si le produit entre en contact avec du liquide, débranchez immédiatement le fil téléphonique ou le cordon d'alimentation. Ne rebranchez pas le produit avant qu'il soit complètement sec.
- Évitez d'installer le système téléphonique dans les endroits soumis à une température extrême, à la lumière directe du soleil ou à proximité immédiate d'autres appareils électriques ou électroniques. Protégez votre téléphone contre les sources d'humidité, la poussière, les vapeurs et les liquides corrosifs.
- Installez cet appareil dans un endroit protégé où personne ne peut trébucher sur les cordons d'alimentation ou la ligne téléphonique. Protégez les câbles contre les dommages ou l'abrasion.
- Si le produit ne fonctionne pas correctement, consultez la section **Dépannage (Troubleshooting)** des pages 94-100 de ce guide d'utilisation. Si vous ne pouvez pas régler le problème, ou si le produit est endommagé, consultez la section **Garantie limitée (Limited warranty)** des pages 106-107. N'ouvrez pas ce produit, sauf tel qu'indiqué dans le guide d'utilisation. L'ouverture du produit ou le remontage inadéquat pourrait vous exposer à des tensions dangereuses ou autres dangers.
- L'adaptateur de courant est conçu pour être orienté verticalement ou installé sur le plancher. Les broches ne sont pas conçues pour se maintenir en place si la fiche est branchée dans une prise de courant au plafond, sous la table ou sous une armoire.
- Pour les **PRODUITS À BRANCHER À UNE PRISE DE COURANT**, la prise de courant doit être installée près du produit, afin d'assurer une accessibilité sécuritaire à la prise de courant.



Mises en garde :

- N'utilisez seulement l'adaptateur inclus avec ce produit. Pour obtenir une pièce de rechange, visitez notre site Web au www.vtechphones.com ou composez le **1-800-595-9511**. Au Canada, composez le **1-800-267-7377**.
- Afin de prévenir les risques d'incendie ou d'explosion de la pile, remplacez la pile avec une pile du même type. Jetez les piles épuisées en respectant les instructions.

Appendix

For C-UL compliance only

Spécifiquement en rapport avec les téléphones sans fil

- Alimentation électrique : La base de ce téléphone sans fil doit être branchée à une prise de courant électrique fonctionnelle. La prise électrique ne doit pas être contrôlée par un interrupteur mural. Les appels ne peuvent pas être effectués à partir du combiné si la base n'est pas branchée, si elle est hors fonction ou si le courant électrique est coupé.
- Adaptateur de courant : L'adaptateur de courant est conçu pour être orienté verticalement ou installé sur le plancher. Les broches ne sont pas conçues pour se maintenir en place si la fiche est branchée dans une prise de courant au plafond, sous la table ou sous une armoire.

Mesures préventives pour les utilisateurs de stimulateurs cardiaques implantés dans l'organisme

Stimulateurs cardiaques (ne s'applique qu'aux téléphones sans fil numériques) :

L'organisme 'Wireless Technology Research, LLC (WTR)', une firme de recherche indépendante, a mené une évaluation pluridisciplinaire des interférences entre les téléphones sans fil portatifs et les stimulateurs cardiaques implantés dans l'organisme. Appuyée par l'Administration des aliments et drogues (FDA) des États-unis, la firme WTR recommande aux médecins :

Avis aux détenteurs de stimulateurs cardiaques

- Ils doivent tenir le téléphone sans fil à une distance d'au moins six pouces du stimulateur cardiaque.
- Ils ne doivent PAS placer le téléphone sans fil directement sur le stimulateur cardiaque, tel que dans une poche de chemise, lorsque celui-ci est en fonction.
- Ils doivent utiliser le téléphone sans fil en l'appuyant sur l'oreille qui se trouve dans la direction opposée au stimulateur cardiaque.

L'étude effectuée par l'organisme WRS n'a pas identifié de risque pour les détenteurs de stimulateurs cardiaques causé par les gens qui utilisent un téléphone sans fil à proximité de ceux-ci.

Spécifiquement en rapport avec les répondeurs téléphoniques

Enregistrement deux voies : Cet appareil n'émet pas de bips d'avertissement qui permettent de prévenir l'autre partie que vous enregistrez la conversation. Pour assurer votre conformité aux règlements fédéraux ou provinciaux en rapport avec les enregistrements des conversations téléphoniques, vous devriez informer l'autre partie lorsque vous activez l'enregistrement.

CONSERVEZ CES INSTRUCTIONS

Appendix

Limited warranty

1. What does this limited warranty cover?

The manufacturer of this VTech product warrants to the holder of a valid proof of purchase (“CONSUMER” or “you”) that the product and all accessories provided in the sales package (“PRODUCT”) are free from defects in material and workmanship, pursuant to the following terms and conditions, when installed and used normally and in accordance with the PRODUCT operating instructions. This limited warranty extends only to the CONSUMER for products purchased and used in the United States of America and Canada.

2. What will VTech do if the PRODUCT is not free from defects in materials and workmanship during the limited warranty period (“materially defective PRODUCT”)?

During the limited warranty period, VTech’s authorized service representative will repair or replace at VTech’s option, without charge, a materially defective PRODUCT. If we repair the PRODUCT, we may use new or refurbished replacement parts. If we choose to replace the PRODUCT, we may replace it with a new or refurbished PRODUCT of the same or similar design. We will retain defective parts, modules, or equipment. Repair or replacement of the PRODUCT, at VTech’s option, is your exclusive remedy. VTech will return repaired or replacement products to you in working condition. You should expect the repair or replacement to take approximately 30 days.

3. How long is the limited warranty period?

The limited warranty period for the PRODUCT extends for TWO (2) YEARS from the date of purchase. If VTech repairs or replaces a materially defective PRODUCT under the terms of this limited warranty, this limited warranty also applies to repaired or replacement PRODUCT for a period of either (a) 90 days from the date the repaired or replacement PRODUCT is shipped to you or (b) the time remaining on the original two-year limited warranty; whichever is longer.

4. What is not covered by this limited warranty?

This limited warranty does not cover:

- PRODUCT that has been subjected to misuse, accident, shipping or other physical damage, improper installation, abnormal operation or handling, neglect, inundation, fire, water, or other liquid intrusion; or
- PRODUCT that has been damaged due to repair, alteration, or modification by anyone other than an authorized service representative of VTech; or
- PRODUCT to the extent that the problem experienced is caused by signal conditions, network reliability or cable or antenna systems; or
- PRODUCT to the extent that the problem is caused by use with non-VTech accessories; or
- PRODUCT whose warranty/quality stickers, PRODUCT serial number plates or electronic serial numbers have been removed, altered or rendered illegible; or
- PRODUCT purchased, used, serviced, or shipped for repair from outside the United States of America or Canada, or used for commercial or institutional purposes (including but not limited to products used for rental purposes); or
- PRODUCT returned without a valid proof of purchase (see item 6 on the next page); or
- Charges for installation or setup, adjustment of customer controls, and installation or repair of systems outside the unit.

Appendix

Limited warranty

5. How do you get warranty service?

To obtain warranty service, visit www.vtechphones.com or call **1 (800) 595-9511**. In Canada, please dial **1 (800) 267-7377**.

NOTE: Before calling for service, please review the user's manual; a check of the PRODUCT's controls and features may save you a service call.

Except as provided by applicable law, you assume the risk of loss or damage during transit and transportation and are responsible for delivery or handling charges incurred in the transport of the PRODUCT(s) to the service location. VTech will return repaired or replaced PRODUCT under this limited warranty to you. Transportation, delivery or handling charges are prepaid. VTech assumes no risk for damage or loss of the PRODUCT in transit. If the PRODUCT failure is not covered by this limited warranty, or proof of purchase does not meet the terms of this limited warranty, VTech will notify you and will request that you authorize the cost of repair prior to any further repair activity. You must pay for the cost of repair and return shipping costs for the repair of products that are not covered by this limited warranty.

6. What must you return with the PRODUCT to get warranty service?

You must:

- Return the entire original package and contents including the PRODUCT to the VTech service location along with a description of the malfunction or difficulty; and
- Include a "valid proof of purchase" (sales receipt) identifying the PRODUCT purchased (PRODUCT model) and the date of purchase or receipt; and
- Provide your name, complete and correct mailing address, and telephone number.

7. Other limitations

This warranty is the complete and exclusive agreement between you and VTech. It supersedes all other written or oral communications related to this PRODUCT. VTech provides no other warranties for this PRODUCT. The warranty exclusively describes all of VTech's responsibilities regarding the PRODUCT. There are no other express warranties. No one is authorized to make modifications to this limited warranty and you should not rely on any such modification.

State/Provincial Law rights: This warranty gives you specific legal rights, and you may also have other rights which vary from state to state or province to province.

Limitations: Implied warranties, including those of fitness for a particular purpose and merchantability (an unwritten warranty that the PRODUCT is fit for ordinary use) are limited to one year from date of purchase. Some states/provinces do not allow limitations on how long an implied warranty lasts, so the above limitation may not apply to you. In no event shall VTech be liable for any indirect, special, incidental, consequential, or similar damages (including, but not limited to lost profits or revenue, inability to use the PRODUCT or other associated equipment, the cost of substitute equipment, and claims by third parties) resulting from the use of this PRODUCT. Some states/provinces do not allow the exclusion or limitation of incidental or consequential damages, so the above limitation or exclusion may not apply to you.

Please retain your original sales receipt as proof of purchase.

Appendix

Technical specifications

RF frequency band	1921.536MHz - 1928.448MHz
Channels	5
Console voltage (AC voltage, 50/60Hz)	100Vrms - 120Vrms
Console voltage (AC adapter output)	6VDC @800mA
Backup batteries	Four 1.5V AA size alkaline batteries
Headset jack	2.5mm, 32-150ohm

Operation with backup batteries	Operating time*
Talk time (corded handset earpiece)	Up to 4.8 hours
Talk time (console speakerphone)	Up to 3.9 hours
Standby	Up to 5 hours

* Operating times vary depending on your actual use and the age of the battery.

Index

A

- Add a corded headset 13
- Add a cordless handset 11
- Add a cordless headset or speakerphone 12
- Add a deskset 10
- Alert tones 27
- Announcement 71–74, 76–77, 79–80
- Announce only 14, 78–80
- Answer a call 37
- Answer an intercom call 47
- Answering system 68–89
- Area codes 33
- Auto-redial 44
- Auto attendant 14, 70–74, 84–85

B

- Backup battery installation 2
- Blind transfer 49

C

- Call history 62–67
- Call intercept 82, 86
- Call privacy 32, 40
- Call screening 81, 86
- Call transfer 49–50
- Call waiting 38, 62
- Caller ID 62–67
- Capacity 57, 69
- Cardiac pacemakers ii
- Central office voicemail (COVM)
 - on or off 56
 - reset 56
- Chain dialing 42
- Conference call 45–46
- Console setup 28–35

D

- Date 15
- Default
 - announcement 71, 74, 77, 80
 - music 17
- Default settings 35
- Deliver a memo 88
- Deregistration 90
- Deskset registration 10
- Dialing options 65
- Dial mode 35
- Directory 57–61
- Directory card 22
- Display dial 61

E

- End
 - a conference call 46
 - an intercom call 47
 - an outside call 36
 - a paging call 52

F

- Factory reset 35
- FCC, ACTA and IC regulations 102
- Flash 38

G

- General mailbox 14, 75–77

H

- Handset registration 11
- Handsfree use 37
- Hold
 - an intercom call 48
 - an outside call 39
- Hold reminder 34

Index

I

- Icons 26
- Important safety information i–ii
- Indication 26, 27, 36, 86
- Installation 1–5
- Intercom 47–48, 50

J

- Join a call 45–46

K

- Key tone 30

L

- Language 31
- LCD contrast 30
- Lights 27
- Limited warranty 106–107
- Line indicators 36
- Line mode 14
- Listening volume 38
- Low battery 2

M

- Maintenance 101
- Make
 - an intercom call 47
 - an outside call 36–37
 - a paging call 51
- Memo 88
- Memory match 64
- Menu
 - answering system setup 25
 - main menu 23–24
- Menu settings 28
- Message indication 86
- Message playback 86–87
- Missed (new) calls indicator 64

Music on hold (M.O.H.) 17–19, 39, 48

Mute 38

N

- Navigation keys 20
- New message indication 86

O

- On hook dialing (predialing) 37
- Operation 36–56
- Overview 20–25

P

- Pacemaker patients ii
- Paging 51–52
- Phonebook (directory) 57–61
- Predialing 37
- Primary line 31
- Privacy 32, 40
- Pulse dialing 35

R

- Record a call 41
- Recording time 81
- Redial 43–44
- Remaining time 88
- Remote access 89
- Rename console 34
- Review call history 64
- Review directory 59
- Ringer Volume 28
- Ring group 16

S

- Search by name 60
- Search for a contact 60
- Set date and time 15
- Set paging groups 52
- Speakerphone 37

Index

- Speed dial 53–55
- Speed dial keys 21, 53–55
- Switch between lines 39
- System setup 14–19

T

- Tabletop installation 3, 9
- Technical specifications 108
- Telephone operation 36–56
- Temporary ringer silencing 37
- Temporary tone dialing 38
- Time 15
- Transfer a call 49, 50
- Troubleshooting 94–100
- Two-way communication 51
- Two-way recording ii

U

- User support 35

V

- Voicemail
 - COVM 56
- Volume 28, 38
- Volume control 38

W

- Wall installation 6–8
- Warranty 106–107
- Website 35

Source of music files for the Music on hold feature:
FreeMusicArchive.org. Used under open license.



Designed to fit you home.
And your life.

VTech Communications, Inc.
A member of THE VTECH GROUP OF COMPANIES.
VTech is a registered trademark of VTech Holdings Limited.
Specifications are subject to change without notice.
© 2015 VTech Communications, Inc.
All rights reserved. 04/15. CM18445_CIB_V1.0
Document order number: 91-008469-010-100