

TABLE OF CONTENTS

INITIAL SETUP

Important Safety Instructions	3
Packing List	4
System Defaults	4
Display & LED Indication	4-5
Buttons & Indicators	4
Line Status Indicator	5
Station Status Indication	5
Important Features	5
Creating Your Unique System	6-8
Identifying Existing Wiring	6
System	6
System Communication	6
Square Configuration	6
Non-Square Configuration -	
Private Line Support	7
Using Other Telephones with the System	
Phones	7
Planning Your System	8
Installation Chart	8
Install Your System	9
Phone Installation	9
Connecting a Fax or PC Modem to	
the Data Port	9
Quick Setup	10-11
Assigning a Station Extension Number ..	10
Setting the Time & Date	10
Verifying Station and Line Configuration	11
Verifying System Configuration	11
Installation Checklist	11

PROGRAMMING THE TELEPHONE

Assigning a Station Extension Number	12
Setting the Time & Date	12
Setting a Private Line	13
Setting Automatic Answer	13
Setting the Outside Line	14
Setting the Area Code	14
Setting the Ringer On/Off by Line	15
Always Ring	15

PROGRAMMING THE VOLUME

Ringer Volume	16
Handset Volume	16
Speakerphone/Intercom Volume	16
Headset Volume	16

PROGRAMMING AUTODIAL

Autodial Information	17
Autodial Card	17
Programming a Caller ID Record into	
Autodial	17
Entering Autodial Records	18
Editing Autodial Entries	19
Autodial Pause	19
Setting the Flash Duration	20

PROGRAMMING CALL WAITING CALLER ID

Call Waiting Caller ID Service Options	21
Caller ID	21
Selecting Which Caller ID Records are	
Saved	22
Turning Call Waiting Caller ID OFF/ON	22

TELEPHONE OPERATION

Off Hook Options	23
Headset Operation	23
Speakerphone Operation	23
Call Duration Time	23
Answering Calls	24-25
Line Selection	24
Automatic Line Selection	24
Manual Line Selection	24
Answering a Call on Another Line	
During a Conversation	25
Answering a Call Waiting Caller ID Call ..	25
Making Calls	25

TABLE OF CONTENTS

TELEPHONE OPERATION (CONT.)

Memory Storage	26-28
Making a Call Using Caller ID	26
Display Redial	26
Memory Dial	26
Redial	27
Auto Busy Redial	27
No Answer Redial	28
Reviewing Autodial Entries	28
Dialing Stored Autodial Numbers	28
Storing a Scratch Pad Number	29
Dialing a Scratch Pad Number	29
Display & Dial Number	29
Hold	30
Audible Hold Reminder	30
Mute	30
Do Not Disturb (DND)	30
Transferring Calls	31-32
Blind Call Transfer	31
Attended Call Transfer	32
Call Privacy & Conference Calling	32-34
Call Privacy	32
Call Privacy Release	33
Conference Calling with Two Outside Lines	33
Privately Talking to One of the Conference Call Parties	34
Conference Calling with One Outside Line and Two Stations	34

INTERCOM & PAGING OPERATION

Intercom & Paging	35
Intercom Display Messages	35
Making an Intercom Call Using the Speakerphone	35
Making an Intercom Call Using the Headset or Handset	36
Answering Intercom Calls when Auto Answer is On	36
Answering Intercom Calls when Auto Answer is Off	36

Answering Intercom Calls When You Are On the Line	37
All Station Page	37
Room Monitor	37

CALL WAITING CALLER ID

Reviewing and Deleting Stored Caller ID Records	38
Caller ID Transfer	38

ADDITIONAL INFORMATION

Battery Installation	38
Wall Mounting Pedestal	39
Desk Top Pedestal	39
Power Failure Operation	40
Permanent Memory Protection	40
Short Term Memory	40
Performing a System Update	40
Station Reset	40
Displays	41-43
Troubleshooting	44-45
Filter Installation Diagram	45
FCC Requirements	46
Index	47

IMPORTANT SAFETY INSTRUCTIONS

INSTALLATION INSTRUCTIONS

1. Never install telephone wiring during a lightning storm.
2. Never install telephone jacks in wet locations unless the jack is specifically designed for wet locations.
3. Never touch uninsulated telephone wires or terminals unless the telephone line has been disconnected at the network interface.
4. Use caution when installing or modifying telephone lines.

SAFETY PRECAUTIONS

When using your telephone equipment, basic safety precautions should always be followed to reduce the risk of fire, electric shock and injury to persons, including the following:

1. Read and understand all instructions.
2. Follow all warnings and instructions marked on the product.
3. Unplug this product from the wall outlet before cleaning. Do not use liquid cleaners or aerosol cleaners. Use a damp cloth for cleaning.
4. Do not use this product near water: for example, near a bath tub, wash bowl, kitchen sink or laundry tub, in a wet basement, or near a swimming pool.
5. Do not place this product on an unstable cart, stand, or table. The product may fall, causing serious product damage.
6. Slots and openings in the cabinet and the back or bottom are provided for ventilation. To protect it from overheating, these openings must not be blocked or covered by placing the product on the bed, sofa, rug, or other similar surface. This product should never be placed near or over a radiator or heat register. This product should not be placed in an enclosed environment unless proper ventilation is provided.
7. Do not allow anything to rest on the power cord. Do not locate this product where the cord will be abused by animals or persons walking on it.
8. Do not overload wall outlets and extension cords as this can result in the risk of fire or electric shock.
9. Never push objects of any kind into this product through cabinet slots as they may touch dangerous voltage points or short out parts that could result in a risk of fire or electric shock.
10. Never spill liquid of any kind on the product.
11. To reduce the risk of electric shock, do not disassemble this product. Take it to a qualified serviceperson when service or repair work is required. Opening or removing covers may expose you to dangerous voltages or other risks. Incorrect re-assembly can cause electric shock when the appliance is subsequently used.
12. Unplug this product from the wall outlet and refer servicing to qualified service personnel under the following conditions:
 - A. When the power supply cord or plug is damaged or frayed.
 - B. If liquid has been spilled into the product.
 - C. If the product has been exposed to rain or water.
 - D. If the product does not operate normally by following the operating instructions. Adjust only those controls that are covered by the operating instructions because improper adjustment of other controls may result in damage and will often require extensive work by a qualified technician to restore the product to normal operation.
 - E. If the product has been dropped or the cabinet has been damaged.
 - F. If the product exhibits a distinct change in performance.
13. Avoid using a telephone (other than a cordless type) during an electrical storm. There may be a remote risk of electric shock from lightning.
14. Do not use the telephone to report a gas leak while near the leak.
15. You should use ONLY the power adapter supplied with your telephone.

SAVE THESE INSTRUCTIONS

INITIAL SETUP

PACKING LIST





Telephone Base	Two long RJ14 Telephone Cords
Handset	AC Adapter
Coiled Handset Cord	Mounting Pedestal
Owner's Guide	Spare Autodial Station Card

SYSTEM DEFAULTS

Once initial setup is complete, the unit is ready to use with the following program defaults. Programming each of the settings below needs to be done at each station:

PROGRAM FEATURE	FACTORY PRESET SETTING	REFERENCE PAGE
Area Code	The area code is set to "000"	14
Auto Answer	Auto Answer is ON for intercom use	13
Always Ring	The default is OFF for incoming calls when you are already on a line	15
Call Waiting Caller ID	Call Waiting Caller ID is set to OFF and ALL, so all caller ID records are retained	22
Default Ringer Volume	The default ringer volume is set to HIGH (on the back of the unit)	15
Flash Duration	The flash duration is set to 600 MS	20
Outside Line	The outside line is set to "-"	14
Ringer	The ringer is ON for all installed lines	15

DISPLAY & LED INDICATION

BUTTONS & INDICATORS	ACTION	DESCRIPTION
Headset (Answer) 	Lights red	When pressed to go off-hook using a headset
Intercom 	Lights red	During an all station page
	Lights red	When pressed to intercom another station
	Flashes red	When your station is being intercommed and Auto Answer is turned off
Mute 	Lights red	When pressed to mute an intercom or off-hook conversation
Speaker 	Lights red	When the speakerphone is activated
Transfer 	Displayed	When pressed to transfer a call

INITIAL SETUP

DISPLAY & LED INDICATION (cont.)

LINE STATUS

INDICATOR <small>- LINE 1</small>	DESCRIPTION
Off	Line is available to use or Unconnected line
Solid Red	Private line is in use at another extension
Slow Flashing Red	Call on hold at another station or privacy released call at another station
Rapid Flashing Red	Line ringing
Rapid Flashing Green	Call has been on hold at this station for over three minutes or call is being transferred to another station
Slow Flashing Green	Call has been placed on hold at this station for less than three minutes
Solid Green	Line is in use at this station or Station is participating in a conference call

STATION STATUS INDICATION (BUSY LAMP FIELD)

The unit allows you to view the activity of all stations in the system at a glance. When the station number icon displays on the LCD, this indicates that this station is on an outside line, intercom call, in Do Not Disturb mode or receiving a transferred call.

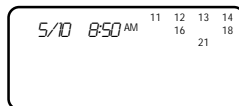

IMPORTANT FEATURES

LIFETIME MEMORY PROTECTION

No batteries are required to maintain caller ID information and autodial names and numbers. Non-volatile memory protects your entries in the event of a power failure.

SUPERTWIST NEMATIC (STN™) LCD

Advanced technology in the unit provides clear, multi-angle viewing of data on the large display.

HELP TEXT

If a delay of over 15 seconds occurs during programming the station ID or setting the time and date, help text will scroll across the display to assist you in programming.

CALL WAITING

The unit supports call waiting caller ID, however, a subscription to call waiting, caller ID and call waiting caller ID is required from your local telephone company to view caller ID records.

INITIAL SETUP

Thank you for purchasing this 4-line fully customizable telephone system. To fully take advantage of the unit's robust system features and to ensure correct installation, it is important to review and follow the owner's guide carefully.

CREATING YOUR UNIQUE SYSTEM

IDENTIFYING EXISTING WIRING

To properly connect the unit to your telephone lines, you must identify the type of jacks available.

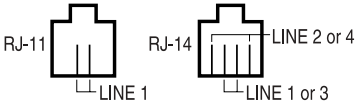

If you are installing or having installed telephone jacks, two RJ14 jacks are recommended.

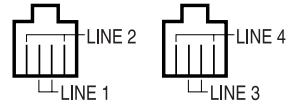

If the installation site is currently wired with RJ11 jacks, it is recommended that you upgrade to RJ14 jacks, available at your telephone supplier.

SYSTEM COMMUNICATION

A system is when there are more than one Executive Series phones and they all have line 1 connected and in common. For the system to operate, line 1 must be common to all stations. Using RF/IF technology, the units communicate with each other using the wiring of line 1, without affecting normal telephone operation. System information like station status and line use status is communicated over this common wire along with up to two simultaneous intercom conversations. The remaining lines, lines 2, 3 and 4 can be common to all or some of the stations. If line 1 is disconnected, you can still make and receive phone calls but the unit will not work as part of the system.

- The maximum length of the TOTAL telephone wire (including the line cords) in a system should not exceed 500 feet for line 1.
- If line 1 or 2 is a DSL line, you will need to install a filter (from your DSL service provider) for proper operation. See page 45.

SQUARE CONFIGURATION

When all lines are all common, the configuration is called "square". The chart below shows a simple square configuration. Since all lines are common, calls on any line can be transferred to any station.

	Line 1	Line 2	Line 3	Line 4
Station 11	X	X	X	X
Station 12	X	X	X	X
Station 13	X	X	X	X
Station 14	X	X	X	X
Station 15	X	X	X	X
Station 16	X	X	X	X
Station 17	X	X	X	X
Station 18	X	X	X	X
Station 19	X	X	X	X
Station 20	X	X	X	X
Station 21	X	X	X	X
Station 22	X	X	X	X

INITIAL SETUP

CREATING YOUR UNIQUE SYSTEM (cont.)

NON-SQUARE CONFIGURATION – PRIVATE LINE SUPPORT

As the diagram below illustrates, lines 1 and 2 are common to all stations and lines 3 through 10 are available to groups of stations, or departments. The sales stations, 14 and 15, each have private lines, lines 8 and 9. The President also has a private line, line 10.

Calls to lines 1 and 2 can be transferred to all stations. Calls on line 3 can be transferred to all stations except stations 14 and 15. Calls on line 6 can only be transferred to the stations which have that line, stations 12 and 13. Calls on line 7 can only be transferred to stations 20 and 21.

Station ID	Department	Line Number									
		1	2	3	4	5	6	7	8	9	10
Station 11	Reception	X	X	X	X						
Station 12	Marketing	X	X	X			X				
Station 13	Marketing	X	X	X			X				
Station 14	Sales	X	X			X			X		
Station 15	Sales	X	X			X				X	
Station 16	Customer Service	X	X	X	X						
Station 17	Customer Service	X	X	X	X						
Station 18	Warehouse	X	X	X		X					
Station 19	Warehouse	X	X	X		X					
Station 20	Accounting	X	X	X				X			
Station 21	Accounting	X	X	X				X			
Station 22	President	X	X	X							X

See page 13 to set a private line.

USING OTHER TELEPHONES WITH THE SYSTEM PHONES

While standard telephones can share lines with the system, features such as intercom and call transfer are unavailable to the standard telephone. The line status indicators will be activated by the standard telephones, but line privacy will not be maintained; a standard telephone can join a call in the system without the station releasing privacy. An unit can access a call that the standard telephone is on after the standard phone has been on a line for atleast 7 seconds. For more information on call privacy, see page 32.

INITIAL SETUP

CREATING YOUR UNIQUE SYSTEM (cont.)

PLANNING YOUR SYSTEM

1. Identify the number of stations you will need. (Maximum is twelve)
2. Determine how many lines are needed. (Maximum four per station)
3. Identify how many lines you want connected to each Executive Series phone in the system.
4. Determine which stations will get which lines.
5. Decide if each station requires a private line.

Create a chart to assist you in organizing your phone system, for example:

	Line 1:	Line 2:	Line 3:	Line 4:	Location / User
	111-4567	222-4567	333-4567	444-4567	
Station 11	X	X	X	X	Receptionist Area / Lisa
Station 12	X	X	X		Warehouse / Jake

INSTALLATION CHART

Station	Line 1:	Line 2:	Line 3:	Line 4:	Location / User
	-	-	-	-	
11					
12					
13					
14					
15					
16					
17					
18					
19					
20					
21					
22					

INITIAL SETUP

INSTALL YOUR SYSTEM

PHONE INSTALLATION

Any equipment connected to the phone line such as faxes, other phones or modems should be temporarily disconnected. Follow the installation sequence for best results.

Connecting Lines 1 and 2

1. Remove the mounting pedestal from the desk mount position.
2. CONNECT one end of the telephone cord into the jack labeled L1/L2, on the bottom of the unit.
3. Guide the line cord through one of the cord channels on the bottom of the unit.
4. Connect the other end of the telephone cord into the two-line RJ14 wall jack.

Connecting Lines 3 and 4

5. CONNECT one end of the other telephone cord into the jack labeled L3/L4, on the bottom of the unit.
6. Guide the line cord through the cord channels on the bottom of the unit.
7. CONNECT the other end of the telephone cord into the two-line RJ14 wall jack.
8. CONNECT the AC adapter plug into the AC adapter outlet on the bottom of the unit.
9. Thread the AC adapter cord through the channel on the bottom of the unit to prevent accidental disconnection.
10. Plug one end of the coiled handset cord into the handset. Plug the other side of the coiled cord into the outlet on the left side of the base with the icon of a handset below. Place the handset in the cradle.
11. Plug the AC adapter into an electrical wall outlet. The LCD will flash and you will see "INITIAL SETUP START". "PRESS START TO SETUP STATION" will scroll across the screen if the soft key under START is not pressed within 15 seconds. The unit is now ready to program. See page 10.
12. Install four AA alkaline batteries (not included) into the bottom side of the base to enable the telephone to operate up to 1 hour during a power failure. (See page 36 for battery installation). Batteries are not necessary for the unit to operate and retain stored data with AC power.
13. Determine if you want the phone to set on your desk or to be wall mounted. Install the pedestal. See PEDESTAL INSTALLATION on page 39.

CONNECTING A FAX OR PC MODEM TO THE DATA PORT

You can connect a fax or PC modem to the Data Port, located on the upper left rear side of the unit. This data port is connected to line 2. When a fax or PC modem is connected to the Data Port, and it is in use by the fax or PC modem, the connection is protected and cannot be interrupted by incoming or transferred calls.

The data port is ALWAYS active, regardless of the position of the PC/FAX switch. Placing the switch in the PC/FAX position silences the ring and turns off line status indication for that line.

1. Connect the line cord of the fax or PC modem into the Data Port, labeled "DOWN STREAM".
2. Position all PC/FAX switches on all Executive Series phones to the PC/FAX position. The line is now a dedicated PC/FAX line.



INITIAL SETUP

QUICK SETUP

On initial power-up (the line cord(s) and AC adapter are connected) each station will prompt the user to set the station ID, time and date. All other system defaults (see SYSTEM DEFAULTS on page 4) are in place and the station is immediately ready for use. Refer to your completed system configuration diagram, on page 8, for rapid installation.

ASSIGNING A STATION EXTENSION NUMBER

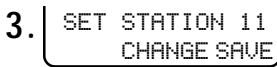
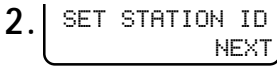

Press the soft key under "CHANGE" until the chosen extension number (11-22) appears in the display.

NOTE:

■ If another station's ID number is chosen, an error beep will be heard and "NOT AVAIL" will appear in the display. Press the soft key under "CHANGE" to select another extension number.

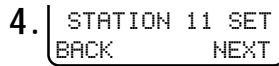

"STATION 11 SET" will appear in the display.

5. Press the soft key under "NEXT" to program the time.

SETTING THE TIME AND DATE

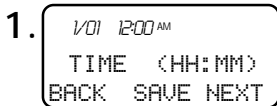

Use the keypad to enter the hour (two digits) and minutes (two digits). Your entries will appear in the display as they are typed. If the time entry is incorrect, press the soft key under "BACK" to re-enter the time.

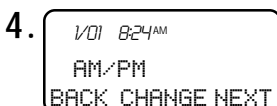
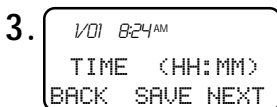
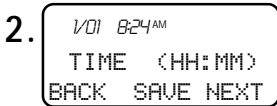

Press the soft key under "CHANGE" to toggle between "AM" and "PM".

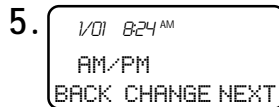

6. Use the keypad to enter the month (01-12) and day (01-31). To edit your entry, press the soft key under "BACK" to re-enter the date.

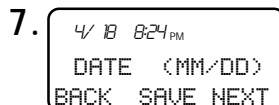

9. "INITIAL SETUP COMPLETE" will appear in the display.

INITIAL SETUP

QUICK SETUP (cont.)

VERIFYING STATION AND LINE CONFIGURATION

1. Press **LINE 1**. The LINE INDICATOR will light green and the speakerphone LED will light red.
2. The station ID will appear in the display to indicate the station is in use.
3. Dial the telephone number for line 2. The LINE INDICATOR for line 2 should flash red. If the line indicator, for the line you called, does not flash, check to make sure lines are correctly installed.
4. Repeat step 2 and call the telephone numbers for line 3 and 4.
5. If the indicators of the lines you called flashed, you have successfully installed this station!

VERIFYING SYSTEM CONFIGURATION

To verify that all stations are communicating,

1. Press and hold **PAGE ALL**.
2. "PAGING" and the station icons for all properly connected stations will appear in the Station Status Display. It may take a moment for all the icons to appear.
3. Check to see if all stations connected to line 1, appear in the display. If they did, the system is successfully configured. If all the stations do not appear in the display, note the station(s) that did not appear in the display. Go to the noted station and make sure the lines are connected and in the correct line jacks.

INSTALLATION CHECKLIST

- AC adapter is connected at stations
- Line cords have been connected
- Line 1 is common on all stations
- All stations have been assigned an extension number
- The time and date have been set at all stations

PROGRAMMING THE TELEPHONE

The unit can be customized to meet your needs.

ASSIGNING A STATION EXTENSION NUMBER

1. Press ^{PROGRAM} ● .

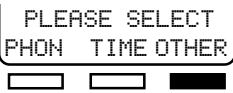
2. 

3. 

4. 

5. 

Press "CHANGE" until the chosen extension number (11-22) appears in the display.

6. 

"STATION 11 SET" will appear in the display.

NOTE:

- If another station's ID number is chosen, an error beep will be heard and "NOT AVAIL" will appear in the display. Press the soft key under "CHANGE" to select another extension number.

7. Press ^{PROGRAM} ● to exit.

SETTING THE TIME AND DATE

The LCD displays the time and day.

1. Press ^{PROGRAM} ● .

2. 

3. 

4. "TIME (HH:MM)" will appear in the display. Use the keypad to enter the hour (01-12) and minutes (00-59). Your entries will appear in the display as they are typed. If the time entry is incorrect, press the soft key under "BACK" to re-enter the time.

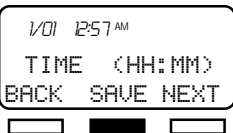
5. 

The programmed time will then appear in the display.

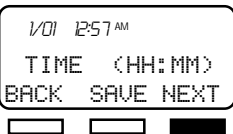
6. 

7. Press the soft key under "CHANGE" to toggle between "AM" and "PM."

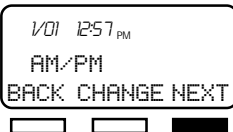
8. 

9. "DATE (MM/DD)" will appear in the display. Use the keypad to enter the month (01-12) and the day (01-31). To edit your entry, press the soft key under "BACK" to re-enter the date.

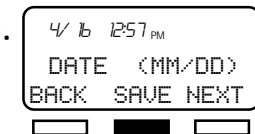
10. 

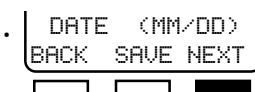
11. 

12. Press ^{PROGRAM} ● to exit.

PROGRAMMING THE TELEPHONE

SETTING A PRIVATE LINE

You must share lines 1 and 2 with all other stations in the system. However, you can create a non-square configuration as described on page 7 using lines 3 and/or 4, so that your station has different telephone number(s) from the other stations lines 3 and/or 4. More than one station can share a private line. **CONFIGURE THE LINE CORDS OF YOUR UNIT INTO THE TELEPHONE LINES YOU WANT TO USE** and follow the programming steps below.

1. Press ^{PROGRAM} ● .
2.

PLEASE SELECT
PHON TIME OTHER

█	□	□
---	---	---
3.

FLASH: 600MS
BACK CHANGE NEXT

□	□	█
---	---	---
4.

AUTODIAL SETUP
BACK ENTER NEXT

□	□	█
---	---	---
5.

RINGER SELECT
BACK ENTER NEXT

□	□	█
---	---	---
6.

AUTOANSWER: ON
BACK CHANGE NEXT

□	□	█
---	---	---
7.

ALWAYSRING: OFF
BACK CHANGE NEXT

□	□	█
---	---	---
8.

PRIV LINE: OFF
BACK CHANGE NEXT

□	█	□
---	---	---

9.

OFF
BACK SAVE ON/OFF

□	□	█
---	---	---

10.

ON: SELECT LN34
BACK SAVE ON/OFF

□	□	□
---	---	---

3 and 4 will be flashing. Use the keypad to select the line or lines that will be private. Selected numbers will be displayed and flashing.

12.

ON: SELECT LN34
BACK SAVE ON/OFF

□	█	□
---	---	---

13. Press ^{PROGRAM} ● to exit.

NOTES:

- Two or more stations can share the same private line(s), but under this condition your private line calls will always be accessible (always be privacy released) to those stations.

SETTING AUTOMATIC ANSWER

When auto answer is turned on and a station receives an intercom call, the station does not intercom ring. Instead, the speakerphone automatically answers the intercom call.

To program the auto answer feature,

1. Follow steps 1-5 above under "SETTING A PRIVATE LINE."
2. Press the soft key under "CHANGE" to toggle between "ON" and "OFF."
3. Once your selection appears in the display, press ^{PROGRAM} ● to exit.

- | |
|------------------|
| AUTOANSWER: ON |
| BACK CHANGE NEXT |
-
- | | | |
|---|---|---|
| □ | █ | □ |
|---|---|---|

PROGRAMMING THE TELEPHONE

SETTING THE OUTSIDE LINE

If you must dial an outside line to access a dial tone, you can program the phone to automatically dial the outside digit when calling a stored caller ID record.

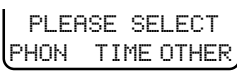
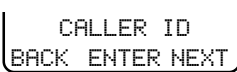
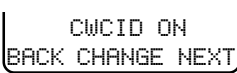
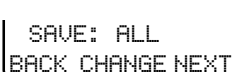
- 1.** Press ^{PROGRAM} ● .
- 2.** 
- 3.** 
- 4.** 
- 5.** 

- 6.** 

Press the soft key under "CHANGE" until the correct digit is displayed. (0 1 2 3 4 5 6 7 8 9)

NOTE:

- If an outside line is not needed, make sure there is a "-" in the display.

- 7.** When the correct outside line digit appears in the display, press "NEXT" to save.
- 8.** Press ^{PROGRAM} ● to exit.

SETTING THE AREA CODE

The area code is always included in caller ID records with telephone numbers. When your local area code is programmed into the unit and you press ^{DIAL} to call a local caller ID record, the area code is automatically removed.

If you must dial 10 or 11-digits when dialing from your area, leave the area code setting at 000. The unit will prompt you to choose between 7, 10, 11 or 8-digit dialing each time you make a caller ID call.

If you reside in a 7-digit dialing area, the unit can make returning phone calls easier by automatically dialing stored Caller ID numbers. In order for this feature to work correctly, it is necessary to program your local area code into the unit.

To program your local area code,

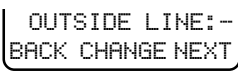
- 1.** Follow steps 1-5 above under "SETTING THE OUTSIDE LINE."
- 2.** 
- 3.** Using the keypad, enter in your three digit area code.

- 4.** 

- 5.** Press ^{PROGRAM} ● to exit.

PROGRAMMING THE TELEPHONE

SETTING THE RINGER ON/OFF BY LINE

Ringer settings for each outside line are individually controlled at each station. When the ringer is turned "ON," the line will ring when calls are received. When the ringer is turned "OFF," that line will not ring when a call is received. Whether the ringer is turned on or off, the LINE INDICATORS will operate normally.

You can determine which lines ring at your station. All four lines are factory preset to ring on the unit.

1. Press ^{PROGRAM} ● .
2.

PLEASE SELECT
PHON TIME OTHER

█	▢	▢
---	---	---
3.

FLASH: 600 MS
BACK CHANGE NEXT

▢	▢	█
---	---	---
4.

AUTODIAL SETUP
BACK ENTER NEXT

▢	▢	█
---	---	---
5.

AUTO INTERCOM
BACK ENTER NEXT

▢	▢	█
---	---	---
6.

RINGER SELECT
BACK ENTER NEXT

▢	█	▢
---	---	---

The "LINE RING" and line number will appear on the display.

7.

LINE1 RING: ON
BACK CHANGE NEXT

▢	█	▢
---	---	---

Press the soft key under "CHANGE" to toggle between turning the ringer "ON" or "OFF" for the selected line.

8.

LINE1 RING: OFF
BACK CHANGE NEXT

▢	▢	█
---	---	---

Press the soft key under "NEXT" to advance to the next line selection.

9. Repeat steps 7 and 8 until all lines have been programmed.

10. Press ^{PROGRAM} ● to exit.

ALWAYS RING

ALWAYS RING is set to OFF by default. If you want to hear the phone ring when you are on another line using the handset or the headset, change this setting to ON.

The telephone will NEVER ring while you are on another line using the SPEAKERPHONE, regardless of the setting of ALWAYS RING to prevent the other party from hearing the phone ring.

1. Follow steps 1-5 above under "SETTING THE RINGER ON/OFF BY LINE."

2.

RINGER SELECT

▢	▢	█
---	---	---
3.

AUTOANSWER: ON
BACK CHANGE NEXT

▢	▢	█
---	---	---

4.

ALWAYSRING: OFF
BACK CHANGE NEXT

▢	█	▢
---	---	---

5. Press ^{PROGRAM} ● to exit.

PROGRAMMING THE VOLUME

RINGER VOLUME

The ringer volume can be set to HI, LOW or OFF. The ringer volume is factory pre-set to HIGH. The ringer volume switch is located on the back of the unit. To adjust the ringer volume, move the ringer volume switch to the desired position. When the ringer volume is turned off, the unit will not ring when a call is received.



You can individually set the volume level for the handset/headset and speaker. When using or switching applications, the set volume level is automatically adjusted.

HANDSET VOLUME

While using the handset:

1. Press to adjust the handset volume.
VOLUME
2. As the volume is adjusted, 1-4 bars will appear on the LCD to visually display the handset volume level. (1 bar representing low and 4 bars representing high volume.) The volume setting will remain at this level until it is changed or a power failure occurs.

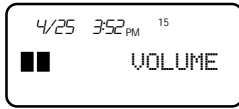

SPEAKERPHONE / INTERCOM VOLUME

When using the speakerphone/intercom or when the phone is in standby mode,

1. Press to set the speakerphone volume to the desired level.
VOLUME
2. As the volume is adjusted, 1-8 sets of bars will appear to visually display the volume level on the LCD. The volume setting will remain at this level until it is changed or a power failure occurs.

HEADSET VOLUME

While using the headset:

1. Press to adjust the headset volume.
VOLUME
2. As the volume is adjusted, 1-4 bars on the LCD will appear to visually display the headset volume level. (1 bar representing low and 4 bars representing high volume.) The volume setting will remain at this level until it is changed or a power failure occurs.

PROGRAMMING AUTODIAL

Each unit in the system can store up to 20 autodial numbers. Ten 16-digit numbers can be accessed with the autodial key and ten additional entries using the lower register key followed by the autodial key. Each autodial entry can have up to 16 digits and can have 14 characters for the name. Once a number has been stored in an autodial location, press the selected autodial location key to have the unit automatically dial the programmed number.

AUTODIAL CARD

Remove the autodial card. Write down the names and/or telephone numbers associated with the stored speed dial numbers and replace the autodial card and plastic cover. An extra autodial card is provided for your convenience.

Home	--	□
Car	--	□
Bank	--	□
Joe Client		□
Direct Line		□
Agency	--	□
Sue Smith		□
--	--	□
--	--	□
--	--	□
--	--	□
--	--	□
LOWER		□

PROGRAMMING

Autodial numbers can be programmed in two ways:

PROGRAMMING A CALLER ID RECORD INTO AUTODIAL

To enter a caller ID record from your directory into an autodial location:

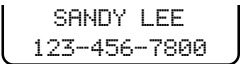
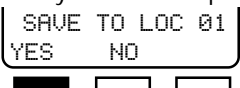
- Press **CALLER ID**.

 - Press the < or > soft keys to scroll through records.
 - When the caller ID record you want to store into autodial appears in the display, press and hold the selected autodial key location.
 - After you hear a beep:

 - The telephone number of the caller ID record will appear in the display. Press "NEXT" to accept the number. (To edit the number, see page 19 "EDITING AUTODIAL ENTRIES.")
NOTE:
 ■ Include the outside line digit if one is needed to dial.
 - The caller ID name will now appear in the display. Press the soft key under "SAVE" to store the name and number. (To edit the name, see page 19 "EDITING AUTODIAL ENTRIES.")
 - Press **PROGRAM** to exit.
- NOTE:**
 ■ Only the first 14 characters of a Caller ID NAME will be transferred to the autodial location.

PROGRAMMING AUTODIAL

ENTERING AUTODIAL RECORDS

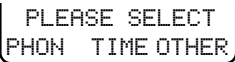
To manually enter a name and number into autodial,

1. Press  .

2. 

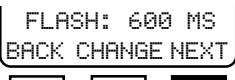
3. 

4. 

5. Press the soft key under "NEXT" to select an autodial location (01-20).



6. 

7. If a number has not already been programmed, "<NUMBER>" will appear in the display. Use the keypad to enter the autodial number, up to 16 digits. *, #, and **FLASH** can be entered as well. If the number is entered incorrectly, press the soft key under "<" to move the cursor left and the soft key under "DEL" to remove digits. Use the keypad to re-enter the correct digits.

NOTE:

■ Include the outside line digit if one is needed to dial out of the system.

8. 

9. 

Use the keypad to enter the name, up to 14 characters. Pressing a key once will display the first letter on that key. Pressing it repeatedly will cycle through all the characters on the key.

NOTE:

■ Pressing the 1 key will add a space.

10. When the desired letter appears in the display, press the soft key under "NEXT" to move the cursor to the right.



11. Repeat steps 8 and 9 until the name is entered.

12. 

13. Repeat steps 4 through 11 to program the remaining autodial numbers.

14. Press  to exit.

PROGRAMMING AUTODIAL

EDITING AUTODIAL ENTRIES

To edit a name or number in autodial,

1. Follow steps 1-4 under "ENTERING AUTODIAL RECORDS" on page 18.

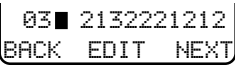
2. 

3. 

The programmed autodial number will appear in the display. To alter the autodial number, press the soft key under "<" to move the cursor left and the soft key under "DEL" to remove digit. Repeat as necessary.

4. Use the keypad to re-enter the correct digits.

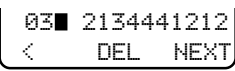
5. 

6. 

Press in combination, the soft key under "<" to move the cursor left and the soft key under "DEL" to remove characters.

7. Use the keypad to enter the correct letter, up to 14 characters. Pressing a key once displays the first letter on that key. Pressing it repeatedly will cycle through all the characters on the key. When the desired letter appears in the display, press the soft key under "NEXT" to move the cursor to the right.

8. Repeat step 7 until the name is entered.

9. 

The next autodial station will appear in the display.

10. Repeat steps 2 through 9 to edit the remaining autodial numbers.

11. Press  to exit.

AUTODIAL PAUSE

When programming numbers in autodial, a two-second pause can be inserted to use with telephone banking, long distance or PBX services.

When a pause needs to be included in an autodial entry,

1. Press .
PAUSE

A "P" will appear on the display to indicate a two-second pause has been added.





PROGRAMMING AUTODIAL

SETTING THE FLASH DURATION

Centrex, PBX and telephone company services infrequently require a specific flash duration different from the default of 600ms. The unit supports flash durations from 100ms (milliseconds) to 1,000ms in 100ms increments.

1. Press ^{PROGRAM} ● .

2. 
PLEASE SELECT
PHON TIME OTHER
█ □ □

3. 
FLASH: 600 MS
BACK CHANGE NEXT
□ █ □

Press CHANGE until the MS you want appears in the display.

4. Press ^{PROGRAM} ● to exit program mode.

PROGRAMMING CALL WAITING CALLER ID

CALL WAITING CALLER ID SERVICE OPTIONS

Caller ID

Caller ID is a subscription service offered by your local telephone company. The local time, date and the caller's name and phone number, if available, will be displayed on the LCD, allowing you to choose to answer the call or not. Caller ID information is sent after the first ring.

Call Waiting

Call Waiting is a subscription service offered by your local telephone company. When you are on the line and another call comes in, a beep is emitted over the line. You can continue speaking to the first caller or, by pressing **FLASH**, you can toggle to speak to the second caller.

Call Waiting Caller ID

If you subscribe to call waiting caller ID service and you are on the line, the local time and the caller's name and phone number, if available, will appear in the display. You can then choose to answer the call by pressing **FLASH** to toggle to the incoming call or let the incoming call continue to ring.

"BLOCKED" and "UNAVAILABLE" Messages

If callers choose to partially or completely "block" their caller ID information from being broadcast, a message will appear on the display indicating that the name and/or telephone number has been blocked. The time and date of the call will still appear in the display.

If, for any reason, the name and/or number information is currently not available from your local telephone company, an "UNAVAILABLE" message will appear in the display. The time and date of the call will still appear in the display.

CALLER ID

All common line stations will display the incoming call's caller ID record.

Three Caller ID Options

Up to 140 of the most recent caller ID records can be retained (stored) corresponding to the following programming selection:



1. **ALL** All call records will be retained.
2. **UNANSWER** Records for calls transferred to your station and not answered by the user will be retained in the station directory.
3. **ANSWER** When you or your station answers a call, the caller ID record will be stored.

PROGRAMMING CALL WAITING CALLER ID

SELECTING WHICH CALLER ID RECORDS ARE SAVED

If you subscribe to any caller ID service, caller ID data will be displayed on the unit's LCD when the call is received. The save feature allows you to decide which displayed records will be saved in unit memory. The save feature is factory pre-set to "SAVE: ALL" (all calls will be recorded in the caller ID directory). The unit can save the most recent 140 caller ID records.

PROGRAMMING

1. Press ^{PROGRAM} ● .
2. 
3. 
4. 



5. 

Press the soft key under "CHANGE" to toggle between "ANSWER," "ALL" and "UNANSWER."

6. When your selection appears in the display, press ^{PROGRAM} ● to exit.

TURNING CALL WAITING CALLER ID ON

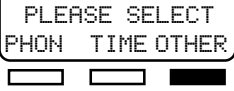
If you subscribe to call waiting caller ID, the caller ID data from an incoming call can be displayed even when you are on another call. The call waiting caller ID feature is factory pre-set to "OFF." If you subscribe to a call waiting caller ID service, you can turn the unit's caller ID feature on.

1. Press ^{PROGRAM} ● .
2. 
3. 
4. 

5. 

Press the soft key under "NEXT" to save the selection.

6. Press ^{PROGRAM} ● to exit.

TELEPHONE OPERATION

OFF HOOK OPTIONS

HEADSET OPERATION

The unit has an RJ11 headset jack, allowing you the convenience of connecting a headset. At anytime during the conversation, you can press **SPEAKER** or lift the handset to use the speaker or handset.

1. Insert the RJ11 plug into the headset port, located on the left side of the unit.
2. Press **HEADSET ANSWER** to answer or hang up a call.



NOTE:

- If your headset uses a 2.5 mm jack, you will need to purchase a headset jack adapter.

SPEAKERPHONE OPERATION

The unit features a digital speakerphone, designed to adapt to the acoustic environment for clear conversations on both sides.

At anytime during a conversation, you can press **HEADSET ANSWER** or lift the handset to switch from using the speakerphone. Likewise, when you are using the headset or the handset, simply press the speakerphone and return the handset to the cradle to begin using the speakerphone.

To use the speakerphone or to answer a call,

1. Press **SPEAKER**.
2. Speak in the direction of the unit.
3. Press **SPEAKER** again to hang up.

CALL DURATION TIME

The hour, minutes and seconds of each call received or made are automatically displayed in the LCD during your conversation. This feature is especially helpful for call accounting and controlling long distance usage.

NOTE:

- The timer resets for every call, and once that call cannot be recalled.

A rectangular LCD display showing the call duration '00:08:26' in a digital font.

you hang up from a call, the duration of

TELEPHONE OPERATION

ANSWERING CALLS

LINE SELECTION

Lines can be automatically or manually selected.

AUTOMATIC LINE SELECTION

The priority of lines is in numerical order. For instance, LINE 1 has priority, followed by LINE 2, LINE 3 and LINE 4. If LINE 1 is in use, LINE 2 will be accessed if the handset is picked up. If LINE 1 and LINE 2 are in use, LINE 3 will be accessed, and so on. In addition, if two lines are ringing and you lift the handset, the line priority above still applies.

1. Lift the handset.
2. The unit will access the available line.

You will hear a beep:

- If you press the line button of a call in use where privacy has not been released, or
- If you press a line button where a line is not connected, or
- If all lines are in use, and you pick up the handset, you will hear an error beep and "ALL LINES IN USE" will appear in the display.

MANUAL LINE SELECTION

1. Lift the handset.
2. Press the desired LINE button, for example **LINE 2**.

You will hear a beep:

- If you press the line button of a call in use where privacy has not been released, or
- If you press a line button where a line is not connected, or
- If all lines are in use, and you pick up the handset, you will hear an error beep and "ALL LINES IN USE" will appear in the display.

ANSWERING CALLS

If you subscribe to any type of caller ID service from your local telephone company, the name and phone number (if available) of the caller will appear in the display within the first two rings.

When the phone rings and the LINE INDICATOR rapidly flashes:

Using the Handset,

1. Lift the handset. The unit will automatically answer the first ringing line.
2. To hang up, return the handset to the cradle.

Using the Speakerphone,

1. Press **SPEAKER**. The unit will automatically answer the ringing line.
2. To hang up, press **SPEAKER**.

Using the Headset,

1. Press **HEADSET ANSWER**. The unit will automatically answer the ringing line.

TELEPHONE OPERATION

ANSWERING CALLS (cont.)

2. To hang up, press **HEADSET ANSWER**.

ANSWERING A CALL ON ANOTHER LINE DURING A CONVERSATION

When you are speaking with a caller on an outside line and another call is received on another line, you will see the LINE INDICATOR flash. If you have ALWAYS RING on, you will also hear ringing on that line (see page 15). To answer the other call:

1. Press **HOLD PAUSE** to place the caller you are speaking with on hold. The LINE button of the call you place on hold will flash green.
2. Press the LINE button of the ringing call and begin speaking with the caller. The LINE INDICATOR will turn from a flashing red to a solid green.
3. To return to the first caller on hold and hang up with the second call, press the LINE button of the holding call. The second line will automatically be disconnected.
4. Begin speaking with the first caller who has been released from hold.

ANSWERING A CALL WAITING CALLER ID CALL

If you subscribe to a call waiting caller ID service from your local telephone company, the unit can receive a caller ID record while you are on the line with another party.

1. If a second call comes in while you are on the phone you will hear a beep.
2. The caller ID data of the caller will appear in the display.
3. Press **FLASH** if you want to answer the call waiting call or ignore the second call and continue with the first call.

NOTE:

- Call waiting caller ID can be seen on the auto attendant station, however, a station will only receive call waiting caller ID if off hook and another call comes in on that line.

MAKING CALLS

The unit enables users three ways to get a dial tone and hang up:

Method	Getting a Dial Tone	Hang Up
Handset	Lift the handset.	Return the handset to the cradle.
Headset	Press HEADSET ANSWER .	Press HEADSET ANSWER .
Speakerphone	Press SPEAKER .	Press SPEAKER .

The owner's guide primarily uses examples using the handset to operate features and functions. However, the headset and speakerphone may also be used. Please refer to the chart above.

TELEPHONE OPERATION

MEMORY STORAGE

MAKING A CALL USING CALLER ID

Making a call if you have set your area code to "000" (See page 14)

1. Press **CALLER ID**.
2. Press the < or > display soft key to scroll through records.
3. Press **PROGRAM** to select 7, 10, 11 or 8 digit dialing.
4. Go off-hook using the handset, headset or speakerphone
5. Press **DIAL** to dial according to the selected method.

OR

4. Press **DIAL**. The unit will automatically activate the speakerphone and begin dialing according to the selected method.

NOTES:

- If you have programmed your local area code into the unit before using this feature, then the unit will not prompt you for different dialing options. See "Setting the Area Code" page14 for more information.
- If you wish to cancel your call (to exit dialing mode), press **CALLER ID**.

DISPLAY REDIAL

This feature allows you to view the contents of redial memory before dialing the number. This feature is useful when you are not sure what number was dialed last.

1. While on-hook, press **REDIAL** / **AUTO REDIAL**.
2. The telephone number that was dialed last will display in the LCD for you to review.

If you want to dial the number displayed,

1. Lift the handset.
2. Press **DIAL**.
3. End the call by returning the handset to the cradle.

MEMORY DIAL

If there is a number that you will be calling frequently for a short period of time and you do not want to program it into an Autodial location, MEMORY DIAL can be used to store this number.

1. While On-Hook, enter the number you wish stored for a short period of time.
2. Press **MEMORY DIAL**. A beep will sound and the display will clear.

TELEPHONE OPERATION

MEMORY STORAGE (cont.)

MEMORY DIAL (cont.)

To dial a MEMORY DIAL number:

1. Press **MEMORY DIAL**. The stored number will be displayed.
2. Press **DIAL**. The unit will go off-hook in speakerphone mode and dialing will commence.

OR

1. Go off-hook using the handset, headset or speakerphone.
2. Press **MEMORY DIAL**. The number will be displayed and dialing will commence automatically.

The number stored in MEMORY DIAL will remain there until replaced with a new number.

REDIAL

The unit remembers the last number dialed and will automatically redial that number.

1. Pickup the handset.
2. Press **REDIAL**. The last number dialed will appear in the display and the unit will automatically redial the number.
3. Return the handset to the cradle to end the call.

AUTO BUSY REDIAL

Auto busy redial automatically redials a busy line up to 10 times, at 10 second intervals. If the line is still busy after 4 minutes, the unit will return to the idle mode. Automatic busy redial can be canceled anytime by pressing **REDIAL** again.

Once you get a busy signal:

1. Hang up.
2. Press **REDIAL** twice. The unit will attempt to redial the number for 15 seconds and the SPEAKERPHONE INDICATOR will flash rapidly.
3. The SPEAKERPHONE INDICATOR will then flash slowly for 10 seconds before attempting to redial the number.
4. The unit will redial the busy line up to 10 times or until the call is answered.
5. Press **SPEAKER** to end the auto redial and begin speaking.
6. Return the handset to the cradle or press **SPEAKER** to end the call.

TELEPHONE OPERATION

MEMORY STORAGE (cont.)

NO ANSWER REDIAL

No answer redial automatically redials an unanswered line up to 10 times, at 30 second intervals. If no one answers the line after 4 minutes, the unit will return to the idle mode. Automatic no answer redial can be canceled anytime by pressing **REDIAL** again.
AUTO REDIAL

Once you make a call where no one answers:

1. Hang up.
2. Press **REDIAL** twice. The unit will attempt to redial the number for 15 seconds and the SPEAKERPHONE INDICATOR will flash rapidly.
AUTO REDIAL
3. The SPEAKERPHONE INDICATOR will then flash slowly for 10 seconds before attempting to redial the number.
4. The unit will redial the unanswered line up to 10 times or until the call is answered.
5. Press **SPEAKER** to end the auto redial and begin speaking.
6. Return the handset to the cradle or press **SPEAKER** to end the call.

REVIEWING AUTODIAL ENTRIES

To review stored autodial entries,

1. Press an AUTODIAL STATION key.
2. The name and/or number programmed in the chosen autodial location will appear on the display. The screen will return to the default screen after thirty seconds.

DIALING STORED AUTODIAL NUMBERS

1. Pick up the handset.
2. Press the AUTODIAL STATION key of the number you want to speed dial.
3. The unit will automatically dial the number displayed.
4. To hang up, return the handset to the cradle.

TELEPHONE OPERATION

MEMORY STORAGE (cont.)

STORING A SCRATCH PAD NUMBER

While on-hook or off-hook, the scratch pad is a location where you can temporarily store a number. The number you enter into the scratch pad will remain there until another number is entered.

To store a number in scratch pad memory.

1. Press **SCRATCH PAD**. "SCRATCH PAD" will appear in the display.
2. Enter the number you want to temporarily store in this location, using the keypad.
3. Press **SCRATCH PAD** again. The unit will beep to indicate the number entered has been saved and the LCD will return to the standby display.

DIALING A SCRATCH PAD NUMBER

To dial a number stored in the scratch pad memory,

1. Lift the handset.
2. Press **SCRATCH PAD**.
3. Press **DIAL**.
4. The number will automatically be dialed.

DISPLAY AND DIAL NUMBER

To display a number prior to dialing the number,

1. Use the keypad to dial a number.
2. The telephone number will appear in the display as it is entered.
3. Lift the handset.
4. Press **DIAL** to dial the displayed number.

TELEPHONE OPERATION

HOLD

Any station can place a call on hold and any station can take a call off hold. Once a call on hold has been seized, the call returns to a private state (except after another station has hung up during a conference call). (See "CALL PRIVACY" on page 32.)

1. Press **HOLD** PAUSE to place a call on hold. The solid green line indicator will slowly flash at your station to indicate the call is holding. Other stations will see the line indicator slowly flashing in red.
2. Any station may press the LINE button of the holding call and speak to the caller. The call will then return to a private call state, where other stations cannot join the call. Once a station takes a call off hold, that station's line indicator will turn solid green.

AUDIBLE HOLD REMINDER

Audible hold reminder is designed to prevent calls from accidentally being placed on hold for long durations of time. Audible hold reminder automatically alerts the station that placed the call on hold that the call has been unattended for more than three minutes. Once the call has been placed on hold for over three minutes, the LINE INDICATOR will flash rapidly and the unit will beep three times every 30 seconds until the call is taken off hold. If a call has been on hold for eight minutes, the holding call will be automatically disconnected.

MUTE

Whether you use the headset, handset or speakerphone, mute temporarily disables the microphone of your phone or headset so the calling party cannot hear any noise on your side. You, however, are still able to hear the calling party.

To initiate the mute feature during a conversation,

1. Press **MUTE**. Mute indicator will light.
2. Press **MUTE** again to end the mute feature and the indicator will turn off.

NOTE:

- If a call is muted, by pressing the INTERCOM, LINE or HOLD button or hanging up, the mute feature is canceled.

DO NOT DISTURB (DND)

The do not disturb feature is especially beneficial when you do not want to be disturbed by pages, transferred calls, intercom calls or incoming calls. When DND is turned on, the station will not accept any transferred calls, incoming calls, pages, or intercom calls.

To turn DND on:

1. Press **DO NOT DISTURB** "DND" will appear in the display.

To turn DND off:

1. Press **DO NOT DISTURB** again. "DND" will disappear from the display.

TELEPHONE OPERATION

TRANSFERRING CALLS

The unit enables calls to be answered and then transferred to another station in the system. When a call is transferred to another station, that call's caller ID data is also transferred.

NOTE:

- The most recent caller ID record your station received is transferred with the call.

Other Transfer Display Messages

MESSAGE	STATUS	ACTION
INVALID ID	Either your station has been entered or a non-existing station number has been entered, i.e. 32.	Enter a valid station number, 11-22.
UNABLE TO CALL	Do Not Disturb (DND) is turned on at the receiving station, the station may not exist or the station is on another intercom call. Check the display for the station icon.	The call cannot be transferred to this station at this time.
CALL TRANSFER	Call has been transferred to the receiving station.	You can hang up.

TELEPHONE OPERATION

BLIND CALL TRANSFER

Blind transfer allows you to transfer a call directly to another station without announcing it to the other station.

After a call is answered,

1. Press ^{TRANSFER} **[REDACTED]**. The call is automatically placed on hold.
2. "EXT. ???" will appear in the display. Enter the extension of the station you want to transfer the call.
3. "CALL TRANSFER" will appear in the display.
4. The call has been transferred. Hang up.

TELEPHONE OPERATION

TRANSFERRING CALLS (cont.)

ATTENDED CALL TRANSFER

To announce that you will be transferring a call or to see if the person you want to transfer the call to is available, after the call is answered,

1. Press **HOLD PAUSE**.
2. Press **INTERCOM**.
3. When "EXT. ?? " appears in the display, enter the extension number of the station you want to speak with.
4. "INTERCOM CALL" and the receiving station's extension will appear in the display.
5. When you hear a beep, advise them that you will be transferring a call.
6. Press the flashing green LINE of the call you want to transfer.
7. Press **TRANSFER**.
8. When "EXT. ?? " appears in the display, enter the extension number of the station you want to forward the call.
9. "CALL TRANSFER" will appear in the display.
10. The call has been transferred. Hang up.

TELEPHONE OPERATION

CALL PRIVACY AND CONFERENCE CALLING

CALL PRIVACY

Call privacy prevents other stations from picking up a line in-use by another station, unless the talking station releases privacy. When you make or answer a call, you automatically have privacy. Once a call is placed on hold, privacy is released until the call is picked up from hold.

- Go off hook to make a call Private
- Receiving an incoming call Private
- Holding call was transferred to your station Private
- Picking up a holding call Privacy released while call is holding only
- CONFERENCE button was pressed on a call Privacy released
- CONFERENCE button was pressed again Privacy restored
- CONFERENCE button was pressed to join calls Privacy released
- CONFERENCE button was pressed at your station after the other station joined in the conference call hangs up Privacy restored

NOTE:

- If any standard telephone is connected to the same line(s) as an unit, the standard phone can always access the unit's phone call (the unit calls are privacy released to standard phones). Alternatively, an unit can access a standard phone's calls once the standard phone has been on a call for at least 7 seconds.

TELEPHONE OPERATION

CALL PRIVACY AND CONFERENCE CALLING (cont.)

CALL PRIVACY RELEASE

At any time during a conversation you can release privacy on a call to allow one other station to join the call.

During a conversation,

1. Press **CONFERENCE**. "PRV RELEASED" will appear in your display.
2. The line INDICATOR of the privacy released call will flash red at other stations in the system, indicating that any station in the system can pick up the privacy released line by pressing the LINE button.

NOTE:

- It is possible for more than one station to seize the same line simultaneously, say if two extensions try to select line 1 or answer a call on line 1 at the exact same moment. When this happens, privacy to other stations remains intact and one or the other party should surrender the line.

CONFERENCE CALLING WITH TWO OUTSIDE LINES

Conference calling allows a station to call two phone lines to initiate a three-way conversation. Once a call conference with two lines has been established, other stations in the system may not join the conference call.

Once you make a call or answer a call,

1. Press **HOLD** PAUSE to place the caller on hold. The LINE INDICATOR will flash green.
2. Make or answer a call from another line.
3. Press **CONFERENCE**.
4. The LCD will display "PRV RELEASED."
5. Press the LINE button of the call on hold.
6. The conference call has been established and you may begin speaking to both parties.
7. To end the conference call, hang up and both parties will be disconnected.

OR

If you want to continue speaking with one of the calling parties,

7. Press the LINE button of the caller you want to maintain a conversation with and the other caller will be disconnected.

TELEPHONE OPERATION

CALL PRIVACY AND CONFERENCE CALLING (cont.)

PRIVATELY TALKING TO ONE OF THE CONFERENCE CALL PARTIES

If you need to interrupt the conference call to speak privately to one of your conference call parties,

1. Press **HOLD** PAUSE to place both calls on hold.
2. Press the LINE button of the call you want to privately speak with.

When you want to continue with the conference call,

3. Press **CONFERENCE** while on the line with the call you are privately speaking to.
4. The LCD will display "PRV RELEASED."
5. Press the LINE button of the call on hold and the conference call is resumed.

CONFERENCE CALLING WITH ONE OUTSIDE LINE AND TWO STATIONS

At anytime in a conversation, you can press **CONFERENCE** and release privacy so one other station can join your call.

1. Intercom a station and let them know you will be making a call on a specific line and when they see that line's indicator flash slowly, they can press the line key to join the conversation.
2. Make or answer a call.
3. Press **CONFERENCE**.
4. The LCD will display "PRV RELEASED."
5. One other station in the system can now join the call by pressing the slowly flashing, privacy released line key.
6. "CALL JOINED" will appear on that station's display and the LINE INDICATOR of the conference call will turn green on that station. That station is automatically joined in the call.
7. Return the handset to the cradle to have your station exit the call.

NOTE:

- If one station exits a call, the other station can re-establish privacy on that call by pressing **CONFERENCE**. "PRIVACY RESTORED" will appear in the display.

INTERCOM & PAGING OPERATION

Intercom allows you to call another station in the system without tying up an outside line. The unit has two intercom channels, so two 2-way intercom conversations can occur at the same time. If auto answer is turned on, and you receive an intercom call, the station will beep and the intercom is instantly connected. If auto answer is not turned on, the station being intercommed will begin ringing with a unique intercom ring.

NOTE:

- To make an intercom call, stations must have a common line 1.

INTERCOM DISPLAY MESSAGES

MESSAGE	STATUS	ACTION
INVALID ID	Either your station has been entered or a non-existing station number has been entered, i.e. 32.	Enter a valid station number, 11-22.
UNABLE TO CALL	Do Not Disturb (DND) is turned on at the receiving station.	Try intercomming this station at another time.
INTERCOM CALL	Initiating an intercom call.	After the beep, begin speaking.

MAKING AN INTERCOM CALL USING THE SPEAKERPHONE

1. Press **INTERCOM**. The INTERCOM and SPEAKER INDICATORS will light.
2. The LCD will display "EXT ??". Enter the station number (11-22) of the station you want to intercom.

NOTE:

- If "INVALID ID" or "UNABLE TO CALL" appears in the display, see actions under "INTERCOM DISPLAY MESSAGES" above.

3. "INTERCOM CALL" and the extension of the station you are calling will appear in your display, while the station you are intercomming will see your station ID.
4. Once the caller answers, begin talking.
5. To end the intercom conversation, press **INTERCOM** again or **SPEAKER**.

INTERCOM & PAGING OPERATION

MAKING AN INTERCOM CALL USING THE HEADSET OR HANDSET

1. Lift the handset or press **HEADSET ANSWER**.
2. Press **INTERCOM**. The INTERCOM INDICATOR will light.
3. The LCD will display "EXT ??". Enter the station number (11-22) of the station you want to intercom.

NOTE:

- If "INVALID ID" or "UNABLE TO CALL" appears in the display, see actions under "INTERCOM DISPLAY MESSAGES" on page 35.
4. "INTERCOM CALL" and the extension of the station you are calling will appear in the display.
 5. Once the caller answers, begin talking.
 6. To end the intercom conversation, press **HEADSET ANSWER**, or return the handset the cradle.

ANSWERING INTERCOM CALLS WHEN AUTO ANSWER IS ON

When Auto Answer is turned on, the station receiving the intercom call will automatically answer the call using the speakerphone.

1. After you hear a beep, the INTERCOM and SPEAKER INDICATORS light.
2. The speakerphone will automatically turn on.
3. Begin speaking to the intercom party. Use the speakerphone or pick up the handset for privacy.
4. Hang up by pressing **INTERCOM**.

ANSWERING INTERCOM CALLS WHEN AUTO ANSWER IS OFF

When the station begins to intercom ring, the INTERCOM INDICATOR will begin to flash and the station paging you will appear in the display.

1. Press **INTERCOM** to answer the call using the speakerphone. The INTERCOM INDICATOR will stop flashing.
2. The SPEAKER INDICATOR will light and you may begin speaking.
3. Hang up by pressing **INTERCOM**.

INTERCOM & PAGING OPERATION

ANSWERING INTERCOM CALLS WHEN YOU ARE ON THE LINE

To answer an intercom call during a conversation:

1. The station will intercom ring once and the INTERCOM INDICATOR will begin to flash.
2. Press **INTERCOM**. The INTERCOM INDICATOR will stop flashing.
3. Your call is automatically placed on hold and you may begin speaking to the intercom party.
4. To end the intercom conversation and resume talking to the caller on hold, press the holding LINE button and begin speaking.

ALL STATION PAGE

The unit allows you to page all stations in the system at one time. Only stations with a common line 1 are able to utilize the page feature. Stations that are off hook or have Do Not Disturb on will not receive the page, so check to see if any station icons appear in the display.

1. Press and hold **PAGE ALL**. A beep is heard and "PAGING" appears in your display. The display of the stations you are paging will state "EXT 22 PAGING."
2. Begin speaking using the handset or the hands-free microphone to broadcast your page.
3. Release **PAGE ALL** to end the page.

ROOM MONITOR

Room monitor allows you to activate the speakerphone of another station, provided that the station is set to "AUTO ANSWER".

1. Press **INTERCOM**.
2. "EXT. ???" will appear in the display.
3. Enter the extension number of the station's room you want to monitor.
4. "INTERCOM CALL" will appear on your display. If auto answer is on, the unit of the station you are intercomming will beep and your extension number will appear on its display.
5. Press **MUTE**.
6. Return the handset to the cradle, press **HEADSET ANSWER**, **SPEAKER** or **INTERCOM** to end room monitoring.

CALL WAITING CALLER ID

REVIEWING AND DELETING STORED CALLER ID RECORDS

The unit will store up to 140 of your most recent caller ID records. Any received caller ID information (name, telephone number, date and time) is stored for your reference, depending on your station setting of ALL, ANSWER or UNANSWER (see page 22). Caller ID records are stored in reverse order of time and date. If memory becomes full, the newest entry will be saved and the oldest record erased.

To review caller ID records,

1. Press . The most recent caller ID record will appear in the display.
2. Press the > button to scroll through the oldest records.
3. Press the < button to scroll through the newest records.
4. Press the DEL button to delete the current record. Select "YES" to delete this record, "ALL" to delete all saved records, or "NO" to abort and save.

CALLER ID TRANSFER

When a call is transferred from one station to another, that call's caller ID data is also transferred. The most recently received caller ID record will be transferred with the call.

ADDITIONAL INFORMATION

BATTERY INSTALLATION

Install four AA alkaline batteries (not included) into the bottom side of the base to enable the telephone to operate up to 1 hours during a power failure. Batteries are not necessary for the unit to operate and retain stored data with AC power.

1. Turn the unit over and remove the mounting pedestal if attached.
2. Remove the battery cover.
3. Install four AA alkaline batteries. Make sure the ribbon lies under the batteries and the batteries are in the correct directions.
4. Replace the cover.

ADDITIONAL INFORMATION

WALL MOUNTING PEDESTAL

The unit can easily be wall mounted by following these instructions.

1. Install two screws into the wall using the template, on this page, as a guide.

NOTE:

■ Purchase wood screws, round head, brass, size #10, 1 ¼ inch in length.

2. Remove the mounting pedestal from the desk mount position.
3. Thread the AC adapter cord and line cords through channels on the bottom of the unit.
4. Snap the pedestal bracket, with the narrow end of the wedge pointing upward, into the bottom four wall mount ports and push up to lock in place.
5. Attach the telephone to the wall.

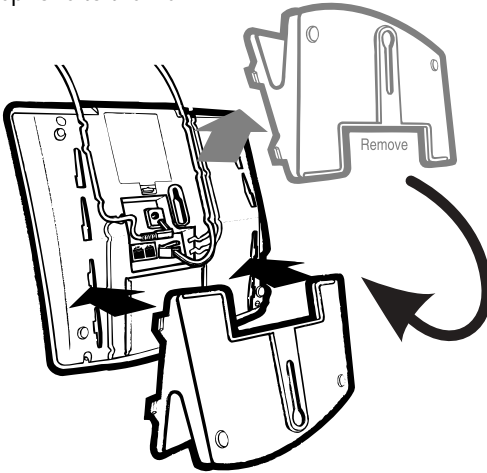

T

E

M

P

L

A

T

E



DESK TOP PEDESTAL

1. Remove the mounting pedestal from the desk mount position.
2. Thread the AC adapter cord and line cords through channels on the bottom of the unit.
3. Snap the pedestal bracket, with the narrow end of the wedge pointing downward, into the top four wall mount ports and push up to lock in place.
4. Place the telephone on the desk.

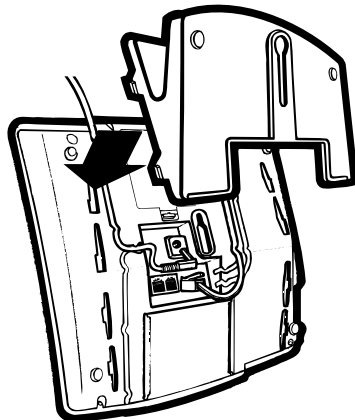

ADDITIONAL INFORMATION

POWER FAILURE OPERATION

NOTE: 4 AA Alkaline batteries must be installed for power failure operation.

During a power failure with good batteries installed, the 410 will allow outgoing calls, dialed in pulse mode ONLY, on line 1. Incoming calls will not ring on any line and all system features will be shut down. Tone (DTMF) interaction with other network and non-network services such as banking, voice mail, etc., will not be available until power is restored.

PERMANENT MEMORY PROTECTION

Programmed information such as caller ID records, autodial entries and station ID are all stored on the unit's memory indefinitely, or until you choose to completely reset the system

SHORT TERM MEMORY

In a power failure, the time and date setting will be maintained for up to 1 hour, if batteries are installed. See "BATTERY INSTALLATION" on page 38.

PERFORMING A SYSTEM UPDATE

When a system update is performed, it updates the status of all the stations in the system. A system update should be performed when removing a station from the system.

To perform a system update:

1. Press ^{PROGRAM} ● .

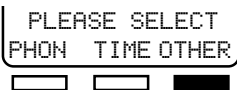
2. 

3. 

4. 

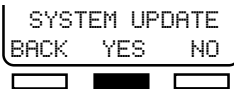
5. 

"UPDATING NOW" will appear in the display.

6. When the update has completed, "FINISHED" will appear in the display.

7. Press ^{PROGRAM} ● to exit.

STATION RESET

If line conditions cause communication errors between station, units may need to be reset as a remedy. A reset will not erase any stored data except day and time.

To reset a station,

1. Take the tip of a pen and insert it into the small opening on the back of the unit labeled "RESET."
2. You will hear a click and the display and station LEDs will briefly turn off and then back on.

All data and system information will be retained (except day and time) and network communication will be restored.

ADDITIONAL INFORMATION

DISPLAYS

DISPLAYED MESSAGE	STATUS	ACTION
ALL LINES IN USE	Tried to access a line when all lines were in use.	Try a little later.
BLOCKED	This caller blocked their caller ID record.	See "CALL WAITING CALLER ID SERVICE OPTIONS" on page 21.
CALL JOINED	Station has joined a conference call.	See page 34.
CALL TRANSFER	Station is transferring a call.	See page 32.
CALLER ID NO DATA	 was pressed and there are no records.	You may not subscribe to caller ID. See "PROGRAMMING CALL WAITING CALLER ID" section on pages 21-22.
EXT. ??	The displays prompts you to press the AUTO INTERCOM key corresponding to the station number or enter the station number of the unit you want to transfer a call to or intercom.	Press an AUTO INTERCOM key or use the keypad to enter two-digit ID of the station you want to transfer a call to or intercom.
INPUT CORRECT DATA	The incorrect data was entered during time and date setup.	Re-enter the correct time and date. See page 12 under "SETTING THE TIME AND DATE."
INTERCOM CALL	Station has initiated an intercom call.	See pages 35-36.
INVALID ID	Your station ID or a non-existing station was entered.	Enter the correct station ID. See "INTERCOM & PAGING OPERATION" on page 35.
LOWER	The LOWER button on the autodial bank has been pressed.	When "LOWER" appears on the display press an autodial station to access lower autodial stations. See "PROGRAMMING AUTODIAL" on pages 17-19.
MISSING DATA	Caller ID record received, but included unrecognizable data.	

ADDITIONAL INFORMATION

DISPLAYS (cont.)

DISPLAYED MESSAGE	STATUS	ACTION
NO DATA	Nothing stored in this autodial location.	Select another autodial location or store an autodial number. See pages 17-19, under "PROGRAMMING AUTODIAL."
PAGING	Sending a page.	See page 37 to send a page.
PERFORM SYSTEM UPDATE AT A DIFFERENT STATION	Line 1 has been disconnected and then reconnected, a station has been added to the system, the AC power has been removed and then reconnected, a power failure occurred or a unit changed it's station ID.	Perform a system update at another station. See page 40 under "PERFORMING A SYSTEM UPDATE."
PLEASE CONNECT LINE1	Line 1 has been disconnected.	Reconnect line 1. If display still appears after the line is reconnected, make sure line 1 is not in use when line 1 is reconnected.
PRV RELEASED	Station has released privacy.	Privacy has been released on this call.
PRV RESTORED	Station has restored privacy.	Privacy has been restored on this call.
SCRATCH PAD	The scratch pad button has been pressed.	Enter the number you want to store and then press SCRATCH PAD again. See page 29.
SET STATION	Line 1 has been disconnected, AC power was lost or this is initial setup.	Press the soft key under "SAVE." See page 12 under "ASSIGNING A STATION EXTENSION NUMBER."
UNABLE TO CALL	Can not intercom, page all or transfer.	The intended station is busy or other stations may be using the intercom or page functions. Try again later. See "INTERCOM & PAGING OPERATION" on pages 35-37.

ADDITIONAL INFORMATION

DISPLAYS (cont.)

DISPLAYED MESSAGE	STATUS	ACTION
UNAVAILABLE	Caller ID record was not available.	See "CALL WAITING CALLER ID SERVICE OPTIONS" on page 21.
UPDATE NEEDED	System update must be performed at another station. Line 1 may have been disconnected and then reconnected or power may have been lost.	Perform a system update at another station. See "PERFORMING A SYSTEM UPDATE" on page 40.
UPDATING NOW	Network or station is being updated.	Please wait.
VOLUME	The volume level will appear when using the handset or headset to go on-hook or off-hook.	The volume level will appear for 2 seconds. See "PROGRAMMING VOLUME" on page 16.
XX NOT AVAIL	Station ID is already being used by another station.	Press "CHANGE" to select another station ID. See "ASSIGNING A STATION EXTENSION NUMBER" on page 12. If you feel this display was received in error, perform a system update at another station.

ADDITIONAL INFORMATION

TROUBLESHOOTING

PROGRAMMING

I reconnected line 1 to the unit and now I cannot program the phone to it's existing ID.

- Perform a system update at another station.

I cannot access the program mode.

- Did your station place a call on hold? Is a line indicator flashing green?
- Is the station off hook?

OPERATION

My station does not receive PAGE ALL.

- Check to see if DND (Do Not Disturb) is on.

I cannot join a call in progress

- Has the station originating the call released privacy?
- Has another station already joined the privacy released call?

The intercom feature does not work.

- Is Line 1 common to all units that want to use the intercom feature?
- Is the station you are intercomming in DND?

I cannot view the activity of other stations.

- Is Line 1 common to all units?

One station's icon continues to appear in the display when the station is not in use.

- Check to see if DND (Do Not Disturb) is on at that station.
- Make sure the unit is still connected with the line and AC power.

TELEPHONE

The LINE INDICATOR flashes when a call comes in but the telephone does not ring.

- Is your station off hook? Your station will not ring if you are on another line.
- If you want your station to ring under the above two conditions, set ALWAYS RING: ON in programming. See page 15.
- Check the ringer switch at the back of the unit.
- Check the ringers for lines 1-4 in programming mode.
- Are lines 3 and/or 4 set as private lines for other stations? See "SETTING A PRIVATE LINE" on page 13.
- Check the PC/FAX switch (see page 9).

There is no dial tone and the LCD is blank.

- Check that the AC adapter is plugged in at both ends.
- Verify that the AC outlet is working by plugging a lamp etc. into it.

Callers cannot hear me when using the handset, but I can hear them.

- Verify that the handset cord is plugged into the HANDSET jack. If the handset cord is plugged into the HEADSET jack, the microphone will not work.

ADDITIONAL INFORMATION

TROUBLESHOOTING (cont.)

TELEPHONE (cont.)

When a call comes in on line 2, my station's LINE 2 indicator does not light.

- Check the FAX/PC switch. All stations switches should be set to PHONE when a PC or fax is not connected.

I cannot operate the phone during a power failure.

- Install four AA alkaline batteries (not included) into the bottom of the base to enable the telephone to operate up to 1 hour during a power failure.

I hear a dial tone when I try to answer a call.

- The caller has hung up before you answered the call.

OR

- If you have a private line, an attempt may have been made to transfer a call to your station from an uncommon line.

FILTER INSTALLATION

DSL service can interfere with communication between Executive Series telephones. If DSL service is present on Line 1, a filter (provided by the DSL provider) should be installed as indicated below.

Installation sites at greater distances from the telephone company central office may also experience network communication problems. These problems include inability to make or receive intercom calls or inconsistent call transfers and paging. If you are experiencing these problems, a filter (part number 3001-01) needs to be installed. Contact the company from which you purchased the phone to obtain this filter.

FILTER INSTALLATION - LOOP WIRING

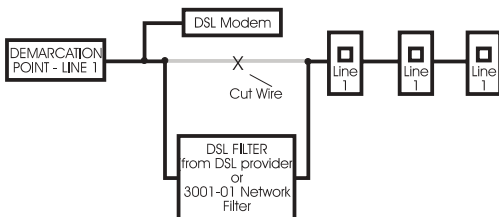

FILTER INSTALLATION - HOME RUN WIRING

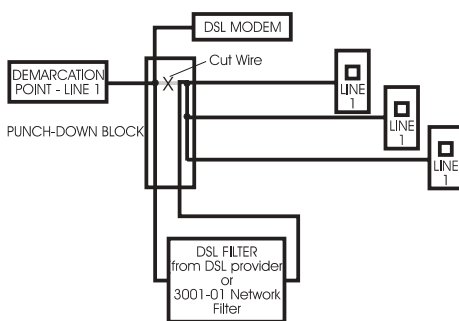

FCC REQUIREMENTS

USER INSTRUCTIONS

1. This equipment complies with Part 68 of the FCC rules. On the bottom of this equipment is a label that contains, among other information, the FCC registration number and Ringer Equivalence Number (REN) for this equipment. If requested, provide this information to your telephone company.
2. The REN is useful to determine the quantity of devices you may connect to your telephone line and still have all of those devices ring when your number is called. In most, but not all areas, the sum of the RENs of all devices should not exceed five (5.0). To be certain of the number of devices you may connect to your line, as determined by the REN, you should call your local telephone company to determine the maximum REN for your calling area.
3. If your telephone causes harm to the telephone network, the telephone company may discontinue your service temporarily. If possible, they will notify you in advance. But if advance notice is not practical, you will be notified as soon as possible. You will be advised of your right to file a complaint with the FCC.
4. Your telephone company may make changes in its facilities, equipment, operations, or procedures that could affect the proper operation of your equipment. If they do, you will be given advance notice so as to give you an opportunity to maintain uninterrupted service.
5. If there is a problem with this unit, the telephone company may ask you to disconnect this equipment from the network until the problem has been corrected or you are sure that the equipment is not malfunctioning.
6. Repairs can only be made by the manufacturer or an authorized service agency. Unauthorized repairs void registration and warranty. Contact seller or manufacturer for details of permissible user-performed routine repairs, and where and how to have other than routine repairs made.
7. This equipment may not be used on coin service provided by the telephone company. Connection to party lines is subject to state tariffs. (Contact your state public utility commission or corporation commission for information.)

Jacks: 2X RJ14 Ringer Equivalence: See bottom/underside of the base unit.

NOTE: This equipment has been tested and found to comply with the limits for a Class B digital device, pursuant to Part 15 of the FCC Rules. These limits are designed to provide reasonable protection against harmful interference in a residential installation. This equipment generates, uses, and can radiate radio frequency energy and, if not installed and used in accordance with the instructions, may cause harmful interference to radio communications. However, there is no guarantee that interference will not occur in a particular installation. If this equipment does cause harmful interference to radio or television reception, which can be determined by turning the equipment off and on, the user is encouraged to try to correct the interference by one or more of the following measures:

- Reorient or relocate the receiving antenna.
- Increase the separation between the equipment and receiver.
- Connect the equipment into an outlet on a circuit different from that to which the receiver is connected.
- Consult the dealer or an experienced radio/TV technician for help.

Any changes made by the user not approved by the manufacturer can void the user's authority to operate the equipment. **This product is hearing aid compatible.**

INDEX

Basic Telephone Operation	23-34	Introduction	4-5
Auto Busy Redial	27	Planning your System	8
Autodial	17-19, 27-29	Setting a Private Line	13
Call Duration Time	23	System Planning Worksheet	8
Call Transfer	31	Power Failure Operation	40
Auto Hold During	31	Quick Start	10-11
Attended	31	Initial Programming Sequence	10-11
Blind	31	Station Reset	40
Conference Calling	33-34	System Features	
Privacy released	33-34	All Station Page	37
Three-Way (2 external Lines)	33	Call Privacy	32
Dialed Number Display	29	Release	32
Memory Dial – Display and Dial	29	Station Status Indication (Busy Lamp Field) ...	5
Scratch Pad	29	System Update	40
Do Not Disturb	30		
Flash	20-21, 25		
Headset Operation	23		
Hold	30		
Hold Reminder	30		
Intercom Operation	35-37		
Auto Answer	12, 36		
Internal Station ID (Number Only)	5, 12		
Last Number Redial	26		
Line Status Indication	5, 24		
Line Selection	24		
Auto	24		
Manual	24		
Making and Receiving Calls	23-25		
Memory Dial	26		
Mute	30		
Programmed Autodial Pause	19		
Redial	27		
Ringer Line Selection	15, 24		
Ringer Volume	15		
Room Monitor	37		
Speakerphone Operation	23		
Volume Control	16		
Call Waiting Caller ID	21-22, 38		
Call Waiting	5, 21-22, 38		
Direct Dial	26, 29		
Record Management	38		
Record/Message Transfer	38		
Record Registration Setup	22		
Feature Call-outs	inside front cover		
Installation	9		
AC	9		
Batteries	38		
Cables	6, 9		
Connecting PC, Fax or Basic Phone	9		
Wall/Desk	39		

Technical Specifications

FCC Registration No.:
See bottom/underside of the unit

Battery Capacity: 4X AA

Ringer Equivalence:
See bottom/underside of the unit

Battery Life:
1 hour standby operation

Jack: 2X RJ14

The unit is hearing aid compatible.

Power Source:
Base Unit, Adapter M/N-95

Design and specifications are subject to
change without notice.

EASY TO USE OWNER'S GUIDE

4-LINE SYSTEM TELEPHONE WITH SPEAKERPHONE AND CALL WAITING CALLER ID



FEATURES

