

Uniden®

EZI 996

SERIES

OWNER'S

MANUAL

OWNER'S MANUAL

Contents

Welcome/Features	4	Voice Mail Waiting Indicator	21
Controls and Functions	5	Emergency Dial	
Terms Used in this Manual	6	Emergency Dial	22
Getting Started		Storing the Emergency Dial	22
Installing the Phone	7	Using the Speed Dial Memory	
A. Choose the Best Location	7	Using the Speed Dial Memory	23
B. Connect the Base Unit and Charge the Handset	8	Storing Names and Numbers in Speed Dial Memory	23
C. Choose the Dialing Mode	10	Storing Caller ID Messages in Speed Memory Locations.	26
D. Set the Visual Ringer Brightness	10	Making Calls from Speed Dial Memory.	27
E. Mount the Base Unit on a Wall	11	Caller ID Features	
Installing the Belt Clip	12	Caller ID and CIDCW (Caller ID on Call Waiting) 28	
Headset Installation	12	When the Telephone Rings	28
Basic Setup	13	Viewing the Caller ID Message List	29
Auto Talk	13	Deleting Information from the Caller ID List	30
Activating Caller ID on Call Waiting	13	Making a Call from the Caller ID List	32
Entering Your Area Code	14	Additional Information	
Setting the Language.	15	Changing the Digital Security Code	33
Selecting the Ringer Tone and Volume	16	Note on Power Sources	34
Basics		Installing a Replacement Battery.	35
Using Your Phone.	17	Maintenance.	36
Making and Receiving Calls.	17	Troubleshooting	37
Adjusting the Handset Earpiece Volume.	18	Liquid Damage	39
Tone Dialing Switch-over	19	General Information	40
Traveling Out-of-Range	19	Precautions & Warranty	41
Selecting a Different Channel.	20	I.C. Notice	48
Find Handset	20	Index	49
Using Call Waiting	21		

Welcome

Congratulations on your purchase of the Uniden cordless telephone. This cordless phone is designed and engineered to exacting standards for reliability, long life, and outstanding performance.

Note: Some illustrations in this manual may differ from the actual unit for explanation purposes. The color of your cordless telephone may vary.



As an ENERGY STAR® Partner, Uniden has determined that this product or product models meets the ENERGY STAR® guidelines for energy efficiency. ENERGY STAR® is a U.S. registered mark.

Features

- 900MHz Extended Range Technology
- Visual Ringer LED
- Large Backlit Keys
- Caller ID and Caller ID on Call Waiting
- 30 Caller ID Memory Locations
- 10 Speed Dial Memory
- One-Touch Emergency Dial
- 3 Line Backlit Easy to Read Display
- Find Handset Locator
- Earpiece Volume Control
- Audio Boost
- Ringer Volume Control
- Hearing Aid Compatible
- Desk or Wall Mountable

Be sure to visit our web site: www.uniden.com

Uniden® is a registered trademark of Uniden America Corporation. AutoTalk, AutoStandby, UltraClear Plus, Random Code and AutoSecure are trademarks of Uniden America Corporation.

Controls and Functions

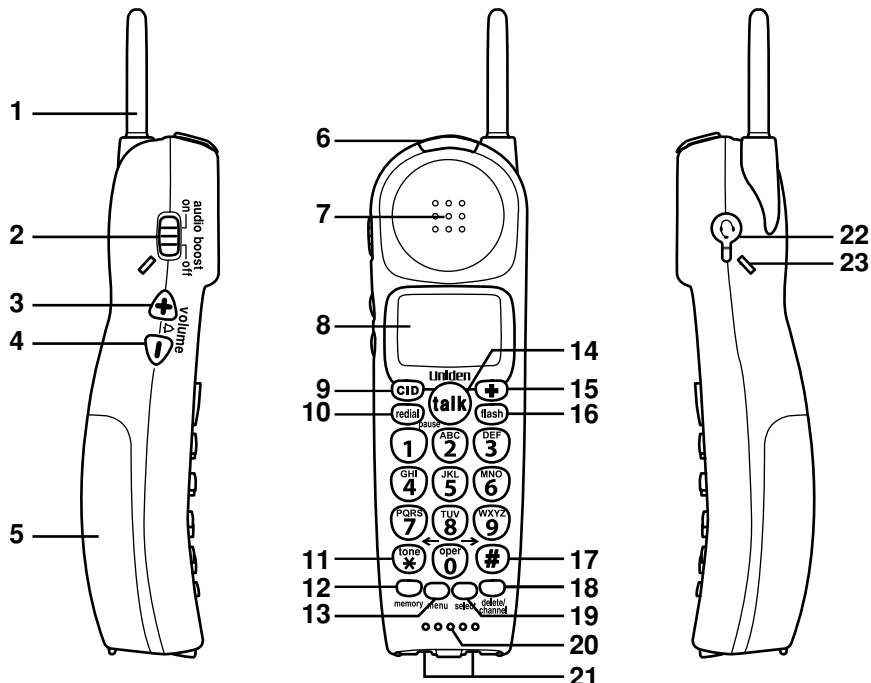

1. Handset antenna
2. Audio boost switch
3. Volume/ Δ (ring)/+ key (p. 16)
4. Volume/ Δ (ring)/- key (p. 16)
5. Handset battery compartment
6. Handset visual ringer LED
7. Handset earpiece
8. LCD display
9. CID key (p. 29)
10. Redial/pause key (p. 18/ 25)
11. x/tone/← key (p. 19)
12. Memory key (p. 23)
13. Menu key (p. 13)
14. Talk key (p. 17)
15. Emergency (☒) key (p. 22)
16. Flash key (p. 21)
17. #/→ key (p. 24)
18. Delete/channel key (p. 14/ 20)
19. Select key (p. 13)
20. Handset microphone and ringer speaker
21. Handset charging contacts
22. Headset jack
23. Beltclip hole

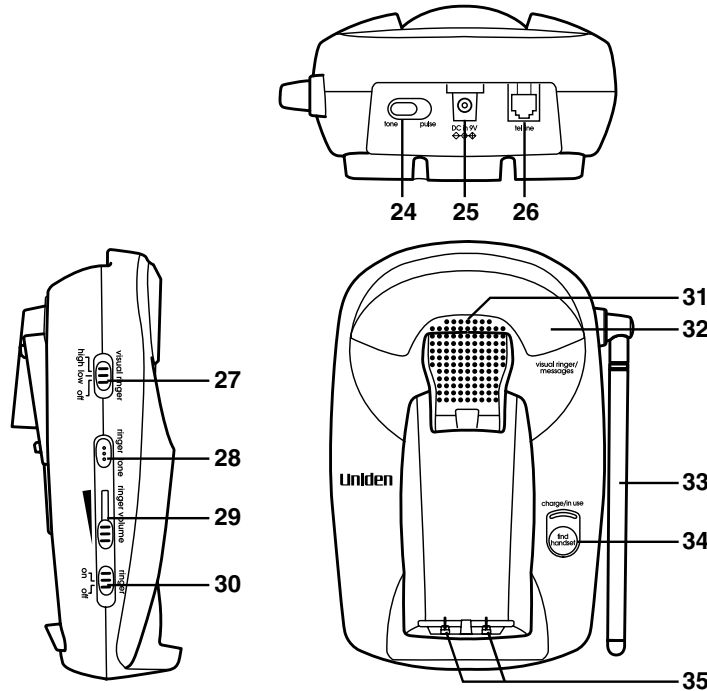

- 24. Pulse/tone switch (p. 10)
- 25. DC in 9V jack
- 26. Telephone line jack
- 27. Visual ringer switch (p. 10)
- 28. Ringer tone switch (p. 16)
- 29. Ringer volume adjuster (p. 16)
- 30. Ringer on/off switch (p. 16)
- 31. Base speaker
- 32. Base visual ringer LED
- 33. Base antenna
- 34. Find handset key (p. 20)
- 35. Base charging contacts

Terms Used in this Manual

- Standby Mode - The handset may be sitting in or off the base, but is NOT in use. The **talk** key has not been pressed and there is no dial tone.
- Talk Mode - The handset is off the base and the **talk** key has been pressed, enabling a dial tone.
- CID - Caller ID
- CIDCW - Caller ID on Call Waiting
- Emergency Dial - One touch speed dial key

Installing the Phone

Do the following steps:

- A. Choose the Best Location
- B. Connect the Base Unit and Charge the Handset
- C. Choose the Dialing Mode
- D. Set the Visual Ringer Brightness (optional)
- E. Mount the Base Unit On a Wall (optional)

A. Choose the Best Location

When choosing a location for your new phone, here are some important guidelines you should consider:

- There should be enough space to fully extend the antenna.

Avoid heat sources, such as radiators, air ducts, and sunlight

Avoid noise sources such as a window by a street with heavy traffic

Avoid television sets and other electronic equipment

Avoid microwave ovens

Avoid excessive moisture, extremely low temperatures, dust, mechanical vibration, or shock

Choose a central location

Avoid personal computers

Avoid other cordless telephones

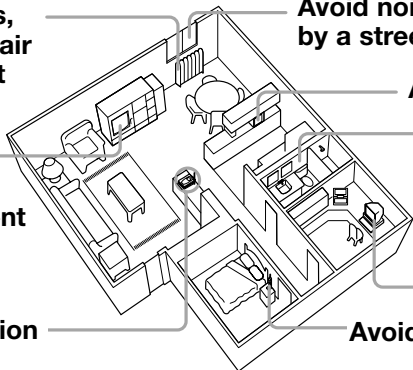

- The location should be close to both a phone jack and a continuous power outlet (one which is not connected to a switch).
- The base and the handset should be kept away from sources of electrical noise such as motors, microwave ovens, and fluorescent lighting.
- The base can be placed on a desk, tabletop, or mounted on a standard wall plate.



If your home has specially wired alarm equipment connected to the telephone line, be sure that installing the system does not disable your alarm equipment.

If you have questions about what will disable your alarm equipment, contact your telephone company or a qualified installer.



- Use only the supplied AD-314 AC adapter. Do not use any other AC adapter.

- Do not place the power cord where it creates a trip hazard or where it could become chafed and create a fire or electrical hazard.

B. Connect the Base Unit and Charge the Handset

- 1) Connect the AC adapter to the **DC in 9V** jack and to a standard 120V AC wall outlet.



- Connect the AC adapter to a continuous power supply.
- Place the base unit close to the AC outlet so that you can unplug the AC adapter easily.

- 2) Place the handset in the base unit.



- The rechargeable battery is already installed in your phone.

- 3) Make sure that the **charge/in use** LED illuminates.

If the LED does not illuminate, check to see that the AC adapter is plugged in and the handset makes good contact with the base charging contacts.

- 4) **Charge the handset battery pack for at least 15-20 hours before using your new cordless telephone for the first time!** To maximize the charge capacity of your battery pack, DO NOT plug the telephone cord into the base unit and wall jack until the battery is fully charged.

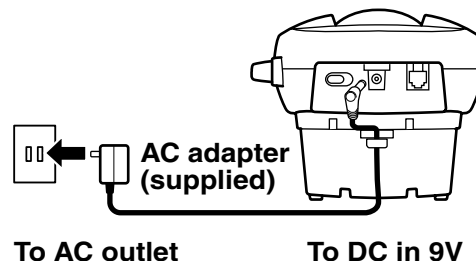

- 5) Once the handset battery pack is fully charged, connect the telephone line cord to the **tel line** jack and to a telephone outlet. If your telephone outlet isn't modular, contact your telephone company for assistance.

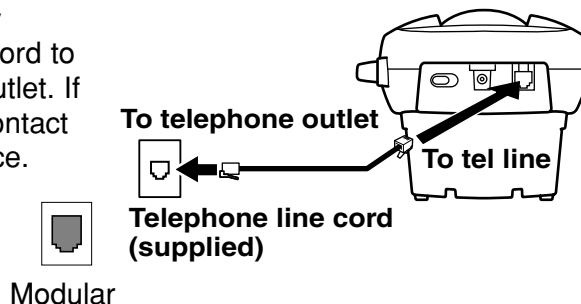

- 6) After the phone is connected, pick up the handset from the base and press **talk**. If you do not get a dial tone, check the following:

- Be sure the telephone cord is securely connected to both the base and an active telephone jack.
- Be sure the **charge** LED is on. If not, check the AC adapter.
- Be sure the handset is fully charged.
- Be sure the battery is installed correctly.
- Check the dialing mode your telephone company uses. If your telephone company uses pulse dialing, set your phone to pulse dialing. (see page 10.)



- Make sure your battery pack is fully charged before choosing the dialing mode.
- If your phone system requires pulse dialing and you need to send the DTMF tones for certain situations during a call, you may switch over to tone dialing. (Refer to "Tone Dialing Switch-over" on page 19.)

C. Choose the Dialing Mode

Most phone systems use tone dialing which sends DTMF tones through the phone lines. However, some phone systems (such as those in rural areas) still use pulse dialing. The default setting is tone dialing. Depending on your dialing system, set the mode as follows:

Place the switch in the **tone** position for tone dialing, or the **pulse** position for pulse dialing.

If you are not sure of your dialing system, set for tone dialing. Make a trial call. If the call connects, leave the setting as is. Otherwise set for pulse dialing.

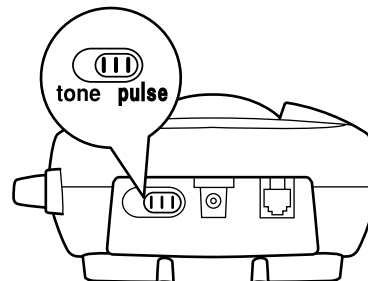

D. Set the Visual Ringer Brightness

The **visual ringer** switch allows you to set the brightness of the **visual ringer** LED on the base. There are three options to choose from: high, low and off. If you set the switch to off, **visual ringer** LED never flashes.

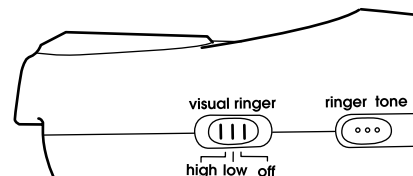

E. Mount the Base Unit on a Wall

Standard wall plate mounting

This phone can be mounted on any standard wall plate.

- 1) Remove the wall mount adapter from the Base and snap it into the notches on the bottom of the base.
- 2) Plug the AC adapter to the **DC in 9V** jack.
- 3) Wrap the AC adapter cord inside the molded wiring channel as shown.
- 4) Plug the AC adapter into a standard 120V AC wall outlet.
- 5) Plug the telephone line cord into the **tel line** jack.
- 6) Wrap the cord inside the molded wiring channel as shown.
- 7) Plug the telephone line cord into the telephone outlet.
- 8) Raise the antenna to a vertical position.
- 9) Align the mounting slots on the base with the mounting posts on the wall. Then push in and down until the phone is firmly seated.

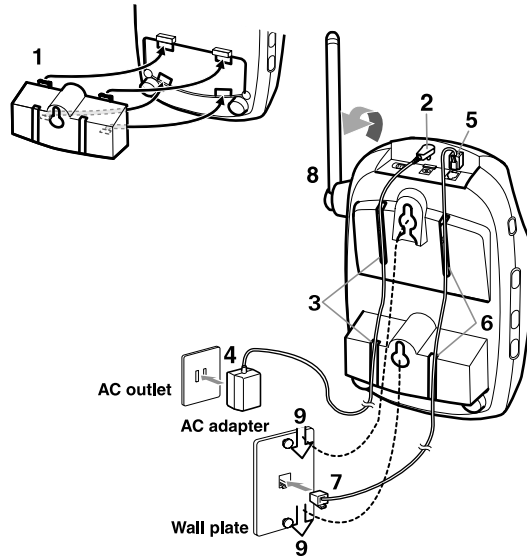

If the base unit is mounted on the wall, always put the handset in the base with the CID display facing forward to make sure the handset does not fall out of the base.

Direct wall mounting

If you don't have a standard wall plate, you can mount your phone directly to the wall. Before doing this, consider the following:

- Avoid electrical cables, pipes, or other items behind the mounting location that could cause a hazard when inserting screws into the wall.

- Try to mount your phone within 5 feet of a working phone jack to avoid excessive cord lengths.
- Make sure the wall material is capable of supporting the weight of the base and handset.
- Use #10 screws (minimum length of 1-3/8 inches) with anchoring devices suitable for the wall material where the base unit will be placed.

- 1) Insert two mounting screws into the wall, (with their appropriate anchoring device), 3-15/16 inches apart. Allow about 1/8 of an inch between the wall and screw heads for mounting the phone.
- 2) Refer to steps 1 through 9 on page 11 to mount the telephone.

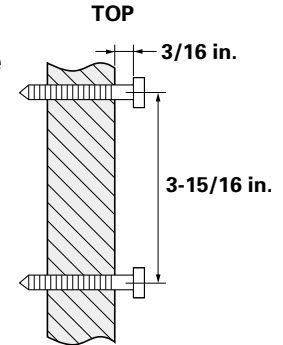

Installing the Beltclip

To attach the beltclip

Insert the beltclip into the holes on each side of the handset. Press down until it clicks.

To remove the beltclip

Pull both sides of the beltclip to release the tabs from the holes.

Headset Installation

Your phone may be used with an optional headset, the Uniden HS910. To use this feature, insert the headset plug into the headset jack.

Your phone is ready for hands-free conversations.

(Headset may be purchased by calling the Uniden Parts Department or visiting the web site. See note on page 35.)



Basic Setup

There are four basic options that you will need to set up: AutoTalk, CIDCW (Caller ID on Call Waiting), Area Code and Language.

AutoTalk

Autotalk allows you to answer the phone simply by removing the handset from the base. You do not have to press any keys.

- 1) When the phone is in standby mode, press the **menu** key. The following screen appears.
- 2) Press the **select** key to turn AutoTalk on.
- 3) Press the **menu** key to complete the setting. The handset returns to standby mode.

```

▶ Auto Talk   : Off
  CIDCW      : On
  Area Code   :
  
```

Activating Caller ID on Call Waiting

Caller ID allows you to see the name and number of the calling party before you answer the phone. Caller ID on Call Waiting (CIDCW) lets you see the name and number of a call that comes in when you are on the line.

You must subscribe to Caller ID service through your local telephone provider to use this feature. You must also subscribe to Call Waiting Service to use Caller ID on Call Waiting.

- 1) When the phone is in standby mode, press the **menu** key. The following screen appears.

```

▶ Auto Talk   : Off
  CIDCW      : On
  Area Code   :
  
```

- 2) Press the **volume/ Δ/-** key to select CIDCW.
- 3) Press the **select** key to toggle and turn on Caller ID on Call Waiting.
- 4) Press the **menu** key and return the handset to the base unit to complete the setting. The handset returns to standby mode.

Entering Your Area Code

If you enter a 3-digit area code number in the **Area Code** option, your local area code does not appear in Caller ID messages. Do not program this option if your calling area requires 10-digit dialing. When reviewing Caller ID messages, you will see only the local seven digit number. For calls received from outside your local area code, you will see a full 10-digit number.

- 1) When the phone is in standby mode, press the **menu** key. The following screen appears.

```
Auto Talk   :Off
CIDCW      :On
Area Code   :
```

- 2) Press the **volume/ Δ/-** key twice to select **Area Code**.

```
Auto Talk   :Off
CIDCW      :On
Auto Talk   :Off
CIDCW      :On
Area Code   :
```

- 3) Press the **select** key. If an area code was already stored, the phone will display it.

- 4) Use the number keys (**0 - 9**) to enter the 3-digit area code. If you make an error, use **delete/channel** key to backspace.

```
Auto Talk   :Off
CIDCW      :On
Area Code   :█
```

- 5) Press the **select** key. A confirmation tone sounds.
- 6) Press the **menu** key to complete the setting. The handset returns to standby mode.

Setting the language

There are three languages to choose from: English, French and Spanish.

- 1) When the phone is in standby mode, press the **menu** key. The following screen appears.

```
Auto Talk   :Off
CIDCW       :On
Area Code   :
```

- 2) Press the **volume/ Δ/-** key three times to select Language.

- 3) Press the **select** key to toggle between Eng, Fr. and Esp.

```
CIDCW       :On
Area Code   :
Language    :Eng
```

- 4) Press the **menu** key to complete the setting. The handset returns to standby mode.

Selecting the Ringer Tone and Volume

Base ringer on/off

The **ringer** switch allows you to set the base ringer on or off. If you set the switch to off, you never hear the base ringer tone.



Base ringer tone

Press the **ringer tone** button in standby mode to select one of 7 ringer tones.

Base ringer volume

Slide the **ringer volume** adjuster to set the base ringer volume.

Handset ringer tone and volume

Press the volume up key or volume down key (labeled as the **volume/ Δ/+** or **volume/ Δ/-** key) in standby mode to select one of five ringer tones and volume combinations.

Using Your Phone

Making and Receiving Calls

Making a call

- 1) Remove the handset from the base.
- 2) Press the **talk** key.
- 3) Listen for the dial tone.
- 4) Dial the number.

OR

- 1) Remove the handset from the base.
- 2) Dial the number.
- 3) Press the **talk** key.

Receiving a call

- 1) Remove the handset from the base (If AutoTalk is on, the phone will automatically answer the call when you pick it up).
- 2) If the handset is off the base, press the **talk** key or any number key (AutoTalk is on).

Hanging up

Press the **talk** key or return the handset to the base.



Refer to page 13
"Basic Setup" to turn
On the AutoTalk feature
if desired.

Redialing the last dialed number

- 1) Remove the handset from the base.
- 2) Press the **talk** key.
- 3) Listen for the dial tone.
- 4) Press the **redial/pause** key.

OR

- 1) Remove the handset from the base.
- 2) Press the **redial/pause** key.
- 3) Press the **talk** key.

Adjusting the Handset Earpiece Volume

To change the earpiece volume, press **volume/ Δ/+** or **volume/ Δ/-** key during a call.

Audio boost

As we get older, it often becomes harder to hear high frequency tones. Audio Boost lets you hear phone conversations more clearly by boosting the high frequency tones.

To set Audio boost on, slide the **audio boost** switch upward.

Boost On appears on the display under the volume setting.

To set Audio boost off, slide **audio boost** switch downward.

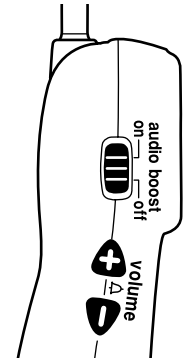

Tone Dialing Switch-over

If your telephone company requires pulse dialing, you can switch-over to tone dialing after the call connects. This feature is useful when you need tone dialing to use any automated menu systems, such as telephone bank tellers, telephone prescriptions refills, customer support menus, etc.

If your phone is set to pulse dialing mode, make your call normally. Once your call connects, press the ***tone/←** key. Any digits you enter from then on will be sent as tone digits. When this particular call ends, the phone automatically returns to pulse dialing mode.

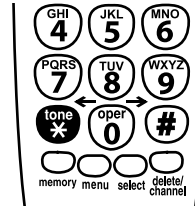

Traveling Out-of-Range

During a call, as you begin to move your handset too far from your base unit, noise increases. If you pass the range limits of the base unit, your call will terminate within 5 minutes.



- The **UltraClear Plus™** true compander circuitry virtually eliminates background noise. This innovative technology, together with 20 different channels, provides you with the best possible reception during all your conversations.

Selecting a Different Channel

If you encounter interference while using your phone, you can manually change the phone's channel for clear operation. This function works only when the phone is in use. Press the **delete/channel** key. **Scanning** appears on the display, indicating the phone is changing to another channel. For more information on interference, refer to page 44 under "Precautions".

Find Handset

If you lost the handset, press the **find handset** key on the base. The **visual ringer** LED on the handset flashes, and the handset beeps for 60 seconds.

Paging is canceled when pressing any handset key, the **find handset** key on the base or the handset is returned to the base. Paging is also canceled when the phone receives an incoming call.

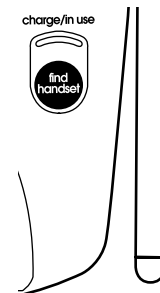

Using Call Waiting

If you have Call Waiting service, you can receive calls while on the line.

- 1) If a call comes in while you are on the phone, you will hear a call waiting tone. If you have CIDCW activated, you will see the name and number of the incoming caller.
- 2) Press the **flash** key to accept the waiting call. After a short pause, you will hear the new caller.
- 3) To return to the original caller, press the **flash** key again.

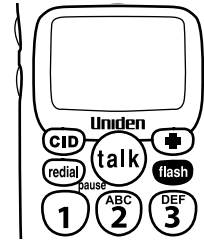

note You must subscribe through your local telephone company to receive Call Waiting service.

Voice Mail Waiting Indicator

If you subscribe to voice mail service, you can use your cordless telephone to access your voice mailbox. The **visual ringer** LED light on the base of your phone flashes whenever you have messages waiting in your voice mailbox. Just dial the access number supplied by your voice mail provider to enter your mailbox. You can program your voice mail access number to a speed dial number.

If the voice mail waiting indicator remains on after you have retrieved your messages, press and hold the **find handset** key for 5 seconds. This will reset the indicator.



You must subscribe to voice mail service from your telephone company in order to use this feature. The voice mail company will provide you with the access number.

Emergency Dial

Emergency Dial is a one-touch speed dial key. Store your most important or most frequently called number as your Emergency Dial number. Then, simply press the **emergency** (**☒**) key, and your phone will automatically dial the number.



Storing the Emergency Dial

- 1) When the phone is in standby mode, press and hold the **emergency** (**☒**) key. The following display appears.

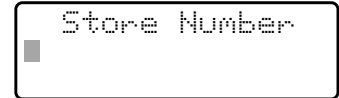

If the Emergency Dial number is already programmed, the Edit screen appears. You can select Edit to edit this entry, select Delete to erase this entry or select Go Back to return to the previous screen.

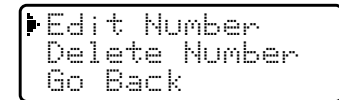

- 2) Store the number by following step 6 on page 25 under "Storing Names and Numbers in Speed Dial Memory".

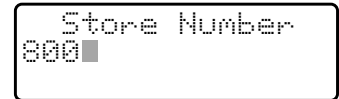

- 3) Press the **select** key.

You hear a confirmation tone, and Number Stored appears. Memory storage is complete.

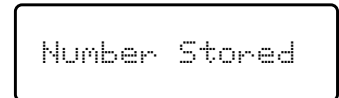

Using the Speed Dial Memory

The speed dial memory allows you to store up to 10 names and numbers in the handset. You can dial these numbers with just a few key presses.

The speed dial memory is not limited to phone numbers. You can store any number (up to 20 digits) that you need to enter once your call connects. This is referred to as Chain Dialing. For example, you can save your bank account number to speed dial memory. When you call your bank's telephone teller service and are prompted to enter your account number, simply press the **memory** key and the speed dial number where you stored your account number.

Storing Names and Numbers in Speed Dial Memory

- 1) With the phone in standby mode, press the **memory** key.
- 2) Enter **0 - 9** to select the speed dial number where you would like to store this entry. You can also scroll through the list with the **volume/ Δ/+** and **volume/ Δ/-** keys. Press the **select** key twice.
- 3) **Store Name** appears and a cursor flashes indicating that the display is ready for the name to be entered.

```
Select Memory
1 |
2 | JOHN DOE
```

```
1: (Empty)
Press Select
to edit
```

```
Store Name
█
```

```
Edit Memory 1
Delete Memory 1
Go Back
```

If the selected speed dial number is already assigned, the Edit screen appears. You can select **Edit** to edit this entry, select **Delete** to delete this entry, or select **Go Back** to choose another speed dial number.



When editing the speed dial memory, you must press a key within 30 seconds or the phone will return to standby mode. If you return the handset to the base, the phone will return to standby mode also.



If the next character uses the same number key, you must press the **#/→** key to move the cursor over. Otherwise the next time you press the number key, it changes the character that was previously set.

- 4) Enter a name according to the instructions below, then press the **select** key. If no name is required, go to step 5.
 - The name can be up to 14 characters.
 - Use the **#/→** and ***/tone/←** keys to move the cursor to the desired location.
 - Use the **delete/channel** key to delete characters as needed.
 - Press and hold the **delete/channel** key to delete all the characters.

Refer to the letters on the number keys to select the desired characters. With each press of a numeric key, the displayed character appears in the following order: Upper case letters first, lower case letters next and finally the number corresponding to the key.

If you make a mistake while entering a name

Use the ***/tone/←** or **#/→** key to move the cursor to the incorrect character. Press the **delete/channel** key to erase the wrong character. Then enter the correct character. To delete all characters, press and hold the **delete/channel** key.

For example, to enter Movies.

- 1) Press **6**. Then press the **#/→** key to move the cursor to the right.
- 2) Press **6** six times.
- 3) Press **8** six times.
- 4) Press **4** six times.
- 5) Press **3** five times.
- 6) Press **7** eight times.

Keys	Number of time key is pressed								
	1	2	3	4	5	6	7	8	9
1	1								
2abc	A	B	C	a	b	c	2		
3def	D	E	F	d	e	f	3		
4ghi	G	H	I	g	h	i	4		
5jkl	J	K	L	j	k	l	5		
6mno	M	N	O	m	n	o	6		
7pqrs	P	Q	R	S	P	q	r	s	7
8tuv	T	U	V	t	u	v	8		
9wxyz	W	X	Y	Z	w	x	y	z	9
0oper	*	#	-	&	()	(blank)	0	

5) Store Number is displayed. The cursor flashes indicating that the display is ready for the number to be entered.

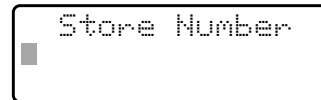

6) Use the keypad to enter the phone number; each number can be up to 20 digits. If you need the phone to pause during the dialing sequence, press the **redial/pause** key to insert a two-second delay between the numbers. You can enter multiple pauses to increase the delay. Each pause counts as a digit. The display shows a P for every pause.

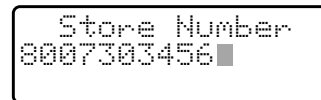

note When storing numbers into memory, if the handset is idle (i. e., no key is pressed) for more than 30 seconds, it will beep rapidly, and the phone will return to standby mode.



You cannot store a Caller ID message if no phone number appears in the message.

- 7) Press the **select** key. You will hear a confirmation tone, and the following screen appears.
Memory storage is complete.
After about 2 seconds, the following screen displays all the speed dial memory entries.
- 8) Press the **memory** key to exit memory setup mode.
The phone returns to standby.

```
Memory 1 Stored
```

```
1▶ Movies  
2 JOHN DOE  
3 MOM AND DAD
```

Storing Caller ID Messages in Speed Memory Locations

Messages (Caller ID names/numbers) shown in the Caller ID list can be stored in memory dialing. For complete instructions on viewing the Caller ID list, see page 29.

- 1) Press the **CID** key. Select the phone number to be stored from the Caller ID list by pressing the **volume/ Δ/-** or **volume/ Δ/+** key.
- 2) Press the **memory** key.

```
5/17 12:30PM 03  
Jane Smith  
214-555-1234
```

```
Select Memory  
1▶ Movies  
2 JOHN DOE
```

- 3) Enter a number (**0 - 9**) or press the **volume/ Δ/-** or **volume/ Δ/+** key to select the memory location to be stored.
- 4) Press the **select** key. You hear a confirmation tone, and the number is stored in memory. The display returns to the Caller ID list.

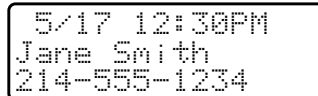

5/17 12:30PM
Jane Smith
214-555-1234



If a message has already been stored in the selected memory number location, a confirmation screen is displayed. Press the **volume/ Δ/+** key to select **Yes**. Press the **select** key to overwrite. The display returns to the Caller ID list.

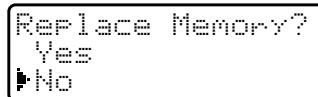

Replace Memory?
Yes
No

Making Calls from Speed Dial Memory

- 1) Press the **memory** key. The handset displays your programmed speed dial number.
- 2) Enter the number (**0 - 9**), or press the **volume/ Δ/+** or **volume/ Δ/-** key to select the speed dial number you would like to dial.
- 3) Press the **talk** key. **Talk** and the number selected appear on the display. Then the displayed number is dialed.



- If you answer a call before the Caller ID message is received (for example, before the second ring), the Caller ID message will not appear.
- When the call is received via a telephone company that does not offer Caller ID service, the caller's phone number and name do not appear. (This includes international calls.)
- When the call is via a private branch exchange (PBX), the caller's phone number and name may not appear.

Caller ID and CIDCW (Caller ID on Call Waiting)

You must subscribe to Caller ID service through your local telephone provider to use this feature.

When the telephone rings, the Caller ID feature allows you to view the caller's name, phone number, date and time of call. With CIDCW (Caller ID on Call Waiting), you will hear a Call Waiting tone while you are on a call, and the Caller ID data is displayed. To accept the waiting call, press the **flash** key (see page 21). Additionally, you can dial a number stored in the Caller ID list or save data to your Memory dial list.

When the Telephone Rings

- 1) When the Caller ID message is received, the display shows the caller's phone number along with the date and time. The incoming call information is stored in the Caller ID record. If the Caller ID service includes the caller's name, the caller's name appears on the display (up to 15 letters).

The date and time received	5/11 12:30PM
Caller's name	Jane Smith
Caller's phone number	214-555-1234

You may receive any one of the following messages:

When invalid data is received	Incomplete Data
When a private name is received	Private Name
When a private number is received	Private Number
When a unknown name is received	Unknown Name
When a unknown number is received	Unknown Number

- 2) When you pick up the phone, the display changes to Talk.
(Auto Talk feature is set to on).

 Data errors appear as "■".

Viewing the Caller ID Message List

The Caller ID list stores information for up to 30 incoming calls - even unanswered calls.

- 1) With the phone in standby mode, press the **CID** key.
The summary screen appears. The screen shows the number of new messages and total messages.

```

Caller ID
New :01
Total:02
  
```

- 2) To see messages starting with the most recent message, press the **volume/ Δ/-** key. Each time you press the key, you will see the next most recent message.

```

5/17 12:30PM 03
Jane Smith
214-555-1234
  
```

- 3) To see messages starting with the oldest message, press the **volume/ Δ/+** key.
Each time you press the key, you will see the next oldest message.
- 4) Press the **CID** key to return to standby mode.



- In Caller ID operation, if no key is pressed for more than 30 seconds, an error tone sounds and the telephone returns to standby mode.
- Each message can be up to 15 characters for the phone number and the name.
- The number of calls from the same Caller ID appears next to the received time. Once you view the new message, the number will be cleared and disappear.



- While using the Delete All? or Delete Message? screen, if no key is pressed for more than 30 seconds, an error tone sounds, and the handset returns to standby mode.
- If you get an incoming call or page, the deleting operation is canceled, and you can answer the call or page.

Deleting Information from the Caller ID List

The cordless phone stores up to 30 messages (Caller ID names/numbers). If the phone receives the 31st message, the oldest one in the list is automatically deleted. Caller ID data can also be deleted manually.

Deleting a Caller ID message

- 1) Press the **CID** key in standby mode. Find the message to be deleted from the Caller ID list by pressing the **volume/ ▲/+** or **volume/ ▼/-** key.
- 2) Press the **delete/channel** key.
- 3) Press the **select** key.

```
5/17 12:30PM 03  
Jane Smith  
214-555-1234
```

```
Delete Message?  
▶ Yes  
No
```

Deleting all Caller ID names/numbers

- 1) With the phone in standby mode, press the **CID** key.
- 2) Press the **delete/channel** key.
- 3) Press the **volume/ Δ/+** key to select Yes, and then press the **select** key.
You hear a confirmation tone and all stored Caller ID messages are deleted.

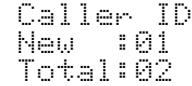

```
Caller ID  
New :01  
Total:02
```

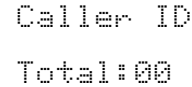

```
Caller ID  
Total:00
```



You cannot make a call from the Caller ID list if your cordless phone is connected to a private branch exchange (PBX).

Making a Call from the Caller ID List

You can place a call from the Caller ID list.

- 1) Press the **CID** key. Select the phone number that you want to dial by pressing the **volume/ Δ/+** or **volume/ Δ/-** key.
- 2) To add a "1" to the front of the displayed Caller ID number for a long distance call, press 1. (Pressing 1 will also delete a 1 from the front of the displayed Caller ID number.)
- 3) To add the area code number stored in you Area Code setting to the front of the displayed Caller ID number, press 3. (Pressing 3 will also delete the area code from the front of the displayed Caller ID number.)
- 4) Press the **talk** key. The displayed phone number dials automatically.

```
5/17 12:30PM 03  
Jane Smith  
214-555-1234
```

```
Talk  
2145551234
```

Changing the Digital Security Code

To protect you against misbilled calls which might result from your phone being activated by other equipment, the cordless phone provides AutoSecure (which electronically locks your phone when the handset is in the base) and Random Code digital security (which automatically selects one of over 262,000 digital security codes for the handset and base).

If the handset battery pack is completely discharged or the battery pack is removed, the digital security code will be lost. If this happens, a new security code is set automatically the next time the battery pack is charged.

The digital security code is an identification code used to connect the handset and the base unit. Normally, setting the code is not necessary. The first time you charge your handset, the security code is automatically set.

In the rare situation that you suspect another cordless telephone is using the same security code, you can change the code.

- 1) Remove the handset from the base unit. Press and hold the **find handset** key on the base.
- 2) While holding the **find handset** key, place the handset in the base unit, and leave the handset on the base for more than 3 seconds. A new random security code is set.

Note on Power Sources

Low battery alert

When the battery pack is very low and needs to be charged, the phone is programmed to eliminate functions in order to save power. If the phone is not in use, **Low Battery** appears on the LCD and none of the keys will operate.

If the phone is in use, **Low Battery** flashes and the handset beeps. Complete your conversation as quickly as possible and return the handset to the base unit for charging.

 Information stored in the phone's memory will be retained for 30 minutes after the battery pack is removed. This includes all setup information, last number dialed, speed dial memory, Emergency Dial programming, and the CID list.

Even when the battery pack is not being used, it will gradually discharge over a long period of time. For optimum performance, be sure to return the handset to the base unit after a telephone call.

Battery replacement and handling

When the operating time becomes short even after a battery is recharged, please replace the battery. With normal usage, your battery should last about one year. Please contact your place of purchase or the Uniden Parts Department for a replacement battery.

Warning: To avoid the risk of personal injury or property damage from fire or electrical shock, only use the Uniden battery model and Uniden adapter model specifically designated for this product.

Power Failure

During the period that the power is off, you will not be able to make or receive calls with the telephone.

Caution

- Use only the specified Uniden battery pack (BT-905).
- Do not remove the battery from the handset to charge it.
- Never throw the battery into a fire, disassemble it, or heat it.
- Do not remove or damage the battery casing.

Installing a Replacement Battery

Follow the steps below if you need to replace a battery.

- 1) Press down on the handset battery case cover (use the finger indentation for a better grip) and slide the cover downward to remove.
- 2) Remove the existing battery and unplug the connector from the jack.
- 3) Plug the battery pack connector (red & black wires) into the jack inside the battery compartment. (The connector notches fit into the grooves of the jack only one way.) Match the wire colors to the polarity label in the battery compartment, connect the battery, and listen for a click to insure connection.
- 4) Make sure you have a good connection by slightly pulling on the battery wires. If the connection is secure, the battery jack will remain in place.
- 5) Place the battery case cover back on the handset by sliding it upwards until it clicks into place.

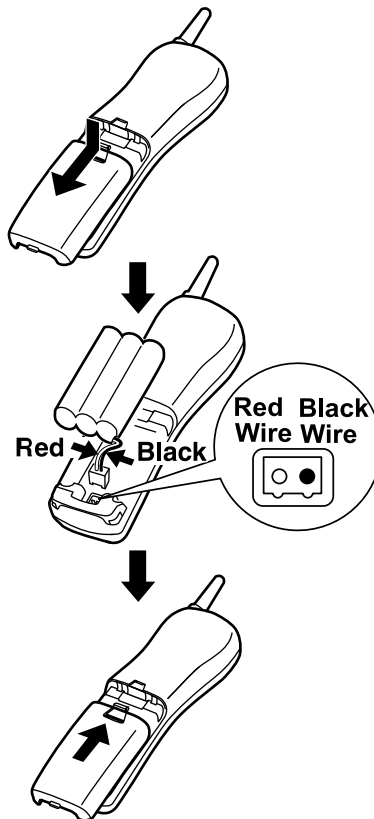

Use only the Uniden rechargeable battery pack (BT-905) supplied with your cordless telephone.



Replacement batteries are also available through the Uniden Parts Department at (800) 554-3988, Monday through Friday from 8:00 a.m. to 5:00 p.m. or online at www.uniden.com

Maintenance

To maintain a good charge, it is important to clean the charging contacts on both the handset and base once a month. Using water only, dampen a cloth to clean the charging contacts. Then, make sure to go back over the charging contacts with a dry cloth.

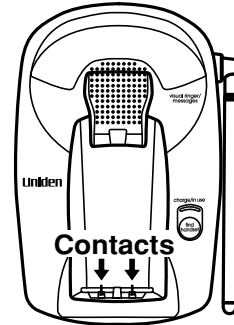

Caution

Do not use paint thinner, benzene, alcohol, or other chemical products. Doing so may discolor the surface of the telephone and damage the finish.

Troubleshooting

If your phone is not performing to your expectations, please try these simple steps first.

Symptom	Suggestion
The charge/in use LED won't illuminate when the handset is placed in the base.	<ul style="list-style-type: none">• Make sure the AC adapter is plugged into the base and wall outlet.• Make sure the handset is properly seated in the base.• Make sure the charging contacts on the handset are clean.
The audio sounds weak and/or scratchy.	<ul style="list-style-type: none">• Move the handset and/or base to a different location away from metal objects or appliances and try again.• Press the delete/channel key to help eliminate background noise.• Make sure that the handset is not too far from the base.
Can't make or receive calls.	<ul style="list-style-type: none">• Check both ends of the telephone line cord.• Make sure the AC adapter is plugged into the base and wall outlet.• Disconnect the AC adapter for a few minutes, then reconnect it.• Change the digital security code (see page 33).• Make sure that the handset is not too far from the base.• Check the dialing mode used by your telephone company.

Symptom	Suggestion
The handset doesn't ring or receive a page.	<ul style="list-style-type: none"> • The battery pack may be weak. Charge the battery for 15-20 hours. • The handset may be too far away from the base unit. • Place the base unit away from appliances or metal objects. • Change the digital security code (see page 33). • Check the battery pack to insure there is a secure connection. • Make sure ringer volume isn't set to turned off.
Severe noise interference.	<ul style="list-style-type: none"> • Keep the handset away from microwave ovens, computers, remote control toys, wireless microphones, alarm systems, intercoms, room monitors, fluorescent lights, and electrical appliances. • Move to another location or turn off the source of interference.
The Caller ID does not display.	<ul style="list-style-type: none"> • The handset was picked up before the second ring. • The call was placed through a switchboard. • Charge the handset. • Your Caller ID service may not be active; contact your local telephone service provider.
Voice Message Indication does not work.	<ul style="list-style-type: none"> • Reset the indicator by pressing and holding the <i>find handset</i> key for 5 seconds. • Contact your local telephone company to make sure that your telephone receives FSK message signaling.
If you still have a problem.	<ul style="list-style-type: none"> • Call our customer hotline at 1-800-297-1023.

Liquid Damage

Moisture and liquid can damage your cordless phone. In case of accidental submersion, please read the following steps.

Case	Action
<p>If the handset or base is exposed to moisture or liquid, but the liquid only affects the exterior plastic housing.</p>	<p>Wipe off the liquid, and use as normal.</p>
<p>If moisture or liquid has entered the plastic-housing (i.e. liquid can be heard in the phone or liquid has entered the handset battery compartment or vent openings on the base).</p>	<p>Handset:</p> <ol style="list-style-type: none"> 1. Remove the battery cover and leave it off for ventilation. 2. Remove the battery pack by disconnecting. 3. Leave the battery cover off and the battery pack disconnected for at least 3 days. 4. Once the handset is completely dry, reconnect the battery pack and the battery cover. 5. Recharge the handset's battery pack for 20 hours in the base unit before using the phone. <p>Base:</p> <ol style="list-style-type: none"> 1. Disconnect the AC adapter from the base unit, cutting off electrical power. 2. Disconnect the telephone cord from the base unit. 3. Let dry for at least 3 days. <p>IMPORTANT: You must unplug the telephone line while recharging the battery pack to avoid charge interruption.</p> <p>CAUTION: DO NOT use a microwave oven to speed up the drying process. This will cause permanent damage to the handset, base and the microwave oven. After following these steps, if your cordless telephone does not work, please send to:</p> <p>Uniden America Corporation Parts and Service Division 4700 Amon Carter Blvd. Ft. Worth, TX76155 1-800-554-3988 Monday through Friday 8 a.m. to 5 p.m. CST</p>

General Information

The phone complies with FCC Parts 15 and 68.

Operating temperature: -10° to +50°C (+14°F to +122°F)

AC Adapter Information

AC Adapter part number: AD-314
Input Voltage: 120V AC 60Hz
Output Voltage: 9V DC 350 mA

Battery Information

Battery part number: BT-905
Capacity: 600 mAH, 3.6V



• **To avoid damage to the phone use only Uniden AD-314 and BT-905 with your phone.**

• If the handset is left off of the base, the actual Talk mode duration will be reduced respective to the amount of time the handset is off the base.

Recharge your phone on a regular basis by returning the handset to the base after each phone call.

When the operating time becomes short, even after the battery is recharged, please replace the battery.

With normal usage, the battery should last about one year.

A replacement Uniden adapter and battery may be purchased at your local Uniden dealer or by contacting the Uniden Parts Department (800) 554-3988. Hours are from 8:00 a.m. to 5:00 p.m. Central Time, Monday through Friday. We can also be reached on the web at www.uniden.com.

Specifications, features, and availability of optional accessories are all subject to change without prior notice.

Precautions!

Before you read anything else, please observe the following:

Warning!

Uniden America Corporation DOES NOT represent this unit to be waterproof. To reduce the risk of fire, electrical shock, or damage to the unit, DO NOT expose this unit to rain or moisture.

Rechargeable Nickel-Cadmium Battery Warning

- This equipment contains a rechargeable nickel-cadmium battery.
- Cadmium is a chemical known to the State of California to cause cancer.
- The rechargeable nickel-cadmium battery contained in this equipment may explode if disposed of in a fire.
- **Do not** short-circuit the battery.
- Do not charge the rechargeable nickel-cadmium battery used in this equipment in any charger other than the one designed to charge this battery as specified in the owner's manual. Using another charger may damage the battery or cause the battery to explode.

Rechargeable Nickel-Cadmium Batteries Must Be Recycled or Disposed of Properly



- Uniden voluntarily participates in an RBRC® industry program to collect and recycle nickel-cadmium batteries at the end of their useful life, when taken out of service within the United States.

www.uniden.com

The RBRC® program provides a convenient alternative to placing used nickel-cadmium batteries into the trash or municipal waste stream, which is illegal in some areas.

- Through the RBRC® program, Uniden makes it easy for you to drop off the used battery at local retailers of replacement nickel-cadmium batteries. You may also contact your local recycling center for information on where to return the used battery. Please call 1-800-8-BATTERY for information on Ni-Cd battery recycling in your area. Uniden's involvement in this program is part of its commitment to protecting our environment and conserving natural resources.
- RBRC® is a registered trademark of the Rechargeable Battery Recycling Corporation.

Uniden works to reduce lead content in our PVC coated cords in our product and accessories.



The exclamation point within an equilateral triangle is intended to alert the user to the presence of important operating and maintenance (servicing) instructions in the literature accompanying the appliance.

Warning:

The cords on this products and/or accessories contain lead, a chemical known to the State of California to cause birth defects or other reproductive harm.

Wash hands after handling.

Important Safety Instructions

When using your telephone equipment, these basic safety precautions should always be followed to reduce the risk of fire, electrical shock, and injury to persons:

1. Read and understand all instructions.
2. Follow all warnings and instructions marked on the product.
3. Unplug this product from the wall outlet before cleaning. Use a dry cloth for cleaning without liquid or aerosol cleaners.
4. Do not use this product near water; for example, near a bathtub, wash bowl, kitchen sink or laundry tub, in a wet basement, or near a swimming pool.
5. Do not place this product on an unstable cart, stand, or table.
The telephone may fall, causing serious damage to the unit.
6. Slots and openings in the cabinet and the back or bottom are provided for ventilation. To protect the product from overheating, these openings must not be blocked or covered. This product should never be placed near or over a radiator or heat register. This product should not be placed in a built-in installation unless proper ventilation is provided.
7. This product should be operated only from the type of power source indicated on the marking label. If you are not sure of the type of power supply to your home, consult your dealer or local power company.
8. Do not allow anything to rest on the power cord. Do not locate this product where the cord will be damaged by persons walking on it.
9. Do not overload wall outlets and extension cords, as this can result in the risk of fire or electrical shock.
10. Never push objects of any kind into this product through cabinet slots, as they may touch dangerous voltage points or short out parts that could result in a risk of fire or electric shock. Never spill liquid of any kind on the product.
11. To reduce the risk of electric shock, do not disassemble this product. Take it to qualified service personnel when service or repair work is required. Opening or removing covers may expose you to dangerous voltages or other risks. Incorrect reassembly can cause electric shock when the appliance is subsequently used.
12. Unplug this product from the wall outlet and refer servicing to qualified service personnel under the following conditions:
 - A. When the power supply cord is damaged or frayed.
 - B. If liquid has been spilled into the product.
 - C. If the product has been exposed to rain or water.

- D. If the product does not operate normally when following the operating instructions. (Adjust only those controls that are covered by the operating instructions. Improper adjustment of other controls may result in damage and will often require extensive repair work by a qualified technician.)
 - E. If the product has been dropped or the cabinet has been damaged.
 - F. If the product exhibits a distinct change in performance.
13. Do not use the telephone to report a gas leak in the vicinity of the leak.

Additional Battery Safety Precautions

Caution! *To reduce the risk of fire or injury to persons by the battery, read and follow these instructions:*

- 1. Use only the Uniden battery pack specified in the owner's manual.
- 2. Do not dispose of the battery pack in a fire. The cell may explode. Check the nickel-cadmium battery disposal package insert for disposal instructions.
- 3. Do not open or mutilate the battery pack. Released electrolyte is corrosive and may cause damage to the eyes or skin. It may be toxic if swallowed.
- 4. Exercise care in handling the battery in order not

to short the battery with conducting materials such as rings, bracelets, and keys. The battery or conductor may overheat and cause burns.

- 5. Charge the battery pack provided with or identified for use with this product only in accordance with the instructions and limitations specified in the owner's manual provided for this product.
- 6. Observe proper polarity orientation between the battery pack and battery charger.

SAVE THESE INSTRUCTIONS!

Important Electrical Considerations

Unplug all electrical appliances when you know an electrical storm is approaching. Lightning can pass through your household wiring and damage any device connected to it. This phone is no exception.

The FCC Wants You To Know

Changes or modifications to this product not expressly approved by Uniden, or operation of this product in any way other than as detailed by the owner's manual, could void your authority to operate this product. Your telephone complies with Part 68 of FCC Rules. You must, upon request, provide the FCC registration number and the REN to your telephone company. Both numbers are on the base unit.

NOTE: You must not connect your phone to:

- coin-operated systems
- most electronic key telephone systems

This device complies with Part 15 of the FCC rules.

Operation is subject to the following two conditions:

(1) This device may not cause harmful interference, and (2) This device must accept any interference received, including interference that may cause undesired Operation. Privacy Of Communications May Not Be Ensured When Using This Phone.

Range

Your new phone is designed to achieve the maximum possible range by transmitting and receiving according to the highest specifications set forth by the FCC. We have rated this phone to operate at a maximum distance with the qualification that the range depends upon the environment in which the telephone is used. Many factors limit range, and it would be impossible to include all the variables in our rating. The Maximum Range rating of this phone is meant to be used as a means of comparison against other range claims.

Telephone Line Problems

The FCC has granted the telephone company the right to disconnect service in the event that your phone causes problems on the telephone line. Also, the telephone company may make changes in facilities and services which may affect the operation of your unit. However, your telephone company must

give adequate notice in writing prior to such actions to allow you time for making necessary arrangements to continue uninterrupted service.

If you are having trouble with your telephone service, you must first disconnect your phone to determine if it is the cause of your problem. If you determine that it is the cause, you must leave it disconnected until the trouble has been corrected.

Radio Interference

Radio interference may occasionally cause buzzing and humming in your cordless handset, or clicking noises in the base. This interference is caused by external sources such as TV, refrigerator, vacuum cleaner, fluorescent lighting, or electrical storm. Your unit is NOT DEFECTIVE.

If these noises continue and are too distracting, please check around your home to see what appliances may be causing the problem. In addition, we recommend that the base not be plugged into a circuit that also powers a major appliance because of the potential for interference. Be certain that antenna on the unit is fully extended. In the unlikely event that you consistently hear other voices or distracting transmissions on your phone, you may be receiving radio signals from another cordless telephone or other source of interference. If you cannot eliminate this type of interference, you need to change to a different channel. Finally, it should be noted that some cordless

telephones operate at frequencies that may cause interference to nearby TVs and VCRs. To minimize or prevent such interference, the base of the cordless telephone should not be placed near or on top of a TV or VCR.

If interference is experienced, moving the cordless telephone farther away from the TV or VCR will often reduce or eliminate the interference.

More Than One Cordless Telephone

If you want to use more than one cordless telephone in your home, they must operate on different channels. Press the channel key to select a channel that provides the clearest communication.

Cordless Telephone Privacy

Cordless telephones are radio devices. Communications between the handset and base of your cordless telephone are accomplished by means of radio waves which are broadcast over the open airways. Because of the inherent physical properties of radio waves, your communications can be received by radio receiving devices other than your own cordless telephone unit. Consequently, any communications using your cordless telephone may not be private.

Installation Considerations

Selecting a Location

Before choosing a location for your new phone, there are some important guidelines you should consider:

- The location should be close to both a phone jack and continuous power outlet. (A continuous power outlet is an AC outlet which does not have a switch to interrupt its power.)
- Keep the base and handset away from sources of electrical noise such as motors or fluorescent lighting.
- The base can be placed on a desk or tabletop.
- You should charge your new phone for 15-20 hours before completing the installation or using the handset.

Telephone Line Outlets

There are two types of phone outlets:

Modular Jack

Most phone equipment available now uses modular jacks. Phone cords are fitted with a molded plastic connector which plugs into this type of jack. If you do not have modular phone jacks, contact your local telephone company for information about their installation.

Hardwired Jack

Some equipment is wired directly to a phone jack, and these types of installations require a modular jack converter. This type of installation is not difficult; however, you should contact your Uniden telephone dealer or a telephone supply store for advice about

the proper adapter or converter for your particular situation.

Connecting the Telephone Cords

Consider these safety guidelines before connecting the telephone cords:

Caution!

- Never install telephone wiring during a lightning storm.
- Never touch uninsulated telephone wires or terminals unless the telephone line has been disconnected.
- Use caution when installing or modifying telephone lines.

Applying Power to the Base

This phone requires an AC outlet, without a switch to interrupt power, and the included AC adapter. To relieve strain on the DC plug when the phone is placed on a desk or table, wrap the power cord around the strain relief notch on the back of the base.

NOTE: Place the power cord so that it does not create a trip hazard, or where it could become chafed and create a fire or other electrical hazards.

One Year Limited Warranty

Important: Evidence of original purchase is required for warranty service.

WARRANTOR: UNIDEN AMERICA CORPORATION (“Uniden”)

ELEMENTS OF WARRANTY: Uniden warrants, for one year, to the original retail owner, this Uniden Product to be free from defects in materials and craftsmanship with only the limitations or exclusions set out below.

WARRANTY DURATION: This warranty to the original user shall terminate and be of no further effect 12 months after the date of original retail sale. The warranty is invalid if the Product is (A) damaged or not maintained as reasonable or necessary, (B) modified, altered, or used as part of any conversion kits, subassemblies, or any configurations not sold by Uniden, (C) improperly installed, (D) serviced or repaired by someone other than an authorized Uniden service center for a defect or malfunction covered by this warranty, (E) used in any conjunction with equipment or parts or as part of any system not manufactured by Uniden, or (F) installed or programmed by anyone other than as detailed by the owner’s manual for this product.

STATEMENT OF REMEDY: In the event that the product does not conform to this warranty at any time while this warranty is in effect, warrantor will either, at its option, repair or replace the defective unit and

return it to you without charge for parts, service, or any other cost (except shipping and handling) incurred by warrantor or its representatives in connection with the performance of this warranty. Warrantor, at its option, may replace the unit with a new or refurbished unit. THE LIMITED WARRANTY SET FORTH ABOVE IS THE SOLE AND ENTIRE WARRANTY PERTAINING TO THE PRODUCT AND IS IN LIEU OF AND EXCLUDES ALL OTHER WARRANTIES OF ANY NATURE WHATSOEVER, WHETHER EXPRESS, IMPLIED OR ARISING BY OPERATION OF LAW, INCLUDING, BUT NOT LIMITED TO ANY IMPLIED WARRANTIES OF MERCHANTABILITY OR FITNESS FOR A PARTICULAR PURPOSE. THIS WARRANTY DOES NOT COVER OR PROVIDE FOR THE REIMBURSEMENT OR PAYMENT OF INCIDENTAL OR CONSEQUENTIAL DAMAGES. Some states do not allow this exclusion or limitation of incidental or consequential damages so the above limitation or exclusion may not apply to you.

LEGAL REMEDIES: This warranty gives you specific legal rights, and you may also have other rights which vary from state to state. This warranty is void outside the United States of America and Canada.

PROCEDURE FOR OBTAINING PERFORMANCE OF WARRANTY: If, after following the instructions in the owner's manual you are certain that the Product is defective, pack the Product carefully (preferably in its original packaging). The Product should include all

parts and accessories originally packaged with the Product. Include evidence of original purchase and a note describing the defect that has caused you to return it. The Product should be shipped freight prepaid, by traceable means, to warrantor at:

Uniden America Corporation
Parts and Service Division
4700 Amon Carter Blvd. Fort Worth, TX 76155
(800) 297-1023, 8 a.m. to 5 p.m. Central,
Monday through Friday
or visit our website at **www.uniden.com**

I.C. Notice

TERMINAL EQUIPMENT

Notice: This equipment meets the applicable Industry Canada Terminal Equipment Technical Specifications. This is confirmed by the registration number. The abbreviation, IC, before the registration number signifies that registration was performed based on a Declaration of Conformity indicating that Industry Canada technical specifications were met. It does not imply that Industry Canada approved the equipment.

Notice: The Ringer Equivalence Number (REN) for this terminal equipment is marked on the equipment itself. The REN assigned to each terminal equipment provides an indication of the maximum number of terminals allowed to be connected to a telephone interface. The termination on an interface may consist of any combination of devices subject only to the requirement that the sum of the Ringer Equivalence Numbers of all the devices does not exceed five.

RADIO EQUIPMENT

The term “IC:” before the radio certification number only signifies that Industry Canada technical specifications were met.

Operation is subject to the following two conditions: (1) this device may not cause interference, and (2) this device must accept any interference, including interference that may cause undesired operation of the device. “Privacy of communications may not be ensured when using this telephone”.

Index

A

- AC adapter information 40
- Audio boost 18

B

- Basic set up 13
- Battery pack
 - Information 40
 - Replacement and handling 34
- Beltclip installation 12

C

- Call waiting 21
- Caller ID service 28
 - Call Waiting 21
 - Deleting 30
 - Making a call 32
 - Viewing 29
- Channel 20
- Charging a battery back 8
- Cleaning contacts 36
- Connect the base unit 8
- Controls and Functions 5

D

- Dial mode 10
- Digital security code 33

E, F, G

- Earpiece volume 18
- Emergency dial 22
- Find Handset 20
- General information 40

H

- Headset installation 12

I, J, K, L

- I.C. Notice 48
- Interference 44
- Liquid Damage 39

M, N, O

- Maintenance 36
- Making a call 17

P, Q

- Precautions 41

R

- Receiving a call 17
- Redial 18
- Ringer tone 16

S

- Speed dial memory
 - Making calls from speed dial memory 27
 - Storing names and numbers in speed dial memory . . . 23

T, U

- Technical information 40
- Tone dialing switch-over 19
- Traveling out-of-range 19
- Troubleshooting 37

V, W, X, Y, Z

- Voice mail waiting indicator . 21
- Wall mounting 11
- Warranty 46

At Uniden, we'll take care of you!

If you need any assistance with this product, please call our Customer Hotline at **1-800-297-1023**

or visit our web site at **www.uniden.com**

PLEASE DO NOT RETURN THIS PRODUCT TO THE PLACE OF PURCHASE.

Our Uniden representatives will be happy to help you with any matters regarding the operation of this unit, available accessories, or any other related matters.

Thank you for purchasing a Uniden product.

Hours: M-F 8:00 AM to 5:00 PM CST.



For information on the accessibility features of this product, please call

1-800-874-9314 (V/TTY)

Uniden®

May be covered under one or more of the following U.S. patents:

4,523,058	4,595,795	4,797,916	5,381,460	5,426,690	5,434,905
5,491,745	5,493,605	5,533,010	5,574,727	5,581,598	5,650,790
5,660,269	5,661,780	5,663,981	5,671,248	5,696,471	5,717,312
5,732,355	5,754,407	5,758,289	5,768,345	5,787,356	5,794,152
5,801,466	5,825,161	5,864,619	5,893,034	5,912,968	5,915,227
5,929,598	5,930,720	5,960,358	5,987,330	6,044,281	6,070,082
6,125,277	6,253,088	6,314,278	6,418,209		

Memo

FOR
ACCESSORIES,
GO ONLINE @
WWW.UNIDEN.COM

REGISTER ONLINE TODAY!
THANK YOU FOR BUYING A UNIDEN PRODUCT.

A World Without Wires | **Uniden[®]**