

RCA

4-Line Intercom Speakerphone with Answerer and Caller ID User's Guide

Please read this manual
before operating product
for the first time.



Model 25415

Important Information

Equipment Approval Information

Your telephone equipment is approved for connection to the Public Switched Telephone Network and is in compliance with parts 15 and 68, FCC Rules and Regulations and the Technical Requirements for Telephone Terminal Equipment published by ACTA.

1 Notification to the Local Telephone Company

On the bottom of this equipment is a label indicating, among other information, the US number and Ringer Equivalence Number (REN) for the equipment. You must, upon request, provide this information to your telephone company.

The REN is useful in determining the number of devices you may connect to your telephone line and still have all of these devices ring when your telephone number is called. In most (but not all) areas, the sum of the RENs of all devices connected to one line should not exceed 5. To be certain of the number of devices you may connect to your line as determined by the REN, you should contact your local telephone company.

A plug and jack used to connect this equipment to the premises wiring and telephone network must comply with the applicable FCC Part 68 rules and requirements adopted by the ACTA. A compliant telephone cord and modular plug is provided with this product. It is designed to be connected to a compatible modular jack that is also compliant. See installation instructions for details.

Notes

- This equipment may not be used on coin service provided by the telephone company.
- Party lines are subject to state tariffs, and therefore, you may not be able to use your own telephone equipment if you are on a party line. Check with your local telephone company.
- Notice must be given to the telephone company upon permanent disconnection of your telephone from your line.
- If your home has specially wired alarm equipment connected to the telephone line, ensure the installation of this product does not disable your alarm equipment. If you have questions about what will disable alarm equipment, consult your telephone company or a qualified installer.

2 Rights of the Telephone Company

Should your equipment cause trouble on your line which may harm the telephone network, the telephone company shall, where practicable, notify you that temporary discontinuance of service may be required. Where prior notice is not practicable and the circumstances warrant such action, the telephone company may temporarily discontinue service immediately. In case of such temporary discontinuance, the telephone company must: (1) promptly notify you of such temporary discontinuance; (2) afford you the opportunity to correct the situation; and (3) inform you of your right to bring a complaint to the Commission pursuant to procedures set forth in Subpart E of Part 68, FCC Rules and Regulations.

The telephone company may make changes in its communications facilities, equipment, operations or procedures where such action is required in the operation of its business and not inconsistent with FCC Rules and Regulations. If these changes are expected to affect the use or performance of your telephone equipment, the telephone company must give you adequate notice, in writing, to allow you to maintain uninterrupted service.

Interference Information

This device complies with Part 15 of the FCC Rules. Operation is subject to the following two conditions: (1) This device may not cause harmful interference; and (2) This device must accept any interference received, including interference that may cause undesired operation.

This equipment has been tested and found to comply with the limits for a Class B digital device, pursuant to Part 15 of the FCC Rules. These limits are designed to provide reasonable protection against harmful interference in a residential installation.

This equipment generates, uses, and can radiate radio frequency energy and, if not installed and used in accordance with the instructions, may cause harmful interference to radio communications. However, there is no guarantee that interference will not occur in a particular installation.

If this equipment does cause harmful interference to radio or television reception, which can be determined by turning the equipment off and on, the user is encouraged to try to correct the interference by one or more of the following measures:

- Reorient or relocate the receiving antenna (that is, the antenna for radio or television that is "receiving" the interference).
- Reorient or relocate and increase the separation between the telecommunications equipment and receiving antenna.
- Connect the telecommunications equipment into an outlet on a circuit different from that to which the receiving antenna is connected.

If these measures do not eliminate the interference, please consult your dealer or an experienced radio/television technician for additional suggestions. Also, the Federal Communications Commission has prepared a helpful booklet, "How To Identify and Resolve Radio/TV Interference Problems." This booklet is available from the U.S. Government Printing Office, Washington, D.C. 20402. Please specify stock number 004-000-00345-4 when ordering copies.

FCC RF Radiation Exposure Statement

This equipment complies with FCC RF radiation exposure limits set forth for an uncontrolled environment. This equipment should be installed and operated with a minimum distance of 20 centimeters between the radiator and your body. This transmitter must not be co-located or operated in conjunction with any other antenna or transmitter."

For body worn operation, this phone has been tested and meets the FCC RF exposure guidelines when used with the belt clip supplied with this product. Use of other accessories may not ensure compliance with FCC RF exposure guidelines.

Licensing

Licensed under US Patent 6,427,009.

Hearing Aid Compatibility

This telephone system meets FCC standards for Hearing Aid Compatibility.

US Number is located on the cabinet bottom
REN number is located on the cabinet bottom



CAUTION: When using telephone equipment, there are basic safety instructions that should always be followed. Refer to the **IMPORTANT SAFETY INSTRUCTIONS** provided with this product and save them for future reference.

Your Four-Line Speakerphone is a full-featured phone ideally suited for home-office use. It is designed to receive calls on up to four incoming telephone lines and to serve up to 16 station users. Your phone features 16 memory locations, 94 phone book memories, hold, conference call, intercom, call transfer, Caller ID display, and speakerphone capabilities. It also features an Auto Attendant function, which will pick up and redirect incoming calls to other extensions in the system per the caller's input. **It is possible to enhance your phone to a cordless feature with the additional purchase of the H5400 accessory handset and module.**

This telephone is designed to be simple to use, however, you can reach its full potential more quickly by taking a few minutes to read this user's guide.

IMPORTANT: In order to use all of the Caller ID features of this telephone, you must subscribe to two separate services available from your local telephone company: the standard Name/Number Caller ID Service to know who is calling when the phone rings and Call Waiting Caller ID Service to know who is calling while you are on the phone

WARNING: TO PREVENT FIRE OR ELECTRICAL SHOCK HAZARD, DO NOT EXPOSE THIS PRODUCT TO RAIN OR MOISTURE.



	<p>CAUTION: RISK OF ELECTRIC SHOCK DO NOT OPEN</p>	
<p>THE LIGHTNING FLASH AND ARROW HEAD WITHIN THE TRIANGLE IS A WARNING SIGN ALERTING YOU OF "DANGEROUS VOLTAGE" INSIDE THE PRODUCT.</p>	<p>CAUTION: TO REDUCE THE RISK OF ELECTRIC SHOCK, DO NOT REMOVE COVER (OR BACK). NO USER SERVICEABLE PARTS INSIDE. REFER SERVICING TO QUALIFIED SERVICE PERSONNEL.</p>	<p>THE EXCLAMATION POINT WITHIN THE TRIANGLE IS A WARNING SIGN ALERTING YOU OF IMPORTANT INSTRUCTIONS ACCOMPANYING THE PRODUCT.</p>
<p>SEE MARKING ON BOTTOM / BACK OF PRODUCT</p>		

Table of Contents

EQUIPMENT APPROVAL INFORMATION	2	Providing Privacy	18
INTERFERENCE INFORMATION	2	VOLUME	18
FCC RF RADIATION EXPOSURE STATEMENT	3	Ringer Volume	18
LICENSING	3	Speakerphone, Handset, and Headset Volume	18
HEARING AID COMPATIBILITY	3	CONFERENCE CALLS	18
PARTS CHECKLIST	5	INTERCOM CALLS	19
TELEPHONE JACK REQUIREMENTS	5	ONE-TOUCH INTERCOM	19
BASE LAYOUT	5	ANSWERING AN INTERCOM CALL	19
IMPORTANT INSTALLATION INFORMATION	6	INTERCOM HOLD	19
IMPORTANT INSTALLATION GUIDELINES	6	INTERCOM CONFERENCE CALLS	19
INSTALLING THE PHONE	6	PAGING ALL STATIONS	20
DATA PORT	8	CALLER ID	20
SYSTEM VERIFICATION	8	SUMMARY SCREEN	20
OTHER SYSTEM PHONES	8	RECEIVING AND STORING CID RECORDS	20
PROGRAMMING THE TELEPHONE	8	Reviewing CID Records	20
LANGUAGE	8	Saving CID Record to Intercom/Memory Log or Phone Book Memory	20
RINGER TONE	8	Deleting a CID Record	20
PRIORITY LINE	9	Deleting All Call Records	20
DELAY RING	9	Dialing Back	21
PHONE ID	9	IF YOU PROGRAMMED YOUR LOCAL AREA CODE	21
PHONE NAME	9	IF YOU DID NOT PROGRAM YOUR LOCAL AREA CODE	21
INTERCOM AUTO ANSWER	10	CALL WAITING CALLER ID	21
FLASH TIME	10	MEMORY LOG AND PHONE BOOK (DIRECTORY) MEMORY	21
CALL ALERT TONE	10	Storing a Number and Name in Memory	21
NO UNKNOWN/BLOCKED	10	Reviewing Phone Book (Directory) Memory	22
DISPLAY CONTRAST	11	Reviewing the Intercom/Memory Log	22
LOCAL AREA CODE	11	Editing a Name or Number Stored in Phone Book Memory	22
REGIONAL AREA CODES	11	Editing a Name or Number Stored in the Intercom/Memory Log	22
MANUALLY SETTING THE TIME AND DATE	11	Storing the Last Number Dialed	22
HOUR FORMAT	12	Storing a Pause in Memory	22
RESTORING THE DEFAULT SETTINGS	12	Dialing a Stored Number	22
PROGRAMMING THE ANSWERING MACHINE	12	Memory Delete/Clear	22
PICKUP DELAY	12	Clear All Memories	23
MESSAGE LENGTH	13	Chain Dialing	23
CALL SCREENING	13	ANSWERING SYSTEM	23
MESSAGE INTERRUPT	13	ANSWERING MACHINE	23
REMOTE PASSWORD	13	TURNING THE ANSWERING SYSTEM ON/OFF	23
MAILBOX	14	RECORDING A GREETING	23
PROGRAMMING THE AUTO ATTENDANT	14	PLAYBACK AND ERASING A GREETING	23
AUTO ATTENDANT PICKUP DELAY	14	RECORDING INCOMING MESSAGES	24
SET DAY TIME FOR AUTO ATTENDANT	14	MONITORING INCOMING CALLS	24
SET NIGHT TIME FOR AUTO ATTENDANT	15	MEMO RECORDING	24
SET NIGHT TIME ON / OFF	15	TWO-WAY RECORDING	24
SET WEEKEND GREETING	15	MESSAGE PLAYBACK	24
SET VALID ID	15	DELETING MESSAGES	24
BASIC OPERATION	16	ACCESSING THE ANSWERING SYSTEM FROM ANOTHER LOCATION	25
MAKING CALLS WITH THE HANDSET	16	CONNECTING WITH THE ANSWERING SYSTEM	25
MAKING CALLS WITH THE SPEAKERPHONE	16	TOLL SAVER OPERATION	25
MAKING CALLS WITH THE OPTIONAL HEADSET	16	AUTO ATTENDANT	25
PRE-DIALING	16	TURN AUTO ATTENDANT ON/OFF	25
ANSWERING CALLS	16	AUTO ATTENDANT SEQUENCE FOR CALLERS	25
SWITCHING BETWEEN THE SPEAKERPHONE, HANDSET, AND HEADSET	17	RECORDING AUTO ATTENDANT GREETINGS	26
MUTE	17	PLAYBACK AND ERASING AUTO ATTENDANT GREETINGS	26
DO NOT DISTURB	17	USING MULTIPLE AUTO ATTENDANTS	26
HOLD	17	DISPLAY MESSAGES	27
Placing a Call on Hold	17	OPERATION BY BATTERY	27
Releasing a Call from Hold	17	OPERATION WITHOUT POWER	27
FLASH	17	CORDLESS PHONE OPTION	27
REDIAL	17	TROUBLESHOOTING GUIDE	27
REVIEWING THE REDIAL NUMBERS	17	GENERAL PRODUCT CARE	28
TRANSFERRING A CALL TO ANOTHER STATION	18	SERVICE	28
RECEIVING A TRANSFERRED CALL FROM ANOTHER STATION	18	ACCESSORY INFORMATION	28
PRIVACY	18	LIMITED WARRANTY	29

Parts Checklist

Make sure your package includes the following items:

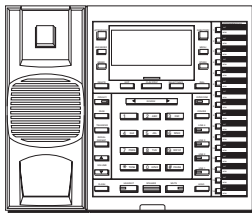

Base



Handset

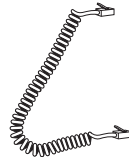

Handset cord

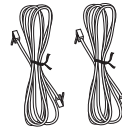

Line cords

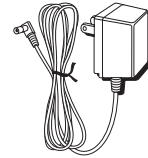

AC power adaptor

Telephone Jack Requirements

Wall plate



Modular telephone line jack

To use this phone, you will need an RJ11C (for a single line) or a RJ14C (for two lines) type modular phone jack, which might look like the one pictured here, installed in your home or office. If you don't have either modular jack, call your local phone company to find out how to get one installed.

VERY IMPORTANT: In order to achieve full system operation (i.e. intercom, page, etc.), Line 1 must be connected and must be common to all phones connected to the system. Only other RCA 25413, 25414, or 25415 or GE 29487 or 29488 models are compatible for full system operation. Connecting phones other than the RCA 25413, 25414, or 25415 or GE 29487 or 29488 to Line 1 may inhibit the intercom and paging operations.

For proper operation of intercom, page function, etc., DO NOT connect a DSL modem to Line 1.

To transfer a call from one station to another, the two stations should be connected to the same line.

Base Layout

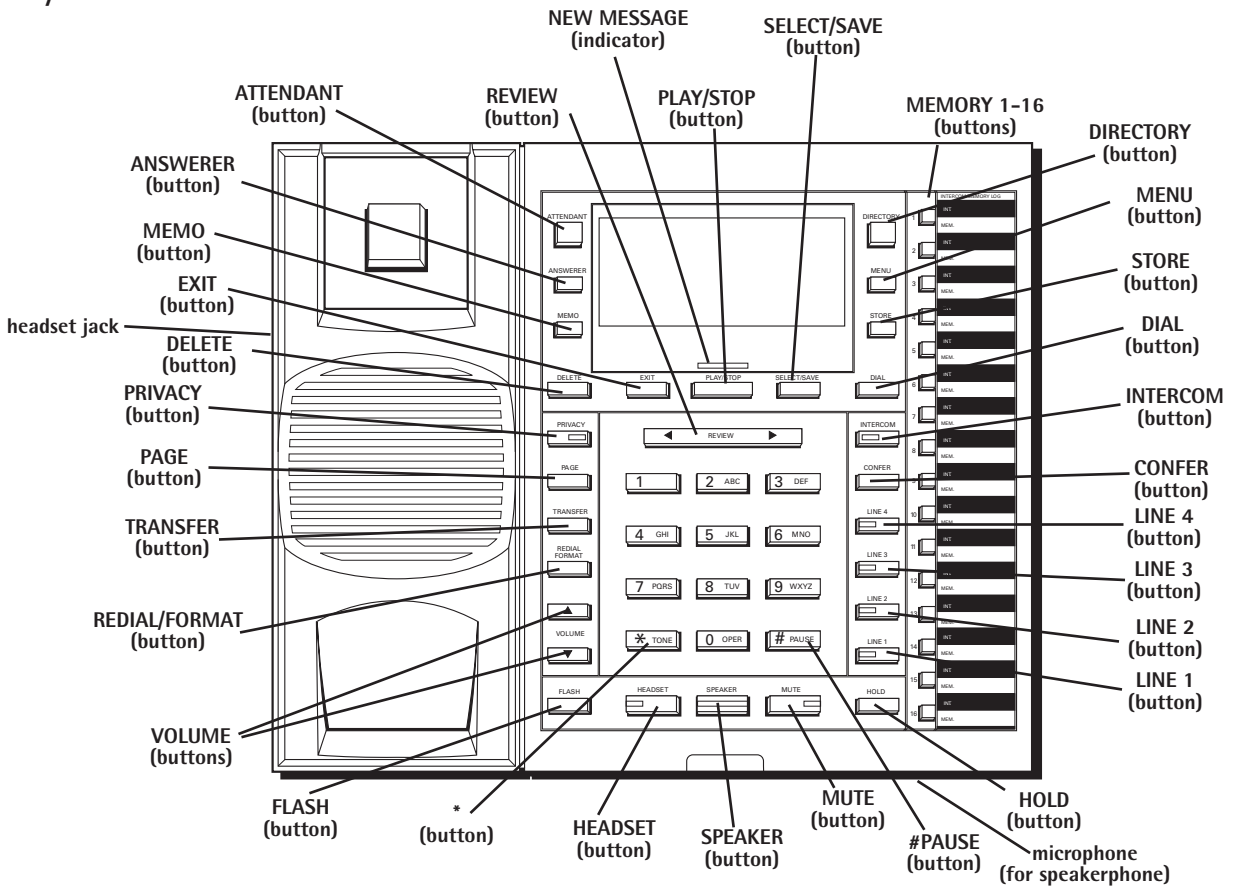

Important Installation Information

- Never install telephone wiring during a lightning storm.
- Never install telephone jacks in wet locations unless the jack is specifically designed for wet locations.
- Never touch non-insulated telephone wires or terminals, unless the telephone line is disconnected from the network.
- Use caution when installing or modifying telephone lines.
- Temporarily disconnect any equipment connected to the phone such as faxes, other phones, or modems.

Important Installation Guidelines

- Install telephone near both a telephone (modular) jack and an electrical power outlet.
- Avoid sources of noise, such as a window by a busy street, and electrical noise, such as motors, microwave ovens, and fluorescent lighting.
- Avoid heat sources, such as heating air ducts, heating appliances, radiators, and direct sunlight.
- Avoid areas of excessive moisture or extremely low temperature.
- Avoid dusty locations.
- Avoid other cordless telephones or personal computers.



CAUTION: Always disconnect all phone cords from the base unit before battery installation or replacement.

Installing the Phone

The phone may be connected to two 2-line (RJ14C) wall jacks or four single line (RJ11C) wall jacks to accommodate all four lines.

1. Choose an area near an electrical outlet and telephone wall jack. Your phone should be placed on a level surface, such as a table top or desk.

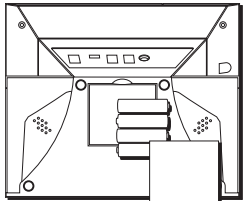

2. Install 4 AAA-size alkaline batteries (not included) for back up power in the event of a power failure.

- Use a screwdriver to loosen and lift up the battery compartment door located on the bottom of the phone.
- Insert the batteries as shown on the diagram inside the battery compartment.
- Snap the battery compartment door back into place and tighten the screw.

NOTE: If the low battery icon appears in the display, you need to replace the batteries. It is important that you replace them as soon as possible to maintain unit operation when electrical power is off. As a precaution, you may want to write down any stored information you do not want erased.

IMPORTANT: If you are not going to use the telephone for more than 30 days, remove the batteries because they can leak and damage the unit.

3. Plug the power supply cord into the power jack on the back of the base and the other end into an electrical outlet.



CAUTION: Use only the ATLINKS USA 5-2651 power adaptor that is compatible with this unit. Using other power adaptors may damage the unit.

4. Connect the telephone line cords:

If you have two dual line wall jacks installed in your home or office, plug one end of the straight telephone line cord tagged as "LINE 1+2" into the jack marked LINE 1 + 2 and one end of the other straight line cord into the other jack on the back of the base. Plug the other end of each line cord into the dual-line wall jacks.

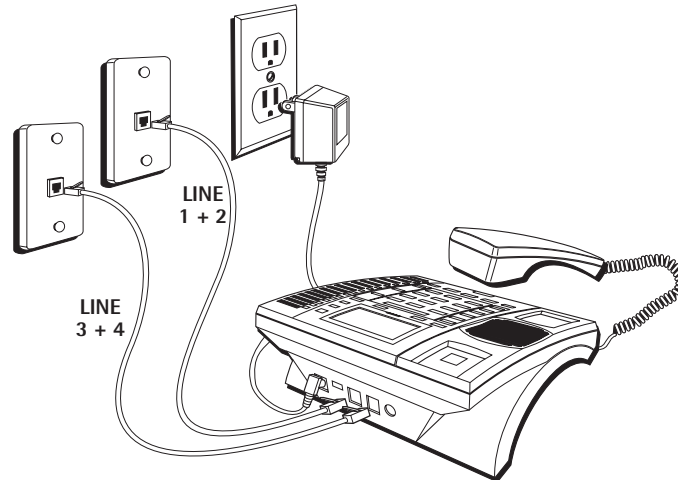

If you have four single-line wall jacks installed in your home or office, you must use adaptors/couplers (not included) to combine the four single telephone lines into two dual lines. The adaptor/coupler may look similar to the one pictured here and can be purchased from your local telephone products retailer.

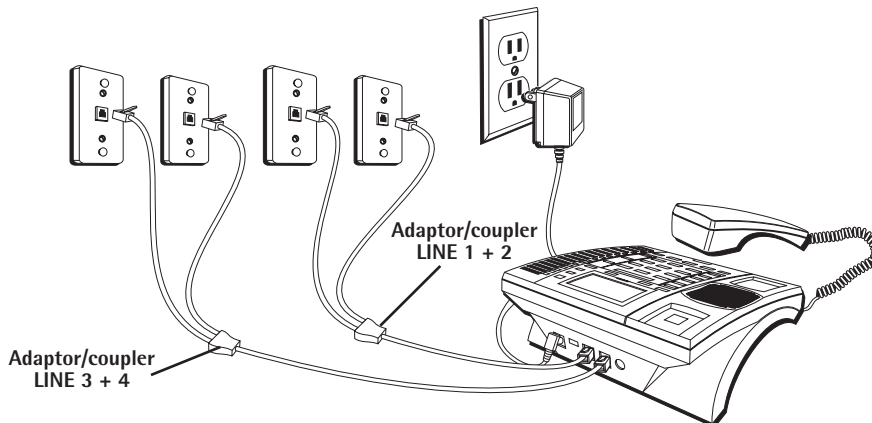

NOTE: To use four lines, you must have four telephone lines with unique telephone numbers. If you only have one telephone line, this phone will still operate, but only as a single line telephone.

Unit Initialization:

After you connect the power supply and Line 1 to the unit, the system automatically searches for and sets up a phone ID. To set your own Phone ID, or change your phone ID, follow the steps in the Phone ID section.

You may connect up to 16 RCA 25413, 25414 and/or 25415 phones to the system at one time. Features like intercom, page and call transfer may be used among the units, but Line 1 must be common for all 25413, 25414, or 25415 units for these features to work properly. You may choose to share or privatize lines 2, 3 and 4.

5. Connect the handset cord:

Connect one end of the coiled handset cord to the jack on the side of the base and the other end into the jack in the handset, and place the handset in the cradle.

6. Check for a dial tone:

Lift the handset and listen for a dial tone. If you hear a dial tone, the phone is properly installed.

Programming the Telephone

Data Port

This phone has a data port jack to connect an auxiliary phone device, such as a fax machine, computer modem, answering machine, or even a cordless phone.

The data port switch on the back of the phone controls the data port jack so you can choose line 1, line 2, line 3, or line 4.

Use the data port to hook up your fax machine, for example, and then set the data port switch to line 4 in order to receive faxes on the phone number for line 4.

If you are talking to someone on line 4 and want that person to fax something to you, change the data port switch to line 2 or line 3, and give the person on-line the phone number for line 2 or line 3. Your fax machine now can receive calls on line 2, line 3, or line 4.

IMPORTANT: Be sure to switch the fax machine back to the normal line when you are done because outside callers who do not know that you have switched lines will not be able to reach your fax machine if they dial the line 4 number.

System Verification

Use the following procedures to test system configuration and identify possible line connection errors. The phone must be connected to the power outlet, Line 1 must be connected to the LINE 1 + 2 jack, and the phone must have a phone ID.

VERY IMPORTANT: In order to achieve full system operation (i.e. intercom, page, etc.), Line 1 must be connected and common to all phones on the system. Only other 25403, 25404, 25413, 25414, or 25415 models are fully compatible.

Other System Phones

1. Press LINE 1.
2. Look at all the other stations. If they all indicate line 1 is being used, the connection is correct.
OR
1. Press the INTERCOM button. The display shows *INTERCOM* and *ENTER CALLING PHONE ID*.
2. Enter a phone ID by pressing an Intercom/Memo Log button (1-16). The display shows the phone ID you entered. If the phone ID you entered is connected to the system, you will hear a ring back tone (call through tone) at your phone. If the phone ID is not connected to the system, you will hear an error tone. *NO ANSWER* shows in the display and intercom is cancelled.

Programming the Telephone

This telephone has several programmable functions.

Language

Set the display language to show messages in either English, Spanish, or French.

1. Press the MENU button while in standby mode. The cursor in the display points to *SET LANGUAGE*.
2. Press the SELECT/SAVE button.
3. Use the < REVIEW > button to scroll to *ENGLISH, ESPANOL, or FRANCAIS*. The default is English.
4. Press the SELECT/SAVE button to save.

Ringer Tone

The ringers for all four lines may be set independent of one another.

1. Press the MENU button while in standby mode.
2. Use the < REVIEW > button to scroll to *SET PHONE OPTIONS*.
3. Press the SELECT/SAVE button.
4. Use the < REVIEW > button to scroll to *SET RING TONE*.
5. Press the SELECT/SAVE button. The ringer tone settings for each of the four telephone lines show in the display.
6. Use the < REVIEW > button to scroll to through each ringer tone for LINE 1. A sample ringer tone is generated when you scroll to individual ringer tones. Choose from eight different tones, or turn the ringer OFF.

NOTE: If you select OFF, the cursor automatically moves to the CID ON/OFF option. Use the < REVIEW > button to select CID ON or OFF. (ON allows the unit to detect and display CID records for the corresponding telephone line. OFF disables the function for the corresponding telephone.) Press the SELECT/SAVE button.

7. Press the SELECT/SAVE button to save. The cursor automatically moves to *LINE 2*.
8. Repeat steps 6 and 7 for each telephone line. After you select the ringer tone for LINE 4, press the EXIT button.

NOTE: The line indicators flash for incoming calls even if the ringer is disabled.

Priority Line

The priority line (one of the four lines) has precedence over the other three lines. When you pick up the handset or press the SPEAKER button, the unit automatically selects the priority line first. If the priority line is in use by another party, the unit will select the next available line.

1. Press the MENU button while in standby mode.
2. Use the < REVIEW > button to scroll to *SET PHONE OPTIONS*.
3. Press the SELECT/SAVE button.
4. Use the < REVIEW > button to scroll to *SET PRIORITY LINE*.
5. Press the SELECT/SAVE button.
6. Use the < REVIEW > button to scroll to *1, 2, 3, or 4*. The default is LINE 1.
7. Press the SELECT/SAVE button to save.

Delay Ring

Use this setting to delay the Central Office ring.

1. Press the MENU button while in standby mode.
2. Use the < REVIEW > button to scroll to *SET PHONE OPTIONS*.
3. Press the SELECT/SAVE button.
4. Use the < REVIEW > button to scroll to *SET DELAY RING*.
5. Press the SELECT/SAVE button.
6. Use the < REVIEW > button to scroll to 0 ring up to 10 rings.
7. Press the SELECT/SAVE button to save.

NOTE: The default Delay Ring is 0. If your system has a phone with the auto attendant ON, we suggest that you set the Delay Ring to 2 rings. This allows the auto attendant to pick up the incoming call before it rings in.

Phone ID

1. Press the MENU button while in standby mode.
2. Use the < REVIEW > button to scroll to *SET PHONE OPTIONS*.
3. Press the SELECT/SAVE button.
4. Use the < REVIEW > button to scroll to *SET PHONE ID*.
5. Press the SELECT/SAVE button.
6. Press the SELECT/SAVE button again to automatically set the phone ID, or press any memory button (1-16) to assign a phone ID.

NOTE: The INTERCOM indicator will flash red and green if the ID is not programmed.

NOTE: The Phone ID (01-16) is unique. If you manually select a phone ID that belongs to another unit on the system, NOT AVAILABLE shows in the display. Press SELECT/SAVE or choose another memory button.

NOTE: If the phone cannot find an ID, determine if there are too many phones connected to the system. A maximum of 16 phones can be connected in the system at one time.

NOTE: You may press the EXIT button at any time to exit, except during the ID search.

Phone Name

1. Press the MENU button while in standby mode.
2. Use the < REVIEW > button to scroll to *SET PHONE OPTIONS*.
3. Press the SELECT/SAVE button.
4. Use the < REVIEW > button to scroll to *SET PHONE NAME*.
5. Press the SELECT/SAVE button.
6. Use the touch-tone pad to enter the phonebook name (up to 8 characters). More than one letter is stored in each of the number keys. For example, to enter "Lorraine," press the 5 key three times for the letter L. Press the 6 key three times for the letter O. Press the 7 key three times for the first letter R. Press the 7 key three times for the second letter R. Press the 2 key once for the letter A. Press the 4 key three times for the letter I. Press the 6 key two times for the letter N. Press the 3 key twice for the letter E.
7. Press the SELECT/SAVE button to save.

NOTE: The Phone Name and ID shows in the display when the phone is idle.

Programming the Telephone

Intercom Auto Answer

For "hands-free" operation, the phone can be set to answer an intercom call by automatically activating the speaker.

TIP: You may also use this feature for room monitoring.

1. Press the MENU button while in standby mode.
2. Use the < REVIEW > button to scroll to *SET PHONE OPTIONS*.
3. Press the SELECT/SAVE button.
4. Use the < REVIEW > button to scroll to *INTERCOM AUTO ANS*.
5. Press the SELECT/SAVE button.
6. Use the < REVIEW > button to choose *YES* or *NO*.
7. Press the SELECT/SAVE button to save.

Flash Time

1. Press the MENU button while in standby mode.
2. Use the < REVIEW > button to scroll to *SET PHONE OPTIONS*.
3. Press the SELECT/SAVE button.
4. Use the < REVIEW > button to scroll to *SET FLASH TIME*.
5. Press the SELECT/SAVE button.
6. Use the < REVIEW > button to scroll through the flash time options. You may choose 100ms or 600ms.
7. Press the SELECT/SAVE button to save.

NOTE: You may press the EXIT button at any time to exit.

Call Alert Tone

Turn on the Call Alert to hear a tone for incoming calls while you are on the telephone. This function notifies you that there is a incoming call while you are using the phone. If you do not want this tone to disturb your conversation, you can set it to OFF.

1. Press the MENU button while in standby mode.
2. Use the < REVIEW > button to scroll to *SET PHONE OPTIONS*.
3. Press the SELECT/SAVE button.
4. Use the < REVIEW > button to scroll to *CALL ALERT TONE*.
5. Press the SELECT/SAVE button.
6. Use the < REVIEW > button to scroll to *ON* or *OFF*.
7. Press the SELECT/SAVE button to save. The cursor automatically moves to LINE 2.
8. Repeat steps 6 and 7 for each telephone line. After you select a tone for Line 4, press the EXIT button.

No Unknown/Blocked

This option allows you to decide whether the unknown or blocked caller ID calls are saved or not. If you select YES, the unknown or blocked calls will be saved.

1. Press the MENU button while in standby mode.
2. Use the < REVIEW > button to scroll to *SET PHONE OPTIONS*.
3. Press the SELECT/SAVE button.
4. Use the < REVIEW > button to scroll to *NO UNKNOWN/BLOCKED*.
5. Press the SELECT/SAVE button.
6. Use the < REVIEW > button to scroll to *YES* or *NO*. The default is YES.
7. Press the SELECT/SAVE button to save.

Display Contrast

Adjust the display contrast to one of four contrast levels.

1. Press the MENU button while in standby mode.
2. Use the < REVIEW > button to scroll to *SET LCD CONTRAST*.
3. Press the SELECT/SAVE button. The MIN and MAX contrast scale shows on the display.
4. Use the < REVIEW > button to adjust the contrast. The display instantly adjusts with each press of the < REVIEW > button.
5. Press the SELECT/SAVE button to save the desired contrast level.

Local Area Code

1. Press the MENU button while in standby mode.
2. Use the < REVIEW > button to scroll to *SET AREA CODE*.
3. Press the SELECT/SAVE button.
4. Use the < REVIEW > button to scroll to *LOCAL AREA CODE*.
5. Press the SELECT/SAVE button. *Enter Number* shows in the display.
6. Use the touch tone pad on your phone to enter your local area code.
7. Press the SELECT/SAVE button to save.

NOTE: If you make a mistake, press DELETE to erase all digits.

Regional Area Codes

Depending on your location, you may need to set up to six regional area codes. Setting Regional Area Codes helps the phone determine the number format to display when a valid CID record is received. Call records matching any of the set regional area codes are displayed as 10 digits.

NOTE: If the CID telephone number does not display correctly, you may not be able to dial back the number from the Caller ID menu.

You may need to set regional area codes if you reside in an area which:

- uses multiple area codes
- uses overlapping area codes
- requires 10-digit dialing.

1. Press the MENU button while in standby mode.
2. Use the < REVIEW > button to scroll to *SET AREA CODE*.
3. Press the SELECT/SAVE button.
4. Use the < REVIEW > button to scroll to *REGIONAL AREA CODES*.
5. Press the SELECT/SAVE button. All six regional area code fields and *Enter Number* show in the display.
6. Use the touch tone pad on your phone to enter up to six regional area codes.
7. Press the SELECT/SAVE button to save.

NOTE: If you make a mistake, press the DELETE button to erase all digits.

Manually Setting the Time and Date

The time and date is automatically set when you receive the first CID call. To manually reset the time and date, follow the steps below.

1. Press the MENU button while in standby mode.
2. Use the < REVIEW > button to scroll to *SET TIME & DATE*.
3. Press the SELECT/SAVE button.
4. Use the < REVIEW > button to scroll to *SET CLOCK*.
5. Press the SELECT/SAVE button, and the cursor moves to the hour field.
6. Use the < REVIEW > button to select the hour.

NOTE: AM or PM will be set accordingly with selected hour

Programming the Answering Machine

7. Press the SELECT/SAVE button, and the cursor moves to the minute field.
8. Use the < REVIEW > button to select the minutes.
9. Press the SELECT/SAVE button, and the cursor moves to the month field.
10. Use the < REVIEW > button to select the month.
11. Press the SELECT/SAVE button, and the cursor moves to the date field.
12. Use the < REVIEW > button to select the date.
13. Press the SELECT/SAVE button, and the cursor moves to the day field.
14. Use the < REVIEW > button to select the day.
15. Press the SELECT/SAVE button, and the cursor moves back to the hour field.
16. Press the EXIT button.

NOTE: You may press EXIT at any step in the process. It is not necessary to re-program the complete time and date if you only want to adjust certain fields (i.e.; hour only).

Hour Format

You may set this phone to a 12 or 24-hour format. The default is 12-hour format.

1. Press the MENU button while in standby mode.
2. Use the < REVIEW > button to scroll to *SET TIME & DATE*.
3. Press the SELECT/SAVE button.
4. Use the < REVIEW > button to scroll to *SET HOUR FORMAT*.
5. Press the SELECT/SAVE button.
6. Use the < REVIEW > button to select *12-HOUR* or *24-HOUR*.
7. Press the SELECT/SAVE button to save.

Restoring the Default Settings

This feature allows you to reset the menu to the original factory default settings.

1. Press the MENU button while in standby mode.
2. Use the < REVIEW > button to scroll to *RESTORE TO DEFAULTS*.
3. Press the SELECT/SAVE button.
4. Use the < REVIEW > button to scroll to *YES* or *NO*.
5. Press the SELECT/SAVE button to save.

Programming the Answering Machine

Pickup Delay

This sets the number of rings before the answering machine picks up the call.

1. Press the MENU button while in standby mode.
2. Use the < REVIEW > button to scroll to *ANSWERING MACHINE*.
3. Press the SELECT/SAVE button.
4. Use the < REVIEW > button to scroll to *PICKUP DELAY*.
5. Press the SELECT/SAVE button.
6. Use the < REVIEW > button to scroll from 3 rings up to 10 rings, or *Toll Saver*. The default is 5 rings.
7. Press the SELECT/SAVE button to save.

NOTE: Toll Saver can save you the cost of a call when you access your message from another phone.

- If you have new messages, the unit answers after the 3rd ring.

- If you have no new messages, the unit answers after the 5th ring.

- You can hang up after the 3rd or 4th ring and save the pay telephone or long distance charge.

Message Length

This sets the maximum recording time for the caller to leave a message when the answering function is on.

1. Press the MENU button while in standby mode.
2. Use the < REVIEW > button to scroll to *ANSWERING MACHINE*.
3. Press the SELECT/SAVE button.
4. Use the < REVIEW > button to scroll to *MESSAGE LENGTH*.
5. Press the SELECT/SAVE button.
6. Use the < REVIEW > button to scroll to *No Limit, 1 minute, 2 minutes, or Greeting Only*. The default is *No Limit*.
7. Press the SELECT/SAVE button to save.

NOTE: If you select Greeting Only, once the call is picked up by answering machine, it will announce "Sorry, no one is available to answer the call. Please call again." and then drop the call.

Call Screening

If activated, it allows you to listen to incoming messages as they are recorded.

1. Press the MENU button while in standby mode.
2. Use the < REVIEW > button to scroll to *ANSWERING MACHINE*.
3. Press the SELECT/SAVE button.
4. Use the < REVIEW > button to scroll to *CALL SCREENING*.
5. Press the SELECT/SAVE button.
6. Use the < REVIEW > button to choose *ON* or *OFF*. The default is *ON*.
7. Press the SELECT/SAVE button to save.

Message Interrupt

If this feature is activated it allows you to pick up the call from another extension while the caller is leaving a message with the answering system.

1. Press the MENU button while in standby mode.
2. Use the < REVIEW > button to scroll to *ANSWERING MACHINE*.
3. Press the SELECT/SAVE button.
4. Use the < REVIEW > button to scroll to *MESSAGE INTERRUPT*.
5. Press the SELECT/SAVE button.
6. Use the < REVIEW > button to choose *ON* or *OFF*. The default is *ON*.
7. Press the SELECT/SAVE button to save.

Remote Password

To set the remote access password;

1. Press the MENU button while in standby mode.
2. Use the < REVIEW > button to scroll to *ANSWERING MACHINE*.
3. Press the SELECT/SAVE button.
4. Use the < REVIEW > button to scroll to *REMOTE PASSWORD*.
5. Press the SELECT/SAVE button.
6. Use the < REVIEW > button to choose *ON, OFF* or *SET UP PASSWORD*. The default is *OFF* and the password is 000.
7. Scroll to *SET UP PASSWORD* and then press the SELECT/SAVE button to start remote password entry. Use the touch tone pad to enter your remote password.
8. Press the SELECT/SAVE button to save.

NOTE: If you set the remote password to OFF, the unit will not accept the remote access of answering machine.

Programming the Auto Attendant

Mailbox

Selecting General Mailbox allows you to have the system answer transferred or incoming calls to all 4 lines. Or you may choose Personal Mailbox to have it answer calls to a selected line only. If you select Transfer Call Only, then the unit will answer only transferred calls.

1. Press the MENU button while in standby mode.
2. Use the < REVIEW > button to scroll to *ANSWERING MACHINE*.
3. Press the SELECT/SAVE button.
4. Use the < REVIEW > button to scroll to *MAILBOX*.
5. Press the SELECT/SAVE button.
6. Use the < REVIEW > button to choose among the following settings: *General, Personal L1, Personal L2, Personal L3, Personal L4, or Transfer Call Only*. If you select "Personal L2", the unit can answer all the transferred calls and incoming calls from L2 by answering machine. The default setting is General.
7. Press the SELECT/SAVE button to save.

Programming the Auto Attendant

Auto Attendant will pick up and redirect incoming calls to other extensions in the system per the caller's input. After you have finished programming this feature, press the ATTENDANT button on the base to activate. The button will light when Auto Attendant is activated.

Auto Attendant Pickup Delay

This sets the time delay before the call is picked up by the Auto Attendant.

1. Press the MENU button while in standby mode.
2. Use the < REVIEW > button to scroll to *AUTO ATTENDANT*.
3. Press the SELECT/SAVE button.
4. Use the < REVIEW > button to scroll to *AUTO ATT PICKUP*.
5. Press the SELECT/SAVE button.
6. Use the < REVIEW > button to scroll from 6 seconds to 13 seconds. The default pickup delay time will depend on the phone ID number.
 - with ID# set to 1 or 2, the default pickup delay time is 6 seconds
 - with ID# set to 3 or 4, the default pickup delay time is 7 seconds
 - with ID# set to 5 or 6, the default pickup delay time is 8 seconds
 - with ID# set to 7 or 8, the default pickup delay time is 9 seconds
 - with ID# set to 9 or 10, the default pickup delay time is 10 seconds
 - with ID# set to 11 or 12, the default pickup delay time is 11 seconds
 - with ID# set to 13 or 14, the default pickup delay time is 12 seconds
 - with ID# set to 15, or 16, the default pickup delay time is 13 seconds
7. Press the SELECT/SAVE button to save.

TIP: Set different Auto Attendant pickup delay times in different 25415's

Set Day Time for Auto Attendant

The Auto-Attendant Day outgoing message will be played during the Day Time you program. The pre-recorded announcement is: "Hello, please enter your party's extension. If you do not know the extension number, press zero (0), zero (0)."

1. Press the MENU button while in standby mode.
2. Use the < REVIEW > button to scroll to *AUTO ATTENDANT*.
3. Press the SELECT/SAVE button.
4. Use the < REVIEW > button to scroll to *SET DAY TIME*.
5. Press the SELECT/SAVE button, and the cursor moves to the hour field. The default is 8:00 AM.
6. Use the < REVIEW > button to select the hour. AM or PM will be set accordingly with the selected hour.
7. Press the SELECT/SAVE button to save, and the cursor moves to the minutes field.
8. Use the < REVIEW > button to select the minute.
9. Press the SELECT/SAVE button to save.
10. Press the EXIT button.

Set Night Time for Auto Attendant

The Auto-Attendant Night outgoing message will be played during the Night Time you program. The pre-recorded announcement is: "Hello, please enter your party's extension. If you do not know the extension number, press zero (0), zero (0)."

1. Press the MENU button while in standby mode.
2. Use the < REVIEW > button to scroll to *AUTO ATTENDANT*.
3. Press the SELECT/SAVE button.
4. Use the < REVIEW > button to scroll to *SET NIGHT TIME*.
5. Press the SELECT/SAVE button, and the cursor moves to the hour field. The default is 5:00 PM.
6. Use the < REVIEW > button to select the hour. AM or PM will be set accordingly with the selected hour.
7. Press the SELECT/SAVE button to save, and the cursor moves to the minutes field.
8. Use the < REVIEW > button to select the minute.
9. Press the SELECT/SAVE button to save.
10. Press the EXIT button.

Set Night Time ON / OFF

If this feature is set to ON, the Auto Attendant Day Greeting will play during the time you designate as Day Time, and during the time you have designated as Night Time, the Auto Attendant Night Greeting will be activated.

If this feature is set to OFF, the unit will play the Auto Attendant Day Greeting at all times.

1. Press the MENU button while in standby mode.
2. Use the < REVIEW > button to scroll to *AUTO ATTENDANT*.
3. Press the SELECT/SAVE button.
4. Use the < REVIEW > button to scroll to *NIGHT TIME ON/OFF*.
5. Press the SELECT/SAVE button.
6. Use the < REVIEW > button to choose *ON* or *OFF*. The default is OFF.
7. Press the SELECT/SAVE button to save.

Set Weekend Greeting

There are two options for you to select from for your Weekend Greeting. The Night Greeting option will play your Night Greeting from Friday night until Monday morning, the Same As Weekday greeting will play your weekday greeting throughout the weekend.

1. Press the MENU button while in standby mode.
2. Use the < REVIEW > button to scroll to *AUTO ATTENDANT*.
3. Press the SELECT/SAVE button.
4. Use the < REVIEW > button to scroll to *WEEKEND GREETING*.
5. Press the SELECT/SAVE button.
6. Use the < REVIEW > button to choose *NIGHT GREETING* or *SAME AS WEEKDAY*. The default is SAME AS WEEKDAY.
7. Press the SELECT/SAVE button to save.

Set Valid ID

When auto attendant is turned on, the call can be forwarded to any listed extension number.

1. Press the MENU button while in standby mode.
2. Use the < REVIEW > button to scroll to *AUTO ATTENDANT*.
3. Press the SELECT/SAVE button.
4. Use the < REVIEW > button to scroll to *SET VALID ID*.
5. Press the SELECT/SAVE button.
6. Use the MEMORY LOG number key (M1 to M16) to add or delete the corresponding listed extension number.
7. Press the SELECT/SAVE button to save.

Basic Operation

Your phone provides the convenience of accessing four separate telephone lines, each obtained from the telephone company and each having its own phone number. This is generally applicable to small offices. It provides for 16 telephones (or stations) to share multiple lines. Each station is interconnected to all others by an intercom.

Making Calls with the Handset

1. Pick up the handset and the phone automatically selects the priority line. If the priority line is occupied, it selects an open line.

OR

Pick up the handset and press a LINE button to select a line.

2. Wait for a dial tone, then dial a phone number.
3. Hang up the handset when finished.

Making Calls with the Speakerphone

1. Press the SPEAKER button and the phone automatically selects the priority line. If the priority line is occupied, it selects an open line.

OR

Press a LINE button to select a line.

2. Wait for a dial tone then dial a phone number.
3. Press SPEAKER button when finished.

NOTE: Only one-way conversation is possible in speakerphone mode. When you are speaking, you are transmitting. When you are listening, you are receiving. You can't do both at the same time. The phone will automatically switch between transmitting and receiving depending on the level of the voice or the room noise picked up by the speakerphone mic.

NOTE: If a line goes off-hook, the call timer counts time until all the lines go on hook. The timer serves for 4 lines.

Making Calls with the Optional Headset

1. Connect the headset plug to the HEADSET jack on the side of the base.
2. Adjust the headset to rest comfortably on top of your head and over your ear.
3. Move the microphone to approximately 2 to 3 inches from your mouth.
4. Press the HEADSET button and the phone automatically selects the priority line. If the priority line is occupied, it selects an open line.
5. Wait for a dial tone, then dial a phone number.
6. Press HEADSET when finished.

CAUTION: Use only the ATLINKS USA, Inc. 5-2425 headset that is compatible with this unit.

NOTE: If the headset is not connected (or if not completely inserted into headset jack), an error tone is heard when the HEADSET button is pressed.

Pre-dialing

1. With the phone idle and the handset on the cradle, manually enter the telephone number. The telephone number shows in the display.
2. Press the DIAL or SPEAKER button, or lift the handset to take a line, and the telephone number is automatically dialed.

Answering Calls

If you receive a call on the priority line,

1. Pick up the handset (handset mode), OR
2. Press the SPEAKER button (speakerphone mode), OR
3. Press the HEADSET button (headset mode).
4. When finished, hang up the handset, or press the SPEAKER button or press the HEADSET button.

If you receive a call on a line other than the priority line,

1. Pick up the handset and press the corresponding line button (handset mode), OR
2. Press the SPEAKER button and press the corresponding line button (speakerphone mode), OR
3. Press the corresponding line button, and then press the HEADSET button (headset mode).
4. When finished, hang up the handset, or press the SPEAKER button, or press the HEADSET button.

NOTE: Whether you are making or receiving a call, the caller is disconnected if you press another line without putting the call on hold first.

Switching Between the Speakerphone, Handset, and Headset

To switch to the speakerphone, press SPEAKER. The speakerphone indicator turns on. Put handset back in cradle.

To switch to the handset, pick up the handset. The speakerphone or headset turns off.

To switch to the headset, press the HEADSET button to enable the headset, and the headset indicator turns on. Hang up the handset.

Mute

To have a private, off-line conversation, use the MUTE feature. The party on the other end of the line cannot hear you, but you can still hear them.

1. Press MUTE to activate the mute feature. The mute indicator turns on.
2. Press MUTE again to turn it off.

NOTE: Switching from speakerphone to handset cancels mute.

Do Not Disturb

This feature is set at individual telephones to disable (silence) an incoming ring signal, intercom ring, or page. When there is an incoming call or an intercom call, the status indicators function as normal but the phone will not ring.

1. When the unit is idle, press the PRIVACY button. The Privacy indicator flashes and the last setting is displayed.
2. Use the < REVIEW > button to select the duration. You may choose from 15 minutes, 30 minutes, 45 minutes, 1 hour, or 2 hours and increase the duration by 1 hour intervals up to 24 hours.
3. Press the SELECT/SAVE button to confirm. The indicator blinks and the display shows how long the ringer will be disabled.
4. To cancel, press PRIVACY again or hang up the handset.

NOTE: If Intercom Auto Answer is turned ON, the unit automatically answers the intercom call even if the Do Not Disturb function is activated.

Hold

Placing a Call on Hold

Press the HOLD button to put the line in use on hold. The line indicator for the line on hold flashes green. The phone emits a beep every 30 seconds as a reminder. At the other stations, the indicator blinks red but no beep is heard.

NOTE: If you put a call on HOLD while in PRIVACY mode, no one but you can access the line on hold. Anyone trying to access the line receives an error tone.

Releasing a Call from Hold

Press the HOLD button or the corresponding LINE button to release hold.

NOTE: If you want to change modes, lift the handset to switch to the handset, or press the HEADSET button to use the headset.

NOTE: The call on hold can be picked up at any station using this procedure.

Flash

Use the FLASH button to activate custom calling services such as call waiting or call forwarding, which are available through your local phone company.

Redial

1. Pick up the handset (handset mode), or press the SPEAKER button (speakerphone mode), or press the HEADSET button (headset mode) and the priority line is automatically selected,

OR

Press a line button to select other line.

2. Press the REDIAL/FORMAT button

NOTE: The redial function will not operate if the number to be redialed contains more than 32 digits. If the number is longer than that, you will hear an error tone.

Reviewing the Redial Numbers

Your phone records up to six previously dialed phone numbers.

1. When the phone is idle, press the REDIAL/FORMAT button.
2. Use the < REVIEW > button to view the last six previously dialed numbers.
3. While the preferred number is displayed, pick up the handset or press the SPEAKER, DIAL, or a line button to dial the phone number.

NOTE: If you do not select a line button, the line is automatically seized and the number is dialed accordingly.

Transferring a Call to Another Station

1. With the caller on the line, press the TRANSFER button.
2. Press the INTERCOM/MEMORY LOG button (1-16) for the station you want to transfer the call to. The line's indicator blinks yellow until the party picks up the transferred call. Once the call is picked up, the indicator stays red. The indicator on the receiving party's line rapidly flashes red and rings during call transfer.
 - If the transferred call is not picked up at the other station within 45 seconds. The transfer cancels, the line is put on hold, and the line indicator flashes green.
 - If the party at the other station doesn't pick up the transferred call, and you want to attempt to transfer to another station, press the line button and repeat the transfer process from step 1.

Receiving a Transferred Call from Another Station

If a call is transferred to your station, the line indicator flashes red. To answer the call, press that line button.

If you are on the line when a call is transferred to you, you will hear beeps to alert you of the incoming call. Put your current call on hold by pressing HOLD, and then pick up the incoming call by pressing the corresponding line button.

NOTE: During the transfer, the only two stations that can access the line are: a) the transferring station, or; b) the station receiving the transfer.

VERY IMPORTANT: To transfer a call from one station to another, the two stations should be connected to the same line.

Privacy

While in use, a line can be secured so that no one else can listen to the conversation. This feature only applies to 25403, 25404, 25413, 25414, and 25415 phones. However, other phone which are not compatible with these models can still access the line.

Providing Privacy

At any time during a conversation, you can use the privacy feature to secure the line.

1. While on a line, press the PRIVACY button. The indicator turns on.
2. To cancel, press PRIVACY again or hang up.

NOTE: If you put a call on hold while in privacy mode, no one but you can access the line on hold.

Volume

The ringer, speaker, and handset/headset volume is set independently with the VOLUME up and down buttons. There are 8 possible volume settings per mode. The volume indicator scale is displayed during volume adjustment.

Ringer Volume

1. While the phone is on the hook, press the VOLUME up or down button. The phone rings according to the current setting.
2. Tap the up or down button to adjust the volume one level at a time. The phone stores the setting after the last button press.

NOTE: To turn the ringer off, on, or change the ringing pattern, see Setting the Ringer Tone.

Speakerphone, Handset, and Headset Volume

While the phone is in use, during the desired mode, press the VOLUME up or down buttons until you reach a comfortable listening level. The phone stores the setting after the last button press.

Conference Calls

This feature allows you to have a 3-way conversation using any combination of 2 lines.

To connect and conference

1. To make a call, press the line you want and dial the telephone number. If you already have someone on the line, skip to step 2.
2. Press the HOLD button to place the call on hold.
3. Press another line button and dial the telephone number of the party you want to conference with.
4. Press the CONFERENCE button.
5. Speak to both parties.

NOTE: If you have more than one line on hold, and you want to have a conference call, you must first select the line on which you want to conference.

To disconnect one party:

Press the line button for the person you want to continue speaking with, and the other party is automatically disconnected.

To disconnect both parties:

Hang up the handset, or press the SPEAKER or HEADSET button.

NOTE: If you press the HOLD button to put them on hold first, you may then disconnect from each party individually.

Intercom Calls

One-Touch Intercom

NOTE: If the INTERCOM indicator is turned on (solid red), the intercom is in use. You must wait until the indicator turns off before making an intercom call.

1. Press the INTERCOM/MEMORY LOG button (1-16) for the station you want to intercom with. The SPEAKER turns on.

Alternately, you may press the INTERCOM button, then press the INTERCOM/MEMORY LOG button (1-16) for the stations you want to intercom with. The speakerphone automatically turns on.

NOTE: If you want to switch to the handset, pick it up and continue speaking. To switch to the headset press the HEADSET button.

NOTE: The handset, headset, or speakerphone cannot be active when an intercom call is initiated (the handset should be on the cradle and the speakerphone and headset turned OFF)

NOTE: To abort intercom call, press SPEAKER button.

2. To end the intercom call, hang up.

NOTE: If the receiving station does not answer within 45 seconds, the intercom call is cancelled. You will hear an error tone and NO ANSWER shows in the display.

NOTE: If the intercom is in use. You will hear an error tone and ERROR INHIBITED shows in the display.

Answering an Intercom Call

When you receive an INTERCOM call, the INTERCOM indicator flashes red, and the display shows the caller's name and phone ID.

NOTE: If you want to answer with the speakerphone, press the INTERCOM or SPEAKER button. If you want to answer by headset, press the HEADSET button (the headset must be connected). To answer by handset, lift the handset.

NOTE: Press SPEAKER or lift the handset to automatically select a party. If you receive an incoming call and intercom call at the same time the unit automatically selects the ringing line.

Intercom Hold

1. Make an intercom call or answer an intercom call.
2. Press the HOLD button. The Intercom indicator flashes green.

NOTE:

- When the intercom is on hold, you may not receive another intercom.
- If the other party terminates intercom, intercom hold is also released.

Intercom Conference Calls

This feature allows you to have a 3-way conversation using the intercom feature and an open line.

1. Place a call or make an intercom call.
2. Press the HOLD button.
3. Place a call on another line or make an intercom call.
4. Press the CONFERENCE button.
5. Speak to both parties.

NOTE: If you have more than one party on hold (telephone line or intercom), you must select the line for the party you want to conference with.

To disconnect one party:

Press the line or intercom button for the person you want to continue speaking with, and the other party is automatically disconnected.

To disconnect both parties:

Hang up the handset, or press the SPEAKER button.

NOTE: If you press the HOLD button to put them on hold first, you may then disconnect from each party individually.

Caller ID

Paging All Stations

1. Lift the handset.
2. Press the PAGE button and listen for the beep. The other stations not in use automatically activate their speakerphones and receive your page.
3. Speak into the handset. You have 30 seconds to page in this mode. After 30 seconds, the page is cancelled.
4. When finished, hang up the handset.

NOTE: You will not receive a page when Do Not Disturb is turned on.

NOTE: Paging can be done with optional headset. plug in headset, press HEADSET button, the press PAGE button

Caller ID

Summary Screen

The summary screen shows the current time, current date, number of CID records to be reviewed and total number of records saved to CID memory. It is displayed until any button is pressed. Within 60 seconds of receiving a new call, the new caller information is displayed.

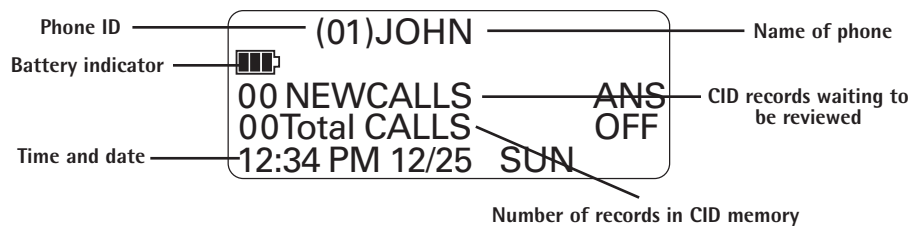

Receiving and Storing CID Records

This unit receives and displays information transmitted by your local phone company. This information can include the phone number, date and time; or the name, phone number, date and time. The unit can store up to 99 calls for later review. When the memory is full, a new call automatically replaces the oldest call in memory. *NEW* appears in the display for calls received that have not been reviewed. The line number for the call received is also displayed.

In case multiple incoming calls come in at the same time, the CID information is displayed according to the unit's priority line setting. Example: the priority line is 3.

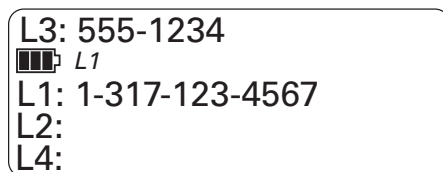

Reviewing CID Records

- Press the < REVIEW > button to scroll through the call records.

NOTE: If you press the > button, the oldest record shows in the display. If you press the < button, the most recent record shows in the display.

- When you scroll to the start/end of the list, *START/END* appears in the display.

Saving a CID Record to the Intercom/Memory Log or to Phone Book Memory

1. While a name and telephone number shows in the display, if you need to edit the information, press the SELECT/SAVE button and follow the steps for Storing a Name and Number in Memory.
2. If you do not need to edit the name or number, press the STORE button.
3. To store data in the Phone Book Directory, press the DIRECTORY button,

OR

To store data in the Intercom/Memory Log, press a memory log button (1-16).

Deleting a CID Record

To delete the record shown in the display, press the DELETE button once.

Deleting All Call Records

This feature allows you to clear all CID records at once.

1. While viewing a CID record, press and hold the DELETE button. *PRESS DELETE AGAIN CLEAR ALL CALLER ID* shows in the display.
2. Press the DELETE button again to confirm.

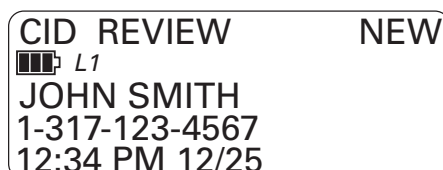

Dialing Back

When reviewing CID records, you can dial back the numbers showing on the display by pressing the DIAL button.

If You Programmed Your Local Area Code

1. Use the < REVIEW > button to display the number you want to dial.
2. If you see a number with 7 digits (i.e.555-1234), then the call was received from within your area code. However, this does not guarantee the call is a local call. If you see a number with 11 digits (i.e.1-234-555-1234), then the call received was not from your area code.
3. To adjust the phone number format, use the REDIAL/FORMAT button. For instance, a 7-digit local number sometimes cannot be dialed because it requires a 10-digit or 11-digit format. Use the REDIAL/FORMAT button to scroll through 7, 10 and 11-digit numbers.
 - 7-digits: 7-digit telephone number (i.e.555-5555)
 - 10-digits: 3-digit area code +7-digit telephone number (i.e.425-555-5555)
 - 11-digits: long distance code 1 +3-digit area code +7-digit telephone number (i.e. 1-425-555-5555)
4. To dial the displayed number, select a line or press DIAL again.

If You Did Not Program Your Local Area Code

1. Use the < REVIEW > button to display the number you want to dial. You will only see 10-digit numbers (i.e.234-555-1234).
2. Press DIAL to dial back. You may adjust the number format by pressing the REDIAL/FORMAT button before dialing.

Call Waiting Caller ID

This feature allows you to see who is calling when you hear the call waiting beep. The caller identification information appears in the display after you hear the tone.

- Press the FLASH button to put the person to whom you're talking on hold and answer the incoming call.

IMPORTANT: To use all the features of this unit, you must subscribe to either the standard Name/Number Caller ID Service or Caller ID with Call Waiting Service. To know who is calling while you are on the phone, you must subscribe to Caller ID with Call Waiting Service.

Memory Log and Phone Book (Directory) Memory

You may store data in the Phone Book Directory (up to 94 memories) or an INTERCOM/MEMORY LOG (16 buttons located to the right of the number pad on the base). The Phone Book and each INTERCOM/MEMORY LOG stores up to 21 characters and 32 digits.

Storing a Number and Name in Memory

NOTE: To cancel the storing procedure at any time, press EXIT.

1. Press the STORE button. *ENTER NUMBER* is displayed.
2. Use the touch tone pad on your telephone to enter the telephone number you want to store. The numbers you enter show in the display.

NOTE: If you make a mistake, use the < REVIEW > button to move the cursor to the incorrect digit, and press the DELETE button to delete.

3. Press SELECT/SAVE. *ENTER NAME* is displayed.
4. Use the touch-tone pad to enter a name (up to 21 characters). More than one letter is stored in each of the number keys. For example, to enter Bill Smith, press the 2 key twice for the letter B. Press the 4 key 3 times for the letter I. Press the 5 key 3 times for the letter L. Press the 5 key 3 times for the second letter L, and press the 1 key to insert a space between the first and last name. Press the 7 key 4 times for the letter S; press the 6 key once for the letter M; press the 4 key 3 times for the letter I; press the 8 key for the letter T; press the 4 key twice for the letter H.

NOTE: If you make a mistake, use the < REVIEW > button to move the cursor to the incorrect digit, and press the DELETE button to delete.

5. Press STORE button. *ENTER LOCATION* is displayed.
6. Enter memory location:

Press the DIRECTORY button to save the record in the Phone Book memory,

OR

Press a INTERCOM/MEMORY LOG button (1-16) to save the record in that memory location.

NOTE: If there is a record stored in selected memory location "OVERWRITE?" shows in the display. Press STORE to confirm overwrite or press the EXIT button, then select a new location.

7. Repeat steps 1-6 for any additional names and numbers you want to store, up to 94, in phone book memory.

NOTE: The storage procedure automatically cancels after 30 seconds if no keys are pressed.

Reviewing Phone Book (Directory) Memory

1. Press the DIRECTORY button. The first memory in the phone book is displayed (memories are stored in alphabetical order).
2. Use the < REVIEW > button to scroll through the phone book memories, or use the touch tone pad on your phone to enter the corresponding letters for the memory you want to review. For example, press the 5 key to display phone book memories that start with the letter J. Press the 5 key twice to go to memories starting with the letter K.
3. Press the EXIT button when you are finished reviewing memories.

Reviewing the Intercom/Memory Log (memory location)

1. Press the DIRECTORY button.
2. Press the INTERCOM/MEMORY LOG button (1-16).
3. Press the EXIT button when you are finished reviewing memories.

Editing a Name or Number Stored in Phone Book (Directory) Memory

1. Press the DIRECTORY button.
2. Use the < REVIEW > button to scroll to the desired memory record.
3. Press the SELECT/SAVE button and edit the content according to the steps in the Storing a Name and Number in Memory section.

Editing a Name or Number Stored in the Intercom/Memory Log (Memory Location)

1. Press the DIRECTORY button.
2. Press the INTERCOM/MEMORY LOG button (1-16).
3. Press the SELECT/SAVE button and edit the content according to the steps in the Storing a Name and Number in Memory section.

Storing the Last Number Dialed

1. When the phone is idle, press the REDIAL/FORMAT button.
2. Use the < REVIEW > button to view the last six previously dialed numbers.
3. While viewing the desired number, press the SELECT/SAVE button twice.
4. Add the name as explained in the Storing A Name and Number in Memory section.
5. Press the STORE button. *ENTER LOCATION* shows in the display.
6. Press the DIRECTORY button to store the redial number in the Phone Book memory or press an INTERCOM/MEMORY LOG button (1-16) to store the redial number in that memory location.

Storing a Pause in Memory

Press the #PAUSE button twice to insert a pause in the dialing sequence of a stored telephone number when a pause is needed (for example, when you must dial a 9 to get an outside line or when you must enter codes to access your bank's information line).

Dialing a Stored Number

1. Pick up the handset, or press SPEAKER to automatically select a line. Or press the line you want to use.
2. Wait for a dial tone.
3. Press the INTERCOM/MEMORY LOG button (1-16) for the person you want to call. The number automatically dials.
OR
1. Press the DIRECTORY button.
2. Use the < REVIEW > button to scroll through the phone book memories, or use the touch tone pad to enter the corresponding letters for the memory you want to review. For example, press the 5 key to display phone book memories that start with the letter J. Press the 5 key twice to go to memories starting with the letter K.
3. Press the DIAL button. The number automatically dials.

Memory Delete/Clear

To delete a Phone Book memory:

1. Press the DIRECTORY button.
2. Use the < REVIEW > button to scroll to the memory you want to delete.
3. Press the DELETE button to delete. *DELETE -DELETE AGAIN* shows in the display.
4. Press the DELETE button again to confirm.

To delete an INTERCOM/MEMORY LOG:

1. Press the DIRECTORY button.
2. Press the corresponding button (1-16) for the Intercom/Memory Log you want to delete.
3. Press the DELETE button to delete, *DELETE -DELETE AGAIN* shows in the display.
4. Press the DELETE button again to confirm.

NOTE: Press the EXIT button to cancel the "delete" function.

Clear All Memories

1. Press the MENU button while in standby mode.
2. Use the < REVIEW > button to scroll to *SET PHONE OPTIONS*.
3. Press the SELECT/SAVE button.
4. Use < REVIEW > button to scroll to *CLEAR ALL MEMORIES*.
5. Press the SELECT/SAVE button.
6. Use the < REVIEW > button to scroll to *Yes* or *No*, *No* is the default.
7. Press the SELECT/SAVE button to confirm.

NOTE: If you select YES, all the directory memories and direct access memories are cleared.

Chain Dialing

This process allows you to dial a succession of stored numbers from separate memory locations. This is useful when you must dial several sequences of numbers, such as with frequent calls via a telephone company long distance provider.

For example	Memory location
Local access number of long distance company	6
Authorization code (ID)	7
Long distance phone number	8

1. Press the line you want.
2. Press memory location 6.
3. Press memory location 7.
4. Press memory location 8.

Answering System

Answering Machine

You can set one or more additional phones to act as an Answering Machine (up to 16 units in the system), each Answering Machine can pick up only one line at a time. To prevent several Answering Machine units picking up the same call, you should assign different pickup delay times for each Answering Machine unit.

The Answering Machine can store approximately 60 minutes of messages, memos, and all the announcements, for a total of up to 99 messages.

Turning the Answering System On/Off

Press the ANSWERER button to switch this function on or off. The ANSWERER light is lit when the function is activated.

Recording a Greeting

1. Press the MENU button while in standby mode.
2. Use the < REVIEW > button to scroll to *ANSWERING MACHINE*
3. Press the SELECT/SAVE button.
4. Use the < REVIEW > button to scroll to *RECORD GREETING*.
5. Press the SELECT/SAVE button.
6. Wait for the beep. Then speak toward the phone in a normal tone of voice. You have a maximum 30 seconds to record your greeting
7. Press the SELECT/SAVE button to save, and the user's recorded greeting will playback once. (The default greeting is "Please leave a message after the tone.")

Playback and Erasing a Greeting

1. Press the MENU button while in standby mode.
2. Use the < REVIEW > button to scroll to *ANSWERING MACHINE*.
3. Press the SELECT/SAVE button.
4. Use the < REVIEW > button to scroll to *PLAYBACK GREETING*.
5. Press the SELECT/SAVE button.
6. The system plays the previously recorded greeting.
7. To erase the recorded greeting, press DELETE button during greeting playback. Press DELETE again to confirm the deletion. Then the default greeting will playback once after deletion.
8. To stop playback, press EXIT.

Recording Incoming Messages

The unit will answer incoming calls or routed calls after X rings (pickup delay set in MENU) and play the outgoing greeting. After hearing the greeting followed by a long beep, the caller can leave a message. The message counter shows new number of messages.

If there is a new message recorded in the unit, the "NEW MESSAGE" indicator will blink.

Note: Your unit will record a message up to the maximum length of time you set as long as the caller continues speaking. To save recording capacity, your unit will automatically stop recording after 7 seconds of silence or if there is a steady dial tone for 7 seconds.

Your unit can record up to 60 minutes of incoming messages. The maximum recording time for each incoming message can be set in MENU.

Monitoring Incoming Calls

Whenever an incoming message is being recorded you can hear it through the speaker if Call Screening is on. To take the call, pick up the handset and the system stops recording. You can interrupt the recording from another extension, if you have Message Interrupt set to ON in the menu.

Memo Recording

1. Press and hold the MEMO button for 2 seconds until you hear a beep.
2. After the beep, speak toward the phone in a normal tone of voice and record your memo.
3. To stop recording, press MEMO button again or press EXIT button. This is considered standard message and will be included in the message counter.

Two-Way Recording

While using the handset or headset, you can record a phone conversation.

1. While on a call using the handset or headset, press MEMO to begin recording the conversation.
2. Press MEMO again or press EXIT button to stop recording. This is considered standard message and will be included in the message counter.

Note: Before start to record the phone conversation, suggest you to tell the party you are speaking to that the conversation will be recorded.

Message Playback

In idle mode, press the PLAY button once. The unit starts to playback the messages.

If the unit has new messages, only the new messages will be played, otherwise all messages will be played. Unit will play messages to the end, then return to standby mode.

During each message playback, you can press REVIEW > button to skip the current message OR press < REVIEW button to replay the message playing.

If there are no messages, the unit will announce "You have NO messages".

Deleting Messages

To delete messages:

1. Press the PLAY button while in idle mode.
2. Use the < REVIEW > button to scroll to the message you want to delete.
3. Press DELETE button and MESSAGE XX DELETE? shows in the display.
4. Press the DELETE button again to confirm.

To delete all the messages:

1. Press and hold the DELETE button for 2 seconds during message playback or while in standby mode. DELETE ALL MESSAGES? shows in the display.
2. Press the DELETE button again to confirm the deletion.

NOTE: You cannot delete ALL messages while you are playing the new messages. You can only delete the messages one by one during playback.

Accessing the Answering System from Another Location

You can access many features of this answering system when you are away from your phone. To access your mailbox, you must turn on the remote function and set a three-digit remote password (see Remote Password section.)

Connecting with the Answering System

1. Call your phone number.
2. After the unit answers, enter your three digit password after playback of the greeting.
3. If the password was entered correctly, the Voice Menu will direct you to press the following buttons on your keyboard:
 - Press 2 to play messages, press 2 again to stop.
 - Press 3 to skip.
 - Press 1 to review.
 - Press 0 while playing a message to erase.
 - Press 4 to turn on and off.
 - Press 6 to play greeting.
 - Press 9 to record a greeting, press 9 again to stop taking message.
 - Press 7 to review menu again.
4. Enter the remote commands.
5. To exit remote operation, hang up. The system will automatically disconnect the call if the user does not enter a command within 10 seconds.

Toll Saver Operation

This system has a built-in automatic toll saving feature to let you know if you have received any new messages before it answers, thus saving you on long distance costs.

IF YOU HAVE SELECTED THE TOLL SAVER FUNCTION IN PICKUP DELAY, when calling the system from a remote location to check your messages, listen to the number of rings.

1. NO New Messages Received

If the phone rings more than three times, there are no new messages. You can hang up on the fourth ring before system answers, and save the cost of the call. Otherwise system will answer the call after fifth ring.

2. New Messages Received

If the system answers after only 3 rings, you have received new messages. Refer to Connecting with Answering System for remote instructions.

Auto Attendant

You can set this phone to function as the Auto-Attendant. A phone designated as an Auto-Attendant will pick up and redirect incoming calls to other extensions in the system. Each Auto-Attendant can pick up only one line at a time, so you may wish to have more than one Auto-Attendant within your system. You can designate up to 16 Auto-Attendants in your system. To prevent several units picking up the same call at once, you should assign different pickup delay times for each Auto-Attendant units.

Turn Auto Attendant On/Off

Press the ATTENDANT button to switch this function on or off. The ATTENDANT light is lit when the function is activated.

Auto Attendant Sequence for Callers

When Auto-Attendant is on, this phone automatically picks up a ringing line after the pickup time you programmed, and plays the designated Auto-Attendant greeting. When a caller enters an extension number after hearing the greeting, the Auto-Attendant transfers the call to that extension. If the requested extension doesn't pick up within 45 seconds, the Auto-Attendant takes the call back and plays the general greeting. If Auto-Attendant unit is in use, the call will be placed on hold.

Auto Attendant Operation

If the caller does not enter an extension number after hearing the message, the Auto-Attendant waits about 5 seconds and replays the ATTENDANT OGA (out-going announcement) for the caller. If the caller still does not enter an extension number within 5 seconds;

- a) the Greeting Only OGA "Sorry, no one is available to answer the call. Please call again." will be played if the answering machine is set to off.
- b) the greeting "Welcome to general delivery mailbox. Please leave your name and phone number after the tone." will be played if the answering machine is set to on and mailbox sets to general.

If the caller presses 00 after hearing the message, the Auto-Attendant Auxiliary Outgoing Message plays. The caller can then enter an extension number, and the call will be redirected.

Recording Auto Attendant Greetings

There are three different Auto Attendant outgoing messages. They are Day Greeting, Night Greeting and Auxiliary Greeting.

Day Greeting is played during the time you set as day time. The Default Day Greeting is "Hello, please enter your party's extension. If you do not know the extension number, press zero (0), zero (0)."

Night Greeting is played during the time you set as night time. The Default Night Greeting is "Hello, please enter your party's extension. If you do not know the extension number, press zero (0), zero (0)."

Auxiliary Greeting is played when an outside caller presses the "0" key twice after hearing the Day or Night message. It is supposed to be recorded by you to tell the caller about the extension number list. The Default Auxiliary Greeting is "Please enter your party's extension."

You can follow the procedures listed below to record the your own greeting.

NOTE: When recording your own Day or Night Greeting be sure to include the following statement to inform your callers of the extension list. "If you do not know the extension number, press zero (0), zero (0)."

NOTE: When recording your own Auxiliary Greeting you should include your extension listing. For example, "To reach Peter Jones, extension #1, for Mary Smith, extension #2, etc.

1. Press the MENU button while in standby mode.
2. Use the < REVIEW > button to scroll to *AUTO ATTENDANT*
3. Press the SELECT/SAVE button.
4. Use the < REVIEW > button to scroll to *RECORD GREETING*,
5. Press the SELECT/SAVE button.
6. Use the < REVIEW > button to scroll to *DAY GREETING*, or *NIGHT GREETING* or *AUXILIARY GREETING*.
7. Press the SELECT/SAVE button.
8. Wait for the beep. Then speak toward the phone in a normal tone of voice.
9. Press the SELECT/SAVE button to save, and the recorded greeting will be playback once.

Playback and Erasing Auto Attendant Greetings

1. Press the MENU button.
2. Use the < REVIEW > button to scroll to *AUTO ATTENDANT*
3. Press the SELECT/SAVE button.
4. Use the < REVIEW > button to scroll to *PLAYBACK GREETING*.
5. Press the SELECT/SAVE button.
6. Use the < REVIEW > button to scroll to *DAY GREETING*, or *NIGHT GREETING*, or *AUXILIARY GREETING*.
7. Press the SELECT/SAVE button.
8. The system plays the previously recorded greeting.
9. To erase the recorded greeting, press DELETE button during greeting playback. Press DELETE again to confirm the deletion. The default greeting will play back once after deletion.

NOTE: The default greeting cannot be deleted.

10. To stop playback, press EXIT.

Using Multiple Auto Attendants

An Auto Attendant is in use and cannot answer the incoming call when someone at that extension is:

- accessing messages, or
- using any of the lines to make or answer a call, or

- on an intercom call, or
- programming the phone, or
- when a message is being recorded at that extension.

It is preferable to set one or more additional phones to act as Auto Attendant for occasions when the primary Auto Attendant is turned off or in use. The primary Auto Attendant is the unit having the shortest pickup time, others would have longer pickup times.

Display Messages

The following special messages indicate the status of a message or the unit:

00 TOTAL CALLS	The Caller ID memory log is empty.
UNKNOWN CALLER	The incoming call does not have Caller ID service or their service area is not linked to yours. If UNKNOWN CALLER appears along with a calling number, the name information for that number was not available.
BLOCKED CALL	The caller is registered as "Private Number "and their Caller ID information is withheld.
INCOMPLETE DATA	Caller information has been interrupted or corrupted during transmission.
NO DATA	No Caller ID signal has been detected, or Caller ID service has not been activated.
START/END	You are at the beginning or the end of the Caller ID memory log.
	Battery power level is low.

Operation By Battery

If the power cord is not plugged into the unit, and the battery is available, the unit enters Battery Operation Mode. In this mode, the unit fully supports all operational features, except the intercom call function and cordless handset.

NOTE: Under battery operation mode, the RF module (optional for use with cordless handset) is not supported.

Operation without Power

If the power cord is not plugged into the unit and no battery is installed, the unit enters into No Power Operation mode. In this mode, the user may:

- 1) use the handset to manually make a call on line 1 only,
- 2) answer a call on line 1 with the handset.

Cordless Phone Option

It is possible to enhance your phone to a cordless feature with the additional purchase of the H5400 accessory handset and module. The H5400 is packaged with an RF module, when the module is properly inserted into the back of the 25415 base, the antenna icon on the display will illuminate. After registration (see user guide of model H5400) you may use your cordless handset with your phone system.

Troubleshooting Guide

No dial tone

- Check or repeat installation steps:
- Make sure the telephone line cords are connected to the phone and the wall jack. Make sure the line cords are not damaged.
- Make sure the hook switch pops up when the handset is lifted.
- Check the SPEAKER button. Make sure the indicator is off.
- Disconnect the phone from the wall jack and connect another phone to the same jack. If there is no dial tone in the second phone, the problem might be your wiring or local service.

You cannot be heard by the other party.

- Make sure the handset or headset cord is inserted properly and securely.
- Make sure the MUTE feature is not turned on.

Phone does not ring.

- Make sure the ringer is turned on.
- Make sure the Do Not Disturb feature is not activated.
- You may have too many extension phones on your line. Try unplugging some phones.
- See solutions for "No dial tone."

Troubleshooting Guide

Incoming voice too low or none at all.

- Check volume setting.

Memory dialing doesn't work

- Did you program the memory location keys correctly?
- Did you follow proper dialing sequence?

Battery icon is blank or shows only one bar

- The 4 "AAA" batteries need replacing or are improperly installed or not installed at all.

Intercom does not function correctly

- Make sure line 1 is connected properly and common to all phones on the system.
- Make sure all phone ID's (station numbers) involved have been assigned.

Transfer does not function correctly

- Make sure receiver phones (stations) have same line connected.

Intercom indicator turns red and green alternately

- The station address needs to be re-assigned due to a duplicate station address in the system.
See "Changing the Phone ID (Station Address)".

General Product Care

To keep your telephone working and looking good, follow these guidelines:

- Avoid putting the phone near heating appliances and devices that generate electrical noise (for example, motors or fluorescent lamps).
- DO NOT expose to direct sunlight or moisture.
- Avoid dropping the handset, as well as other rough treatment to the phone.
- Clean the phone with a soft cloth.
- Never use a strong cleaning agent or abrasive powder because this will damage the finish.
- Retain the original packaging in case you need to ship the phone at a later date.

Service

If trouble is experienced with this equipment, for repair or warranty information, please contact customer service at 1-800-511-3180. If the equipment is causing harm to the telephone network, the telephone company may request that you disconnect the equipment until the problem is resolved.

This product may be serviced only by the manufacturer or its authorized service agents. Changes or modifications not expressly approved by ATLINKS USA, Inc. could void the user's authority to operate this product. For instructions on how to obtain service, refer to the warranty included in this guide or call customer service at 1-800-511-3180.

Or refer inquiries to:

ATLINKS USA, Inc.

Manager, Consumer Relations

P O Box 1976

Indianapolis, IN 46206

Attach your sales receipt to the booklet for future reference or jot down the date this product was purchased or received as a gift. This information will be valuable if service should be required during the warranty period.

Purchase date _____ Name of store _____

Accessory Information

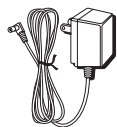

AC power adaptor

5-2651



Headset

5-2425

To place order, have your Visa, MasterCard, or Discover Card ready and call toll-free 1-800-338-0376.

A shipping and handling fee will be charged upon ordering.

We are required by law to collect appropriate sales tax for each individual state, country, and locality to which the merchandise is being sent.

Items are subject to availability. *Prices are subject to change without notice.

Limited Warranty

What your warranty covers:

- Defects in materials or workmanship.

For how long after your purchase:

- One year, from date of purchase. (The warranty period for rental units begins with the first rental or 45 days from date of shipment to the rental firm, whichever comes first.)

What we will do:

- Provide you with a new or, at our option, a refurbished unit. The exchange unit is under warranty for the remainder of the original product's warranty period.

How you get service:

- Properly pack your unit. Include any cables, etc., which were originally provided with the product. We recommend using the original carton and packing materials.
- "Proof of purchase in the form of a bill of sale or receipted invoice which is evidence that the product is within the warranty period, must be presented to obtain warranty service." For rental firms, proof of first rental is also required. Also print your name and address and a description of the defect. Send via standard UPS or its equivalent to:

ATLINKS USA, Inc.
c/o Thomson
11721 B Alameda Ave.
Socorro, Texas 79927

- Pay any charges billed to you by the Exchange Center for service not covered by the warranty.
- Insure your shipment for loss or damage. ATLINKS accepts no liability in case of damage or loss.
- A new or refurbished unit will be shipped to you freight prepaid.

What your warranty does not cover:

- Customer instruction. (Your Owner's Manual provides information regarding operating instructions and user controls. Any additional information, should be obtained from your dealer.)
- Installation and setup service adjustments.
- Batteries.
- Damage from misuse or neglect.
- Products which have been modified or incorporated into other products.
- Products purchased or serviced outside the USA.
- Acts of nature, such as but not limited to lightning damage.

Product Registration:

- Please complete and mail the Product Registration Card packed with your unit. It will make it easier to contact you should it ever be necessary. The return of the card is not required for warranty coverage.

Limitation of Warranty:

- THE WARRANTY STATED ABOVE IS THE ONLY WARRANTY APPLICABLE TO THIS PRODUCT. ALL OTHER WARRANTIES, EXPRESS OR IMPLIED (INCLUDING ALL IMPLIED WARRANTIES OF MERCHANTABILITY OR FITNESS FOR A PARTICULAR PURPOSE) ARE HEREBY DISCLAIMED. NO VERBAL OR WRITTEN INFORMATION GIVEN BY ATLINKS USA, INC., ITS AGENTS, OR EMPLOYEES SHALL CREATE A WARRANTY OR IN ANY WAY INCREASE THE SCOPE OF THIS WARRANTY.
- REPAIR OR REPLACEMENT AS PROVIDED UNDER THIS WARRANTY IS THE EXCLUSIVE REMEDY OF THE CONSUMER. ATLINKS USA, INC. SHALL NOT BE LIABLE FOR INCIDENTAL OR CONSEQUENTIAL DAMAGES RESULTING FROM THE USE OF THIS PRODUCT OR ARISING OUT OF ANY BREACH OF ANY EXPRESS OR IMPLIED WARRANTY ON THIS PRODUCT. THIS DISCLAIMER OF WARRANTIES AND LIMITED WARRANTY ARE GOVERNED BY THE LAWS OF THE STATE OF INDIANA. EXCEPT TO THE EXTENT PROHIBITED BY APPLICABLE LAW, ANY IMPLIED WARRANTY OF MERCHANTABILITY OR FITNESS FOR A PARTICULAR PURPOSE ON THIS PRODUCT IS LIMITED TO THE APPLICABLE WARRANTY PERIOD SET FORTH ABOVE.

How state law relates to this warranty:

- Some states do not allow the exclusion nor limitation of incidental or consequential damages, or limitations on how long an implied warranty lasts so the above limitations or exclusions may not apply to you.
- This warranty gives you specific legal rights, and you also may have other rights that vary from state to state.

If you purchased your product outside the USA:

- This warranty does not apply. Contact your dealer for warranty information.

A

Accessing the Answering System from Another Location 25
Accessory Information 28
Answering an Intercom Call 19
Answering Calls 16
Answering Machine 23
Answering System 23
Auto Attendant 25
Auto Attendant Pickup Delay 14
Auto Attendant Sequence for Callers 25

B

Base Layout 5
Basic Operation 16

C

Call Alert Tone 10
Call Screening 13
Call Waiting Caller ID 21
Caller ID 20
Chain Dialing 23
Clear All Memories 23
Conference Calls 18
Connecting with the Answering System 25
Cordless Phone Option 27

D

Data Port 8
Delay Ring 9
Deleting a CID Record 20
Deleting All Call Records 20
Deleting Messages 24
Dialing a Stored Number 22
Dialing Back 21
Display Contrast 11
Display Messages 27
Do Not Disturb 17

E

Editing Name Number Stored in Phone Book Memory 22
Editing Name Number Stored in the Intercom/Memory Log 22
Equipment Approval Information 2

F

FCC RF Radiation Exposure Statement 3
Flash 17
Flash Time 10

G

General Product Care 28

H

Hearing Aid Compatibility 3
Hold 17
Hour Format 12

I

If You Did Not Program Your Local Area Code 21
If You Programmed Your Local Area Code 21
Important Installation Guidelines 6
Important Installation Information 6
Installing the Phone 6
Intercom Auto Answer 10
Intercom Calls 19
Intercom Conference Calls 19
Intercom Hold 19
Interference Information 2

L

Language 8
Licensing 3
Limited Warranty 29
Local Area Code 11

M

Mailbox 14
Making Calls with the Handset 16
Making Calls with the Optional Headset 16
Making Calls with the Speakerphone 16
Manually Setting the Time and Date 11
Memo Recording 24
Memory Delete/Clear 22
Memory Log and Phone Book (Directory) Memory 21
Message Interrupt 13
Message Length 13
Message Playback 24
Monitoring Incoming Calls 24
Mute 17

N

No Unknown/Blocked 10

O

One-Touch Intercom	19
Operation By Battery	27
Operation without Power	27
Other System Phones	8

P

Paging All Stations	20
Parts Checklist	5
Phone ID	9
Phone Name	9
Pickup Delay	12
Placing a Call on Hold	17
Playback and Erasing a Greeting	23
Playback and Erasing Auto Attendant Greetings	26
Pre-dialing	16
Priority Line	9
Privacy	18
Programming the Answering Machine	12
Programming the Auto Attendant	14
Programming the Telephone	8
Providing Privacy	18

R

Receiving a Transferred Call from Another Station	18
Receiving and Storing CID Records	20
Recording a Greeting	23
Recording Auto Attendant Greetings	26
Recording Incoming Messages	24
Redial	17
Regional Area Codes	11
Releasing a Call from Hold	17
Remote Password	13
Restoring the Default Settings	12
Reviewing CID Records	20
Reviewing Phone Book (Directory) Memory	22
Reviewing the Intercom/Memory Log	22
Reviewing the Redial Numbers	17
Ringer Tone	8
Ringer Volume	18

S

Saving CID Record to Intercom/Memory Log or Phone Book Memory	20
Service	28
Set Day Time for Auto Attendant	14
Set Night Time for Auto Attendant	15
Set Night Time ON / OFF	15
Set Valid ID	15
Set Weekend Greeting	15
Speakerphone, Handset, and Headset Volume	18
Storing a Number and Name in Memory	21
Storing a Pause in Memory	22
Storing the Last Number Dialed	22
Summary Screen	20
Switching Between the Speakerphone, Handset, & Headset	17
System Verification	8

T

Telephone Jack Requirements	5
Toll Saver Operation	25
Transferring a Call to Another Station	18
Troubleshooting Guide	27
Turn Auto Attendant On/Off	25
Turning the Answering System On/Off	23
Two-Way Recording	24

U

Using Multiple Auto Attendants	26
--------------------------------	----

V

Volume	18
--------	----

Visit the RCA web site at www.rca.com

Please do not send any products to the Indianapolis address listed in this manual or on the carton. This will only add delays in service for your product.

ATLINKS USA, Inc.
101 West 103rd Street
Indianapolis, IN 46290

©2005 ATLINKS USA, Inc.
Trademark(s)® Registered
Marca(s) Registrada(s)
Model 25415
00000556 (Rev. 0 E)
05-13
Printed in China

