

# Panasonic®

## Operating Instructions

Integrated Telephone Answering System

Model No. **KX-TS4300**

**4 LINE**



This unit is compatible with Caller ID. To use this feature, you must subscribe to the appropriate service offered by your telephone service provider.

Please read these Operating Instructions before using the unit and save for future reference.

For assistance, visit our website:

**<http://www.panasonic.com/phonehelp>** for customers in the U.S.A. or Puerto Rico.

## Table of Contents

### Introduction

Introduction	4
Accessory information	5
Included accessories	5
Additional/replacement accessories	5
Sales and support information	5
Important safety instructions	6
For best performance	8

### Preparation

Symbols used in these operating instructions	9
Display	9
Location of controls	10
Battery installation	12
Setup	13
Connecting the handset and AC adaptor	14
Connecting the telephone line cords	15
Connecting the units to individual two-line telephone jacks	15
Connecting 2 two-line telephone jacks	16
Connecting four single-line telephone jacks	17
If you subscribe to a DSL service	18
Connecting 2 two-line telephone jacks	18
Connecting four single-line telephone jacks	19
Setting up the line group	20
Connecting a communication device	22
Setting the unit before use	23
Display language	23
Extension No.	23
Date and time	24
Dialing mode	24

### Making/Answering Calls

Making calls	25
Answering calls	26
Turning ringer on/off	26
Ringer type	27
Turning Do Not Disturb (DND) on/off	27
Making/answering another outside call during a conversation	28
Useful features during a call	28
Call privacy	28

HOLD button	28
Hold reminder	29
MUTE button	29
FLASH button	29
Flash time	30
Temporary tone dialing (for rotary/pulse service users)	30
Recording a telephone conversation	30

### Phonebook

Phonebook	31
Adding items to the phonebook	31
Storing items from the phonebook into the speed dialer	32
Storing items from the redial list into the phonebook	32
Finding and calling a phonebook item	33
Editing items in the phonebook	33
Erasing one item in the phonebook	34
Erasing all items in the phonebook	34
Chain dial	34

### Speed Dialer

Speed dialer	35
Speed dial preference	35
Adding/editing names and phone numbers	35
Storing items from the redial list into the speed dialer	36
Erasing a stored entry	37
Calling someone with the speed dialer	37

### Multi-unit Operation

Intercom/Paging	38
Making an intercom call	38
Answering an intercom call	38
Paging a designated extension	39
Answering a single page	39
Paging all extensions	39
Answering all pages	39
Room monitor	40
Transferring calls	40
Answering transferred calls	41
Conference calls	41

**Caller ID Service**

Using Caller ID service . . . . . 43  
 Incoming Caller ID display . . . . . 43  
 Caller list . . . . . 44  
   Viewing the caller list . . . . . 44  
   Calling back from the caller list . . . 44  
   Editing a caller's phone number  
   before calling back . . . . . 45  
   Area codes . . . . . 45  
   Storing caller information into the  
   phonebook . . . . . 46  
   Storing caller information into the  
   speed dialer . . . . . 47  
   Erasing selected caller information . 47  
   Erasing all caller information . . . . 47

**Programming**

Programmable settings . . . . . 48  
 Programming the phone setup  
 features . . . . . 51  
   Prime line . . . . . 51  
   Handsfree mode . . . . . 51  
 Programming the advanced setup  
 features . . . . . 52  
   Line group . . . . . 52  
   Reset all . . . . . 52

**Answering system**

Automated Attendant System  
 operation . . . . . 53  
   Turning Automated Attendant  
   System on/off . . . . . 53  
   Setting the Automated Attendant  
   System day and night times . . . . . 54  
   Playing back the Automated  
   Attendant System greeting  
   messages . . . . . 55  
   Recording the Automated  
   Attendant System greeting  
   messages . . . . . 55  
   Erasing the Automated Attendant  
   System greeting messages . . . . . 56  
   Using multiple Automated  
   Attendant Systems . . . . . 56  
 Answering system . . . . . 57  
   Memory capacity . . . . . 57  
   Turning the answering system  
   on/off . . . . . 57  
   Screening calls . . . . . 58

Intercept call . . . . . 58  
 Playing back the greeting  
 message . . . . . 59  
 Recording your greeting message . 59  
 Erasing your greeting message . . 59  
 Pre-recorded greeting message . . 60  
 Listening to messages . . . . . 60  
 Voice memo . . . . . 61  
   Recording a voice memo . . . . . 61  
 Remote operation . . . . . 62  
   Remote code . . . . . 62  
   Using the answering system  
   remotely . . . . . 62  
   Toll saver . . . . . 63  
   Caller's message length . . . . . 64

**Voice Mail Service**

Using Voice Mail service . . . . . 65  
 Message waiting . . . . . 65

**Useful Information**

Headset (optional) . . . . . 66  
   Sales and support information . . . 66  
   Connecting the optional headset  
   to the unit . . . . . 66  
 Wall mounting . . . . . 67  
 Connecting a standard telephone . . . 69  
 Error messages . . . . . 70  
 Troubleshooting . . . . . 70  
 FCC and other information . . . . . 75  
 Specifications . . . . . 77  
 Customer services . . . . . 78  
 Warranty . . . . . 79

**Index**

Index . . . . . 81

## **Introduction**

**Thank you for purchasing a Panasonic integrated telephone.**

We recommend keeping a record of the following information for future reference.

Serial No. \_\_\_\_\_

Date of purchase \_\_\_\_\_

(found on the bottom of the unit)

Name and address of dealer \_\_\_\_\_

┌-----┐  
| **Attach your purchase receipt here.** |  
└-----┘

## Accessory information

### Included accessories

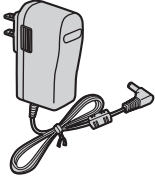
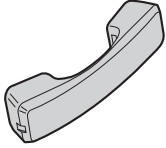
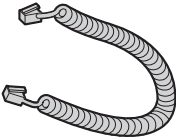
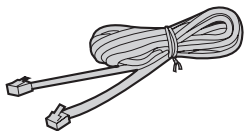
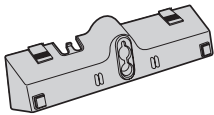
<input type="checkbox"/> AC adaptor Order No. PQLV210Z    one	<input type="checkbox"/> Handset Order No. PQJXC0401Z (Black)    one
<input type="checkbox"/> Handset cord Order No. PQJA212N (Gray)    one	<input type="checkbox"/> 4-wire telephone line cord Order No. PQJA10088Z    two
<input type="checkbox"/> Wall mounting adaptor Order No. PQYL10021Z    one	

### Additional/replacement accessories

Accessory item	Order number
Headset	KX-TCA86, KX-TCA88HA, KX-TCA91, KX-TCA92, KX-TCA93, KX-TCA94, or KX-TCA95
2-line adaptor	KX-J24
2-line splitter	KX-J42
T-adaptor	KX-J66
2-wire telephone line cord	PQJA10075Z
9 V Alkaline (6LR61) back-up battery	Use standard store bought 9 V Alkaline battery

### Sales and support information

- To order additional/replacement accessories, call 1-800-332-5368.
- TTY users (hearing or speech impaired users) can call 1-866-605-1277.

---

---

### Important safety instructions

When using the product, basic safety precautions should always be followed to reduce the risk of fire, electric shock, or personal injury.

1. Read all instructions carefully.
2. Follow all warnings and instructions marked on the product.
3. Unplug the product from power outlets before cleaning. Do not use liquid or aerosol cleaners. Use a moist cloth for cleaning.
4. Do not use the product near water, for example near a bathtub, wash bowl, kitchen sink, etc.
5. Place the product securely on a stable surface. Serious damage and/or injury may result if the product falls.
6. Do not cover slots and openings on the product. They are provided for ventilation and protection against overheating. Never place the product near radiators, or in a place where proper ventilation is not provided.
7. Use only the power source marked on the product. If you are not sure of the type of power supplied to your home, consult your dealer or local power company.
8. Do not place objects on the power cord. Install the product where no one can step or trip on the cord.
9. Do not overload power outlets and extension cords. This can result in the risk of fire or electric shock.
10. Never push any objects through slots in the product. This may result in the risk of fire or electric shock. Never spill any liquid on the product.
11. To reduce the risk of electric shock, do not disassemble the product. Take the product to an authorized service center when service is required. Opening or removing covers may expose you to dangerous voltages or other risks. Incorrect reassembly can cause electric shock when the product is subsequently used.
12. Unplug the product from power outlets and take to an authorized service center when the following conditions occur:
  - A. When the power cord is damaged or frayed.
  - B. If liquid has been spilled into the product.
  - C. If the product has been exposed to rain or water.
  - D. If the product does not work normally by following the operating instructions. Adjust only controls covered by the operating instructions. Improper adjustment may require extensive work by an authorized service center.
  - E. If the product has been dropped or physically damaged.
  - F. If the product exhibits a distinct change in performance.
13. During thunderstorms, avoid using telephones except cordless types. There may be a remote risk of an electric shock from lightning.
14. Do not use the product to report a gas leak, when in the vicinity of the leak.

## SAVE THESE INSTRUCTIONS

### CAUTION:

#### Installation

- Never install telephone wiring during a lightning storm.
- Never install telephone jacks in wet locations unless the jack is specifically designed for wet locations.
- Never touch uninsulated telephone wires or terminals unless the

telephone line has been disconnected at the network interface.

- Use caution when installing or modifying telephone lines.
- Do not touch the plug with wet hands.
- The AC adaptor is used as the main disconnect device. Ensure that the AC outlet is installed near the product and is easily accessible.

**Battery**

To reduce the risk of fire or injury to persons, read and follow these instructions.

- Use only the battery specified.
- Do not dispose of the battery in a fire. It may explode. Check with local waste management codes for special disposal instructions.
- Do not open or mutilate the battery. Released electrolyte is corrosive and may cause burns or injury to the eyes or skin. The electrolyte may be toxic if swallowed.
- Exercise care when handling the battery in order not to short the battery to conductive materials such as rings, bracelets, and keys. The battery and/or conductor may overheat and cause burns.
- Do not recharge the battery provided with or identified for use with the product. The battery may leak corrosive electrolyte or explode.
- Do not attempt to rejuvenate the battery provided with or identified for use with the product by heating. Sudden release of battery electrolyte may occur causing burns or irritation to the eyes or skin.
- Remove the battery from the product if the product will not be used for a long period of time (several months or more). During this time the battery could leak in the product.
- Discard the "dead" battery as soon as possible. The "dead" battery may leak in the product.

- Do not store the product, or the battery provided with or identified for use with the product, in high temperature areas. A battery that is stored in a freezer or refrigerator for the purpose of extending shelf life should be protected from condensation during storage and defrosting. A battery should be stabilized at room temperature prior to use after cold storage.

**WARNING:**

- To prevent the risk of fire or electrical shock, do not expose the product to rain or any type of moisture.
- Unplug the product from power outlets if it emits smoke, an abnormal smell, or makes an unusual noise. These conditions can cause fire or electric shock. Confirm that smoke has stopped emitting and contact the Panasonic Call Center at 1-800-211-PANA (1-800-211-7262).

---

---

# For best performance

---

### Environment

- Keep the product away from electrical noise generating devices, such as fluorescent lamps and motors.
- The product should be kept free from excessive smoke, dust, high temperature, and vibration.
- The product should not be exposed to direct sunlight.
- Do not place heavy objects on top of the product.
- When you leave the product unused for a long period of time, unplug the product from the power outlet.
- The product should be kept away from heat sources such as heaters, kitchen stoves, etc. It should not be placed in rooms where the temperature is less than 5 °C (41 °F) or greater than 40 °C (104 °F). Damp basements should also be avoided.

---

### Routine care

- Wipe the outer surface of the product with a soft moist cloth. Do not use benzine, thinner, or any abrasive powder.



## Symbols used in these operating instructions

Symbol	Meaning
<b>[ ]</b> : button name <b>Example:</b> <b>[MENU/SET]</b> , <b>[SP-PHONE]</b>	The words in the brackets indicate button names on the unit.
<b>Example:</b> "Ringer Type"	The words in quotations indicate the menu on the display.
<b>Example:</b> Select "Phone Setup".	Press <b>[▼]</b> or <b>[▲]</b> to select "Phone Setup".
<b>[▼]</b> <b>[▲]</b> <b>[◀◀]</b> <b>[▶▶]</b>	Press down, up, left, or right on the navigator key.

## Display

### Example:

100 new Caller ID, and 198 total Caller ID	<div style="border: 1px solid black; padding: 5px; width: fit-content;">           03:45P 02/23 MON            EXT 11            CID:100/198 MSGW            TAD:12/26 1 34         </div>	<p>— The current date and time</p> <p>— The extension number of this phone</p>
12 new messages, and 26 total messages		<p>— Message waiting information on line 1, line 3, and line 4</p>

## Location of controls

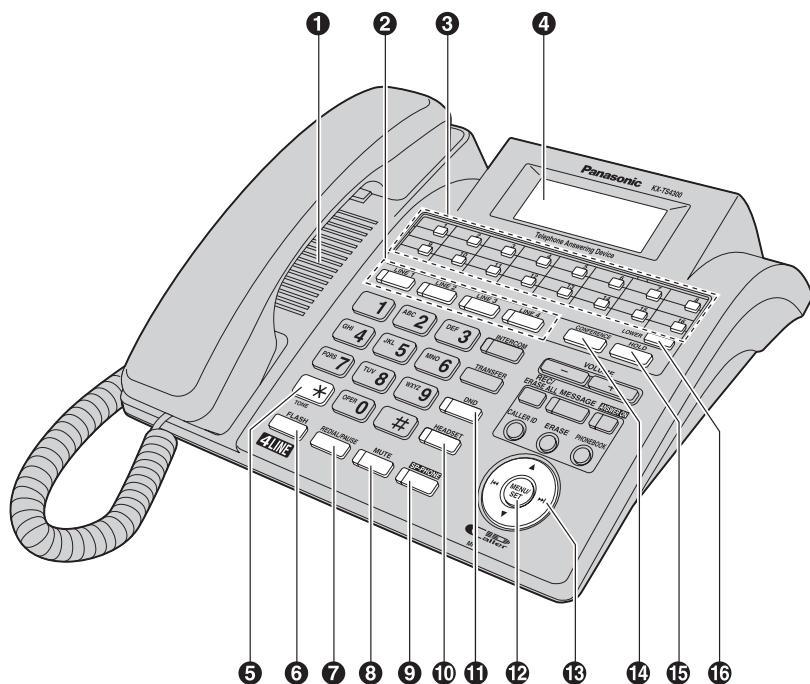

- |  |  |
|--|--|
| <b>1</b> Speaker   | <b>10</b> [HEADSET]<br>HEADSET indicator                                     |
| <b>2</b> Line buttons and indicators                     | <b>11</b> [DND] (Do Not Disturb)<br>DND indicator                            |
| <b>3</b> Speed dial (extension) buttons                  | <b>12</b> [MENU/SET]   |
| <b>4</b> Display   | <b>13</b> Navigator key ([ $\nabla$ ][ $\blacktriangle$ ][ $\ll$ ][ $\gg$ ]) |
| <b>5</b> [*] (TONE)                                      | <b>14</b> [CONFERENCE]   |
| <b>6</b> [FLASH]   | <b>15</b> [HOLD]   |
| <b>7</b> [REDIAL/PAUSE]                                  | <b>16</b> [LOWER]  |
| <b>8</b> [MUTE]<br>MUTE indicator                        |  |
| <b>9</b> [SP-PHONE] (Speakerphone)<br>SP-PHONE indicator |  |



- 17 Headset jack
- 18 [REC/ERASE ALL]
- 19 Volume key ([ - ] [ + ])
- 20 [ANSWER ON]  
ANSWER ON indicator
- 21 [INTERCOM]  
INTERCOM indicator
- 22 [TRANSFER]
- 23 [MESSAGE]  
MESSAGE indicator
- 24 [CALLER ID]
- 25 [ERASE]
- 26 [PHONEBOOK]
- 27 MIC (Microphone)

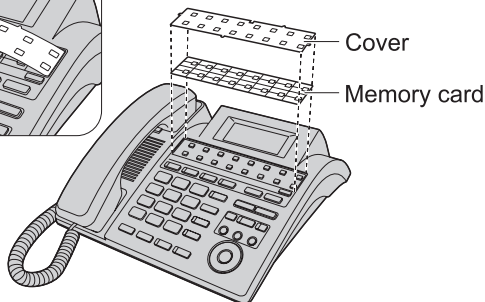

**Memory card:**  
Remove the memory card and use it as a name index for speed dialer or extensions.

### Battery installation

Install a 9 V Alkaline (6LR61) battery (sold separately) in the battery compartment. It works as emergency power during a power failure. The unit will work as a standard telephone, so that you can make or answer outside calls with the handset. (You cannot use the speakerphone, intercom, etc.)

- 1 Open the battery cover by sliding in the direction of arrow (①), and take out the battery snap (②).

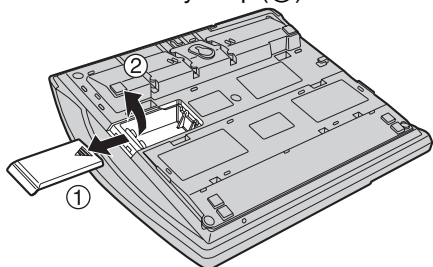

- 2 Match the polarity and snap the battery to the battery snap as shown.

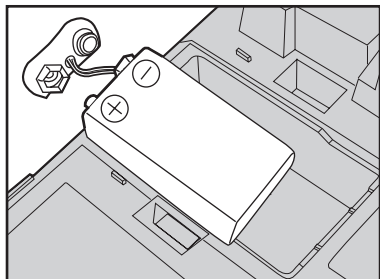

- 3 Place the battery into the battery compartment.
- 4 Dress the battery snap wire, and close the battery cover.

#### Note:

- Please refer to “Battery” on page 7 for correct battery usage.
- When the display shows “LOW BATT” with a 9 V battery in the unit, the battery needs to be changed immediately. If the battery level is too low, all LEDs might light up or flash

and the unit is not guaranteed to perform as normal during a power failure. Replacing with a fresh battery will restore normal function.

- The Manganese (6F22) battery can be used but operating time when using it will be dramatically shortened.
- It is recommended that the battery is replaced annually.
- It is recommended that the battery is replaced after a power outage.
- The battery operating time may depend on usage conditions, ambient temperature, and battery quality.
- During a power failure the battery will retain the clock memory (see “Date and time” on page 24) and the redial memory (see “Making a call using the redial list” on page 25). If you do not install the battery, the data in memory will be lost during a power failure.
- When storing or disposing of the battery, please cover the positive (+) and negative (−) terminals with tape.

#### Battery replacement

Disconnect the telephone line cord(s) before opening the battery cover.

#### Note:

- You do not need to disconnect the AC adaptor, otherwise the clock memory and the redial memory will be lost.
- Please refer to “Battery” on page 7 for correct battery usage.

#### Battery life

The battery works as **emergency power** during a power failure.

**Please remove the battery when you cut the power supply, as the battery will discharge automatically once the power is cut according to the time as follows.**

Operation	Operating time (for a Panasonic Alkaline battery)
While in use (talking)	Approx. 3 hours
While not in use (standby)	Approx. 4 hours

---

## Setup

This unit can be used in 3 positions.

---

### On the desk

#### – Normal (without the wall mounting adaptor)

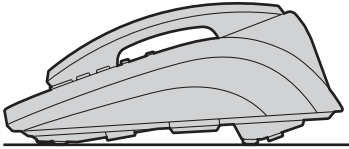

#### – With the wall mounting adaptor

You can attach the wall mounting adaptor to slope this unit.

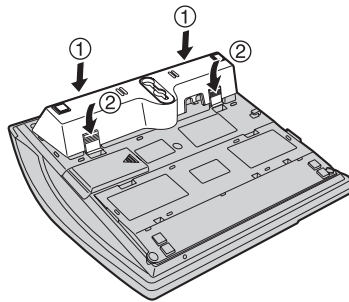
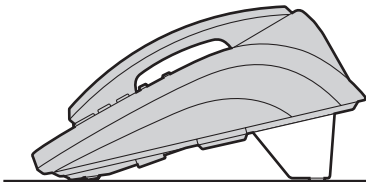

- To attach the wall mounting adaptor, push it in the direction of the arrows (① and ②) as shown.

---

### On the wall

See “Wall mounting” on page 67 for details.

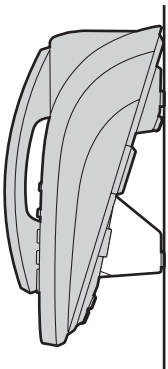

## Connecting the handset and AC adaptor

**Important:**

- Use only the included Panasonic handset PQJXC0401Z.
- Use only the included Panasonic AC adaptor PQLV210Z.

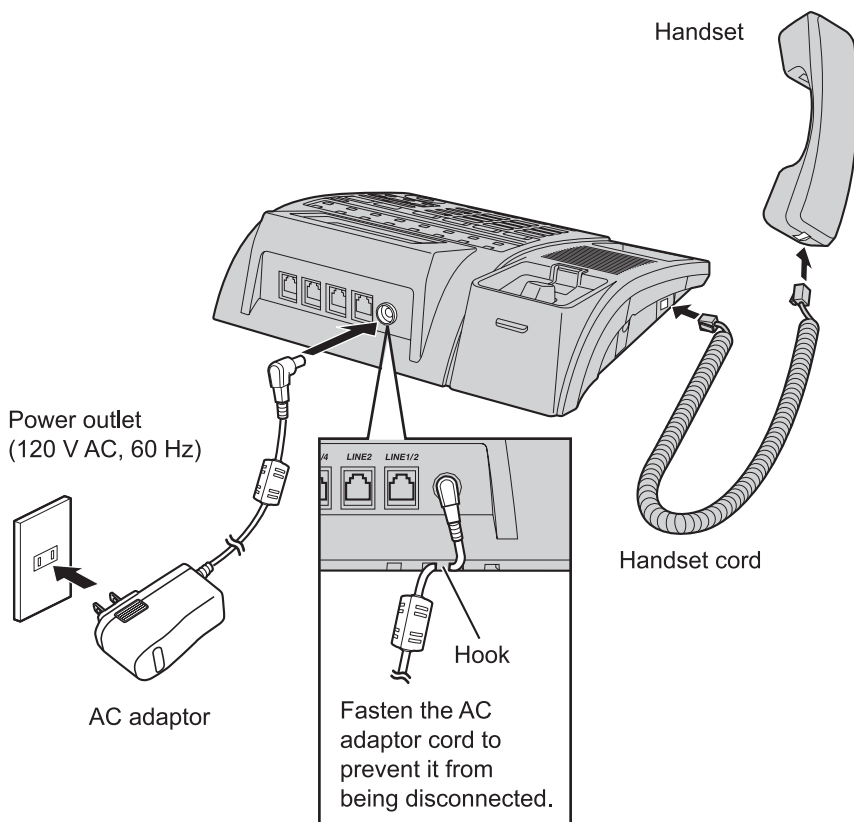

**Note:**

- The AC adaptor must remain connected at all times. (It is normal for the adaptor to feel warm during use.)
- The AC adaptor should be connected to a vertically oriented or floor-mounted AC outlet. Do not connect the AC adaptor to a ceiling-mounted AC outlet, as the weight of the adaptor may cause it to become disconnected.
- The unit will not work during a power failure. We recommend connecting a standard telephone to the same telephone line or to the same telephone jack using a Panasonic T-adaptor KX-J66 (see "Connecting a standard telephone" on page 69). Emergency power can be supplied to the unit by installing a 9 V Alkaline (6LR61) back-up battery (see "Additional/replacement accessories" on page 5).

## Connecting the telephone line cords

A maximum of 16 system phones (KX-TS4100/KX-TS4200/KX-TS4300) can be connected in parallel. To use the intercom, LINE1 must be connected at all extensions, and must be the same phone number.

### Connecting the units to individual two-line telephone jacks

Parallel connected  
two-line telephone jacks (RJ14C)

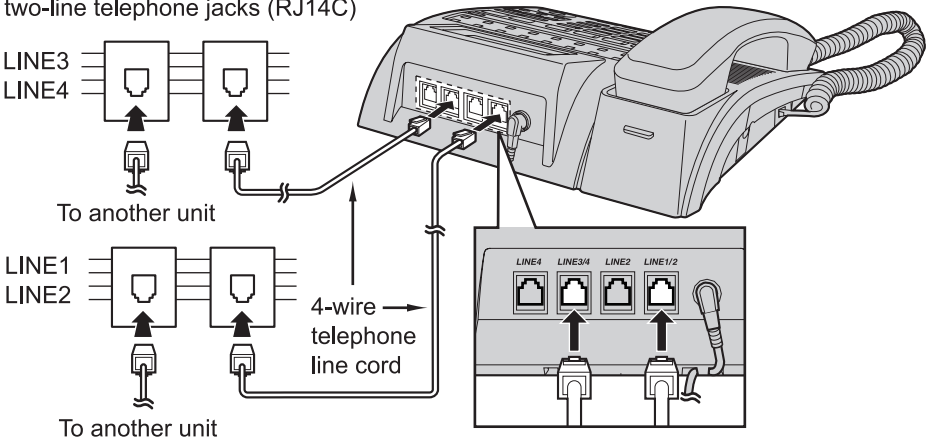

Parallel connected two-line telephone jacks (RJ14C)

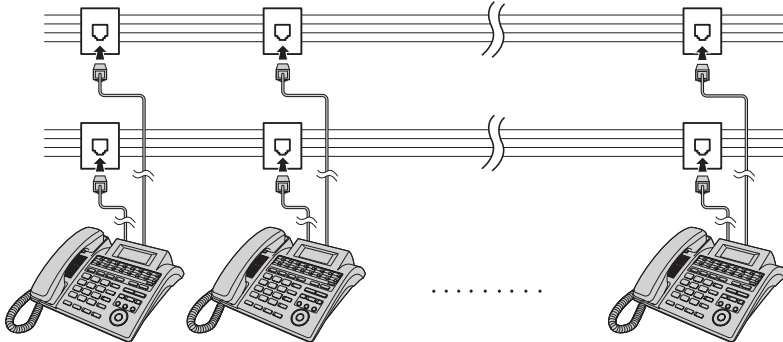

- You can connect up to 16 system phones.

#### Note:

- If a non-system phone is connected to the system phone (KX-TS4100/KX-TS4200/KX-TS4300), the line indicators of this unit will not function for that telephone.

**DSL Internet connection and KX-TS4100/KX-TS4200/KX-TS4300 Intercom work at similar frequencies. Please contact Panasonic at 1-800-211-PANA (1-800-211-7262) for special wiring configurations.**

## Connecting 2 two-line telephone jacks

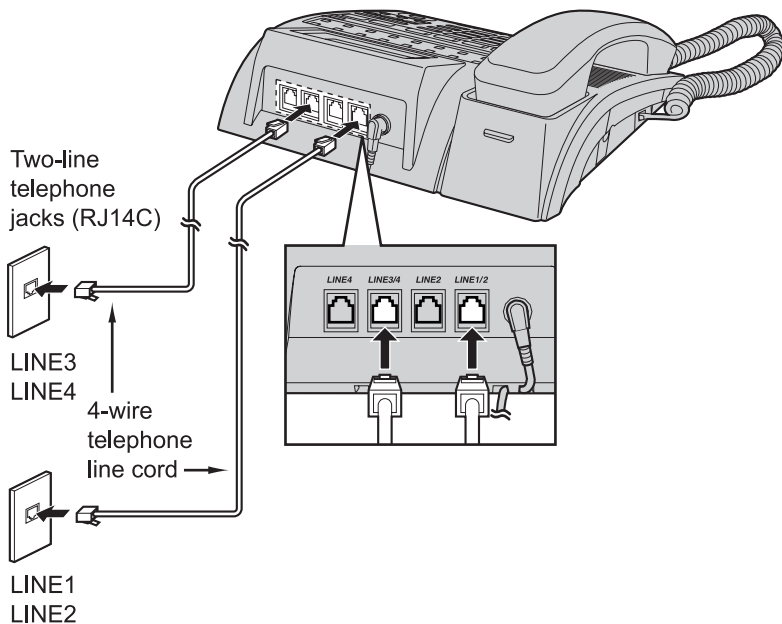

**DSL Internet connection and KX-TS4100/KX-TS4200/KX-TS4300 Intercom work at similar frequencies. Please contact Panasonic at 1-800-211-PANA (1-800-211-7262) for special wiring configurations.**



## Connecting four single-line telephone jacks

For this connection, please purchase two Panasonic 2-line adaptors KX-J24 and two 2-wire telephone line cords (Order No. PQJA10075Z) (see "Additional/replacement accessories" on page 5).

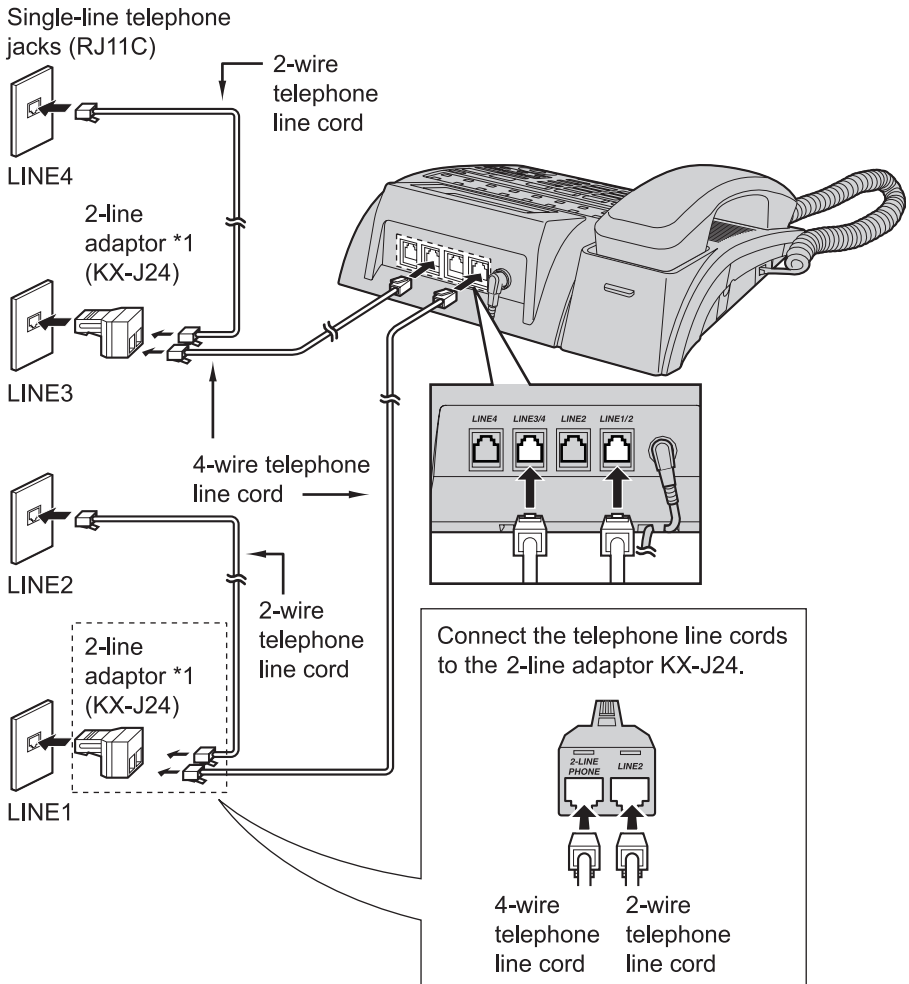

\*1 2-line adaptor merges a 2-wire (single line) telephone outlet with another 2-wire (single line) telephone line onto a single 4-wire (2-line) telephone line cord.

**DSL Internet connection and KX-TS4100/KX-TS4200/KX-TS4300 Intercom work at similar frequencies. Please contact Panasonic at 1-800-211-PANA (1-800-211-7262) for special wiring configurations.**

## If you subscribe to a DSL service

Please attach a noise filter (contact your DSL provider) to the telephone line between the unit and the telephone line jack in the event of the following:

- Noise is heard during conversations.
- Caller ID features (see “Using Caller ID service” on page 43) do not function properly.

## Connecting 2 two-line telephone jacks

For this connection, please purchase a Panasonic 2-line splitter KX-J42 and two 2-wire telephone line cords (Order No. PQJA10075Z) (see “Additional/replacement accessories” on page 5).

Example: DSL line is LINE2.

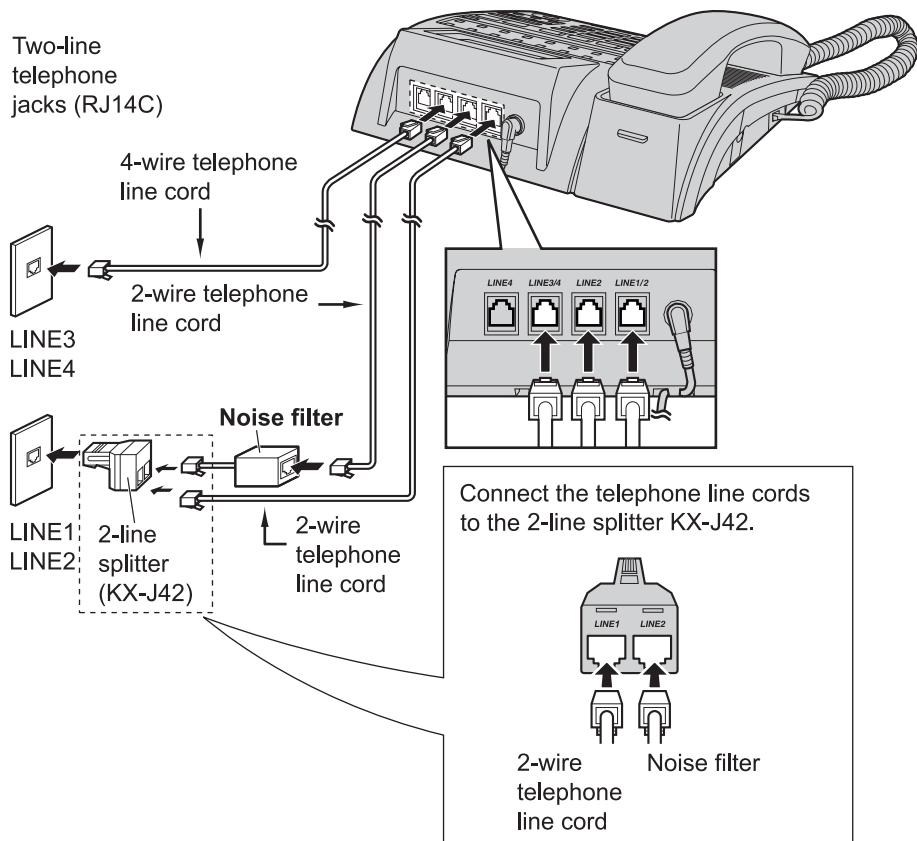

**DSL Internet connection and KX-TS4100/KX-TS4200/KX-TS4300 Intercom work at similar frequencies. Please contact Panasonic at 1-800-211-PANA (1-800-211-7262) for special wiring configurations.**

## Connecting four single-line telephone jacks

For this connection, please purchase a Panasonic 2-line adaptor KX-J24 and three 2-wire telephone line cords (Order No. PQJA10075Z) (see "Additional/replacement accessories" on page 5).

Example: DSL line is LINE2.

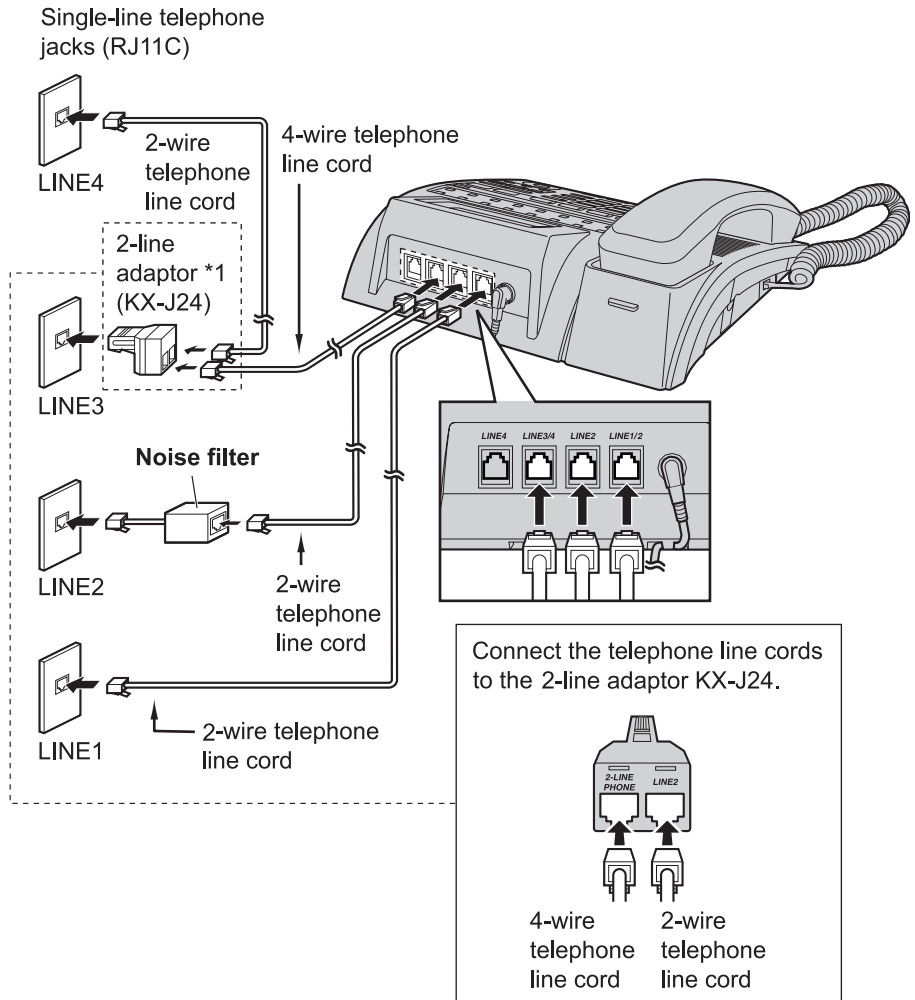

\*1 2-line adaptor merges a 2-wire (single line) telephone outlet with another 2-wire (single line) telephone line onto a single 4-wire (2-line) telephone line cord.

**DSL Internet connection and KX-TS4100/KX-TS4200/KX-TS4300 Intercom work at similar frequencies. Please contact Panasonic at 1-800-211-PANA (1-800-211-7262) for special wiring configurations.**

### Setting up the line group

If you have more than 2 system phones (KX-TS4100/KX-TS4200/KX-TS4300) and use more than 4 lines in your system phones, you can set up the line group to work correctly with the units. To program the line group, see “Line group” on page 52.

#### Important:

- You can set up the line group only for LINE4.

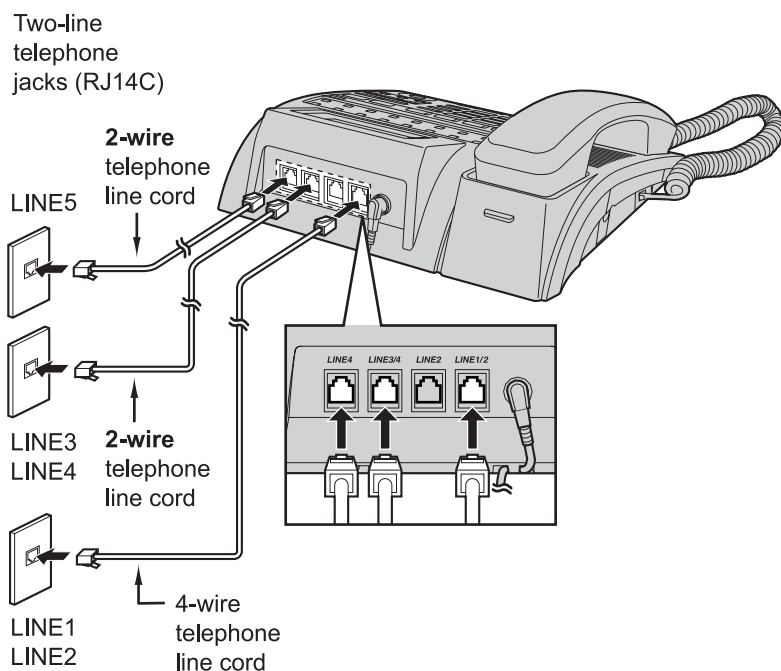

#### Note:

- You can set up the line group unconnected from other extensions (private line). To program the private line, see “Line group” on page 52.

**DSL Internet connection and KX-TS4100/KX-TS4200/KX-TS4300 Intercom work at similar frequencies. Please contact Panasonic at 1-800-211-PANA (1-800-211-7262) for special wiring configurations.**

## Example:

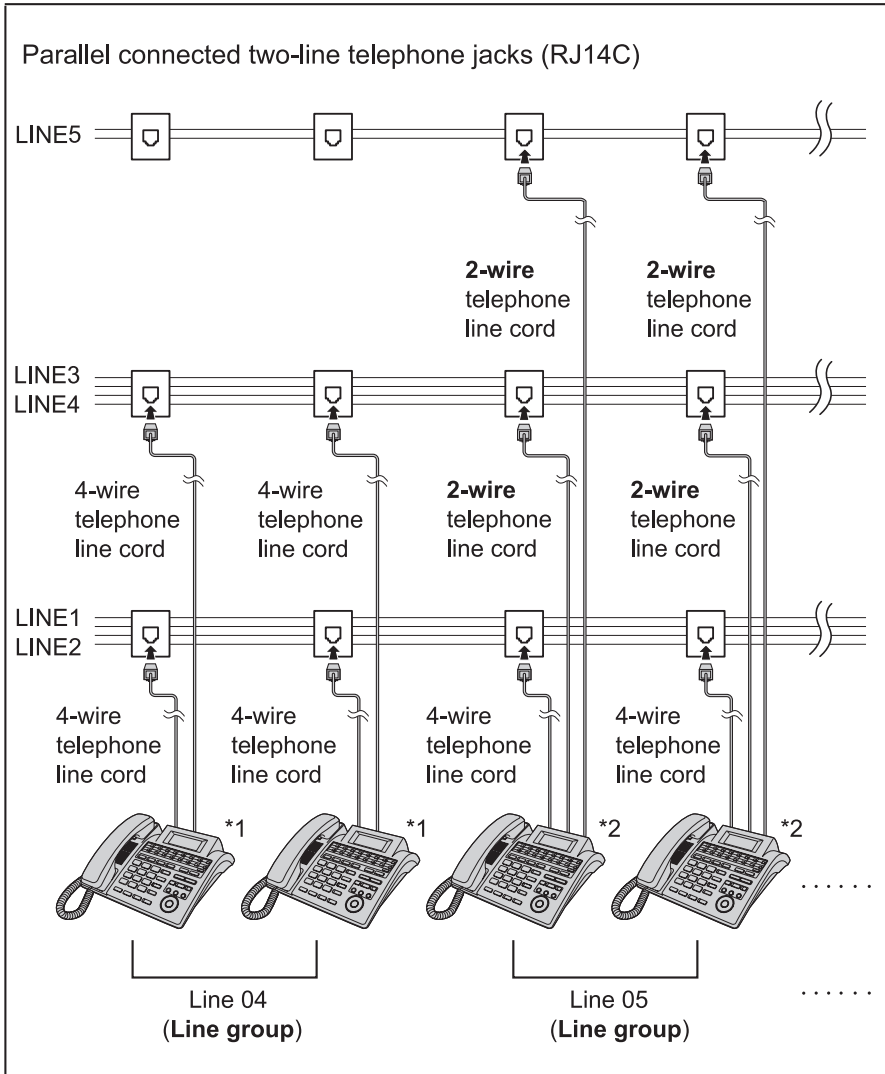

\*1 This unit uses the LINE1/2 (with 4-wire telephone line cord) and LINE3/4 (with 4-wire telephone line cord) jacks.

\*2 This unit uses the LINE1/2 (with 4-wire telephone line cord), LINE3/4 (with 2-wire telephone line cord), and LINE4 (with 2-wire telephone line cord) jacks.

**DSL Internet connection and KX-TS4100/KX-TS4200/KX-TS4300 Intercom work at similar frequencies. Please contact Panasonic at 1-800-211-PANA (1-800-211-7262) for special wiring configurations.**

## Connecting a communication device

After connecting the telephone line cords to two-line telephone jacks, you can connect a communication device (computer, modem, fax, etc.) through this unit using the LINE2 or LINE4 jacks.

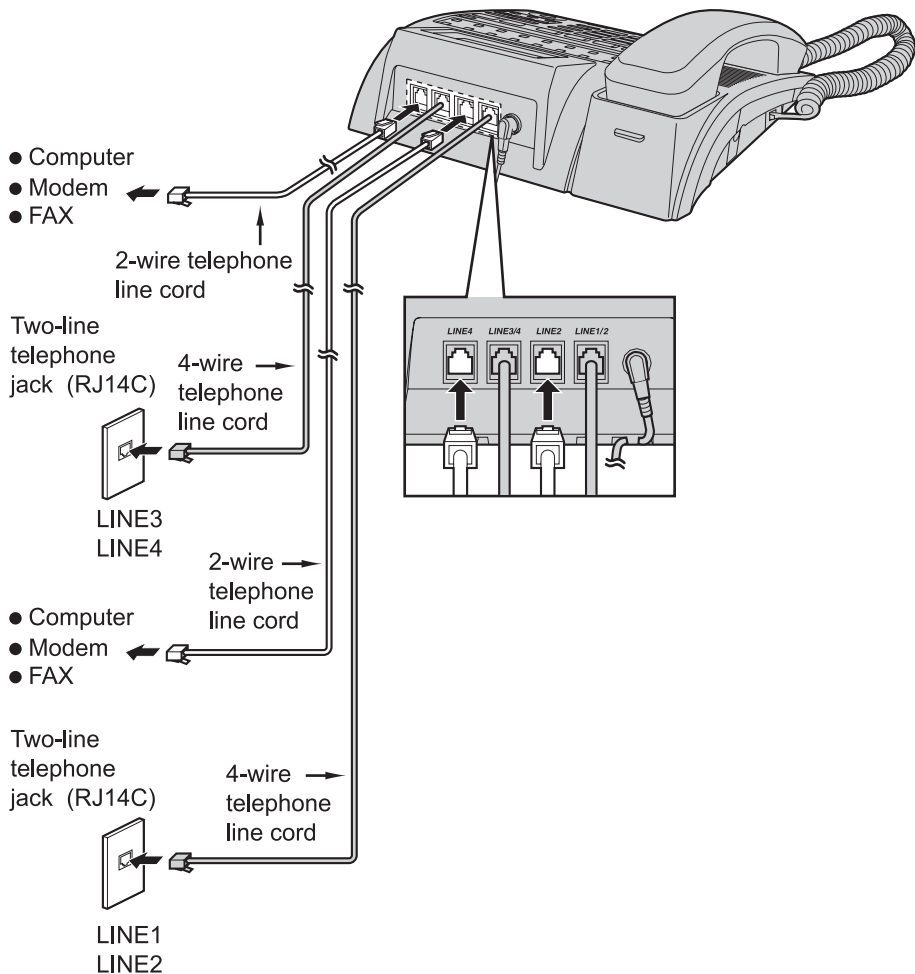

**Note:**

- If the communication device is in use, use LINE1 or LINE3 to make or answer other calls. Otherwise the communication device may not operate properly.

**DSL Internet connection and KX-TS4100/KX-TS4200/KX-TS4300 Intercom work at similar frequencies. Please contact Panasonic at 1-800-211-PANA (1-800-211-7262) for special wiring configurations.**

## Setting the unit before use

### Display language

Choose whether the display appears in English or Spanish. The default setting is "English".

#### Important:

- Make sure that the unit is in standby mode.

- 1 Press **[MENU/SET]**.
- 2 Select "Phone Setup", then press **[MENU/SET]**.
- 3 Select "Language", then press **[MENU/SET]**.

```
→Language
  Extension No.
  Date & Time
  [▼/▲]:Scroll
```

- 4 Select the desired setting, then press **[MENU/SET]**.

```
Language
=English
[SET]:Save
[▼/▲]:Change
```

- 5 Press and hold **[MENU/SET]** to return to standby mode.

#### Note:

- To return to the previous menu, press **[◀◀]**.
- If you select a language you cannot read, press **[MENU/SET]** 2 times, press **[▼]**, press **[MENU/SET]**, select the desired language, then press **[MENU/SET]**.

### Extension No.

Assign the extension number ("11" to "26") to the unit to use the intercom feature. The default setting is "11".

#### Important:

- Make sure that the unit is in standby mode.

- 1 Press **[MENU/SET]**.
- 2 Select "Phone Setup", then press **[MENU/SET]**.
- 3 Select "Extension No.", then press **[MENU/SET]**.

```
→Extension No.
  Date & Time
  Auto Mute
  [▼/▲]:Scroll
```

- 4 Select the desired number, then press **[MENU/SET]**.

```
Extension No.
=11
[SET]:Save
[▼/▲]:Change
```

#### If you try to assign an extension number which is already used:

The display shows "(In Use)".

```
Extension No.
=11 (In Use)
Please Re-Assign
Another EXT#
```

Press **[▼]** or **[▲]** to select a different extension number, then press **[MENU/SET]**.

- 5 Press and hold **[MENU/SET]** to return to standby mode.

#### Note:

- To return to the previous menu, press **[◀◀]**.
- If you are going to add another station to your existing telephone system, assign a different extension number.

### Date and time

Set the correct date and time. When you play back a message from the answering system (see “Listening to messages” on page 60), the unit announces the day and time it was recorded.

#### Important:

- Make sure that the unit is in standby mode.

- 1 Press **[MENU/SET]**.
- 2 Select “Phone Setup”, then press **[MENU/SET]**.
- 3 Select “Date & Time”, then press **[MENU/SET]**.

→Date & Time
Auto Mute
Tone/Pulse
[▼/▲]:Scroll

- 4 Enter the current year by selecting 2 digits, then press **[MENU/SET]**.

**Example:** 2006

**[0][6]**

- You can set the year 2000 to 2099.

- 5 Enter the current month and day by selecting 2 digits for each, then press **[MENU/SET]**.

**Example:** August 15

**[0][8][1][5]**

- 6 Enter the current hour and minute (12-hour clock format) by selecting 2 digits for each, then press **[MENU/SET]**.

**Example:** 9:30

**[0][9][3][0]**

- 7 Select “A” (AM) or “P” (PM), then press **[MENU/SET]**.

- 8 Press and hold **[MENU/SET]** to return to standby mode.

#### Note:

- To return to the previous menu, press **[◀◀]**.

- If you make a mistake when entering the date and time, press **[◀◀]** or **[▶▶]** to move the cursor, then make the correction.

### Dialing mode

If you cannot make calls, change this setting depending on your telephone line service. The default setting is “Tone”.

“Tone”: For tone dial service.

“Pulse”: For rotary pulse dial service.

#### Important:

- Make sure that the unit is in standby mode.

- 1 Press **[MENU/SET]**.
- 2 Select “Phone Setup”, then press **[MENU/SET]**.
- 3 Select “Tone/Pulse”, then press **[MENU/SET]**.

→Tone/Pulse
Flash Time
Hold Reminder
[▼/▲]:Scroll

- 4 Select the desired setting, then press **[MENU/SET]**.

Tone/Pulse
=Tone
[SET]:Save
[▼/▲]:Change

- 5 Press and hold **[MENU/SET]** to return to standby mode.

#### Note:

- To return to the previous menu, press **[◀◀]**.



## Making calls

### Using the handset

- 1 Lift the handset.
  - The prime line (see “Prime line” on page 51) is automatically selected and the line indicator lights.
  - The display shows the length of the call.
- 2 Dial the phone number.
  - The dialed number is displayed. If you dial a phone number longer than 15 digits, all the digits will be shifted to the left side.
- 3 When you finish talking, place the handset on the cradle.
  - The line indicator goes out.
  - The length of the call will remain on the display for a few seconds.

#### Note:

- The line indicator flashes while another phone is using the line.

### Using the speakerphone

- 1 Press **[SP-PHONE]**.
  - The SP-PHONE indicator lights.
  - The prime line (see “Prime line” on page 51) is automatically selected and the line indicator lights.
  - The display shows the length of the call.
- 2 Dial the phone number.
  - The dialed number is displayed. If you dial a phone number longer than 15 digits, all the digits will be shifted to the left side.
  - If you misdial, press **[SP-PHONE]** and start again from step 1.
- 3 When you finish talking, press **[SP-PHONE]**.
  - The SP-PHONE and the line indicators go out.
  - The length of the call will remain on the display for a few seconds.

#### Note:

- The line indicator flashes while another phone is using the line.
- Use the speakerphone in a quiet environment.
- In step 1, you can select a line by pressing a line button with an unlit indicator instead of pressing **[SP-PHONE]**. Be sure that the handsfree mode is set to “Speakerphone” (see “Handsfree mode” on page 51).

### Switching between handset and speakerphone

#### Switching from handset to speakerphone

Press **[SP-PHONE]**, then place the handset on the cradle.

#### Switching from speakerphone to handset

Lift the handset.

### Adjusting the handset volume (5 levels) or speaker volume (8 levels)

Press **[–]** or **[+]** repeatedly while talking.

### Redialing the last number dialed

- 1 Lift the handset or press **[SP-PHONE]** or a line button.
- 2 Press **[REDIAL/PAUSE]**.

### Making a call using the redial list

The last 6 phone numbers dialed are stored in the redial list.

- 1 Press **[REDIAL/PAUSE]**.
- 2 Press **[▼]** or **[▲]** to select the desired number.
- 3 Lift the handset or press **[SP-PHONE]** or a line button.

### Erasing a number in the redial list

#### Important:

- Make sure that the unit is in standby mode.

- 1 Press **[REDIAL/PAUSE]**.
- 2 Press **[▼]** or **[▲]** to select the desired number, then press **[ERASE]**.
- 3 Select “Yes?”, then press **[ERASE]** or **[MENU/SET]**.

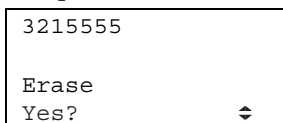

- To cancel, select “No?”, then press **[MENU/SET]**.
- 4 Press **[REDIAL/PAUSE]** to return to standby mode.

#### Note:

- To return to the previous menu, press **[◀◀]**.

### PAUSE button (for PBX/long distance service users)

A pause is sometimes required when making calls using a PBX or long distance service. When storing a calling card access number and/or PIN in the phonebook, a pause is also needed (see “Chain dial” on page 34).

For example, if you need to dial the line access number “9” when making outside calls with a PBX:

- 1 Lift the handset or press **[SP-PHONE]** or a line button.
- 2 Press **[9]**, then press **[REDIAL/PAUSE]**.
- 3 Dial the phone number.

#### Note:

- A 3.5 second pause is inserted each time **[REDIAL/PAUSE]** is pressed. Press repeatedly to insert longer pauses.

## Answering calls

When a call is being received, the unit rings and the called line indicator flashes rapidly.

### Using the handset

- 1 Lift the handset.
- 2 When you finish talking, place the handset on the cradle.

### Using the speakerphone

- 1 Press **[SP-PHONE]**.
- 2 Speak into the MIC.
- 3 When you finish talking, press **[SP-PHONE]**.

#### Note:

- In step 1, you can also answer the call by pressing the flashing line button. Be sure that the handsfree mode is set to “Speakerphone” (see “Handsfree mode” on page 51).

### Adjusting the ringer volume (4 levels)

Press **[–]** or **[+]** repeatedly when in standby mode.

## Turning ringer on/off

Turn the ringer on/off for each line.

#### Important:

- Make sure that the unit is in standby mode.
- 1 Press **[MENU/SET]**.
  - 2 Select “Advanced Setup”, then press **[MENU/SET]**.

- 3** Select "Ringer On/Off", then press **[MENU/SET]**.

```
→Ringer On/Off
Ringer Type
Line Group
[▼/▲]:Scroll
```

- 4** Select the line you want to set, then press **[MENU/SET]**.

```
→Line1 Ringer
Line2 Ringer
Line3 Ringer
[▼/▲]:Scroll
```

- 5** Select the desired setting, then press **[MENU/SET]**.

```
Line1 Ringer
=On
[SET]:Save
[▼/▲]:Change
```

- 6** Press and hold **[MENU/SET]** to return to standby mode.

**Note:**

- To return to the previous menu, press **[◀◀]**.

## Ringer type

Select a ring pattern (4 types) for each line.

**Important:**

- Make sure that the unit is in standby mode.

- 1** Press **[MENU/SET]**.
- 2** Select "Advanced Setup", then press **[MENU/SET]**.
- 3** Select "Ringer Type", then press **[MENU/SET]**.

```
→Ringer Type
Line Group
Display MSGW
[▼/▲]:Scroll
```

- 4** Select the line you want to set, then press **[MENU/SET]**.

```
→Line1 Ring Type
Line2 Ring Type
Line3 Ring Type
[▼/▲]:Scroll
```

- 5** Select the desired setting, then press **[MENU/SET]**.

```
Line1 Ring Type
=Type-1
[SET]:Save
[▼/▲]:Change
```

- 6** Press and hold **[MENU/SET]** to return to standby mode.

**Note:**

- To return to the previous menu, press **[◀◀]**.
- Incoming intercom calls use Type-1 and cannot be changed.

## Turning Do Not Disturb (DND) on/off

You will not hear call rings or paging when this feature is activated. The line indicator flashes for outside calls and the INTERCOM indicator flashes for intercom calls.

Press **[DND]** to turn on/off the Do Not Disturb (DND) feature.

- When the Do Not Disturb (DND) feature is turned on, the DND indicator lights and the display shows "DND".

```
03:45P 02/23 MON
DND 11
CID:100/198 MSGW
TAD:12/26 1 34
```

- When the Do Not Disturb (DND) feature is turned off, the DND indicator goes out.

---

### Making/answering another outside call during a conversation

If you hear beeps during a conversation and another line indicator flashes rapidly, an incoming call is being received. You can answer the 2nd call while holding the 1st call.

- 1 Press **[HOLD]** to put the 1st call on hold.
  - The line indicator flashes.
  - If you press the other line button before pressing **[HOLD]**, the 1st call is disconnected.
- 2 To answer a 2nd call, press the relevant line button.

To make a 2nd call, press the other line button or **[SP-PHONE]**, then dial the phone number.

  - The other line indicator lights.
- 3 To return to the 1st call, press the line button for the 1st call.
  - The 2nd call is disconnected.
  - To hold the 2nd call in step 3, press **[HOLD]** before pressing the line button for the 1st call.

#### Note:

- When the Do Not Disturb (DND) feature is turned on, beeps will not be heard during a conversation.
- To establish a conference call, see “Conference calls” on page 41.

---

### Useful features during a call

---

#### Call privacy

Call privacy allows you to prevent other extensions from joining your conversations with outside callers. The phone always keeps call privacy on unless you manually turn this feature off.

---

#### Call privacy release

During the call, press the line button for the call. You will hear a double-beep.

- Any system phones can join the call by pressing the relevant line button.

---

#### Call privacy release recover

Press the line button again during the call. You will hear a 3-beep.

#### Note:

- Call privacy will turn on again automatically when you hang up.
- If a non-system phone is connected on the same line, this feature does not work for the phone.
- When a non-system phone answers a call, any system phones can join the call by pressing the relevant line button.

---

#### HOLD button

This feature allows you to put a call on hold (for an outside call only).

---

#### To put a call on hold

During an outside call, press **[HOLD]**.

- The line indicator flashes.
- If using the handset, you can place it on the cradle.
- To transfer the call to another extension, see “Transferring calls” on page 40.

### To release the hold

Press the line button.

- The other extension users can take the call by pressing their line buttons.

#### Note:

- If a call is kept on hold for more than 60 or 120 seconds, an alarm tone starts to sound (hold reminder). To turn off the hold reminder, see "Hold reminder" on page 29.
- If a call is kept on hold for more than 5 minutes, the call is disconnected. To keep a call on hold longer than 5 minutes, release hold before 5 minutes and then place the call on hold again.

### Hold reminder

This feature reminds you the call is on hold by sounding a 4-tone alarm every 60 or 120 seconds. The default setting is "60 Seconds".

#### Important:

- Make sure that the unit is in standby mode.

- 1 Press **[MENU/SET]**.
- 2 Select "Phone Setup", then press **[MENU/SET]**.
- 3 Select "Hold Reminder", then press **[MENU/SET]**.

→Hold Reminder  
 Handsfree Mode  
 Prime Line  
 [▼/▲]:Scroll

- 4 Select the desired setting, then press **[MENU/SET]**.

Hold Reminder  
 = 60 Seconds  
 [SET]:Save  
 [▼/▲]:Change

- 5 Press and hold **[MENU/SET]** to return to standby mode.

#### Note:

- To return to the previous menu, press **[◀◀]**.

### MUTE button

While mute is turned on, you can hear the other party, but the other party cannot hear you.

To mute your voice, press **[MUTE]**.

- The MUTE indicator lights.
- To return to the conversation, press **[MUTE]** again. The MUTE indicator goes out.
- When you switch between the handset and the speakerphone or press **[FLASH]**, mute will be released.

### FLASH button

Pressing **[FLASH]** allows you to use special features of your host PBX such as transferring an extension call, or accessing optional telephone services such as Call Waiting.

#### Note:

- To change the flash time, see "Flash time" on page 30.

#### For Call Waiting service users

To use Call Waiting, you must subscribe to Call Waiting service of your telephone service provider.

This feature allows you to receive calls while you are already talking on the phone.

If you receive a call while on the phone, you will hear a Call Waiting tone.

Press **[FLASH]** to answer the 2nd call after the tone.

- To switch between calls, press **[FLASH]**.

#### Note:

- Please contact your telephone service provider for details and availability of this service in your area.

### Flash time

The flash time depends on your telephone exchange or host PBX. You can select the following flash time: 80 ms, 100 ms, 200 ms, 300 ms, 400 ms, 500 ms, 600 ms, and 700 ms. The default setting is "600 ms".

#### Important:

- Make sure that the unit is in standby mode.

- 1 Press **[MENU/SET]**.
- 2 Select "Phone Setup", then press **[MENU/SET]**.
- 3 Select "Flash Time", then press **[MENU/SET]**.

```
→Flash Time
  Hold Reminder
  Handsfree Mode
  [▼/▲]:Scroll
```

- 4 Select the desired setting, then press **[MENU/SET]**.

```
Flash Time
=600 ms
[SET]:Save
[▼/▲]:Change
```

- 5 Press and hold **[MENU/SET]** to return to standby mode.

#### Note:

- To return to the previous menu, press **[◀◀]**.
- If you are connected via a PBX, a longer flash time may be necessary to use PBX functions (transferring a call, etc.). Consult your PBX installer for the correct setting.

### Temporary tone dialing (for rotary/pulse service users)

You can temporarily switch the dialing mode to tone when you need to access touch tone services (for example, answering services, telephone banking services, etc.).

Press **[✳]** (TONE) before entering access numbers which require tone dialing.

### Recording a telephone conversation

You can record your conversation while on an outside call.

- 1 During an outside call, press **[REC/ERASE ALL]**, then press **[MENU/SET]**.
- 2 To stop recording, press **[MENU/SET]** again.

#### Note:

- Many states have imposed regulations on the manner in which 2-way telephone conversations may be recorded, so you should inform the other party that the conversation is being recorded. Consult your local telephone company for further information.
- Recorded conversations are treated as new messages.
- To listen to the recorded conversation, see "Listening to messages" on page 60.
- If the message memory becomes full, "Memory Full" will blink and recording will stop. Erase unnecessary messages (see "Erasing a message" on page 61).
- The recording time of the telephone conversation does not have limitation.
- If there is no sound recorded for a while, recording mode will end.

# Phonebook

You can add up to 200 items to the phonebook and search for phonebook items by name.

## Adding items to the phonebook

### Important:

- Make sure that the unit is in standby mode.

### 1 Press **[PHONEBOOK]**.

- If the display shows “(Full)”, erase other items from the phonebook (see “Erasing one item in the phonebook” on page 34).

### 2 Select “Add New Record”, then press **[MENU/SET]**.

Phonebook (029)  
View Records  
→Add New Record  
[▼/▲]:Scroll

- The total number of items in the phonebook are shown on the display.
- If there are no items in the phonebook, the display will show “(Empty)”.

### 3 Enter the name (max. 16 characters; see “Character table” on page 31).

### 4 Select “Done”, then press **[MENU/SET]**.

- To cancel, select “Cancel”, then press **[MENU/SET]**.

### 5 Enter the phone number (max. 24 digits).

- If required, you can insert **[FLASH]**, **[REDIAL/PAUSE]** or **[\*]** (TONE) in a phone number.
- To add the last number dialed, you can press **[REDIAL/PAUSE]** instead of entering the phone number.

### 6 Select “Done”, then press **[MENU/SET]**.

- To cancel, select “Cancel”, then press **[MENU/SET]**.
- To add other items, repeat from step 2.

### 7 Press **[PHONEBOOK]** to return to standby mode.

### Note:

- To return to the previous menu, press **[◀◀]**.

### Character table

Key	Character
<b>[1]</b>	, - ' & . ( ) @ ! 1
<b>[2]</b>	A B C a b c 2
<b>[3]</b>	D E F d e f 3
<b>[4]</b>	G H I g h i 4
<b>[5]</b>	J K L j k l 5
<b>[6]</b>	M N O m n o 6
<b>[7]</b>	P Q R S p q r s 7
<b>[8]</b>	T U V t u v 8
<b>[9]</b>	W X Y Z w x y z 9
<b>[0]</b>	Space 0
<b>[*]</b>	*
<b>[#]</b>	#

- To enter another character that is located on the same dial key, first press **[▶▶]** to move the cursor to the next space.

### Editing/correcting a mistake

Press **[◀◀]** or **[▶▶]** to move the cursor to the character or number you want to erase, then press **[ERASE]**. Enter the appropriate character or number.

## Storing items from the phonebook into the speed dialer

### Important:

- Make sure that the unit is in standby mode.

- 1 Press **[PHONEBOOK]**.
- 2 Select "View Records", then press **[MENU/SET]**.
- 3 Press **[▼]** or **[▲]** to select the desired item, then press **[MENU/SET]**.
  - To search for the item by initial, see "Searching for a name by initial" on page 33.
- 4 Select "Copy To SPD", then press **[MENU/SET]**.
- 5 Press the speed dial button (**[1]** to **[16]**).  
OR  
Press **[LOWER]**, then press the speed dial button (**[1]** to **[16]**).
- 6 Press **[PHONEBOOK]** to return to standby mode.

### Note:

- To return to the previous menu, press **[◀◀]**.
- If the speed dial has already stored the content, you can select whether it should be replaced or not. To replace current content, select "Yes?", then press **[MENU/SET]**. To keep original content, select "No?", then press **[MENU/SET]**.

## Storing items from the redial list into the phonebook

### Important:

- Make sure that the unit is in standby mode.

- 1 Press **[REDIAL/PAUSE]**.
- 2 Press **[▼]** or **[▲]** to select the desired number, then press **[MENU/SET]**.
- 3 Select "Copy To PhBook", then press **[MENU/SET]**.
- 4 Enter the name (max. 16 characters; see "Character table" on page 31).
- 5 Select "Done", then press **[MENU/SET]**.
  - To cancel, select "Cancel", then press **[MENU/SET]**.
- 6 Edit the phone number if necessary.
  - If required, you can insert **[FLASH]**, **[REDIAL/PAUSE]** or **[\*]** (TONE) in a phone number.
- 7 Select "Done", then press **[MENU/SET]**.
  - To cancel, select "Cancel", then press **[MENU/SET]**.
- 8 Press **[REDIAL/PAUSE]** to return to standby mode.

### Note:

- To return to the previous menu, press **[◀◀]**.



## Finding and calling a phonebook item

Phonebook items can be searched for alphabetically by scrolling through the phonebook items or by entering the first initial.

### Searching for a name alphabetically by scrolling through all items

- 1 Press [**PHONEBOOK**].
- 2 Select "View Records", then press [**MENU/SET**].
- 3 Press [**▼**] or [**▲**] to select the desired item.
- 4 Lift the handset or press [**SP-PHONE**] or a line button to dial the phone number.

### Searching for a name by initial

- 1 Press [**PHONEBOOK**].
- 2 Press the dialing key ([**0**] to [**9**], [**#**], or [**\***]) that corresponds to the first letter you are searching for (see "Character table" on page 31).  
**Example:** "LISA"  
Press [**5**] repeatedly to display the first phonebook entry starting with the initial "L" and go to step 3.
  - If there is no item corresponding to the letter you selected, "No Entries" is displayed.
- 3 Press [**▼**] or [**▲**] to select the desired item.
- 4 Lift the handset or press [**SP-PHONE**] or a line button to dial the phone number.

## Editing items in the phonebook

### Important:

- Make sure that the unit is in standby mode.
- 1 Press [**PHONEBOOK**].
  - 2 Select "View Records", then press [**MENU/SET**].
  - 3 Press [**▼**] or [**▲**] to select the desired item, then press [**MENU/SET**].
    - To search for the item by initial, see "Searching for a name by initial" on page 33.
  - 4 Select "Edit", then press [**MENU/SET**].
  - 5 Edit the name if necessary (see "Character table" on page 31).
  - 6 Select "Done", then press [**MENU/SET**].
    - To cancel, select "Cancel", then press [**MENU/SET**].
  - 7 Edit the phone number if necessary.
    - If required, you can insert [**FLASH**], [**REDIAL/PAUSE**] or [**\***] (TONE) in a phone number.
  - 8 Select "Done", then press [**MENU/SET**].
    - To cancel, select "Cancel", then press [**MENU/SET**].
  - 9 Press [**PHONEBOOK**] to return to standby mode.
- Note:**
- To return to the previous menu, press [**◀◀**].

### Erasing one item in the phonebook

#### Important:

- Make sure that the unit is in standby mode.
- 1 Press **[PHONEBOOK]**.
  - 2 Select “View Records”, then press **[MENU/SET]**.
  - 3 Press **[▼]** or **[▲]** to select the desired item, then press **[ERASE]**.
    - To search for the item by initial, see “Searching for a name by initial” on page 33.
  - 4 Select “Yes?”, then press **[ERASE]** or **[MENU/SET]**.
    - To cancel, select “No?”, then press **[MENU/SET]**.
  - 5 Press **[PHONEBOOK]** to return to standby mode.

#### Note:

- To return to the previous menu, press **[◀◀]**.

### Erasing all items in the phonebook

#### Important:

- Make sure that the unit is in standby mode.
- 1 Press **[PHONEBOOK]**.
  - 2 Select “View Records”, then press **[MENU/SET]**.
  - 3 Select “End Of List” by pressing **[▲]**, then press **[ERASE]**.
  - 4 Select “Yes?”, then press **[ERASE]** or **[MENU/SET]**.
    - To cancel, select “No?”, then press **[MENU/SET]**.
  - 5 Press **[PHONEBOOK]** to return to standby mode.

#### Note:

- To return to the previous menu, press **[◀◀]**.

### Chain dial

This feature allows you to dial phone numbers in the phonebook while you are on a call. This feature can be used, for example, to dial a calling card access number or bank account PIN that you have stored in the phonebook, without having to dial manually.

- 1 During an outside call, press **[PHONEBOOK]**.
- 2 Select “View Records”, then press **[MENU/SET]**.
- 3 Press **[▼]** or **[▲]** to select the desired item, then press **[MENU/SET]**.
  - To search for the item by initial, see “Searching for a name by initial” on page 33.
- 4 Select “Dial”, then press **[MENU/SET]**.

#### Note:

- When storing a calling card access number and your PIN in the phonebook as one phonebook item, press **[REDIAL/PAUSE]** to add pauses after the number and PIN as necessary (see “PAUSE button (for PBX/long distance service users)” on page 26).
- If you have rotary or pulse service, you need to press **[\*]** (TONE) before pressing **[PHONEBOOK]** in step 1 to change the dialing mode temporarily to tone.

## Speed dialer

You can store up to 32 names and phone numbers in the speed dial buttons. (16 names and numbers in upper memory locations, 16 names and numbers in lower memory locations.)

### Speed dial preference

If you want to place speed dialer calls using only one button, set this feature to "CO Call". If you want to place intercom call using only one button, set this feature to "Intercom DSS". If you want to place speed dialer calls after reviewing the entries, set this feature to "Preview Memory".

#### Important:

- Make sure that the unit is in standby mode.

- 1 Press **[MENU/SET]**.
- 2 Select "Phone Setup", then press **[MENU/SET]**.
- 3 Select "Speed Dial", then press **[MENU/SET]**.

```
→Speed Dial
Language
Extension No.
[▼/▲]:Scroll
```

- 4 Select "SPD Preference", then press **[MENU/SET]**.

```
→SPD Preference
Edit/View SPD
[▼/▲]:Scroll
```

- 5 Select the desired setting, then press **[MENU/SET]**.

```
SPD Preference
=CO Call
[SET]:Save
[▼/▲]:Change
```

- 6 Press and hold **[MENU/SET]** to return to standby mode.

#### Note:

- To return to the previous menu, press **[◀◀]**.

### Adding/editing names and phone numbers

#### Important:

- Make sure that the unit is in standby mode.

- 1 Press **[MENU/SET]**.
- 2 Select "Phone Setup", then press **[MENU/SET]**.
- 3 Select "Speed Dial", then press **[MENU/SET]**.

```
→Speed Dial
Language
Extension No.
[▼/▲]:Scroll
```

- 4 Select "Edit/View SPD", then press **[MENU/SET]**.

```
→Edit/View SPD
SPD Preference
[▼/▲]:Scroll
```

- 5 Press the speed dial button (**[1]** to **[16]**).

OR

Press **[LOWER]**, then press the speed dial button (**[1]** to **[16]**).

```
Edit/View SPD
Select SPD Key
```

- 6 Press **[MENU/SET]**.
- 7 Select "Edit", then press **[MENU/SET]**.
- 8 Enter (or edit) the name (max. 16 characters; see "Character table" on page 31).

## Speed Dialer

- To erase the character, press **[ERASE]** or select "Delete Char", then press **[MENU/SET]**.
- 9 Select "Done", then press **[MENU/SET]**.
    - To cancel, select "Cancel", then press **[MENU/SET]**.
  - 10 Enter (or edit) the phone number (max. 24 digits).
    - To erase the number, press **[ERASE]** or select "Delete Char", then press **[MENU/SET]**.
    - If required, you can insert **[FLASH]**, **[REDIAL/PAUSE]** or **[\*]** (TONE) in a phone number.
    - To add the last number dialed, you can press **[REDIAL/PAUSE]** instead of entering the phone number.
  - 11 Select "Done", then press **[MENU/SET]**.
    - To cancel, select "Cancel", then press **[MENU/SET]**.
  - 12 Press and hold **[MENU/SET]** to return to standby mode.

### Note:

- To return to the previous menu, press **[◀◀]**.

### Editing/correcting a mistake

Press **[◀◀]** or **[▶▶]** to move the cursor to the character or number you want to erase, then press **[ERASE]**. Enter the appropriate character or number.

## Storing items from the redial list into the speed dialer

### Important:

- Make sure that the unit is in standby mode.

- 1 Press **[REDIAL/PAUSE]**.

- 2 Press **[▼]** or **[▲]** to select the desired number, then press **[MENU/SET]**.
- 3 Select "Copy To SPD", then press **[MENU/SET]**.
- 4 Press the speed dial button (**[1]** to **[16]**).  
OR  
Press **[LOWER]**, then press the speed dial button (**[1]** to **[16]**).

3215555

Select SPD Key

- 5 Enter the name (max. 16 characters; see "Character table" on page 31).
  - To erase the character, press **[ERASE]** or select "Delete Char", then press **[MENU/SET]**.
- 6 Select "Done", then press **[MENU/SET]**.
  - To cancel, select "Cancel", then press **[MENU/SET]**.
- 7 Edit the phone number if necessary.
  - To erase the number, press **[ERASE]** or select "Delete Char", then press **[MENU/SET]**.
  - If required, you can insert **[FLASH]**, **[REDIAL/PAUSE]** or **[\*]** (TONE) in a phone number.
- 8 Select "Done", then press **[MENU/SET]**.
  - To cancel, select "Cancel", then press **[MENU/SET]**.
- 9 Press **[REDIAL/PAUSE]** to return to standby mode.

### Note:

- To return to the previous menu, press **[◀◀]**.

## Erasing a stored entry

### Important:

- Make sure that the unit is in standby mode.

- 1 Press **[MENU/SET]**.
- 2 Select "Phone Setup", then press **[MENU/SET]**.
- 3 Select "Speed Dial", then press **[MENU/SET]**.

```
→Speed Dial
  Language
  Extension No.
  [▼/▲]:Scroll
```

- 4 Select "Edit/View SPD", then press **[MENU/SET]**.

```
→Edit/View SPD
  SPD Preference
  [▼/▲]:Scroll
```

- 5 Press the speed dial button (**[1]** to **[16]**).  
OR  
Press **[LOWER]**, then press the speed dial button (**[1]** to **[16]**).

```
Edit/View SPD

Select SPD Key
```

- 6 Press **[ERASE]**.
- 7 Select "Yes?", then press **[ERASE]** or **[MENU/SET]**.
  - To cancel, select "No?", then press **[MENU/SET]**.
- 8 Press and hold **[MENU/SET]** to return to standby mode.

### Note:

- To return to the previous menu, press **[◀◀]**.

## Calling someone with the speed dialer

### If speed dial preference is set to "CO Call"

Press the desired speed dial button (**[1]** to **[16]**).

OR

Press **[LOWER]**, then press the desired speed dial button (**[1]** to **[16]**).

### If speed dial preference is set to "Intercom DSS"

- 1 Lift the handset or press **[SP-PHONE]** or a line button.

- 2 Press the desired speed dial button (**[1]** to **[16]**).

OR

Press **[LOWER]**, then press the desired speed dial button (**[1]** to **[16]**).

### If speed dial preference is set to "Preview Memory"

- 1 Press the desired speed dial button (**[1]** to **[16]**).

OR

Press **[LOWER]**, then press the desired speed dial button (**[1]** to **[16]**).

- You can review the entries by pressing **[▼]** or **[▲]**.

- 2 Lift the handset or press **[SP-PHONE]** or a line button.

---

### Intercom/Paging

A 2-way intercom can be set up between two extensions. Make sure that each extension has been assigned the number ("11" to "26", see "Extension No." on page 23) and is connected to the LINE1/2 and LINE3/4 telephone jacks of the unit (page 15, 16, 17).

**The speed dial (extension) buttons "1, 2, 3...15, 16" mean the extension numbers "11, 12, 13...25, 26".**

#### Note:

- If you press the line button during an intercom call (paging), the intercom call (paging) is disconnected and you can make or answer an outside call.

---

### Making an intercom call

#### Using the handset

- 1 Press **[INTERCOM]**.
  - The INTERCOM indicator lights.
  - The SP-PHONE indicator lights and the speakerphone turns on.
- 2 Lift the handset.
  - The SP-PHONE indicator goes out.
- 3 Press the speed dial (extension) button or enter the extension number.
- 4 To end the intercom call, place the handset on the cradle.
  - The INTERCOM indicator goes out.

---

#### Using the speakerphone

- 1 Press **[INTERCOM]**.
  - The INTERCOM indicator lights.
  - The SP-PHONE indicator lights and the speakerphone turns on.

- 2 Press the speed dial (extension) button or enter the extension number.
- 3 To end the intercom call, press **[SP-PHONE]** or **[INTERCOM]**.
  - The INTERCOM and the SP-PHONE indicators go out.

---

#### If speed dial preference is set to "Intercom DSS"

- 1 Press the speed dial (extension) button.
  - The INTERCOM indicator lights.
  - The SP-PHONE indicator lights and the speakerphone turns on.
- 2 To end the intercom call, press **[SP-PHONE]** or **[INTERCOM]**.
  - The INTERCOM and the SP-PHONE indicators go out.

---

### Answering an intercom call

The INTERCOM indicator flashes rapidly and the extension number of the caller is displayed.

Lift the handset or press **[SP-PHONE]** or **[INTERCOM]**.

---

#### Answering an intercom call directed to another extension

Any extensions can answer the intercom call directed to another extension.

Press **[INTERCOM]**.

## Paging a designated extension

### Important:

- Turn Do Not Disturb (DND) off at the destination extension (see “Turning Do Not Disturb (DND) on/off” on page 27).

- 1 Press **[INTERCOM]** 2 times.
  - The INTERCOM indicator lights.
  - The SP-PHONE indicator lights and the speakerphone turns on.
- 2 Press the speed dial (extension) button or enter the extension number, then speak into the MIC or the handset.
  - The destination extension does not ring, instead it will beep 3 times.
  - You can make an intercom call by pressing **[INTERCOM]**.
- 3 To end the paging, place the handset on the cradle or press **[SP-PHONE]**.

## Answering a single page

### If auto mute is set to on

Lift the handset or press **[MUTE]**.

### If auto mute is set to off

Speak into the MIC or the handset.

### Turning auto mute on/off

If this feature is set to off, sounds at the paged extension is heard automatically.

### Important:

- Make sure that the unit is in standby mode.

- 1 Press **[MENU/SET]**.
- 2 Select “Phone Setup”, then press **[MENU/SET]**.

- 3 Select “Auto Mute”, then press **[MENU/SET]**.

→Auto Mute
Tone/Pulse
Flash Time
[▼/▲]: Scroll

- 4 Select the desired setting, then press **[MENU/SET]**.

Auto Mute
=On
[SET]: Save
[▼/▲]: Change

- 5 Press and hold **[MENU/SET]** to return to standby mode.

### Note:

- To return to the previous menu, press **[◀◀]**.

## Paging all extensions

### Important:

- Turn Do Not Disturb (DND) off at the destination extension (see “Turning Do Not Disturb (DND) on/off” on page 27).

- 1 Press **[INTERCOM]**.
  - The INTERCOM indicator lights.
  - The SP-PHONE indicator lights and the speakerphone turns on.
- 2 Press **[0]** to page all extensions, then speak into the MIC or the handset.
  - The other extensions will hear your paging voice through the speaker.
- 3 To end the paging, place the handset on the cradle or press **[SP-PHONE]** or **[INTERCOM]**.

### Note:

- You can only talk with an extension who answers first.

## Answering all pages

Press **[INTERCOM]**.

### Room monitor

You can monitor a room using the intercom feature. For example, you can monitor a baby from different areas of the house.

To use this feature, turn auto mute off at the destination extension.

#### Important:

- Turn auto mute off at the destination extension (see “Turning auto mute on/off” on page 39).
- Make sure that the destination unit is in standby mode.

#### 1 Press **[INTERCOM]** 2 times.

- The INTERCOM indicator lights.
- The SP-PHONE indicator lights and the speakerphone turns on.

#### 2 Press the speed dial (extension) button or enter the extension number.

- The destination extension does not ring, instead it will beep 3 times.
- Your unit starts to monitor the room through the extension.
- If necessary, you can mute your sound output by pressing **[MUTE]**.

#### 3 To end monitoring, press **[SP-PHONE]** or place the handset on the cradle.

#### Note:

- To avoid being monitored and keep privacy, turn Do Not Disturb (DND) on.
- The monitored extension user can stop being monitored by pressing **[SP-PHONE]** or **[INTERCOM]**.

### Transferring calls

You can transfer an outside call to another extension.

**The speed dial (extension) buttons “1, 2, 3...15, 16” mean the extension numbers “11, 12, 13...25, 26”.**

#### Blind transfer

- 1 During an outside call, press **[TRANSFER]** to put the call on hold.
- 2 Press the speed dial (extension) button or enter the extension number, then place the handset on the cradle.
  - If the transferred extension does not answer within 1 minute, the transferred call will ring at all extensions.

#### Note:

- Any extensions can take a transferred call by pressing the relevant line button.
- If a call is kept on hold for more than 60 or 120 seconds, an alarm tone starts to sound (hold reminder). To turn off the hold reminder, see “Hold reminder” on page 29.
- If a call is kept on hold for more than 5 minutes, the call is disconnected.

#### Paging before transfer

- 1 During an outside call, press **[INTERCOM]** 2 times to put the call on hold.
  - You can make an intercom call by pressing **[INTERCOM]**.
- 2 Press the speed dial (extension) button or enter the extension number.
  - If the paged extension does not answer, press the relevant line button.



- 3 After the paged extension answers, announce the transfer.
- 4 Press [**TRANSFER**], then place the handset on the cradle.
  - If the transferred extension does not answer within 1 minute, the transferred call will ring at all extensions.

**Note:**

- Any extensions can take a transferred call by pressing the relevant line button.
- To page all extensions in step 2, press [**0**].
- If a call is kept on hold for more than 60 or 120 seconds, an alarm tone starts to sound (hold reminder). To turn off the hold reminder, see "Hold reminder" on page 29.
- If a call is kept on hold for more than 5 minutes, the call is disconnected.

---

## Answering transferred calls

The line indicator flashes rapidly and the extension number of the caller is displayed.

Lift the handset or press [**SP-PHONE**] or a line button.

---

### Answering a transferred call directed to another extension

Any extensions can answer a transferred call directed to another extension.

Press the relevant line button.

---

## Conference calls

---

### Conference call with two outside calls

While you are talking with an outside caller, you can make or answer a 2nd call on the other line, and then combine the calls to establish a conference call.

- 1 During an outside call, press [**HOLD**].
- 2 To answer a 2nd call, press the relevant line button.  
To make a 2nd call, press the other line button or [**SP-PHONE**], then dial the phone number.
- 3 When the 2nd call is connected, press [**CONFERENCE**] to make a conference call.
  - To hang up both lines, place the handset on the cradle or press [**SP-PHONE**].
  - To hang up only one line, press the line button for the party with which you want to continue talking.
  - To put both lines on hold, press [**HOLD**].
    - To talk with only one caller, press the line button for the party with which you want to continue talking.
    - To resume both lines, press the relevant line button, then press [**CONFERENCE**].

**Note:**

- If a call is kept on hold for more than 60 or 120 seconds, an alarm tone starts to sound (hold reminder). To turn off the hold reminder, see "Hold reminder" on page 29.
- If a call is kept on hold for more than 5 minutes, the call is disconnected.

### Conference with an outside call and an intercom call

While you are talking with an outside caller, one more extension can join the conversation and establish a conference call.

- 1** During an outside call, press **[INTERCOM]** to put the call on hold.
- 2** To page another extension, press the speed dial (extension) button or enter the extension number.
- 3** When the paged party answers, press **[CONFERENCE]** to make a conference call.
  - To hang up both the outside and intercom calls, place the handset on the cradle or press **[SP-PHONE]**. (The other remaining parties on the line can still talk.)

#### Note:

- If a call is kept on hold for more than 60 or 120 seconds, an alarm tone starts to sound (hold reminder). To turn off the hold reminder, see "Hold reminder" on page 29.
- If a call is kept on hold for more than 5 minutes, the call is disconnected.

## Using Caller ID service

This unit is Caller ID compatible. To use Caller ID features, you must subscribe to Caller ID service of your telephone service provider.

## Incoming Caller ID display

When an outside call is being received, the date and time of the call, the calling party's name, phone number, and the called line are displayed.

Caller information for the last 200 different callers is logged in the caller list by the most recent call to the oldest.

When the caller list is full, the oldest call is deleted.

- Generally caller information is displayed from the 2nd ring.

```
03:45P 02/23
Jack Smith
1-555-321-5555
L1
```

You can switch the display by pressing [◀◀] or [▶▶] to check the length of the call.

```
03:45P 02/23 MON
00:29
```

- If the unit cannot receive caller information, the following is displayed:
  - “**Out Of Area**”: The caller dialed from an area which does not provide Caller ID service.
  - “**Private Caller**”: The caller requested not to send caller information.
  - “**Long Distance**”: The caller called you long distance.
- If the unit is connected to a PBX system, caller information may not be received properly. Consult your PBX supplier.

## Missed calls

If a call is not answered, the unit treats the call as a missed call. The number of missed calls is shown on the display.

This lets you know if you should view the caller list to see who called while you were out.

## Call Waiting Caller ID display

If you subscribe to both Caller ID and Call Waiting with Caller ID services, the 2nd caller's information is displayed after you hear a Call Waiting tone (see “For Call Waiting service users” on page 29). Please contact your telephone service provider for details and availability of this service in your area.

```
03:45P 02/23
Jack Smith
1-555-321-5555
(Call Waiting)L1
```

## Simultaneous ringing on two or more lines

If two or more lines receive calls at the same time, only one caller's information can be displayed at a time.

To review the Caller ID of another line, press [◀◀] or [▶▶].

## Home and local area codes

The format of phone numbers displayed will depend on the home and local area codes you programmed into the phone (see “Area codes” on page 45).

- If the incoming call came from your home area code, only the phone number is displayed.
- If the incoming call came from one of your pre-programmed local area codes, the phone number with the local area code prefixed is displayed.
- If the incoming call did not come from any of your area codes, one of the 2 following cases can occur:

## Caller ID Service

- If the phone number is 10 digits, “1” is automatically inserted and display before the phone number.
- If the phone number is less than 10 digits, only the phone number is displayed.

### Example:

Home area code is set to “999”.

Local area code is set to “888”.

- When a number from “999” area code is received (for example, “999-xxx-xxxx”), it displays as a 7-digit number.

xxx-xxxx

- When a number from “888” (set to one of the local area codes) area code is received (for example, “888-xxx-xxxx”), it displays as a 10-digit number.

888-xxx-xxxx

- When a number from “333” (not set to the local area code) area code is received (for example, “333-xxx-xxxx”), it displays as a 11-digit number.

1-333-xxx-xxxx

### Note:

- If you are in a region where 10 digits are used to dial within your area code, you are advised to set the home area code to “000” and you must set your area code as a local area code.
- To edit a caller’s phone number, see “Editing a caller’s phone number before calling back” on page 45.

### Automatically setting date and time

This phone automatically resets the date and time each time new information is received. You can set the date and time yourself if you wish (see “Date and time” on page 24).

## Caller list

### Viewing the caller list

#### Important:

- Make sure that the unit is in standby mode.

- 1 Press [**CALLER ID**].
- 2 Press [**▼**] to search from the most recent call, or [**▲**] to search from the oldest call.
- 3 To exit the list, press [**CALLER ID**].

#### Note:

- To return to the previous menu, press [**◀◀**].

### Calling back from the caller list

#### Important:

- Make sure that the unit is in standby mode.

- 1 Press [**CALLER ID**].
- 2 Press [**▼**] to search from the most recent call, or [**▲**] to search from the oldest call.
- 3 Press [**MENU/SET**].
  - If the number requires editing, see “Editing a caller’s phone number before calling back” on page 45.
- 4 Select “Dial Alternate” (or “Dial”), then press [**MENU/SET**].
  - If you want to select a desired line and dial out, press the line button.

#### Note:

- To return to the previous menu, press [**◀◀**].

## Editing a caller's phone number before calling back

You can edit a phone number in the caller list by removing its area code and/or the long distance code "1".

### Important:

- Make sure that the unit is in standby mode.

- 1 Press **[CALLER ID]**.
- 2 Select the desired item, then press **[MENU/SET]**.
- 3 Select "Dial Alternate".
- 4 Press **[▶▶]** to show the alternate forms of the number. (**[◀◀]** does not work.)
  - ① Local phone number  
**Example:**
  - ② Area code - Local phone number  
**Example:**
  - ③ 1 - Area code - Local phone number  
**Example:**
- 5 Press **[MENU/SET]**.

### Note:

- To return to the previous menu, press **[◀◀]**.

## Area codes

You can program this phone to recognize one home and up to 5 local area codes.

- If you set the home area code, the display shows the 7 digits of the phone number when you receive a call from your home area code.
- If you set the local area code, you can dial 10 digits (without dialing "1") to make a call outside your home area code and the display shows the 10 digits (without "1") of the phone number when you receive a call from one of your local area codes.

### Important:

- Make sure that the unit is in standby mode.

- 1 Press **[MENU/SET]**.
- 2 Select "Advanced Setup", then press **[MENU/SET]**.
- 3 Select "Area Codes", then press **[MENU/SET]**.

→Area Codes  
 Reset All  
 Ringer On/Off  
 [▼/▲]:Scroll

- 4 Select the area code you want to set, then press **[MENU/SET]**.

→Home Area Code  
 Local Area C1  
 Local Area C2  
 [▼/▲]:Scroll

- 5 Enter the area code, then press **[MENU/SET]**.
- 6 Press and hold **[MENU/SET]** to return to standby mode.

### Note:

- To return to the previous menu, press **[◀◀]**.

### Erasing the area code

#### Important:

- Make sure that the unit is in standby mode.

- 1 Press **[MENU/SET]**.
- 2 Select "Advanced Setup", then press **[MENU/SET]**.
- 3 Select "Area Codes", then press **[MENU/SET]**.

→Area Codes Reset All Ringer On/Off [▼/▲]: Scroll
--

- 4 Select the area code you want to erase, then press **[MENU/SET]**.
- 5 Press **[ERASE]**.
- 6 Select "Yes?", then press **[ERASE]** or **[MENU/SET]**.
  - To cancel, select "No?", then press **[MENU/SET]**.
- 7 Press and hold **[MENU/SET]** to return to standby mode.

#### Note:

- To return to the previous menu, press **[◀◀]**.

### Storing caller information into the phonebook

#### Important:

- Make sure that the unit is in standby mode.

- 1 Press **[CALLER ID]**.
- 2 Select the desired item, then press **[MENU/SET]**.
- 3 Select "Copy To PhBook".
  - To edit the phone number, press **[▶▶]** repeatedly until the phone number is shown in the desired format. (**[◀◀]** does not work.)
- 4 Press **[MENU/SET]**.
- 5 Press **[CALLER ID]** to return to standby mode.

#### Note:

- To return to the previous menu, press **[◀◀]**.

## Storing caller information into the speed dialer

### Important:

- Make sure that the unit is in standby mode.

- 1 Press **[CALLER ID]**.
- 2 Select the desired item, then press **[MENU/SET]**.
- 3 Select "Copy To SPD".
  - To edit the phone number, press **[▶▶]** repeatedly until the phone number is shown in the desired format. (**[◀◀]** does not work.)
- 4 Press **[MENU/SET]**.
- 5 Press the speed dial button (**[1]** to **[16]**).  
OR  
Press **[LOWER]**, then press the speed dial button (**[1]** to **[16]**).
- 6 Press **[CALLER ID]** to return to standby mode.

### Note:

- To return to the previous menu, press **[◀◀]**.
- If the speed dial has already stored the content, you can select whether it should be replaced or not. To replace current content, select "Yes?", then press **[MENU/SET]**. To keep original content, select "No?", then press **[MENU/SET]**.

## Erasing selected caller information

### Important:

- Make sure that the unit is in standby mode.

- 1 Press **[CALLER ID]**.
- 2 Select the desired item, then press **[ERASE]**.
- 3 Select "Yes?", then press **[ERASE]** or **[MENU/SET]**.
  - To cancel, select "No?", then press **[MENU/SET]**.
- 4 Press **[CALLER ID]** to return to standby mode.

### Note:

- To return to the previous menu, press **[◀◀]**.

## Erasing all caller information

### Important:

- Make sure that the unit is in standby mode.

- 1 Press **[CALLER ID]**.
- 2 Press **[ERASE]**.
- 3 Select "Yes?", then press **[ERASE]** or **[MENU/SET]**.
  - To cancel, select "No?", then press **[MENU/SET]**.
- 4 Press **[CALLER ID]** to return to standby mode.

### Note:

- To return to the previous menu, press **[◀◀]**.

## Programmable settings

You can customize the unit by programming the following features.  
Make sure that the unit is in standby mode.

**Note:**

- In the following table, \* shows the default setting.
- To return to the previous menu, press [◀◀].
- You can exit feature setup and return to the idle status any time by pressing and holding [MENU/SET].

**Phone Setup**

Sub-menu 1	Sub-menu 2	Setting	Page
Speed Dial	SPD Preference	CO Call*, Intercom DSS, Preview Memory	35
	Edit/View SPD	—	35
Language	—	English*, Español	23
Extension No.	—	11* – 26	23
Date & Time	—	2006 12/31 12:00A*	24
Auto Mute	—	On*, Off	39
Tone/Pulse	—	Tone*, Pulse	24
Flash Time	—	80 ms, 100 ms, 200 ms, 300 ms, 400 ms, 500 ms, 600 ms*, 700 ms	30
Hold Reminder	—	60 Seconds*, 120 Seconds, Off	29
Handsfree Mode	—	Headset*, Speakerphone	51
Prime Line	—	Line1*, Line2, Line3, Line4	51



## Advanced Setup

Sub-menu 1	Sub-menu 2	Setting	Page
Ringer On/Off	Line1 Ringer	On*, Off	26
	Line2 Ringer	On*, Off	
	Line3 Ringer	On*, Off	
	Line4 Ringer	On*, Off	
Ringer Type	Line1 Ring Type	Type-1*, Type-2, Type-3, Type-4	27
	Line2 Ring Type	Type-1*, Type-2, Type-3, Type-4	
	Line3 Ring Type	Type-1*, Type-2, Type-3, Type-4	
	Line4 Ring Type	Type-1*, Type-2, Type-3, Type-4	
Line Group	-	Line 04* - 15, Private Line	52
Display MSGW	-	On, Off*	65
Clear MSGW	-	Yes, No	65
Area Codes	Home Area Code	3 digits, (Empty)*	45
	Local Area C1	3 digits, (Empty)*	
	Local Area C2	3 digits, (Empty)*	
	Local Area C3	3 digits, (Empty)*	
	Local Area C4	3 digits, (Empty)*	
	Local Area C5	3 digits, (Empty)*	
Reset All	-	Yes, No	52

## Programming

---

### AA/TAD Setup

Sub-menu 1	Sub-menu 2	Setting	Page
Auto Attendant	–	On, Off*	53
AA Answer Delay	–	06* - 12 Seconds	54
Day Time	–	09:00A*	54
Night Time	–	06:00P*	54
TAD Ans. Delay	–	14 - 40 Seconds (20 Seconds*)	57
Toll Saver	–	On, Off*	63
Remote Code	–	3 digits, 123*	62
Message Length	–	Unlimited*, 1 Minute, Greeting Only	64
Call Screening	–	On*, Off	58
Intercept Call	–	On*, Off	58

## Programming the phone setup features

### Prime line

If the selected line is ringing or all lines are idle, it has the highest priority to be picked up when you lift the handset or press **[SP-PHONE]**.

#### Important:

- Make sure that the unit is in standby mode.

- 1 Press **[MENU/SET]**.
- 2 Select "Phone Setup", then press **[MENU/SET]**.
- 3 Select "Prime Line", then press **[MENU/SET]**.

```
→Prime Line
  Speed Dial
  Language
  [▼/▲]:Scroll
```

- 4 Select the desired setting, then press **[MENU/SET]**.

```
Prime Line
=Line1
[SET]:Save
[▼/▲]:Change
```

- 5 Press and hold **[MENU/SET]** to return to standby mode.

#### Note:

- To return to the previous menu, press **[◀◀]**.

## Handsfree mode

You can use this phone in "Handsfree" mode by using the speakerphone on the unit or a headset (optional).

This feature specifies a mode to be automatically selected each time you press a line key with the handset on the cradle.

#### Important:

- Make sure that the unit is in standby mode.

- 1 Press **[MENU/SET]**.
- 2 Select "Phone Setup", then press **[MENU/SET]**.
- 3 Select "Handsfree Mode", then press **[MENU/SET]**.

```
→Handsfree Mode
  Prime Line
  Speed Dial
  [▼/▲]:Scroll
```

- 4 Select the desired setting, then press **[MENU/SET]**.

```
Handsfree Mode
=Headset
[SET]:Save
[▼/▲]:Change
```

- 5 Press and hold **[MENU/SET]** to return to standby mode.

#### Note:

- To return to the previous menu, press **[◀◀]**.
- If you set "Handsfree" mode to "Headset" but do not actually have a headset connected, speakerphone will be used.

## Programming the advanced setup features

### Line group

You can choose to leave LINE4 unconnected at particular extensions or to connect private lines (constructing a line group) at particular extensions. To set up the line group, see "Setting up the line group" on page 20.

**Important:**

- Make sure that the unit is in standby mode.

- 1 Press **[MENU/SET]**.
- 2 Select "Advanced Setup", then press **[MENU/SET]**.
- 3 Select "Line Group", then press **[MENU/SET]**.

```
→Line Group
  Display MSGW
  Clear MSGW
  [▼/▲]:Scroll
```

- 4 Select the desired setting, then press **[MENU/SET]**.

```
Line Group
=Line 04
[SET]:Save
[▼/▲]:Change
```

- 5 Press and hold **[MENU/SET]** to return to standby mode.

**Note:**

- To return to the previous menu, press **[|◀◀]**.
- Transferring a call to a different line group through line 4 is not allowed.

### Reset all

Return all features to default settings, and all numbers set to speed dial are erased. You cannot undo the "Reset All" command.

**Important:**

- Make sure that the unit is in standby mode.

- 1 Press **[MENU/SET]**.
- 2 Select "Advanced Setup", then press **[MENU/SET]**.
- 3 Select "Reset All", then press **[MENU/SET]**.

```
→Reset All
  Ringer On/Off
  Ringer Type
  [▼/▲]:Scroll
```

- 4 Select "Yes?", then press **[MENU/SET]**.

```
Reset All
Yes?
[SET]:Reset
[▼/▲]:Change
```

- To cancel, select "No?", then press **[MENU/SET]**.
- 5 Press and hold **[MENU/SET]** to return to standby mode.

**Note:**

- To return to the previous menu, press **[|◀◀]**.

## Automated Attendant System operation

The Automated Attendant System is a flexible communication tool that can enhance your productivity by improving your call management.

When the Automated Attendant System on this phone is turned on, the phone answers incoming calls with a greeting message and routes the callers to other extensions in the system.

You need to set the day and night times (see "Setting the Automated Attendant System day and night times" on page 54) to use the Automated Attendant System. You can then use the different greeting messages for those times.

### Note:

- The Automated Attendant System only works with a multi-phone system.

### How Automated Attendant System works

- 1 Call is received.
- 2 The Automated Attendant System answers the call and play a greeting message.
- 3 **If a caller presses an extension number (11 to 26)**, the call is transferred to the required extension. **If a caller presses 0**, the Automated Attendant System plays an auxiliary greeting message. **If a caller does not enter any number**, the Automated Attendant System transfers the call to extension 11.

### Automated Attendant System greeting messages

Three different greeting messages are available. If you do not record your own greeting messages (see "Recording the Automated Attendant System greeting messages" on page 55), the following pre-recorded greeting messages play.

#### Day time greeting message:

*"Thank you for calling. If you know your party's extension, you may dial it at any time, otherwise please dial zero."*

#### Night time greeting message:

*"Thank you for calling. We cannot answer your call. If you would like to leave a message to your party's extension, please dial it now, otherwise please dial zero."*

#### Auxiliary greeting message:

*"Please enter 11 for attendant."*

## Turning Automated Attendant System on/off

### Important:

- Make sure that the unit is in standby mode.

- 1 Press **[MENU/SET]**.
- 2 Select "AA/TAD Setup", then press **[MENU/SET]**.
- 3 Select "Auto Attendant", then press **[MENU/SET]**.

```
→Auto Attendant
  AA Answer Delay
  Day Time
  [▼/▲]:Scroll
```

- 4 Select the desired setting, then press **[MENU/SET]**.

```
Auto Attendant
=Off
[SET]:Save
[▼/▲]:Change
```

- 5 Press and hold **[MENU/SET]** to return to standby mode.

### Note:

- To return to the previous menu, press [◀◀].
- When the Automated Attendant System is turned on, the display shows "AA Mode".

```
03:45P 02/23 MON
EXT 11 AA Mode
CID:100/198 MSGW
TAD:12/26 1 34
```

### Automated Attendant System answer delay

This setting changes the amount of time the phone waits before playing the greeting message. After the selected amount of time passes, the phone plays the greeting message.

### Important:

- Make sure that the unit is in standby mode.

- 1 Press [MENU/SET].
- 2 Select "AA/TAD Setup", then press [MENU/SET].
- 3 Select "AA Answer Delay", then press [MENU/SET].

```
→AA Answer Delay
Day Time
Night Time
[▼/▲]:Scroll
```

- 4 Select the desired setting, then press [MENU/SET].

```
AA Answer Delay
=06 Seconds
[SET]:Save
[▼/▲]:Change
```

- 5 Press and hold [MENU/SET] to return to standby mode.

### Note:

- To return to the previous menu, press [◀◀].

## Setting the Automated Attendant System day and night times

The Automated Attendant System day (or night) greeting message will begin playing at the time programmed as day until the time you programmed as night, and vice versa.

### Important:

- Make sure that the unit is in standby mode.

- 1 Press [MENU/SET].
- 2 Select "AA/TAD Setup", then press [MENU/SET].
- 3 Select "Day Time" or "Night Time", then press [MENU/SET].

```
→Day Time
Night Time
TAD Ans. Delay
[▼/▲]:Scroll
```

- 4 Enter the hour and minute, then press [MENU/SET].

```
Day Time
= 9:00A
[SET]:Save
[DIGIT]:Change
```

- 5 Select "A" (AM) or "P" (PM), then press [MENU/SET].

```
Day Time
=09:00P
[SET]:Save
[▼/▲]:Change
```

- 6 Press and hold [MENU/SET] to return to standby mode.

### Note:

- To return to the previous menu, press [◀◀].
- If you make a mistake when entering the date and time, press [◀◀] or [▶▶] to move the cursor, then make the correction.

- If you set the same time for day and night time, the system will play the day time greeting message only.

### Auxiliary greeting message

The phone plays this message when an outside caller presses **[0]** after hearing the day or night time greeting message.

## Playing back the Automated Attendant System greeting messages

### Important:

- Make sure that the unit is in standby mode.

- 1 Press **[REC/ERASE ALL]**.
- 2 Select the desired setting, "AA Day-OGM", "AA Night-OGM" or "AA Aux-OGM", then press **[MENU/SET]**.

```
TAD Operation
→AA Day-OGM
  AA Night-OGM
[▼/▲]:Scroll
```

- 3 Select "Play", then press **[MENU/SET]**.

```
AA Day-OGM

[SET]:Play ⇅
```

- 4 To stop playing, press **[MENU/SET]** while the Automated Attendant System greeting message is playing.
- 5 Press **[REC/ERASE ALL]** to return to standby mode.

### Note:

- To return to the previous menu, press **[◀◀]**.

## Recording the Automated Attendant System greeting messages

You can record up to 90 seconds of the Automated Attendant System greeting messages.

### Important:

- Make sure that the unit is in standby mode.

- 1 Press **[REC/ERASE ALL]**.
- 2 Select the desired setting, "AA Day-OGM", "AA Night-OGM" or "AA Aux-OGM", then press **[MENU/SET]**.

```
TAD Operation
→AA Day-OGM
  AA Night-OGM
[▼/▲]:Scroll
```

- 3 Select "Re-Record", then press **[MENU/SET]**.

```
AA Day-OGM

[SET]:Re-Record⇅
```

- 4 After the unit beeps, speak clearly about 20 cm (8 inches) away from the MIC.
- 5 To stop recording, press **[MENU/SET]**.
  - The greeting message is played back.
- 6 Press **[REC/ERASE ALL]** to return to standby mode.

### Note:

- To return to the previous menu, press **[◀◀]**.
- If there is no sound recorded for a while, recording mode will end.

### Erasing the Automated Attendant System greeting messages

If you erase your own greeting message, the unit plays a pre-recorded greeting message for callers.

#### Important:

- Make sure that the unit is in standby mode.

- 1 Press **[REC/ERASE ALL]**.
- 2 Select the desired setting, "AA Day-OGM", "AA Night-OGM" or "AA Aux-OGM", then press **[MENU/SET]**.

```
TAD Operation
→AA Day-OGM
  AA Night-OGM
[▼/▲]:Scroll
```

- 3 Select "Play", then press **[MENU/SET]**.

```
AA Day-OGM

[SET]:Play ⇅
```

- 4 Press **[ERASE]** during playback.
- 5 Select "Yes?", then press **[ERASE]** or **[MENU/SET]**.

```
AA Day-OGM
Playing
Erase
Yes? ⇅
```

- To cancel, select "No?", then press **[MENU/SET]**.

- 6 Press **[REC/ERASE ALL]** to return to standby mode.

#### Note:

- To return to the previous menu, press **[◀◀]**.

### Using multiple Automated Attendant Systems

When multiple Automated Attendant Systems are used, you can choose a particular extension to be the primary Automated Attendant System. The Automated Attendant System which has the shortest Automated Attendant System answer delay is going to be the primary Automated Attendant System. When the primary Automated Attendant System is turned off or busy, other Automated Attendant Systems answer a call.

#### Note:

- To avoid more than one Automated Attendant System trying to pick up a single call at the same time, you must program the Automated Attendant System answer delay with over two seconds between them.



## Answering system

### Important:

- When callers leave messages, the unit records the day and time of each message. Make sure the date and time have been correctly set (see "Date and time" on page 24).

## Memory capacity

The total recording capacity (including your greeting message, caller messages, voice memo, and telephone conversation) is about 60 minutes. A maximum of 99 messages (including a greeting message) can be recorded.

- If the message memory becomes full, "Memory Full" will blink, recording will stop, and the pre-recorded greeting message ("Hello, we are not available now. Thank you for calling. Memory full.") will be announced to callers. Erase unnecessary messages (see "Erasing a message" on page 61).

```
03:45P 02/23 MON
EXT 11
CID:100/198 MSGW
Memory Full 1 34
```

## Turning the answering system on/off

Press **[ANSWER ON]** to turn on/off the answering system. (The default setting is on.)

- When the answering system is turned on, the ANSWER ON indicator lights.
- When the answering system is turned off, the ANSWER ON indicator goes out.

## TAD answer delay

This setting changes the amount of time the phone waits before playing the greeting message (14 - 40 Seconds). After the selected amount of time passes, the phone plays the greeting message. The default setting is "20 Seconds".

### Important:

- Make sure that the unit is in standby mode.

- 1 Press **[MENU/SET]**.
- 2 Select "AA/TAD Setup", then press **[MENU/SET]**.
- 3 Select "TAD Ans. Delay", then press **[MENU/SET]**.

```
→TAD Ans. Delay
Toll Saver
Remote Code
[▼/▲]:Scroll
```

- 4 Select the desired setting, then press **[MENU/SET]**.

```
TAD Ans. Delay
=20 Seconds
[SET]:Save
[▼/▲]:Change
```

- 5 Press and hold **[MENU/SET]** to return to standby mode.

### Note:

- To return to the previous menu, press **[◀◀]**.

### Screening calls

While a caller is leaving a message, you can listen to the call through the speaker. To adjust the speaker volume, press **[-]** or **[+]** repeatedly. You can answer the call by lifting the handset or pressing **[SP-PHONE]** or a line button.

#### Important:

- To listen to the call through the speaker, turn Do Not Disturb (DND) off (see “Turning Do Not Disturb (DND) on/off” on page 27) before the answering system is activated.

### Turning the call screening on/off

#### Important:

- Make sure that the unit is in standby mode.

- 1 Press **[MENU/SET]**.
- 2 Select “**AA/TAD Setup**”, then press **[MENU/SET]**.
- 3 Select “**Call Screening**”, then press **[MENU/SET]**.

```
→Call Screening
  Intercept Call
  Auto Attendant
  [▼/▲]:Scroll
```

- 4 Select the desired setting, then press **[MENU/SET]**.

```
Call Screening
=On
[SET]:Save
[▼/▲]:Change
```

- 5 Press and hold **[MENU/SET]** to return to standby mode.

#### Note:

- To return to the previous menu, press **[|<<]**.

### Intercept call

While screening a call, you can answer the call by pressing the relevant line button with the other compatible extension phone.

### Turning the intercept call on/off

#### Important:

- Make sure that the unit is in standby mode.

- 1 Press **[MENU/SET]**.
- 2 Select “**AA/TAD Setup**”, then press **[MENU/SET]**.
- 3 Select “**Intercept Call**”, then press **[MENU/SET]**.

```
→Intercept Call
  Auto Attendant
  AA Answer Delay
  [▼/▲]:Scroll
```

- 4 Select the desired setting, then press **[MENU/SET]**.

```
Intercept Call
=On
[SET]:Save
[▼/▲]:Change
```

- 5 Press and hold **[MENU/SET]** to return to standby mode.

#### Note:

- To return to the previous menu, press **[|<<]**.

## Playing back the greeting message

### Important:

- Make sure that the unit is in standby mode.

- 1 Press **[REC/ERASE ALL]**.
- 2 Select "TAD Ans-OGM", then press **[MENU/SET]**.

```
TAD Operation
→TAD Ans-OGM
AA Day-OGM
[▼/▲]:Scroll
```

- 3 Select "Play", then press **[MENU/SET]**.

```
TAD Ans-OGM

[SET]:Play ↕
```

- 4 To stop playing, press **[MENU/SET]** while the greeting message is playing.
- 5 Press **[REC/ERASE ALL]** to return to standby mode.

### Note:

- To return to the previous menu, press **[◀◀]**.

## Recording your greeting message

You can record your own greeting message (up to 90 seconds) that is played when the answering system answers a call. If you do not record a greeting message, a pre-recorded greeting message is used. If the message memory becomes full, the pre-recorded greeting message ("Hello, we are not available now. Thank you for calling. Memory full.") will be announced to callers.

### Important:

- Make sure that the unit is in standby mode.

- 1 Press **[REC/ERASE ALL]**.
- 2 Select "TAD Ans-OGM", then press **[MENU/SET]**.

```
TAD Operation
→TAD Ans-OGM
AA Day-OGM
[▼/▲]:Scroll
```

- 3 Select "Re-Record", then press **[MENU/SET]**.

```
TAD Ans-OGM

[SET]:Re-Record↕
```

- 4 After the unit beeps, speak clearly about 20 cm (8 inches) away from the MIC.
- 5 To stop recording, press **[MENU/SET]**.
  - The greeting message is played back.
- 6 Press **[REC/ERASE ALL]** to return to standby mode.

### Note:

- To return to the previous menu, press **[◀◀]**.
- If there is no sound recorded for a while, recording mode will end.

## Erasing your greeting message

### Important:

- Make sure that the unit is in standby mode.

- 1 Press **[REC/ERASE ALL]**.
- 2 Select "TAD Ans-OGM", then press **[MENU/SET]**.

```
TAD Operation
→TAD Ans-OGM
AA Day-OGM
[▼/▲]:Scroll
```

- 3 Select "Play", then press **[MENU/SET]**.

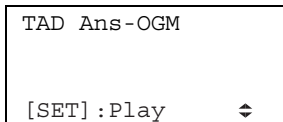

- 4 Press **[ERASE]** while your greeting message is playing.
- 5 Select "Yes?", then press **[ERASE]** or **[MENU/SET]**.

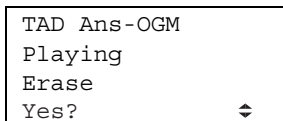

- To cancel, select "No?", then press **[MENU/SET]**.
- 6 Press **[REC/ERASE ALL]** to return to standby mode.

**Note:**

- To return to the previous menu, press **[◀◀]**.

---

## Pre-recorded greeting message

If you erase (or do not record) your own greeting message, the unit plays a pre-recorded greeting message for callers asking them to leave a message. If the message length is set to "Greeting Only" (see "Caller's message length" on page 64), incoming messages are not recorded and the unit plays a different pre-recorded greeting message: *"Hello, we are not available now. Thank you for calling."* The call will end after the message has played. To play back the pre-recorded greeting message, see "Playing back the greeting message" on page 59.

---

## Listening to messages

When new messages have been recorded, the MESSAGE indicator flashes. When you have listened to all new messages, the MESSAGE indicator will switch from flashing to lit.

**Important:**

- Make sure that the unit is in standby mode.

- 1 Press **[MESSAGE]**.
  - The unit plays new messages.
  - When you have no new messages, the unit plays back all messages.
- 2 To stop playback, press **[MESSAGE]** again.

**Note:**

- When you have erased all messages, the MESSAGE indicator goes out.

---

## Adjusting the speaker volume

Press **[−]** or **[+]** repeatedly while listening to a message.

---

## Repeating a message

Press **[◀◀]** during playback.

- If pressed within the first 3 seconds of a message, the previous message is played.

---

## Skipping a message

Press **[▶▶]** during playback.

---

## Pausing a message

Press **[MENU/SET]** during playback.

- To resume playback, press **[MENU/SET]** again while "Play" is displayed.
- To stop playback completely, press **[MESSAGE]** or select "Exit", then press **[MENU/SET]** again.

## Erasing a message

- 1 Press **[ERASE]** during playback.
- 2 Select "Yes?", then press **[ERASE]** or **[MENU/SET]**.
  - To cancel, select "No?", then press **[MENU/SET]**.

## Erasing all messages

### Important:

- Make sure that the unit is in standby mode.

- 1 Press **[REC/ERASE ALL]**.
- 2 Select "Erase All MSG", then press **[MENU/SET]**.

```
TAD Operation
→Erase All MSG
TAD Ans-OGM
[▼/▲]:Scroll
```

- 3 Select "Yes?", then press **[ERASE]** or **[MENU/SET]**.

```
Erase All MSG
All Message:19
Erase All
Yes? ⇅
```

- To cancel, select "No?", then press **[MENU/SET]**.

- 4 Press **[REC/ERASE ALL]** to return to standby mode.

### Note:

- To return to the previous menu, press **[◀◀]**.

## Voice memo

### Recording a voice memo

You can use the unit to leave a voice memo (voice message) for yourself or someone else. Voice memos can be played back later with the same operation used to play back answering system messages.

### Important:

- Make sure that the unit is in standby mode.

- 1 Press **[REC/ERASE ALL]**.
- 2 Select "Record Memo", then press **[MENU/SET]**.

```
TAD Operation
→Record Memo
Erase All MSG
[▼/▲]:Scroll
```

- 3 After the unit beeps, speak clearly about 20 cm (8 inches) away from the MIC.
- 4 To stop recording, press **[MENU/SET]**.
- 5 Press **[REC/ERASE ALL]** to return to standby mode.

### Note:

- To return to the previous menu, press **[◀◀]**.
- The recording time of the voice memo (voice message) doesn't have limitation.
- If there is no sound recorded for a while, recording mode will end.

### Remote operation

Using a touch tone phone, you can call your phone number from outside or another extension in the phone system and access the unit to listen to messages.

#### Note:

- In order to operate the answering system remotely, you must first set a remote code (see “Remote code” on page 62). This code must be entered each time you operate the answering system remotely.

### Remote code

A remote code must be entered when operating the answering system remotely (see “Using the answering system remotely” on page 62). This code prevents unauthorized parties from listening to your messages remotely. The default setting is “123”.

#### Important:

- Make sure that the unit is in standby mode.

- 1 Press **[MENU/SET]**.
- 2 Select “AA/TAD Setup”, then press **[MENU/SET]**.
- 3 Select “Remote Code”, then press **[MENU/SET]**.

→Remote Code Message Length Call Screening [▼/▲] : Scroll
--

- 4 Enter the desired 3-digit remote code, then press **[MENU/SET]**

Remote Code = 123 [SET] : Save [DIGIT] : Change
--

- 5 Press and hold **[MENU/SET]** to return to standby mode.

#### Note:

- To return to the previous menu, press **[◀◀]**.
- The remote code can be edited, but not deleted.

### Using the answering system remotely

#### From a touch tone phone outside the telephone system

##### Important:

- Make sure that the answering system is turned on (see “Turning the answering system on/off” on page 57).

- 1 Dial your phone number from a touch tone phone.
- 2 After the greeting message starts, enter your remote code (see “Remote code” on page 62).
- 3 Enter the remote commands (see “Remote commands” on page 63).
- 4 When finished, hang up.

#### From another extension within the telephone system

##### Important:

- Turn Do Not Disturb (DND) off at the destination extension (see “Turning Do Not Disturb (DND) on/off” on page 27).

- 1 Page the extension of the answering system you wish to reach (see “Paging a designated extension” on page 39).
- 2 Enter your remote code within 20 seconds (see “Remote code” on page 62).

- 3 Enter the remote commands (see “Remote commands” on page 63).
- 4 When finished, hang up.

### Remote commands

You can press dial keys to access certain answering system functions.

Key	Remote command
[1]	Repeat message (during playback) <sup>*1</sup>
[2]	Play new messages
[2][#]	Play all messages
[3]	Skip message (during playback)
[4]	Record a memo
[5]	Stop recording/playback
[6]	Play answering system greeting <sup>*2</sup>
[7]	Play Automated Attendant System day time greeting <sup>*2</sup>
[8]	Play Automated Attendant System night time greeting <sup>*2</sup>
[9]	Play Automated Attendant System Auxiliary greeting <sup>*2</sup>
[0]	Turn answering system on/off
[*][*]	Erase currently playing message
[*][#]	Erase all messages

\*1 If pressed within the first 3 seconds of a message, the previous message is played.

\*2 During playback of the greeting, you can record a new greeting by pressing [4].

### Note:

- If the phone is being accessed remotely, it will not respond to any keys.
- Remote operation will end by pausing for over 20 seconds during remote operation.

### Toll saver

If the Toll saver feature is turned on, the unit answers within about 10 seconds when new messages have been recorded, and after over 10 seconds when there are no new messages present. For example, if you call this phone from an outside line and the phone rings for over 10 seconds, there are no new messages present. You can then hang up without being charged for the call.

### Important:

- Make sure that the answering system is turned on (see “Turning the answering system on/off” on page 57) and the Automated Attendant System is turned off (see “Turning Automated Attendant System on/off” on page 53).

### Turning Toll Saver on/off

### Important:

- Make sure that the unit is in standby mode.

- 1 Press [MENU/SET].
- 2 Select “AA/TAD Setup”, then press [MENU/SET].
- 3 Select “Toll Saver”, then press [MENU/SET].

→Toll Saver
Remote Code
Message Length
[▼/▲]:Scroll

- 4 Select the desired setting, then press **[MENU/SET]**.

```
Toll Saver
=Off
[SET] : Save
[▼/▲] : Change
```

- 5 Press and hold **[MENU/SET]** to return to standby mode.

**Note:**

- To return to the previous menu, press **[◀◀]**.

### For Voice Mail service subscribers

If you subscribe to a flat-rate service package that includes Caller ID, Call Waiting, Voice Mail, and unlimited local/regional/long distance calls, please note the following:

- To use the Voice Mail service provided by your telephone service provider rather than the unit's answering system, turn off the answering system (see "Turning the answering system on/off" on page 57).
- To use this unit's answering system rather than the Voice Mail service provided by your telephone service provider, please contact your telephone service provider to deactivate your Voice Mail service. If your telephone service provider cannot do this:
  - Set this unit's "TAD Ans. Delay" setting so that this unit's answering system answers calls before the Voice Mail service of your telephone service provider does (see "TAD answer delay" on page 57). It is necessary to check the time required to activate the Voice Mail service provided by your telephone service provider before changing this setting.

- Change the time of the Voice Mail service so that the answering system can answer the call first. To do so, consult your telephone service provider.

## Caller's message length

You can change the maximum message recording time allotted to each caller.

The default setting is "Unlimited".

**"Greeting Only"**: The unit plays the greeting message ("Hello, we are not available now. Thank you for calling.") but does not record caller messages.

**"1 Minute"**: The caller can record the message up to 1 minute.

**Important:**

- Make sure that the unit is in standby mode.

- 1 Press **[MENU/SET]**.
- 2 Select **"AA/TAD Setup"**, then press **[MENU/SET]**.
- 3 Select **"Message Length"**, then press **[MENU/SET]**.

```
→Message Length
Call Screening
Intercept Call
[▼/▲] : Scroll
```

- 4 Select the desired setting, then press **[MENU/SET]**.

```
Message Length
=Unlimited
[SET] : Save
[▼/▲] : Change
```

- 5 Press and hold **[MENU/SET]** to return to standby mode.

**Note:**

- To return to the previous menu, press **[◀◀]**.



## Using Voice Mail service

Voice Mail is an automatic answering service offered by your telephone service provider. After you subscribe to this service, the telephone service provider's Voice Mail system will answer calls for you when you are unavailable to answer the phone or when your line is busy. Messages are recorded by the telephone service provider, not your telephone.

### Important:

- To use the Voice Mail service provided by your telephone service provider rather than the unit's answering system, turn off the answering system (see "Turning the answering system on/off" on page 57).

## Message waiting

If you subscribe to the Voice Mail service, the display will flash when you have unretrieved messages waiting. After retrieving the message, the indicator will be deleted.

```
03:45P 02/23 MON
EXT 11
CID:100/198 `MSGW`
TAD:12/26 ,1 34`
```

## Display message waiting

Turn on or off the current MSGW indicators on the display.

### Important:

- Make sure that the unit is in standby mode.

- 1 Press **[MENU/SET]**.
- 2 Select "Advanced Setup", then press **[MENU/SET]**.
- 3 Select "Display MSGW", then press **[MENU/SET]**.

```
→Display MSGW
Clear MSGW
Area Codes
[▼/▲]:Scroll
```

- 4 Select the desired setting, then press **[MENU/SET]**.

```
Display MSGW
=Off
[SET]:Save
[▼/▲]:Change
```

- 5 Press and hold **[MENU/SET]** to return to standby mode.

### Note:

- To return to the previous menu, press **[◀◀]**.

## Clear message waiting

### Important:

- Make sure that the unit is in standby mode.

- 1 Press **[MENU/SET]**.
- 2 Select "Advanced Setup", then press **[MENU/SET]**.
- 3 Select "Clear MSGW", then press **[MENU/SET]**.

```
→Clear MSGW
Area Codes
Reset All
[▼/▲]:Scroll
```

- 4 Select "Yes?", then press **[MENU/SET]**.

```
Clear MSGW
Yes?
[SET]:Clear
[▼/▲]:Change
```

- To cancel, select "No?", then press **[MENU/SET]**.
- 5 Press and hold **[MENU/SET]** to return to standby mode.

### Note:

- To return to the previous menu, press **[◀◀]**.

---

---

## Headset (optional)

---

### Sales and support information

- To order replacement accessories, call 1-800-332-5368.
- TTY users (hearing or speech impaired users) can call 1-866-605-1277.

---

### Connecting the optional headset to the unit

Connecting a headset to the unit allows hands-free phone conversations. We recommend using the Panasonic headset noted on page 5.



- Headset shown is KX-TCA88HA.

---

### Making/Answering calls

- 1 Press **[HEADSET]** to make or answer a call.
  - If you misdial when making a call, press **[HEADSET]** and start again from step 1.
- 2 To hang up, press **[HEADSET]**.

### To adjust the headset receiver volume (5 levels)

While using the headset, press **[-]** or **[+]**.

---

### Switching between headset, handset, and speakerphone

#### Switching from handset to headset

Press **[HEADSET]**, then place the handset on the cradle.

#### Switching from headset to handset

When the handset is on the cradle, lift the handset.

When the handset is off-hook, press **[HEADSET]** again.

#### Switching from headset to speakerphone

Press **[SP-PHONE]**.

#### Switching from speakerphone to headset

Press **[HEADSET]**.

#### Note:

- If you unplug the headset while the phone is in use, the phone will not automatically switch to speakerphone. You must press **[SP-PHONE]** to switch.

## Wall mounting

This unit can be mounted on a wall phone plate.

- 1 Pull down the handset hook until it locks, **so the tab holds the handset**.

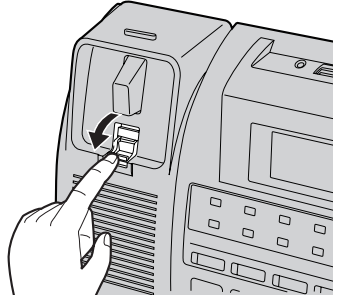

- 2 Connect the AC adaptor, and dress the AC adaptor cord as shown.

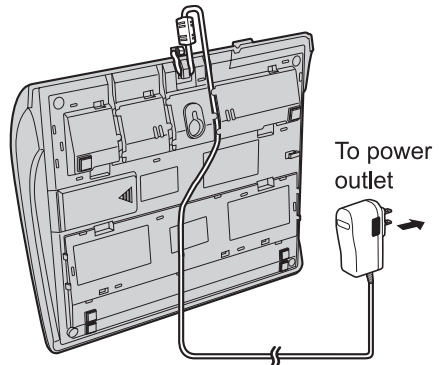

- 3 Dress the telephone line cord as shown. Tuck the telephone line cord inside the wall mounting adaptor, then push it in the direction of the arrows (1 and 2).

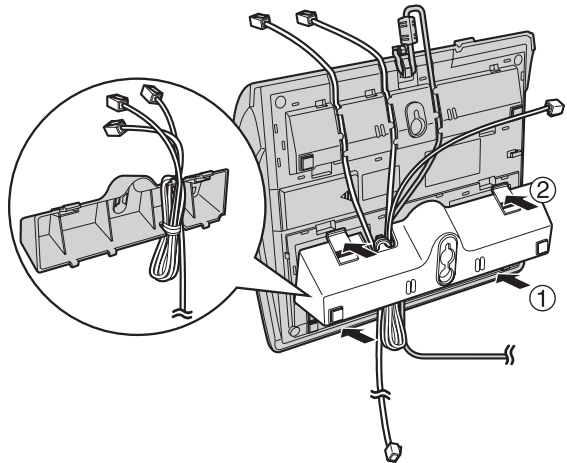

## Useful Information

- 4 Connect the telephone line cord.  
Mount the unit, then slide down.

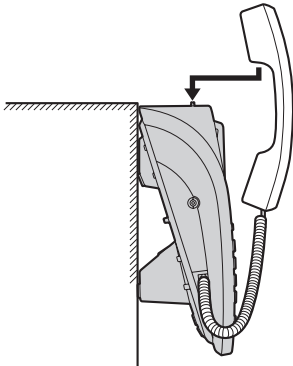
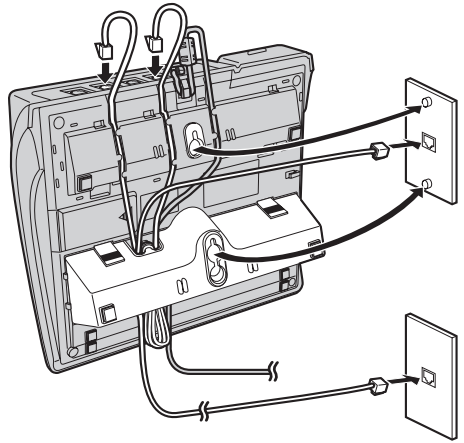

To temporarily set the handset down during a conversation, place it as shown here.

## Connecting a standard telephone

If the backup battery has been discharged during a power failure, the unit will not work. If required, you can connect a standard telephone on LINE 2 or LINE 4 of this unit using the Panasonic T-adaptor KX-J66. To order, call the accessories telephone number on page 5.

Example: Connecting a standard telephone on LINE 4.

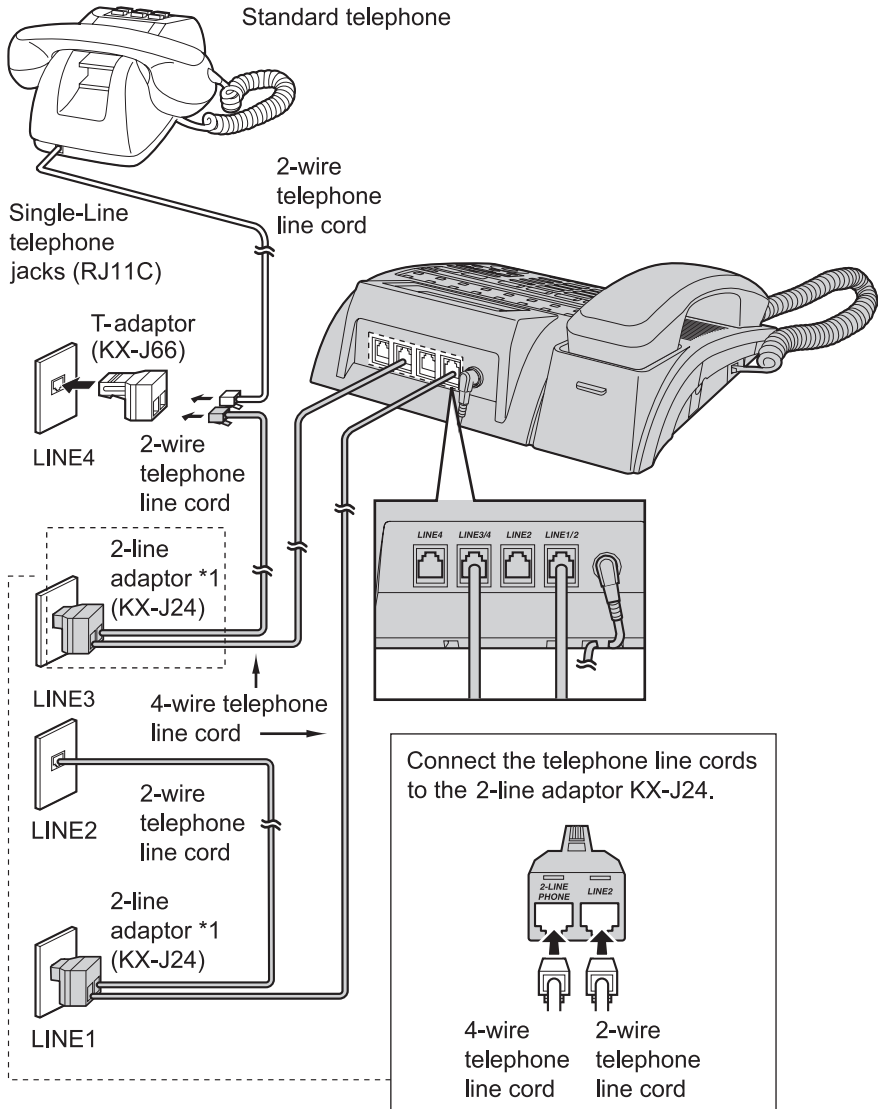

\*1 2-line adaptor merges a 2-wire (single line) telephone outlet with another 2-wire (single line) telephone line onto a single 4-wire (2-line) telephone line cord.

### Error messages

If the unit detects a problem, one of the following messages is shown on the display.

Display message	Cause/solution
<b>Busy:AA Mode</b>	<ul style="list-style-type: none"><li>● The phone is currently carrying out the Automated Attendant System process.</li></ul>
<b>Busy:Record Mode</b>	<ul style="list-style-type: none"><li>● The phone is currently carrying out the recording process.</li></ul>
<b>Busy:Remote Mode</b>	<ul style="list-style-type: none"><li>● The phone is currently being accessed remotely.</li></ul>
<b>Phonebook Full!</b>	<ul style="list-style-type: none"><li>● There is no space in the phonebook to store new items from the caller list or redial list. Erase unnecessary items (see "Erasing one item in the phonebook" on page 34).</li></ul>
<b>(Full)</b>	<ul style="list-style-type: none"><li>● There is no space in the phonebook to store new items. Erase unnecessary items (see "Erasing one item in the phonebook" on page 34).</li></ul>
<b>LOW BATT</b>	<ul style="list-style-type: none"><li>● No battery is installed.</li><li>● The battery may need to be replaced with a new one (see "Battery replacement" on page 12).</li></ul>
<b>Memory Full</b>	<ul style="list-style-type: none"><li>● The message memory is full. Erase unnecessary messages (see "Erasing a message" on page 61).</li></ul>
<b>PowerFail</b>	<ul style="list-style-type: none"><li>● When the phone is disconnected from a power outlet or there is a power failure, the battery works as emergency power. When power is restored, "PowerFail" will disappear on the display.</li></ul>

---

### Troubleshooting

#### General use

Problem	Cause/solution
The unit does not work.	<ul style="list-style-type: none"><li>● Check the connections (page 14, 15, 16, 17).</li><li>● Unplug the AC adaptor to reset the unit. Reconnect the adaptor and try again.</li></ul>
The line indicators do not work properly.	<ul style="list-style-type: none"><li>● Check the connections (page 14, 15, 16, 17).</li></ul>
The unit does not ring.	<ul style="list-style-type: none"><li>● The ringer is set to "OFF". Turn it on (see "Turning ringer on/off" on page 26).</li><li>● The Do Not Disturb (DND) feature is turned on. Turn it off (see "Turning Do Not Disturb (DND) on/off" on page 27).</li><li>● If there are several non-system phones on the line that do not ring, disconnect some of them. Having too many phones connected can also result in low ringer volumes on non-system phones.</li></ul>

Problem	Cause/solution
You cannot hear a dial tone.	<ul style="list-style-type: none"> <li>● Check the connections (see “Connecting the handset and AC adaptor” on page 14).</li> <li>● Confirm the telephone line cord is properly connected (page 15, 16, 17).</li> <li>● Disconnect the unit from the telephone line and connect a known working telephone. If the working telephone operates properly, contact our service personnel to have the unit repaired. If the working telephone does not operate properly, contact your telephone service provider.</li> </ul>
You cannot dial.	<ul style="list-style-type: none"> <li>● Check whether the dialing mode selection is correct (see “Dialing mode” on page 24).</li> </ul>
Date and time on the display flashes.	<ul style="list-style-type: none"> <li>● Set the date and time (see “Date and time” on page 24).</li> <li>● If you subscribe to Caller ID service, date and time is automatically set when an outside call is received (see “Automatically setting date and time” on page 44).</li> </ul>
The battery is discharged.	<ul style="list-style-type: none"> <li>● Please remove the battery when you cut the power supply, as the battery will discharge automatically once the power is cut according to the time shown on page 12.</li> </ul>
How do I return to standby mode quickly?	<ul style="list-style-type: none"> <li>● Lift the handset, then place it back on the cradle.</li> <li>● Press <b>[SP-PHONE]</b> 2 times.</li> </ul>

### Programmable settings

Problem	Cause/solution
You cannot program function items, such as the dialing mode.	<ul style="list-style-type: none"> <li>● Programming is not possible while in the talk or intercom mode, or while listening to messages or the answering system is answering a call.</li> <li>● Do not pause for over 30 seconds while programming.</li> <li>● Make sure that the unit is in standby mode.</li> </ul>

### Making/answering calls, intercom

Problem	Cause/solution
Static is heard, sound cuts in and out.	<ul style="list-style-type: none"> <li>● If your unit is connected to a telephone line with DSL service, we recommend connecting a noise filter between the unit and the telephone line jack (see “Connecting 2 two-line telephone jacks” on page 18, “Connecting four single-line telephone jacks” on page 19). Contact your DSL provider for details.</li> </ul>
You cannot redial the last number dialed.	<ul style="list-style-type: none"> <li>● If the last number dialed was more than 32 digits long, the number cannot be redialed.</li> <li>● Access numbers entered after pressing <b>[*]</b> (TONE) will not be included when redialing.</li> </ul>

## Useful Information

Problem	Cause/solution
You cannot have a conversation using the headset.	<ul style="list-style-type: none"><li>● Make sure that <b>[HEADSET]</b> is pressed.</li><li>● Make sure that the headset is plugged into the headset jack properly (see “Connecting the optional headset to the unit” on page 66).</li></ul>
During a power failure, you cannot make or answer a call.	<ul style="list-style-type: none"><li>● Make sure that a battery has been installed properly (see “Battery installation” on page 12).</li><li>● The battery may have been discharged. In that case, replace the battery with a new one (see “Battery replacement” on page 12).</li></ul>
The intercom does not work.	<ul style="list-style-type: none"><li>● DSL Internet connection and KX-TS4100/KX-TS4200/KX-TS4300 Intercom work at similar frequencies. Please contact Panasonic at 1-800-211-PANA (1-800-211-7262) for special wiring configurations.</li></ul>
You cannot page other extension.	<ul style="list-style-type: none"><li>● The unit is in use. Try again later.</li></ul>
You cannot answer the transferred call even if the display shows “Transfer From xx”.	<ul style="list-style-type: none"><li>● The transferred call was disconnected before you answered it.</li></ul>

## Phonebook

Problem	Cause/solution
You cannot store a name and phone number in the phonebook.	<ul style="list-style-type: none"><li>● Do not pause for over 30 seconds while programming.</li><li>● Make sure that the unit is in standby mode.</li></ul>
The display returns to standby mode while viewing the phonebook.	<ul style="list-style-type: none"><li>● Do not pause for over 30 seconds while searching.</li></ul>



## Caller ID

Problem	Cause/solution
The caller's information is not displayed.	<ul style="list-style-type: none"> <li>● You have not subscribed to Caller ID service. Contact your telephone company to subscribe.</li> <li>● If your unit is connected to any additional telephone equipment such as a Caller ID box or cordless telephone jack, disconnect the unit from the equipment and plug the unit directly into the wall jack.</li> <li>● If your unit is connected to a telephone line with DSL service, we recommend connecting a noise filter between the unit and the telephone line jack (see "Connecting 2 two-line telephone jacks" on page 18, "Connecting four single-line telephone jacks" on page 19). Contact your DSL provider for details.</li> <li>● The name display service may not be available in some areas. Contact your telephone company for details.</li> <li>● Other telephone equipment may be interfering with this unit. Disconnect the other equipment and try again.</li> <li>● The caller requested not to send caller information (see "Incoming Caller ID display" on page 43).</li> <li>● If a call is being transferred to you, the caller information is not displayed.</li> <li>● Generally, caller information is displayed from the 2nd ring.</li> </ul>
The display returns to standby mode while viewing the caller list.	<ul style="list-style-type: none"> <li>● Do not pause for over 30 seconds while searching.</li> </ul>
When a 2nd call is received on the same line, the unit does not display the new caller's information.	<ul style="list-style-type: none"> <li>● You have not subscribed to Caller ID and/or Call Waiting with Caller ID services. Please contact your telephone service provider for details and availability of this service in your area.</li> <li>● If another call is received on the same line while; <ul style="list-style-type: none"> <li>–the Automated Attendant System or answering system is responding to a call, or</li> <li>–a call is placed on hold,</li> </ul> the caller information will not be displayed. </li> </ul>
You cannot dial the phone number edited in the caller list.	<ul style="list-style-type: none"> <li>● The phone number you dialed might have an incorrectly edited pattern (for example, the long distance "1" or the area code is missing). Edit the phone number with another pattern (see "Editing a caller's phone number before calling back" on page 45).</li> </ul>

### Automated Attendant System/Answering system

Problem	Cause/solution
The unit does not record new messages.	<ul style="list-style-type: none"><li>● The answering system is off. Turn it on (see “Turning the answering system on/off ” on page 57).</li><li>● The caller’s message length is set to “<b>Greeting Only</b>”. Select a different setting (see “Caller’s message length” on page 64).</li><li>● The message memory is full. Erase unnecessary messages (see “Erasing a message” on page 61).</li><li>● If you subscribe to the Voice Mail service, messages are recorded by the telephone service provider not your telephone (see “For Voice Mail service subscribers” on page 64).</li></ul>
“ <b>Memory Full</b> ” flashes on the display, and no new messages are recorded.	<ul style="list-style-type: none"><li>● The message memory is full. Erase unnecessary messages (see “Erasing a message” on page 61).</li></ul>
You cannot listen to messages from a remote location.	<ul style="list-style-type: none"><li>● A touch tone phone is required for remote operation.</li><li>● Enter the remote code correctly (see “Remote code” on page 62).</li><li>● The answering system is off. Turn it on (see “Turning the answering system on/off ” on page 57).</li><li>● The answering system may not respond if the tones are too short to activate the unit. Press each button firmly.</li><li>● If you enter the wrong remote code, hang up and then try again.</li></ul>
While recording a greeting message, the unit starts to ring and stops recording.	<ul style="list-style-type: none"><li>● A call is being received. Answer the call and start again after hanging up.</li></ul>
During playback, incoming call tones are heard.	<ul style="list-style-type: none"><li>● A call is being received. Answer the call and start again after hanging up.</li></ul>
You have a difficulty in intercepting a call during message recording.	<ul style="list-style-type: none"><li>● “<b>Intercept Call</b>” is turned off. Turn it on (see “Turning the intercept call on/off ” on page 58).</li><li>● Use a phone connected to the line of the incoming call.</li></ul>

## FCC and other information

This equipment complies with Part 68 of the FCC rules and the requirements adopted by the ACTA. On the bottom of this equipment is a label that contains, among other information, a product identifier in the format US:ACJ-----. If requested, this number must be provided to the telephone company.

- Registration No.  
.....(found on the bottom of the unit)
- Facility Interface Code.....02LS2
- Service Order Code.....9.0F
- Required Network Interface Jack  
.....RJ11C, RJ14C
- Ringer Equivalence No.  
(REN).....0.3B

A plug and jack used to connect this equipment to the premises wiring and telephone network must comply with the applicable FCC Part 68 rules and requirements adopted by the ACTA. A compliant telephone cord and modular plug is provided with the product. It is designed to be connected to a compatible modular jack that is also compliant.

The REN is used to determine the number of devices that may be connected to a telephone line. Excessive RENs on a telephone line may result in the devices not ringing in response to an incoming call. In most but not all areas, the sum of RENs should not exceed five (5.0). To be certain of the number of devices that may be connected to a line, as determined by the total RENs, contact the local telephone company. For products approved after July 23, 2001, the REN for the product is part of the product identifier that has the format US:AAAEQ##TXXXX. The digits

represented by ## are the REN without a decimal point (e.g., 03 is a REN of 0.3).

If this equipment causes harm to the telephone network, the telephone company will notify you in advance that temporary discontinuance of service may be required. But if advance notice isn't practical, the telephone company will notify the customer as soon as possible. Also, you will be advised of your right to file a complaint with the FCC if you believe it is necessary.

The telephone company may make changes in its facilities, equipment, operations or procedures that could affect the operation of the equipment. If this happens the telephone company will provide advance notice in order for you to make necessary modifications to maintain uninterrupted service.

If trouble is experienced with this equipment, for repair or warranty information, please contact a Factory Servicenter or other Authorized Servicer. If the equipment is causing harm to the telephone network, the telephone company may request that you disconnect the equipment until the problem is resolved.

Connection to party line service is subject to state tariffs. Contact the state public utility commission, public service commission or corporation commission for information.

If your home has specially wired alarm equipment connected to the telephone line, ensure the installation of this equipment does not disable your alarm equipment. If you have questions about what will disable alarm equipment, consult your telephone company or a qualified installer.

## Useful Information

---

This equipment is hearing aid compatible as defined by the FCC in 47 CFR Section 68.316.

### WHEN PROGRAMMING EMERGENCY NUMBERS AND(OR) MAKING TEST CALLS TO EMERGENCY NUMBERS:

- 1) Remain on the line and briefly explain to the dispatcher the reason for the call.
- 2) Perform such activities in the off-peak hours, such as early morning or late evenings.

This device complies with Part 15 of the FCC Rules. Operation is subject to the following two conditions:

(1) This device may not cause harmful interference, and (2) this device must accept any interference received, including interference that may cause undesired operation.

### CAUTION:

Any changes or modifications not expressly approved by the party responsible for compliance could void the user's authority to operate this device.

### NOTE:

This equipment has been tested and found to comply with the limits for a Class B digital device, pursuant to Part 15 of the FCC Rules. These limits are designed to provide reasonable protection against harmful interference in a residential installation. This equipment generates, uses, and can radiate radio frequency energy and, if not installed and used in accordance with the instructions, may cause harmful interference to radio communications. However, there is no guarantee that interference will not occur in a particular installation. If this equipment does cause harmful interference to radio or television reception, which can be

determined by turning the equipment off and on, the user is encouraged to try to correct the interference by one or more of the following measures:

- Reorient or relocate the receiving antenna.
- Increase the separation between the equipment and receiver.
- Connect the equipment into an outlet on a circuit different from that to which the receiver is connected.
- Consult the dealer or an experienced radio/TV technician for help.

---

---

## Specifications

<b>Operating environment</b>	5 °C – 40 °C (41 °F – 104 °F)
<b>Dimensions (without wall mounting adaptor)</b>	Approx. height 105 mm x width 245 mm x depth 225 mm (4 <sup>1</sup> / <sub>8</sub> inches x 9 <sup>21</sup> / <sub>32</sub> inches x 8 <sup>7</sup> / <sub>8</sub> inches)
<b>Mass (Weight) (without wall mounting adaptor)</b>	Approx. 1,090 g (2.4 lb.)
<b>Power consumption</b>	Standby: Approx. 5 W (PQLV210Z) Maximum: Approx. 8 W (PQLV210Z)
<b>Power supply</b>	AC adaptor (120 V AC, 60 Hz)

**Note:**

- Design and specifications are subject to change without notice.
- The illustrations in these instructions may vary slightly from the actual product.

## Customer services

### ***Customer Services Directory***

Obtain Product Information and Operating Assistance; locate your nearest Dealer or Servicenter; purchase Parts and Accessories; or make Customer Service and Literature requests by visiting our Web Site at:

**<http://www.panasonic.com/consumersupport>**

or, contact us via the web at:

**<http://www.panasonic.com/contactinfo>**

You may also contact us directly at: 1-800-211-PANA (1-800-211-7262),  
Monday-Friday 9 am-9 pm; Saturday-Sunday 10 am-7 pm, EST.

TTY users (hearing or speech impaired users) can call 1-877-833-8855.

### ***Accessory Purchases***

Purchase Parts, Accessories and Instruction Books online for all Panasonic Products by visiting our Web Site at:

**<http://www.pasc.panasonic.com>**

or, send your request by E-mail to:

**[npcparts@us.panasonic.com](mailto:npcparts@us.panasonic.com)**

You may also contact us directly at:

1-800-332-5368 (Phone) 1-800-237-9080 (Fax Only)

(Monday - Friday 9 am to 9 pm, EST.)

Panasonic Services Company

20421 84th Avenue South, Kent, WA 98032

(We Accept Visa, MasterCard, Discover Card, American Express, and Personal Checks)

TTY users (hearing or speech impaired users) can call 1-866-605-1277.

### ***Service in Puerto Rico***

Panasonic Puerto Rico, Inc.

San Gabriel Industrial Park, Ave. 65 de Infantería, Km. 9.5,

Carolina, Puerto Rico 00985

Phone (787)750-4300, Fax (787)768-2910

## Warranty

PANASONIC CONSUMER  
ELECTRONICS COMPANY, DIVISION  
OF PANASONIC CORPORATION OF  
NORTH AMERICA  
One Panasonic Way,  
Secaucus, New Jersey 07094

PANASONIC PUERTO RICO, INC.  
San Gabriel Industrial Park,  
Ave. 65 de Infantería, Km. 9.5,  
Carolina, Puerto Rico 00985

## Panasonic Telephone Products Limited Warranty

### Limited Warranty Coverage

If your product does not work properly because of a defect in materials or workmanship, Panasonic Consumer Electronics Company or Panasonic Puerto Rico, Inc. (collectively referred to as "the warrantor") will, for the length of the period indicated on the chart below, which starts with the date of original purchase ("Limited Warranty period"), at its option either (a) repair your product with new or refurbished parts, or (b) replace it with a new or a refurbished product. The decision to repair or replace will be made by the warrantor.

Parts	Labor
One (1) Year	One (1) Year

During the "Labor" Limited Warranty period there will be no charge for labor. During the "Parts" Limited Warranty period, there will be no charge for parts. You must mail-in your product prepaid during the Limited Warranty period. This Limited Warranty excludes both parts and labor for batteries, antennas, and cosmetic parts (cabinet). This Limited Warranty only applies to products purchased and serviced in the United States or Puerto Rico. This Limited Warranty is extended only to the original purchaser and only covers products purchased as new.

### Mail-In Service

For assistance in the continental U.S.A. in obtaining repairs please ship the product prepaid to:

**Panasonic Services Company Customer Servicenter**

**4900 George McVay Drive Suite B Door #12 McAllen, TX 78503**

For assistance in Puerto Rico call Panasonic Puerto Rico, Inc. (787)-750-4300 or fax (787)-768-2910.

When shipping the unit carefully pack, include all accessories, and send it prepaid, adequately insured and preferably in the original carton. Include a letter detailing the complaint and provide a day time phone number where you can be reached.

**IF REPAIR IS NEEDED DURING THE LIMITED WARRANTY PERIOD THE PURCHASER WILL BE REQUIRED TO FURNISH A SALES RECEIPT/PROOF OF PURCHASE INDICATING DATE OF PURCHASE, AMOUNT PAID AND PLACE OF PURCHASE. CUSTOMER WILL BE CHARGED FOR THE REPAIR OF ANY UNIT RECEIVED WITHOUT SUCH PROOF OF PURCHASE.**

### Limited Warranty Limits And Exclusions

This Limited Warranty ONLY COVERS failures due to defects in materials or workmanship, and DOES NOT COVER normal wear and tear or cosmetic damage. The Limited Warranty ALSO DOES NOT COVER damages which occurred in shipment, or failures which are caused by products not supplied by the warrantor, or failures which result from accidents, misuse, abuse, neglect, bug infestation, mishandling, misapplication, alteration, faulty installation, set-up adjustments, misadjustment of consumer controls, improper maintenance, power line surge, lightning damage, modification, introduction of sand, humidity or liquids, or rental use of the product, or service by anyone other than a Factory Servicenter or other Authorized Servicer, or damage that is attributable to acts of God.

**THERE ARE NO EXPRESS WARRANTIES EXCEPT AS LISTED UNDER "LIMITED WARRANTY COVERAGE". THE WARRANTOR IS NOT LIABLE FOR INCIDENTAL OR CONSEQUENTIAL DAMAGES RESULTING FROM THE USE OF THIS PRODUCT, OR ARISING OUT OF ANY BREACH OF THIS LIMITED WARRANTY.** (As examples, this excludes damages for lost time, lost calls or messages, cost of having someone remove or re-install an installed unit if applicable, travel to and from the servicer. The items listed are not exclusive, but are for illustration only.) **ALL EXPRESS AND IMPLIED WARRANTIES, INCLUDING THE WARRANTY OF MERCHANTABILITY, ARE LIMITED TO THE PERIOD OF THE LIMITED WARRANTY.**

Some states do not allow the exclusion or limitation of incidental or consequential damages, or limitations on how long an implied warranty lasts, so the exclusions may not apply to you.

This Limited Warranty gives you specific legal rights and you may also have other rights which vary from state to state. If a problem with this product develops during or after the Limited Warranty period, you may contact your dealer or Servicenter. If the problem is not handled to your satisfaction, then write to the warrantor's Consumer Affairs Department at the addresses listed for the warrantor.

**PARTS AND SERVICE, WHICH ARE NOT COVERED BY THIS LIMITED WARRANTY, ARE YOUR RESPONSIBILITY.**



---



---

## Index

- A** Answering calls: 26
  - Answering system
    - Erasing messages: 61, 63
    - Listening to messages: 60, 63
    - TAD answer delay: 57
    - Turning on/off: 57, 63
  - Area codes: 43, 45
  - Auto mute: 39
  - Automated Attendant System
    - Answer delay: 54
    - Turning on/off: 53
- B** Battery
  - Installation: 12
  - Life: 12
  - Replacement: 12
- C** Call privacy: 28
  - Call screening: 58
  - Call Waiting: 29
  - Call Waiting Caller ID: 43
  - Caller ID service: 43
  - Caller list
    - Calling back: 44
    - Editing: 45
    - Erasing: 47
    - Storing: 46, 47
    - Viewing: 44
  - Chain dial: 34
  - Conference calls: 41
  - Connections
    - Communication device: 22
    - Handset and AC adaptor: 14
    - Noise filter: 18, 19
    - Standard telephone: 69
    - Telephone line cords: 15, 16, 17
- D** Date and time: 24
  - Day time: 54
  - Dialing mode: 24
  - Display language: 23
  - Do Not Disturb (DND): 27
- E** Error messages: 70
  - Extension No.: 23
- F** Flash: 29
  - Flash time: 30
- G** Greeting message: 59
- H** Headset, optional: 66
  - Hold: 28
  - Hold reminder: 29
- I** Intercept call: 58
  - Intercom: 38
- L** Line group: 20, 52
- M** Making calls: 25
  - Memory capacity: 57
  - Memory card: 11
  - Message length: 64
  - Message waiting: 65
  - Missed calls: 43
  - Mute: 29
- N** Navigator key: 10
  - Night time: 54
- P** Page: 39
  - Pause: 26
  - Phonebook: 31
  - Power failure: 14
  - Pre-recorded greeting message: 60
  - Prime line: 51
  - Pulse service: 30
- R** Redial list: 25
  - Remote code: 62
  - Remote operation: 62
  - Reset all: 52
  - Ringer on/off: 26
  - Ringer type: 27
  - Room monitor: 40
  - Rotary service: 30
- S** Speed dial preference: 35
  - Speed dialer: 35
  - SP-phone: 25
- T** Toll saver: 63
  - Tone service: 30
  - Transferring calls: 40
  - Troubleshooting: 70
  - TTY: 5, 84
- V** Voice Mail service: 64, 65
  - Voice memo: 61
  - Volume
    - Handset: 25
    - Headset: 66
    - Ringer: 26
    - Speaker: 25
- W** Wall mounting: 67
  - Warranty: 79

---

# Notes

---

## Notes

## ***If you need assistance with setup or operation***

- 1** Visit our website: <http://www.panasonic.com/phonehelp>
- 2** Contact us via the web at: <http://www.panasonic.com/contactinfo>
- 3** Call us at: 1-800-211-PANA (1-800-211-7262)  
TTY users (hearing or speech impaired users) can call 1-877-833-8855.

### **When you ship the product**

- Carefully pack your unit, preferably in the original carton.
- Attach a letter, detailing the symptom, to the outside of the carton.
- Send the unit to Panasonic Services Company Customer Servicer, prepaid and adequately insured.
- Do not send your unit to Panasonic Consumer Electronics Company listed below or to executive or regional sales offices. These locations do not repair consumer products.

**Panasonic Consumer Electronics Company,  
Division of Panasonic Corporation of North America**  
One Panasonic Way, Secaucus, New Jersey 07094

**Panasonic Puerto Rico, Inc.**  
San Gabriel Industrial Park, Ave. 65 de Infantería, Km. 9.5,  
Carolina, Puerto Rico 00985

#### **Copyright:**

This material is copyrighted by Panasonic Communications (Malaysia) Sdn. Bhd., and may be reproduced for internal use only. All other reproduction, in whole or in part, is prohibited without the written consent of Panasonic Communications (Malaysia) Sdn. Bhd.

© 2006 Panasonic Communications (Malaysia) Sdn. Bhd. All Rights Reserved.



\*TS4300\*

**PQQX15445YA** FM0706FS1086