

Panasonic®

Operating Instructions

Link-to-Cell Cellular Convergence Solution

Model No. **KX-TG9541**

KX-TG9542

2LINE



Model shown is KX-TG9541.

Before initial use, see “Getting Started” on page 9.

Thank you for purchasing a Panasonic product.

Please read these operating instructions before using the unit and save them for future reference.

Consulte “Guía Rápida Española”, página 73.

For assistance, visit our Web site: <http://www.panasonic.com/help> for customers in the U.S.A. or Puerto Rico.

Please register your product: <http://www.panasonic.com/prodreg>

Introduction

Model composition	3
Accessory information	3
System capabilities	5

Important Information

For your safety	6
Important safety instructions	7
For best performance	7
Other information	7
Specifications	8

Getting Started

Setting up	9
Power back-up operation	12
Intelligent eco mode	12
Controls	13
Display icons/Indicators	14
Date and time	16
Language setting	16
Other settings	16

Link to Cell

Link to cell feature	18
Pairing a cellular phone	18
Link to cell settings	19

Making/Answering Calls Using the Handset

Making cellular calls	22
Making landline calls	22
Answering calls	23
Useful features during a call	23

Making/Answering Calls Using the Base Unit

Making cellular calls	27
Making landline calls	27
Answering calls	27
Useful features during a call	28

Intercom

Intercom	31
----------------	----

Phonebook

Phonebook	32
Speed dial	35

Programming

Menu list	37
Alarm	43
Silent mode	44
Call block	44
Other programming	46
Registering a unit	46

Caller ID Service

Using Caller ID service	47
Caller list	47

Using Bluetooth Devices

Copying phonebook from a cellular phone (phonebook transfer)	50
Text message (SMS) alert	51
Using a Bluetooth wireless headset (optional) for landline calls	51

Answering System for Landline

Answering system for landline	54
Turning the answering system on/off	54
Greeting message	54
Listening to messages using the base unit	56
Listening to messages using the handset	56
Advanced new message alerting features	57
Remote operation	59
Answering system settings	60

Useful Information

Voice mail service for landline	62
Wall mounting	62
Error messages	64
Troubleshooting	65
FCC and other information	71

Guía Rápida Española

Guía Rápida Española	73
----------------------------	----

Appendix

Customer services	83
Warranty (For United States and Puerto Rico)	84

Index

Index	86
-------------	----

Model composition

Series	Model No.	Base unit	Handset	
		Part No.	Part No.	Quantity
KX-TG9541 series	KX-TG9541*1	KX-TG9541	KX-TGA950	1
	KX-TG9542	KX-TG9541	KX-TGA950	2

*1 Single handset models: Intercom calls can be made between handsets by purchasing and registering one or more optional handsets (page 4).

Accessory information

Supplied accessories

No.	Accessory item/Order number	Quantity	
		KX-TG9541	KX-TG9542
①	AC adaptor/PNLV234Z	1	1
②	4-wire telephone line cord with green plugs/PQJA10088Z	1	1
③	2-wire telephone line cord with transparent plugs/PQJA10075Z	1	1
④	Desk stand/Wall mounting adaptor*1/PNKL1040Z1	1	1
⑤	Rechargeable batteries for handset/HHR-55AAABUG	2	4
⑥	Handset cover*2/PNYNTGA680BR	1	2
⑦	Belt clip/PNKE1268Z1	1	2
⑧	Charger/PNLC1040ZB	–	1

*1 The desk stand/wall mounting adaptor comes attached to the base unit.

*2 The handset cover comes attached to the handset.

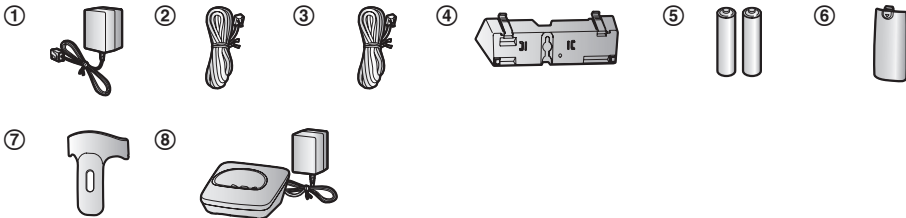

Additional/replacement accessories

Please contact your nearest Panasonic dealer for sales information (page 83).

Accessory item	Order number
Rechargeable batteries	HHR-55AAABUG*1 ● To order, please call 1-800-332-5368 or visit http://www.panasonic.com/batterystore
	Battery type: – Nickel metal hydride (Ni-MH) – 2 x AAA (R03) size for each handset
Headset	KX-TCA60, KX-TCA93, KX-TCA400, KX-TCA430
T-adaptor	KX-J66
2-line splitter	KX-J42
Range extender	KX-TGA405*2
Key detector	KX-TGA20*3



- *1 Replacement batteries may have a different capacity from that of the supplied batteries.
- *2 By installing this unit, you can extend the range of your phone system to include areas where reception was previously not available. This product can be purchased online. Please visit our Web site: <http://www.panasonic.com/RangeExtender>
- *3 By registering the key detector (4 max.) to a Panasonic Digital Cordless Phone and attaching it to an easy-to-lose item in advance, you can locate and find the mislaid item to which the key detector is attached. Please visit our Web site: <http://panasonic.net/pcc/products/telephone/p/tga20/>

Expanding your phone system

Handset (optional): KX-TGA950	
You can expand your phone system by registering optional handsets (6 max.) to a single base unit. ● Optional handsets may be a different color from that of the supplied handsets.	

Bluetooth® devices

You can expand your phone system by pairing the following units to a single base unit.

Your Bluetooth cellular phone *1: 4 max. (for cellular calls: page 18)	
Your Bluetooth headset *1: 1 max. (for a wireless hands-free conversation: page 51)	

- *1 Your cellular phone and headset must be Bluetooth wireless technology compatible. For more details and the list of compatible cellular phones, please visit our Web site:

Trademarks

- The Bluetooth® word mark and logos are owned by the Bluetooth SIG, Inc. and any use of such marks by Panasonic Corporation is under license. All other trademarks identified herein are the property of their respective owners.

System capabilities

The unit can accommodate up to 2 external telephone lines and the following operations are available at the same time.

How many units can be in use at one time?

■ A maximum of 4 parties are available:

Line 1: Outside call (including 1 extension and 1 outside party)

Line 2: Outside call (including 1 extension and 1 outside party)

e.g. Outside call on line 1



e.g. Outside call on line 2



■ A maximum of 5 parties are available:

Line 1: Conference call (including 2 extensions and 1 outside party)

Line 2: Outside call (including 1 extension and 1 outside party)

e.g. Conference call on line 1



e.g. Outside call on line 2



■ The following operations are possible simultaneously:

- An outside call and 1 pair of intercom call can be made at a time.
- While a caller is leaving a message on your answering system through one line, the unit can make an outside call through another line.

Note:

- The maximum operating number may decrease, depending on the state of usage, for example, when the answering system is taking a call.

For your safety

To prevent severe injury and loss of life/property, read this section carefully before using the product to ensure proper and safe operation of your product.

WARNING

Power connection

- Use only the power source marked on the product.
- Do not overload power outlets and extension cords. This can result in the risk of fire or electric shock.
- Completely insert the AC adaptor/power plug into the power outlet. Failure to do so may cause electric shock and/or excessive heat resulting in a fire.
- Regularly remove any dust, etc. from the AC adaptor/power plug by pulling it from the power outlet, then wiping with a dry cloth. Accumulated dust may cause an insulation defect from moisture, etc. resulting in a fire.
- Unplug the product from power outlets if it emits smoke, an abnormal smell, or makes an unusual noise. These conditions can cause fire or electric shock. Confirm that smoke has stopped emitting and contact the Panasonic Call Center at 1-800-211-PANA (1-800-211-7262).
- Unplug from power outlets and never touch the inside of the product if its casing has been broken open.
- Never touch the plug with wet hands. Danger of electric shock exists.

Installation

- To prevent the risk of fire or electrical shock, do not expose the product to rain or any type of moisture.
- Do not place or use this product near automatically controlled devices such as automatic doors and fire alarms. Radio waves emitted from this product may cause such devices to malfunction resulting in an accident.
- Do not allow the AC adaptor or telephone line cord to be excessively pulled, bent or placed under heavy objects.

Operating safeguards

- Unplug the product from power outlets before cleaning. Do not use liquid or aerosol cleaners.
- Do not disassemble the product.
- Do not spill liquids (detergents, cleansers, etc.) onto the telephone line cord plug, or allow it to become wet at all. This may cause a fire. If the telephone line cord plug becomes wet, immediately pull it from the telephone wall jack, and do not use.

Medical

- Consult the manufacturer of any personal medical devices, such as pacemakers or hearing aids, to determine if they are adequately shielded from external RF (radio frequency) energy. (The product operates in the frequency range of 1.92 GHz to 1.93 GHz, and the RF transmission power is 115 mW (max.).)
- Do not use the product in health care facilities if any regulations posted in the area instruct you not to do so.

Hospitals or health care facilities may be using equipment that could be sensitive to external RF energy.

CAUTION

Installation and location

- Never install telephone wiring during an electrical storm.
- Never install telephone line jacks in wet locations unless the jack is specifically designed for wet locations.
- Never touch uninsulated telephone wires or terminals unless the telephone line has been disconnected at the network interface.
- Use caution when installing or modifying telephone lines.
- The AC adaptor is used as the main disconnect device. Ensure that the AC outlet is installed near the product and is easily accessible.
- This product is unable to make calls when:
 - the handset batteries need recharging or have failed.
 - there is a power failure.

Battery

- We recommend using the batteries noted on page 4. **USE ONLY rechargeable Ni-MH batteries AAA (R03) size.**
- Do not mix old and new batteries.
- Do not open or mutilate the batteries. Released electrolyte from the batteries is corrosive and may cause burns or injury to the eyes or skin. The electrolyte is toxic and may be harmful if swallowed.
- Exercise care when handling the batteries. Do not allow conductive materials such as rings, bracelets, or keys to touch the batteries, otherwise a short circuit may cause the batteries and/or the conductive material to overheat and cause burns.
- Charge the batteries provided with or identified for use with this product only, in accordance with the instructions and limitations specified in this manual.
- Only use a compatible base unit (or charger) to charge the batteries. Do not tamper with the base unit (or charger). Failure to follow these instructions may cause the batteries to swell or explode.

Attention:



A nickel metal hydride battery that is recyclable powers the product you have purchased. Please call 1-800-8-BATTERY (1-800-822-8837) for information on how to recycle this battery.

Important safety instructions

When using your product, basic safety precautions should always be followed to reduce the risk of fire, electric shock, and injury to persons, including the following:

1. Do not use this product near water for example, near a bathtub, washbowl, kitchen sink, or laundry tub, in a wet basement or near a swimming pool.
2. Avoid using a telephone (other than a cordless type) during an electrical storm. There may be a remote risk of electric shock from lightning.
3. Do not use the telephone to report a gas leak in the vicinity of the leak.
4. Use only the power cord and batteries indicated in this manual. Do not dispose of batteries in a fire. They may explode. Check with local codes for possible special disposal instructions.

SAVE THESE INSTRUCTIONS

For best performance

Base unit location/avoiding noise

The base unit and other compatible Panasonic units use radio waves to communicate with each other.

- For maximum coverage and noise-free communications, place your base unit:
 - at a convenient, high, and central location with no obstructions between the handset and base unit in an indoor environment.
 - away from electronic appliances such as TVs, radios, personal computers, wireless devices, or other phones.
 - facing away from radio frequency transmitters, such as external antennas of mobile phone cell stations. (Avoid putting the base unit on a bay window or near a window.)
- Coverage and voice quality depends on the local environmental conditions.
- If the reception for a base unit location is not satisfactory, move the base unit to another location for better reception.

Environment

- Keep the product away from electrical noise generating devices, such as fluorescent lamps and motors.
- The product should be kept free from excessive smoke, dust, high temperature, and vibration.
- The product should not be exposed to direct sunlight.
- Do not place heavy objects on top of the product.
- When you leave the product unused for a long period of time, unplug the product from the power outlet.
- The product should be kept away from heat sources such as heaters, kitchen stoves, etc. It should not be placed in rooms where the temperature is less than 0 °C (32 °F) or greater than 40 °C (104 °F). Damp basements should also be avoided.
- The maximum calling distance may be shortened when the product is used in the following places: Near obstacles such as hills, tunnels, underground, near metal objects such as wire fences, etc.

- Operating the product near electrical appliances may cause interference. Move away from the electrical appliances.

Routine care

- Wipe the outer surface of the product with a soft moist cloth.
- Do not use benzine, thinner, or any abrasive powder.

Other information

CAUTION: Risk of explosion if battery is replaced by an incorrect type. Dispose of used batteries according to the instructions.

Notice for product disposal, transfer, or return

- This product can store your private/confidential information. To protect your privacy/confidentiality, we recommend that you erase information such as phonebook or caller list entries from the memory before you dispose of, transfer, or return the product.

Notice

- This product is designed for use in the United States of America. Sale or use of this product in other countries may violate local laws.
- Cet appareil est conçu pour être utilisé aux États-Unis d'Amérique. La vente ou l'emploi de cet appareil dans certains autres pays peut constituer une infraction à la législation locale.
- Este producto está diseñado para usarse en los Estados Unidos de América. La venta o el empleo de este producto en ciertos países puede constituir violación de la legislación local.
- 本產品專為美國使用而設。若在其他國家銷售或使用，可能會違反當地法例。
- この製品は、日本国外での使用を目的として設計されており、日本国内での使用は法律違反となります。従って、当社では日本国内においては原則として修理などのサービスは致しかねます。

Specifications

- **Standard:**
DECT 6.0 (Digital Enhanced Cordless Telecommunications 6.0)
Bluetooth wireless technology 2.1
- **Frequency range:**
1.92 GHz to 1.93 GHz (DECT)
2.402 GHz to 2.48 GHz (Bluetooth)
- **RF transmission power:**
115 mW (max.)
- **Power source:**
120 V AC, 60 Hz
- **Power consumption:**
Base unit:
Standby: Approx. 1.2 W
Maximum: Approx. 4.5 W
Charger:
Standby: Approx. 0.1 W
Maximum: Approx. 1.8 W
- **USB Charger:**
Output voltage: DC 5 V
Output current: 500 mA
- **Operating conditions:**
0 °C – 40 °C (32 °F – 104 °F), 20 % – 80 % relative air humidity (dry)

Note:

- Design and specifications are subject to change without notice.
- The illustrations in these instructions may vary slightly from the actual product.

Setting up

Connecting the AC adaptor

■ Base unit

- Use only the supplied Panasonic AC adaptor PNLV234.

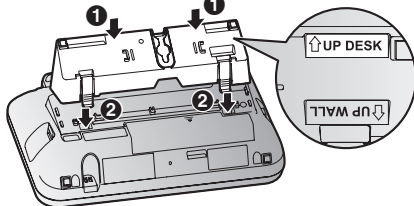
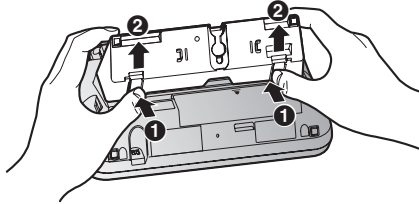

- The words "UP DESK" should be facing up.
- Follow the directions on the display to set up the unit.

■ Charger

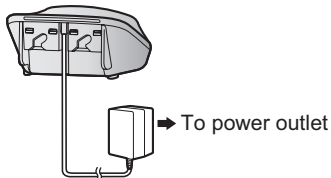

Connecting the telephone line cord

Refer to one of the following methods depending on your situation:

- To connect to a 2-line telephone jack: page 9
- To connect to 2 single-line telephone jacks: page 9
- If you use the unit as a single-line telephone only: page 10

Connect the telephone line cord until it clicks into the base unit and telephone line jack.

To connect to a 2-line telephone jack

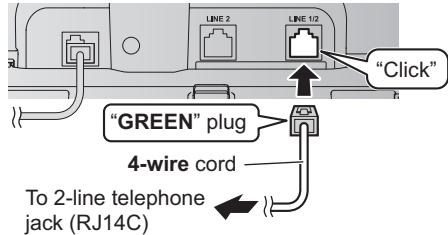

To connect to 2 single-line telephone jacks

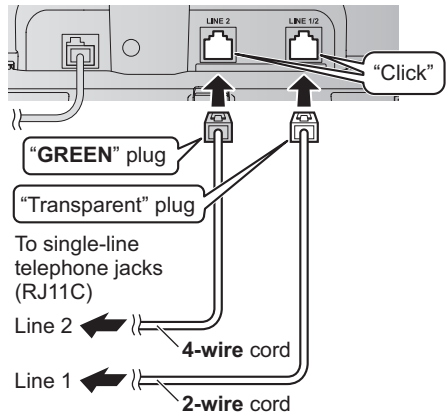

If you use the unit as a single-line telephone only

Be sure to connect the telephone line cord to LINE 1/2. Change the line selection mode from "Auto" to "Line1" (page 16).

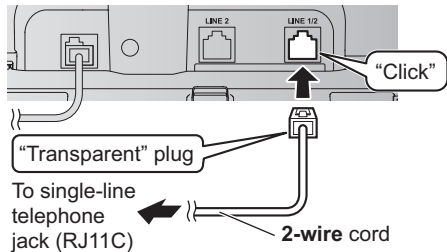

Note:

- "Check tel line 2" is displayed on the unit. To erase it, see page 64.

If you subscribe to a DSL/ADSL service

Please attach a DSL/ADSL filter (contact your DSL/ADSL provider) to the telephone line between the base unit and the telephone line jack in the event of the following:

- noise is heard during conversations.
- Caller ID features do not function properly.

To connect to a 2-line telephone jack

For this connection, please purchase a Panasonic 2-line splitter (page 4).

Example: DSL/ADSL line is line 2

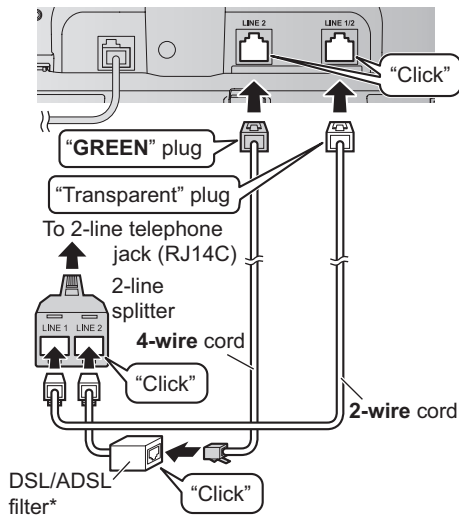

*DSL/ADSL filter (not supplied) is required if you have DSL/ADSL service.

To connect to 2 single-line telephone jacks

Example: DSL/ADSL line is line 2

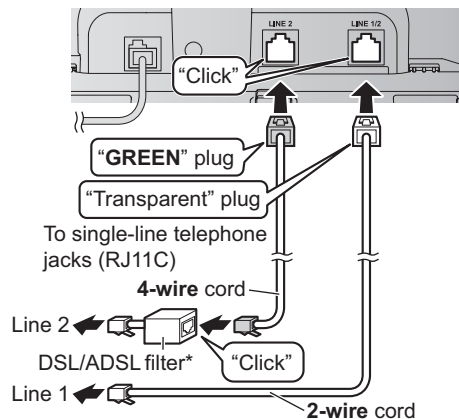

*DSL/ADSL filter (not supplied) is required if you have DSL/ADSL service.

Battery installation

- USE ONLY Ni-MH batteries AAA (R03) size.
- Do NOT use Alkaline/Manganese/Ni-Cd batteries.
- Confirm correct polarities (⊕, ⊖).

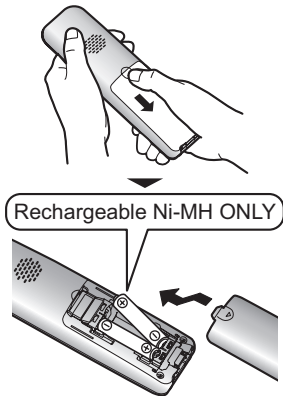

- Follow the directions on the display to set up the unit.

Battery charging

Charge for about 7 hours.

- When the batteries are fully charged, “Fully charged” is displayed.

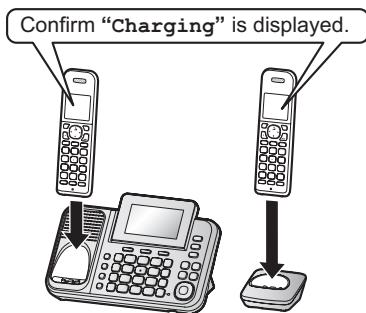

Note when setting up

Note for connections

- The AC adaptor must remain connected at all times. (It is normal for the adaptor to feel warm during use.)
- The AC adaptor should be connected to a vertically oriented or floor-mounted AC outlet.

Do not connect the AC adaptor to a ceiling-mounted AC outlet, as the weight of the adaptor may cause it to become disconnected.

Note for battery installation

- Use the supplied rechargeable batteries. For replacement, we recommend using the Panasonic rechargeable batteries noted on page 4, 6.

Note for battery charging

- It is normal for the handset to feel warm during charging.
- Clean the charge contacts of the handset, base unit, and charger with a soft and dry cloth once a month. Before cleaning the unit, disconnect from power outlets and any telephone line cords. Clean more often if the unit is exposed to grease, dust, or high humidity.

Battery level

Icon	Battery level
	High
	Medium
	Low
	Needs charging.
	Empty

Panasonic Ni-MH battery performance (supplied batteries)

Operation	Operating time
In continuous use	15 hours max.*1
Not in use (standby)	170 hours max.*1

*1 If eco mode is on.

Note:

- Actual battery performance depends on usage and ambient environment.

Power back-up operation

The backup battery in the base unit works as emergency power during a power failure.

Battery installation

The base unit can provide emergency power if supplied with 2 standard AAA (R03) batteries (not supplied).

Important:

- Before inserting the batteries into the base unit, disconnect the telephone line cords.

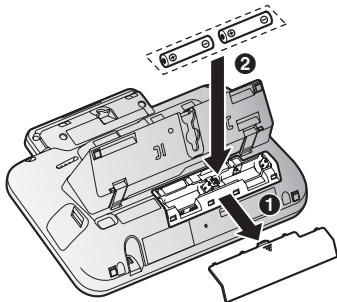

- 1 Open the battery cover (1).
- 2 Install the batteries in the battery compartment (2).
- 3 When finished, close the cover.
 - When this feature is turned on,  is displayed.

Battery caution

- The batteries should be used correctly, otherwise the unit may be damaged due to battery leakage.
- Do not mix old, new or different types of batteries.
- Do not charge, short-circuit, disassemble, or heat the batteries.
- Do not dispose of batteries in a fire.
- It is recommended that batteries are replaced annually.
- It is recommended that batteries are replaced after a power outage.
- Operating time may be shortened depending on usage conditions, ambient temperature, and battery quality.
- Remove all the batteries when replacing.

Battery life

During a power failure, the following performance will be available.

Ni-MH batteries

Operation	Operating time
While in use (talking)	6 hours max.
While not in use (standby)	13 hours max.

Note:

- The operating time depends on the type of batteries.
- The battery cannot be charged even if the AC adaptor is connected.
- If  on the base unit flashes, the battery power is low. Install new batteries as soon as possible.

Intelligent eco mode

This feature automatically reduces handset power consumption by suppressing handset transmission power when the handset is close to the base unit.

- When this feature is activated, **ECO** is displayed. However, during a call, **ECO** is not displayed even though this feature is activated.
- Eco mode is turned off when the clarity booster is activated (page 23).

Controls

Handset

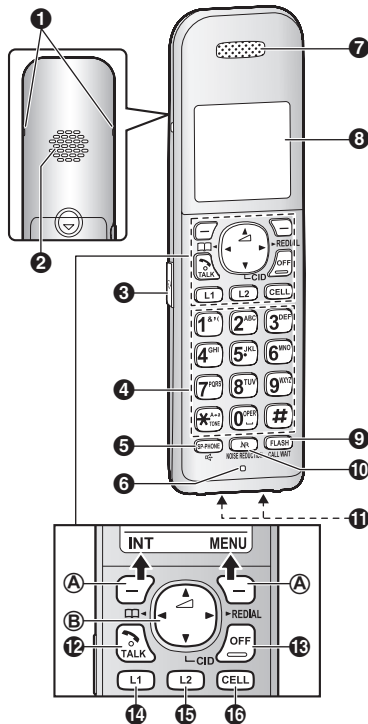

- 1** Belt clip hole
- 2** Speaker
- 3** Headset jack
- 4** Dial keypad (☒: TONE)
- 5** [☎] (SP-PHONE: Speakerphone)
- 6** Microphone
- 7** Receiver
- 8** Display
- 9** [FLASH] [CALL WAIT]
- 10** [NR] [NOISE REDUCTION]
- 11** Charge contacts
- 12** [☞] (TALK)
- 13** [OFF]
- 14** [L1] (Line 1)
- 15** [L2] (Line 2)
- 16** [CELL]

- Control type
- Ⓐ Soft keys

By pressing a soft key, you can select the feature shown directly above it on the display.

Ⓑ Navigator key

- [▲], [▼], [◀], or [▶]: Scroll through various lists and items.
- [↻] (Volume: [▲] or [▼]): Adjust the receiver or speaker volume while talking.
- [☞] [☎]: View the phonebook entry.
- [▶] [RE] [DIAL]: View the redial list.
- [▼] [CID] (Caller ID): View the caller list.

Base unit

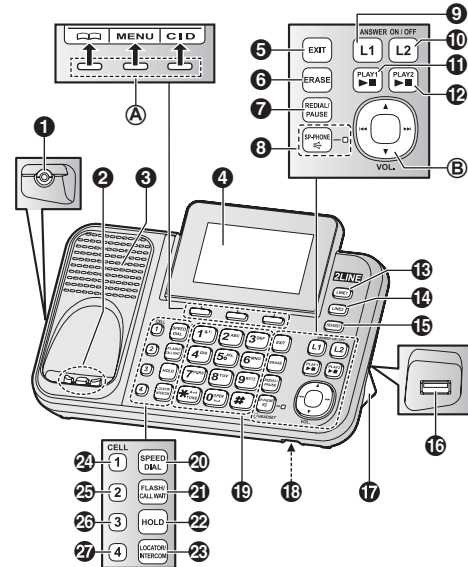

- 1** Headset jack
- 2** Charge contacts
- 3** Speaker
- 4** Display
 - The display can be moved back and forth to select the desired angle.
- 5** [EXIT]
- 6** [ERASE]
- 7** [RE] [DIAL] [PAUSE]
- 8** [☎] (SP-PHONE: Speakerphone)
 - SP-PHONE indicator
 - Corded headset indicator
- 9** [L1] (Line 1: ANSWER ON/OFF)
 - L1 ANSWER ON/OFF indicator
- 10** [L2] (Line 2: ANSWER ON/OFF)
 - L2 ANSWER ON/OFF indicator
- 11** [▶] [■] (PLAY1) (Stop)
 - Message indicator

- 12 **[▶■] (PLAY2) (Stop)**
Message indicator
- 13 **[LINE 1]**
LINE 1 indicator
- 14 **[LINE 2]**
LINE 2 indicator
- 15 **[HEADSET]**
Bluetooth HEADSET indicator
- 16 **USB jack**
- 17 **Desk stand/Wall mounting adaptor**
 - The adaptor is a removable attachment for desk stand or wall mounting use (page 62).
- 18 **Microphone**
- 19 **Dial keypad [☒]: TONE**
- 20 **[SPEED DIAL]**
- 21 **[FLASH] [CALL WAIT]**
- 22 **[HOLD]**
- 23 **[LOCATOR] [INTERCOM]**
 - You can locate a misplaced handset by pressing [LOCATOR].
- 24 **[CELL 1]**
CELL 1 indicator
- 25 **[CELL 2]**
CELL 2 indicator
- 26 **[CELL 3]**
CELL 3 indicator
- 27 **[CELL 4]**
CELL 4 indicator

■ Control type

Ⓐ Soft keys

By pressing a soft key, you can select the feature shown directly above it on the display.

Ⓑ Navigator key

- **[▲], [▼], [◀], [▶]**: Scroll through various lists and items.
- **VOL.** (Volume: **[▲]** or **[▼]**): Adjust the speaker volume while talking.
- **[◀▶]/[▶▶]**: Repeat/skip messages during playback.

Charging the cellular phone by USB

By connecting a USB cable (not supplied) to the cellular phone and the base unit, you can charge a cellular phone. However, the cellular phone cannot

exchange data with the base unit through a USB cable.

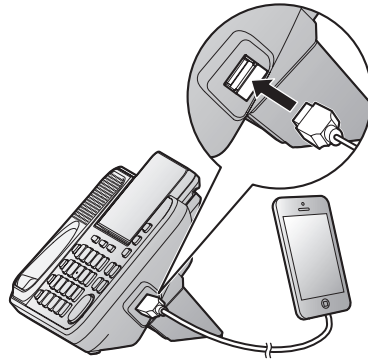





Note:

- USB charging may not work properly depending on the cellular phone's specifications.

Display icons/Indicators



Handset display items

Item	Meaning
⚡	Within base unit range
⚡	Out of base unit range
📞	The landline is in use.* ¹ <ul style="list-style-type: none"> • When flashing: The call is put on hold. • When flashing rapidly: An incoming call is now being received.
📱	A cellular line is in use. <ul style="list-style-type: none"> • When flashing: The cellular call is put on hold. • When flashing rapidly: A cellular call is being received.
ECO	Eco mode is on.* ² (page 12)
📶	A cellular phone is connected.* ³ Ready to make/receive cellular calls. <ul style="list-style-type: none"> • When turned off: A cellular phone is not connected to the base unit. (page 20)

Item	Meaning
C1	– The cellular line is selected for the setting.
C2	
C3	
C4	
NR	Noise reduction is set. (page 24)
EQ	Equalizer is set. (page 24)
	Speakerphone is on. (page 22)
	Ringer volume is off.*4 (page 23, 39)
Zz	Silent mode is on. (page 44)
PRIV	Call sharing mode is off. (page 42)
	Alarm is on. (page 43)
1	Handset number
	Battery level
	Blocked call (page 44)
In use:	Someone is using the corresponding line.

- *1 Corresponding landline number(s) is(are) indicated next to the item.
- *2 During a call, the item is not displayed even though the feature is activated.
- *3 Corresponding cellular line(s) is(are) indicated next to the item.
- *4 Corresponding lines (1, 2: landline, C: cellular line) are indicated next to the item. If all lines are turned off, no line is indicated.

Base unit display items

Item	Meaning
Zz	Silent mode is on. (page 44)
L1  C1 C2 C3 C4	Ringer volume is off.*1 (page 28, 39)
PRIVACY	Call sharing mode is off. (page 42)
GO L1	“Greeting only” is selected. Caller messages are not recorded.*2 (page 55)
	Power back-up mode is on. (page 12)
In use:	Someone is using the corresponding line.

- *1 Corresponding lines (L1, L2: landline, C1-C4: cellular line) are indicated next to the item.

- *2 Corresponding landline number(s) is(are) indicated next to the item.

CELL indicators on the base unit

The CELL indicators show each cellular line status.

Status	Meaning
On	A cellular phone is connected. Ready to make/receive cellular calls.
Flashing	– The cellular line is in use. – Phonebook entries are being copied from a cellular phone (page 50). – The base unit is searching for the paired cellular phone. – The base unit is pairing a cellular phone. – A cellular call is put on hold.
Flashing rapidly	A cellular call is being received.
Light off	– A cellular phone is not paired to the base unit. – A cellular phone is not connected to the base unit (page 20).

Bluetooth HEADSET indicator on the base unit

The HEADSET indicator shows the Bluetooth headset status.

Status	Meaning
On	A Bluetooth headset is connected to the base unit. Ready to use it.
Flashing	– A Bluetooth headset is in use – The base unit is searching for the paired Bluetooth headset. – The base unit is pairing a headset. – Mute is turned on.
Flashing rapidly	A landline call is being received.
Light off	– The Bluetooth headset is not connected to the base unit. – A Bluetooth headset is not paired to the base unit.

LINE indicator on the base unit

The LINE indicators show the status of each line, respectively, as follows.

Status	Meaning
Light off	The line is available.

Status	Meaning
Light on	The line is in use.
Flashing rapidly	A call is being received.
Flashing	A call is put on hold or the answering system is answering a call.

Date and time

Program this setting using either the base unit or one of the handsets.

Handset / Base unit

- 1 **[MENU]** **#** **1** **0** **1**
- 2 Enter the current month, date, and year by selecting 2 digits for each.
Example: July 15, 2013
0 **7** **1** **5** **1** **3**
- 3 **[OK]**
- 4 Enter the current hour and minute (12-hour clock format) by selecting 2 digits for each.
Example: 9:30
0 **9** **3** **0**
- 5 Proceed with the operation for your unit.
Handset: **[X]**: Select **[AM]** or **[PM]**.
Base unit: **[AM/PM]**: Select **[AM]** or **[PM]**.
- 6 **[SAVE]**
- 7 Proceed with the operation for your unit.
Handset: **[OFF]**
Base unit: **[EXIT]**

Note:

- When English is selected as the display language, 12-hour clock format is used. When Spanish is selected, 24-hour clock format is used.

Language setting

Display language

Handset / Base unit

- 1 **[MENU]** **#** **1** **1** **0**
- 2 **[↓]**: Select the desired setting. → **[SAVE]**

- 3 Proceed with the operation for your unit.

Handset: **[OFF]**
Base unit: **[EXIT]**

Voice guidance language

Program this setting using either the base unit or one of the handsets.

Handset / Base unit

- 1 **[MENU]** **#** **1** **1** **2**
- 2 **[↓]**: Select the desired setting. → **[SAVE]**
- 3 Proceed with the operation for your unit.
Handset: **[OFF]**
Base unit: **[EXIT]**

Other settings

Dialing mode

If you cannot make calls, change this setting according to your telephone line service. The default setting is “**Tone**”.

“**Tone**”: For tone dial service.

“**Pulse**”: For rotary/pulse dial service.

Program this setting using either the base unit or one of the handsets.

Handset / Base unit

- 1 **[MENU]** **#** **1** **2** **0**
- 2 **[↓]**: Select the desired setting. → **[SAVE]**
- 3 Proceed with the operation for your unit.
Handset: **[OFF]**
Base unit: **[EXIT]**

Line selection mode for landline

The line selection mode determines which line is selected when:

- you press **[↶]**/**[↷]** on the handset (when making/answering calls)
- you press **[↶]**/**[↷]** on the base unit (when making/answering calls)

The following setting is available:

- “**Auto**” (default): When making a call, line 1 is selected. If that line is unavailable, line 2 is selected. When you call back using the caller list (page 47) or while listening to a message (page 56, 57), the indicated line is used.

When answering a call, the ringing line is selected.

- “**Line1**”: Line 1 is selected.
- “**Line2**”: Line 2 is selected.

Handset / Base unit

- 1 **[MENU]** **#** **2** **5** **0**
- 2 **[↕]**: Select the desired setting. → **[SAVE]**
- 3 Proceed with the operation for your unit.
Handset: [OFF]
Base unit: [EXIT]

Note:

- You can select a line manually regardless of the line selection mode by pressing **[L1]**/**[L2]** on the handset or **[LINE 1]**/**[LINE 2]** on the base unit.

Link to cell feature

To use this feature, you must first pair and connect your cellular phones to the base unit (page 18). Your cellular phones must have Bluetooth wireless technology that is compatible with this product.

This feature allows you to:

- make or answer cellular calls using your home phone (handset or base unit) with better reception.
- maximize the benefits of cellular services (such as free night and weekend calls, or cellular to cellular call plans) by utilizing unused peak minutes with your home phone.
- conserve the battery power of your cellular phone while the unit is on a cellular call. (We recommend charging your cellular phone during the cellular call as your cellular phone battery is being consumed.)

Important:

- You may pair a maximum of 4 cellular phones and 1 headset. However, the base unit allows only one Bluetooth to be active at a time.
- Locate your cellular phone near the base unit. If the cellular phone is too close to the base unit during a cellular call, you may hear noise. For best performance, we recommend placing the cellular phone between 0.6 m to 3 m (2 feet to 10 feet) away from the base unit.

Pairing a cellular phone

Program this setting using either the base unit or one of the handsets.

Important:

- For more details and the list of compatible cellular phones, please visit our Web site: <http://www.panasonic.com/link2cell>
- Before pairing a Bluetooth enabled cellular phone to the base unit, make sure that no other Bluetooth device such as a Bluetooth headset is connected to your cellular phone.

Handset / Base unit

- 1 For CELL 1: **[MENU]** **#** **6** **2** **4** **1**
For CELL 2: **[MENU]** **#** **6** **2** **4** **2**
For CELL 3: **[MENU]** **#** **6** **2** **4** **3**
For CELL 4: **[MENU]** **#** **6** **2** **4** **4**

- After the corresponding CELL indicator on the base unit starts flashing, the rest of the procedure must be completed within 5 minutes.

2 Your cellular phone:

While the corresponding CELL indicator is flashing, follow the instructions of your cellular phone to enter the pairing mode.

- Depending on your cellular phone, it may ask you to enter the base unit PIN (default: “0000”).

3 Wait until a long beep sounds.

- It may take more than 10 seconds to complete pairing.
- When the CELL indicator lights up, the cellular phone is connected to the base unit. You are ready to make cellular calls.

4 Proceed with the operation for your unit.

Handset: [OFF]

Base unit: [EXIT]

Note:

- Make sure that your cellular phone is set to connect to this product automatically. Refer to your cellular phone’s operating instructions.
- Make sure you cancel your cellular phone’s current pairing if you want to pair it to the other line (page 18).
- The default setting for the text message alert feature is “On”, so when you pair your cellular phone to the base unit, this feature may be activated (page 51). (This depends on the version and type of cellular phone you are using.)

Unpairing a cellular phone

You can cancel the pairing of a cellular phone that is stored in the base unit.

Program this setting using either the base unit or one of the handsets.

Handset / Base unit

- 1 For CELL 1: **[MENU]** **#** **6** **1** **1** **1**
For CELL 2: **[MENU]** **#** **6** **1** **1** **2**
For CELL 3: **[MENU]** **#** **6** **2** **1** **3**
For CELL 4: **[MENU]** **#** **6** **2** **1** **4**
- 2 **[↕]**: “Yes” → **[SELECT]**
 - When the cellular phone is unpaired, the CELL indicator is turned off.
- 3 Proceed with the operation for your unit.
Handset: [OFF]

Base unit: [EXIT]

Link to cell settings

Selecting which unit receives cellular calls

You can select which unit rings and receives calls for a cellular line. When "a11" is selected, all handsets and the base unit ring.

Program this setting using either the base unit or one of the handsets.

Handset / Base unit

- 1 For CELL 1: [MENU]#6271
For CELL 2: [MENU]#6272
For CELL 3: [MENU]#6273
For CELL 4: [MENU]#6274
- 2 [↕]: Select the desired handset or "a11". → [SAVE]
- 3 Proceed with the operation for your unit.
Handset: [OFF]
Base unit: [EXIT]

Note:

- When you select a specific handset to receive calls for a cellular line:
 - other handsets cannot answer the calls.
 - the base unit can answer the calls even though it does not ring. However, you can make the base unit ring by adjusting the base unit ringer volume (page 39).
- When you change the setting to "a11", the base unit ringer volume also returns to the lowest level even if the ringer volume has been changed.
- The units selected with this setting have the text message alert feature (page 51) applied to them.

Ring as cell mode

Once this feature is turned on, the handset and base unit ring using the same ringer tone as your cellular phone.

The following settings are available:

- "OFF": Turn this feature off to use the ringer tones of the handset and base unit. Caller information is announced depending on the Talking Caller ID setting (page 41).

- "On (with Talking CID)" (default): The handset and base unit use your cellular phone's ringer tone. Caller information is announced even if the Talking Caller ID is turned off.
 - "On (without Talking CID)": The handset and base unit use your cellular phone's ringer tone. Caller information is not announced even if the Talking Caller ID is turned on.
- Program this setting using either the base unit or one of the handsets.

Important:

- To use this feature, your cellular phone must support Bluetooth in-band ringtone. Refer to your cellular phone's operating instructions.

Handset / Base unit

- 1 For CELL 1: [MENU]#6141
For CELL 2: [MENU]#6142
For CELL 3: [MENU]#6143
For CELL 4: [MENU]#6144
- 2 [↕]: Select the desired setting. → [SAVE]
- 3 Proceed with the operation for your unit.
Handset: [OFF]
Base unit: [EXIT]

Note:

- The units use the preset ringer tones (page 40) instead of your cellular phone's ringer tone when a cellular call is being received if:
 - your cellular phone is in silent mode (depending on your cellular phone).
 - the base unit is in use.
 - 2 handsets are sharing a landline call.
- If your cellular phone is in silent mode with "On (with Talking CID)" set, the unit announces caller information even when Talking Caller ID is turned off (page 41).

To use the handset ringer tone instead of your cellular phone's ringer tone

Select "OFF" in step 2, "Ring as cell mode", page 19.

To change the handset ringer tone for a cellular line, see page 39.

Auto connection to the cellular phone

After pairing, your cellular phone is connected to the base unit. If you move the cellular phone out of base unit range, the cellular phone is disconnected

from the base unit. This feature allows the base unit to try to reconnect the cellular phone at regular intervals when it returns within base unit range. You can set the interval. The default setting is "1 min".

Program this setting using either the base unit or one of the handsets.

Important:

- When you are using a cellular line or a Bluetooth headset, the base unit loses its connection from other Bluetooth devices (cellular phone or headset). To automatically resume the connection to cellular phones, leave the auto connection on.
- Some cellular phones lose connection after usage, please check the specifications of your cellular phone for more details.

Handset / Base unit

- 1 **[MENU]** **#** **6** **3** **2**
- 2 **[↕]**: Select the desired setting. → **[SAVE]**
- 3 Proceed with the operation for your unit.
Handset: [OFF]
Base unit: [EXIT]

Note:

- Some cellular phones may ask you if you accept the connection requirement from the base unit. In that case, select "OFF" in step 2. Check the specifications of your cellular phone.

Connecting/disconnecting the cellular phone manually

If you will not be using the paired cellular phone's link to cell feature temporarily (for example, you do not want the unit to ring when your cellular line receives a call), you can disconnect your cellular phone from the base unit. If you want to use it again, reconnect the cellular phone to the base unit.

Program this setting using either the base unit or one of the handsets.

Note:

- Even if a paired cellular phone was disconnected from the base unit, if it is brought within the base unit's range during the auto connection interval, it may automatically connect to the base unit (page 19).
- A disconnected cellular phone is not unpaired from the base unit, so pairing it to the base unit again is unnecessary.

Handset / Base unit

1 To connect/disconnect:

For CELL 1: **[MENU]** **#** **6** **2** **5** **1**

For CELL 2: **[MENU]** **#** **6** **2** **5** **2**

For CELL 3: **[MENU]** **#** **6** **2** **5** **3**

For CELL 4: **[MENU]** **#** **6** **2** **5** **4**

- A long beep sounds.

2 Proceed with the operation for your unit.

Handset: [OFF]

Base unit: [EXIT]

Cellular line selection

Handset

This feature determines which cellular line is selected to make cellular calls when you press **[CELL]** on the handset.

The following settings are available:

- "Manual" (default): You can select the desired cellular line when making a call.
- "Cellular phone 1": CELL 1 is selected.
- "Cellular phone 2": CELL 2 is selected.
- "Cellular phone 3": CELL 3 is selected.
- "Cellular phone 4": CELL 4 is selected.

1 **[MENU]** **#** **6** **3** **4**

2 **[↕]**: Select the desired setting. → **[SAVE]**

3 **[OFF]**

Storing your area code (for dialing only a 7-digit phone number to make a local call)

You need to add your area code when making cellular calls to a phone number in your area. Once you store your area code, it is automatically added to the beginning of the 7-digit phone number when making cellular calls. Program this setting using either the base unit or one of the handsets.

Handset / Base unit

1 **[MENU]** **#** **6** **3** **3**

2 Enter the 3-digit area code.

- To correct a digit, press **[CLEAR]**.

3 **[SAVE]**

4 Proceed with the operation for your unit.

Handset: [OFF]

Base unit: [EXIT]

Changing the Bluetooth PIN (Personal Identification Number)

The PIN is used to pair cellular phones to the base unit. The default PIN is “0000”. To prevent unauthorized access to this product, we recommend that you change the PIN, and keep it confidential.

Program this setting using either the base unit or one of the handsets.

Important:

- Please make note of your new PIN. The unit does not reveal the PIN to you. If you forget your PIN, see page 70.

Handset / Base unit

- 1 **[MENU]** **#** **6** **1** **9**
 - If the unit prompts you to enter the old PIN (when the default has been changed), enter the current 4-digit PIN.
- 2 Enter the new 4-digit PIN. → **[OK]**
- 3 Enter the new 4-digit PIN again. → **[SAVE]**
- 4 Proceed with the operation for your unit.
Handset: [OFF]
Base unit: [EXIT]

Making cellular calls

Important:

- Only 1 cellular line can be used at a time.
- Before making calls, confirm that the corresponding CELL indicator on the base unit lights up (page 15).

- 1 Lift the handset and dial the phone number.
 - To correct a digit, press **[CLEAR]**.
- 2 **[CELL]**
 - The unit starts dialing when:
 - only 1 cellular phone is paired.
 - a specific line is set to make cellular calls (page 20).Go to step 4.
- 3 **[↕]**: Select the desired cellular phone. → **[SELECT]**
- 4 When you finish talking, press **[OFF]** or place the handset on the base unit or charger.

Note:

- To switch to the speaker, press **[📞]**.
To switch back to the receiver, press **[📞]/[📞]**.

Adjusting the receiver or speaker volume

Press **[▲]** or **[▼]** repeatedly while talking.

Making a cellular call using the redial list

The last 5 phone numbers dialed are stored in the redial list (each 48 digits max.).

- 1 **[▶]** REDIAL
- 2 **[↕]**: Select the desired phone number.
- 3 **[CELL]**
 - The unit starts dialing when:
 - only 1 cellular phone is paired.
 - a specific line is set to make cellular calls (page 20).
- 4 **[↕]**: Select the desired cellular phone. → **[SELECT]**

Erasing a number in the redial list

- 1 **[▶]** REDIAL
- 2 **[↕]**: Select the desired phone number. → **[ERASE]**
- 3 **[↕]**: “Yes” → **[SELECT]**
- 4 **[OFF]**

Making landline calls

- 1 Lift the handset and dial the phone number.
 - To correct a digit, press **[CLEAR]**.
- 2 **[↷]**
 - An available line is automatically selected.
To change the line selection mode, see page 16.
 - You can also select the line manually by pressing **[L1]** or **[L2]**.
- 3 When you finish talking, press **[OFF]** or place the handset on the base unit or charger.

Note:

- The LINE 1 indicator or LINE 2 indicator on the base unit lights up while using the handset.

Using the speakerphone

- 1 Dial the phone number and press **[📞]**.
- 2 When you finish talking, press **[OFF]**.

Note:

- To switch back to the receiver, press **[📞]/[📞]**.

Making a call using the redial list

The last 5 phone numbers dialed are stored in the redial list (each 48 digits max.).

- 1 **[▶]** REDIAL
- 2 **[↕]**: Select the desired phone number.
- 3 **[↷]**

Pause (for PBX/long distance service users)

A pause is sometimes required when making calls using a PBX or long distance service. When storing a calling card access number and/or PIN in the phonebook, a pause is also needed (page 34).

Example: If you need to dial the line access number “9” when making outside calls with a PBX:

- 1 **[9]** → **[▲]** (Pause)
- 2 Dial the phone number. → **[↷]**

Note:

- A 3.5 second pause is inserted each time **[▲]** (Pause) is pressed.

Answering calls

- 1 Press [📶] or [📞] when the unit rings.
 - To answer a cellular call, you can also press [CELL].
 - The called landline is automatically selected. To change the line selection mode, see page 16.
 - You can also answer the landline call by pressing [L1] or [L2].
- 2 When you finish talking, press [OFF].

Any key answer: You can answer the call by pressing any dial key.

Auto talk: You can answer calls simply by lifting the handset (page 42).

Temporary ringer off: You can turn the ringer off temporarily by pressing [🔕].

Adjusting the handset ringer volume

Press [▲] or [▼] repeatedly to select the desired volume while ringing.

Useful features during a call

Hold

- 1 Press [MENU] during an outside call.
- 2 [📶]: “Hold” → [SELECT]
 - During hold, the caller will hear music. For canceling music, see page 42.
- 3 **To release hold on the cellular line:**
Press [CELL].
 - Another handset user can take the call:
[CELL]*1 → [SELECT]
 - *1 The call is taken when:
 - only 1 cellular phone is paired.
 - a specific line is set to make cellular calls (page 20).
 - The base unit user can take the call by pressing the desired cellular line key ([CELL 1] to [CELL 4]).

To release hold on the landline:
Press [L1] or [L2].

Note:

- After holding for 10 minutes, the call is disconnected.

Mute

- 1 Press [MUTE] during a call.
- 2 To return to the call, press [MUTE].

Note:

- [MUTE] is a soft key visible on the display during a call.

Flash for landline calls

[FLASH] allows you to use the special features of your host PBX such as transferring an extension call, or accessing optional telephone services.

Note:

- To change the flash time, see page 42.

For call waiting or Call Waiting Caller ID service users

To use call waiting or Call Waiting Caller ID, you must first subscribe with your service provider/telephone company.

This feature allows you to receive calls while you are already talking on the phone. If you receive a call while on the phone, you will hear a call waiting tone.

If you subscribe to both Caller ID and Call Waiting with Caller ID services, the 2nd caller's information is displayed after you hear the call waiting tone on the handset.

- 1 Press [CALL WAIT] to answer the 2nd call.
- 2 To switch between calls, press [CALL WAIT].

Note:

- Please contact your service provider/telephone company for details and availability of this service in your area.

Temporary tone dialing for landline calls (for rotary/pulse service users)

Press [☒] (TONE) before entering access numbers which require tone dialing.

Handset clarity booster

This feature can improve sound clarity when the handset is used in an area where there may be interference. During an outside call, this feature is turned on automatically when necessary.

Handset noise reduction

This feature allows you to hear the voice of the person you are talking to clearly, by reducing the surrounding noise coming from the other party's telephone.

Press **[NOISE REDUCTION]** to turn on/off while talking.

Note:

- Depending on the environment where this handset is being used, this feature may not be effective.
- This feature is not available using the speakerphone.
- When both the "Equalizer" setting and noise reduction are activated, **NR** is shown on the display.

Handset equalizer

This feature clarifies the voice of the person you are talking to, producing a more natural-sounding voice that is easier to hear and understand.

- 1 Press **[MENU]** while talking.
- 2 **[↕]**: "Equalizer" → **[SELECT]**
- 3 **[↕]**: Select the desired setting.
- 4 Press **[OK]** to exit.

Note:

- Depending on the condition and quality of your telephone line, this feature may emphasize existing line noise. If it becomes difficult to hear, turn this feature off.
- This feature is not available while using the speakerphone.

Call share

You can join an existing outside call.

■ While another unit is on a cellular call:

- 1 To join the conversation, press **[CELL]**.
 - You can join the conversation when:
 - only 1 cellular phone is paired.
 - a specific line is set to make cellular calls (page 20).
- 2 **[↕]**: Select the desired cellular phone. → **[SELECT]**

■ While another unit is on a landline call:

To join the conversation, press **[L1]** or **[L2]** to select the line that is being used by another extension for an outside call.

Note:

- A maximum of 3 parties (including 1 outside party) can join a conversation using 2 extensions. (**3-way conference**)
- To prevent other users from joining your conversations with outside callers, turn call sharing mode off (page 42).

Transferring calls

Outside calls can be transferred between 2 people.

- 1 During an outside call, press **[MENU]** to put the call on hold.
- 2 **[↕]**: "Intercom" → **[SELECT]**
- 3 **[↕]**: Select the desired unit. → **[SELECT]**
- 4 Wait for the paged party to answer.
 - If the paged party does not answer, press **[BACK]** to return to the outside call.
- 5 Press **[OFF]**.

Conference landline calls

3 people can establish a conference call.

Conference call with 2 outside calls

While you are talking with an outside caller, you can make or answer a 2nd call on the other line, and then combine the calls to establish a conference call.

- 1 During an outside call, press **[MENU]** to put the call on hold.
- 2 **[↕]**: "Hold" → **[SELECT]**
- 3 **To make a 2nd call:**
Press **[L1]** or **[L2]**, then dial the phone number.
To answer a 2nd call:
Press **[L1]** or **[L2]**.
- 4 When the 2nd call is connected, press **[MENU]**. → **[↕]**: "Conference" → **[SELECT]**
 - The 2 calls are combined.
 - To hang up only one line, press **[L1]** or **[L2]** for the party with which you want to continue talking.
 - To put both lines on hold, press **[MENU]**. → **[↕]**: "Hold" → **[SELECT]**

To talk with only one caller, press **[L1]** or **[L2]** for the party with which you want to continue talking. To resume both lines, press **[CONF]**.

Conference call with an outside call and an intercom call

While you are talking with an outside caller, one more extension can join the conversation and establish a conference call.

- 1 During an outside call, press **[MENU]** to put the call on hold.
- 2 **[↕]**: "Intercom" → **[SELECT]**
- 3 **[↕]**: Select the desired unit. → **[SELECT]**
- 4 When the paged party answers, press **[MENU]**. → **[↕]**: "Conference" → **[SELECT]**
 - If the paged party does not answer, press **[BACK]** to return to the outside call.
 - The 2 calls are combined.
 - To leave the conference, press **[OFF]**. The other 2 parties can continue the conversation.

Note:

- The outside call can be put on hold by press **[MENU]**. → **[↕]**: "Hold" → **[SELECT]**. Only the person who placed the call on hold can resume the full conference by press **[MENU]**. → **[↕]**: "Conference" → **[SELECT]**.

Transferring a cellular call between the handset and a cellular phone

Transferring a cellular call from the handset to a cellular phone

- 1 Press **[MENU]** during a cellular call.
- 2 **[↕]**: "Transfer to cell" → **[SELECT]**
 - The cellular call is transferred to the cellular phone.

Note:

- Depending on your cellular phone type, you may need to set the cellular phone to be ready to talk before transferring. For example, if your cellular phone has a top cover, open it beforehand.
- You can also transferring a cellular call as follows:
Press and hold **[CELL]**.

Transferring a cellular call from a cellular phone to the handset

During a conversation using a cellular phone, the call cannot be transferred to the handset by the cellular phone. Perform the following with the handset.

- 1 During a conversation using a cellular phone, press **[CELL]**.
 - The call is transferred to the handset when:
 - only 1 cellular phone is paired.
 - a specific line is set to make cellular calls (page 20).
- 2 **[↕]**: Select the desired cellular phone. → **[SELECT]**
 - The call is transferred to the handset.

Using the other line during a conversation

You can handle a cellular call and a landline call at the same time. When another call is being received during a conversation, the interrupt tone sounds (page 40), and the 2nd caller's information is displayed if you subscribe to Caller ID (page 47). You can answer the 2nd call while holding the 1st call.

Making/answering a cellular call during a conversation on the landline

- 1 Press **[MENU]** during a landline call.
- 2 **[↕]**: "Hold" → **[SELECT]**
- 3 **To make a 2nd call:**
Dial the phone number. → **[CELL]*1** → **[↕]**:
Select the desired cellular phone. → **[SELECT]**
 - *1 The unit starts dialing when:
 - only 1 cellular phone is paired.
 - a specific line is set to make cellular calls (page 20).

To answer a 2nd call: **[CELL]**

- To hold the 2nd call: **[MENU]** → **[↕]**: "Hold" → **[SELECT]**
- 4 To hang up the 2nd call and return to the 1st call (landline call), press **[OFF]**, then press **[L1]** or **[L2]**.

Making/answering a landline call during a conversation on a cellular line

- 1 Press **[MENU]** during a cellular call.

- 2 **[↕]:** “H01d” → **[SELECT]**
- 3 **To make a 2nd call:**
Dial the phone number. → **[↩]**
To answer a 2nd call:
[↩]
 - To hold the 2nd call: **[MENU]** → **[↕]:**
“H01d” → **[SELECT]**
- 4 To hang up the 2nd call and return to the 1st call (cellular call), press **[OFF]**, then press **[CELL]**.

Using the other line during a landline call

You can use the other line in the following ways:

- When a call is being received on the other line during a conversation, an interrupt tone will be heard (page 40). You can answer the 2nd call while holding the 1st call.
- During an outside call, you can also make a call using the other line by holding the 1st call.

Example: If you are using line 1:

- 1 Press **[MENU]**. → **[↕]:** “H01d” → **[SELECT]** to put the 1st call (line 1) on hold.
- 2 Press **[L2]** to make or answer a 2nd call.
 - To hold the 2nd call: **[MENU]** → **[↕]:**
“H01d” → **[SELECT]**
- 3 To return to the 1st call (line 1), press **[L1]**.

Note:

- If you subscribe to Caller ID, the 2nd caller's information is displayed when a call is being received on the other line (page 47).

Making cellular calls

Important:

- Only 1 cellular line can be used at a time.
- Before making calls, confirm that corresponding CELL indicator lights up (page 15).

- 1 Dial the phone number.
- 2 Press the desired cellular line key ([CELL 1] to [CELL 4]).
- 3 When the other party answers, speak into the microphone.
- 4 When you finish talking, press [END].

Note:

- While on a call, you can switch from the base unit to the handset:
With the call sharing mode on (page 28), press [CELL] on the handset. → [↕]: Select the desired cellular phone. → [SELECT] → Press [END] on the base unit.
– When only 1 cellular phone is paired or the line is set to make cellular calls (page 20), press [CELL] on the handset, then press [END] on the base unit.
If the handset is on the base unit, simply lift it.

Adjusting the speaker volume

Press [▲] or [▼] repeatedly while talking.

Making a cellular call using the redial list

The last 10 phone numbers dialed are stored in the redial list (each 48 digits max.).

- 1 [REDIAL]
- 2 [↕]: Select the desired phone number.
- 3 Press the desired cellular line key ([CELL 1] to [CELL 4]).

Making landline calls

- 1 Dial the phone number.
- 2 [END]
 - An available line is automatically selected and either the LINE 1 indicator or LINE 2 indicator lights up. To change the line selection mode, see page 16.
 - You can also select the line manually by pressing [LINE 1] or [LINE 2].

- 3 When the other party answers, speak into the microphone.

- 4 When you finish talking, press [END].

Note:

- While on a call, you can switch from the base unit to the handset:
 - Press [↶] on the handset, then press [END] on the base unit with the call sharing mode on (page 28).
 - If the handset is on the base unit, simply lift it.

Making a call using the redial list

The last 10 phone numbers dialed are stored in the redial list (each 48 digits max.).

- 1 [REDIAL]
- 2 [↕]: Select the desired phone number.
- 3 [END]

Erasing a number in the redial list

- 1 [REDIAL]
- 2 [↕]: Select the desired phone number. → [ERASE]
- 3 [↕]: “Yes” → [SELECT]
- 4 [EXIT]

Pause (for PBX/long distance service users)

A pause is sometimes required when making calls using a PBX or long distance service. When storing a calling card access number and/or PIN in the phonebook, a pause is also needed (page 34).

Example: If you need to dial the line access number “9” when making outside calls with a PBX:

- 1 [9] → [PAUSE]
- 2 Dial the phone number. → [END]

Note:

- A 3.5 second pause is inserted each time [PAUSE] is pressed.

Answering calls

- 1 Press [END] when the unit rings.
 - You can also answer the cellular call by pressing the desired cellular line key ([CELL 1] to [CELL 4]).

- The called landline is automatically selected. To change the line selection mode, see page 16.
- You can also answer the landline call by pressing **[LINE 1]** or **[LINE 2]**.

2 Speak into the microphone.

3 When you finish talking, press **[END]**.

Temporary ringer off: You can turn the ringer off temporarily by pressing **[MUTE]**.

Adjusting the base unit ringer volume

Press **[▲]** or **[▼]** repeatedly to select the desired volume.

Useful features during a call

Hold

- 1** Press **[HOLD]** during an outside call.
 - During the hold, the caller will hear music. For canceling music, see page 42.
 - After holding for 10 minutes, the call is disconnected.
- 2 To release hold on the cellular line:**

To select the desired cellular line key (**[CELL 1]** to **[CELL 4]**).

 - A handset user can take the call: **[CELL]*1** → **[SELECT]**

*1 The call is taken when:

 - only 1 cellular phone is paired.
 - a specific line is set to make cellular calls (page 20).

To release hold on the landline:
Press **[LINE 1]** or **[LINE 2]**.

Note:

- While a landline call is on hold, the corresponding line indicators flash.
-

Mute

- 1** Press **[MUTE]** during a call.
- 2** To return to the call, press **[MUTE]**.

Note:

- **[MUTE]** is a soft key visible on the display during a call.
-

Flash for landline calls

[FLASH] allows you to use the special features of your host PBX such as transferring an extension call, or accessing optional telephone services.

Note:

- To change the flash time, see page 42.
-

For call waiting or Call Waiting Caller ID service users

To use call waiting or Call Waiting Caller ID, you must first subscribe with your service provider/telephone company.

This feature allows you to receive calls while you are already talking on the phone. If you receive a call while on the phone, you will hear a call waiting tone.

If you subscribe to both Caller ID and Call Waiting with Caller ID services, the 2nd caller's information is displayed after you hear the call waiting tone on the base unit.

- 1** Press **[CALL WAIT]** to answer the 2nd call.
- 2** To switch between calls, press **[CALL WAIT]**.

Note:

- Please contact your service provider/telephone company for details and availability of this service in your area.
-

Temporary tone dialing for landline calls (for rotary/pulse service users)

Press **[TONE]** before entering access numbers which require tone dialing.

Call share

You can join an existing outside call.

To select the line that is being used for the call:

- for a cellular line press the desired cellular line key (**[CELL 1]** to **[CELL 4]**).
- for the landline press **[LINE 1]** or **[LINE 2]**.

Note:

- A maximum of 3 parties (including 1 outside party) can join a conversation using 2 extensions. (**3-way conference**)
 - To prevent other users from joining your conversations with outside callers, turn call sharing mode off (page 42).
-

Transferring calls

Outside calls can be transferred between 2 people.

- 1 During an outside call, press **[INTERCOM]**.
When 2 or more handsets are registered:
 - To page a specific handset, enter the handset number.
 - To page all handsets, press **[0]** or wait for a few seconds.
- 2 Wait for the paged party to answer.
 - If paged party does not answer, press **[INTERCOM]** to return to the outside call.
- 3 Press **[⏏]**.

Conference landline calls

3 people can establish a conference call.

Conference call with 2 outside calls

While you are talking with an outside caller, you can make or answer a 2nd call on the other line, and then combine the calls to establish a conference call.

- 1 During an outside call, press **[HOLD]**.
- 2 **To make a 2nd call:**
 Press **[LINE 1]** or **[LINE 2]**, then dial the phone number.
To answer a 2nd call:
 Press **[LINE 1]** or **[LINE 2]**.
- 3 When the 2nd call is connected, press **[MENU]** → **[↕]**: “Conference” → **[SELECT]**
 - The 2 calls are combined.
 - To hang up only one line, press **[LINE 1]** or **[LINE 2]** for the party with which you want to continue talking.
 - To put both lines on hold, press **[HOLD]**.
 To talk with only one caller, press **[LINE 1]** or **[LINE 2]** for the party with which you want to continue talking. To resume both lines, press **[CONF]**.

Conference call with an outside call and an intercom call

While you are talking with an outside caller, one more extension can join the conversation and establish a conference call.

- 1 During an outside call, press **[INTERCOM]**.
When 2 or more handsets are registered:
 - To page a specific handset, enter the handset number.

- To page all handsets, press **[0]** or wait for a few seconds.

- 2 When the paged party answers, press **[CONF]**.
 - The 2 calls are combined.
 - To leave the conference, press **[⏏]**. The other 2 parties can continue the conversation.

Note:

- The outside call can be put on hold by pressing **[HOLD]**. Only the person who placed the call on hold can resume the full conference by pressing **[CONF]**.

Transferring a cellular call between the base unit and a cellular phone

Transferring a cellular call from the base unit to a cellular phone

During a cellular call, press and hold the desired cellular line key (**[CELL 1]** to **[CELL 4]**) until the SP-PHONE indicator goes out.

- The cellular call is transferred to the cellular phone.

Transferring a cellular call from a cellular phone to the base unit

During a conversation using a cellular phone, press the desired cellular line key (**[CELL 1]** to **[CELL 4]**).

- The cellular call is transferred to the base unit.

Using the other line during a conversation

You can handle a cellular call and a landline call at the same time. When another call is being received during a conversation, the interrupt tone sounds (page 40). You can answer the 2nd call while holding the 1st call.

Making/answering a cellular call during a conversation on the landline

- 1 Press **[HOLD]** during a landline call.
- 2 **To make a 2nd call:**
 Dial the phone number. → Press the desired cellular line key (**[CELL 1]** to **[CELL 4]**).
To answer a 2nd call:
 Press the desired cellular line key (**[CELL 1]** to **[CELL 4]**).

- To hold the 2nd call, press **[HOLD]**.
- 3** To hang up the 2nd call and return to the 1st call (landline call), press the corresponding line key (**[LINE 1]** or **[LINE 2]**).

Making/answering a landline call during a conversation on a cellular line

- 1** Press **[HOLD]** during a cellular call.
- 2 To make a 2nd call:**
Dial the phone number. → **[☎]**
To answer a 2nd call:
[☎]
 - To hold the 2nd call, press **[HOLD]**.
- 3** To hang up the 2nd call and return to the 1st call (cellular call), press **[☎]**, then press the desired cellular line key (**[CELL 1]** to **[CELL 4]**).

Using the other line during a landline call

You can use the other line in the following ways:

- When a call is being received on the other line during a conversation, an interrupt tone will be heard (page 40). You can answer the 2nd call while holding the 1st call.
- During an outside call, you can also make a call using the other line by holding the 1st call.

Example: If you are using line 1:

- 1** Press **[HOLD]** to put the 1st call (line 1) on hold.
- 2** Press **[LINE 2]** to make or answer a 2nd call.
 - To hold the 2nd call, press **[HOLD]**.
- 3** To return to the 1st call (line 1), press **[LINE 1]**.

Intercom

Intercom calls can be made:

- between handsets
- between a handset and the base unit

Note:

- When paging unit(s), the paged unit(s) beeps for 1 minute.
- If you receive an outside call while talking on the intercom, you hear 2 tones.
 - To answer the call with the handset, press **[OFF]**, then press the corresponding line key.
 - To answer the call with the base unit, press **[📞]**, then press the corresponding line key.

Note:

- The ringer volume for intercom calls follows the higher volume level of the 2 lines (page 40).

Making an intercom call

Handset

- 1 **[INT]***1
or
[MENU] → **[📞]**: “Intercom” → **[SELECT]**
- 2 **[📞]**: Select the desired unit. → **[SELECT]**
- 3 When you finish talking, press **[OFF]**.

*1 If there is a new message in the answering system, **[INT]** is not displayed.

Base unit

- 1 Press **[INTERCOM]**.
When 2 or more handsets are registered:
 - To page a specific handset, enter the handset number.
 - To page all handsets, press **[0]** or wait for a few seconds.
- 2 When you finish talking, press **[INTERCOM]**.

Answering an intercom call

Handset

- 1 Press **[📞]** to answer the page.
- 2 When you finish talking, press **[OFF]**.

Base unit

- 1 Press **[INTERCOM]** to answer the page.
- 2 When you finish talking, press **[INTERCOM]**.

Phonebook

You can add 3,000 names (16 characters max.) and phone numbers (24 digits max.) to the phonebook, and assign each phonebook entry to the desired group (“Home”, “Cell 1” to “Cell 4”).

Important:

- All entries can be shared by the base unit and any registered handset.
- You can copy phonebook entries from a Bluetooth cellular phone to the unit’s phonebook (page 50).

Adding entries

Handset / Base unit

- 1 Proceed with the operation for your unit.
Handset: [◀] ☞ → [MENU]
Base unit: [☞] → [MENU]
- 2 [↕]: “Add new entry” → [SELECT]
- 3 Enter the party’s name. → [OK]
- 4 Enter the party’s phone number. → [OK]
- 5 [↕]: Select the desired group. → [SELECT] 2 times
- 6 Proceed with the operation for your unit.
Handset: [OFF]
Base unit: [EXIT]

Character table for entering names

While entering characters, you can switch between uppercase and lowercase by pressing ☒ (A→a).

Key	Character
[1]	& ' () * , - . / 1
[2]	A B C 2 a b c 2
[3]	D E F 3 d e f 3
[4]	G H I 4 g h i 4
[5]	J K L 5 j k l 5

Key	Character
[6]	M N O 6 m n o 6
[7]	P Q R S 7 p q r s 7
[8]	T U V 8 t u v 8
[9]	W X Y Z 9 w x y z 9
[0]	_ 0
[#]	#

- To enter another character that is located on the same dial key:
Handset: Press [▶] to move the cursor to the next space.
Base unit: Press [▶▶] to move the cursor to the next space.
- If you do not press any dial key within 5 seconds after entering a character, the character is fixed and the cursor moves to the next space.
- _ in the above table represents a single space.

Erasing the character or number

- Handset:** Press [◀] or [▶]. → [CLEAR]
Base unit: Press [◀◀] or [▶▶]. → [CLEAR]
- Press and hold [CLEAR] to erase all characters or numbers.

Storing a redial list number to the phonebook

Phone numbers of up to 24 digits can be stored in the phonebook.

Handset / Base unit

- 1 Proceed with the operation for your unit.
Handset: [▶] REDIAL
Base unit: [REDIAL]
- 2 [↕]: Select the desired phone number. → [SAVE]
- 3 To store the name, continue from step 3, “Editing entries”, page 34.

Storing caller information to the phonebook

Handset

- 1 [▼] CID

- 2 **[↕]**: Select the desired entry.
 - To edit the number: **[MENU]** → **[↕]**:
 “Edit” → **[SELECT]**
 Press **[EDIT]** repeatedly until the phone number is shown in the desired format. And then, press **[SAVE]**. Go to step 5.
- 3 **[MENU]**
- 4 **[↕]**: “Save CID” → **[SELECT]**
- 5 **[↕]**: “Phonebook” → **[SELECT]**
- 6 Continue from step 3, “Editing entries”, page 34.

Base unit

- 1 **[CID]**
- 2 **[↕]**: Select the desired entry.
 - To edit the number, press **[EDIT]** repeatedly until the phone number is shown in the desired format.
- 3 **[SAVE]**
- 4 **[↕]**: “Phonebook” → **[SELECT]**
- 5 Continue from step 3, “Editing entries”, page 34.

Groups

Groups can help you find entries in the phonebook quickly and easily. You can search for phonebook entries by group. The group ringer tone feature is available for Caller ID subscribers (page 33).

Setting ringer ID

Handset

- 1 **[←] ☞** → **[MENU]**
- 2 **[↕]**: “Group” → **[SELECT]**
- 3 **[↕]**: Select the desired group. → **[SELECT]**
- 4 **[↕]**: Select the desired ringer tone. → **[SAVE]**
- 5 **[OFF]**

Finding and calling from a phonebook entry

Once you have found the desired entry using one of the following 4 methods, make a call with your unit.

- **Using a cellular line:**

Handset

- 1 **[CELL]**
 - The unit starts dialing when:
 - only 1 cellular phone is paired.
 - a specific line is set to make cellular calls (page 20).
- 2 **[↕]**: Select the desired cellular phone. → **[SELECT]**

Base unit

Press the desired CELL buttons (**[CELL 1]** to **[CELL 4]**).

- **Using the landline:**

Handset

- [↶]**
- You can also make a call by pressing **[L1]** or **[L2]**.

Base unit

- [☞]**
- You can also make a call by pressing **[LINE 1]** or **[LINE 2]**.

Scrolling through all entries

Handset / Base unit

- 1 Proceed with the operation for your unit.
Handset: **[←] ☞**
Base unit: **[☞]**
- 2 **[↕]**: Select the desired entry.

Searching by first character

Handset / Base unit

- 1 Proceed with the operation for your unit.
Handset: **[←] ☞**
Base unit: **[☞]**
- 2 Press the dial key (**[0]** – **[9]** or **[#]**) which contains the character you are searching for (page 32).
- 3 **[↕]**: Scroll through the phonebook if necessary.

Searching by query

You can narrow down the search to enter the first characters of a name.

Handset / Base unit

- 1 Proceed with the operation for your unit.
Handset: **[←] ☞** → **[☒]**

Base unit: [📖] → [✖]

- To search for the name, enter the first characters (up to 4) in uppercase (page 32).
 - Characters cannot be entered in lowercase.
 - If there is no entry corresponding to the characters you selected, the next entry is displayed.
- [OK]
- [↕]: Scroll through the phonebook if necessary.

Searching by group

Handset / Base unit

- Proceed with the operation for your unit.
Handset: [←] 📖
Base unit: [📖]
- [GROUP]
- [↕]: Select the group you want to search. → [SELECT]
 - If you select "A11", the unit ends the group search.
- [↕]: Select the desired entry.

Editing entries

Handset

- Find the desired entry (page 33).
- [MENU] → [↕]: "Edit" → [SELECT]
- Edit the name if necessary. → [OK]
- Edit the phone number if necessary. → [OK]
- [↕]: Select the desired group (page 33). → [SELECT] 2 times
- [OFF]

Base unit

- Find the desired entry (page 33).
- [EDIT]
- Edit the name if necessary. → [OK]
- Edit the phone number if necessary. → [OK]
- [↕]: Select the desired group (page 33). → [SELECT] 2 times
- [EXIT]

Erasing entries

Erasing an entry

Handset

- Find the desired entry (page 33).
- [MENU] → [↕]: "Erase" → [SELECT]
- [↕]: "Yes" → [SELECT]
- [OFF]

Base unit

- Find the desired entry (page 33).
- [ERASE] → [↕]: "Yes" → [SELECT]
- [EXIT]

Erasing all entries in a group

Handset / Base unit

- Proceed with the operation for your unit.
Handset: [←] 📖 → [MENU]
Base unit: [📖] → [MENU]
- [↕]: "Erase all" → [SELECT]
- [↕]: Select the desired group. → [SELECT]
- [↕]: "Yes" → [SELECT]
- [↕]: "Yes" → [SELECT]
- Proceed with the operation for your unit.
Handset: [OFF]
Base unit: [EXIT]

Chain dial

This feature allows you to dial phone numbers in the phonebook while you are on a call. This feature can be used, for example, to dial a calling card access number or bank account PIN that you have stored in the phonebook, without having to dial manually.

Handset / Base unit

- Proceed with the operation for your unit.
During an outside call:
Handset: [←] 📖
Base unit: [📖]
- [↕]: Select the desired entry.
- Press [CALL] to dial the number.

Note:

- When storing a calling card access number and your PIN in the phonebook as one phonebook

entry, press **[▲]** (Pause) to add pauses after the number and PIN as necessary (page 22).

- If you have rotary/pulse service, you need to press **[✕]** (TONE) before pressing **[MENU]** on the handset or **[☞]** on the base unit in step 1 to change the dialing mode temporarily to tone. When adding entries to the phonebook, we recommend adding **[✕]** (TONE) to the beginning of phone numbers you wish to chain dial (page 32).

Speed dial

You can store phone numbers to the base unit and handset separately:

- Handset: up to 10 entries.
- Base unit: up to 20 entries.

Adding phone numbers to speed dial keys

Handset

You can assign 1 phone number to each of the dial keys (**[1]** to **[0]**).

■ By entering phone numbers:

- 1 Press and hold the desired speed dial key (**[1]** to **[0]**). → **[ADD]**
- 2 **[↕]**: “Manual” → **[SELECT]**
- 3 Enter the party's name (16 characters max.). → **[OK]**
- 4 Enter the party's phone number (24 digits max.). → **[OK]**
- 5 **[SELECT]** → **[OFF]**

■ From the phonebook:

- 1 Press and hold the desired speed dial key (**[1]** to **[0]**). → **[ADD]**
- 2 **[↕]**: “Phonebook” → **[SELECT]**
- 3 **[↕]**: Select the desired entry.
- 4 **[SAVE]** → **[OFF]**

Base unit

■ By entering phone numbers:

- 1 **[SPEED DIAL]**
- 2 **[↕]**: Select the desired speed dial key. → **[EDIT]**

- 3 Enter the party's name (16 characters max.). → **[OK]**
- 4 Enter the party's phone number (24 digits max.). → **[OK]**
- 5 **[SELECT]** → **[EXIT]**

■ From the phonebook:

- 1 **[SPEED DIAL]**
- 2 **[↕]**: Select the desired speed dial key. → **[☞]**
- 3 **[↕]**: Select the desired entry.
- 4 **[SAVE]** → **[EXIT]**

Note for handset and base unit:

- If you edit a phonebook entry which is assigned to a speed dial key, the edited entry does not transfer to the speed dial key.

Note for base unit:

- You can also select the desired entry as follows for **[1]** to **[0]**:
Press and hold the desired speed dial key (**[1]** to **[0]**).
- You can also select the desired entry as follows:
Press **[SPEED DIAL]** and the desired speed dial number (1 to 20).

Editing an entry

Handset

- 1 Press and hold the desired speed dial key (**[1]** to **[0]**). → **[MENU]**
- 2 **[↕]**: “Edit” → **[SELECT]**
- 3 Edit the name if necessary. → **[OK]**
- 4 Edit the phone number if necessary. → **[OK]**
- 5 **[SELECT]** → **[OFF]**

Base unit

- 1 **[SPEED DIAL]**
- 2 **[↕]**: Select the desired entry. → **[DETAIL]**
- 3 **[EDIT]**
- 4 Edit the name if necessary. → **[OK]**
- 5 Edit the phone number if necessary. → **[OK]**
- 6 **[SELECT]** → **[EXIT]**

Erasing an entry

Handset

- 1 Press and hold the desired speed dial key ([1] to [0]). → [MENU]
- 2 [↕]: “Erase” → [SELECT]
- 3 [↕]: “Yes” → [SELECT]
- 4 [OFF]

Base unit

- 1 [SPEED DIAL]
- 2 [↕]: Select the desired entry. → [DETAIL]
- 3 [ERASE]
- 4 [↕]: “Yes” → [SELECT]
- 5 [EXIT]

Viewing an entry/Making a call

Handset

■ Using a cellular line:

- 1 Press and hold the desired speed dial key ([1] to [0]).
- 2 [CELL]
 - The unit starts dialing when:
 - only 1 cellular phone is paired.
 - a specific line is set to make cellular calls (page 20).
- 3 [↕]: Select the desired cellular phone. → [SELECT]

■ Using the landline:

- 1 Press and hold the desired speed dial key ([1] to [0]).
- 2 Press [L1] or [L2].

Base unit

- 1 [SPEED DIAL]
- 2 [↕]: Select the desired entry.
- 3 Press the desired line key.

Menu list

To access the features, there are 2 methods.

Handset / Base unit





■ Scrolling through the display menus

- 1 [MENU]
- 2 Press [▼] or [▲] to select the desired main menu. → [SELECT]
- 3 Press [▼] or [▲] to select the desired item from the next sub-menus. → [SELECT]
- 4 Press [▼] or [▲] to select the desired setting. → [SAVE]

■ Using the direct command code



- 1 [MENU] → Enter the desired code.
Example: Press [MENU][#][1][0][1].
- 2 Select the desired setting. → [SAVE]

Note:

- The unit column shows the unit(s) that can be used to program the item.
 - : Only the handset can program the item.
 - : Only the base unit can program the item.
 - : Both the handset and base unit can program the item.
- To exit the operation, press [OFF] on the handset or [EXIT] on the base unit.
- In the following table, < > indicates the default settings.
- In the following table,  indicates the reference page number.
- Display menu order and sub-menu may vary depending on your model.



Display menu tree and direct command code table





Main menu:  “Phonebook”



























Operation	Code	Unit	
Viewing the phonebook entry.	#280		33

Main menu:  “Caller list”



Operation	Code	Unit	
Viewing the caller list.	#213		47

Main menu:  (for handset)/ (for base unit) “Answering device” → : “Line1” or “Line2”



















Sub-menu 1	Sub-menu 2	Settings	Code	Unit	
Play new message	-	-	#3231* ¹		56
			#3232* ²		
Play all message	-	-	#3241* ¹		56
			#3242* ²		
Erase all message* ³	-	-	#3251* ¹		57
			#3252* ²		

Sub-menu 1	Sub-menu 2	Settings	Code	Unit	
Greeting	Select greeting* ³	<Greeting1> Greeting2 Greeting1&2 Greeting1&Only Greeting only	#3421* ¹	 	54
			#3422* ²		
	Record greeting* ³ – Greeting1 – Greeting2 – Greeting only	–	#3021* ¹	 	55
			#3022* ²		
	Check greeting – Greeting1 – Greeting2 – Greeting only	–	#3031* ¹	 	56
#3032* ²					
Pre-recorded* ³ (Reset to pre-recorded greeting) – Greeting1 – Greeting2 – Greeting only	–	#3041* ¹	 	55	
		#3042* ²			
New message alert* ³	By calling – On/Off	1: On 0: <Off>	#3381* ¹	 	57
			#3382* ²		
	By calling – Alert to	–	#3381* ¹	 	
			#3382* ²		
	By calling – Remote code	1: Activate 0: <Inactivate>	#3381* ¹	 	
#3382* ²					
Base unit beep	1: On 0: <Off>	#3391* ¹	 	57	
		#3392* ²			
Settings	Ring count* ³	2-7: 2-7 rings <4 rings> 0: Toll saver	#2111* ¹	 	60
			#2112* ²		
	Recording time* ³	1: 1 min 3: <3 min>	#3051* ¹	 	61
			#3052* ²		
	Remote code* ³	<111>	#3061* ¹	 	59
			#3062* ²		
	Screen call	1: <On> 0: Off	#3101* ¹	 	54
			#3102* ²		
Answer on* ³	–	–	#3271* ¹		54
			#3272* ²		
Answer off* ³	–	–	#3281* ¹		54
			#3282* ²		

Main menu:  "Intercom"

Operation	Code	Unit	
Paging the desired unit.	#274		31

Main menu:  "Bluetooth"

Sub-menu 1	Sub-menu 2	Settings	Code	Unit	
Link to cell – 1: Add new device ^{*4} (for CELL 1) – 2: Add new device ^{*4} (for CELL 2) – 3: Add new device ^{*4} (for CELL 3) – 4: Add new device ^{*4} (for CELL 4)	Connect ^{*3} / Disconnect ^{*3}	–	#6251 ^{*5}	 	28
		#6252 ^{*6}			
		#6253 ^{*7}			
		#6254 ^{*8}			
	Ringer volume	Handset: 0-6: Off-6 <6> Base unit: 0-6: Off-6 <1>	#6281 ^{*5}	 	23
			#6282 ^{*6}		
			#6283 ^{*7}		
			#6284 ^{*8}		
	Ringer tone ^{*10}	<Tone 4>	#6291 ^{*5}		–
			#6292 ^{*6}		
			#6293 ^{*7}		
			#6294 ^{*8}		
	Select unit to ring ^{*3}	1-6: Handset 1-6 *: <All>	#6271 ^{*5}	 	19
			#6272 ^{*6}		
			#6273 ^{*7}		
			#6274 ^{*8}		
	Ring as cell (limited) ^{*3}	1: <On (with Talking CID)> 2: On (without Talking CID) 0: Off	#6141 ^{*5}	 	19
			#6142 ^{*6}		
			#6143 ^{*7}		
			#6144 ^{*8}		
	Text message alert ^{*3}	<On> Off	#6101 ^{*5}	 	51
			#6102 ^{*6}		
			#6103 ^{*7}		
	Pair	–	#6241 ^{*5}	 	18
#6242 ^{*6}					
#6243 ^{*7}					
#6244 ^{*8}					
Unpair	–	#6111 ^{*5}	 	18	
		#6112 ^{*6}			
		#6113 ^{*7}			
		#6114 ^{*8}			
Phonebook transfer	–	–	#618	 	50





































Sub-menu 1	Sub-menu 2	Settings	Code	Unit	
Headset	Add new device*4	–	#621		51
	Connect*3/ Disconnect*3	–	#622		52
	Pair	–	#621		51
	Unpair	–	#612		52
Settings	Auto connect*3	1: <1 min> 2: 3 min 3: 5 min 4: 10 min 0: Off	#632		19
	Cell area code*3	–	#633		20
	Cell line select	0: <Manual> 1: Cellphone 1*4 2: Cellphone 2*4 3: Cellphone 3*4 4: Cellphone 4*4	#634		20
	Set PIN*3	<0000>	#619		21

Main menu: “Set date & time”



























Sub-menu 1	Sub-menu 2	Settings	Code	Unit	
Date and time*3	–	–	#101		16
Alarm	–	1: Once 2: Daily 0: <Off>	#720		43
Time adjustment*3, *9	–	1: <Caller ID auto> 0: Manual	#226		–

Main menu: “Initial setting”



Sub-menu 1	Sub-menu 2	Settings	Code	Unit	
Ringer setting	Ringer volume – Line1 – Line2	Handset: 0-6: Off-6 <6> Base unit: 0-6: Off-6 <1>	#160		23
	Ringer tone*10, *11 – Line1 – Line2	<Tone 1>*1 <Tone 2>*2	#161		–
	Interrupt tone*12	1: <On> 0: Off	#201		25
	Silent mode – On/Off	1: On 0: <Off>	#238		44
	Silent mode – Start/End	<11:00 PM/06:00 AM>	#237		44

Sub-menu 1	Sub-menu 2	Settings	Code	Unit	👍	
Set date & time	Date and time* ³	–	#101	 	16	
	Alarm	1: Once 2: Daily 0: <Off>	#720		43	
	Time adjustment* ³ , * ⁹	1: <Caller ID auto> 0: Manual	#226	 	–	
Talking Caller ID	–	Handset: 1: <On> 0: Off Base unit: 1: On 0: <Off>	#162	 	47	
Handset name	–	–	#104		46	
Key detector setting* ¹³ – 1: Add new device (for Detector 1)* ¹⁴ – 2: Add new device (for Detector 2) – 3: Add new device (for Detector 3) – 4: Add new device (for Detector 4)	Change name* ³	Detector1	#6561		–	
		Detector2* ¹⁵	#6562* ¹⁶			
		Detector3* ¹⁵	#6563* ¹⁶			
		Detector4* ¹⁵	#6564* ¹⁶			
	Registration	–	–	#6571		–
			–	#6572* ¹⁶		
			–	#6573* ¹⁶		
			–	#6574* ¹⁶		
	Deregistration	–	–	#6581		–
			–	#6582* ¹⁶		
			–	#6583* ¹⁶		
			–	#6584* ¹⁶		
Call block* ³	–	–	#217	 	44	
	First ring* ³	1: <On> 0: Off	#173	 	45	
	Block w/o num.* ³ , * ¹⁷ (Block calls without phone number)	1: On 0: <Off>	#240	 	45	
Speed dial	–	–	#261	 	35	
VM tone detect* ³ (VM: Voice mail)	–	1: <On> 0: Off	#332	 	62	
Phonebook setting* ³	International code	–	#117	 	50	
	Country code	–	#118	 		
	Trunk prefix	–	#119	 		



Programming

Sub-menu 1	Sub-menu 2	Settings	Code	Unit	
LCD contrast (Display contrast)	–	1-6: Level 1-6 <3>	#145	 	–
Key tone	–	1: <On> 0: Off	#165		–
Set music on hold*18	–	1: <On> 0: Off	#167	 	–
Caller ID edit (Caller ID number auto edit)	–	1: <On> 0: Off	#214	 	48
Auto talk*19	–	1: On 0: <Off>	#200		23
Line select (for landline)	–	0: <Auto> 1: Line1 2: Line2	#250	 	16
Set tel line	Set dial mode*3	1: Pulse 2: <Tone>	#120	 	16
	Set flash time*3,*20 – Line1 – Line2	0: 900 ms 1: <700 ms> 2: 600 ms 3: 400 ms 4: 300 ms 5: 250 ms *: 200 ms #: 160 ms 6: 110 ms 7: 100 ms 8: 90 ms 9: 80 ms	#121	 	23
	Set line mode*3,*21	1: A 2: 	#122	 	–
Call sharing*3	–	1: <On> 0: Off	#194	 	24, 28
Registration	Register handset	–	#130		46
	Deregistration*17	–	#131	 	46
Change language	Display	1: <English> 2: Español	#110	 	16
	Voice prompt*3	1: <English> 2: Español	#112	 	16

Main menu:  “Customer support”

Operation	Code	Unit	
Displaying customer support Web address.	#680	 	–

Main menu:  "Key detector"^{*13}

Sub-menu 1	Sub-menu 2	Settings	Code	Unit	
Search	—	—	#655		—
Battery check	—	—			

- *1 For Line 1
- *2 For Line 2
- *3 If you program these settings using one of the units, you do not need to program the same item using another unit.
- *4 After the Bluetooth device is paired, the device name is displayed.
- *5 For CELL 1
- *6 For CELL 2
- *7 For CELL 3
- *8 For CELL 4
- *9 This feature allows the unit to automatically adjust the date and time each time caller information including date and time is received.
To turn this feature on, select "Caller ID auto". To turn this feature off, select "Manual". (Caller ID subscribers only)
To use this feature, set the date and time first (page 16).
- *10 The preset melodies in this product are used with permission of © 2007 Copyrights Vision Inc.
- *11 If you subscribe to a distinctive ring service (such as IDENTA-RING), select a tone (tone 1 to 5). If you select a melody, you cannot distinguish lines by their ringers.
- *12 This tone lets you know when you receive an outside call while you are on another line or an intercom call. If you select "On", the tone sounds 2 times.
- *13 This setting is available when you have the key detector (KX-TGA20). Read the installation guide for more information on the key detector.
- *14 For models with supplied key detectors, the display shows "1: Detector1".
- *15 If you register 2 or more key detectors.
- *16 If you have 2 or more key detectors.
- *17 This menu is not displayed when scrolling through the display menus. It is only available in direct command code.
- *18 You can set music play during the hold. The preset melody in this product is used with permission of © 2006 Copyrights Vision Inc.
- *19 If you subscribe to a Caller ID service and want to view the caller's information after lifting up the handset to answer a call, turn off this feature.
- *20 The flash time depends on your telephone exchange or host PBX. Contact your PBX supplier if necessary. The setting should stay at "700 ms" unless pressing [FLASH] fails to pick up the waiting call.
- *21 Generally, the line mode setting should not be changed. If the LINE 1 indicator or LINE 2 indicator does not light when another phone connected to the same line is in use, you need to change the line mode to "A".

Alarm

An alarm sounds at the set time for 3 minutes once or daily. Alarm can be set for each handset.

Important:

- Make sure the unit's date and time setting is correct (page 16).

Handset

- 1 [MENU]#720
- 2 [↓]: Select the desired alarm option. →
[SELECT]

"OFF"	Turns alarm off. Go to step 7.
"Once"	An alarm sounds once at the set time.

"Daily"	An alarm sounds daily at the set time. Go to step 4.
---------	--

- 3 Enter the desired month and date. → **[OK]**
- 4 Set the desired time.
- 5 **[X]**: Select "AM" or "PM". → **[OK]**
- 6 **[↓]**: Select the desired alarm tone. → **[SELECT]**
 - We recommend selecting a different ringer tone from the one used for outside calls.
- 7 **[SELECT]** → **[OFF]**

Note:

- To stop the alarm, press **[OFF]** or place the handset on the base unit or charger.
- When the handset is in use, the alarm will not sound until the handset is in standby mode.

Silent mode

Silent mode allows you to select a period of time during which the handset and/or base unit will not ring for outside calls. This feature is useful for time periods when you do not want to be disturbed, for example, while sleeping. Silent mode can be set for each unit.

Important:

- Make sure the unit's date and time setting is correct (page 16).
- If you have set the alarm, the alarm sounds even if the silent mode is turned on.

Turning silent mode on/off

Handset

- 1 **[MENU]** **#** **2** **3** **8**
- 2 **[↓]**: Select the desired setting. → **[SAVE]**
 - If you select "OFF", press **[OFF]** to exit.
- 3 Enter the desired hour and minute you wish to start this feature.
- 4 **[X]**: Select "AM" or "PM". → **[OK]**
- 5 Enter the desired hour and minute you wish to end this feature.
- 6 **[X]**: Select "AM" or "PM".
- 7 **[SAVE]** → **[OFF]**

Base unit

- 1 **[MENU]** **#** **2** **3** **8**

- 2 **[↓]**: Select the desired setting. → **[SAVE]**
 - If you select "OFF", press **[EXIT]** to exit.
- 3 Enter the desired hour and minute you wish to start this feature.
- 4 **[AM/PM]**: Select "AM" or "PM". → **[OK]**
- 5 Enter the desired hour and minute you wish to end this feature.
- 6 **[AM/PM]**: Select "AM" or "PM".
- 7 **[SAVE]** → **[EXIT]**

Changing the start and end time

Handset / Base unit

- 1 **[MENU]** **#** **2** **3** **7**
- 2 Continue from step 3 for handset or step 3 for base unit, "Turning silent mode on/off", page 44.

Call block

This feature allows the unit to reject calls when:

- the unit receives a call from a phone number stored in the call block list as unwanted ("Storing unwanted callers", page 44).
- the unit receives a call without phone number ("Blocking incoming calls without phone number", page 45).

When a call is received, the unit rings for a short time*1 while the caller is being identified. If the phone number matches an entry in the call block list, the unit emits no sound to the caller, and disconnects the call. (Caller ID subscribers only)

*1 This is called first ring. If you do not want the first ring to sound, turn this setting to "OFF" (page 45).

Important:

- When the unit receives a call from a number that is stored in the call block list or a call without a recognized phone number, the call is logged in the caller list (page 47) with **↵** after the call is disconnected.
- You can program this setting using either the base unit or one of the handsets.

Storing unwanted callers

You can store up to 250 phone numbers in the call block list.

Important:

- We recommend storing 10 digits (including an area code). If only 7 digits are stored, all numbers that have the same last 7 digits will be blocked.

■ From the caller list:**Handset**

- 1 **[v]** CID
- 2 **[↕]**: Select the entry to be blocked.
 - To edit the number: **[MENU]** → **[↕]**: “Edit” → **[SELECT]**
Press **[EDIT]** repeatedly until the phone number is shown in the 10-digit format. And then, press **[SAVE]**. Go to step 5.

- 3 **[MENU]**
- 4 **[↕]**: “Save CID” → **[SELECT]**
- 5 **[↕]**: “Call block” → **[SELECT]**
- 6 **[↕]**: “Yes” → **[SELECT]**
- 7 Edit the phone number if necessary (24 digits max.).
- 8 **[SAVE]** → **[OFF]**

Base unit

- 1 **[CID]**
- 2 **[↕]**: Select the entry to be blocked.
 - To edit the number, press **[EDIT]** repeatedly until the phone number is shown in the 10-digit format.
- 3 **[SAVE]**
- 4 **[↕]**: “Call block” → **[SELECT]**
- 5 **[↕]**: “Yes” → **[SELECT]**
- 6 Edit the phone number if necessary (24 digits max.).
- 7 **[SAVE]** → **[EXIT]**

■ By entering phone numbers:**Handset**

- 1 **[MENU]** **#** **2** **1** **7**
- 2 **[MENU]** → **[↕]**: “Add” → **[SELECT]**
- 3 Enter the phone number (24 digits max.).
- 4 **[SAVE]** → **[OFF]**

Base unit

- 1 **[MENU]** **#** **2** **1** **7** → **[ADD]**
- 2 Enter the phone number (24 digits max.).

3 [SAVE] → [EXIT]**Blocking incoming calls without phone number**

You can reject a call when no phone number is provided, such as a call just showing “out of area”.

Handset / Base unit

- 1 **[MENU]** **#** **2** **4** **0**
- 2 **[↕]**: Select the desired setting. → **[SAVE]**
- 3 Proceed with the operation for your unit.
Handset: **[OFF]**
Base unit: **[EXIT]**

Note:

- When the unit receives a cellular call without a phone number, the call may not be rejected.

Setting the first ring for the call block list**Handset / Base unit**

If you do not want the first ring from a number on the call block list to sound, turn the first ring setting to “off”. The default setting is “on”.

- 1 **[MENU]** **#** **1** **7** **3**
- 2 **[↕]**: Select the desired setting. → **[SAVE]**
- 3 Proceed with the operation for your unit.
Handset: **[OFF]**
Base unit: **[EXIT]**

Viewing/editing/erasing call block numbers**Handset**

- 1 **[MENU]** **#** **2** **1** **7**
- 2 **[↕]**: Select the desired entry.
 - To exit, press **[OFF]**.
- 3 **To edit a number:**
[EDIT] → Edit the phone number. → **[SAVE]** → **[OFF]**
To erase a number:
[ERASE] → **[↕]**: “Yes” → **[SELECT]** → **[OFF]**

Base unit

- 1 **[MENU]** **#** **2** **1** **7**
- 2 **[↕]**: Select the desired entry.
 - To exit, press **[EXIT]**.
- 3 **To edit a number:**
[EDIT] → Edit the phone number. → **[SAVE]** → **[EXIT]**
To erase a number:

[ERASE] → [↕]: “Yes” → [SELECT] → [EXIT]

Note for handset and base unit:

- When viewing, “Block w/o num.”*1 / “Block w/o number”*2 is displayed if the blocking incoming calls without phone number feature is turned on. To turn the feature off: [ERASE] → [v] → [SAVE] → [OFF] (Handset) or [EXIT] (Base unit)

*1 Handset

*2 Base unit

Other programming

Changing the handset name

Each handset can be given a customized name (“Bob”, “Kitchen”, etc.). This is useful when you make intercom calls between handsets. You can also select whether or not the handset name is displayed in standby mode. The default setting is “No”. If you select “Yes” without entering any handset name, “Handset 1” to “Handset 6” is displayed.

Handset

- 1 [MENU]#104
- 2 Enter the desired name (max. 10 characters)
- 3 [SAVE]
- 4 [↕]: Select the desired setting. → [SELECT] 2 times → [OFF]

Registering a unit

Operating additional units

Additional handsets

Up to 6 handsets can be registered to the base unit.

Important:

- See page 4 for information on the available model.

Registering a handset to the base unit

The supplied handset and base unit are pre-registered. If for some reason the handset is not registered to the base unit, re-register the handset.

- 1 **Handset:**
[MENU]#130
- 2 **Base unit:**
Press and hold [LOCATOR] for about 5 seconds until the registration tone sounds.
 - If all registered handsets start ringing, press [LOCATOR] again to stop, then repeat this step.
- 3 **Handset:**
Press [OK], then wait until a long beep sounds.

Deregistering a handset

A handset can cancel its own registration to the base unit, or other handsets registered to the same base unit. This allows the handset to end its wireless connection with the system.

Handset / Base unit

- 1 [MENU]#131
 - All handsets registered to the base unit are displayed.
- 2 [↕]: Select the handset you want to cancel. → [SELECT]
- 3 [↕]: “Yes” → [SELECT]
- 4 Proceed with the operation for your unit.
Handset: [OFF]
Base unit: [EXIT]

Using Caller ID service

Important:

- This unit is Caller ID compatible. To use Caller ID features, you must subscribe to a Caller ID service. Contact your service provider/telephone company for details.

Caller ID features

Handset / Base unit

When an outside call is being received, the caller information is displayed.

Caller information for the last 50 callers is logged in the caller list from the most recent call to the oldest.

- If the unit cannot receive caller information, the following is displayed:
 - “**Out of area**”: The caller dials from an area which does not provide a Caller ID service.
 - “**Private caller**”: The caller requests not to send caller information.
 - “**Long distance**”: The caller makes a long distance call.
- If the unit is connected to a PBX system, caller information may not be properly received. Contact your PBX supplier.

Missed calls

Handset / Base unit

If a call is not answered, the unit treats it as a missed call. The display shows “**Missed call**”.

Note:

- Even when there are unviewed missed calls, “**Missed call**” disappears from the standby display if the following operation is performed by one of the units:
 - A handset is replaced on the base unit or charger.
 - Pressing [**OFF**] on a handset.
 - Pressing [**EXIT**] on the base unit.

Phonebook name display

When caller information is received and it matches a phone number stored in the phonebook, the stored name in the phonebook is displayed and logged in the caller list.

Talking Caller ID

Handset / Base unit

This feature lets you know who is calling without looking at the display.

To use this feature, you must:

- subscribe to a Caller ID service of your service provider/telephone company.
- turn this feature on (page 41).

When caller information is received, the handsets and base unit announce the caller's name or phone number received from your service provider/telephone company following every ring.

The unit announces in English only.

- Name pronunciation may vary. This feature may not pronounce all names correctly.
- Caller ID service has a limit of how many characters can be displayed. If the caller's name is too long, the unit may not be able to display or announce the entire name.

Phonebook name announcement

When caller information is received and it matches a phone number stored in the phonebook, the stored name in the phonebook is announced.

Caller list

Important:

- Make sure the unit's date and time setting is correct (page 16).

Viewing the caller list and calling back

■ Using a cellular line

Handset

- 1 [**▼**] CID
- 2 Press [**▼**] to search from the most recent call, or [**▲**] to search from the oldest call.
- 3 To call back, press [**CELL**].
 - The unit starts dialing when:
 - only 1 cellular phone is paired.
 - a specific line is set to make cellular calls (page 20).

To exit, press [**OFF**].
- 4 [**↕**]: Select the desired cellular phone. → [**SELECT**]

Base unit





- 1 [CID]
- 2 Press [▼] to search from the most recent call, or [▲] to search from the oldest call.
- 3 To call back, press the desired cellular line key ([CELL 1] to [CELL 4]).
To exit, press [EXIT].

■ Using the landline

Handset / Base unit

- 1 Proceed with the operation for your unit.
Handset: [▼] CID
Base unit: [CID]
- 2 Press [▼] to search from the most recent call, or [▲] to search from the oldest call.
- 3 Proceed with the operation for your unit.
Handset:
 - To call back, press the desired landline key ([L1] or [L2]).
 - To exit, press [OFF].**Base unit:**
 - To call back, press the desired landline key ([LINE 1] or [LINE 2]).
 - To exit, press [EXIT].

Note for handset and base unit:

- If the entry has already been viewed or answered, “✓” is displayed, even if it was viewed or answered using another unit.
-  to  indicates the caller information was received from the cellular line.
-  and  indicates the caller information was received from the landline.

Editing a caller's phone number

You can edit a phone number in the caller list by removing its area code and/or the long distance code “1”.

Handset

- 1 [▼] CID
- 2 [↕]: Select the desired entry.
- 3 [MENU] → [↕]: “Edit” → [SELECT]
- 4 Press [EDIT] repeatedly until the phone number is shown in the desired format.

5 Using a cellular line:

To make a cellular call, continue from step 3, “Viewing the caller list and calling back”, page 47.

Using the landline:

Press [L1] or [L2].

Base unit

- 1 [CID]
- 2 [↕]: Select the desired entry.
- 3 Press [EDIT] repeatedly until the phone number is shown in the desired format.
- 4 **Using a cellular line:**
To make a cellular call, continue from step 3, “Viewing the caller list and calling back”, page 47.
Using the landline:
Press [LINE 1] or [LINE 2].
 - If the indicated line is already being used or you want to select the other line:
Handset: Press [L1] or [L2].
Base unit: Press [LINE 1] or [LINE 2].

Caller ID number auto edit feature

Handset / Base unit

Once you call back an edited number, the unit which was used to call back remembers the area code and format of the edited number. The next time someone calls from the same area code, caller information is customized by the unit as follows:

- When the call is being received, the Caller ID number is displayed in the same format as the edited number.
- After the call has ended, the caller's phone number is displayed in the same format as the edited number, when reviewed from the caller list.

For example, you can use this feature to set the unit to ignore the area code of callers in your area, so that you can call these local numbers using caller information without dialing the area code.

To activate this feature, you must edit an entry in the caller list, then call that number. After that, phone numbers from that caller's area code are edited automatically.

This feature can be set for each unit (page 42). The default setting is “on”.

Note:

- Phone numbers from the 4 most recently edited area codes are automatically edited.

Erasing selected caller information

Handset / Base unit

- 1 Proceed with the operation for your unit.
Handset: [▼] CID
Base unit: [CID]
- 2 [↕]: Select the desired entry.
- 3 [ERASE] → [↕]: “Yes” → [SELECT]
- 4 Proceed with the operation for your unit.
Handset: [OFF]
Base unit: [EXIT]

Erasing all caller information

Handset / Base unit

- 1 Proceed with the operation for your unit.
Handset: [▼] CID
Base unit: [CID]
- 2 [ERASE] → [↕]: “Yes” → [SELECT]
- 3 Handset: [OFF]

Copying phonebook from a cellular phone (phonebook transfer)

You can copy phonebook entries from the paired cellular phones or other cellular phones (not paired) to the unit's phonebook. A cellular phone must be compatible with Bluetooth wireless technology.

Important:

- If a copied entry has 2 or more phone numbers, each phone number (6 max.) is stored as a separate entry with the same name.
- If a phonebook entry includes additional data such as a picture, that entry may fail to copy to the base unit.
- If your cellular phone includes international call entries, set the conversion codes before copying (page 50).

Handset / Base unit

1 **[MENU]** **#** **6** **1** **8**

2 **To copy from paired cellular phones:**

[↕]: Select the desired cellular phone. → **[SELECT]**

- Copied items are stored to the group ("Cell 1" to "Cell 4") which the cellular phone is paired to.

To copy from other cellular phones (not paired):

[↕]: "Other cell" → **[SELECT]** → **[↕]**:
Select the group you want to copy to. → **[SELECT]**

3 **When "Use the cell to transfer phonebook" is displayed:**

Go to step 4.

When "Select mode" menu is displayed:

[↕]: Select "Auto" or "Manual". → **[SELECT]**

"Auto": Download all entries from the cellular phone automatically. Go to step 5.

"Manual": Copy entries you selected.

- "Select mode" menu is displayed only when the cellular phone supports PBAP (Phone Book Access Profile) for Bluetooth connection.
- Some cellular phones may require you to perform an operation on the cellular phone even if you select "Auto".

4 **Cellular phone:**

Follow the instructions of your cellular phone to copy phonebook entries.

- For other cellular phones (not paired), you need to search for and select the base unit. The base unit PIN (default: "0000") may be required.
- The entries being copied are displayed on the handset.

5 Wait until "Completed" is displayed.

- You can continue copying other entries if necessary.

6 Proceed with the operation for your unit.

Handset: [OFF]

Base unit: [EXIT]

Note:

- Some copied entries may have characters which do not exist in the character table (page 32). These characters can be displayed but cannot be entered when editing an entry.
- The unit does not support some characters. If a copied entry includes those characters, they are replaced with other available characters or "*".
- If you receive a call while copying phonebook entries, the copying procedure stops. Try again after finishing the call.

Setting conversion codes

You must first set the following 3 dialing codes in the base unit which you want to copy to before transferring the phonebook from your cellular phone (each 4 digits max.).

- "International": An international prefix used when you make an international call.
- "Country code": Your country code for international calls.
- "Trunk prefix": A trunk prefix; the initial digit(s) to be dialed in a domestic call, prior to the area code.

Handset / Base unit

1 **[MENU]**

2 To store "International": **#** **1** **1** **7**

To store "Country code": **#** **1** **1** **8**

To store "Trunk prefix": **#** **1** **1** **9**

3 Enter the desired number. → **[SAVE]**

4 Proceed with the operation for your unit.

Handset: [OFF]

Base unit: [EXIT]

Note:

- After you copy the entries, confirm that the numbers were transferred correctly.

Text message (SMS) alert

This feature sets the handset and base unit to notify the arrival of a new text message on a cellular phone that is paired with the base unit. This notification is displayed momentarily on both the handset and the base unit, and announced. The announcement is in English only. The default setting is “on”.

Important:

- To use the text message alert feature, you need to pair your cellular phone to the base unit (page 18).
- Your cellular phone must support Message Access Profile (MAP) specification. We recommend that you confirm if your cellular phone supports MAP in advance.
- For more details and the list of compatible cellular phones, please visit our Web site: <http://www.panasonic.com/link2cell>
- Text message alerts can be made by CELL 1, CELL 2, and CELL 3.

For those whose devices do not support the Message Access Profile (MAP):

By installing the application “Text Message Alert”, you can use the text message alert feature. Please visit our Web site: <http://www.panasonic.net/pcc/support/tel/sms/>



- Refer to your cellular phone operating instructions for information on how to install applications.

Text message (SMS) alert settings

Program this setting using either the base unit or one of the handsets.

Your cellular phone

To use this text message alert feature, you may need to turn on the notification of Bluetooth setting on your cellular phone.

Handset / Base unit

- 1 For CELL 1: **[MENU]** **#** **6** **1** **0** **1**
For CELL 2: **[MENU]** **#** **6** **1** **0** **2**
For CELL 3: **[MENU]** **#** **6** **1** **0** **3**
- 2 **[↕]**: Select the desired setting.
- 3 **[SAVE]**
- 4 Proceed with the operation for your unit.
Handset: [OFF]
Base unit: [EXIT]

Note:

- If the text message alert feature does not work, you must turn on notifications in the Bluetooth settings of your cellular phone. Then, unplug the base unit's AC adaptor and reconnect it to activate the text message alert feature. For instructions on how to do this, visit our Web site: <http://www.panasonic.net/pcc/support/tel/>
- The unit cannot display or announce that a text message has been received during a call.
- Text message alerts are not logged in the caller list of your unit.

Using a Bluetooth wireless headset (optional) for landline calls

By pairing a Bluetooth headset to the base unit, you can have a hands-free conversation wirelessly for landline calls.

Important:

- 1 headset can be paired to the base unit. However, only one Bluetooth device (cellular phone or headset) can be connected to the base unit at a time.
- For best performance, we recommend using a Bluetooth headset within 1 m (3.3 feet) of the base unit. A headset can communicate with the base unit within a range of approximately 10 m (33 feet).
- If you are using a corded headset and a Bluetooth headset at the same time, the corded headset is used.

Pairing a headset to the base unit

Important:

- Make sure that the Bluetooth headset is not connected to any other Bluetooth device.

Handset / Base unit

- 1 Your headset:**
Set your headset to pairing mode.
 - Refer to the headset operating instructions.
- 2 [MENU]#621**
- 3 If your headset PIN is “0000”, go to step 4. If your headset PIN is other than “0000”, press [CLEAR], then enter your headset PIN.**
 - Typically, default PIN is “0000”. Refer to the headset operating instructions.
- 4 Press [OK], then wait until a long beep sounds.**
- 5 Proceed with the operation for your unit.**
Handset: [OFF]
Base unit: [EXIT]
 - When the HEADSET indicator on the base unit lights up, the headset is available for use.

Connecting/disconnecting a headset

If you cannot connect the headset and base unit using the headset, you can connect using the unit. To use your headset with another Bluetooth device such as a cellular phone, you may need to disconnect it from the base unit.

Important:

- Make sure that the headset is turned on.

Handset

- 1 To connect/disconnect:**
[MENU]#622
 - A long beep sounds.
- 2 [OFF]**

Base unit

To connect:

Press **[HEADSET]**.

To disconnect:

Press and hold **[HEADSET]** until a long beep sounds.

Unpairing a headset

You can cancel a pairing of the headset that is stored to the base unit.

Handset / Base unit

- 1 [MENU]#612**

- 2 [↕]: “yes” → [SELECT]**

- When the headset is unpaired, the HEADSET indicator on the base unit is turned off.

- 3 Proceed with the operation for your unit.**

Handset: [OFF]

Base unit: [EXIT]

Operating a Bluetooth wireless headset using a landline

Important:

- Refer to your headset operating instructions for headset operations.

Answering landline calls with your headset

To answer a landline call, turn on your headset referring to your headset operating instructions. When you finish talking, turn off your headset referring to your headset operating instructions.

Note:

- If you cannot hang up the call using your headset, press **[⏏]** on the base unit 2 times.

Switching between the base unit and your headset

You can switch between the base unit and your headset:

- during a landline call with the base unit speakerphone.
- during an intercom call between the base unit and handset.
- while listening to messages recorded on the base unit answering system.

■ To switch to your headset:

Press **[HEADSET]** on the base unit.

■ To switch to the base unit:

Press **[⏏]** on the base unit.

Call sharing between your headset and the handset

Important:

- To activate this feature, you should set call sharing mode to on beforehand (page 42).

■ While the handset is on a landline call:

To join the conversation with your headset, turn on the headset referring to your headset operating instructions.

■ While your headset is on a landline call:

To join the conversation with the handset, press **[↶]**.

- An available line is automatically selected. To change the line selection mode, see page 16.

Adjusting your headset receiver volume

Base unit

Press **[▲]** or **[▼]** repeatedly while using your headset.

Answering system for landline

The answering system can answer and record calls for you when you are unavailable to answer the phone.

You can also set the unit to play a greeting message but not to record caller messages by selecting “**Greeting only**” as the greeting setting (page 61).
Answering system settings can be set for each line.

Important:

- Make sure the date and time have been set correctly (page 16).

Memory capacity (including your greeting message)

The total recording capacity for both lines added together is about 60 minutes. A maximum of 128 messages can be recorded.

Note:

- When message memory becomes full:
 - “**Messages full**” is shown on the handset and base unit display.
 - The ANSWER ON/OFF indicator of each line on the base unit flashes rapidly if the answering system is turned on.
 - If you use the pre-recorded greeting message, the unit automatically switches to another pre-recorded greeting message asking callers to call again later.
 - If you recorded your own greeting message, the same message is still announced to callers even though their messages are not recorded.

Turning the answering system on/off

Base unit

To turn on/off:

For line 1: Press **[L1]** (ANSWER ON/OFF).
For line 2: Press **[L2]** (ANSWER ON/OFF).

Handset

1 To turn on:

For line 1: **[MENU]#3271**

For line 2: **[MENU]#3272**

To turn off:

For line 1: **[MENU]#3281**

For line 2: **[MENU]#3282**

2 [OFF]

Note for base unit and handset:

- When the answering system is turned on, the ANSWER ON/OFF indicator on the base unit lights up.

Call screening

Handset / Base unit

While a caller is leaving a message, you can listen to the call through the unit's speaker.

To adjust the speaker volume, press **[▲]** or **[▼]** repeatedly.

You can answer the call by pressing **[L1]** or **[L2]** on the handset or **[LINE 1]** or **[LINE 2]** on the base unit.

Call screening can be set for each unit. The default setting is “**on**”.

1 For line 1: **[MENU]#3101**

For line 2: **[MENU]#3102**

2 **[↕]**: Select the desired setting. → **[SAVE]**

3 Proceed with the operation for your unit.

Handset: [OFF]

Base unit: [EXIT]

Greeting message

When the unit answers a call, a greeting message is played to callers.

You can use the 3 types of greeting messages (“**Greeting1**”, “**Greeting2**”, “**Greeting only**”) for each line.

Selecting the greeting message

Handset / Base unit

You can set the combination of greeting messages and the start time of the greeting messages.

The following settings are available:

- “**Greeting1**”(default): The answering system only plays “**Greeting1**” for all calls.

- “Greeting2”: The answering system only plays “Greeting2” for all calls.
- “Greeting1&2”: The answering system announces either “Greeting1” or “Greeting2”, depending on the time of the incoming call.*1
- “Greeting1&Only”: The answering system announces either “Greeting1” or “Greeting only”, depending on the time of the incoming call.*1
- “Greeting only”: The answering system only plays “Greeting only” for all calls.

Program this setting using either the base unit or one of the handsets.

*1 The default setting for “Greeting1” plays between “9:00 AM” and “4:59 PM”, and the default setting for “Greeting2” or “Greeting only” plays between “5:00 PM” and “8:59 AM”.

Important:

- Make sure the unit’s date and time setting is correct (page 16).
- Record the greeting message beforehand (page 55).

- 1 For line 1: **[MENU]** **#** **3** **4** **2** **1**
For line 2: **[MENU]** **#** **3** **4** **2** **2**
- 2 **[↕]**: Select the desired greeting setting. → **[SELECT]**
 - “Greeting1” or “Greeting2”: Go to step 7.
 - “Greeting1&2” or “Greeting1&Only”: Go to step 3.
 - “Greeting only”: **[↕]**: “Yes” → **[SELECT]** → Go to step 7.
- 3 Enter the desired hour and minute you wish to start “Greeting1”.
- 4 Proceed with the operation for your unit.
Handset: **[☒]**: Select **[AM]** or **[PM]**. → **[OK]**
Base unit: **[AM/PM]**: Select **[AM]** or **[PM]**. → **[OK]**
- 5 Enter the desired hour and minute you wish to end this feature.
- 6 Proceed with the operation for your unit.
Handset: **[☒]**: Select **[AM]** or **[PM]**. → **[SAVE]**
Base unit: **[AM/PM]**: Select **[AM]** or **[PM]**. → **[SAVE]**
- 7 Proceed with the operation for your unit.
Handset: **[OFF]**
Base unit: **[EXIT]**

Selecting “Greeting only”

You can select “Greeting only” which sets the unit to announce a greeting message to callers but not record messages.

Select “Greeting only” or “Greeting1&Only” in step 2 on “Selecting the greeting message”, page 54.

Recording your greeting message

Handset / Base unit

- 1 For line 1: **[MENU]** **#** **3** **0** **2** **1**
For line 2: **[MENU]** **#** **3** **0** **2** **2**
- 2 **[↕]**: Select the desired greeting message. → **[SELECT]**
- 3 **[↕]**: “Yes” → **[SELECT]**
- 4 After a beep sounds, hold the handset about 20 cm (8 inches) away and speak clearly into the microphone (2 minutes max.).
- 5 Press **[STOP]** to stop recording.
- 6 Proceed with the operation for your unit.
Handset: **[OFF]**
Base unit: **[EXIT]**

Using a pre-recorded greeting message

The unit provides 2 pre-recorded greeting messages:

- If you erase or do not record your own greeting message, the unit plays a pre-recorded greeting asking callers to leave a message.
- If the greeting setting (page 54) is set to “Greeting only” or “Greeting1&Only”, callers’ messages are not recorded and the unit plays a different pre-recorded greeting message asking callers to call again.

Resetting to a pre-recorded greeting message

If you want to use a pre-recorded greeting message once you record your own greeting message, you need to erase your own greeting message.

Handset / Base unit

- 1 For line 1: **[MENU]** **#** **3** **0** **4** **1**
For line 2: **[MENU]** **#** **3** **0** **4** **2**
- 2 **[↕]**: Select the desired greeting message. → **[SELECT]**

- 3 [YES]
- 4 Proceed with the operation for your unit.
Handset: [OFF]
Base unit: [EXIT]

Playing back the greeting message

Handset / Base unit

- 1 For line 1: [MENU]# [3] [0] [3] [1]
 For line 2: [MENU]# [3] [0] [3] [2]
- 2 [↕]: Select the desired greeting message. → [SELECT]
- 3 Proceed with the operation for your unit.
Handset: To exit, press [OFF].
Base unit: To exit, press [EXIT].

Listening to messages using the base unit

When new messages have been recorded:

- [▶■] on the base unit flashes.
- “New message” is displayed.

For line 1: Press [▶■] (PLAY1).

For line 2: Press [▶■] (PLAY2).

- If new messages have been recorded, the base unit plays back new messages.
- If there are no new messages, the base unit plays back all messages.

Operating the answering system during playback

Key	Operation
[▲] or [▼]	Adjust the speaker volume
[◀◀]	Repeat message*1
[▶▶]	Skip message
[PAUSE]	Pause message To resume playback, press [▶].
[■] (STOP)	Stop playback
[ERASE]	Erase currently playing message

*1 If pressed within the first 5 seconds of a message, the previous message is played.

Calling back (Caller ID subscribers only)

Press [↵] during playback.

- To edit the number before calling back, press [EDIT] repeatedly until the phone number is shown in the desired format (page 48).
- The unit automatically uses the line you set in line selection mode (page 16) to call back. When the line selection mode is set to “Auto”, the indicated line (L1 or L2) is used for the call. If the indicated line is already being used or you want to select the other line, press [LINE 1] or [LINE 2].
- To call back using a cellular line, continue from step 2, “Making cellular calls”, page 27.

Erasing all messages for the desired line

- 1 [ERASE]
- 2 [↕]: Select the desired line. → [SELECT]
- 3 [↕]: “Yes” → [SELECT]

Listening to messages using the handset

When new messages have been recorded, “New message” is displayed.

1 To listen to new messages:

For line 1: [PLAY1]*1, *2

For line 2: [PLAY2]*1, *2

or

For line 1: [MENU]# [3] [2] [3] [1]

For line 2: [MENU]# [3] [2] [3] [2]

To listen to all messages:

For line 1: [MENU]# [3] [2] [4] [1]

For line 2: [MENU]# [3] [2] [4] [2]

2 When finished, press [OFF].

Note:

- To switch to the receiver, press [↶].

*1 If there are no new messages in the answering system, [PLAY1] or [PLAY2] is not displayed.

*2 If there are new messages in both lines, [PLAY] is displayed.

Operating the answering system

[MENU] → [↕]: “Answering device” →
 [SELECT] → [↕]: Select the desired line. →
 [SELECT]

Key	Operation
[▲] or [▼]	Adjust the receiver/speaker volume (during playback)
[1] or [◀]	Repeat message (during playback)*1
[2] or [▶]	Skip message (during playback)
[3]	Enter the “Settings” menu
[4]	Play new messages
[5]	Play all messages
[8]	Turn answering system on
[PAUSE]	Pause message*2
[9] or [STOP]	Stop recording Stop playback
[0]	Turn answering system off
[X] [4]*3	Erase currently playing message
[X] [5]	Erase all messages

- *1 If pressed within the first 5 seconds of a message, the previous message is played.
 *2 To resume playback:
 [↕]: “Playback” → [SELECT]
 *3 You can also erase as follows:
 [PAUSE] → [↕]: “Erase” → [SELECT]
 → [↕]: “Yes” → [SELECT]

Calling back (Caller ID subscribers only)

Press the desired line key during playback.

Editing the number before calling back

- 1 Press [PAUSE] during playback.
- 2 [↕]: “Edit & Call” → [SELECT]
- 3 Press [EDIT] repeatedly until the phone number is shown in the desired format (page 48). → Press the desired landline key ([L1] or [L2]).
 - The unit automatically uses the line you set in line selection mode (page 16) to call back. When the line selection mode is set to “Auto”, the indicated line ([L1] or [L2]) is used for the call. If the indicated line is already

being used or you want to select the other line, press [L1] or [L2].

- To call back using a cellular line, continue from step 2, “Making cellular calls”, page 22.

Erasing all messages

- 1 For line 1: [MENU]#[3][2][5][1]
 For line 2: [MENU]#[3][2][5][2]
- 2 [↕]: “Yes” → [SELECT] → [OFF]

Advanced new message alerting features

Audible message alert

This feature allows the base unit to beep to inform you of a new message arrival when new messages are recorded. The base unit beeps 2 times every minute until you listen to the messages, if the “Base unit beep” setting is turned on. The default setting is “OFF”.

Program this setting using either the base unit or one of the handsets.

Handset / Base unit

- 1 For line 1: [MENU]#[3][3][9][1]
 For line 2: [MENU]#[3][3][9][2]
- 2 [↕]: Select the desired setting. → [SAVE]
- 3 Proceed with the operation for your unit.
Handset: [OFF]
Base unit: [EXIT]

Note:

- When the silent mode is activated (page 44), the base unit beeps will not sound.

New message alert by a call

This feature allows the unit to make a call to the pre-stored phone number and inform you that a new message has been received by announcement.

To use this feature, you must:

- store a phone number to which the unit makes the call to.
 - turn on the new message alert setting.
- After you answer the new message alert call, you can listen to messages from that call (page 59). This feature can be set for each line separately.

Important:

- A new message alert is stopped 1 minute after the unit starts to call. The unit will not retry the call even if the call is not answered.

Storing a phone number to which the unit makes an alert call

Handset

■ From the phonebook:

- 1 For line 1: **[MENU]** **#** **3** **3** **8** **1**
For line 2: **[MENU]** **#** **3** **3** **8** **2**
- 2 **[↕]**: "Alert to" → **[SELECT]** → **[ADD]**
- 3 **[↕]**: "Phonebook" → **[SELECT]**
- 4 **[↕]**: Select the desired phonebook entry.
→ **[SAVE]** → **[OFF]**

■ By entering a phone number:

- 1 For line 1: **[MENU]** **#** **3** **3** **8** **1**
For line 2: **[MENU]** **#** **3** **3** **8** **2**
- 2 **[↕]**: "Alert to" → **[SELECT]** → **[ADD]**
- 3 **[↕]**: "Manual" → **[SELECT]**
- 4 Enter the desired name (16 characters max.). → **[OK]**
- 5 Enter the desired number (24 digits max.).
→ **[OK]** → **[SELECT]** → **[OFF]**

Base unit

■ From the phonebook:

- 1 For line 1: **[MENU]** **#** **3** **3** **8** **1**
For line 2: **[MENU]** **#** **3** **3** **8** **2**
- 2 **[↕]**: "Alert to" → **[SELECT]** → **[☞]**
- 3 **[↕]**: Select the desired phonebook entry.
→ **[SAVE]** → **[EXIT]**

■ By entering a phone number:

- 1 For line 1: **[MENU]** **#** **3** **3** **8** **1**
For line 2: **[MENU]** **#** **3** **3** **8** **2**
- 2 **[↕]**: "Alert to" → **[SELECT]** → **[EDIT]**
- 3 Enter the desired name (16 characters max.). → **[OK]**
- 4 Enter the desired number (24 digits max.).
→ **[OK]** → **[SELECT]** → **[EXIT]**

Turning on/off the new message alert setting

Handset / Base unit

- 1 For line 1: **[MENU]** **#** **3** **3** **8** **1**
For line 2: **[MENU]** **#** **3** **3** **8** **2**
- 2 **[↕]**: "On/Off" → **[SELECT]**
- 3 **[↕]**: Select the desired setting. → **[SAVE]**
- 4 Proceed with the operation for your unit.
Handset: **[OFF]**
Base unit: **[EXIT]**

Editing the set phone number

Handset

- 1 For line 1: **[MENU]** **#** **3** **3** **8** **1**
For line 2: **[MENU]** **#** **3** **3** **8** **2**
- 2 **[↕]**: "Alert to" → **[SELECT]**
- 3 **[MENU]** → **[↕]**: "Edit" → **[SELECT]**
- 4 Edit the name if necessary (16 characters max.). → **[OK]**
- 5 Edit the phone number if necessary (24 digits max.). → **[OK]** → **[SELECT]** → **[OFF]**

Base unit

- 1 For line 1: **[MENU]** **#** **3** **3** **8** **1**
For line 2: **[MENU]** **#** **3** **3** **8** **2**
- 2 **[↕]**: "Alert to" → **[SELECT]** → **[EDIT]**
- 3 Edit the name if necessary (16 characters max.). → **[OK]**
- 4 Edit the phone number if necessary (24 digits max.). → **[OK]** → **[SELECT]** → **[EXIT]**

Erasing the set phone number

Handset

- 1 For line 1: **[MENU]** **#** **3** **3** **8** **1**
For line 2: **[MENU]** **#** **3** **3** **8** **2**
- 2 **[↕]**: "Alert to" → **[SELECT]**
- 3 **[MENU]** → **[↕]**: "Erase" → **[SELECT]**
- 4 **[↕]**: "Yes" → **[SELECT]** → **[OFF]**
 - The new message alert setting is turned off.

Base unit

- 1 For line 1: **[MENU]** **#** **3** **3** **8** **1**
For line 2: **[MENU]** **#** **3** **3** **8** **2**
- 2 **[↕]**: "Alert to" → **[SELECT]** → **[ERASE]**
- 3 **[↕]**: "Yes" → **[SELECT]** → **[EXIT]**
 - The new message alert setting is turned off.

Activating/inactivating the remote access code to play messages

If you activate this feature, you must enter the remote access code (page 59) to play the new message from the new message alert call. This is so that unauthorized parties cannot listen to your messages. The default setting is “Inactivate”.

- “Inactivate”: You can listen to the message by pressing **[4]** to play new messages (without entering the remote access code).
- “Activate”: You must enter your remote access code (page 59) and then press **[4]** to play new message.

Handset / Base unit

- 1** For line 1: **[MENU][#][3][3][8][1]**
For line 2: **[MENU][#][3][3][8][2]**
- 2** **[↕]**: “Remote code” → **[SELECT]**
- 3** **[↕]**: Select the desired setting. → **[SAVE]**
- 4** Proceed with the operation for your unit.
Handset: [OFF]
Base unit: [EXIT]

Listening to messages

After you answer the new message alert, you can listen to the messages as follows.

- **When the remote access code is set to “Inactivate”:**
Press **[4]** to play the new message during the announcement.
- **When the remote access code is set to “Activate”:**
 - 1** Enter the remote access code (page 59) during the announcement.
 - 2** Press **[4]** to play the new message.

Note:

- Within 10 seconds after listening to new messages, you can press **[#][9]** during the call to turn off the new message alert by a call feature.
- Even if the unit makes a new message alert call, the handset redial list does not show the record. However, on the base unit redial list it is shown as “Message alert”.

Remote operation

Using a touch-tone phone, you can call your phone number from outside and access the unit to listen to messages or change answering system settings. The unit’s voice guidance prompts you to press certain dial keys to perform different operations.

Remote access code

A 3-digit remote access code must be entered when operating the answering system remotely. This code prevents unauthorized parties from listening to your messages remotely. The default setting is “111”.

Program this setting using either the base unit or one of the handsets.

Important:

- To prevent unauthorized access to this product, we recommend that you regularly change the remote code.

Handset / Base unit

- 1** For line 1: **[MENU][#][3][0][6][1]**
For line 2: **[MENU][#][3][0][6][2]**
- 2** Enter the desired 3-digit remote access code.
- 3** **[SAVE]**
- 4** Proceed with the operation for your unit.
Handset: [OFF]
Base unit: [EXIT]

Deactivating remote operation

Press **[X]** in step 2 on “Remote access code”, page 59.

- The entered remote access code is deleted.

Using the answering system remotely

- 1** Dial your landline phone number from a touch-tone phone.
- 2** After the greeting message starts, enter your remote access code.
- 3** Follow the voice guidance prompts as necessary or control the unit using remote commands (page 60).
- 4** When finished, hang up.

Voice guidance

■ When the English voice guidance is selected

During remote operation, the unit's voice guidance starts and prompts you to press **[1]** to perform a specific operation, or press **[2]** to listen to more available operations.

■ When the Spanish voice guidance is selected

To start the voice guidance, press **[9]**. The voice guidance announces the available remote commands (page 60).

Note:

- If you do not press any dial keys within 10 seconds after a voice guidance prompt, the unit disconnects your call.

Remote commands

You can press dial keys to access certain answering system functions without waiting for the voice guidance to prompt you.

Key	Operation
[1]	Repeat message (during playback) ^{*1}
[2]	Skip message (during playback)
[4]	Play new messages
[5]	Play all messages
[9]	Stop playback ^{*2} Start voice guidance ^{*3}
[0]	Turn answering system off
[*][4]	Erase currently playing message
[*][5]	Erase all messages
[*][#]	End remote operation (or hang up)

- *1 If pressed within the first 5 seconds of a message, the previous message is played.
 *2 For English voice guidance only
 *3 For Spanish voice guidance only

Turning on the answering system remotely

- 1 Dial your phone number from a touch-tone phone.
- 2 Let the phone ring 15 times.
 - A long beep is heard.

- 3 Enter your remote access code within 10 seconds after the long beep.
 - The greeting message is played back.
 - You can either hang up, or enter your remote access code again and begin remote operation (page 59).

Answering system settings

Number of rings before the unit answers a call

You can change the number of times the phone rings “**Ring count**” before the unit answers calls. You can select 2 to 7 rings, or “**To11 saver**”.

The default setting is “**4 rings**”.

“**To11 saver**”: The unit's answering system answers at the end of the 2nd ring when new messages have been recorded, or at the end of the 5th ring when there are no new messages. If you call your phone from outside to listen to new messages (page 59), you know that there are no new messages when the phone rings for the 3rd time. You can then hang up without being charged for the call.

Program this setting using either the base unit or one of the handsets.

Handset / Base unit

- 1 For line 1: **[MENU][#][2][1][1][1]**
For line 2: **[MENU][#][2][1][1][2]**
- 2 **[↕]**: Select the desired setting. → **[SAVE]**
- 3 Proceed with the operation for your unit.
Handset: [OFF]
Base unit: [EXIT]

For voice mail service subscribers

If you subscribe to a flat-rate service package that includes Caller ID, call waiting, voice mail, and unlimited local/regional/long distance calls, please note the following:

- To use the voice mail service provided by your service provider/telephone company rather than the unit's answering system, turn off the answering system (page 54).
- To use this unit's answering system rather than the voice mail service provided by your service provider/telephone company, please contact

your service provider/telephone company to deactivate your voice mail service.

If your service provider/telephone company cannot do this:

- Set this unit's "Ring count" setting so that this unit's answering system answers calls before the voice mail service of your service provider/telephone company does. It is necessary to check the number of rings required to activate the voice mail service provided by your service provider/telephone company before changing this setting.
- Change the number of rings of the voice mail service so that the answering system can answer the call first. To do so, contact your service provider/telephone company.

Caller's recording time

You can change the maximum message recording time allowed for each caller. The default setting is "3 min".

Program this setting using either the base unit or one of the handsets.

Handset / Base unit

- 1** For line 1: **[MENU]#3051**
For line 2: **[MENU]#3052**
- 2** **[↕]**: Select the desired setting. → **[SAVE]**
- 3** Proceed with the operation for your unit.
Handset: [OFF]
Base unit: [EXIT]

Voice mail service for landline

Voice mail is an automatic answering service offered by your service provider/telephone company. After you subscribe to this service, your service provider/telephone company's voice mail system answers calls for you when you are unavailable to answer the phone or when your line is busy. Messages are recorded by your service provider/telephone company, not your telephone. Please contact your service provider/telephone company for details of this service.

Important:

- To use the voice mail service provided by your service provider/telephone company rather than the unit's answering system, turn off the answering system (page 54). For details, see page 60.

Voice mail message indication

When you have new voice mail messages, "Voice Mail: **1**" and/or "Voice Mail: **2**" is displayed if message indication service is available. In order to listen to your voice mail messages, you must dial the voice mail access number of your service provider/telephone company.

Note for handset and base unit:

- If the handset and base unit still indicate there are new messages even after you have listened to all new messages, turn it off by pressing and holding **[#]** until the handset or base unit beeps.

Voice mail (VM) tone detection

Handset / Base unit

Your service provider/telephone company sends special signals (sometimes called "voice mail tones" or "stutter tones") to the unit to let you know you have new voice mail messages. If you hear a series of dial tones followed by a continuous dial tone after you press **[hook]** on the handset or press **[hook]** on the base unit, you have new voice mail messages. Soon after you hang up a call or after the phone stops ringing, your unit checks the phone line to see if new voice mail messages have been recorded.

Turn this feature off when:

- You do not subscribe to voice mail service.
 - Your service provider/telephone company does not send voice mail tones.
 - Your phone is connected to a PBX.
- If you are not sure which setting is required, contact your service provider/telephone company.

Turning VM tone detection on/off

The default setting is "on".

Program this setting using either the base unit or one of the handsets.

Handset / Base unit

- 1 **[MENU][#][3][3][2]**
- 2 **[↕]**: Select the desired setting. → **[SAVE]**
- 3 Proceed with the operation for your unit.
Handset: [OFF]
Base unit: [EXIT]

Wall mounting

The base unit can be mounted on a wall by changing the wall mounting adaptor's position.

Note:

- Make sure that the wall and the fixing method are strong enough to support the weight of the unit.

Base unit

- 1 To remove the wall mounting adaptor, push down the release levers (1). Remove the adaptor (2).

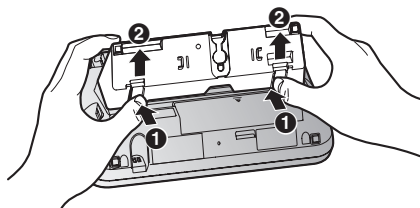

- 2 ① Turn the adaptor so that the words "UP WALL" are facing up.
② Tuck the telephone line cord inside the wall mounting adaptor.

- ③ Connect the AC adaptor cord and telephone line cord.

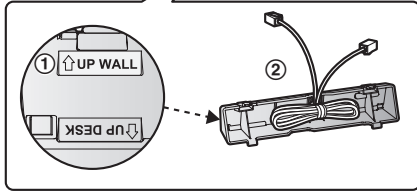
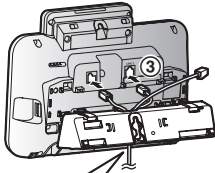

- 3 Insert the lower tabs of the adaptor into the unit's bottom slots (1), then insert by pushing down the levers of the adaptor into the upper slots (2).
- The words "UP WALL" should be facing up.

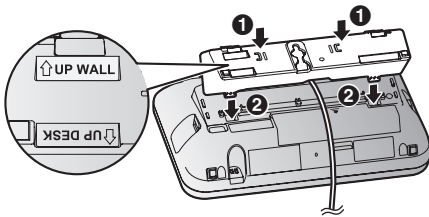

- 4 Mount the unit on a wall then slide down to secure in place.

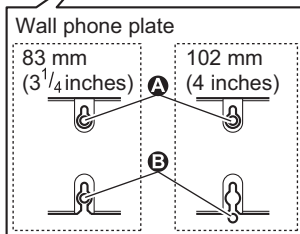
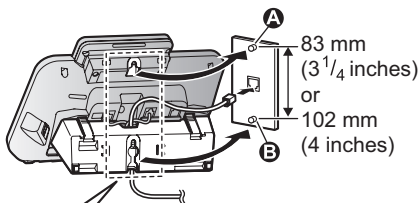

Charger

Drive the screws (not supplied) into the wall.

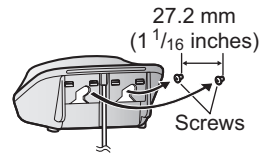

Error messages

Display message	Cause/solution
Base no power or No link. Re-connect base AC adaptor.	<ul style="list-style-type: none"> • The handset has lost communication with the base unit. Move closer to the base unit and try again. • Unplug the base unit's AC adaptor to reset the unit. Reconnect the adaptor and try again. • The handset's registration may have been canceled. Re-register the handset (page 46).
Busy	<ul style="list-style-type: none"> • No cellular phone is paired to the base unit. Pair a cellular phone (page 18). • The called unit is in use. • Other units are in use and the system is busy. Try again later. • The handset you are using is too far from the base unit. Move closer and try again.
Check tel line 1 Check tel line 2	<ul style="list-style-type: none"> • The supplied telephone line cord has not been connected yet or not connected properly. Check the connections (page 9). • If you use the unit as a single-line telephone only, erase the message as follows: To erase "Check tel line 1", press [MENU]. → # [1] [8] [9] To erase "Check tel line 2", press [MENU]. → # [1] [9] [0] When a power failure occurs, the message is displayed again. Erase again as above.
Error!!	<ul style="list-style-type: none"> • Recording was too short. Try again. • Someone is using a cellular line or headset. Try again later. • The phonebook copy is incomplete (page 50). The cellular phone is disconnected from the base unit. Make sure that other Bluetooth devices are not connected to the cellular phone, and try again.
Failed	<ul style="list-style-type: none"> • Although the unit tried to connect to the cellular phone or headset, the connection has been failed. <ul style="list-style-type: none"> – Someone is using a cellular line or headset. Try again later. – Make sure that the cellular phone or headset is not connected to other Bluetooth devices.
Invalid	<ul style="list-style-type: none"> • There is no handset registered to the base unit matching the handset number you entered. • The handset is not registered to the base unit. Register the handset (page 46).
Requires subscription to Caller ID.	<ul style="list-style-type: none"> • You must subscribe to a Caller ID service. Once you receive caller information after subscribing to a Caller ID service, this message will not be displayed.
Use rechargeable battery.	<ul style="list-style-type: none"> • A wrong type of battery such as Alkaline or Manganese was inserted. Use only the rechargeable Ni-MH batteries noted on page 4, 6.

Troubleshooting

If you still have difficulties after following the instructions in this section, disconnect the base unit's AC adaptor, then reconnect the base unit's AC adaptor. Remove the batteries from the handset, and then insert the batteries into the handset again.



General use

Problem	Cause/solution
The handset does not turn on even after installing charged batteries.	<ul style="list-style-type: none"> Place the handset on the base unit or charger to turn on the handset.
The unit does not work.	<ul style="list-style-type: none"> Make sure the batteries are installed correctly (page 11). Fully charge the batteries (page 11). Check the connections (page 9). Unplug the base unit's AC adaptor to reset the unit. Reconnect the adaptor and try again. The handset has not been registered to the base unit. Register the handset (page 46).
I cannot pair a cellular phone to the base unit.	<ul style="list-style-type: none"> Depending on the compatibility of the cellular phone, you may not be able to pair it to the base unit. Confirm that your cellular phone supports the hands-free profile (HFP) specification. Confirm that the Bluetooth feature of your cellular phone is turned on. You may need to turn this feature on depending on your cellular phone. The Bluetooth technology on your cellular phone may not be functioning normally. Turn off and on your cellular phone. If your cellular phone is already connected to another Bluetooth device such as a Bluetooth headset, turn it off or disconnect it from your cellular phone. Some cellular phones may require you to enter the base unit PIN to pairing. Confirm that you entered the correct PIN.
I cannot connect a cellular phone to the base unit.	<ul style="list-style-type: none"> Confirm that your cellular phone is turned on. Confirm that your cellular phone is within base unit range (page 14). Depending on the state of the wireless environment, such as the presence of any electrical interference, there may be a delay even if the auto connection feature is turned on. You can connect to the base unit manually (page 20). The cellular phone has not been paired to the base unit. Pair the cellular phone (page 18).
I cannot hear a dial tone.	<ul style="list-style-type: none"> Make sure that the CELL indicator lights up (page 15). The base unit's AC adaptor or telephone line cord is not connected. Check the connections. Disconnect the base unit from the telephone line and connect the line to a known working telephone. If the working telephone operates properly, contact our service personnel to have the unit repaired. If the working telephone does not operate properly, contact your service provider/telephone company.
The base unit beeps.	<ul style="list-style-type: none"> New messages have been recorded. Listen to the new messages (page 56).

Menu list

Problem	Cause/solution
The display is in a language I cannot read.	<ul style="list-style-type: none">● Change the display language (page 16).
I cannot register a handset to a base unit.	<ul style="list-style-type: none">● The maximum number of handsets (6) is already registered to the base unit. Cancel unused handset registrations from the base unit (page 46).

Battery recharge

Problem	Cause/solution
The handset beeps and/or  flashes.	<ul style="list-style-type: none">● Battery charge is low. Fully charge the batteries (page 11).
I fully charged the batteries, but –  still flashes, –  is displayed, or – the operating time seems to be shorter.	<ul style="list-style-type: none">● Clean the battery ends (\oplus, \ominus) and the charge contacts with a dry cloth and charge again.● It is time to replace the batteries (page 11).

Making/answering calls, intercom

Problem	Cause/solution
 is displayed.	<ul style="list-style-type: none">● The handset is too far from the base unit. Move closer.● The base unit's AC adaptor is not properly connected. Reconnect AC adaptor to the base unit.● The handset is not registered to the base unit. Register it (page 46).
Noise is heard, sound cuts in and out.	<ul style="list-style-type: none">● You are using the handset or base unit in an area with high electrical interference. Re-position the base unit and use the handset away from sources of interference.● Move closer to the base unit.● If you use a DSL/ADSL service, we recommend connecting a DSL/ADSL filter between the base unit and the telephone line jack. Contact your DSL/ADSL provider for details.
The handset or base unit does not ring.	<ul style="list-style-type: none">● The ringer volume for landline is turned off. Adjust the ringer volume (page 40).● The ringer volume for cellular line is turned off. Adjust the ringer volume (page 39).● When one handset is selected to ring for cellular calls, other units do not ring. To change the selection, see page 20.● Silent mode is turned on. Turn it off (page 44).
I cannot make local calls with the handset or base unit using a cellular line.	<ul style="list-style-type: none">● You need to add your area code when making cellular calls. Store your area code in order to automatically add it to the beginning of the 7-digit phone number when making cellular calls (page 20).

Problem	Cause/solution
I cannot make or answer cellular calls with the handset or base unit.	<ul style="list-style-type: none"> Depending on the cellular phone's compatibility, you may not be able to make or answer cellular calls even if the cellular phone is connected to the base unit. Make sure that the CELL indicator lights up and the cellular phone is connected to the base unit (page 20). If someone is talking on a cellular call or using the headset, you cannot use the cellular feature. There can be only one active Bluetooth connection at a time. The cellular phone is being used separately from your system.
I can make and answer cellular calls but cannot hear a sound.	<ul style="list-style-type: none"> The Bluetooth technology on your cellular phone may not be functioning normally. Turn off and on your cellular phone. Disconnect and reconnect the base unit AC adaptor and try again.
I cannot switch cellular calls from the unit to the cellular phone.	<ul style="list-style-type: none"> Your cellular phone may not support this feature. Refer to the operating instructions of your cellular phone.
I cannot make a call using the landline.	<ul style="list-style-type: none"> The dialing mode may be set incorrectly. Change the setting (page 16).
I cannot make long distance calls.	<ul style="list-style-type: none"> Make sure that you have long distance service.

Caller ID/Talking Caller ID

Problem	Cause/solution
Caller information is not displayed.	<ul style="list-style-type: none"> You must subscribe to Caller ID service. Contact your service provider/telephone company for details. If your unit is connected to any additional telephone equipment such as a Caller ID box or cordless telephone line jack, plug the unit directly into the wall jack. If you use a DSL/ADSL service, we recommend connecting a DSL/ADSL filter between the base unit and the telephone line jack. Contact your DSL/ADSL provider for details. The name display service for landline calls may not be available in some areas. Contact your service provider/telephone company for details. Other telephone equipment may be interfering with this unit. Disconnect the other equipment and try again.
Caller information is displayed or announced late.	<ul style="list-style-type: none"> Depending on your service provider/telephone company, the unit may display or announce the caller's information at the 2nd ring or later. Move closer to the base unit.

Useful Information

Problem	Cause/solution
Caller information is not announced.	<ul style="list-style-type: none"> • The ringer volume for landline is turned off. Adjust the ringer volume (page 40). • The ringer volume for cellular line is turned off. Adjust the ringer volume (page 39). • When one handset is selected to ring for cellular calls, other units do not announce caller information. To change the selection, see page 19. • The Talking Caller ID feature is turned off. Turn it on (page 41). • The ring as cell mode is set to “On (without Talking CID)”. To change the mode, see page 19. • The number of rings for the answering system is set to “2 rings” or “Toll saver”. Select a different setting (page 60).
The caller list/incoming phone numbers are not edited automatically.	<ul style="list-style-type: none"> • The Caller ID number auto edit feature is turned off. Turn it on and try again (page 42). • You need to call back the edited number to activate Caller ID number auto edit.
I cannot dial the phone number edited in the caller list.	<ul style="list-style-type: none"> • The phone number you dialed might have been edited incorrectly (for example, the long distance “1” or the area code is missing). Edit the phone number with another pattern (page 48).
Time on the unit has shifted.	<ul style="list-style-type: none"> • Incorrect time information from incoming Caller ID changes the time. Set the time adjustment to “Manual” (off) (page 41).
The 2nd caller’s information is not displayed during an outside call.	<ul style="list-style-type: none"> • In order to use Caller ID, call waiting, or Call Waiting Caller ID (CWID), you must first contact your service provider/telephone company and subscribe to the desired service. After subscribing, you may need to contact your service provider/telephone company again to activate this specific service, even if you already subscribed to both Caller ID and Call Waiting with Caller ID services (CWID).

Using Bluetooth devices

Problem	Cause/solution
I cannot copy phonebook entries from a cellular phone.	<ul style="list-style-type: none"> • Confirm that the cellular phone supports Bluetooth wireless technology. • Confirm that the cellular phone supports the Phone Book Access Profile (PBAP) or Object Push Profile (OPP) specification. • If the cellular phone is already connected to another Bluetooth device such as a Bluetooth headset, turn it off or disconnect it from the cellular phone. • Someone is using a cellular line or headset. Try again later. • Turn the cellular phone off, then turn it on and try again. • If an entry is already stored in the unit’s shared phonebook, the entry cannot be copied even by selecting another group.
I cannot have a conversation using the headset.	<ul style="list-style-type: none"> • Your Bluetooth headset is not paired. Pair it (page 51). • Turn your headset off, then turn it on and try again.

Problem	Cause/solution
Noise is heard during a call on the headset.	<ul style="list-style-type: none"> ● A Bluetooth headset can communicate with the base unit within a range of approximately 10 m (33 feet). The connection may be subject to interference from obstructions such as walls or electronic devices. Move closer to the base unit.
I cannot connect my headset to the base unit.	<ul style="list-style-type: none"> ● Confirm that your headset is turned on. ● If your headset is already connected to another Bluetooth device such as your cellular phone, disconnect the headset from your cellular phone, then perform the connecting procedure from the base unit. ● If someone is using a cellular line, you cannot connect the headset. There can be only one active Bluetooth connection at a time. ● The headset has not been paired to the base unit. Pair the headset (page 51).
Some headset enhanced features are not available.	<ul style="list-style-type: none"> ● The base unit does not support enhanced features such as Last number redial or Call reject.
An error tone is heard when I try to program the Bluetooth feature.	<ul style="list-style-type: none"> ● The Bluetooth feature cannot be accessed immediately after connecting the AC adaptor to the base unit. Wait a few seconds and try again. ● The headset has not connected to the base unit yet, even though you performed the connecting procedure setting. Wait a few seconds and try again.
Text message (SMS) alert is not announced.	<ul style="list-style-type: none"> ● The text message (SMS) alert announcement depends on the “Ring as cell (limited)” setting (page 19) and the “Talking Caller ID” setting (page 41). To make the unit announce text message (SMS) alerts, there are 2 methods available, depending on whether or not you want the unit to emit the same ring as the cellular phone when a call is being received on the cellular phone. <ul style="list-style-type: none"> – If you prefer the same ring as the cellular phone, select “On (with Talking CID)” of the “Ring as cell (limited)” setting. – If you prefer the same ring as the unit, select “Off” of the “Ring as cell (limited)” setting, and select “On” of the “Talking Caller ID” setting on the handset and base unit.

Answering system

Problem	Cause/solution
The unit does not record new messages.	<ul style="list-style-type: none"> • The answering system is turned off. Turn it on (page 54). • The answering system does not answer or record calls from cellular lines. • The message memory is full. Erase unnecessary messages (page 56). • The greeting setting is set to "Greeting only" or Greeting1&Only. Change the setting (page 54). • If you subscribe to a voice mail service, messages are recorded by your service provider/telephone company, not your telephone. Change the unit's number of rings setting or contact your service provider/telephone company (page 60). • The answering system can only record calls from 1 line at a time.
I cannot operate the answering system remotely.	<ul style="list-style-type: none"> • The remote access code is not set. Set the remote access code (page 59). • You are entering the wrong remote access code. If you have forgotten your remote access code, enter the remote access code setting to check your current code (page 59). • The answering system is turned off. Turn it on (page 60). • You cannot operate the answering system when calling a cellular phone paired to the base unit.
The unit does not emit the specified number of rings.	<ul style="list-style-type: none"> • If the first ring is turned off, the number of rings decreases by 1 from the specified number of rings.

Bluetooth PIN

Problem	Cause/solution
I cannot remember the PIN.	<ul style="list-style-type: none"> • Change the PIN using the following method. <ol style="list-style-type: none"> 1 [MENU] # 6 1 9 2 ⊗ 7 0 0 0 3 Enter the new 4-digit PIN. → [OK] 4 Enter the new 4-digit PIN again. → [SAVE] → [OFF]

Liquid damage

Problem	Cause/solution
Liquid or other form of moisture has entered the handset/base unit.	<ul style="list-style-type: none"> • Disconnect the AC adaptor and telephone line cord from the base unit. Remove the batteries from the handset and leave to dry for at least 3 days. After the handset/base unit are completely dry, reconnect the AC adaptor and telephone line cord. Insert the batteries and charge fully before use. If the unit does not work properly, contact an authorized service center.

Caution:

- To avoid permanent damage, do not use a microwave oven to speed up the drying process.

FCC and other information

This equipment complies with Part 68 of the FCC rules and the requirements adopted by the ACTA. On the bottom of this equipment is a label that contains, among other information, a product identifier in the format US:ACJ-----.

If requested, this number must be provided to the telephone company.

- Registration No. (found on the bottom of the unit)
- Ringer Equivalence No. (REN)0.1B (line1 and line2)

A plug and jack used to connect this equipment to the premises wiring and telephone network must comply with the applicable FCC Part 68 rules and requirements adopted by the ACTA. A compliant telephone cord and modular plug is provided with the product. It is designed to be connected to a compatible modular jack that is also compliant.

The REN is used to determine the number of devices that may be connected to a telephone line. Excessive RENs on a telephone line may result in the devices not ringing in response to an incoming call. In most but not all areas, the sum of RENs should not exceed five (5.0). To be certain of the number of devices that may be connected to a line, as determined by the total RENs, contact the local telephone company. For products approved after July 23, 2001, the REN for the product is part of the product identifier that has the format US:AAAEQ##TXXXX. The digits represented by ## are the REN without a decimal point (e.g., 03 is a REN of 0.3).

If this equipment causes harm to the telephone network, the telephone company will notify you in advance that temporary discontinuance of service may be required. But if advance notice isn't practical, the telephone company will notify the customer as soon as possible. Also, you will be advised of your right to file a complaint with the FCC if you believe it is necessary.

The telephone company may make changes in its facilities, equipment, operations or procedures that could affect the operation of the equipment. If this happens the telephone company will provide advance notice in order for you to make necessary modifications to maintain uninterrupted service.

If trouble is experienced with this equipment, for repair or warranty information, please contact a Factory Service Center or other Authorized Servicer. If the equipment is causing harm to the telephone network, the telephone company may request that you disconnect the equipment until the problem is resolved.

Connection to party line service is subject to state tariffs. Contact the state public utility commission, public service commission or corporation commission for information.

If your home has specially wired alarm equipment connected to the telephone line, ensure the installation of this equipment does not disable your alarm equipment. If you have questions about what will disable alarm equipment, consult your telephone company or a qualified installer.

This equipment is hearing aid compatible as defined by the FCC in 47 CFR Section 68.316.

When you hold the phone to your ear, noise might be heard in your Hearing Aid. Some Hearing Aids are not adequately shielded from external RF (radio frequency) energy. If noise occurs, use an optional headset accessory or the speakerphone option (if applicable) when using this phone. Consult with your audiologist or Hearing Aid manufacturer about the availability of Hearing Aids which provide adequate shielding to RF energy commonly emitted by digital devices.

WHEN PROGRAMMING EMERGENCY NUMBERS AND/OR MAKING TEST CALLS TO EMERGENCY NUMBERS:

- 1) Remain on the line and briefly explain to the dispatcher the reason for the call.
- 2) Perform such activities in the off-peak hours, such as early morning or late evenings.

This device complies with Part 15 of the FCC Rules.

Operation is subject to the following two conditions:

- (1) This device may not cause harmful interference, and
- (2) this device must accept any interference received, including interference that may cause undesired operation.

Privacy of communications may not be ensured when using this phone.

CAUTION:

Any changes or modifications not expressly approved by the party responsible for compliance could void the user's authority to operate this device.

NOTE:

This equipment has been tested and found to comply with the limits for a Class B digital device, pursuant to Part 15 of the FCC Rules. These limits are designed to provide reasonable protection against harmful interference in a residential installation. This equipment generates, uses, and can radiate radio

frequency energy and, if not installed and used in accordance with the instructions, may cause harmful interference to radio communications. However, there is no guarantee that interference will not occur in a particular installation. If this equipment does cause harmful interference to radio or television reception, which can be determined by turning the equipment off and on, the user is encouraged to try to correct the interference by one or more of the following measures:

- Reorient or relocate the receiving antenna.
- Increase the separation between the equipment and receiver.
- Connect the equipment into an outlet on a circuit different from that to which the receiver is connected.
- Consult the dealer or an experienced radio/TV technician for help.

Some cordless telephones operate at frequencies that may cause interference to nearby TVs and VCRs. To minimize or prevent such interference, the base of the cordless telephone should not be placed near or on top of a TV or VCR. If interference is experienced, move the cordless telephone further away from the TV or VCR. This will often reduce or eliminate interference.

FCC RF Exposure Warning:

- This product complies with FCC radiation exposure limits set forth for an uncontrolled environment.
- To comply with FCC RF exposure requirements, the base unit must be installed and operated 20 cm (8 inches) or more between the product and all person's body (excluding extremities of hands, wrist and feet).
- This product may not be collocated or operated in conjunction with any other antenna or transmitter.
- The handset may be carried and operated with only the specific provided belt-clip. Other non-tested belt-clips or similar body-worn accessories may not comply and must be avoided.

Notice

- FCC ID can be found inside the battery compartment or on the bottom of the units.

Compliance with TIA-1083 standard:

Telephone handsets identified with this logo have reduced noise and interference when used with T-Coil equipped hearing aids and cochlear implants.



Guía Rápida Española

Cómo conectar el adaptador para corriente

Unidad base

- Use solo el adaptador de corriente alterna Panasonic PNLV234 que se suministra.

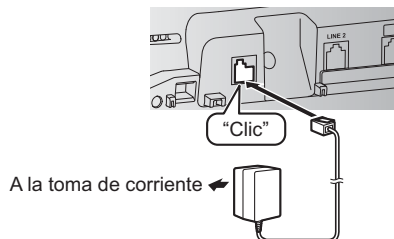

*Se requiere un filtro DSL/ADSL (no incluido) si tiene servicio de DSL/ADSL.

Cargador

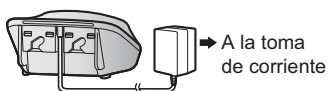

Cómo conectar el cable de la línea telefónica

- Para conectarlo a una toma telefónica para 2 líneas

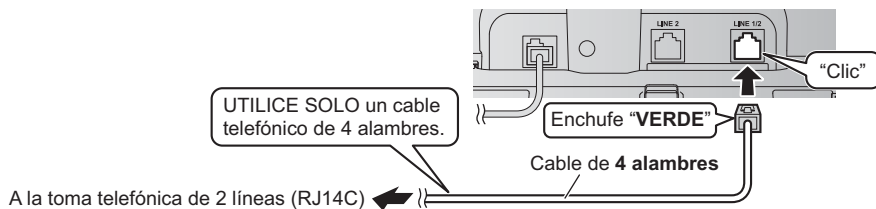

Cómo conectar el cable de la línea telefónica

- Para conectarlo a 2 tomas telefónicas de una sola línea

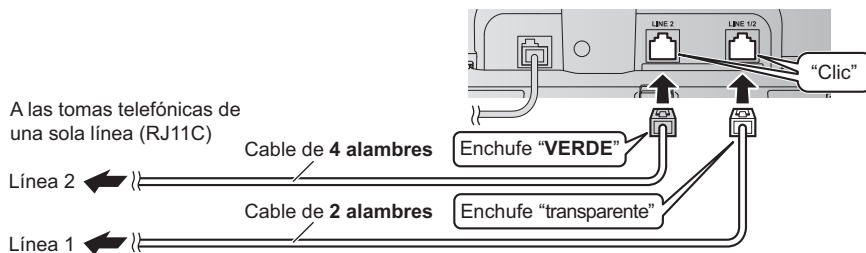

Si está suscrito a un servicio de DSL/ADSL, añada un filtro de DSL/ADSL a la línea telefónica entre la unidad base y la toma de la línea telefónica. Consulte las instrucciones de operación para ver las conexiones.

Instalación y carga de la batería

Cargue aproximadamente durante 7 horas.

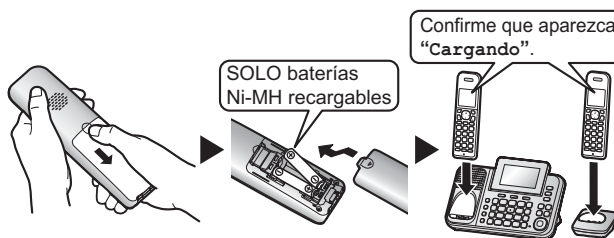

Nota:

- UTILICE SOLO baterías de Ni-MH tamaño AAA (R03).
- NO utilice baterías Alcalinas, de Manganeseo o de Ni-Cd.
- Confirme que las polaridades estén correctas (+, -).

Cómo usar la unidad solo como teléfono de una sola línea

Conecte el cable de la línea telefónica a LINE (LÍNEA) 1/2.

Auricular/Unidad base:

- Para usar solo la línea 1: [MENU]#250 → [↕]: "Línea1" → [SAVE] → [OFF]/[EXIT]
- Para borrar el mensaje "Verif. Línea 2": [MENU]#190

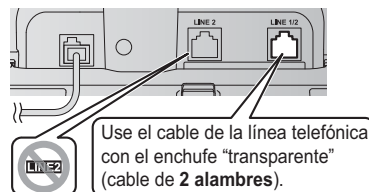



Sugerencias de operación

Teclas de función

Al oprimir una tecla de función, puede seleccionar la función que aparece directamente encima de ella en la pantalla. Preste atención a la pantalla para ver qué funciones están asignadas a las teclas de función durante la operación.

Tecla navegadora

Auricular:

- [▲], [▼], [◀], o [▶]: Navegue por diversas listas y elementos.
-  (Volumen: [▲] o [▼]): Ajuste el volumen del receptor o el altavoz mientras habla.
- [◀] : Ver la entrada del directorio telefónico.
- [▶] REDIAL (Remarcación): Vea la lista de remarcación.
- [▼] CID (identificador de llamadas): Vea la lista de personas que llamaron.

Unidad base:

- [▲], [▼], [◀◀] o [▶▶]: Navegue por diversas listas y elementos.
- VOL. (Volumen: [▲] o [▼]): Ajuste el volumen del altavoz mientras habla.
- [◀◀]/[▶▶]: Repetir u omitir mensajes durante la reproducción.

Auricular

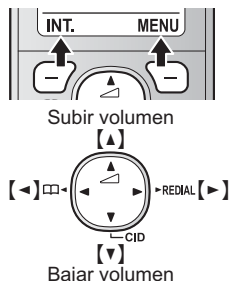

Unidad base

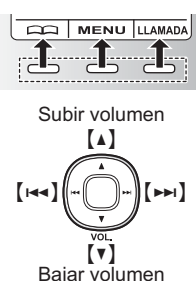

Cambio de idiomas (predeterminado: “English”) (Auricular/Unidad base)

Cuando instale las baterías por primera vez, es posible que aparezca “Date and time Press SELECT”. Oprima [OFF]/[EXIT] para salir.

Idioma de la pantalla

- 1 [MENU]#110 → [↕]: “Español” → [GUARDA]
- 2 Continúe operando su unidad.
Auricular: [OFF]
Unidad base: [EXIT]

Idioma de la guía de voz

- 1 [MENU]#112 → [↕]: “Español” → [GUARDA]
- 2 Continúe operando su unidad.
Auricular: [OFF]
Unidad base: [EXIT]

Fecha y hora (Auricular/Unidad base)

- 1 [MENU]#101
- 2 Introduzca el día, mes y año actuales. → [OK]
- 3 Introduzca la hora y minuto actuales (formato de reloj de 24 horas).
- 4 [GUARDA]
- 5 Continúe operando su unidad.
Auricular: [OFF]
Unidad base: [EXIT]

Cómo grabar el mensaje de saludo del contestador de llamadas para la línea terrestre (Auricular/Unidad base)

Si utiliza un mensaje de saludo pregrabado, no es necesario que grabe su propio mensaje de saludo.

1 Para la línea 1: **[MENU]#3021**

Para la línea 2: **[MENU]#3022**

2 (↓): Seleccione el mensaje de saludo deseado. → **[SELEC.]**

3 (↓): “sí” → **[SELEC.]**

4 Después de que se emita un pitido, sostenga el auricular a una distancia aproximada de 20 cm (8 pulgadas) y hable con claridad en el micrófono (máx. de 2 minutos).

5 Oprima **[ALTO]** para dejar de grabar.

6 Continúe operando su unidad.

Auricular: [OFF]

Unidad base: [EXIT]

Enlace a celular

Puede usar la unidad para hacer o contestar llamadas usando una línea de teléfono celular. Sus teléfonos celulares deben tener tecnología inalámbrica Bluetooth® que sea compatible con este producto. Para obtener más detalles, visite nuestro sitio web: <http://www.panasonic.com/link2cell>

- Coloque su teléfono celular cerca de la unidad base. Si su teléfono celular está demasiado cerca de la unidad base durante la llamada celular, es posible que escuche ruido. Para un mejor funcionamiento, le recomendamos que coloque su teléfono celular de 0.6 m a 3 m (2 pies a 10 pies) de la unidad base.

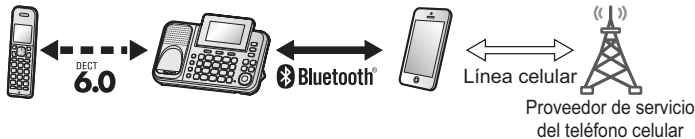

Cómo emparejar un teléfono celular con Bluetooth (Auricular/Unidad base)

1 Para CELL 1: **[MENU]#6241**

Para CELL 2: **[MENU]#6242**

Para CELL 3: **[MENU]#6243**

Para CELL 4: **[MENU]#6244**

- Después de que el indicador de CELL correspondiente comienza a parpadear en la unidad base, el resto del procedimiento debe completarse en menos de 5 minutos.

2 Su teléfono celular:

Aunque el indicador de CELL esté parpadearando, siga las instrucciones de su teléfono celular para entrar al modo de emparejamiento.

- Dependiendo de su teléfono celular, es posible que le pida que introduzca el NIP de la unidad base (predeterminado: “0000”).

3 Espere a que se emita un pitido largo.

- Es posible que tarde más de 10 segundos en completar el emparejamiento.
- Cuando el indicador de CELL se ilumina, esto significa que el teléfono celular está conectado a la unidad base. Ya está listo para hacer llamadas regulares de celular.

4 Continúe operando su unidad.

Auricular: [OFF]

Unidad base: [EXIT]

Nota:

- Asegúrese de que su teléfono celular está configurado para conectarse a este producto automáticamente. Consulte las instrucciones de operación de su teléfono celular.

Marcas registradas



- La marca denominativa y los logotipos de Bluetooth® son propiedad de Bluetooth SIG, Inc. y cualquier uso de dichas marcas por parte de Panasonic Corporation se hace bajo licencia. Todas las demás marcas comerciales que se identifican en el presente pertenecen a sus respectivos propietarios.

Enlace a celular

Unidad base: Indicadores de CELL

Estado	Significado
Encendido	Un teléfono celular está conectado. Listo para hacer o recibir llamadas celulares.
Parpadeando	<ul style="list-style-type: none"> - La línea del celular se está usando. - Las entradas del directorio telefónico se están copiando desde un teléfono celular. - La unidad base está buscando el teléfono celular emparejado. - Una llamada de celular se pone en espera.
Parpadea rápidamente	Se está recibiendo una llamada de celular.
Luz apagada	<ul style="list-style-type: none"> - No hay un teléfono celular emparejado con la unidad base. - No hay un teléfono celular conectado a la unidad base.

Auricular: enlace a elementos de la pantalla del celular

	<p>Se está usando una línea de celular.</p> <ul style="list-style-type: none"> ● Cuando parpadea: la llamada celular se pone en espera. ● Cuando parpadea rápidamente: se está recibiendo una llamada celular.
	<p>Un teléfono celular está conectado.*1 Listo para hacer o recibir llamadas celulares.</p> <ul style="list-style-type: none"> ● Cuando está apagado: no hay un teléfono celular conectado a la unidad base. <p>*1 La línea o líneas celulares correspondientes se indican enseguida del elemento.</p>
	Está recibiendo una llamada de celular en esa línea.

Cómo conectar o desconectar el teléfono celular (Auricular/Unidad base)

Conexión automática al teléfono celular

La unidad se conecta al teléfono celular a intervalos regulares si se pierde la conexión. Consulte las instrucciones de operación para cambiar el intervalo (predeterminado: "1 min").

- Cuando está usando una línea celular o un audífono con Bluetooth, la unidad base pierde la conexión de otros dispositivos con Bluetooth (teléfono celular o audífono). Para restablecer la conexión a los teléfonos celulares automáticamente, deje encendida la conexión automática.

Cómo conectar o desconectar manualmente el teléfono celular

Si no va a utilizar el vínculo del teléfono celular emparejado a la función del celular temporalmente (por ejemplo, si no quiere que la unidad timbre cuando su línea celular reciba una llamada), puede desconectar su teléfono celular de la unidad base. Si desea usarlo de nuevo, reconecte el teléfono celular a la unidad base.

- Aunque haya desconectado un teléfono celular emparejado de la unidad base, si lo coloca dentro del alcance de la unidad base durante el intervalo de conexión automática, es posible que se conecte automáticamente a la unidad base.
- Los teléfonos celulares desconectados no se desemparejan de la unidad base, así que no es necesario emparejarlos de nuevo con ella.

1 Para conectarlo o desconectarlo:

Para CELL 1: **[MENU]** **#** **6** **2** **5** **1** (suena un pitido largo).

Para CELL 2: **[MENU]** **#** **6** **2** **5** **2** (suena un pitido largo).

Para CELL 3: **[MENU]** **#** **6** **2** **5** **3** (suena un pitido largo).

Para CELL 4: **[MENU]** **#** **6** **2** **5** **4** (suena un pitido largo).

2 Continúe operando su unidad.

Auricular: **[OFF]**

Unidad base: **[EXIT]**

Operaciones básicas	
Cómo hacer y contestar llamadas (Auricular)	
Para hacer llamadas de celular	1 Marque el número telefónico. → [CELL] <ul style="list-style-type: none"> • Cuando solo hay 1 teléfono celular emparejado, la unidad comienza a marcar. 2 Cuando hay 2 o más teléfonos celulares emparejados: [↵] : Seleccione el teléfono celular deseado. → [SELEC.]
Para hacer llamadas por la línea terrestre	Marque el número telefónico. → [↵]/[☎]
Para contestar llamadas	[↵]/[☎]
Para colgar	[OFF]
Para ajustar el volumen del receptor o del altavoz	Oprima [▲] o [▼] repetidamente mientras habla.
Cómo hacer una llamada usando la lista de remarcación	1 [▶] REDIAL → [↵] : Seleccione el número telefónico deseado. 2 Para hacer una llamada celular: Cuando solo 1 teléfono celular está emparejado: [CELL] o Cuando hay 2 o más teléfonos celulares emparejados: [CELL] → [↵] : Seleccione el teléfono celular deseado. → [SELEC.] Para hacer una llamada terrestre: [↵]
Cómo hacer y contestar llamadas (Unidad base)	
Para hacer llamadas de celular	Marque el número telefónico. → Oprima la tecla de la línea celular deseada ([CELL 1] a [CELL 4]).
Para hacer llamadas por la línea terrestre	Marque el número telefónico. → [☎]
Para contestar llamadas	[☎]
Para colgar	[☎]
Para ajustar el volumen del altavoz	Oprima [▲] o [▼] repetidamente mientras habla.
Cómo hacer una llamada usando la lista de remarcación	1 [REDIAL] → [↵] : Seleccione el número telefónico deseado. 2 Para hacer una llamada celular: Oprima la tecla de la línea celular deseada ([CELL 1] a [CELL 4]). Para hacer una llamada terrestre: [☎]
Para ajustar el volumen del timbre (Auricular/Unidad base)	
Para ajustar el volumen del timbre del auricular (línea de celular/línea terrestre)	Oprima [▲] o [▼] repetidamente para seleccionar el volumen deseado mientras timbra.

Operaciones básicas	
Directorio telefónico (Auricular)	
Para añadir entradas	<ol style="list-style-type: none"> 1 [] [] → [MENU] 2 []: "Agregar Ent. Nueva" → [SELEC.] 3 Introduzca el nombre de la persona (máx. 16 caracteres). → [OK] 4 Introduzca el número telefónico de la persona (máx. 24 dígitos). → [OK] 5 []: Seleccione el grupo deseado. → [SELEC.] 2 veces → [OFF]
Para hacer llamadas	<ol style="list-style-type: none"> 1 [] [] → []: Seleccione la entrada deseada. 2 Para hacer una llamada celular: Cuando solo 1 teléfono celular está emparejado: [CELL] o Cuando hay 2 o más teléfonos celulares emparejados: [CELL] → []: Seleccione el teléfono celular deseado. → [SELEC.] Para hacer una llamada terrestre: []
Directorio telefónico (Unidad base)	
Para añadir entradas	<ol style="list-style-type: none"> 1 [] → [MENU] 2 []: "Agregar Ent. Nueva" → [SELEC.] 3 Introduzca el nombre de la persona (máx. 16 caracteres). → [OK] 4 Introduzca el número telefónico de la persona (máx. 24 dígitos). → [OK] 5 []: Seleccione el grupo deseado. → [SELEC.] 2 veces → [EXIT]
Para hacer llamadas	<ol style="list-style-type: none"> 1 [] → []: Seleccione la entrada deseada. 2 Para hacer una llamada celular: Oprima la tecla de la línea celular deseada ([CELL 1] a [CELL 4]). Para hacer una llamada terrestre: []
Contestador de llamadas de la línea terrestre (unidad base)	
Contestador encendido/apagado	Para encenderlo/apagarlo: Para la línea 1: Oprima [L1](ANSWER ON/OFF) Para la línea 2: Oprima [L2](ANSWER ON/OFF)
Para escuchar mensajes	Para la línea 1: Oprima [] (PLAY1). Para la línea 2: Oprima [] (PLAY2).
Contestador de llamadas de la línea terrestre (auricular)	
Para escuchar mensajes	Para escuchar mensajes nuevos: Para la línea 1: [MENU]#3231 Para la línea 2: [MENU]#3232 Para escuchar todos los mensajes: Para la línea 1: [MENU]#3241 Para la línea 2: [MENU]#3242

Cómo usar dispositivos Bluetooth**Copiado de entradas del directorio telefónico desde un teléfono celular con Bluetooth (transferencia del directorio telefónico)
(Auricular/Unidad base)**

Puede copiar entradas del directorio telefónico desde los teléfonos celulares emparejados o desde otros teléfonos celulares (no emparejados) al directorio telefónico compartido de la unidad.

1 [MENU]#[6][1][8]

2 Para copiar desde teléfonos celulares emparejados:

[↕]: Seleccione el teléfono celular deseado. → [SELEC.]

- Los elementos copiados se almacenan en el grupo ("Ce1. 1" a "Ce1. 4") en el que está emparejado el teléfono celular.

Para copiar desde otros teléfonos celulares (no emparejados):

[↕]: "Otro celular" → [SELEC.] → [↕]: Seleccione el grupo al que desea copiar. → [SELEC.]

3 Cuando aparezca "Transf. datos del directorio del celular": Vaya al paso 4.

Cuando aparezca el menú "Selec. modo":

[↕]: Seleccione "Auto" o "Manual". → [SELEC.]

"Auto": Descargue todas las entradas del teléfono celular automáticamente. Vaya al paso 5.

"Manual": Copie las entradas que seleccionó.

- El menú "Selec. modo" aparece solo cuando el teléfono celular soporta PBAP (Perfil de Acceso a Directorio Telefónico) para la conexión Bluetooth.
- Algunos teléfonos celulares pueden requerir la operación aunque seleccione "Auto".

4 Teléfono celular:

Siga las instrucciones de su teléfono celular para copiar las entradas del directorio telefónico.

- Para otros teléfonos celulares (no emparejados), necesita buscar y seleccionar la unidad base. Es posible que requiera el NIP (predeterminado: "0000") de la unidad base.
- Las entradas que se están copiando aparecen en el auricular.

5 Espere a que aparezca "Completo".

6 Continúe operando su unidad.

Auricular: [OFF]

Unidad base: [EXIT]

Cómo usar dispositivos Bluetooth

Cómo usar un audífono Bluetooth (opcional) para llamadas por la línea terrestre

Al emparejar un audífono Bluetooth con la unidad base, podrá tener conversaciones inalámbricas a manos libres para llamadas terrestres.

- La conexión del audífono con Bluetooth no está disponible mientras alguien se encuentra usando la línea celular.

Cómo emparejar un audífono con la unidad base (Auricular/ Unidad base)

1 Su audífono:

- Configure su audífono en modo de emparejamiento.
- Consulte las instrucciones de operación de su audífono.

2 [MENU]#621



3 Si el NIP de su audífono es "0000", vaya al paso 4.

Si el NIP de su audífono es diferente a "0000", oprima [CLEAR] y después introduzca el NIP de su audífono.

- Por lo general, el NIP predeterminado es "0000". Consulte las instrucciones de operación del audífono.

4 Oprima [OK], y después espere a que se emita un pitido largo. → [OFF]

- Cuando aparezca el indicador HEADSET (AUDÍFONO) en la unidad base, el audífono estará listo para usarse.

Cómo operar un audífono inalámbrico con Bluetooth usando una línea terrestre (Unidad base)

Consulte las instrucciones de operación de su audífono para ver cómo funciona.

■ Cómo contestar llamadas de la línea terrestre con su audífono

Para contestar una llamada de línea terrestre, encienda su audífono. Para ello, consulte las instrucciones de operación de su audífono.

Cuando termine de hablar, apague su audífono. Para ello, consulte las instrucciones de operación de su audífono.

- Si no puede colgar la llamada usando su auricular, oprima [📞] 2 veces en la unidad base.

■ Cómo cambiar entre la unidad base y su audífono

Puede cambiar entre la unidad base y su audífono:

- durante una llamada por una línea terrestre con el altavoz de la unidad base.
- durante una llamada de intercomunicador entre la unidad base y el auricular.
- mientras escucha los mensajes grabados en el contestador de llamadas de la unidad base.

■ Para cambiar a su audífono:

Oprima [HEADSET] en la unidad base.

■ Para cambiar a la unidad base:

Oprima [📞] en la unidad base.

Preguntas frecuentes	
Pregunta	Causa y solución
¿Por qué aparece  ?	<ul style="list-style-type: none"> ● El auricular está demasiado lejos de la unidad base. Acérquelo. ● El adaptador para corriente de la unidad base no está conectado correctamente. Conecte de nuevo el adaptador para corriente a la unidad base. ● El auricular no está registrado en la unidad base. Regístrelo. <ol style="list-style-type: none"> 1 Auricular: [MENU]#[1][3][0] 2 Unidad base: Oprima y mantenga oprimido [LOCATOR] durante aproximadamente 5 segundos hasta que suene el tono de registro. 3 Auricular: Oprima [OK], y después espere hasta que suene un pitido largo.
¿Por qué no es posible emparejar un teléfono celular con la unidad base?	<ul style="list-style-type: none"> ● Dependiendo de la compatibilidad del teléfono celular, es posible que no pueda emparejarlo con la unidad base. Para obtener más información, visite http://www.panasonic.com/link2cell ● Confirme que la función de Bluetooth de su teléfono celular esté encendida. Es posible que necesite encender esta función dependiendo de su teléfono celular.
¿Por qué no se escucha el tono de marcación? (línea celular)	<ul style="list-style-type: none"> ● Asegúrese de que el indicador de CELL se ilumine y de que el teléfono celular esté conectado a la unidad base. ● El teléfono celular no se ha emparejado con la unidad base. Empareje el teléfono celular.
¿Cómo se incrementa el nivel de volumen del auricular?	<ul style="list-style-type: none"> ● Oprima la tecla de navegación [▲] repetidamente mientras habla.
¿Por qué hay ruido o se corta la conversación?	<ul style="list-style-type: none"> ● Trate de reubicar la unidad base de forma que se minimice la distancia al auricular. ● Si ocurre el mismo problema aunque el auricular se encuentre enseguida de la unidad base, llame a servicio a clientes de Panasonic al 1-800-211-PANA (1-800-211-7262).
¿Es posible añadir otro auricular accesorio a mi unidad base?	<ul style="list-style-type: none"> ● Sí, puede añadir hasta 6 auriculares (incluyendo los que se venden con su unidad base) a una sola unidad base. ● Para adquirir auriculares accesorios adicionales (KX-TGA950), visite: http://www.pstc.panasonic.com o llame al 1-800-332-5368. Los usuarios TTY (usuarios con impedimentos auditivos o del habla) pueden llamar al 1-866-605-1277.
¿Es posible mantener cargando las baterías todo el tiempo?	<ul style="list-style-type: none"> ● Puede dejar el auricular en la unidad base o el cargador en cualquier momento. Esto no daña las baterías.
¿Cómo se contestan las llamadas en espera (segunda llamada)?	<ul style="list-style-type: none"> ● Oprima [CALL WAIT] cuando escuche el tono de llamada en espera.

Para obtener más información acerca del registro, visite <http://www.panasonic.com/RegisterYourHandset>

Customer services

Customer Services Directory (United States and Puerto Rico)

Obtain Product Information and Operating Assistance; locate your nearest Dealer or Service Center; purchase Parts and Accessories; or make Customer Service and Literature requests by visiting our Web Site at:

<http://www.panasonic.com/help>

or, contact us via the web at:

<http://www.panasonic.com/contactinfo>

You may also contact us directly at: 1-800-211-PANA (1-800-211-7262),
Monday - Friday 9 am to 9 pm; Saturday - Sunday 10 am to 7 pm, EST.

TTY users (hearing or speech impaired users) can call 1-877-833-8855.

Accessory Purchases (United States and Puerto Rico)

Purchase Parts, Accessories and Instruction Books online for all Panasonic Products by visiting our Web Site at:

<http://www.pstc.panasonic.com>

or, send your request by E-mail to:

npcparts@us.panasonic.com

You may also contact us directly at:

1-800-332-5368 (Phone) 1-800-237-9080 (Fax Only)

(Monday - Friday 9 am to 9 pm, EST.)

Panasonic Service and Technology Company

20421 84th Avenue South, Kent, WA 98032

(We Accept Visa, MasterCard, Discover Card, American Express, and Personal Checks.)

TTY users (hearing or speech impaired users) can call 1-866-605-1277.

Warranty (For United States and Puerto Rico)

PANASONIC CORPORATION OF NORTH AMERICA
One Panasonic Way, Secaucus, New Jersey 07094

Panasonic Telephone Products Limited Warranty

Limited Warranty Coverage

If your product does not work properly because of a defect in materials or workmanship, Panasonic Corporation of North America (referred to as "the warrantor") will, for the length of the period indicated on the chart below, which starts with the date of original purchase ("Limited Warranty period"), at its option either (a) repair your product with new or refurbished parts, or (b) replace it with a new or a refurbished product. The decision to repair or replace will be made by the warrantor.

Parts	Labor
One (1) Year	One (1) Year

During the "Labor" Limited Warranty period there will be no charge for labor. During the "Parts" Limited Warranty period, there will be no charge for parts. You must mail-in your product prepaid during the Limited Warranty period. This Limited Warranty excludes both parts and labor for batteries, antennas, and cosmetic parts (cabinet). This Limited Warranty only applies to products purchased and serviced in the United States or Puerto Rico. This Limited Warranty is extended only to the original purchaser and only covers products purchased as new.

Ship-In Service

For assistance in the continental United States and Puerto Rico in obtaining repairs please ship the product prepaid to:

Panasonic Exchange Center,
4900 George McVay Drive, Suite B Door #12, McAllen, TX 78503
panacare@us.panasonic.com

Online Repair Request

To submit a new repair and for quick repair status visit our web site at
<http://www.panasonic.com/help>

When shipping the unit carefully pack in a padded shipping carton, include all accessories, and send it prepaid. Include a letter detailing the complaint, a return address and provide a day time phone number where you can be reached. P.O. Boxes are not acceptable. Keep the tracking number for your records. A copy of valid registered receipt is required under the 1 year parts and labor Limited Warranty.

For Limited Warranty service for headsets if a headset is included with this product please follow instructions above.

IF REPAIR IS NEEDED DURING THE LIMITED WARRANTY PERIOD THE PURCHASER WILL BE REQUIRED TO FURNISH A SALES RECEIPT/PROOF OF PURCHASE INDICATING DATE OF PURCHASE, AMOUNT PAID AND PLACE OF PURCHASE. CUSTOMER WILL BE CHARGED FOR THE REPAIR OF ANY UNIT RECEIVED WITHOUT SUCH PROOF OF PURCHASE.

Limited Warranty Limits And Exclusions

This Limited Warranty ONLY COVERS failures due to defects in materials or workmanship, and DOES NOT COVER normal wear and tear or cosmetic damage. The Limited Warranty ALSO DOES NOT COVER damages which occurred in shipment, or failures which are caused by products not supplied by the warrantor, or failures which result from accidents, misuse, abuse, neglect, bug infestation, mishandling, misapplication, alteration, faulty installation, set-up adjustments, misadjustment of consumer controls, improper maintenance, power line surge, lightning damage, modification, introduction of sand, humidity or liquids, commercial use such as hotel, office, restaurant, or other business or rental use of the product, or service by anyone other than a Factory Service Center or other Authorized Servicer, or damage that is attributable to acts of God.

THERE ARE NO EXPRESS WARRANTIES EXCEPT AS LISTED UNDER "LIMITED WARRANTY COVERAGE". THE WARRANTOR IS NOT LIABLE FOR INCIDENTAL OR CONSEQUENTIAL DAMAGES RESULTING FROM THE USE OF THIS PRODUCT, OR ARISING OUT OF ANY BREACH OF THIS LIMITED WARRANTY. (As examples, this excludes damages for lost time, lost calls or messages, cost of having someone remove or re-install an installed unit if applicable, travel to and from the servicer. The items listed are not exclusive, but are for illustration only.) **ALL EXPRESS AND IMPLIED WARRANTIES, INCLUDING THE WARRANTY OF MERCHANTABILITY, ARE LIMITED TO THE PERIOD OF THE LIMITED WARRANTY.**

Some states do not allow the exclusion or limitation of incidental or consequential damages, or limitations on how long an implied warranty lasts, so the exclusions may not apply to you.

This Limited Warranty gives you specific legal rights and you may also have other rights which vary from state to state. If a problem with this product develops during or after the Limited Warranty period, you may contact your dealer or Service Center. If the problem is not handled to your satisfaction, then write to the warrantor's Consumer Affairs Department at the addresses listed for the warrantor.

PARTS AND SERVICE, WHICH ARE NOT COVERED BY THIS LIMITED WARRANTY, ARE YOUR RESPONSIBILITY.

When you ship the product

- Carefully pack your unit, preferably in the original carton.
- Attach a letter, detailing the symptom.
- Send the unit to Panasonic Exchange Center, prepaid and adequately insured.
- Do not send your unit to Panasonic Corporation of North America listed on the back cover or to executive or regional sales offices. These locations do not repair consumer products.

Index

- # 3-way conference: 24, 28
- A** Additional handset: 46
 - Alarm: 43
 - Answering calls: 23, 27
 - Answering system
 - Call screening: 54
 - Erasing messages: 56, 57, 60
 - Greeting message: 54
 - Greeting only: 61
 - Listening to messages: 56, 59
 - New message alerting: 57
 - Number of rings: 60
 - Recording time: 61
 - Remote access code: 59
 - Remote operation: 59
 - Ring count: 60
 - Toll saver: 60
 - Turning on/off: 54
 - Auto talk: 42
- B** Battery: 11
 - Bluetooth wireless technology
 - Cellular phone (Link to cell): 18
 - Headset: 51
 - Phonebook transfer: 50
 - Booster (Clarity booster): 23
- C** Call block: 44
 - First ring: 45
 - Call share: 24, 28, 42
 - Call waiting: 23, 28
 - Call Waiting Caller ID: 23
 - Caller ID number auto edit: 42, 48
 - Caller ID service: 47
 - Caller list: 47
 - Caller list edit: 48
 - Cellular calls: 22, 27
 - Cellular phone
 - Pairing: 18
 - Unpairing: 18
 - Chain dial: 34
 - Check tel line 2: 10
 - CID (Caller ID): 47, 48
 - Conference calls: 24, 29
 - Control type: 13, 14
 - Customer support: 42
- D** Date and time: 16
 - Dialing mode: 16
 - Direct command code: 37
 - Display
 - Contrast: 42
 - Language: 16
- E** Eco mode: 12
 - Equalizer: 24
 - Error messages: 64
- F** Flash: 23, 28, 42
- G** Groups: 33
- H** Handset
 - Deregistration: 46
 - Name: 46
 - Registration: 46
 - Hold: 23, 28
- I** Intercom: 31
- K** Key detector: 41, 43
 - Key tone: 42
- L** Landline calls: 22, 27
 - Line mode: 42
 - Line selection mode: 16
 - Link to cell
 - Area code: 20
 - Auto connection: 19
 - Cellular line selection: 20
 - Connection: 20
 - Ring as cell mode: 19
 - Select unit to ring: 19
 - Text message (SMS: Short Message Service) alert: 51
- M** Making calls: 22, 27
 - Missed calls: 47
 - Mute: 23, 28
- N** Noise reduction: 24
- P** Pause: 22, 27
 - Phonebook: 32
 - PIN: 21
- R** Redialing: 22, 27
 - Ringer ID: 33
 - Ringer tone: 33, 39, 40
 - Rotary/pulse service: 23
- S** Silent mode: 44
 - Speed dial: 35
 - SP-PHONE (Speakerphone): 22
- T** Talking Caller ID: 47
 - Temporary tone dialing: 23, 28
 - Time adjustment: 41
 - Transferring calls: 24, 29
 - Troubleshooting: 65
 - TTY: 83
- U** USB charging: 14
- V** Voice guidance language: 16
 - Voice mail: 60, 62
 - Volume
 - Receiver: 22
 - Ringer (Base unit): 28, 39, 40
 - Ringer (Handset): 23, 39, 40

Speaker: 22, 27

W Wall mounting: 62

IMPORTANT!

If your product is not working properly. . .

- ① **Reconnect AC adaptor to the base unit.**
- ② **Check if telephone line cord is connected.**
- ③ **Use rechargeable Ni-MH batteries.**
(Alkaline/Manganese/Ni-Cd batteries CANNOT be used.)
- ④ **Read troubleshooting page in the Operating Instructions.**



Visit our Web site: <http://www.panasonic.com/help>

- **FAQ and troubleshooting hints are available.**

For your future reference

We recommend keeping a record of the following information to assist with any repair under warranty.

Serial No.	Date of purchase
(found on the bottom of the base unit)	
Name and address of dealer	

Attach your purchase receipt here.

Panasonic Corporation of North America
One Panasonic Way, Secaucus, New Jersey 07094

© Panasonic System Networks Co., Ltd. 2013

Printed in China



PNQX6073ZA

PNQX6073ZA TT0613MU0 (E)