

Panasonic®

Operating Instructions

Expandable Digital Cordless Phone

Model No. **KX-TG6511**
KX-TG6512
KX-TG6513

Expandable Digital Cordless Answering System

Model No. **KX-TG6522**
KX-TG6523
KX-TG6524
KX-TG6525
KX-TG6572
KX-TG6531
KX-TG6532
KX-TG6533
KX-TG6534
KX-TG6541
KX-TG6542
KX-TG6543
KX-TG6544
KX-TG6545

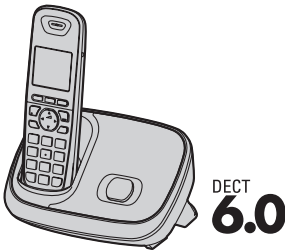

Model shown is KX-TG6511.

Before initial use, see “Getting Started” on page 10.

Thank you for purchasing a Panasonic product.

Please read these operating instructions before using the unit and save them for future reference.

Consulte “Guía Rápida Española”, página 56.

This unit is compatible with Caller ID. You must subscribe to the appropriate service offered by your service provider/telephone company.

For assistance, visit our Web site: <http://www.panasonic.com/help> for customers in the U.S.A. or Puerto Rico.

Please register your product: <http://www.panasonic.com/prodreg>

Table of Contents

Introduction

Model composition	3
Accessory information	4

Important Information

For your safety	7
Important safety instructions	8
For best performance	8
Other information	9
Specifications	9

Getting Started

Setting up	10
Note when setting up	11
Intelligent eco mode	11
Controls	12
Belt clip	14
Display	14
Initial settings	14

Making/Answering Calls

Making calls	16
Answering calls	17
Useful features during a call	18

Shared Phonebook

Shared phonebook	20
----------------------------	----

Programming

Programmable settings	23
Special programming	29
Registering a unit	31

Caller ID Service

Using Caller ID service	33
Caller list	34

Answering System

Answering system	36
Turning the answering system on/off	36
Greeting message	37
Listening to messages using the base unit	37
Listening to messages using the handset	38
Voice memo	39
Remote operation	39
Answering system settings	41

Voice Mail Service

Voice mail service	43
------------------------------	----

Intercom/Locator

Intercom	45
Handset locator	45
Transferring calls, conference calls	46

Useful Information

Wall mounting	47
Error messages	48
Troubleshooting	49
FCC and other information	54

Guía Rápida Española

Guía Rápida Española	56
--------------------------------	----

Appendix

Customer services	60
Warranty (For United States and Puerto Rico)	61

Index

Index	63
-----------------	----

Model composition

■ KX-TG6511 series



- Model shown is KX-TG6512.

■ KX-TG6521/ KX-TG6531 series



- Model shown is KX-TG6522.

■ KX-TG6541 series



- Model shown is KX-TG6542.

Series	Model No.	Base unit	Handset	
		Part No.	Part No.	Quantity
KX-TG6511 series	KX-TG6511	KX-TG6511	KX-TGA652	1
	KX-TG6512	KX-TG6511	KX-TGA652	2
	KX-TG6513	KX-TG6511	KX-TGA652	3
KX-TG6521 series	KX-TG6522	KX-TG6531	KX-TGA653	2
	KX-TG6523	KX-TG6531	KX-TGA653	3
	KX-TG6524	KX-TG6531	KX-TGA653	4
	KX-TG6525	KX-TG6531	KX-TGA653	5
	KX-TG6572	KX-TG6521	KX-TGA653	2
KX-TG6531 series	KX-TG6531	KX-TG6531	KX-TGA652	1
	KX-TG6532	KX-TG6531	KX-TGA652	2
	KX-TG6533	KX-TG6531	KX-TGA652	3
	KX-TG6534	KX-TG6531	KX-TGA652	4
KX-TG6541 series	KX-TG6541	KX-TG6541	KX-TGA652	1
	KX-TG6542	KX-TG6541	KX-TGA652	2
	KX-TG6543	KX-TG6541	KX-TGA652	3
	KX-TG6544	KX-TG6541	KX-TGA652	4
	KX-TG6545	KX-TG6541	KX-TGA652	5

Introduction

Feature differences

Series	Answering system	Talking Caller ID	Headset jack	Call with base unit ^{*1}	Intercom ^{*2}
					 ^{*3}
KX-TG6511 series	–	–	●	–	–
KX-TG6521 series	●	●	–	–	–
KX-TG6531 series	●	●	●	–	–
KX-TG6541 series	●	●	●	●	●

*1 Calls can be made or answered with the base unit.

*2 Single handset models: Intercom calls can be made between handsets by purchasing and registering one or more optional handsets (page 6).

*3 Intercom calls can be made between the base unit and handset.

ENERGY STAR

As an ENERGY STAR[®] Partner, Panasonic has determined that this product meets the ENERGY STAR guidelines for energy efficiency. ENERGY STAR is a U.S. registered mark.



Accessory information

Supplied accessories

No.	Supplied handset qty.	1 unit ^{*1}	2 unit ^{*2}	3 unit ^{*3}	4 unit ^{*4}	5 unit ^{*5}
	Accessory item/ Order number	Accessory quantity				
①	AC adaptor/PQLV219Y	1	2	3	4	5
②	Telephone line cord/ PQJA10075Z	1	1	1	1	1

No.	Supplied handset qty.	1 unit ^{*1}	2 unit ^{*2}	3 unit ^{*3}	4 unit ^{*4}	5 unit ^{*5}
	Accessory item/ Order number	Accessory quantity				
③	Rechargeable batteries/ HHR-4DPA (Part No. HHR-55AAABU or N4DHYYY00004)	2	4	6	8	10
④	Handset cover ^{*6} / PNYNTGA652BR	1	2	3	4	5
⑤	Belt clip/PNKE1054Z1	1	2	3	4	5
⑥	Charger ^{*7}	–	1	2	3	4

*1 KX-TG6511/KX-TG6531/KX-TG6541

*2 KX-TG6512/KX-TG6522/KX-TG6572/KX-TG6532/KX-TG6542

*3 KX-TG6513/KX-TG6523/KX-TG6533/KX-TG6543

*4 KX-TG6524/KX-TG6534/KX-TG6544

*5 KX-TG6525/KX-TG6545

*6 The handset cover comes attached to the handset.

*7 PNLC1010ZB: Black, PNLC1010YR: Wine red, PNLC1010YC: Dark blue metallic

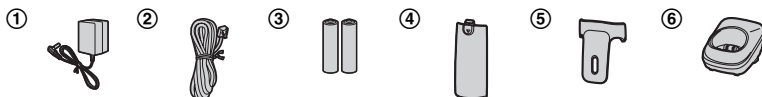

Additional/replacement accessories

Please contact your nearest Panasonic dealer for sales information (page 60).

Accessory item	Order number
Rechargeable batteries	HHR-4DPA ^{*1} ● To order, please call 1-800-332-5368 or visit http://www.panasonic.com/batterystore
	Battery type: – Nickel metal hydride (Ni-MH) – 2 x AAA (R03) size for each handset
Headset	KX-TCA60, KX-TCA93, KX-TCA94, KX-TCA400, KX-TCA430
T-adaptor	KX-J66
Battery back-up power supply	KX-TCA230



*1 Replacement batteries may have a different capacity from that of the supplied batteries.

Expanding your phone system

Optional handset feature overview

You can expand your phone system by registering optional handsets (6 max.) to a single base unit.

- Optional handsets may be a different color from that of the supplied handsets.

Feature	KX-TGA651	KX-TGA401	KX-TGA750
Handset			
Display size	1.8 inches	1.8 inches	2.1 inches
Button size	Large	Extra large	Large
Display mode ^{*1}	–	–	●
Message list ^{*2}	–	–	●

*1 This feature allows you to select how the display shows:

- multiple items at a time
- 1 item at a time in large characters

*2 The unit displays a list of all recorded messages and allows you to select the item to play back.

Range extender

By installing this unit, you can extend the range of your phone system to include areas where reception was previously not available. Up to 2 range extenders can be registered to the base unit. This product can be purchased online. Please visit our Web site:

<http://www.panasonic.com/RangeExtender>

Range extender: KX-TGA405

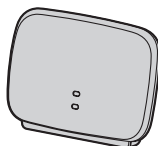

For your safety

To prevent severe injury and loss of life/property, read this section carefully before using the product to ensure proper and safe operation of your product.

WARNING

Power connection

- Use only the power source marked on the product.
- Do not overload power outlets and extension cords. This can result in the risk of fire or electric shock.
- Completely insert the AC adaptor/power plug into the power outlet. Failure to do so may cause electric shock and/or excessive heat resulting in a fire.
- Regularly remove any dust, etc. from the AC adaptor/power plug by pulling it from the power outlet, then wiping with a dry cloth. Accumulated dust may cause an insulation defect from moisture, etc. resulting in a fire.
- Unplug the product from power outlets if it emits smoke, an abnormal smell, or makes an unusual noise. These conditions can cause fire or electric shock. Confirm that smoke has stopped emitting and contact the Panasonic Call Center at 1-800-211-PANA (1-800-211-7262).
- Unplug from power outlets and never touch the inside of the product if its casing has been broken open.
- Never touch the plug with wet hands. Danger of electric shock exists.

Installation

- To prevent the risk of fire or electrical shock, do not expose the product to rain or any type of moisture.
- Do not place or use this product near automatically controlled devices such as automatic doors and fire alarms. Radio waves emitted from this product may cause such devices to malfunction resulting in an accident.
- Do not allow the AC adaptor or telephone line cord to be excessively pulled, bent or placed under heavy objects.

Operating safeguards

- Unplug the product from power outlets before cleaning. Do not use liquid or aerosol cleaners.
- Do not disassemble the product.
- Do not spill liquids (detergents, cleansers, etc.) onto the telephone line cord plug, or allow it to become wet at all. This may cause a fire. If the telephone line cord plug becomes wet, immediately pull it from the telephone wall jack, and do not use.

Medical

- Consult the manufacturer of any personal medical devices, such as pacemakers or hearing aids, to determine if they are adequately shielded from external RF (radio frequency) energy. (The product operates in the frequency range of 1.92 GHz to 1.93 GHz, and the RF transmission power is 115 mW (max.))
- Do not use the product in health care facilities if any regulations posted in the area instruct you not to do so. Hospitals or health care facilities may be using equipment that could be sensitive to external RF energy.

CAUTION

Installation and location

- Never install telephone wiring during an electrical storm.
- Never install telephone line jacks in wet locations unless the jack is specifically designed for wet locations.
- Never touch uninsulated telephone wires or terminals unless the telephone line has been disconnected at the network interface.
- Use caution when installing or modifying telephone lines.
- The AC adaptor is used as the main disconnect device. Ensure that the AC outlet is installed near the product and is easily accessible.
- This product is unable to make calls when:
 - the handset batteries need recharging or have failed.
 - there is a power failure.

Important Information

Battery

- We recommend using the batteries noted on page 5. **USE ONLY rechargeable Ni-MH batteries AAA (R03) size.**
- Do not mix old and new batteries.
- Do not open or mutilate the batteries. Released electrolyte from the batteries is corrosive and may cause burns or injury to the eyes or skin. The electrolyte is toxic and may be harmful if swallowed.
- Exercise care when handling the batteries. Do not allow conductive materials such as rings, bracelets, or keys to touch the batteries, otherwise a short circuit may cause the batteries and/or the conductive material to overheat and cause burns.
- Charge the batteries provided with or identified for use with this product only, in accordance with the instructions and limitations specified in this manual.
- Only use a compatible base unit (or charger) to charge the batteries. Do not tamper with the base unit (or charger). Failure to follow these instructions may cause the batteries to swell or explode.

Attention:



A nickel metal hydride battery that is recyclable powers the product you have purchased. Please call 1-800-8-BATTERY (1-800-822-8837) for information on how to recycle this battery.

Important safety instructions

When using your product, basic safety precautions should always be followed to reduce the risk of fire, electric shock, and injury to persons, including the following:

1. Do not use this product near water for example, near a bathtub, washbowl,

2. kitchen sink, or laundry tub, in a wet basement or near a swimming pool.
2. Avoid using a telephone (other than a cordless type) during an electrical storm. There may be a remote risk of electric shock from lightning.
3. Do not use the telephone to report a gas leak in the vicinity of the leak.
4. Use only the power cord and batteries indicated in this manual. Do not dispose of batteries in a fire. They may explode. Check with local codes for possible special disposal instructions.

SAVE THESE INSTRUCTIONS

For best performance

Base unit location/avoiding noise

The base unit and other compatible Panasonic units use radio waves to communicate with each other.

- For maximum coverage and noise-free communications, place your base unit:
 - at a convenient, high, and central location with no obstructions between the handset and base unit in an indoor environment.
 - away from electronic appliances such as TVs, radios, personal computers, wireless devices, or other phones.
 - facing away from radio frequency transmitters, such as external antennas of mobile phone cell stations. (Avoid putting the base unit on a bay window or near a window.)
- Coverage and voice quality depends on the local environmental conditions.
- If the reception for a base unit location is not satisfactory, move the base unit to another location for better reception.

Environment

- Keep the product away from electrical noise generating devices, such as fluorescent lamps and motors.
- The product should be kept free from excessive smoke, dust, high temperature, and vibration.
- The product should not be exposed to direct sunlight.
- Do not place heavy objects on top of the product.

- When you leave the product unused for a long period of time, unplug the product from the power outlet.
- The product should be kept away from heat sources such as heaters, kitchen stoves, etc. It should not be placed in rooms where the temperature is less than 0 °C (32 °F) or greater than 40 °C (104 °F). Damp basements should also be avoided.
- The maximum calling distance may be shortened when the product is used in the following places: Near obstacles such as hills, tunnels, underground, near metal objects such as wire fences, etc.
- Operating the product near electrical appliances may cause interference. Move away from the electrical appliances.

Routine care

- **Wipe the outer surface of the product with a soft moist cloth.**
- Do not use benzine, thinner, or any abrasive powder.

Other information

CAUTION: Risk of explosion if battery is replaced by an incorrect type. Dispose of used batteries according to the instructions.

Notice for product disposal, transfer, or return

- This product can store your private/confidential information. To protect your privacy/confidentiality, we recommend that you erase information such as phonebook or caller list entries from the memory before you dispose of, transfer, or return the product.

Notice

- This product is designed for use in the United States of America. Sale or use of this product in other countries may violate local laws.
- Cet appareil est conçu pour être utilisé aux États-Unis d'Amérique. La vente ou l'emploi de cet appareil dans certains autres pays peut constituer une infraction à la législation locale.
- Este producto está diseñado para usarse en

los Estados Unidos de América. La venta o el empleo de este producto en ciertos países puede constituir violación de la legislación local.

- 本產品專為美國使用而設。若在其他國家銷售或使用，可能會違反當地法例。
- この製品は、日本国外での使用を目的として設計されており、日本国内での使用は法律違反となります。従って、当社では日本国内においては原則として修理などのサービスは致しかねます。

Specifications

- **Standard:**
DECT 6.0 (Digital Enhanced Cordless Telecommunications 6.0)
 - **Frequency range:**
1.92 GHz to 1.93 GHz
 - **RF transmission power:**
115 mW (max.)
 - **Power source:**
120 V AC, 60 Hz
 - **Power consumption:**
Base unit^{*1}:
Standby: Approx. 1.0 W
Maximum: Approx. 4.0 W
Base unit^{*2}:
Standby: Approx. 1.1 W
Maximum: Approx. 4.4 W
Charger:
Standby: Approx. 0.1 W
Maximum: Approx. 2.6 W
 - **Operating conditions:**
0 °C – 40 °C (32 °F – 104 °F), 20 % – 80 % relative air humidity (dry)
- *1 KX-TG6511/KX-TG6521/KX-TG6531 series: page 3
*2 KX-TG6541 series: page 3

Note:

- Design and specifications are subject to change without notice.
- The illustrations in these instructions may vary slightly from the actual product.

Setting up

Connections

- Use only the supplied Panasonic AC adaptor PQLV219.

■ Base unit

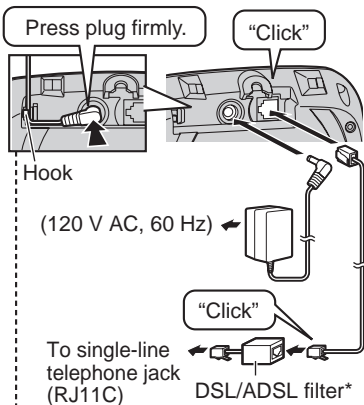

Correct

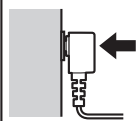

Wrong



*DSL/ADSL filter (not supplied) is required if you have DSL/ADSL service.

■ Charger

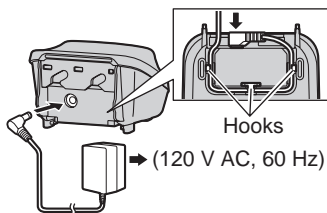

Battery installation

- USE ONLY Ni-MH batteries AAA (R03) size.
- Do NOT use Alkaline/Manganese/Ni-Cd batteries.
- Confirm correct polarities (\oplus , \ominus).

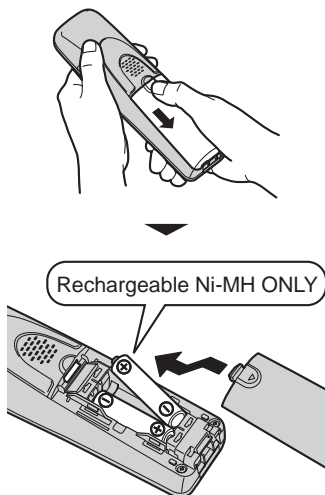

Battery charge

Charge for about 7 hours.

- When the batteries are fully charged, the charge indicator goes off and "Fully charged" is displayed.

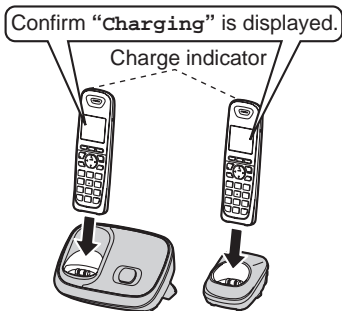

Note when setting up

Note for connections

- The AC adaptor must remain connected at all times. (It is normal for the adaptor to feel warm during use.)
- The AC adaptor should be connected to a vertically oriented or floor-mounted AC outlet. Do not connect the AC adaptor to a ceiling-mounted AC outlet, as the weight of the adaptor may cause it to become disconnected.

During a power failure

The unit will not work during a power failure. We recommend connecting a corded-type telephone (without AC adaptor) to the same telephone line or to the same telephone line jack using a Panasonic T-adaptor (page 5). Emergency power can be supplied to the unit by connecting a Panasonic battery back-up power supply noted on page 5.





Note for battery installation

- Use the supplied rechargeable batteries. For replacement, we recommend using the Panasonic rechargeable batteries noted on page 5, 8.
- Wipe the battery ends (+, -) with a dry cloth.
- Avoid touching the battery ends (+, -) or the unit contacts.

Note for battery charge

- It is normal for the handset to feel warm during charging.
- Clean the charge contacts of the handset, base unit, and charger with a soft and dry cloth once a month. Clean more often if the unit is exposed to grease, dust, or high humidity.

Battery level

Icon	Battery level
	High
	Medium
	Low
	Needs charging.
	Empty

Panasonic Ni-MH battery performance (supplied batteries)

Operation	Operating time
In continuous use	13 hours max. ^{*1}
Not in use (standby)	11 days max. ^{*1}

*1 If Eco mode is on.

Note:

- Actual battery performance depends on usage and ambient environment.
- Even after the handset is fully charged, the handset can be left on the base unit or charger without any ill effect on the batteries.
- The battery level may not be displayed correctly after you replace the batteries. In this case, place the handset on the base unit or charger and let it charge for at least 7 hours.

Intelligent eco mode

This feature automatically reduces handset power consumption by suppressing handset transmission power when the handset is close to the base unit.

- When this feature is activated, **ECO** is displayed.

- Eco mode is turned off when the clarity booster is activated (page 19).

Controls

Handset (KX-TGA652)

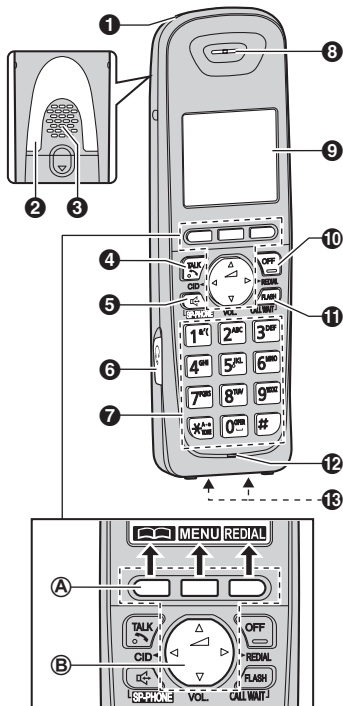

- Charge indicator**
Ringer indicator
Message indicator
- Nonslip pad**
 - Nonslip pad offers support when you cradle the handset between your shoulder and ear.
- Speaker**
- [TALK]** (TALK)
- [SP-PHONE]** (SP-PHONE: Speakerphone)

- Headset jack**
(KX-TG6511/KX-TG6531/
KX-TG6541 series: page 3)
- Dial keypad** ([*]: TONE)
- Receiver**
- Display**
- [OFF]**
- [FLASH] [CALL WAIT]**
- Microphone**
- Charge contacts**

Control type

A Soft keys

The handset features 3 soft keys. By pressing a soft key, you can select the feature shown directly above it on the display.

B Navigator key

- [▲], [▼], [◀], or [▶]: Scroll through various lists and items.
- VOL. (Volume: [▲] or [▼]): Adjust the receiver or speaker volume while talking.
- [◀] CID (Caller ID): View the caller list.
- [▶] REDIAL: View the redial list.

Base unit

■ KX-TG6511 series (page 3)

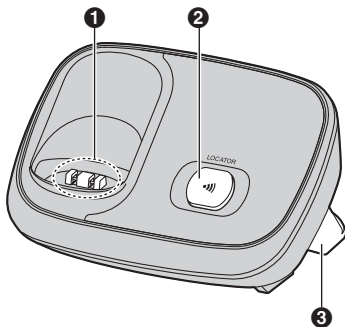

- Charge contacts**

② [⏏] (LOCATOR)

③ Bracket*¹

■ KX-TG6521/KX-TG6531 series
(page 3)

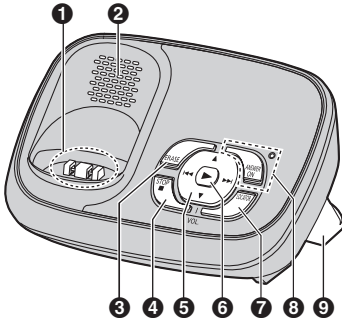

- ① Charge contacts
- ② Speaker
- ③ [ERASE]
- ④ [■] (STOP)
- ⑤ [▲]/[▼] (VOL.: Volume up/down)
[◀]/[▶] (Repeat/Skip)
- ⑥ [▶] (Play)
Message indicator
- ⑦ [LOCATOR]
- ⑧ [ANSWER ON]
ANSWER ON indicator
- ⑨ Bracket*¹

■ KX-TG6541 series (page 3)

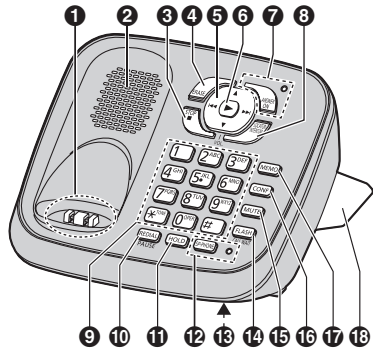

- ① Charge contacts
- ② Speaker
- ③ [■] (STOP)
- ④ [ERASE]
- ⑤ [▲]/[▼] (VOL.: Volume up/down)
[◀]/[▶] (Repeat/Skip)
- ⑥ [▶] (Play)
Message indicator
- ⑦ [ANSWER ON]
ANSWER ON indicator
- ⑧ [LOCATOR] [INTERCOM]
- ⑨ Dial keypad ([*]: TONE)
- ⑩ [REDIAL] [PAUSE]
- ⑪ [HOLD]
- ⑫ [SP-PHONE] (Speakerphone)
SP-PHONE indicator
- ⑬ Microphone
- ⑭ [FLASH] [CALL WAIT]
- ⑮ [MUTE]
- ⑯ [CONF] (Conference)
- ⑰ [MEMO]
- ⑱ Bracket*¹

*¹ The base unit has an unremovable bracket for desk or wall mounting. To mount on a wall, see page 47.

Belt clip

■ To attach

■ To remove



Display

Handset display items

Item	Meaning
Y	Within base unit range
Y	Out of base unit range
	The line is in use. <ul style="list-style-type: none"> When flashing: The call is put on hold. When flashing rapidly: An incoming call is now being received.
ECO	Eco mode is on. (page 11)
	Speakerphone is on. (page 16)
	Ringer volume is off. (page 27)
ZzZ	Silent mode is on. (page 29)
PRIV.	Privacy mode is on. (page 19)
	Alarm is on. (page 29)
1	Handset number
	Battery level

Item	Meaning
	Blocked call (page 30)
BOOST	Clarity booster is on. (page 19)
In use	Answering system is being used by another handset or the base unit.*1
Line in use	Someone is using the line.

*1 KX-TG6521/KX-TG6531/KX-TG6541 series: page 3

Initial settings

Symbol meaning:

Example: [▼]/[▲]: “OFF”

Press [▼] or [▲] to select the words in quotations.

Display language

You can select either “English” or “Español” as the display language. The default setting is “English”.

- [MENU]** → **[#][1][1][0]**
- [▼]/[▲]**: Select the desired setting.
- [SAVE]** → **[OFF]**

Voice guidance language

Available for:

KX-TG6521/KX-TG6531/KX-TG6541 series (page 3)

You can select either “English” or “Español” as the voice guidance language of the answering system. The default setting is “English”.

- [MENU]** → **[#][1][1][2]**
- [▼]/[▲]**: Select the desired setting.

3 [SAVE] → [OFF]**Dialing mode**

If you cannot make calls, change this setting according to your telephone line service. The default setting is “**Tone**”.

“**Tone**”: For tone dial service.

“**Pulse**”: For rotary/pulse dial service.

1 [MENU] → [#][1][2][0]**2 [▼]/[▲]:** Select the desired setting.**3 [SAVE] → [OFF]****Date and time****1 [MENU] → [#][1][0][1]****2** Enter the current month, date, and year by selecting 2 digits for each.

Example: July 15, 2010

[0][7][1][5][1][0]

3 [OK]**4** Enter the current hour and minute (12-hour clock format) by selecting 2 digits for each.

Example: 9:30

[0][9][3][0]

5 [AM/PM]: Select “**AM**” or “**PM**”.**6 [SAVE] → [OFF]****Note:**

- When English is selected as the display language, 12-hour clock format is used. When Spanish is selected, 24-hour clock format is used.
- To correct a digit, press [**←**] or [**→**] to move the cursor to the digit, then make the correction.
- The date and time may be incorrect after a power failure. In this case, set the date and time again.

Making calls

Using the handset

- 1 Lift the handset and dial the phone number.
 - To correct a digit, press **[CLEAR]**.
- 2 Press **[↶]** or **[CALL]**.
- 3 When you finish talking, press **[OFF]** or place the handset on the base unit or charger.

Using the speakerphone

- 1 Dial the phone number and press **[☎]**.
 - Speak alternately with the other party.
- 2 When you finish talking, press **[OFF]**.

Note:

- For best performance, use the speakerphone in a quiet environment.
- To switch back to the receiver, press **[↶]**.

Adjusting the receiver or speaker volume

Press **[▲]** or **[▼]** repeatedly while talking.

Making a call using the redial list

The last 5 phone numbers dialed are stored in the redial list (each 48 digits max.).

- 1 **[REDIAL]** or **[▶] REDIAL**
 - If there is a new message in the voice mail or answering system, **[REDIAL]** is not displayed.
- 2 **[▼]/[▲]**: Select the desired phone number.
- 3 **[↶]**

Erasing a number in the redial list

- 1 **[REDIAL]** or **[▶] REDIAL**
- 2 **[▼]/[▲]**: Select the desired phone number. → **[ERASE]**
- 3 **[▼]/[▲]**: "Yes" → **[SELECT]**
- 4 **[OFF]**

Pause (for PBX/long distance service users)

A pause is sometimes required when making calls using a PBX or long distance service. When storing a calling card access number and/or PIN in the phonebook, a pause is also needed (page 22).

Example: If you need to dial the line access number "9" when making outside calls with a PBX:

- 1 **[9]** → **[PAUSE]**
- 2 Dial the phone number. → **[↶]**

Note:

- A 3.5 second pause is inserted each time **[PAUSE]** is pressed. Repeat as needed to create longer pauses.

Using the base unit

Available for:

KX-TG6541 series (page 3)

- 1 **[SP-PHONE]**
- 2 Dial the phone number.
- 3 When the other party answers, speak into the microphone.
 - Speak alternately with the other party.
- 4 When you finish talking, press **[SP-PHONE]**.

Note:

- For best performance, use the speakerphone in a quiet environment.

- While on a call, you can switch from the base unit to the handset:
 - Press [**📞**] on the handset, then press [**SP-PHONE**] on the base unit with the privacy mode off (page 19).
 - If the handset is on the base unit, simply lift it.

Adjusting the speaker volume

Press [**▲**] or [**▼**] repeatedly while talking.

Redialing the last number dialed [**SP-PHONE**] → [**REDIAL**]

Answering calls

Using the handset

When a call is being received, the ringer indicator flashes rapidly.

- 1 Lift the handset and press [**📞**] or [**📞**] when the unit rings.
 - You can also answer the call by pressing any dial key from [**0**] to [**9**], [*****], or [**#**]. (**Any key answer feature**)
- 2 When you finish talking, press [**OFF**] or place the handset on the base unit or charger.

Auto talk

You can answer calls simply by lifting the handset off the base unit or charger. You do not need to press [**📞**]. To turn this feature on, see page 26.

Adjusting the handset ringer volume

Press [**▲**] or [**▼**] repeatedly to select the desired volume while the handset is ringing for an incoming call.

Note:

- You can also program the handset ringer volume beforehand (page 25).

Temporary handset ringer off

While the handset is ringing for a call, you can turn the ringer off temporarily by pressing [**📞**].

Adjusting the base unit ringer volume

Available for:

KX-TG6521/KX-TG6531/KX-TG6541 series (page 3)

Press [**▲**] or [**▼**] repeatedly to select the desired volume.

- To turn the ringer off, press and hold [**▼**] until the unit beeps.

Note:

- Even when the ringer volume is set to off, the base unit still rings for intercom calls (page 45). (KX-TG6541 series: page 3)

Using the base unit

Available for:

KX-TG6541 series (page 3)

When a call is being received, the SP-PHONE indicator flashes rapidly.

- 1 Press [**SP-PHONE**] when the unit rings.
- 2 Speak into the microphone.
- 3 When you finish talking, press [**SP-PHONE**].

Useful features during a call

Hold

This feature allows you to put an outside call on hold.

Handset

- 1 Press **[MENU]** during an outside call.
- 2 **[▼]/[▲]**: “Hold” → **[SELECT]**
- 3 To release hold, press **[↶]**.
 - Another handset user can take the call by pressing **[↶]**.
 - The base unit user can take the call by pressing **[SP-PHONE]**. (KX-TG6541 series: page 3)

Base unit

Available for:

KX-TG6541 series (page 3)

- 1 Press **[HOLD]** during an outside call.
- 2 To release hold, press **[SP-PHONE]**.
 - A handset user can take the call by pressing **[↶]**.

Note for handset and base unit:

- If a call is kept on hold for more than 9 minutes, an alarm tone starts to sound and the ringer indicator on the handset flashes rapidly. After 1 additional minute on hold, the call is disconnected.
- If another phone is connected to the same line (page 11), you can also take the call by lifting its handset.
- While an outside call is on hold, the SP-PHONE indicator on the base unit flashes. (KX-TG6541 series: page 3)

Mute

While mute is turned on, you can hear the other party, but the other party cannot hear you.

Handset

- 1 Press **[MUTE]** during conversation.
 - **[MUTE]** flashes.
- 2 To return to the conversation, press **[MUTE]** again.

Note:

- **[MUTE]** is a soft key visible on the handset display during a call.

Base unit

Available for:

KX-TG6541 series (page 3)

- 1 Press **[MUTE]** during conversation.
 - The SP-PHONE indicator on the base unit flashes.
- 2 To return to the conversation, press **[MUTE]** again.

Flash

[FLASH] allows you to use the special features of your host PBX such as transferring an extension call, or accessing optional telephone services.

Note:

- To change the flash time, see page 26.

For call waiting or Call Waiting Caller ID service users

To use call waiting, you must first subscribe to call waiting from your service provider/telephone company. This feature allows you to receive calls while you are already talking on the phone. If you receive a call while on the phone, you will hear a call waiting tone. **If you subscribe to both Caller ID and Call Waiting with Caller ID services**, the 2nd caller's information is displayed after you hear the call waiting tone on the handset.

- 1 Press [**CALL WAIT**] to answer the 2nd call.
- 2 To switch between calls, press [**CALL WAIT**].

Note:

- Please contact your service provider/telephone company for details and availability of this service in your area.

Temporary tone dialing (for rotary/pulse service users)

You can temporarily switch the dialing mode to tone when you need to access touch-tone services (for example, answering services, telephone banking services, etc.).

Press [*****] (TONE) before entering access numbers which require tone dialing.

Handset clarity booster

This feature can improve sound clarity when the handset is used in an area where there may be interference. During an outside call, this feature is turned on automatically when necessary.

- When this feature is turned on, **BOOST** is displayed.

Call share

This feature allows you to join an existing outside call.

Important:

- When the privacy mode is on, you cannot join the conversation. Turn it off.

Handset

To join the conversation, press [**↶**] when the other handset is on an outside call.

Base unit

Available for:

KX-TG6541 series (page 3)

To join the conversation, press [**SP-PHONE**] when the handset is on an outside call.

Note for handset and base unit:

- A maximum of 4 parties (including 1 outside party) can join a conversation using 3 extensions. **(4-way conference)**

Privacy mode

When the privacy mode is "On", the unit prevents other users from joining your conversations with outside callers. To allow other users to join your conversations (call share), leave this feature off. The default setting is "Off".

1 [**MENU**] → [**#**][**1**][**9**][**4**]

2 [**▼**]/[**▲**]: Select "On" or "Off".

3 [**SAVE**] → [**OFF**]

- When the privacy mode is turned on, **PRIV** is displayed during an outside call.

Shared phonebook

The shared phonebook allows you to make calls without having to dial manually. Any handset registered to the base unit can use the shared phonebook. You can add 50 names and phone numbers to the shared phonebook, and assign each phonebook entry to the desired group.

Important:

- Only 1 person can access the shared phonebook at a time.
- Caller ID subscribers can use group ringer tone features (page 34).

Adding entries

- 1 → **[ADD]**
- 2 Enter the party's name (16 characters max.). → **[OK]**
- 3 Enter the party's phone number (24 digits max.). → **[OK]**
- 4 /: Select the desired group. → **[SELECT]** 2 times
 - To add other entries, repeat from step 2.
- 5 **[OFF]**

Character table for entering names

While entering characters, you can switch between uppercase and lowercase by pressing **[*]** (A→a).

Key	Character
[1]	Space & ' () * , - . / 1
[2]	A B C 2
	a b c 2
[3]	D E F 3
	d e f 3

Key	Character
[4]	G H I 4
	g h i 4
[5]	J K L 5
	j k l 5
[6]	M N O 6
	m n o 6
[7]	P Q R S 7
	p q r s 7
[8]	T U V 8
	t u v 8
[9]	W X Y Z 9
	w x y z 9
[0]	Space 0
[#]	#

- To enter another character that is located on the same dial key, first press **[▶]** to move the cursor to the next space.
- If you do not press any dial key within 5 seconds after entering a character, the character is fixed and the cursor moves to the next space.

Correcting a mistake

Press **[◀]** or **[▶]** to move the cursor to the character or number you want to erase, then press **[CLEAR]**. Enter the appropriate character or number.

- Press and hold **[CLEAR]** to erase all characters or numbers.

Groups

Groups can help you find entries in the phonebook quickly and easily. When adding an entry to the phonebook, you can assign it to one of 9 groups. You can change the names of groups assigned for phonebook entries ("Friends", "Family", etc.) and then search for phonebook entries by group. The group

ringer tone feature is available for Caller ID subscribers (page 34).

Changing group names

The default group name is "Group 1" to "Group 9".

- 1 → [MENU]
- 2 /[]: "Group" → [SELECT]
- 3 /[]: Select the desired group. → [SELECT]
- 4 /[]: "Group name" → [SELECT]
- 5 Edit the name (10 characters max.; page 20). → [SAVE]
- 6 [OFF]

Finding and calling a phonebook entry

Scrolling through all entries

- 1
- 2 /[]: Select the desired entry.
- 3

Searching by first character

- 1
- 2 Press the dial key ([0] – [9] or [#]) which contains the character you are searching for (page 20).
 - Press the same dial key repeatedly to display the first entry corresponding to each character located on that dial key.
 - If there is no entry corresponding to the character you selected, the next entry is displayed.
- 3 /[]: Scroll through the phonebook if necessary.
- 4

Searching by group

- 1 → [GROUP]
- 2 /[]: Select the group you want to search. → [SELECT]
 - If you select "All groups", the unit ends the group search.
- 3 /[]: Select the desired entry.
- 4

Editing entries

- 1 Find the desired entry (page 21). → [EDIT]
- 2 Edit the name if necessary (16 characters max.; page 20). → [OK]
- 3 Edit the phone number if necessary (24 digits max.). → [OK]
- 4 /[]: Select the desired group (page 20). → [SELECT]
- 5 [SELECT] → [OFF]

Erasing entries

Erasing an entry

- 1 Find the desired entry (page 21).
- 2 [ERASE]
- 3 /[]: "Yes" → [SELECT] → [OFF]

Erasing all entries

- 1 → [MENU]
- 2 /[]: "Erase all" → [SELECT]
- 3 /[]: "Yes" → [SELECT]
- 4 /[]: "Yes" → [SELECT]
- 5 [OFF]

Chain dial

This feature allows you to dial phone numbers in the phonebook while you are on a call. This feature can be used, for example, to dial a calling card access number or bank account PIN that you have stored in the phonebook, without having to dial manually.

- 1 During an outside call, press **[MENU]**.
- 2 **[▼]/[▲]**: "Phonebook" → **[SELECT]**
- 3 **[▼]/[▲]**: Select the desired entry.
- 4 Press **[CALL]** to dial the number.

Note:

- When storing a calling card access number and your PIN in the phonebook as one phonebook entry, press **[PAUSE]** to add pauses after the number and PIN as necessary (page 16).
- If you have rotary/pulse service, you need to press **[✳]** (TONE) before pressing **[MENU]** in step 1 to change the dialing mode temporarily to tone. When adding entries to the phonebook, we recommend adding **[✳]** (TONE) to the beginning of phone numbers you wish to chain dial (page 20).

Programmable settings

You can customize the unit by programming the following features using the handset. To access the features, there are 2 methods:





- scrolling through the display menus (page 23)
- using the direct commands (page 25)
- Direct command is the main method used in these operating instructions.

Programming by scrolling through the display menus



- 1 [MENU]
- 2 Press [▼] or [▲] to select the desired main menu. → [SELECT]
- 3 Press [▼] or [▲] to select the desired item in sub-menu 1. → [SELECT]
 - In some cases, you may need to select from sub-menu 2. → [SELECT]
- 4 Press [▼] or [▲] to select the desired setting. → [SAVE]
 - This step may vary depending on the feature being programmed.
 - To exit the operation, press [OFF].

Note:

- See page 25 for the default settings.

Main menu	Sub-menu 1	Sub-menu 2	Page	
Caller list 	–	–	34	
Answering device  (KX-TG6521/ KX-TG6531/ KX-TG6541 series: page 3)	Play new msg.	–	38	
	Play all msg.	–	38	
	Erase all msg. ^{*1}	–	39	
	Greeting	Record greeting ^{*1}		37
		Check greeting		37
		Pre-recorded ^{*1}		37
	Settings	Ring count ^{*1}		41
		Recording time ^{*1}		41
		Remote code ^{*1}		39
		Screen call		36
Answer on ^{*1}	–		36	
Answer off ^{*1}	–		36	
V.M. access 	–	–	44	
Intercom 	–	–	45	

Programming

Main menu	Sub-menu 1	Sub-menu 2	Page
Set date & time 	Date and time ^{*1}	–	15
	Alarm	–	29
	Time adjustment ^{*1}	–	–
Initial setting 	Ringer setting	Ringer volume	–
		Ringer tone	–
		Silent mode – On/Off – Start/End	29
	Set date & time	Date and time ^{*1}	15
		Alarm	29
		Time adjustment ^{*1}	–
	Talking Caller ID (KX-TG6521/ KX-TG6531/ KX-TG6541 series: page 3)	Handset	33
		Base unit ^{*1}	
	Handset name	–	30
	Call block ^{*1}	–	30
	Voice mail	Store VM access# ^{*1}	43
		VM tone detect ^{*1}	43
	Message alert	–	42
	Display setting	LCD Contrast	–
	Key tone	–	–
	Caller ID edit	–	35
	Auto talk	–	17
	Set tel line	Set dial mode ^{*1}	15
		Set flash time ^{*1}	18
		Set line mode ^{*1}	–
	Privacy mode ^{*1}	–	19
	Registration	Register handset	31
	Change language	Display	14
		Voice prompt ^{*1} (KX-TG6521/ KX-TG6531/ KX-TG6541 series: page 3)	14

Main menu	Sub-menu 1	Sub-menu 2	Page
Customer support 	–	–	–

*1 If you program these settings using one of the handsets, you do not need to program the same item using another handset.

Programming using the direct commands

- [MENU]** → **[#]**
- Enter the desired code.
- Select the desired setting. → **[SAVE]**
 - This step may vary depending on the feature being programmed.
 - To exit the operation, press **[OFF]**.

Note:

- In the following table, < > indicates the default settings.

Feature	Code	Setting	System ^{*1}	Page
Caller list	[2][1][3]	–	–	34
V.M. access (V.M.: Voice mail)	[3][3][0]	–	–	44
Intercom	[2][7][4]	–	–	45
Date and time	[1][0][1]	–	●	15
Alarm	[7][2][0]	[1] : Once [2] : Daily [0] : <Off>	–	29
Time adjustment ^{*2}	[2][2][6]	[1] : <Caller ID auto> [0] : Manual	●	–
Ringer volume ^{*3} (Handset)	[1][6][0]	[1]–[6] : Level 1–6 <6> [0] : Off	–	–
Ringer tone (Handset) ^{*4, *5, *6}	[1][6][1]	[1]–[5] : Tone 1–5 <Tone 1> [6]–[0] : Melody 1–5	–	–
Silent mode (On/Off)	[2][3][8]	[1] : On [0] : <Off>	–	29
Silent mode (Start/End)	[2][3][7]	<11:00 PM/06:00 AM>	–	30
Handset name	[1][0][4]	–	–	30
Call block	[2][1][7]	–	●	30
Block w/o num (Block calls without phone number)	[2][4][0]	[1] : On [0] : <Off>	●	31

Programming

Feature	Code	Setting	System ^{*1}	Page
Store VM access# (VM: Voice mail)	[3][3][1]	–	●	43
VM tone detect	[3][3][2]	[1]: <On> [0]: Off	●	44
Message alert	[3][4][0]	[1]: <On> [0]: Off	–	42
LCD Contrast (Display contrast)	[1][4][5]	[1]–[6]: Level 1–6 <3>	–	–
Key tone ^{*7}	[1][6][5]	[1]: <On> [0]: Off	–	–
Caller ID edit (Caller ID number auto edit)	[2][1][4]	[1]: <On> [0]: Off	–	35
Auto talk ^{*8}	[2][0][0]	[1]: On [0]: <Off>	–	17
Set dial mode	[1][2][0]	[1]: Pulse [2]: <Tone>	●	15
Set flash time ^{*9}	[1][2][1]	[0]: 900 ms [1]: <700 ms> [2]: 600 ms [3]: 400 ms [4]: 300 ms [5]: 250 ms [*]: 200 ms [#]: 160 ms [6]: 110 ms [7]: 100 ms [8]: 90 ms [9]: 80 ms	●	18
Set line mode ^{*10}	[1][2][2]	[1]: A [2]: 	●	–
Privacy mode	[1][9][4]	[1]: On [0]: <Off>	●	19
Register handset	[1][3][0]	–	–	31
Deregistration	[1][3][1]	–	–	32
Display (Change language)	[1][1][0]	[1]: <English> [2]: Español	–	14
Customer support ^{*11}	[6][8][0]	–	–	–

For the Talking Caller ID feature (KX-TG6521/KX-TG6531/KX-TG6541 series: page 3)

Feature	Code	Setting	System ^{*1}	Page
Talking Caller ID (Handset)	[1][6][2]	[1]: <On> [0]: Off	–	33
Talking Caller ID (Base unit)	[*][1][6][2]	[1]: On [0]: <Off>	●	33

For the answering system (KX-TG6521/KX-TG6531/KX-TG6541 series: page 3)

Feature	Code	Setting	System ^{*1}	Page
Play new msg. (msg.: message)	[3][2][3]	–	–	38
Play all msg.	[3][2][4]	–	–	38
Erase all msg.	[3][2][5]	–	●	39
Record greeting	[3][0][2]	–	●	37
Check greeting	[3][0][3]	–	–	37
Pre-recorded (Reset to pre- recorded greeting)	[3][0][4]	–	●	37
Ring count	[2][1][1]	2–7 rings <4 rings> Toll saver	●	41
Recording time	[3][0][5]	1 min <3 min> Greeting only	●	41
Remote code	[3][0][6]	<111>	●	39
Screen call	[3][1][0]	<On> Off	–	36
Answer on	[3][2][7]	–	●	36
Answer off	[3][2][8]	–	●	36
Voice prompt (Change language)	[1][1][2]	[1]: <English> [2]: Español	●	14

*1 If “System” column is checked, you do not need to program the same item using another handset.

*2 This feature allows the unit to automatically adjust the date and time each time caller information including date and time is received.
To turn this feature on, select “**Caller ID auto**”. To turn this feature off, select “**Manual**”. (Caller ID subscribers only)

To use this feature, set the date and time first (page 15).

*3 When the ringer volume is turned off, $\&$ is displayed and the handset does not ring for outside calls. However even when the ringer volume is set to off, the handset still rings for alarm (page 29), intercom calls, and paging (page 45).

*4 If you subscribe to a distinctive ring service (such as IDENT-A-RING), select a tone (tone 1 to 5). If you select a melody, you cannot distinguish lines by their ringers.

*5 If you select one of the melody ringer tones, the ringer tone continues to play for several seconds even if the caller has already hung up. You may either hear a dial tone or no one on the line when you answer the call.

*6 The preset melodies in this product are used with permission of © 2009 Copyrights Vision Inc.

*7 Turn this feature off if you prefer not to hear key tones while you are dialing or pressing any keys, including confirmation tones and error tones.

Programming

- *8 If you subscribe to a Caller ID service and want to view the caller's information after lifting up the handset to answer a call, turn off this feature.
- *9 The flash time depends on your telephone exchange or host PBX. Contact your PBX supplier if necessary. The setting should stay at "700 ms" unless pressing **[FLASH]** fails to pick up the waiting call.
- *10 Generally, the line mode setting should not be changed. This setting automatically maintains receiver volume at the proper level depending on the current telephone line condition. Set the line mode to "A" if telephone line condition is not good.
- *11 The handset can display the Internet address where you can download the operating instructions or get further information for this product, using your computer.

Special programming

Alarm

An alarm sounds at the set time for 3 minutes once or daily. Alarm can be set for each handset.

Important:

- Set the date and time beforehand (page 15).

1 **[MENU]** → **[#][7][2][0]**

2 **[▼]/[▲]**: Select the desired alarm option. → **[SELECT]**

Off	Turns alarm off. Go to step 7.
Once	An alarm sounds once at the set time.
Daily	An alarm sounds daily at the set time. Go to step 4.

3 Enter the desired month and date. → **[OK]**

4 Set the desired time.

5 **[AM/PM]**: Select "AM" or "PM". → **[OK]**

6 **[▼]/[▲]**: Select the desired alarm tone. → **[SELECT]**

- We recommend selecting a different ringer tone from the one used for outside calls.

7 **[SELECT]** → **[OFF]**

- When the alarm is set, \ominus is displayed.

Note:

- To stop the alarm, press any dial key or place the handset on the base unit or charger.
- When the handset is in use, the alarm will not sound until the handset is in standby mode.

Silent mode

Silent mode allows you to select a period of time during which the handset will not ring for outside calls. This feature is useful for time periods when you do not want to be disturbed, for example, while sleeping. Silent mode can be set for each handset.

Important:

- Set the date and time beforehand (page 15).
- We recommend turning the base unit ringer off (page 17) in addition to turning the silent mode on. (KX-TG6521/KX-TG6531/KX-TG6541 series: page 3)
- If you have set the alarm, the alarm sounds even if the silent mode is turned on.

Turning silent mode on/off

1 **[MENU]** → **[#][2][3][8]**

2 **[▼]/[▲]**: Select "On" or "Off". → **[SAVE]**

- If you select "Off", press **[OFF]** to exit.

3 Enter the desired hour and minute you wish to start this feature.

4 **[AM/PM]**: Select "AM" or "PM". → **[OK]**

5 Enter the desired hour and minute you wish to end this feature.

6 **[AM/PM]**: Select "AM" or "PM".

7 **[SAVE]** → **[OFF]**

- When the silent mode is set, Zz is displayed.

Note:

- To correct a digit, press **[◀]** or **[▶]** to move the cursor to the digit, then make the correction.

Changing the start and end time

- 1 **[MENU]** → **[#][2][3][7]**
- 2 Continue from step 3, "Turning silent mode on/off", page 29.

Changing the handset name

Each handset can be given a customized name ("Bob", "Kitchen", etc.). This is useful when you make intercom calls between handsets. You can also select whether or not the handset name is displayed in standby mode. The default setting is "OFF". If you select "On" without entering any handset name, "Handset 1" to "Handset 6" is displayed.

- 1 **[MENU]** → **[#][1][0][4]**
- 2 Enter the desired name (max. 10 characters; see the character table, page 20).
 - If not required, go to step 3.
- 3 **[SAVE]**
- 4 **[▼]/[▲]**: Select the desired setting. → **[SELECT]**
- 5 **[SELECT]** → **[OFF]**

Call block (Caller ID subscribers only)

This feature allows the unit to reject calls when:

- the unit receives a call from a phone number stored in the call block list as unwanted ("Storing unwanted callers", page 30).
- the unit receives a call without phone number ("Block calls without phone number", page 31).

When a call is received, the unit rings for a short time while the caller is being identified. If the phone number matches an entry in the call block list, the unit

sends out a busy tone to the caller, and then disconnects the call.

Important:

- When the unit receives a call from a number that is stored in the call block list or a call without a recognized phone number, the call is logged in the caller list (page 34) with **[▼]** after the call is disconnected.

Storing unwanted callers

You can store up to 30 phone numbers in the call block list by using the caller list or by entering the numbers directly.

Important:

- We recommend storing 10 digits (including an area code). If only 7 digits are stored, all numbers that have the same last 7 digits will be blocked.

■ From the caller list:

- 1 **[←]** CID
- 2 **[▼]/[▲]**: Select the entry to be blocked.
 - To edit the number, press **[EDIT]** repeatedly until the phone number is shown in the 10-digit format.

- 3 **[SAVE]**
- 4 **[▼]/[▲]**: "Call block" → **[SELECT]**
- 5 **[▼]/[▲]**: "Yes" → **[SELECT]**
- 6 Edit the phone number if necessary (24 digits max.).
- 7 **[SAVE]** → **[OFF]**

■ By entering phone numbers:

- 1 **[MENU]** → **[#][2][1][7]** → **[ADD]**
- 2 Enter the phone number (24 digits max.).
 - To erase a digit, press **[CLEAR]**.
- 3 **[SAVE]** → **[OFF]**

Block calls without phone number

You can reject a call without phone number including “Out of area”, “Private caller”, or “Long distance”.

- 1 **[MENU]** → **[#][2][4][0]**
- 2 **[▼]/[▲]**: Select the desired setting.
→ **[SAVE]** → **[OFF]**

Viewing/editing/erasing call block numbers

- 1 **[MENU]** → **[#][2][1][7]**
- 2 **[▼]/[▲]**: Select the desired entry.
 - To exit, press **[OFF]**.
- 3 **To edit a number:**
[EDIT] → Edit the phone number.
→ **[SAVE]** → **[OFF]**
To erase a number:
[ERASE] → **[▼]/[▲]**: “Yes” →
[SELECT] → **[OFF]**

Note:

- When editing, press the desired dial key to add, **[CLEAR]** to erase.
- When viewing, “Block w/o num” is displayed if the block calls without phone number feature is turned on. To turn the feature off: **[ERASE]** → **[▼]** → **[SAVE]** → **[OFF]**

Registering a unit**Operating additional units****Additional handsets**

Up to 6 handsets can be registered to the base unit.

Important:

- See page 6 for information on the available model.

Registering a handset to the base unit

The supplied handset and base unit are pre-registered. If for some reason the handset is not registered to the base unit, re-register the handset.

- 1 **Handset:**
[MENU] → **[#][1][3][0]**
- 2 **Base unit:**
 - **KX-TG6511 series: page 3**
Press and hold **[LOCATOR]** for about 5 seconds. (No registration tone)
 - **KX-TG6521/KX-TG6531/KX-TG6541 series: page 3**
Press and hold **[LOCATOR]** for about 5 seconds until the registration tone sounds.
 - If all registered handsets start ringing, press the same button to stop. Then repeat this step.
 - The next step must be completed within 90 seconds.
- 3 **Handset:**
Press **[OK]**, then wait until a long beep sounds.

Note:

- While registering, “Base in registering” is displayed on all registered handsets.
- When you purchase an additional handset, refer to the additional handset's installation manual for registration.

Deregistering a handset

A handset can cancel its own registration (or the registration of another handset) that is stored to the base unit. This allows the handset to end its wireless connection with the system.

- 1 **[MENU] → [#][1][3][1]**
 - All handsets registered to the base unit are displayed.
- 2 **[▼]/[▲]**: Select the handset you want to cancel. → **[SELECT]**
- 3 **[▼]/[▲]**: “Yes” → **[SELECT]**
- 4 **[OFF]**

Using Caller ID service

Important:

- This unit is Caller ID compatible. To use Caller ID features, you must subscribe to a Caller ID service. Contact your service provider/telephone company for details.

Caller ID features

When an outside call is being received, the caller's name and phone number are displayed.

Caller information for the last 50 callers is logged in the caller list from the most recent call to the oldest.

- If the unit cannot receive caller information, the following is displayed:
 - “**Out of area**”: The caller dials from an area which does not provide a Caller ID service.
 - “**Private caller**”: The caller requests not to send caller information.
 - “**Long distance**”: The caller makes a long distance call.
- If the unit is connected to a PBX system, caller information may not be properly received. Contact your PBX supplier.

Missed calls

If a call is not answered, the unit treats it as a missed call. The display shows “**Missed call**”. This lets you know if you should view the caller list to see who called while you were away.

Note:

- Even when there are unviewed missed calls, “**Missed call**” disappears from the standby display if the following operation is performed by one of the registered handsets:

- Being replaced on the base unit or charger.
- Pressing [**OFF**].

Phonebook name display

When caller information is received and it matches a phone number stored in the phonebook, the stored name in the phonebook is displayed and logged in the caller list.

Talking Caller ID

Available for:

KX-TG6521/KX-TG6531/KX-TG6541 series (page 3)

This feature lets you know who is calling without looking at the display.

To use this feature, you must:

- subscribe to a Caller ID service of your service provider/telephone company.
- turn this feature on (page 26).

When caller information is received, the handsets and base unit announce the caller's name or phone number received from your service provider/telephone company following every ring.

The unit announces in English only.

- Name pronunciation may vary. This feature may not pronounce all names correctly.
- Caller ID service has a limit of how many characters can be displayed. If the caller's name is too long, the handset may not be able to display or announce the entire name.
- The announcement is heard at the same level as the ringer volume (page 17, 25).
- If you turn on the answering system and set the number of rings “**2 rings**” (page 41), the unit does not announce the caller information. If

Caller ID Service

“Toll saver” is selected and there is a new message, the unit does not announce the caller information.

- When you receive a call while on the phone, the 2nd caller's name is not announced even if you subscribe to both Caller ID and Call Waiting with Caller ID services.

Phonebook name announcement

When caller information is received and it matches a phone number stored in the phonebook, the stored name in the phonebook is announced.

Group ringer tone for phonebook

This feature can help you identify who is calling by using different ringer tones for different groups of callers. When adding an entry to the phonebook, you can assign it to the desired group (page 20). When a call is received from a caller assigned to a group, the ringer you selected for that group rings after caller information is displayed. If you select “Current ringer” (default), the unit uses the ringer tone you selected on page 25 when calls from this group are received.

- 1 [📖] → [MENU]
- 2 [▼]/[▲]: “Group” → [SELECT]
- 3 [▼]/[▲]: Select the desired group. → [SELECT]
- 4 [▼]/[▲]: Select the current setting of the group ringer tone. → [SELECT]
- 5 [▼]/[▲]: Select the desired ringer tone. → [SAVE]
- 6 [OFF]

Caller list

Important:

- Only 1 person can access the caller list at a time.
- Make sure the unit's date and time setting is correct (page 15).

Viewing the caller list and calling back

- 1 [←] CID
- 2 Press [▼] to search from the most recent call, or [▲] to search from the oldest call.
 - If ► is displayed, not all of the information is shown. To see the remaining information, press [▶]. To return to the previous screen, press [←].
- 3 To call back, press [↶]. To exit, press [OFF].

Note:

- If the entry has already been viewed or answered, “✓” is displayed, even if it was viewed or answered using another handset.

Editing a caller's phone number before calling back

You can edit a phone number in the caller list by removing its area code and/or the long distance code “1”.

- 1 [←] CID
- 2 [▼]/[▲]: Select the desired entry.
 - If ► is displayed, not all of the information is shown. To see the remaining information, press [▶]. To return to the previous screen, press [←].

3 Press **[EDIT]** repeatedly until the phone number is shown in the desired format.

- ① Local phone number
Example: 321-5555
- ② Area code – Local phone number
Example: 555-321-5555
- ③ 1 – Area code – Local phone number
Example: 1-555-321-5555

4

Caller ID number auto edit feature

Once you call back an edited number, the handset which was used to call back remembers the area code and format of the edited number. The next time someone calls from the same area code, caller information is customized by the handset as follows:

- When the call is being received, the Caller ID number is displayed in the same format as the edited number.
- After the call has ended, the caller's phone number is displayed in the same format as the edited number, when reviewed from the caller list.

For example, you can use this feature to set the handset to ignore the area code of callers in your area, so that you can call these local numbers using caller information without dialing the area code.

To activate this feature, you must edit an entry in the caller list, then call that number. After that, phone numbers from that caller's area code are edited automatically.

This feature can be set for each handset (page 26). The default setting is "on".

Note:

- Phone numbers from the 4 most recently edited area codes are automatically edited.
- If you move to another area, you can turn this feature off to erase previously edited area codes. To use this feature again, turn it on and reprogram the area codes you want to edit once again.

Erasing selected caller information

- 1 **[←]** CID
- 2 **[▼]/[▲]**: Select the desired entry.
- 3 **[ERASE]** → **[▼]/[▲]**: "Yes" → **[SELECT]** → **[OFF]**

Erasing all caller information

- 1 **[←]** CID
- 2 **[ERASE]** → **[▼]/[▲]**: "Yes" → **[SELECT]** → **[OFF]**

Storing caller information to the phonebook

- 1 **[←]** CID
- 2 **[▼]/[▲]**: Select the desired entry.
 - To edit the number, press **[EDIT]** repeatedly until the phone number is shown in the desired format.
- 3 **[SAVE]**
- 4 **[▼]/[▲]**: "Phonebook" → **[SELECT]**
- 5 Continue from step 2, "Editing entries", page 21.

Answering system

Available for:

KX-TG6521/KX-TG6531/KX-TG6541 series (page 3)

The answering system can answer and record calls for you when you are unavailable to answer the phone. You can also set the unit to play a greeting message but not to record caller messages by selecting “**Greeting only**” as the recording time setting (page 41).

Important:

- Only 1 person can access the answering system (listen to messages, record a greeting message, etc.) at a time.
- When callers leave messages, the unit records the day and time of each message. Make sure the date and time have been set correctly (page 15).

Memory capacity (including your greeting message)

The total recording capacity is about 18 minutes. A maximum of 64 messages can be recorded.

Note:

- If message memory becomes full:
 - “**Messages full**” is shown on the handset display.
 - The ANSWER ON indicator on the base unit flashes rapidly when the answering system is turned on.
- When the message memory becomes full:
 - If you use the pre-recorded greeting message, the unit automatically switches to another pre-recorded

greeting message asking callers to call again later.

- If you recorded your own greeting message, the same message is still announced to callers even though their messages are not recorded.

Turning the answering system on/off

Base unit

Press **[ANSWER ON]** to turn on/off the answering system.

Handset

- 1 **To turn on:**
[MENU] → [#][3][2][7]
To turn off:
[MENU] → [#][3][2][8]
- 2 **[OFF]**

Note for base unit and handset:

- When the answering system is turned on, the ANSWER ON indicator on the base unit lights up.

Call screening

While a caller is leaving a message, you can listen to the call through the unit speaker.

Handset

To adjust the speaker volume, press **[▲]** or **[▼]** repeatedly. You can answer the call by pressing **[📞]**. Call screening can be set for each handset. The default setting is “on”.

- 1 **[MENU] → [#][3][1][0]**
- 2 **[▼]/[▲]**: Select the desired setting.
→ **[SAVE] → [OFF]**

Base unit

Available for:

KX-TG6541 series (page 3)

To adjust the speaker volume, press [▲] or [▼] repeatedly. You can answer the call by pressing [SP-PHONE].

To turn off while screening a call, press [▼] repeatedly until the sounds goes off.

Note:

- If you adjust the speaker volume while listening to messages or talking on the intercom, the speaker volume for call screening is turned on again.

Greeting message

When the unit answers a call, a greeting message is played to callers.

You can use either:

- your own greeting message
- a pre-recorded greeting message

Recording your greeting message

- 1 [MENU] → [#][3][0][2]
- 2 [▼]/[▲]: “Yes” → [SELECT]
- 3 After a beep sounds, hold the handset about 20 cm (8 inches) away and speak clearly into the microphone (2 minutes max.).
- 4 Press [STOP] to stop recording.
- 5 [OFF]

Using a pre-recorded greeting message

The unit provides 2 pre-recorded greeting messages:

- If you erase or do not record your own greeting message, the unit plays a

pre-recorded greeting asking callers to leave a message.

- If the message recording time (page 41) is set to “Greeting only”, callers’ messages are not recorded and the unit plays a different pre-recorded greeting message asking callers to call again.

Resetting to a pre-recorded greeting message

If you want to use a pre-recorded greeting message once you record your own greeting message, you need to erase your own greeting message.

- 1 [MENU] → [#][3][0][4]
- 2 [YES] → [OFF]

Playing back the greeting message

- 1 [MENU] → [#][3][0][3]
- 2 [OFF]

Listening to messages using the base unit

When new messages have been recorded, the message indicator on the base unit flashes.

Press [▶].

- If new messages have been recorded, the base unit plays back new messages.
- If there are no new messages, the base unit plays back all messages.

Operating the answering system during playback

Key	Operation
[▲] or [▼]	Adjust the speaker volume
[◀◀]	Repeat message* ¹
[▶▶]	Skip message
[■] (STOP)	Stop playback
[ERASE]	Erase currently playing message

*¹ If pressed within the first 5 seconds of a message, the previous message is played.

Erasing all messages

Press [ERASE] 2 times while the unit is not in use.

Listening to messages using the handset

When new messages have been recorded:

- “New message” is displayed.
- The message indicator on the handset flashes slowly if the message alert feature is turned on (page 42).

1 To listen to new messages:

[PLAY]

or

[MENU] → [#][3][2][3]

- If there are no new messages in the answering system, [PLAY] is not displayed.

To listen to all messages:

[MENU] → [#][3][2][4]

2 When finished, press [OFF].

Note:

- To switch to the receiver, press [↶].

Operating the answering system

[MENU] → [▼]/[▲]: “Answering device” → [SELECT]

Key	Operation
[▲] or [▼]	Adjust the receiver/speaker volume (during playback)
[1] or [◀]	Repeat message (during playback)* ¹
[2] or [▶]	Skip message (during playback)
[3]	Enter the “Settings” menu
[4]	Play new messages
[5]	Play all messages
[6]	Play greeting message
[7][6]	Record greeting message
[8]	Turn answering system on
[PAUSE]	Pause message* ²
[9] or [STOP]	Stop recording Stop playback
[0]	Turn answering system off
[*][4] ³	Erase currently playing message
[*][5]	Erase all messages
[*][6]	Reset to a pre-recorded greeting message

- *1 If pressed within the first 5 seconds of a message, the previous message is played.
- *2 To resume playback:
[▼]/[▲]: "Playback" → [SELECT]
- *3 You can also erase as follows:
[ERASE] → [▼]/[▲]: "Yes" → [SELECT]

Calling back (Caller ID subscribers only)

If caller information is received for the call, you can call the caller back while listening to a message.

- 1 Press [PAUSE] during playback.
- 2 [▼]/[▲]: "Call back" → [SELECT]

Editing the number before calling back

- 1 Press [PAUSE] during playback.
- 2 [▼]/[▲]: "Edit & Call" → [SELECT]
- 3 Press [EDIT] repeatedly until the phone number is shown in the desired format (page 34). → [↶]

Erasing all messages

- 1 [MENU] → [#][3][2][5]
- 2 [▼]/[▲]: "Yes" → [SELECT] → [OFF]

Voice memo

Available for:
KX-TG6541 series (page 3)

Recording a voice memo

You can use the base unit to leave a voice memo (voice message) for

yourself or someone else (3 minutes max.). Voice memos can be played back later with the same operation used to play back answering system messages.

- 1 [MEMO]
- 2 After the unit beeps, speak clearly about 20 cm (8 inches) away from the microphone.
- 3 To stop recording, press [■] (STOP).

Remote operation

Using a touch-tone phone, you can call your phone number from outside and access the unit to listen to messages or change answering system settings. The unit's voice guidance prompts you to press certain dial keys to perform different operations.

Remote access code

A 3-digit remote access code must be entered when operating the answering system remotely. This code prevents unauthorized parties from listening to your messages remotely. The default setting is "111".

Important:

- To prevent unauthorized access to this product, we recommend that you regularly change the remote code.

- 1 [MENU] → [#][3][0][6]
- 2 Enter the desired 3-digit remote access code.
- 3 [SAVE] → [OFF]

Deactivating remote operation

Press [*] in step 2 on "Remote access code", page 39.

- The entered remote access code is deleted.

Using the answering system remotely

- 1 Dial your phone number from a touch-tone phone.
- 2 After the greeting message starts, enter your remote access code.
 - The unit announces the number of new messages.
 - The voice guidance announcements are different depending on the voice guidance language setting (page 14).
- 3 Follow the voice guidance prompts as necessary or control the unit using remote commands (page 40).
- 4 When finished, hang up.

Note:

- You can also leave a message just as any outside caller can. After the greeting message starts, press **[*]** to skip the greeting message and record your message after the beep.

Voice guidance

When the English voice guidance is selected

During remote operation, the unit's voice guidance starts and prompts you to press **[1]** to perform a specific operation, or press **[2]** to listen to more available operations.

Note:

- If you do not press any dial keys within 10 seconds after a voice guidance prompt, the unit disconnects your call.

When the Spanish voice guidance is selected

To start the voice guidance, press **[9]**. The voice guidance announces the available remote commands (page 40).

Note:

- If you do not press any dial keys within 10 seconds after a voice guidance prompt, the unit disconnects your call.

Remote commands

You can press dial keys to access certain answering system functions without waiting for the voice guidance to prompt you.

Key	Operation
[1]	Repeat message (during playback) ^{*1}
[2]	Skip message (during playback)
[4]	Play new messages
[5]	Play all messages
[9]	Stop playback ^{*2} Start voice guidance ^{*3}
[0]	Turn answering system off
[*][4]	Erase currently playing message
[*][5]	Erase all messages
[*][#]	End remote operation (or hang up)

*1 If pressed within the first 5 seconds of a message, the previous message is played.

*2 For English voice guidance only

*3 For Spanish voice guidance only

Turning on the answering system remotely

If the answering system is off, you can turn it on remotely.

- 1 Dial your phone number from a touch-tone phone.
- 2 Let the phone ring 15 times.
 - A long beep is heard.

- 3** Enter your remote access code within 10 seconds after the long beep.
- The greeting message is played back.
 - You can either hang up, or enter your remote access code again and begin remote operation (page 39).

Answering system settings

Number of rings before the unit answers a call

You can change the number of times the phone rings “**Ring count**” before the unit answers calls. You can select 2 to 7 rings, or “**Toll saver**”.

The default setting is “**4 rings**”.

“**Toll saver**”: The unit’s answering system answers at the end of the 2nd ring when new messages have been recorded, or at the end of the 5th ring when there are no new messages. If you call your phone from outside to listen to new messages (page 39), you know that there are no new messages when the phone rings for the 3rd time. You can then hang up without being charged for the call.

- 1** [MENU] → [#][2][1][1]
2 [▼]/[▲]: Select the desired setting.
 → [SAVE] → [OFF]

For voice mail service subscribers

If you subscribe to a flat-rate service package that includes Caller ID, call waiting, voice mail, and unlimited local/regional/long distance calls, please note the following:

- To use the voice mail service provided by your service provider/telephone company rather than the unit’s answering system, turn off the answering system (page 36).
- To use this unit’s answering system rather than the voice mail service provided by your service provider/telephone company, please contact your service provider/telephone company to deactivate your voice mail service.

If your service provider/telephone company cannot do this:

- Set this unit’s “**Ring count**” setting so that this unit’s answering system answers calls before the voice mail service of your service provider/telephone company does. It is necessary to check the number of rings required to activate the voice mail service provided by your service provider/telephone company before changing this setting.
- Change the number of rings of the voice mail service so that the answering system can answer the call first. To do so, contact your service provider/telephone company.

Caller’s recording time

You can change the maximum message recording time allowed for each caller. The default setting is “**3 min**”.

- 1** [MENU] → [#][3][0][5]
2 [▼]/[▲]: Select the desired setting.
 → [SAVE] → [OFF]

Selecting “Greeting only”

You can select “**Greeting only**” which sets the unit to announce a greeting message to callers but not record messages.

Answering System

Select “**Greeting only**” in step 2 on “Caller’s recording time”, page 41.

Note:

- When you select “**Greeting only**”:
 - If you do not record your own message, the unit will play the pre-recorded greeting-only message asking callers to call again later.
 - If you use your own message, record the greeting-only message asking callers to call again later (page 37).

Message alert

You can select whether or not the message indicator on the handset flashes slowly when new messages are recorded. The default setting is “**On**”.

Important:

- If you stored the voice mail access number (page 43), the message indicator also flashes for newly recorded voice mail messages (page 44).

1 [MENU] → [#][3][4][0]

2 [▼]/[▲]: Select the desired setting.
→ [SAVE] → [OFF]

Note:

- While message alert is on, battery operating time is shortened (page 11).

Voice mail service

Voice mail is an automatic answering service offered by your service provider/telephone company. After you subscribe to this service, your service provider/telephone company's voice mail system answers calls for you when you are unavailable to answer the phone or when your line is busy. Messages are recorded by your service provider/telephone company, not your telephone. Please contact your service provider/telephone company for details of this service.

Important:

- To use the voice mail service provided by your service provider/telephone company rather than the unit's answering system, turn off the answering system (page 36). For details, see page 41.
(KX-TG6521/KX-TG6531/
KX-TG6541 series: page 3)
- You need to store the voice mail access number to activate the message alert feature (page 42) for voice mail service.

Storing the voice mail (VM) access number

In order to listen to your voice mail messages, you must dial your service provider/telephone company's voice mail access number. Once you have stored your voice mail access number, you can dial it automatically (page 44).

- 1 **[MENU]** → **[#][3][3][1]**
- 2 Enter your access number (24 digits max.). → **[SAVE]** → **[OFF]**

Note:

- When storing your voice mail access number and your mailbox password,

press **[PAUSE]** to add pauses (page 16) between the access number and the password as necessary. Contact your service provider/telephone company for the required pause time.

Example:

<u>1-222-333-4444</u>	<u>PPPP</u>	<u>8888</u>
VM access	Pauses	Password
number		

To erase the voice mail access number

- 1 **[MENU]** → **[#][3][3][1]**
- 2 Press and hold **[CLEAR]** until all digits are erased. → **[SAVE]** → **[OFF]**

Voice mail (VM) tone detection

Your service provider/telephone company sends special signals (sometimes called "voice mail tones" or "stutter tones") to the unit to let you know you have new voice mail messages. If you hear a series of dial tones followed by a continuous dial tone after you press **[↶]**, you have new voice mail messages. Soon after you hang up a call or after the phone stops ringing, your unit checks the phone line to see if new voice mail messages have been recorded.

Turn this feature off when:

- You do not subscribe to voice mail service.
- Your service provider/telephone company does not send voice mail tones.
- Your phone is connected to a PBX.

If you are not sure which setting is required, contact your service provider/telephone company.

Turning VM tone detection on/off

The default setting is "On".

- 1 **[MENU]** → **[#][3][3][2]**
- 2 **[▼]/[▲]**: Select the desired setting.
→ **[SAVE]** → **[OFF]**

Listening to voice mail messages

The unit lets you know that you have new voice mail messages in the following ways:

- "New Voice Mail" is displayed on the handset if message indication service is available.
- The message indicator on the handset flashes slowly if the message alert feature is turned on ("Message alert", page 42).

- 1 **[VM]**
or
[MENU] → **[#][3][3][0]**
 - The speakerphone turns on.
 - If there are no new messages in the voice mail, **[VM]** is not displayed.
- 2 Follow the pre-recorded instructions.
- 3 When finished, press **[OFF]**.

Note:

- If the handset still indicates there are new messages even after you have listened to all new messages, turn it off by pressing and holding **[#]** until the handset beeps.
- If your voice mail service uses voice mail tones and a message is over 3 minutes long, the handset may not indicate new messages.
- If your voice mail service uses voice mail tones, the tones are heard from any phone connected to the same line. If you want to use another phone

to listen to voice mail messages, you have to dial your access number manually.

Intercom

Intercom calls can be made:

- between handsets
- between the handset and base unit (KX-TG6541 series: page 3)

Note:

- If you receive an outside call while talking on the intercom, you hear 2 tones.
 - To answer the call with the handset, press **[OFF]**, then press **[↶]**.
 - To answer the call with the base unit, press **[SP-PHONE]** 2 times. (KX-TG6541 series: page 3)
- When paging unit(s), the paged unit(s) beeps for 1 minute.

Making an intercom call

Handset

- 1 **[MENU]** → **[INT]**
- 2 **[▼]/[▲]**: Select the desired unit. → **[SELECT]**
 - To stop paging, press **[OFF]**.
- 3 When you finish talking, press **[OFF]**.

Base unit

Available for:
KX-TG6541 series (page 3)

- 1 Press **[INTERCOM]**.
When 2 or more handsets are registered:
 - To page a specific handset, enter the handset number.
 - To page all handsets, press **[0]** or wait for a few seconds.
- To stop paging, press **[INTERCOM]**.

- 2 When you finish talking, press **[INTERCOM]**.

Answering an intercom call

Handset

- 1 Press **[↶]** to answer the page.
- 2 When you finish talking, press **[OFF]**.

Base unit

Available for:
KX-TG6541 series (page 3)

- 1 Press **[INTERCOM]** to answer the page.
- 2 When you finish talking, press **[INTERCOM]**.

Handset locator

You can locate a misplaced handset by paging it.

- 1 **Base unit:**
[LOCATOR]
 - All registered handsets beep for 1 minute.
- 2 To stop paging:
Base unit:
Press **[LOCATOR]**.
Handset:
 - **KX-TG6511/KX-TG6521/KX-TG6531 series:** page 3
Press **[OFF]**.
 - **KX-TG6541 series:** page 3
Press **[↶]**, then press **[OFF]**.

Transferring calls, conference calls

Outside calls can be transferred or a conference call with an outside party can be made:

- between 2 handsets
- between the handset and base unit (KX-TG6541 series: page 3)

Handset

- 1 During an outside call, press **[INT]** to put the call on hold.
- 2 **[▼]/[▲]**: Select the desired unit. → **[SELECT]**
- 3 Wait for the paged party to answer.
 - If the paged party does not answer, press **[↶]** to return to the outside call.
- 4 **To complete the transfer:**
Press **[OFF]**.
 - The outside call is being routed to the destination unit.**To establish a conference call:**
Press **[CONF]**.
 - To leave the conference, press **[OFF]**. The other 2 parties can continue the conversation.
 - To put the outside call on hold, press **[HOLD]**. To resume the conference, press **[CONF]**.

Base unit

Available for:
KX-TG6541 series (page 3)

- 1 During an outside call, press **[INTERCOM]**.
When 2 or more handsets are registered:
 - To page a specific handset, enter the handset number.

- To page all handsets, press **[0]** or wait for a few seconds.
- 2 Wait for the paged party to answer.
 - If paged party does not answer, press **[INTERCOM]** to return to the outside call.
 - 3 **To complete the transfer:**
Press **[SP-PHONE]**.
 - The outside call is being routed to the handset.**To establish a conference call:**
Press **[CONF]**.
 - To leave the conference, press **[SP-PHONE]**. The other 2 parties can continue the conversation.
 - To put the outside call on hold, press **[HOLD]**. To resume the conference, press **[CONF]**.

Answering a transferred call

Handset

Press **[↶]** to answer the page.

Base unit

Available for:
KX-TG6541 series (page 3)

Press **[SP-PHONE]** to answer the page.

Error messages

If the unit detects a problem, one of the following messages is shown on the display.

Display message	Cause/solution
Base no power or No link. Re-connect base AC adaptor.	<ul style="list-style-type: none">● The handset has lost communication with the base unit. Move closer to the base unit and try again.● Unplug the base unit's AC adaptor to reset the unit. Reconnect the adaptor and try again.● The handset's registration may have been canceled. Re-register the handset (page 31).
Busy	<ul style="list-style-type: none">● The called unit is in use.● Other units are in use and the system is busy. Try again later.● The handset you are using is too far from the base unit. Move closer and try again.
Call phone company for your access #	<ul style="list-style-type: none">● You have not stored the voice mail access number. Store the number (page 43).
Check tel line	<ul style="list-style-type: none">● The supplied telephone line cord has not been connected yet or not connected properly. Check the connections (page 10).
Error!!	<ul style="list-style-type: none">● Recording was too short. Try again.*¹
Invalid	<ul style="list-style-type: none">● There is no handset registered to the base unit matching the handset number you entered.● The handset is not registered to the base unit. Register the handset (page 31).
Requires subscription to Caller ID.	<ul style="list-style-type: none">● You must subscribe to a Caller ID service. Once you receive caller information after subscribing to a Caller ID service, this message will not be displayed.
Use rechargeable battery.	<ul style="list-style-type: none">● A wrong type of battery such as Alkaline or Manganese was inserted. Use only the rechargeable Ni-MH batteries noted on page 5, 8.

*1 KX-TG6521/KX-TG6531/KX-TG6541 series: page 3

Troubleshooting

If you still have difficulties after following the instructions in this section, disconnect the base unit's AC adaptor, then reconnect the base unit's AC adaptor. Remove the batteries from the handset, and then insert the batteries into the handset again.

General use

Problem	Cause/solution
The handset does not turn on even after installing charged batteries.	<ul style="list-style-type: none"> Place the handset on the base unit or charger to turn on the handset.
The unit does not work.	<ul style="list-style-type: none"> Make sure the batteries are installed correctly (page 10). Fully charge the batteries (page 10). Check the connections (page 10). Unplug the base unit's AC adaptor to reset the unit. Reconnect the adaptor and try again. The handset has not been registered to the base unit. Register the handset (page 31).
I cannot hear a dial tone.	<ul style="list-style-type: none"> The base unit's AC adaptor or telephone line cord is not connected. Check the connections. Disconnect the base unit from the telephone line and connect the line to a known working telephone. If the working telephone operates properly, contact our service personnel to have the unit repaired. If the working telephone does not operate properly, contact your service provider/ telephone company.
The indicator on the handset flashes slowly.	<ul style="list-style-type: none"> New messages have been recorded. Listen to the new messages (page 38).^{*1} New voice mail messages have been recorded. Listen to the new voice mail messages (page 44).



*1 KX-TG6521/KX-TG6531/KX-TG6541 series: page 3

Programmable settings

Problem	Cause/solution
The display is in a language I cannot read.	<ul style="list-style-type: none"> Change the display language (page 14).
I cannot register a handset to a base unit.	<ul style="list-style-type: none"> The maximum number of handsets (6) is already registered to the base unit. Cancel unused handset registrations from the base unit (page 32).

Useful Information

Battery recharge

Problem	Cause/solution
The handset beeps and/or  flashes.	<ul style="list-style-type: none">● Battery charge is low. Fully charge the batteries (page 10).
I fully charged the batteries, but <ul style="list-style-type: none">–  still flashes,–  is displayed, or– the operating time seems to be shorter.	<ul style="list-style-type: none">● Clean the battery ends (\oplus, \ominus) and the charge contacts with a dry cloth and charge again.● It is time to replace the batteries (page 10).

Making/answering calls, intercom

Problem	Cause/solution
 is displayed.	<ul style="list-style-type: none">● The handset is too far from the base unit. Move closer.● The base unit's AC adaptor is not properly connected. Reconnect AC adaptor to the base unit.● The handset is not registered to the base unit. Register it (page 31).
Noise is heard, sound cuts in and out.	<ul style="list-style-type: none">● You are using the handset or base unit in an area with high electrical interference. Re-position the base unit and use the handset away from sources of interference.● Move closer to the base unit.● If you use a DSL/ADSL service, we recommend connecting a DSL/ADSL filter between the base unit and the telephone line jack. Contact your DSL/ADSL provider for details.
The handset does not ring.	<ul style="list-style-type: none">● The ringer volume is turned off. Adjust the ringer volume (page 25).● Silent mode is turned on. Turn it off (page 29).
The base unit does not ring.* ¹	<ul style="list-style-type: none">● The ringer volume is turned off. Adjust the ringer volume (page 17).
I cannot make a call.	<ul style="list-style-type: none">● The dialing mode may be set incorrectly. Change the setting (page 15).● The handset is too far from the base unit. Move closer and try again.
I cannot make long distance calls.	<ul style="list-style-type: none">● Make sure that you have long distance service.

*1 KX-TG6521/KX-TG6531/KX-TG6541 series: page 3

Caller ID/Talking Caller ID*¹

Problem	Cause/solution
Caller information is not displayed.	<ul style="list-style-type: none"> ● You must subscribe to Caller ID service. Contact your service provider/telephone company for details. ● If your unit is connected to any additional telephone equipment such as a Caller ID box or cordless telephone line jack, plug the unit directly into the wall jack. ● If you use a DSL/ADSL service, we recommend connecting a DSL/ADSL filter between the base unit and the telephone line jack. Contact your DSL/ADSL provider for details. ● The name display service may not be available in some areas. Contact your service provider/telephone company for details. ● Other telephone equipment may be interfering with this unit. Disconnect the other equipment and try again.
Caller information is not announced.* ¹	<ul style="list-style-type: none"> ● The handset or base unit's ringer volume is turned off. Adjust it (page 17, 25). ● The Talking Caller ID feature is turned off. Turn it on (page 26). ● The number of rings for the answering system is set to "2 rings" or "Toll saver". Select a different setting (page 41). ● If the base unit and another handset are having an intercom call, your handset does not announce caller information.*²
Caller information is displayed or announced* ¹ late.	<ul style="list-style-type: none"> ● Depending on your service provider/telephone company, the unit may display or announce the caller's information at the 2nd ring or later. ● Move closer to the base unit.
The caller list/incoming phone numbers are not edited automatically.	<ul style="list-style-type: none"> ● The Caller ID number auto edit feature is turned off. Turn it on and try again (page 26). ● You need to call back the edited number to activate Caller ID number auto edit.
I cannot dial the phone number edited in the caller list.	<ul style="list-style-type: none"> ● The phone number you dialed might have been edited incorrectly (for example, the long distance "1" or the area code is missing). Edit the phone number with another pattern (page 34).

Useful Information

Problem	Cause/solution
Time on the unit has shifted.	<ul style="list-style-type: none">● Incorrect time information from incoming Caller ID changes the time. Set the time adjustment to “Manual” (off) (page 25).
The 2nd caller's information is not displayed during an outside call.	<ul style="list-style-type: none">● In order to use Caller ID, call waiting, or Call Waiting Caller ID (CWID), you must first contact your service provider/telephone company and subscribe to the desired service. After subscribing, you may need to contact your service provider/telephone company again to activate this specific service, even if you already subscribed to both Caller ID and Call Waiting with Caller ID services (CWID).

*1 KX-TG6521/KX-TG6531/KX-TG6541 series: page 3

*2 KX-TG6541 series: page 3

Answering system (KX-TG6521/KX-TG6531/KX-TG6541 series: page 3)

Problem	Cause/solution
The unit does not record new messages.	<ul style="list-style-type: none">● The answering system is turned off. Turn it on (page 36).● The message memory is full. Erase unnecessary messages (page 38).● The recording time is set to “Greeting only”. Change the setting (page 41).● If you subscribe to a voice mail service, messages are recorded by your service provider/telephone company, not your telephone. Change the unit's number of rings setting or contact your service provider/telephone company (page 41).
I cannot operate the answering system.	<ul style="list-style-type: none">● Someone is using the unit. Wait for the other user to finish.● A caller is leaving a message. Wait for the caller to finish.● The handset is too far from the base unit. Move closer.

Problem	Cause/solution
I cannot operate the answering system remotely.	<ul style="list-style-type: none"> ● The remote access code is not set. Set the remote access code (page 39). ● You are entering the wrong remote access code. If you have forgotten your remote access code, enter the remote access code setting to check your current code (page 39). ● Press each key firmly. ● The answering system is turned off. Turn it on (page 40).

Liquid damage

Problem	Cause/solution
Liquid or other form of moisture has entered the handset/base unit.	<ul style="list-style-type: none"> ● Disconnect the AC adaptor and telephone line cord from the base unit. Remove the batteries from the handset and leave to dry for at least 3 days. After the handset/base unit are completely dry, reconnect the AC adaptor and telephone line cord. Insert the batteries and charge fully before use. If the unit does not work properly, contact an authorized service center.

Caution:

- To avoid permanent damage, do not use a microwave oven to speed up the drying process.

FCC and other information

This equipment complies with Part 68 of the FCC rules and the requirements adopted by the ACTA. On the bottom of this equipment is a label that contains, among other information, a product identifier in the format US:ACJ-----.

If requested, this number must be provided to the telephone company.

- Registration No.(found on the bottom of the unit)
- Ringer Equivalence No. (REN).....0.1B

A plug and jack used to connect this equipment to the premises wiring and telephone network must comply with the applicable FCC Part 68 rules and requirements adopted by the ACTA. A compliant telephone cord and modular plug is provided with the product. It is designed to be connected to a compatible modular jack that is also compliant.

The REN is used to determine the number of devices that may be connected to a telephone line. Excessive RENs on a telephone line may result in the devices not ringing in response to an incoming call. In most but not all areas, the sum of RENs should not exceed five (5.0). To be certain of the number of devices that may be connected to a line, as determined by the total RENs, contact the local telephone company. For products approved after July 23, 2001, the REN for the product is part of the product identifier that has the format US:AAEQ##TXXXX. The digits represented by ## are the REN without a decimal point (e.g., 03 is a REN of 0.3).

If this equipment causes harm to the telephone network, the telephone company will notify you in advance that temporary discontinuance of service may be required. But if advance notice isn't practical, the telephone company will notify the customer as soon as possible. Also, you will be advised of your right to file a complaint with the FCC if you believe it is necessary.

The telephone company may make changes in its facilities, equipment, operations or procedures that could affect the operation of the equipment. If this happens the telephone company will provide advance notice in order for you to make necessary modifications to maintain uninterrupted service.

If trouble is experienced with this equipment, for repair or warranty information, please contact a Factory Service Center or other Authorized Servicer. If the equipment is causing harm to the telephone network, the telephone company may request that you disconnect the equipment until the problem is resolved.

Connection to party line service is subject to state tariffs. Contact the state public utility commission, public service commission or corporation commission for information.

If your home has specially wired alarm equipment connected to the telephone line, ensure the installation of this equipment does not disable your alarm equipment. If you have questions about what will disable alarm equipment, consult your telephone company or a qualified installer.

This equipment is hearing aid compatible as defined by the FCC in 47 CFR Section 68.316.

When you hold the phone to your ear, noise might be heard in your Hearing Aid. Some Hearing Aids are not adequately shielded from external RF (radio frequency) energy. If noise occurs, use an optional headset accessory or the speakerphone option (if applicable) when using this phone. Consult with your audiologist or Hearing Aid manufacturer about the availability of Hearing Aids which provide adequate shielding to RF energy commonly emitted by digital devices.

WHEN PROGRAMMING EMERGENCY NUMBERS AND/OR MAKING TEST CALLS TO EMERGENCY NUMBERS:

- 1) Remain on the line and briefly explain to the dispatcher the reason for the call.
- 2) Perform such activities in the off-peak hours, such as early morning or late evenings.

This device complies with Part 15 of the FCC Rules. Operation is subject to the following two conditions:

(1) This device may not cause harmful interference, and (2) this device must accept any interference received, including interference that may cause undesired operation.

Privacy of communications may not be ensured when using this phone.

CAUTION:

Any changes or modifications not expressly approved by the party responsible for compliance could void the user's authority to operate this device.

NOTE:

This equipment has been tested and found to comply with the limits for a Class B digital device, pursuant to Part 15 of the FCC Rules. These limits are designed to provide reasonable protection against harmful interference in a residential installation. This equipment generates, uses, and can radiate radio frequency energy and, if not installed and used in accordance with the instructions, may cause harmful interference to radio communications.

However, there is no guarantee that interference will not occur in a particular installation. If this equipment does cause harmful interference to radio or television reception, which can be determined by turning the equipment off and on, the user is encouraged to try to correct the interference by one or more of the following measures:

- Reorient or relocate the receiving antenna.
- Increase the separation between the equipment and receiver.
- Connect the equipment into an outlet on a circuit different from that to which the receiver is connected.

- Consult the dealer or an experienced radio/TV technician for help.

Some cordless telephones operate at frequencies that may cause interference to nearby TVs and VCRs. To minimize or prevent such interference, the base of the cordless telephone should not be placed near or on top of a TV or VCR. If interference is experienced, move the cordless telephone further away from the TV or VCR. This will often reduce, or eliminate, interference.

FCC RF Exposure Warning:

- This product complies with FCC radiation exposure limits set forth for an uncontrolled environment.
- To comply with FCC RF exposure requirements, the base unit must be installed and operated 20 cm (8 inches) or more between the product and all person's body (excluding extremities of hands, wrist and feet).
- This product may not be collocated or operated in conjunction with any other antenna or transmitter.
- The handset may be carried and operated with only the specific provided belt-clip. Other non-tested belt-clips or similar body-worn accessories may not comply and must be avoided.

Notice

- FCC ID can be found inside the battery compartment or on the bottom of the units.

Compliance with TIA-1083 standard:

Telephone handsets identified with this logo have reduced noise and interference when used with T-Coil equipped hearing aids and cochlear implants.



Guía Rápida Española

Instalación

Unidad base

- Use solo el adaptador de corriente Panasonic PQLV219 incluido.

Oprima firmemente el contacto.

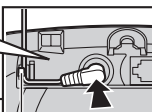

Gancho

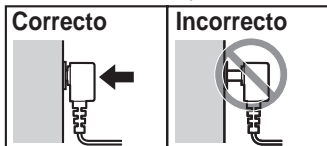
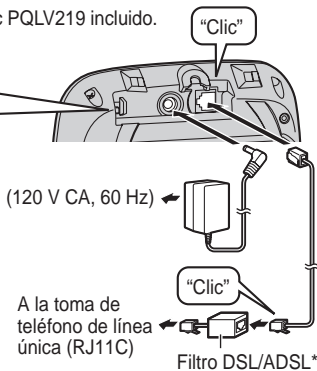

*Requiere un filtro DSL/ADSL (no incluido) si tiene este tipo de servicio.

Auricular

- UTILICE SOLO baterías de Ni-MH tamaño AAA (R03).
- NO utilice baterías Alcalinas, de Manganeseo o de Ni-Cd.
- Compruebe que las polaridades son las correctas (+, -).

SOLO baterías Ni-MH recargables

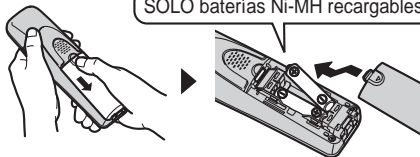

Cargador

- Use solo el adaptador de corriente Panasonic PQLV219 incluido.

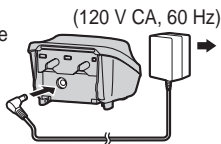

CARGUE APROXIMADAMENTE DURANTE 7 HORAS

Confirme que aparezca "Cargando".

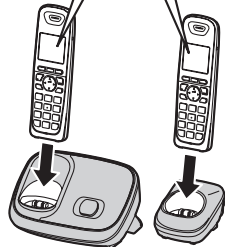

Sugerencias de operación

Teclas de función

El auricular incluye 3 teclas de función. Al oprimir una tecla de función, puede seleccionar la función que aparece directamente encima de ella en la pantalla.

[**☰**], [**MENU**], [**REMR.**] y otras funciones adicionales se asignan a las teclas de función. Preste atención a la pantalla para ver qué funciones están asignadas a las teclas de función durante la operación del auricular.

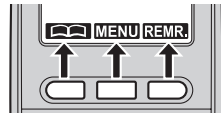

Tecla navegadora

- [**▲**], [**▼**], [**◀**], o [**▶**]: Navegue por diversas listas y elementos.
- **VOL.** (Volumen: [**▲**] o [**▼**]): Ajuste el volumen del receptor o el altavoz mientras habla.
- [**☰**] CID (identificador de llamadas): Vea la lista de personas que llamaron.
- [**▶**] REDIAL (remarcación): Vea la lista de remarcación.

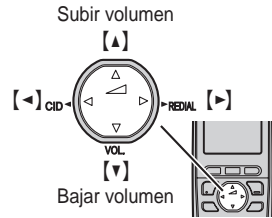

Cambio de idiomas (Auricular) (predeterminado: inglés)

Idioma de la pantalla

[**MENU**] → [**#**][**1**][**1**][**0**] → [**▼**]/[**▲**]: "Español" → [**GUARDA**] → [**OFF**]

Idioma de la guía de voz

Disponible para las series KX-TG6521/KX-TG6531/KX-TG6541

[**MENU**] → [**#**][**1**][**1**][**2**] → [**▼**]/[**▲**]: "Español" → [**GUARDA**] → [**OFF**]

Fecha y hora (Auricular)

1 [**MENU**] → [**#**][**1**][**0**][**1**]

2 Introduzca el día, mes y año actuales. → [**OK**]

3 Introduzca la hora y minuto actuales (formato de reloj de 24 horas).

4 [**GUARDA**] → [**OFF**]

Operaciones básicas

Cómo hacer y contestar llamadas (Auricular)

Para hacer llamadas	Marque el número telefónico. → [☎]/[☎]
Para contestar llamadas	[☎]/[☎]
Para colgar	[OFF]
Para ajustar el volumen del receptor o del altavoz	Oprima [▲] o [▼] repetidamente mientras habla.
Cómo hacer una llamada usando la lista de remarcación	[REMR.] o [▶] REDIAL → [▼]/[▲]: Seleccione el número telefónico deseado. → [☎]

Operaciones básicas

Cómo hacer y contestar llamadas (Auricular)

Para ajustar el volumen del timbre del auricular	1 [MENU] → [#][1][6][0] 2 [▼]/[▲]: Seleccione el volumen deseado. → [GUARDA] → [OFF]
--	---

Cómo hacer y contestar llamadas (Unidad base): serie KX-TG6541

Para hacer llamadas	[SP-PHONE] → Marque el número telefónico.
Para contestar llamadas	[SP-PHONE]
Para colgar	[SP-PHONE]
Para ajustar el volumen del altavoz	Oprima [▲] o [▼] repetidamente mientras habla.
Remarcación del último número marcado	[SP-PHONE] → [REDIAL]
Para ajustar el volumen del timbre de la unidad base	Oprima [▲] o [▼] repetidamente para seleccionar el volumen deseado.

Directorio telefónico compartido (Auricular)

Para añadir entradas	1 [📖] → [AÑAD.] 2 Introduzca el nombre de la persona (máx. 16 caracteres). → [OK] 3 Introduzca el número telefónico de la persona (máx. 24 dígitos). → [OK] 4 [▼]/[▲]: Seleccione el grupo deseado. → [SELEC.] 2 veces → [OFF]
Para hacer llamadas	[📖] → [▼]/[▲]: Seleccione la entrada deseada. → [📞]

Sistema contestador de llamadas (Unidad base): series KX-TG6521/KX-TG6531/KX-TG6541

Contestador encendido/apagado	Oprima [ANSWER ON] para encender y apagar el contestador de llamadas.
Para escuchar mensajes	[▶]

Sistema contestador de llamadas (Auricular): series KX-TG6521/KX-TG6531/KX-TG6541

Para escuchar mensajes	Para escuchar mensajes nuevos: [REPRO.] o [MENU] → [#][3][2][3] Para escuchar todos los mensajes: [MENU] → [#][3][2][4]
------------------------	--

Preguntas frecuentes

Pregunta	Causa y solución
¿Por qué aparece 📞 ?	<ul style="list-style-type: none"> El auricular está demasiado lejos de la unidad base. Acérquelo.

Preguntas frecuentes

Pregunta	Causa y solución
¿Por qué aparece Ψ ?	<ul style="list-style-type: none"> ● El adaptador para corriente de la unidad base no está conectado correctamente. Conecte de nuevo el adaptador para corriente a la unidad base. ● El auricular no está registrado en la unidad base. Regístrelo. <ol style="list-style-type: none"> 1 Auricular: [MENU] → [#][1][3][0] 2 Unidad base: <ul style="list-style-type: none"> ■ Serie KX-TG6511 Oprima y mantenga oprimido [LOCATOR] durante aproximadamente 5 segundos. (No hay tono de registro) ■ Series KX-TG6521/KX-TG6531/KX-TG6541 Oprima y mantenga oprimido [LOCATOR] durante aproximadamente 5 segundos hasta que suene el tono de registro. 3 Auricular: Oprima [OK], y después espere a que se emita un pitido largo.
¿Cómo se incrementa el nivel de volumen del auricular?	<ul style="list-style-type: none"> ● Oprima la tecla de navegación [▲] repetidamente mientras habla.
¿Por qué hay ruido o se corta la conversación?	<ul style="list-style-type: none"> ● Trate de reubicar la unidad base de forma que se minimice la distancia al auricular. ● Si ocurre el mismo problema aunque el auricular se encuentre enseguida de la unidad base, llame a soporte al cliente de Panasonic al 1-800-211-PANA (1-800-211-7262).
¿Es posible añadir otro auricular accesorio a mi unidad base?	<ul style="list-style-type: none"> ● Sí, puede añadir hasta 6 auriculares (incluyendo los que se venden con su unidad base) a una sola unidad base. ● Para adquirir auriculares accesorios adicionales (KX-TGA401/KX-TGA651/KX-TGA750), visite http://www.panasonic.com o llame al 1-800-332-5368. Los usuarios TTY (usuarios con impedimentos auditivos o del habla) pueden llamar al 1-866-605-1277.
¿Es posible mantener cargando las baterías todo el tiempo?	<ul style="list-style-type: none"> ● Puede dejar el auricular en la unidad base o el cargador en cualquier momento. Esto no daña las baterías.
¿Cómo se contestan las llamadas en espera (segunda llamada)?	<ul style="list-style-type: none"> ● Oprima [CALL WAIT] cuando escuche el tono de llamada en espera.

Para obtener más información acerca del registro, visite <http://www.panasonic.com/RegisterYourHandset> (solo en inglés)

Customer services

Customer Services Directory (United States and Puerto Rico)

Obtain Product Information and Operating Assistance; locate your nearest Dealer or Service Center; purchase Parts and Accessories; or make Customer Service and Literature requests by visiting our Web Site at:

<http://www.panasonic.com/help>

or, contact us via the web at:

<http://www.panasonic.com/contactinfo>

You may also contact us directly at: 1-800-211-PANA (1-800-211-7262),
Monday - Friday 9 am to 9 pm; Saturday - Sunday 10 am to 7 pm, EST.

TTY users (hearing or speech impaired users) can call 1-877-833-8855.

Accessory Purchases (United States and Puerto Rico)

Purchase Parts, Accessories and Instruction Books online for all Panasonic Products by visiting our Web Site at:

<http://www.pstc.panasonic.com>

or, send your request by E-mail to:

npcparts@us.panasonic.com

You may also contact us directly at:

1-800-332-5368 (Phone) 1-800-237-9080 (Fax Only)

(Monday - Friday 9 am to 9 pm, EST.)

Panasonic Service and Technology Company

20421 84th Avenue South, Kent, WA 98032

(We Accept Visa, MasterCard, Discover Card, American Express, and Personal Checks.)

TTY users (hearing or speech impaired users) can call 1-866-605-1277.

Warranty (For United States and Puerto Rico)

PANASONIC CORPORATION OF NORTH AMERICA
One Panasonic Way, Secaucus, New Jersey 07094

Panasonic Telephone Products Limited Warranty

Limited Warranty Coverage

If your product does not work properly because of a defect in materials or workmanship, Panasonic Corporation of North America (referred to as "the warrantor") will, for the length of the period indicated on the chart below, which starts with the date of original purchase ("Limited Warranty period"), at its option either (a) repair your product with new or refurbished parts, or (b) replace it with a new or a refurbished product. The decision to repair or replace will be made by the warrantor.

Parts

One (1) Year

Labor

One (1) Year

During the "Labor" Limited Warranty period there will be no charge for labor. During the "Parts" Limited Warranty period, there will be no charge for parts. You must mail-in your product prepaid during the Limited Warranty period. This Limited Warranty excludes both parts and labor for batteries, antennas, and cosmetic parts (cabinet). This Limited Warranty only applies to products purchased and serviced in the United States or Puerto Rico. This Limited Warranty is extended only to the original purchaser and only covers products purchased as new.

Ship-In Service

For assistance in the continental United States and Puerto Rico in obtaining repairs please ship the product prepaid to:

PSTC (Panasonic) Exchange Center,
4900 George McVay Drive, Suite B Door #12, McAllen, TX 78503
panacare@us.panasonic.com

When shipping the unit carefully pack in a padded shipping carton, include all accessories, and send it prepaid. Include a letter detailing the complaint, a return address and provide a day time phone number where you can be reached. P.O. Boxes are not acceptable. Keep the tracking number for your records. A copy of valid registered receipt is required under the 1 year parts and labor Limited Warranty.

For Limited Warranty service for headsets if a headset is included with this product please follow instructions above.

IF REPAIR IS NEEDED DURING THE LIMITED WARRANTY PERIOD THE PURCHASER WILL BE REQUIRED TO FURNISH A SALES RECEIPT/PROOF OF PURCHASE INDICATING DATE OF PURCHASE, AMOUNT PAID AND PLACE OF PURCHASE. CUSTOMER WILL BE CHARGED FOR THE REPAIR OF ANY UNIT RECEIVED WITHOUT SUCH PROOF OF PURCHASE.

Limited Warranty Limits And Exclusions

This Limited Warranty ONLY COVERS failures due to defects in materials or workmanship, and DOES NOT COVER normal wear and tear or cosmetic damage. The Limited Warranty ALSO DOES NOT COVER damages which occurred in shipment, or failures which are caused by products not supplied by the warrantor, or failures which result from accidents, misuse, abuse, neglect, bug infestation, mishandling, misapplication, alteration, faulty installation, set-up adjustments, misadjustment of consumer controls, improper maintenance, power line surge, lightning damage, modification, introduction of sand, humidity or liquids, commercial use such as hotel, office, restaurant, or other business or rental use of the product, or service by anyone other than a Factory Service Center or other Authorized Servicer, or damage that is attributable to acts of God.

THERE ARE NO EXPRESS WARRANTIES EXCEPT AS LISTED UNDER "LIMITED WARRANTY COVERAGE". THE WARRANTOR IS NOT LIABLE FOR INCIDENTAL OR CONSEQUENTIAL DAMAGES RESULTING FROM THE USE OF THIS PRODUCT, OR ARISING OUT OF ANY BREACH OF THIS LIMITED WARRANTY. (As examples, this excludes damages for lost time, lost calls or messages, cost of having someone remove or re-install an installed unit if applicable, travel to and from the servicer. The items listed are not exclusive, but are for illustration only.) **ALL EXPRESS AND IMPLIED WARRANTIES, INCLUDING THE WARRANTY OF MERCHANTABILITY, ARE LIMITED TO THE PERIOD OF THE LIMITED WARRANTY.**

Some states do not allow the exclusion or limitation of incidental or consequential damages, or limitations on how long an implied warranty lasts, so the exclusions may not apply to you.

This Limited Warranty gives you specific legal rights and you may also have other rights which vary from state to state. If a problem with this product develops during or after the Limited Warranty period, you may contact your dealer or Service Center. If the problem is not handled to your satisfaction, then write to the warrantor's Consumer Affairs Department at the addresses listed for the warrantor.

PARTS AND SERVICE, WHICH ARE NOT COVERED BY THIS LIMITED WARRANTY, ARE YOUR RESPONSIBILITY.

When you ship the product

- Carefully pack your unit, preferably in the original carton.
- Attach a letter, detailing the symptom.
- Send the unit to PSTC (Panasonic) Exchange Center, prepaid and adequately insured.
- Do not send your unit to Panasonic Corporation of North America listed on the back cover or to executive or regional sales offices. These locations do not repair consumer products.

Index

- # 4-way conference: 19
- A** Additional handset: 31
 - Alarm: 29
 - Answering calls: 17
 - Answering system
 - Call screening: 36
 - Erasing messages: 38, 39, 40
 - Greeting message: 37
 - Greeting only: 41
 - Listening to messages: 37, 38, 40
 - MEMO: 39
 - Number of rings: 41
 - Recording time: 41
 - Remote access code: 39
 - Remote operation: 39
 - Ring count: 41
 - Toll saver: 41
 - Turning on/off: 36, 38, 40
 - Auto talk: 17
- B** Battery: 10, 11
 - Belt clip: 14
 - Booster (Clarity booster): 19
- C** Call block: 30
 - Caller ID number auto edit: 35
 - Caller ID service: 33
 - Caller list: 34
 - Caller list edit: 34
 - Call share: 19
 - Call waiting: 19
 - Call Waiting Caller ID: 19
 - Chain dial: 22
 - CID (Caller ID): 34
 - Conference calls: 46
 - Control type: 12
 - Customer support: 26
- D** Date and time: 15
 - Dialing mode: 15
 - Direct commands: 25
 - Display
 - Contrast: 26
 - Language: 14
- E** Eco mode: 11
- Error messages: 48
- F** Flash: 18, 26
- G** Groups: 20, 34
- H** Handset
 - Deregistration: 32
 - Locator: 45
 - Name: 30
 - Registration: 31
 - Hold: 18
- I** Intercom: 45
- K** Key tone: 26
- L** Line mode: 26
- M** Making calls: 16
 - Missed calls: 33
 - Mute: 18
- P** Pause: 16
 - Phonebook: 20
 - Power failure: 11
 - Privacy mode: 19
- R** Redialing: 16
 - Ringer tone: 25, 34
 - Rotary/pulse service: 19
- S** Silent mode: 29
 - SP-PHONE (Speakerphone): 16
- T** Talking caller ID: 33
 - Temporary tone dialing: 19
 - Time adjustment: 25
 - Transferring calls: 46
 - Troubleshooting: 49
 - TTY: 60
- V** VM (Voice mail): 43
 - Voice guidance language: 14
 - Voice mail: 41, 43
 - Volume
 - Receiver: 16
 - Ringer (Base unit): 17
 - Ringer (Handset): 17, 25
 - Speaker: 16
- W** Wall mounting: 47

IMPORTANT!

If your product is not working properly. . .

- ① **Reconnect AC adaptor to the base unit.**
- ② **Check if telephone line cord is connected.**
- ③ **Use rechargeable Ni-MH batteries.**
(Alkaline/Manganese/Ni-Cd batteries CANNOT be used.)
- ④ Read **troubleshooting** page in the **Operating Instructions**.



Visit our Web site: <http://www.panasonic.com/help>

- **FAQ and troubleshooting hints are available.**

For your future reference

We recommend keeping a record of the following information to assist with any repair under warranty.

Serial No.

Date of purchase

(found on the bottom of the base unit)

Name and address of dealer

Attach your purchase receipt here.

Panasonic Corporation of North America
One Panasonic Way, Secaucus, New Jersey 07094

Copyright:

This material is copyrighted by Panasonic System Networks Co., Ltd., and may be reproduced for internal use only. All other reproduction, in whole or in part, is prohibited without the written consent of Panasonic System Networks Co., Ltd.

© Panasonic System Networks Co., Ltd. 2009

Printed in Malaysia



TG6511

PNQX2397XA CM1209DW3050