



## Operating Instructions

---

5.8 GHz Digital Cordless  
Answering System

Model No. **KX-TG5631**

Model No. **KX-TG5651**

5.8 GHz Expandable Digital Cordless  
Answering System with Two Handsets

Model No. **KX-TG5632**

Model No. **KX-TG5652**

5.8 GHz Expandable Digital Cordless  
Answering System with Three Handsets

Model No. **KX-TG5633**

5.8 GHz Digital Cordless  
Answering System with Three Handsets

Model No. **KX-TG5653**

5.8 GHz Digital Cordless  
Answering System with Four Handsets

Model No. **KX-TG5634**

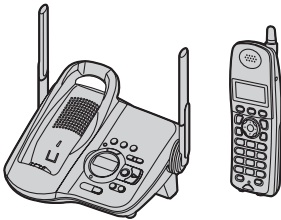

Model shown is KX-TG5631.

This unit is compatible with Caller ID. To use this feature, you must subscribe to the appropriate service offered by your service provider.

**Charge the handset battery for 7 hours before initial use.**

Please read these Operating Instructions before using the unit and save for future reference.

For assistance, visit our website:

<http://www.panasonic.com/phonehelp> for customers in the U.S.A. or Puerto Rico.

## Table of Contents

---

### Introduction

|  |    |
|--|----|
| Introduction . . . . .                       | 3  |
| About these operating instructions . . . . . | 4  |
| Accessory information . . . . .              | 7  |
| Important safety instructions . . . . .      | 10 |
| For best performance . . . . .               | 12 |

### Preparation

|                                       |    |
|---------------------------------------|----|
| Setting up the base unit . . . . .    | 13 |
| Setting up the handset . . . . .      | 14 |
| Controls . . . . .                    | 17 |
| Displays . . . . .                    | 19 |
| Setting the unit before use . . . . . | 20 |

### Making/Answering Calls

|   |    |
|---|----|
| Making calls . . . . .                  | 22 |
| Answering calls . . . . .               | 23 |
| Useful features during a call . . . . . | 23 |

### Phonebook

|   |    |
|---|----|
| Handset phonebook . . . . .               | 26 |
| Copying handset phonebook items . . . . . | 28 |

### Caller ID Service

|                                   |    |
|-----------------------------------|----|
| Using Caller ID service . . . . . | 29 |
| Caller list . . . . .             | 31 |

### Programming

|                                 |    |
|---------------------------------|----|
| Programmable settings . . . . . | 33 |
|---------------------------------|----|

### Answering System

|   |    |
|---|----|
| Answering system . . . . .                          | 38 |
| Listening to messages using the base unit . . . . . | 39 |
| Listening to messages using the handset . . . . .   | 40 |
| Remote operation . . . . .                          | 41 |
| Answering system settings . . . . .                 | 42 |

### Multi-unit Operation

|                    |    |
|--------------------|----|
| Intercom . . . . . | 44 |
|--------------------|----|

|   |    |
|---|----|
| Transferring calls between handsets, conference calls . . . . . | 45 |
| Registering a handset . . . . .                                 | 46 |

### Useful Information

|                                     |    |
|-------------------------------------|----|
| Wall mounting . . . . .             | 47 |
| Headset (optional) . . . . .        | 49 |
| Error messages . . . . .            | 50 |
| Troubleshooting . . . . .           | 51 |
| FCC and other information . . . . . | 55 |
| Specifications . . . . .            | 58 |
| Warranty . . . . .                  | 59 |
| Customer services . . . . .         | 61 |

### Index

|                 |    |
|-----------------|----|
| Index . . . . . | 62 |
|-----------------|----|

## Introduction

**Thank you for purchasing a Panasonic cordless telephone.**

We recommend keeping a record of the following information for future reference.

Serial No. \_\_\_\_\_ Date of purchase \_\_\_\_\_  
(found on the bottom of the base unit)

Name and address of dealer \_\_\_\_\_

┌-----┐  
│ **Attach your purchase receipt here.** │  
└-----┘

### **ENERGY STAR**

As an ENERGY STAR® Participant, Panasonic has determined that this product meets the ENERGY STAR guidelines for energy efficiency. ENERGY STAR is a U.S. registered mark.



# About these operating instructions

These operating instructions can be used for the following models:

- KX-TG5631/KX-TG5632/KX-TG5633/KX-TG5634
- KX-TG5651/KX-TG5652/KX-TG5653

---

## Descriptions of the multiple handsets and chargers

The following models include 2 or more handsets and a charger(s). Descriptions of the multiple handsets and chargers in these operating instructions are for the following models only:

KX-TG5632/KX-TG5652

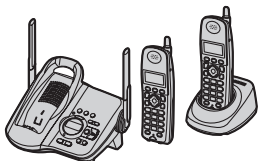

KX-TG5633/KX-TG5653



KX-TG5634



---



---

**Symbols used in these operating instructions**

| Symbol   | Meaning   |
|--|---|
| <b>Example:</b> "Ringer ID"  | Press <b>[▲]</b> or <b>[▼]</b> to select the words in quotations shown on the display.  |
| →  | Proceed to the next operation.  |
| <b>Example:</b> <b>[MENU]</b> , <b>[Phonebook]</b>   | The words in the brackets indicate button names including soft key names (page 19) on the handset and base unit.  |
| <b>Example:</b><br><b>[MENU]</b> → <b>[0][5][1]</b> →<br>Select the desired setting. →<br><b>[Save]</b> → <b>[OFF]</b> | Press <b>[MENU]</b> , then press <b>[0]</b> , <b>[5]</b> , <b>[1]</b> . Press <b>[▲]</b> or <b>[▼]</b> to select the desired setting. Press <b>[Save]</b> , then press <b>[OFF]</b> . |

## Introduction

---

### Expanding your phone system

For the following models, you can expand the system by adding accessory handsets (sold separately):

- KX-TG5632/KX-TG5633: max. 4 handsets
- KX-TG5652: max. 3 handsets

#### KX-TG5632

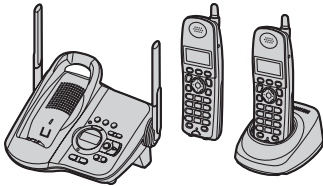

+

Accessory handset (up to 2)  
KX-TGA560



#### KX-TG5633

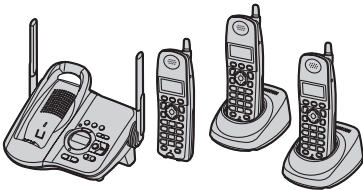

+

Accessory handset (up to 1)  
KX-TGA560



#### KX-TG5652



+

Accessory handset (up to 1)  
KX-TGA560



## Accessory information

### Included accessories

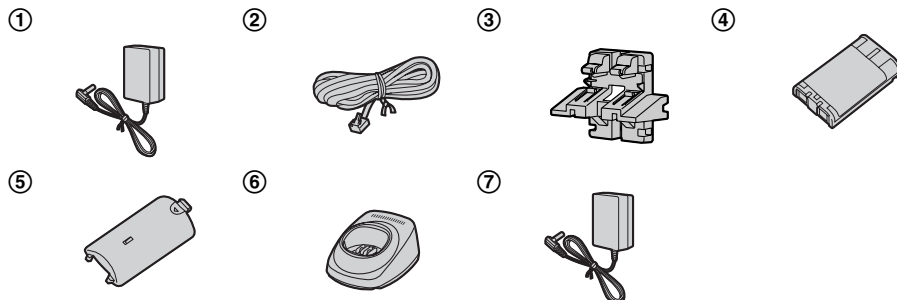

#### ■ KX-TG5631/KX-TG5632/KX-TG5633/KX-TG5634

| No. | Accessory item              | Order number                     | Quantity    |             |             |             |             |             |
|-----|-----------------------------|----------------------------------|-------------|-------------|-------------|-------------|-------------|-------------|
|     |                             |                                  | KX-TG 5631S | KX-TG 5632M | KX-TG 5633B | KX-TG 5633W | KX-TG 5634S | KX-TG 5634M |
| ①   | AC adaptor for base unit    | PQLV1W or PQLV256Z <sup>*1</sup> | 1           | 1           | 1           | 1           | 1           | 1           |
| ②   | Telephone line cord         | PQJA10075Z                       | 1           | 1           | 1           | 1           | 1           | 1           |
| ③   | Wall mounting adaptor       | PQKL10068Z1                      | 1           | —           | —           | —           | 1           | —           |
|     |                             | PQKL10068Z4                      | —           | 1           | 1           | —           | —           | 1           |
|     |                             | PQKL10068Z3                      | —           | —           | —           | 1           | —           | —           |
| ④   | Battery                     | HHR-P104                         | 1           | 2           | 3           | 3           | 4           | 4           |
| ⑤   | Handset cover <sup>*2</sup> | PQYNTG5631SR                     | 1           | —           | —           | —           | 4           | —           |
|     |                             | PQYNTG5633BR                     | —           | —           | 3           | —           | —           | —           |
|     |                             | PQYNTG5632MR                     | —           | 2           | —           | —           | —           | 4           |
|     |                             | PQYNTG5633WR                     | —           | —           | —           | 3           | —           | —           |

## Introduction

| No. | Accessory item         | Order number                        | Quantity       |                |                |                |                |                |
|-----|------------------------|-------------------------------------|----------------|----------------|----------------|----------------|----------------|----------------|
|     |                        |                                     | KX-TG<br>5631S | KX-TG<br>5632M | KX-TG<br>5633B | KX-TG<br>5633W | KX-TG<br>5634S | KX-TG<br>5634M |
| ⑥   | Charger                | PQLV30042ZS                         | –              | –              | –              | –              | 3              | –              |
|     |                        | PQLV30042ZB                         | –              | –              | 2              | –              | –              | –              |
|     |                        | PQLV30042ZM                         | –              | 1              | –              | –              | –              | 3              |
|     |                        | PQLV30042ZW                         | –              | –              | –              | 2              | –              | –              |
| ⑦   | AC adaptor for charger | KX-TCA1-2 or PQLV256Z <sup>*1</sup> | –              | 1              | 2              | 2              | 3              | 3              |

\*1 Both of the AC adaptors function well.

\*2 The handset cover comes attached to the handset.

### ■ KX-TG5651/KX-TG5652/KX-TG5653

| No. | Accessory item              | Order number                        | Quantity       |                |                |
|-----|-----------------------------|-------------------------------------|----------------|----------------|----------------|
|     |                             |                                     | KX-TG<br>5651S | KX-TG<br>5652M | KX-TG<br>5653B |
| ①   | AC adaptor for base unit    | PQLV1W or PQLV256Z <sup>*1</sup>    | 1              | 1              | 1              |
| ②   | Telephone line cord         | PQJA10075Z                          | 1              | 1              | 1              |
| ③   | Wall mounting adaptor       | PQKL10068Z1                         | 1              | –              | –              |
|     |                             | PQKL10068Z4                         | –              | 1              | 1              |
| ④   | Battery                     | HHR-P104                            | 1              | 2              | 3              |
| ⑤   | Handset cover <sup>*2</sup> | PQYNTG5631SR                        | 1              | –              | –              |
|     |                             | PQYNTG5632MR                        | –              | 2              | –              |
|     |                             | PQYNTG5633BR                        | –              | –              | 3              |
| ⑥   | Charger                     | PQLV30042ZM                         | –              | 1              | –              |
|     |                             | PQLV30042ZB                         | –              | –              | 2              |
| ⑦   | AC adaptor for charger      | KX-TCA1-2 or PQLV256Z <sup>*1</sup> | –              | 1              | 2              |

\*1 Both of the AC adaptors function well.

\*2 The handset cover comes attached to the handset.



## Additional/replacement accessories

| Accessory item                                    | Order number  |
|---|---|
| Rechargeable nickel metal hydride (Ni-MH) battery | HHR-P104  |
| Accessory handset with charger*1                  | KX-TGA560   |
| Headset   | KX-TCA60, KX-TCA86, KX-TCA88HA, KX-TCA91, KX-TCA92, or KX-TCA98 |
| T-adaptor   | KX-J66  |
| Battery back-up power supply                      | KX-TCA200   |

\*1 KX-TG5632/KX-TG5633/KX-TG5652 only

| Accessory item | KX-TG5631S/<br>KX-TG5634S/<br>KX-TG5651S | KX-TG5632M/<br>KX-TG5634M/<br>KX-TG5652M | KX-TG5633B/<br>KX-TG5653B | KX-TG5633W  |
|----------------|--|--|---------------------------|-------------|
| Belt clip      | PQKE10396Z1                              | PQKE10396Z2                              | PQKE10396Z3               | PQKE10396Z4 |

## Sales and support information

- To order replacement accessories, call 1-800-332-5368.
- TTY users (hearing or speech impaired users) can call 1-866-605-1277.

# Important safety instructions

When using the product, basic safety precautions should always be followed to reduce the risk of fire, electric shock, or personal injury.

1. Read all instructions carefully.
2. Follow all warnings and instructions marked on the product.
3. Unplug the product from power outlets before cleaning. Do not use liquid or aerosol cleaners. Use a moist cloth for cleaning.
4. Do not use the product near water, for example near a bathtub, wash bowl, kitchen sink, etc.
5. Place the product securely on a stable surface. Serious damage and/or injury may result if the product falls.
6. Do not cover slots and openings on the product. They are provided for ventilation and protection against overheating. Never place the product near radiators, or in a place where proper ventilation is not provided.
7. Use only the power source marked on the product. If you are not sure of the type of power supplied to your home, consult your dealer or local power company.
8. Do not place objects on the power cord. Install the product where no one can step or trip on the cord.
9. Do not overload power outlets and extension cords. This can result in the risk of fire or electric shock.
10. Never push any objects through slots in the product. This may result in the

risk of fire or electric shock. Never spill any liquid on the product.

11. To reduce the risk of electric shock, do not disassemble the product. Take the product to an authorized service center when service is required. Opening or removing covers may expose you to dangerous voltages or other risks. Incorrect reassembly can cause electric shock when the product is subsequently used.
12. Unplug the product from power outlets and take to an authorized service center when the following conditions occur:
  - A. When the power cord is damaged or frayed.
  - B. If liquid has been spilled into the product.
  - C. If the product has been exposed to rain or water.
  - D. If the product does not work normally by following the operating instructions. Adjust only controls covered by the operating instructions. Improper adjustment may require extensive work by an authorized service center.
  - E. If the product has been dropped or physically damaged.
  - F. If the product exhibits a distinct change in performance.
13. During thunderstorms, avoid using telephones except cordless types. There may be a remote risk of an electric shock from lightning.
14. Do not use the product to report a gas leak, when in the vicinity of the leak.

## SAVE THESE INSTRUCTIONS

### **CAUTION:**

#### **Installation**

- Never install telephone wiring during a lightning storm.
- Never install telephone jacks in wet locations unless the jack is specifically designed for wet locations.
- Never touch uninsulated telephone wires or terminals unless the telephone line has been disconnected at the network interface.
- Use caution when installing or modifying telephone lines.
- Do not touch the plug with wet hands.
- The AC adaptor is used as the main disconnect device. Ensure that the AC outlet is installed near the product and is easily accessible.

#### **Battery**

To reduce the risk of fire or injury to persons, read and follow these instructions.

- Use only the battery(ies) specified.
- Do not dispose of the battery(ies) in a fire. They may explode. Check with local waste management codes for special disposal instructions.
- Do not open or mutilate the battery(ies). Released electrolyte is corrosive and may cause burns or injury to the eyes or skin. The electrolyte may be toxic if swallowed.
- Exercise care when handling the battery(ies). Do not allow conductive materials such as rings, bracelets or keys to touch the battery(ies), otherwise a short circuit may cause the battery(ies) and/or the conductive material to overheat and cause burns.

- Charge the battery(ies) provided, or identified for use with the product only, in accordance with the instructions and limitations specified in this manual.

### **WARNING:**

- To prevent the risk of fire or electrical shock, do not expose the product to rain or any type of moisture.
- Unplug the product from power outlets if it emits smoke, an abnormal smell, or makes an unusual noise. These conditions can cause fire or electric shock. Confirm that smoke has stopped emitting and contact the Panasonic Call Center at 1-800-211-PANA (1-800-211-7262).

### **Medical**

- Consult the manufacturer of any personal medical devices, such as pacemakers or hearing aids, to determine if they are adequately shielded from external RF (radio frequency) energy. (The product operates in the frequency range of 5.76 GHz to 5.84 GHz, and the power output is 200 mW (max.)) Do not use the product in health care facilities if any regulations posted in the area instruct you not to do so. Hospitals or health care facilities may be using equipment that could be sensitive to external RF energy.

---

### For best performance

---

#### Base unit location/avoiding noise

The base unit and other compatible Panasonic units use radio waves to communicate with each other.

For maximum distance and noise-free operation, we recommend the following:

- Placing the product away from electrical appliances.
- Placing the base unit in a HIGH and CENTRAL location with no obstructions such as walls.
- Raising the antennas vertically.
- If you use the handset near a microwave oven which is being used, noise may be heard. Move away from the microwave oven and closer to the base unit.
- If you use the handset near another cordless phone's base unit, noise may be heard. Move away from the other cordless phone's base unit and closer to your base unit.

---

#### Environment

- Keep the product away from electrical noise generating devices, such as fluorescent lamps and motors.
- The product should be kept free from excessive smoke, dust, high temperature, and vibration.
- The product should not be exposed to direct sunlight.
- Do not place heavy objects on top of the product.
- When you leave the product unused for a long period of time, unplug the product from the power outlet.

- The product should be kept away from heat sources such as heaters, kitchen stoves, etc. It should not be placed in rooms where the temperature is less than 5 °C (41 °F) or greater than 40 °C (104 °F). Damp basements should also be avoided.
- The maximum calling distance may be shortened when the product is used in the following places: Near obstacles such as hills, tunnels, underground, near metal objects such as wire fences, etc.
- Operating near 5.8 GHz electrical appliances may cause interference. Move away from the electrical appliances.

---

#### Routine care

- Wipe the outer surface of the product with a soft moist cloth. Do not use benzine, thinner, or any abrasive powder.

## Setting up the base unit

### Connecting the AC adaptor and telephone line cord

Connect the telephone line cord until it clicks into the base unit (❶) and telephone line jack (❷). Connect the AC adaptor cord by pressing the plug firmly (❸).

- Use only the included Panasonic AC adaptor PQLV1 or PQLV256.

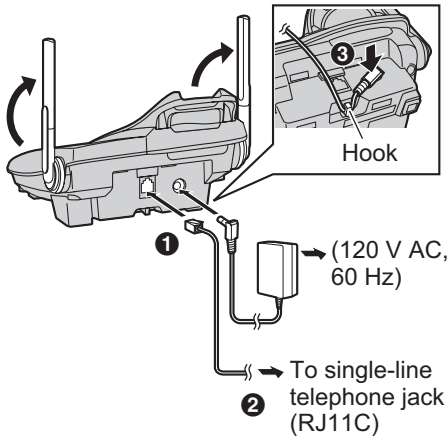

#### Note:

- The AC adaptor must remain connected at all times. (It is normal for the adaptor to feel warm during use.)
- The AC adaptor should be connected to a vertically oriented or floor-mounted AC outlet. Do not connect the AC adaptor to a ceiling-mounted AC outlet, as the weight of the adaptor may cause it to become disconnected.
- The unit will not work during a power failure. We recommend connecting a

standard telephone to the same telephone line or to the same telephone jack using a Panasonic T-adaptor (page 9). Emergency power can be supplied to the unit by connecting a Panasonic battery back-up power supply noted on page 9.

#### If you subscribe to a DSL service

Please attach a noise filter (contact your DSL provider) to the telephone line between the base unit and the telephone line jack in the event of the following:

- Noise is heard during conversations.
- Caller ID features (page 29) do not function properly.

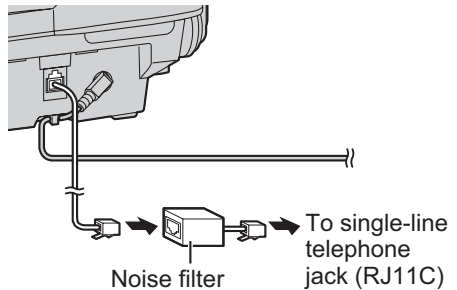

# Setting up the handset

## Connecting the charger

### Available model:

KX-TG5632/KX-TG5633/KX-TG5634/  
KX-TG5652/KX-TG5653

- Use only the included Panasonic AC adaptor KX-TCA1 or PQLV256.

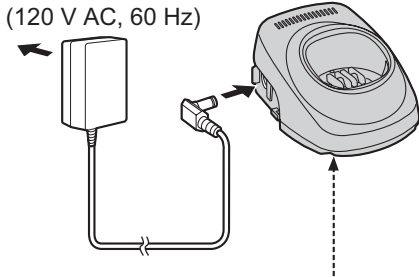

Bottom of the charger

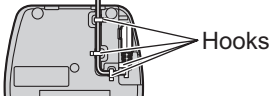

Fasten the AC adaptor cord to prevent it from being disconnected.

## Battery installation/replacement

- 1 Press the notch of the handset cover firmly, and slide it in the direction of the arrow.
  - If necessary, remove the old battery.



- 2 Insert the battery (1), and press it down until it snaps into position (2). Then close the handset cover.

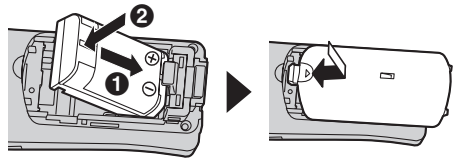

### Important:

- Use only the rechargeable Panasonic battery noted on page 9.

## Attention:



A nickel metal hydride battery that is recyclable powers the product you have purchased.

Please call 1-800-8-BATTERY (1-800-822-8837) for information on how to recycle this battery.

## Battery charge

Place the handset on the base unit or charger for **7 hours** before initial use. While charging, “**Charging**” is displayed and the CHARGE indicator on the base unit lights. When the battery is fully charged, “**Charge completed**” is displayed.

## Base unit:

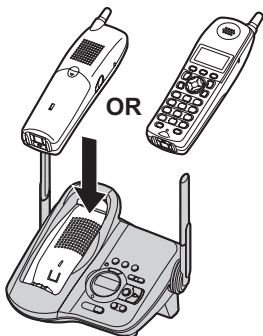

- Model shown is KX-TG5631.

## Charger:

### Available model:

KX-TG5632/KX-TG5633/KX-TG5634/  
KX-TG5652/KX-TG5653

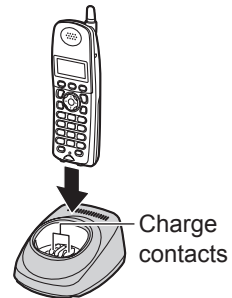





## Note:

- If you want to use the unit immediately, charge the battery for at least 15 minutes.
- To ensure that the battery charges properly, clean the charge contacts of the handset, base unit, and charger with a soft, dry cloth once a month. Clean more often if the unit is subject to the exposure of grease, dust, or high humidity.

## Preparation

### Battery level

| Battery icon   | Battery level                           |
|--|---|
|  | Fully charged                           |
|  | Medium                                  |
|  | Low<br>Flashing: needs to be recharged. |
|  | Empty                                   |

### Note:

- When the battery needs to be charged, the handset beeps intermittently while it is in use.

### Panasonic battery performance

| Operation   | Operating time |
|---|----------------|
| While in use (talking)                            | Up to 5 hours  |
| While not in use (standby)                        | Up to 11 days  |
| While using the clarity booster feature (page 24) | Up to 3 hours  |

### Note:

- Battery operating time may be shortened over time depending on usage conditions and surrounding temperature.
- Battery power is consumed whenever the handset is off the base unit or charger, even when the handset is not in use. Hence the longer you leave the handset off the base unit or charger, the less time you may actually talk using the handset.

- After the handset is fully charged, displaying "Charge completed", it may be left on the base unit (or charger) without any ill effect on the battery.
- The battery level may not be displayed correctly after you replace the battery. In this case, place the handset on the base unit (or charger) and let charge for 7 hours.



# Controls

## Base unit

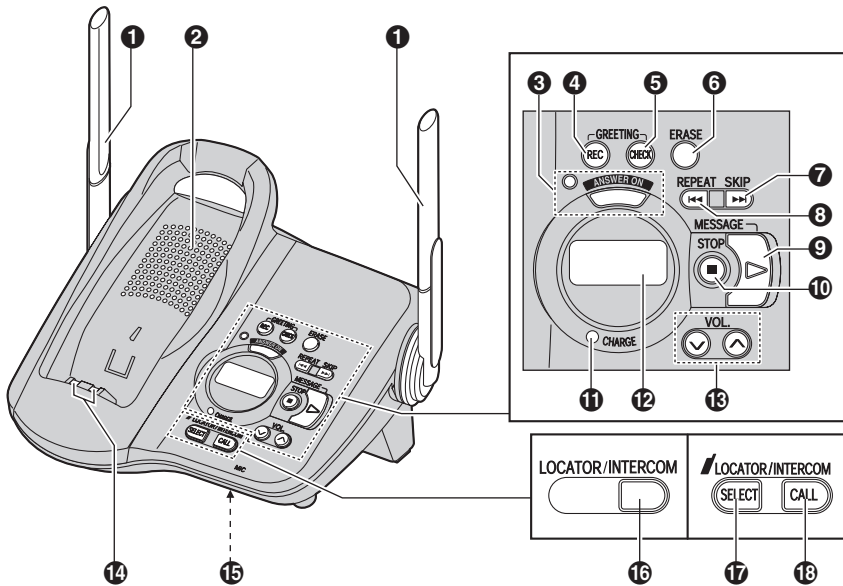

- ❶ Antennas
- ❷ Speaker
- ❸ [ANSWER ON]  
ANSWER ON indicator
- ❹ [GREETING REC] (Recording)
- ❺ [GREETING CHECK]
- ❻ [ERASE]
- ❼ [▶▶] (SKIP)
- ❽ [◀◀] (REPEAT)
- ❾ [MESSAGE]  
MESSAGE indicator
- ❿ [STOP]
- ⓫ CHARGE indicator
- ⓬ Display
- ⓭ VOL. (Volume) [∨] [∧]
- ⓮ Charge contacts
- ⓯ MIC (Microphone)
- ⓰ [LOCATOR/INTERCOM]\*<sup>1</sup>
- ⓱ [SELECT]\*<sup>2</sup>
- ⓲ [CALL]\*<sup>2</sup>

\*1 KX-TG5631/KX-TG5651

\*2 KX-TG5632/KX-TG5633/KX-TG5634/KX-TG5652/KX-TG5653

# Preparation

## Handset

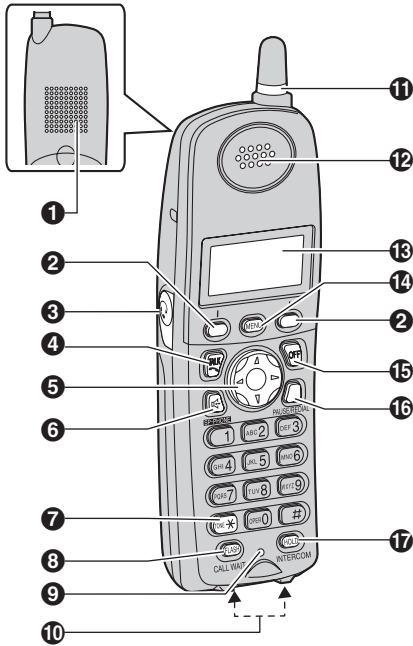

- ❶ Speaker
- ❷ Soft keys
- ❸ Headset jack
- ❹ [TALK]
- ❺ Navigator key ([▲] [▼] [◀] [▶])
- ❻ [SP-PHONE]
- ❼ [TONE]
- ❽ [FLASH] [CALL WAIT]
- ❾ Microphone
- ❿ Charge contacts
- ⓫ Ringer indicator  
Message indicator
- ⓬ Receiver
- ⓭ Display

- ⓬ [MENU]
- ⓭ [OFF]
- ⓮ [PAUSE/REDIAL]
- ⓯ [HOLD] [INTERCOM]

### Note:

- Some operations not mentioned above are displayed as soft key selections during operation (page 19).

**Example: [Mute]**

### Using the navigator key

The handset navigator key can be used to navigate through menus and to select items shown on the display, by pressing [▲], [▼], [◀], or [▶].

### Adjusting audio volume

Press [▲] or [▼] repeatedly while talking.

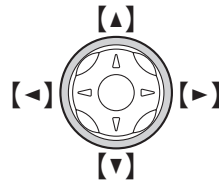

## Handset soft keys

The handset features 2 soft keys. By pressing a soft key, you can select the feature shown directly above it on the display.

**[Select]**, **[Save]**, **[OK]** and additional other functions are assigned to soft keys, pay attention to soft keys to find functions you need during handset operation.

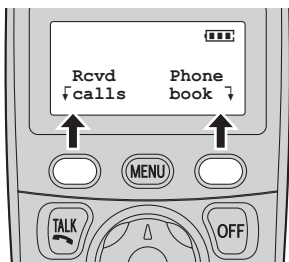

### Note:

- In these operating instructions, soft key names are written inside brackets, the same way as other unit keys.





### Example:

Unit keys: **[**, **[OFF]**, etc.

Soft keys: **[Rcvd calls]**, **[Phonebook]**, etc.



## Displays

### Base unit display items

| Displayed item  | Meaning  |
|---|--|
| <b>FULL</b>   | Flashes when message memory is full.   |
|    | Flashes when the date and time need to be set.   |
| <b>IN USE</b>   | Base unit is on an intercom call, or handset is using the answering system.<br>When flashing: base unit is paging or is being paged.                           |
| <b>LINE</b><br><b>IN USE</b>  | The line is in use.<br>When flashing: the call is put on hold or the answering system is answering a call.<br>When flashing rapidly: a call is being received. |
| <b>RINGER OFF</b>   | Base unit ringer is off.   |
|    | Greeting message recording error   |
|   | Answering system is in greeting only mode (caller messages are not recorded).  |
|  | Handset number; displayed when paging, being paged or registering.*1   |

\*1 For models with 2 or more handsets included only (page 4).

### Handset display items

| Displayed item   | Meaning               |
|--|-----------------------|
|  | Voice enhancer is on. |
|  | Battery level         |

---

## Setting the unit before use

---

### Display language

The default setting is "English".

- 1** [MENU] → [0][8]
- 2** Select the desired setting.
- 3** Press the right soft key to save. → [OFF]

---

### Dialing mode

If you cannot make calls, change this setting depending on your telephone line service. The default setting is "Tone".

"Tone": For tone dial service.

"Pulse": For rotary pulse dial service.

- 1** [MENU] → [0][5][1]
- 2** Select the desired setting. → [Save] → [OFF]

---

### Date and time

Set the correct date and time. When you play back a message from the answering system (page 39), the unit announces the day and time it was recorded.

**1 [MENU] → [4]**

**2** Enter the current month, day, and year by selecting 2 digits for each.

**Example:** August 15, 2006

**[0][8] [1][5] [0][6]**

**3** Enter the current hour and minute (12-hour clock format) by selecting 2 digits for each.

**Example:** 9:30

**[0][9] [3][0]**

**4** Press **[AM/PM]** to select “**AM**” or “**PM**”.  
→ **[Save]** → **[OFF]**

### Note:

- If you make a mistake when entering the date and time, press **[◀]**, **[▶]**, **[▲]**, or **[▼]** to move the cursor, then make the correction.

---

### Making calls

- 1 Lift the handset and dial the phone number.
  - To correct a digit, press **[Clear]**.
- 2 Press **[↶]** or **[Call]**.
- 3 When you finish talking, press **[OFF]** or place the handset on the base unit or charger.

#### Note:

- “Line in use” is displayed when someone is talking on another handset (for models with 2 or more handsets included only: page 4) or another phone.

---

### Using the speakerphone

- 1 Lift the handset, dial the phone number, and press **[☎]**.
  - Speak alternately with the other party.
- 2 When you finish talking, press **[OFF]**.

#### Note:

- Use the speakerphone in a quiet environment.
- To switch to the receiver, press **[↶]**.

---

### Adjusting the receiver/speaker volume

Press **[▲]** or **[▼]** repeatedly while talking.

---

### Making a call using the redial list

The last 5 phone numbers dialed are stored in the redial list.

#### 1 **[REDIAL]**

- 2 Press **[▲]** or **[▼]** to select the desired number.

#### 3 **[↶]**

---

### Erasing a number in the redial list

#### 1 **[REDIAL]**

- 2 Press **[▲]** or **[▼]** to select the desired number. → **[Erase]** → **[Yes]** → **[OFF]**

---

### PAUSE button (for PBX/long distance service users)

A pause is sometimes required when making calls using a PBX or long distance service.

For example, if you need to dial the line access number “9” when making outside calls with a PBX:

- 1 **[9]** → **[PAUSE]** → Dial the phone number.







#### 2 **[↶]**

#### Note:

- A 3.5 second pause is inserted each time **[PAUSE]** is pressed. Press repeatedly to insert longer pauses.

## Answering calls

When a call is being received, the ringer indicator flashes rapidly.

- 1 Lift the handset and press **[]** or **[]**.
  - You can also answer the call by pressing any button except **[]**, **[]**, **[]**, **[]**, or **[OFF]**. (Any key talk feature)

- 2 When you finish talking, press **[OFF]**.

### Note:

- You can change the ringer indicator light color and the ringer tone. You can also adjust the handset ringer volume (page 36).



### Auto talk

This feature allows you to answer a call by simply lifting the handset off the base unit or charger. You do not need to press **[]**. To activate this feature, see page 35.

### Temporary ringer off

While the handset is ringing for an outside call, you can turn the ringer off temporarily by pressing **[OFF]**.

### Adjusting the base unit ringer volume

Press **[]** or **[]** repeatedly to select the desired volume.

- To turn the ringer off, press and hold **[]** until the unit beeps 2 times.

## Useful features during a call

### HOLD button

This feature allows you to put an outside call on hold.

#### For models with only 1 handset included



Press **[HOLD]** during an outside call.

- To release the hold, press **[]**.

### Note:

- If another phone is connected on the same line (page 13), you can also take the call by lifting its handset.
- If a call is kept on hold for more than 6 minutes, an alarm tone starts to sound. After 4 additional minutes on hold, the call is disconnected.

#### For models with 2 or more handsets included

- 1 Press **[HOLD]** during an outside call.
  - To transfer the call to another handset, continue from step 2 on page 45, "Transferring calls between handsets, conference calls".
- 2 Press **[HOLD]** again.
  - To release the hold, press **[]**.
  - Another handset user can take the call by pressing **[]**.

### Note:

- If another phone is connected on the same line (page 13), you can also take the call by lifting its handset.

## Making/Answering Calls

---

- If a call is kept on hold for more than 6 minutes, an alarm tone starts to sound. After 4 additional minutes on hold, the call is disconnected.

---

### Mute

While mute is turned on, you can hear the other party, but the other party cannot hear you.

To mute your voice, press **[Mute]**.

- To return to the conversation, press **[Mute]** or **[↶]**.

### Note:

- **[Mute]** is a soft key visible on the handset display during a call.

---

### FLASH button

Pressing **[FLASH]** allows you to use special features of your host PBX such as transferring an extension call, or accessing optional telephone services such as Call Waiting.

### Note:

- To change the flash time, see page 36.

---

### For Call Waiting service users

To use Call Waiting, you must subscribe to your telephone company's Call Waiting service.

This feature allows you to receive calls while you are already talking on the phone. If you receive a call while on the phone, you will hear a Call Waiting tone. Please contact your telephone company for details and availability of this service in your area.

Press **[CALL WAIT]** to answer the 2nd call.

- To switch between calls, press **[CALL WAIT]**.

---

### Temporary tone dialing (for rotary/pulse service users)

You can temporarily switch the dialing mode to tone when you need to access touch tone services (for example, answering services, telephone banking services, etc.).

Press **[\*]** (TONE) before entering access numbers which require tone dialing.

---

### Handset clarity booster

This feature can improve sound clarity when the handset is used in an area where there may be interference. During an outside call, this feature is turned on automatically when necessary. You can also turn this feature on or off manually.

- 1 Press **[MENU]** during an outside call.
- 2 Press **[2]** to select "Booster on" or "Booster off".

### Note:

- When this feature is turned off manually during a call, it is not turned on automatically during the same call.
- While this feature is turned on;
  - the battery operating time is shortened (page 16).
  - the maximum number of extensions that can be used at a time may decrease when you have 3 or more handsets.



---

### Handset voice enhancer

This feature clarifies the voice of the person you are talking to, reproducing a more natural-sounding voice that is easier to hear and understand (page 36).

Press **[(VE)]** during an outside call to turn on or off this feature.

- When this feature is turned on, **[(VE)]** is displayed.

#### Note:

- **[(VE)]** is a soft key visible on the handset during an outside call.
- Depending on the condition and quality of your telephone line, this feature may emphasize existing line noise. If it becomes difficult to hear, turn this feature off.

---

### Call share

**Available model:**

KX-TG5632/KX-TG5633/KX-TG5634/  
KX-TG5652/KX-TG5653

This feature allows the handset to join an existing outside call.

To join the conversation, press **[↶]** when the other handset is on an outside call.

#### Note:

- A maximum of 4 parties (including 1 outside party) can join a conversation using 3 extensions.

## Handset phonebook

You can add up to 50 items to the handset phonebook and search for phonebook items by name.

### Adding items to the phonebook

#### 1 [Phonebook]

#### 2 [Add]

3 Enter the name (max. 16 characters).  
→ [Next]

4 Enter the phone number (max. 32 digits). → [Next] → [Save]  
• To add other items, repeat from step 2.

#### 5 [OFF]

##### Note:

- Caller ID subscribers can use ringer ID and light-up ID features (page 30).

### Character table

| Key | Character         |
|-----|-------------------|
| [1] | & ' ( ) , - . / 1 |
| [2] | a b c A B C 2     |
| [3] | d e f D E F 3     |
| [4] | g h i G H I 4     |
| [5] | j k l J K L 5     |
| [6] | m n o M N O 6     |
| [7] | p q r s P Q R S 7 |
| [8] | t u v T U V 8     |
| [9] | w x y z W X Y Z 9 |

| Key | Character |
|-----|-----------|
| [0] | 0 Space   |
| [*] | *         |
| [#] | #         |

- To enter another character that is located on the same dial key, first press [▶] to move the cursor to the next space.

### Editing/correcting a mistake

Press [◀] or [▶] to move the cursor to the character or number you want to erase, then press [Clear]. Enter the appropriate character or number.

- Press and hold [Clear] to erase all characters or numbers.

### Finding and calling a phonebook item

Phonebook items can be searched for alphabetically by scrolling through the phonebook items or by entering the first initial.

### Searching for a name alphabetically by scrolling through all items

1 [Phonebook] → [Search]

2 Press [▲] or [▼] to select the desired item.

3 Press [↵] to dial the phone number.

## Searching for a name by initial

- 1 **[Phonebook]** → **[Search]**
- 2 Press the dial key (**[0]** – **[9]**, **[#]**, or **[\*]**) that corresponds to the first letter you are searching for (see the character table, page 26).  
**Example:** “LISA”  
 Press **[5]** repeatedly to display the first phonebook entry starting with the initial “L” and go to step 3.
  - If there is no item corresponding to the letter you selected, the next item is displayed.
- 3 Press **[v]** to select the desired item.
- 4 Press **[↵]** to dial the phone number.

## Editing items in the phonebook

- 1 Find the desired item (page 26, 27). → **[Option]** → “Edit” → **[Select]**
- 2 Edit the name if necessary (see the character table, page 26). → **[Next]**
- 3 Edit the phone number if necessary. → **[Next]** → **[Save]** → **[OFF]**

## Erasing items in the phonebook

- 1 Find the desired item (page 26, 27).
- 2 **[Erase]** → **[Yes]** → **[OFF]**

## Chain dial

This feature allows you to dial phone numbers in the handset phonebook while you are on a call. This feature can be used, for example, to dial a calling card access number or bank account PIN that you have stored in the handset phonebook, without having to dial manually.

- 1 During an outside call, press **[MENU]**.
- 2 “Phonebook” → **[Select]**
- 3 Find the desired item (page 26, 27). → **[Call]**

### Note:

- When storing a calling card access number and your PIN in the phonebook as one phonebook item, press **[PAUSE]** to add pauses after the number and PIN as necessary (page 22).
- If you have rotary or pulse service, you need to press **[\*]** before pressing **[MENU]** in step 1 to change the dialing mode temporarily to tone.

---

---

# Copying handset phonebook items

### Available model:

KX-TG5632/KX-TG5633/KX-TG5634/  
KX-TG5652/KX-TG5653

You can copy one or all of the phonebook items from one handset to another.

### Important:

- Ringer ID and light-up ID settings for phonebook items are not copied.

---

### Copying an item

- 1** **[MENU]** → **[#][1]**
- 2** Select the destination unit by pressing **[▲]** or **[▼]**. → **[Next]**
- 3** Find the desired item (page 26, 27). → **[Send]**
- 4** Press **[OFF]** after the long beep.

---

### Copying all items

- 1** **[MENU]** → **[#][2]**
- 2** Select the destination unit by pressing **[▲]** or **[▼]**. → **[Send]**
- 3** Press **[OFF]** after the long beep.

---

## Using Caller ID service

This unit is Caller ID compatible. To use Caller ID features, you must subscribe to your telephone company's Caller ID service.

---

### Caller ID features

When an outside call is being received, the calling party's name and telephone number are displayed.

Caller information for the last 50 different callers is logged in the caller list by the most recent call to the oldest.

- Generally caller information is displayed from the 2nd ring.
- If the unit cannot receive caller information, the following is displayed:
  - “**Out of area**”: The caller dialed from an area which does not provide Caller ID service.
  - “**Private caller**”: The caller requested not to send caller information.
  - “**Long distance**”: The caller called you long distance.
- If the unit is connected to a PBX system, caller information may not be received properly. Consult your PBX supplier.

---

### Missed calls

If a call is not answered, the unit treats the call as a missed call. The number of missed calls is shown on the handset display. This lets you know if you should view the caller list to see who called while you were out.

---

### Private name display

#### Available model:

KX-TG5631/KX-TG5632/KX-TG5633/  
KX-TG5634

When caller information is received and it matches a phone number stored in the phonebook, the stored name is displayed and logged in the caller list.

---

### Call Waiting Caller ID display

If you subscribe to both Caller ID and Call Waiting with Caller ID services, the 2nd caller's information is displayed after you hear a Call Waiting tone (page 24).

Please contact your telephone company for details and availability of this service in your area.

---

### Talking Caller ID

#### Available model:

KX-TG5651/KX-TG5652/KX-TG5653

This feature lets you know who is calling without looking at the display. When a call comes in, the handset and base unit announce the caller's name displayed on the handset following every ring.

To use this feature, you must subscribe to your telephone company's Caller ID service.

- Name pronunciation may vary. This feature may not pronounce all names correctly.
- Caller ID supports names of up to 15 letters. If the caller's name has more than 15 letters, the name is not displayed or announced correctly.

## Caller ID Service

---

- Usually the unit announces the caller's name after the 2nd ring. If you turn on the answering system and set the ring count to "2" (page 42), the unit does not announce the caller's name. If "Toll saver" is selected and there is a new message, the unit does not announce the caller's name.
- When you receive a call while on the phone, the 2nd caller's name is not announced even if you subscribe to both Caller ID and Call Waiting with Caller ID services.
- This feature can be turned on or off (page 36).

---

### Ringer ID

This feature can help you identify who is calling by using different ringers for different callers stored in the phonebook. You can assign a different ringer to each phonebook item. When a call is received from a caller stored in the phonebook, the ringer is used after Caller ID information is displayed.

If you select "No Ringer ID", the handset uses the ringer tone you selected on page 36 when a call is received from that caller. The default setting is "No Ringer ID".

- 1 Find the desired item (page 26, 27). → **[Option]**
- 2 "Ringer ID" → **[Select]**
- 3 Select the desired ringer tone.
- 4 **[Save]** → **[OFF]**

---

### Light-up ID

This feature can help you identify who is calling by using different ringer indicator colors for different callers stored in the handset phonebook. You can assign a different indicator color to each handset phonebook item. When a call is received from a caller stored in the handset phonebook, the indicator color is used after Caller ID information is displayed. If you select "No Light-up ID", the handset uses the ringer indicator color you selected on page 36 when a call is received from that caller.

The default setting is "No Light-up ID".

- 1 Find the desired item (page 26, 27). → **[Option]**
- 2 "Light-up ID" → **[Select]**
- 3 Select the desired ringer indicator color.
- 4 **[Save]** → **[OFF]**

## Caller list

### Viewing the caller list and calling back

- 1 Press **[▲]** or **[▼]** to enter the caller list.
- 2 Press **[▼]** to search from the most recent call, or **[▲]** to search from the oldest call.

### 3

#### Note:

- For models with 2 or more handsets included only (page 4):  
Each handset has its own caller list. If you viewed the caller list or answered a call on one handset, the same information in the other handsets is displayed as “**missed calls**”.
- You can also press **[Rcvd calls]** to enter the caller list.
- If the same caller calls more than once, it is displayed with the number of times the caller called (“x2” to “x9”). Only the date and time of the most recent call is stored.
- A **✓** is displayed next to items which have already been viewed or answered.

### Editing a caller’s phone number before calling back

You can edit a phone number in the caller list by removing its area code and/or the long distance code “1”.

- 1 Press **[▲]** or **[▼]** to enter the caller list.
- 2 Select the desired item. → **[Select]**

- 3 Press **[Edit]** repeatedly until the phone number is shown in the desired format.

① Local phone number

**Example:**

② Area code – Local phone number

**Example:**

③ 1 – Area code – Local phone number

**Example:**

### 4

#### Caller ID number auto edit feature

Once you call back an edited number, the unit can automatically edit other incoming phone numbers each time you receive a call.

For example, you can use this feature to set the unit to ignore the area code of callers in your area code, so that you can call these local numbers using caller information without dialing the area code.

To activate this feature, you must edit an item in the caller list, then call that number. After that, phone numbers from that caller’s area code are edited automatically. This feature can be turned on or off (page 35).

#### Note:

- Phone numbers from the 4 most recently edited area codes are automatically edited.
- If you move to another area, you can turn this feature off to erase previously edited area codes. To use this feature again, turn it on and reprogram the area codes you want to edit once again.

## Caller ID Service

---

### Storing caller information into the phonebook

- 1** Press **[▲]** or **[▼]** to enter the caller list.
- 2** Select the desired item. → **[Select]**
  - To edit the number, press **[Edit]** repeatedly until the phone number is shown in the desired format.
- 3 [Save]**
  - If there is the name information for the caller, skip to step 5.
- 4** Enter the name (see the character table, page 26). → **[Next]** → **[Save]**
- 5 [OFF]**

---

### Erasing selected caller information

- 1** Press **[▲]** or **[▼]** to enter the caller list.
- 2** Select the desired item.
- 3 [Erase] → [Yes] → [OFF]**

---

### Erasing all caller information

- 1** Press **[▲]** or **[▼]** to enter the caller list.
- 2 [All erase] → [Yes]**



## Programmable settings

You can customize the unit by programming the following features using the handset. To access the features, there are 2 methods: scrolling through the display menus (page 33) or using the direct commands (page 35).

- Mainly the direct command method is used in these operating instructions.

### Programming by scrolling through the display menus

#### 1 [MENU]

2 Press [▲] or [▼] to select the desired menu. → [Select]

- If there is a sub-menu(s), press [▲] or [▼] to select the desired item. → [Select]

**Example:** To access the handset ringer tone setting

Press [▲] or [▼] to select "Ringer setting". → [Select]

Then press [▲] or [▼] to select "Ringer tone". → [Select]

3 Press [▲] or [▼] to select the desired setting.

- This step may vary depending on the feature being programmed.

#### 4 [Save] → [OFF]

| Main menu                      | Sub-menu 1     | Sub-menu 2 | Page    |
|--------------------------------|----------------|------------|---------|
| Message play                   | –              | –          | page 40 |
| Ringer setting                 | Ringer volume  | –          | –       |
|                                | Ringer tone    | –          | –       |
|                                | Ring color     | –          | –       |
| Date and time <sup>*1</sup>    | –              | –          | page 21 |
| Voice enhancer                 | –              | –          | –       |
| Caller IQ <sup>*2</sup>        | View Info.?    | –          | –       |
|                                | Get new Info.? | –          | –       |
|                                | Turn CIQ off?  | –          | –       |
| Copy phonebook <sup>*3</sup>   | Copy 1 item    | –          | page 28 |
|                                | Copy all items | –          | page 28 |
| Talking CallerID <sup>*4</sup> | –              | –          | –       |

## Programming

| Main menu        | Sub-menu 1                    | Sub-menu 2                       | Page    |
|------------------|-------------------------------|----------------------------------|---------|
| Customer support | –                             | –                                | page 37 |
| Initial setting  | Set answering                 | Ring count <sup>*1</sup>         | page 42 |
|                  |                               | Recording time <sup>*1</sup>     | page 43 |
|                  |                               | Remote code <sup>*1</sup>        | page 42 |
|                  | Message alert                 | –                                | page 43 |
|                  | LCD contrast                  | –                                | –       |
|                  | Key tone                      | –                                | –       |
|                  | Auto talk                     | –                                | –       |
|                  | Caller ID edit                | –                                | –       |
|                  | Time adjustment <sup>*1</sup> | –                                | –       |
|                  | Set tel line                  | Set dial mode <sup>*1</sup>      | page 20 |
|                  |                               | Set flash time <sup>*1</sup>     | –       |
|                  |                               | Set line mode <sup>*1</sup>      | –       |
|                  | Set base unit                 | Ringer tone <sup>*1</sup>        | –       |
|                  |                               | Talking CallerID <sup>*1*4</sup> | –       |
| Registration     | –                             | page 46                          |         |
| Change language  | –                             | page 20                          |         |

\*1 If you program these settings using one of the handsets, you do not need to program the same item using another handset (for models with 2 or more handsets included).

\*2 See the leaflet included with this unit for more information (KX-TG5631/KX-TG5632/KX-TG5633/KX-TG5634).

\*3 For models with 2 or more handsets included.

\*4 KX-TG5651/KX-TG5652/KX-TG5653

## Programming using the direct commands

### 1 [MENU]

2 Enter the desired feature code.

3 Enter the desired setting code.

- This step may vary depending on the feature being programmed.

4 [Save] → [OFF]

#### Note:

- In the following table:
  - < > shows the default setting.
  - If “System setting” column is checked, you do not need to program the same item using another handset (for models with 2 or more handsets included).
- If you make a mistake or enter the wrong code, press [OFF], then start again by pressing [MENU].

| Feature  | Feature code | Setting code   | System setting |
|--|--------------|--|----------------|
| Auto talk <sup>*1</sup>                        | [0][3]       | [1]: On [0]: <Off>                                       | –              |
| Caller ID edit<br>(Caller ID number auto edit) | [0][4]       | [1]: <On> [0]: Off<br>(page 31)                          | –              |
| Change language<br>(Display language)          | [0][8]       | [1]: <English><br>[2]: Español (page 20)                 | –              |
| Copy phonebook (1 item) <sup>*2</sup>          | [#][1]       | (page 28)  | –              |
| Copy phonebook (all items) <sup>*2</sup>       | [#][2]       | (page 28)  | –              |
| Date and time                                  | [4]          | (page 21)  | ●              |
| Key tone <sup>*3</sup>                         | [0][2]       | [1]: <On> [0]: Off                                       | –              |
| LCD contrast<br>(Display contrast)             | [0][1]       | [1]–[6]: Level 1–6 <3>                                   | –              |
| Message alert                                  | [0][#]       | [1]: On [0]: <Off>                                       | –              |
| Message play                                   | [2]          | –  | –              |
| Recording time                                 | [0][6][2]    | [1]: 1min [2]: 2min<br>[3]: <3min><br>[0]: Greeting only | ●              |
| Registration                                   | [0][0]       | (page 46)  | –              |
| Remote code                                    | [0][6][3]    | (page 42)  | ●              |

## Programming

| Feature   | Feature code | Setting code  | System setting |
|---|--------------|---|----------------|
| Ring color<br>(Ringer indicator color)                        | [1][4]       | [1]: <Color1>=Amber<br>[2]: Color2=Green<br>[3]: Color3=Red<br>[4]: Multicolor                    | –              |
| Ring count  | [0][6][1]    | [2]–[7]: 2–7 rings <4><br>[0]: Toll saver   | ●              |
| Ringer tone (Base unit)                                       | [0][*][1]    | [1]–[3]: Tone <1>–3   | –              |
| Ringer tone (Handset) <sup>*4</sup>                           | [1][2]       | [1]–[3]: Tone <1>–3<br>[4]–[7]: Melody 1–4  | –              |
| Ringer volume (Handset)                                       | [1][1]       | [1]: Low [2]: Medium<br>[3]: <High> [0]: Off  | –              |
| Set dial mode   | [0][5][1]    | [1]: Pulse [2]: <Tone><br>(page 20)   | ●              |
| Set flash time <sup>*5</sup>                                  | [0][5][2]    | [1]: <700ms> [2]: 600ms<br>[3]: 400ms [4]: 300ms<br>[5]: 250ms [6]: 110ms<br>[7]: 100ms [8]: 90ms | ●              |
| Set line mode <sup>*6</sup>                                   | [0][5][3]    | [1]: A [2]: <B>   | ●              |
| Talking CallerID <sup>*7</sup><br>(Handset)                   | [9]          | [1]: <On> [0]: Off<br>(page 29)   | –              |
| Talking CallerID <sup>*7</sup><br>(Base unit)                 | [0][*][4]    | [1]: <On> [0]: Off<br>(page 29)   | –              |
| Time adjustment <sup>*8</sup><br>(Caller ID subscribers only) | [0][9]       | [1]: <Caller ID [auto]><br>[0]: Manual  | ●              |
| Voice enhancer  | [5]          | [1]: On [0]: <Off>  | –              |

\*1 If you subscribe to Caller ID service and want to view the caller's information after lifting up the handset to answer a call, turn off this feature.

\*2 KX-TG5632/KX-TG5633/KX-TG5634/KX-TG5652/KX-TG5653

\*3 You can select whether or not key tones are heard when keys are pressed. Includes confirmation tones and error tones.

\*4 If you subscribe to a distinctive ring service (such as IDENT-A-RING), select a tone (tone 1 to 3). If you select a melody, you cannot distinguish lines by their ringers.

- \*5 The flash time depends on your telephone exchange or host PBX. Consult your PBX supplier if necessary. The setting should stay at “700ms” unless pressing **[FLASH]** fails to pick up the call waiting call.
- \*6 Generally, the line mode setting should not be adjusted. If “Line in use” is not displayed when another phone connected to the same line is in use, you need to change the line mode to “A”.
- \*7 KX-TG5651/KX-TG5652/KX-TG5653
- \*8 This feature allows the unit to automatically adjust the date and time setting when caller information is received. To use this feature, set the date and time first.

---

### Customer support

The handset can display the Internet address where you can download the operating instructions or get further information for this product using your computer.

**[MENU]** → “Customer support” → **[Select]** → **[OFF]**

---

### Answering system

#### Important:

- Only 1 person can access the answering system at a time.
- When callers leave messages, the unit records the day and time of each message. Make sure the date and time have been set (page 21).

---

#### Memory capacity

The total recording capacity (including your greeting message and caller messages) is:

- about 15 minutes for KX-TG5631/KX-TG5632/KX-TG5633/KX-TG5634
- about 21 minutes for KX-TG5651/KX-TG5652/KX-TG5653

A maximum of 64 messages (including a greeting message) can be recorded.

- If the message memory becomes full, the ANSWER ON indicator flashes rapidly (if the answering system is turned on). Erase unnecessary messages (page 39).
- If less than 3 minutes of recording time is available, the unit announces the remaining recording time when operating the answering system. Erase unnecessary messages (page 39).

---

#### Turning the answering system on/off

Press **[ANSWER ON]** to turn on/off the answering system.

- When the answering system is turned on, the ANSWER ON indicator lights.

- When the answering system is turned off, the ANSWER ON indicator turns off.

---

#### Screening calls

While a caller is leaving a message, you can listen to the call through the base unit's speaker. To adjust the speaker volume, press **[^]** or **[v]** repeatedly. You can answer the call by pressing **[hook]** on the handset.

---

#### Turning off the call screening feature

When the base unit is not in use, press **[GREETING CHECK]**, then press **[v]** repeatedly until "0" is displayed.

OR

While screening, press **[v]** repeatedly until "0" is displayed.

#### Note:

- If you adjust the speaker volume while listening to messages or talking on the intercom, the speaker volume for call screening is turned on again.

---

#### Recording your greeting message

You can record your own greeting message (max. 2 minutes) that is played when the answering system answers a call. If you do not record a greeting message, a prerecorded greeting message is used.

#### 1 [GREETING REC]

2 Within 10 seconds, press **[GREETING REC]** again.

3 After the base unit beeps, speak clearly about 20 cm (8 inches) away from the MIC.

**4** To stop recording, press **[STOP]**.

#### Playing back the greeting message

Press **[GREETING CHECK]**.

#### Erasing your greeting message

Press **[GREETING CHECK]**, and then press **[ERASE]** while your greeting message is playing.

#### Prerecorded greeting message

If you erase or do not record your own greeting message, the unit plays a prerecorded greeting message for callers and ask them to leave messages. If the message recording time (page 43) is set to "Greeting only", caller messages are not recorded and the unit plays a different prerecorded greeting message asking callers to call again.

## Listening to messages using the base unit

When new messages have been recorded, the MESSAGE indicator on the base unit flashes.

Press **[MESSAGE]**.

- The unit plays new messages.
- When you have no new messages, the unit plays back all messages.

#### Adjusting the speaker volume

Press **[^]** or **[v]** repeatedly while listening to a message.

#### Repeating a message

Press **[|◀◀]** during playback.

- If pressed within the first 5 seconds of a message, the previous message is played.

#### Skipping a message

Press **[▶▶|]** during playback.

#### Pausing a message

Press **[STOP]** during playback.

- To resume playback, press **[MESSAGE]**.
- To stop playback completely, press **[STOP]** again.

#### Erasing a message

Press **[ERASE]** during playback.

#### Erasing all messages

Press **[ERASE]** 2 times while the unit is not being used.

### Listening to messages using the handset

When new messages have been recorded:

- “**New message**” is displayed.
- The message indicator on the handset flashes slowly if the message alert feature is turned on (page 43).

#### 1 [MENU]

#### 2 “Message play” → [Select]

- The handset plays new messages.
- When you have no new messages, the handset plays back all messages.

#### 3 Press [OFF] when finished.

#### Note:

- You can also listen to the messages by pressing [MENU], then pressing [2].
- To switch to the receiver, press [↶].

### Adjusting the receiver/speaker volume

Press [▲] or [▼] repeatedly while listening to a message.

### Voice guidance

If you do not press any buttons after the last message is played back, the unit’s voice guidance starts. Operate the answering system by following the guidance as necessary.

### Calling back (Caller ID subscribers only)

If Caller ID information was received for the call, you can call the caller back while listening to the message.

- 1 Press [Select] during playback.
  - To edit the number before calling back, press [Edit] repeatedly to select the desired format (page 31).

### 2 [Call]

### Answering system commands

You can also operate the answering system by pressing dial keys on the handset during playback.

| Key               | Command  |
|-------------------|--|
| [1] or [◀]        | Repeat message (during playback) <sup>*1</sup> |
| [2] or [▶]        | Skip message (during playback)                 |
| [4]               | Play new messages                              |
| [5]               | Play all messages                              |
| [8]               | Turn answering system on                       |
| [9]               | Stop playback <sup>*2</sup>                    |
| [0]               | Turn answering system off                      |
| [*][4] or [Erase] | Erase currently playing message                |
| [*][5]            | Erase all messages                             |

\*1 If pressed within the first 5 seconds of a message, the previous message is played.

\*2 To resume operation, press a command key within 15 seconds, or the voice guidance will start.



## Remote operation

Using a touch tone phone, you can call your phone number from outside and access the unit to listen to messages. The unit's voice guidance prompts you to press certain dial keys to perform different operations.

### Important:

- In order to operate the answering system remotely, you must first set a remote code (page 42). This code must be entered each time you operate the answering system remotely.

## Using the answering system remotely

- 1 Dial your phone number from a touch tone phone.
- 2 After the greeting message starts, enter your remote code (page 42).
  - The unit plays back new messages.
  - After playing back new messages, the voice guidance starts.
- 3 Follow the voice guidance as necessary.
- 4 When finished, hang up.

### Note:

- You can ignore the voice guidance and control the unit using remote commands (page 41).

## Voice guidance

During remote operation, the unit's voice guidance prompts you to press **[1]** to perform a specific operation, or press **[2]** to listen to more available operations. Operations are presented by voice guidance in the following order:

- Play back all messages
- Play back new messages
- Record a message
- Erase all messages

### Note:

- If you do not press any dial keys within 10 seconds after a voice guidance prompt, the unit disconnects your call.
- If less than 3 minutes of recording time is available, the unit announces the remaining recording time after the last message is played back.

## Remote commands

You can press dial keys to access certain answering system functions without waiting for the voice guidance to prompt you.

| Key        | Remote command                                 |
|------------|--|
| <b>[1]</b> | Repeat message (during playback) <sup>*1</sup> |
| <b>[2]</b> | Skip message (during playback)                 |
| <b>[4]</b> | Play new messages                              |
| <b>[5]</b> | Play all messages                              |
| <b>[9]</b> | Stop playback <sup>*2</sup>                    |
| <b>[0]</b> | Turn answering system off                      |

| Key           | Remote command                  |
|---------------|---------------------------------|
| <b>[*][4]</b> | Erase currently playing message |
| <b>[*][5]</b> | Erase all messages              |

\*1 If pressed within the first 5 seconds of a message, the previous message is played.

\*2 To resume operation, enter a remote command within 15 seconds, or the voice guidance starts.

### Turning on the answering system remotely

If the answering system is off, you can turn it on remotely.

**1** Dial your phone number.

**2** Let the phone ring 15 times.

- The unit answers your call with the greeting message.
- You can hang up, or if you call from a touch tone phone, you can enter your remote code and begin remote operation (page 41).

### Skipping the greeting message to leave a message

You can leave a message just as any outside caller can. Call your phone number. When the answering system picks up, press **[\*]** to skip the greeting message and record your message after the beep.

## Answering system settings

### Remote code

A remote code must be entered when operating the answering system remotely. This code prevents unauthorized parties from listening to your messages remotely. The default setting is "11".

**1** **[MENU]** → **[0][6][3]**

**2** Enter the desired 2-digit remote code.  
→ **[Save]** → **[OFF]**

### Ring count

You can change the number of times the phone rings before the unit answers calls. The default setting is "4".

"**Toll saver**": The unit answers on the 2nd ring when new messages have been recorded, and on the 4th ring when there are no new messages. If you call your phone from outside to listen to new messages (page 41), you will know that there are no new messages when the phone rings for the 3rd time. You can then hang up without being charged for the call.

**1** **[MENU]** → **[0][6][1]**

**2** Select the desired setting. → **[Save]**  
→ **[OFF]**

### For Voice Mail service subscribers

If you subscribe to a flat-rate service package that includes Caller ID, Call Waiting, Voice Mail, and unlimited local/regional/long distance calls, please note the following:

- To use the Voice Mail service provided by your telephone company rather than the unit's answering system, turn off the answering system (page 38). This unit does not have an indicator to indicate if there are new messages in your mailbox service.
- To use this unit's answering system rather than the Voice Mail service provided by your telephone company, please contact your telephone company to deactivate your Voice Mail service. If your telephone company cannot do this:
  - Set this unit's "**Ring count**" setting so that this unit's answering system answers calls before your telephone company's Voice Mail service tries to answer your calls. It is necessary to check the ring count required to activate the Voice Mail service provided by your telephone company before changing this setting.
  - Change the ring count of the Voice Mail service so that the answering system can answer the call first. To do so, consult your telephone company.

### Caller's recording time

You can change the maximum message recording time allotted to each caller.

The default setting is "3min".

"**Greeting only**": The unit plays the greeting message but does not record caller messages.

**1** [MENU] → [0][6][2]

**2** Select the desired setting. → [Save]  
→ [OFF]

#### Note:

- If the message memory becomes full, the unit automatically switches to the "**Greeting only**" mode and no new messages are recorded. If you have recorded your own greeting message, that same greeting message is announced to callers even though their messages are not recorded. If you have not recorded your own greeting message, the prerecorded message used for "**Greeting only**" mode is announced to callers (page 39).

### Message alert

You can select whether or not the message indicator on the handset flashes when new messages are recorded (page 40). The default setting is "OFF".

**1** [MENU] → [0][#]

**2** Select the desired setting. → [Save]  
→ [OFF]

#### Note:

- While message alert is on, battery operating time is shortened (page 16).

---

### Intercom

Intercom calls can be made:

- between the handset and base unit
- between handsets (for models with 2 or more handsets included only: page 4)

**Note:**

- If you receive a phone call while talking on the intercom, you hear 2 tones. To answer the call, press **[OFF]**, then press **[↶]**.
- You can locate a misplaced handset by paging it (handset locator).

---

### For models with only 1 handset included

---

#### Making an intercom call

##### Handset

- 1 [INTERCOM]**
  - The base unit beeps for 1 minute.
- 2** To end the intercom call, press **[OFF]**.

##### Base unit

- 1 [LOCATOR/INTERCOM]**
  - The handset beeps for 1 minute.
- 2** To end the intercom call, press **[LOCATOR/INTERCOM]**.

---

#### Answering an intercom call

##### Handset

- 1** Press **[↶]** to answer the page.
- 2** To end the intercom call, press **[OFF]**.

##### Base unit

- 1** Press **[LOCATOR/INTERCOM]** to answer the page.
- 2** To end the intercom call, press **[LOCATOR/INTERCOM]**.

**Note:**

- When the ringer volume is set to off, the handset or the base unit rings at the low level for intercom calls.

---

### For models with 2 or more handsets included

---

#### Making an intercom call

##### Handset

- 1 [INTERCOM]**
- 2** To page the base unit, press **[0]**.  
To page another handset, enter its extension number (**[1] – [4]**).
  - The destination unit beeps for 1 minute.
- 3** To end the intercom call, press **[OFF]**.

**Base unit**

- 1 Press **[SELECT]** repeatedly to display the desired handset number. → **[CALL]**
  - The handset beeps for 1 minute.
- 2 To end the intercom call, press **[CALL]**.

**Answering an intercom call****Handset**

- 1 Press **[↶]** to answer the page.
- 2 To end the intercom call, press **[OFF]**.

**Base unit**

- 1 Press **[CALL]** to answer the page.
- 2 To end the intercom call, press **[CALL]**.

**Note:**

- When the ringer volume is set to off, the handset or the base unit rings at the low level for intercom calls.

**Transferring calls between handsets, conference calls****Available model:**

KX-TG5632/KX-TG5633/KX-TG5634/  
KX-TG5652/KX-TG5653

Outside calls can be transferred between 2 handsets. 2 handsets can have a conference call with an outside party.

- 1 During an outside call, press **[INTERCOM]** to put the call on hold.
- 2 To page another handset, enter its extension number (**[1] – [4]**).
  - **[4]** can be used if you have 4 handsets.
- 3 Wait for the paged party to answer.
  - If the paged party does not answer, press **[↶]** to return to the outside call.
- 4 To complete the transfer, press **[OFF]**.
  - The outside call is being routed to another handset.

To establish a conference call, press **[Conf]**.

  - To leave the conference, press **[OFF]**. The other parties can continue the conversation.
  - To put the outside call on hold, press **[HOLD]**. To resume the conference, press **[Conf]**.

## Multi-unit Operation

---

### Answering transferred calls

Press [**↶**] to answer the page.

- After the paging party disconnects, you can talk to the outside caller.

---

## Registering a handset

The included handset and base unit are preregistered. If for some reason the handset is not registered to the base unit, register the handset.

---

### For models with only 1 handset included

#### 1 Handset:

[**MENU**] → [**0**][**0**]

#### 2 Base unit:

Press and hold [**LOCATOR/INTERCOM**] until the CHARGE indicator flashes.

- After the CHARGE indicator starts flashing, the rest of the procedure must be completed within 1 minute.

#### 3 Handset:

Press [**OK**], then wait until the handset beeps.

---

### For models with 2 or more handsets included

#### Important:

- If you accidentally assign another handset's extension number to the base unit, the originally assigned handset stops functioning. Confirm the extension number of the handset by placing it on the base unit or charger. Lift the handset from the charger before registering.

#### 1 Handset:

[**MENU**] → [**0**][**0**]

#### 2 Base unit:

Press [**SELECT**] until the desired extension number (*H 1*, *H 2*, *H 3*, or *H 4*) is displayed on the base unit, then press and hold [**CALL**] until the CHARGE indicator flashes.

- *H 4* can be used if you have 4 handsets.
- After the CHARGE indicator starts flashing, the rest of the procedure must be completed within 1 minute.

#### 3 Handset:

Press [**OK**], then wait until the handset beeps.

---

### Registering an additional handset

See page 6 for information on the available models and extension numbers.

Start from step 2.

## Wall mounting

### Base unit

- 1** Tuck the telephone line cord inside the wall mounting adaptor (**1**).  
Connect the telephone line cord (**2**).

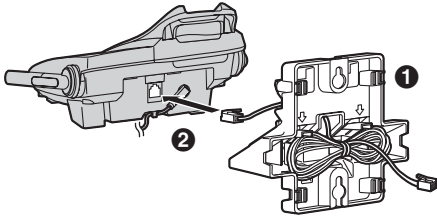

- 2** Insert the hooks on the wall mounting adaptor into the holes (**A**) and (**B**) on the base unit.

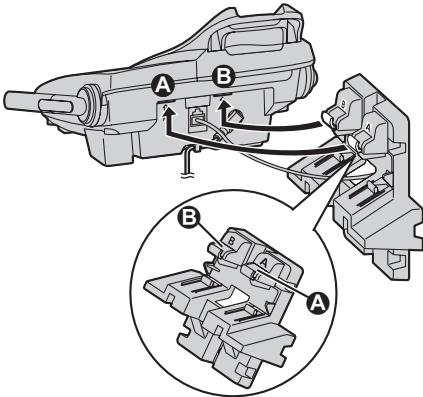

- 3** Adjust the adaptor to hold the base unit, then push it in the direction of the arrow until it clicks into place.

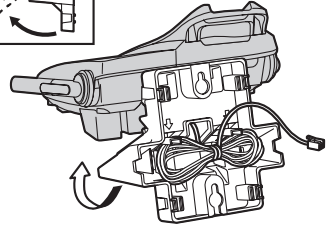
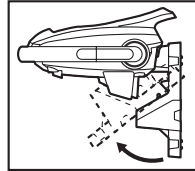

## Useful Information

**4** Connect the telephone line cord. Mount the unit by inserting the mounting pins into the round openings on the adaptor (for pin **B**, use round cut out at the bottom of the adaptor if you are using the 4 inches phone plate), then sliding the unit down to secure it. Connect the AC adaptor to power outlet (page 13).

- There are two common types of wall phone plates. The distance between **A** and **B** may vary depending on the size of the wall phone plate installed.

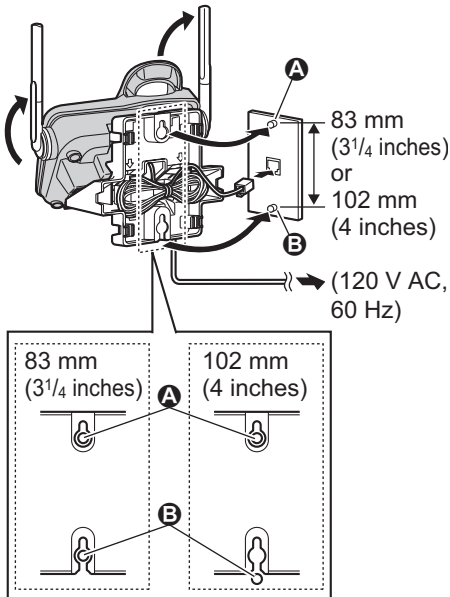

### To remove the wall mounting adaptor

While pushing down the release levers (**1**), remove the adaptor (**2**).

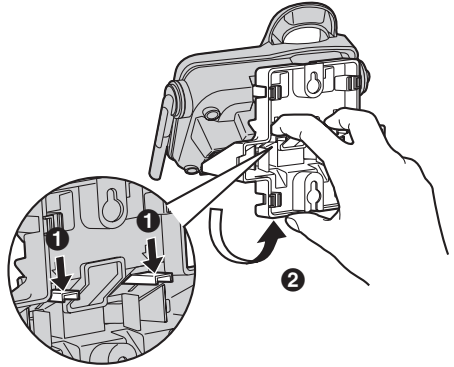



## Charger

### Available model:

KX-TG5632/KX-TG5633/KX-TG5634/  
KX-TG5652/KX-TG5653

- 1 Drive the screws (not included) into the wall using the wall mount template as a guide.

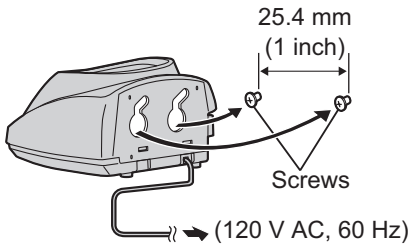

- 2 Mount the charger (1), then slide it down (2) and to the right (3) until it is secure.

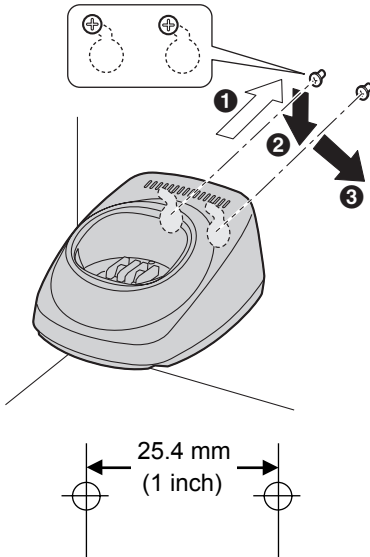

## Headset (optional)

Connecting a headset to the handset allows hands-free phone conversations. We recommend using the Panasonic headset noted on page 9.



- Headset shown is KX-TCA86.

### Switching a call between the headset and handset speakerphone

To switch to the handset speakerphone, press [📞].

To return to the headset, press [📞].

# Error messages

If the unit detects a problem, one of the following messages is shown on the display.

| Display message   | Cause/solution   |
|---|--|
| <b>Busy</b>   | <ul style="list-style-type: none"><li>● The called base unit is in use.</li><li>● Another handset or the called handset is in use.*<sup>1</sup></li><li>● The handset you tried to copy phonebook items to is in use.*<sup>1</sup></li><li>● The handset you are calling is too far from the base unit.*<sup>1</sup></li></ul>                                 |
| <b>Error!!</b>  | <ul style="list-style-type: none"><li>● The handset's registration has failed. Move the handset and base unit away from all electrical appliances and try again.</li><li>● Another handset user tried to send phonebook items to you but there was an error. Have the other handset user re-send the items to you (page 28).*<sup>1</sup></li></ul>            |
| <b>---Incomplete---<br/>Phonebook full</b>                      | <ul style="list-style-type: none"><li>● The destination unit's phonebook memory is full. Erase unnecessary items from the destination unit's phonebook (page 27).*<sup>1</sup></li></ul>   |
| <b>Invalid</b>  | <ul style="list-style-type: none"><li>● There is no handset registered to the base unit matching the extension number you entered.*<sup>1</sup></li></ul>  |
| <b>No items stored</b>  | <ul style="list-style-type: none"><li>● Your phonebook or redial list is empty.</li></ul>  |
| <b>No link to base.<br/>Move closer to<br/>base, try again.</b> | <ul style="list-style-type: none"><li>● The handset has lost communication with the base unit. Move closer to the base unit, and try again.</li><li>● Confirm that the base unit's AC adaptor is plugged in.</li><li>● Raise the base unit antennas.</li><li>● The handset's registration may have been canceled. Re-register the handset (page 46).</li></ul> |
| <b>Phonebook full</b>   | <ul style="list-style-type: none"><li>● There is no space to store new items in the phonebook. Erase unnecessary items (page 27).</li></ul>  |
| <b>Please lift up<br/>and try again.</b>                        | <ul style="list-style-type: none"><li>● A handset button was pressed while the handset was on the base unit or charger. Lift the handset and press the button again.</li></ul>   |
| <b>System is busy.<br/>Please try again<br/>later.</b>          | <ul style="list-style-type: none"><li>● Other units are in use and the system is busy. Try again later.*<sup>1</sup></li><li>● Another user is listening to messages. Try again later.</li></ul>   |

\*<sup>1</sup> For models with 2 or more handsets included only (page 4).

## Troubleshooting



### General use

| Problem                    | Cause/solution  |
|----------------------------|---|
| The unit does not work.    | <ul style="list-style-type: none"> <li>● Make sure the battery is installed correctly and fully charged (page 14, 15).</li> <li>● Check the connections (page 13).</li> <li>● Unplug the base unit's AC adaptor to reset the unit. Reconnect the adaptor and try again.</li> <li>● The handset has not been registered to the base unit. Register the handset (page 46).</li> </ul>                         |
| I cannot hear a dial tone. | <ul style="list-style-type: none"> <li>● Confirm the telephone line cord is properly connected (page 13).</li> <li>● Disconnect the unit from the telephone line and connect a known working telephone. If the working telephone operates properly, contact our service personnel to have the unit repaired. If the working telephone does not operate properly, contact your telephone company.</li> </ul> |

### Programmable settings

| Problem  | Cause/solution  |
|--|---|
| I cannot program items.                        | <ul style="list-style-type: none"> <li>● While another user is listening to messages or the answering system is answering a call, you cannot program items. Try again later.</li> </ul> |
| While programming, the handset starts to ring. | <ul style="list-style-type: none"> <li>● A call is being received. Answer the call and start again after hanging up.</li> </ul>   |

### Battery recharge

| Problem   | Cause/solution   |
|---|--|
| I charged the battery fully, but  continues to flash, or  is displayed. | <ul style="list-style-type: none"> <li>● Clean the charge contacts and charge again (page 15).</li> <li>● The battery may need to be replaced with a new one (page 14).</li> </ul> |
| The handset display is blank.   | <ul style="list-style-type: none"> <li>● Confirm that the battery is properly installed.</li> <li>● Fully charge the battery (page 15).</li> </ul>                                 |

## Useful Information

---

### Making/answering calls, intercom

| Problem  | Cause/solution  |
|--|---|
| Static is heard, sound cuts in and out.<br>Interference from other electrical units. | <ul style="list-style-type: none"><li>● Move the handset and the base unit away from other electrical appliances.</li><li>● Move closer to the base unit.</li><li>● Raise the base unit antennas.</li><li>● Turn on the clarity booster feature (page 24).</li><li>● If your unit is connected to a telephone line with DSL service, we recommend connecting a noise filter between the base unit and the telephone line jack. Contact your DSL provider for details.</li></ul> |
| The handset does not ring.   | <ul style="list-style-type: none"><li>● The ringer volume is turned off. Adjust it (page 36).</li></ul>   |
| The base unit does not ring.   | <ul style="list-style-type: none"><li>● The ringer volume is turned off. Adjust it (page 23).</li></ul>   |
| I cannot make a call.  | <ul style="list-style-type: none"><li>● The dialing mode may be set incorrectly. Change the setting (page 20).</li><li>● The base unit or another handset is in use. Try again later.</li></ul>   |
| I cannot redial by pressing <b>[REDIAL]</b> .  | <ul style="list-style-type: none"><li>● If the last number dialed was more than 48 digits long, the number will not be redialed correctly. Dial the number manually.</li></ul>  |
| I cannot have a conversation using the headset.                                      | <ul style="list-style-type: none"><li>● Make sure that an optional headset is connected properly (page 49).</li><li>● If “<b>SP-phone</b>” is displayed on the handset, press <b>[</b>] to switch to the headset.</li></ul>  |
| I cannot make long distance calls.   | <ul style="list-style-type: none"><li>● Make sure that you have long distance service.</li></ul>  |
| I cannot page the handset.   | <ul style="list-style-type: none"><li>● The called handset is too far from the base unit.</li><li>● The called handset is in use. Try again later.</li></ul>  |
| I cannot page the base unit.   | <ul style="list-style-type: none"><li>● The base unit is in use. Try again later.</li></ul>   |

## Phonebook

| Problem   | Cause/solution  |
|---|---|
| Copying stopped with an item displayed.* <sup>1</sup> | <ul style="list-style-type: none"> <li>The destination handset may have lost communication with the base unit, or the destination unit user may have pressed <b>[MUTE]</b> or <b>[MUTE]</b>. The displayed phonebook item was not copied to the unit. Press <b>[OFF]</b>. Confirm that the destination unit is not in use and try again.</li> </ul> |

\*1 For models with 2 or more handsets included only (page 4).

## Caller ID

| Problem  | Cause/solution   |
|--|--|
| The handset does not display the caller's name and/or phone number.                  | <ul style="list-style-type: none"> <li>You have not subscribed to Caller ID service. Contact your telephone company to subscribe.</li> <li>If your unit is connected to any additional telephone equipment such as a Caller ID box or cordless telephone jack, disconnect the unit from the equipment and plug the unit directly into the wall jack.</li> <li>If your unit is connected to a telephone line with DSL service, we recommend connecting a noise filter between the base unit and the telephone line jack. Contact your DSL provider for details.</li> <li>The name display service may not be available in some areas. Contact your telephone company for details.</li> <li>Other telephone equipment may be interfering with this unit. Disconnect the other equipment and try again.</li> <li>The caller requested not to send caller information (page 29).</li> <li>If a call is being transferred to you, the caller information is not displayed.</li> </ul> |
| The handset or base unit does not announce the displayed caller names.* <sup>1</sup> | <ul style="list-style-type: none"> <li>The handset or base unit's ringer volume is turned off. Adjust it (page 23, 36).</li> <li>The Talking Caller ID feature is turned off. Turn it on (page 36).</li> <li>The ring count for the answering system is set to "2" or "To11 saver". Select a different setting (page 42).</li> <li>If the base unit and another handset are having an intercom call, your handset does not announce caller information.*<sup>2</sup></li> </ul>  |

## Useful Information

| Problem   | Cause/solution  |
|---|---|
| The caller list/incoming phone numbers are not edited automatically.  | <ul style="list-style-type: none"> <li>● The Caller ID number auto edit feature is turned off. Turn it on and try again (page 35).</li> <li>● You need to call back the edited number to activate Caller ID number auto edit.</li> </ul>  |
| I cannot dial the phone number edited in the caller list.             | <ul style="list-style-type: none"> <li>● The phone number you dialed might have an incorrectly edited pattern (for example, the long distance “1” or the area code is missing). Edit the phone number with another pattern (page 31).</li> </ul>  |
| The 2nd caller’s information is not displayed during an outside call. | <ul style="list-style-type: none"> <li>● In order to use Caller ID, Call Waiting, or Call Waiting Caller ID (CWID), you must first contact your telephone company and subscribe to the desired service. After subscribing, you may need to contact your telephone company again to activate this specific service, even if you already subscribed to both Caller ID and Call Waiting with Caller ID services (CWID).</li> </ul> |

\*1 KX-TG5651/KX-TG5652/KX-TG5653

\*2 KX-TG5652/KX-TG5653

## Answering system

| Problem   | Cause/solution  |
|---|---|
| I cannot listen to messages from a remote location. | <ul style="list-style-type: none"> <li>● A touch tone phone is required for remote operation.</li> <li>● Enter the remote code correctly (page 41).</li> <li>● The answering system is off. Turn it on (page 42).</li> </ul>  |
| The unit does not record new messages.              | <ul style="list-style-type: none"> <li>● The recording time is set to “<b>Greeting only</b>”. Select a different setting (page 43).</li> <li>● The message memory is full. Erase unnecessary messages (page 39).</li> <li>● If you subscribe to the Voice Mail service, messages are recorded by the telephone company not your telephone (page 43).</li> </ul> |
| I cannot operate the answering system.              | <ul style="list-style-type: none"> <li>● Someone is operating the answering system.</li> <li>● If someone is talking on a conference call, you cannot operate the answering system. Try again later.*1</li> </ul>   |
| The message indicator on the handset flashes.       | <ul style="list-style-type: none"> <li>● New messages have been recorded. Listen to the new messages (page 39).</li> </ul>  |

\*1 For models with 2 or more handsets included only (page 4).

## FCC and other information

This equipment complies with Part 68 of the FCC rules and the requirements adopted by the ACTA. On the bottom of this equipment is a label that contains, among other information, a product identifier in the format US:ACJ-----.

If requested, this number must be provided to the telephone company.

- Registration No  
.....(found on the bottom of the unit)
- Ringer Equivalence No.  
(REN).....0.1B

A plug and jack used to connect this equipment to the premises wiring and telephone network must comply with the applicable FCC Part 68 rules and requirements adopted by the ACTA. A compliant telephone cord and modular plug is provided with the product. It is designed to be connected to a compatible modular jack that is also compliant.

The REN is used to determine the number of devices that may be connected to a telephone line. Excessive RENs on a telephone line may result in the devices not ringing in response to an incoming call. In most but not all areas, the sum of RENs should not exceed five (5.0). To be certain of the number of devices that may be connected to a line, as determined by the total RENs, contact the local telephone company. For products approved after July 23, 2001, the REN for the product is part of the product identifier that has the format US:AAAEQ##TXXXX. The digits represented by ## are the REN without a

decimal point (e.g., 03 is a REN of 0.3).

If this equipment causes harm to the telephone network, the telephone company will notify you in advance that temporary discontinuance of service may be required. But if advance notice isn't practical, the telephone company will notify the customer as soon as possible. Also, you will be advised of your right to file a complaint with the FCC if you believe it is necessary.

The telephone company may make changes in its facilities, equipment, operations or procedures that could affect the operation of the equipment. If this happens the telephone company will provide advance notice in order for you to make necessary modifications to maintain uninterrupted service.

If trouble is experienced with this equipment, for repair or warranty information, please contact a Factory Servicenter or other Authorized Servicer. If the equipment is causing harm to the telephone network, the telephone company may request that you disconnect the equipment until the problem is resolved.

Connection to party line service is subject to state tariffs. Contact the state public utility commission, public service commission or corporation commission for information.

If your home has specially wired alarm equipment connected to the telephone

## Useful Information

---

line, ensure the installation of this equipment does not disable your alarm equipment. If you have questions about what will disable alarm equipment, consult your telephone company or a qualified installer.

This equipment is hearing aid compatible as defined by the FCC in 47 CFR Section 68.316.

When you hold the phone to your ear, noise might be heard in your Hearing Aid. Some Hearing Aids are not adequately shielded from external RF (radio frequency) energy. If noise occurs, use an optional headset accessory or the speakerphone option (if applicable) when using this phone. Consult with your audiologist or Hearing Aid manufacturer about the availability of Hearing Aids which provide adequate shielding to RF energy commonly emitted by digital devices.

### WHEN PROGRAMMING EMERGENCY NUMBERS AND/OR MAKING TEST CALLS TO EMERGENCY NUMBERS:

- 1) Remain on the line and briefly explain to the dispatcher the reason for the call.
- 2) Perform such activities in the off-peak hours, such as early morning or late evenings.

This device complies with Part 15 of the FCC Rules. Operation is subject to the following two conditions:

(1) This device may not cause harmful interference, and (2) this device must accept any interference received, including interference that may cause undesired operation.

Privacy of communications may not be ensured when using this phone.

### CAUTION:

Any changes or modifications not expressly approved by the party responsible for compliance could void the user's authority to operate this device.

### NOTE:

This equipment has been tested and found to comply with the limits for a Class B digital device, pursuant to Part 15 of the FCC Rules. These limits are designed to provide reasonable protection against harmful interference in a residential installation. This equipment generates, uses, and can radiate radio frequency energy and, if not installed and used in accordance with the instructions, may cause harmful interference to radio communications. However, there is no guarantee that interference will not occur in a particular installation. If this equipment does cause harmful interference to radio or television reception, which can be determined by turning the equipment off and on, the user is encouraged to try to correct the interference by one or more of the following measures:

- Reorient or relocate the receiving antenna.
- Increase the separation between the equipment and receiver.
- Connect the equipment into an outlet on a circuit different from that to which the receiver is connected.
- Consult the dealer or an experienced radio/TV technician for help.



Some cordless telephones operate at frequencies that may cause interference to nearby TVs and VCRs. To minimize or prevent such interference, the base of the cordless telephone should not be placed near or on top of a TV or VCR. If interference is experienced, move the cordless telephone further away from the TV or VCR. This will often reduce, or eliminate, interference.

### **FCC RF Exposure Warning:**

The product complies with FCC radiation exposure limits set forth for an uncontrolled environment. To comply with FCC RF exposure requirements, the base unit must be installed and operated with its antenna located 20 cm (8 inches) or more between antenna and all person's body (excluding extremities of hands, wrist and feet). The handset may be carried and operated with only the optional specific belt-clip. Other non-tested belt-clips or similar body-worn accessories may not comply and must be avoided. The product must not be collocated or operated in conjunction with any other antenna or transmitter.

### **KX-TG5631/KX-TG5632/KX-TG5633/ KX-TG5634:**

The software contained in this equipment to allow user access to the network must be upgraded to recognize newly established network area codes and exchange codes as they are placed into service.

Failure to upgrade the premises systems or peripheral equipment to recognize the new codes as they are established will restrict the customer and the customer's employees from gaining access to the network and to these codes.

### **Notice**

- This product is designed for use in the United States of America. Sale or use of this product in other countries may violate local laws.
- Cet appareil est conçu pour être utilisé aux États-Unis d'Amérique. La vente ou l'emploi de cet appareil dans certains autres pays peut constituer une infraction à la législation locale.
- Este producto está diseñado para usarse en los Estados Unidos de América.  
La venta o el empleo de este producto en ciertos países puede constituir violación de la legislación local.
- この製品は、日本国外での使用を目的として設計されており、日本国内での使用は法律違反となります。従って、当社では日本国内においては原則として修理などのサービスは致しかねます。

# Specifications

### General

|                              |                               |
|------------------------------|-------------------------------|
| <b>Operating environment</b> | 5 °C – 40 °C (41 °F – 104 °F) |
| <b>Frequency</b>             | 5.76 GHz – 5.84 GHz           |

### Base unit

|                          |  |
|--------------------------|--|
| <b>Dimensions</b>        | Approx. height 95 mm x width 174 mm x depth 143 mm<br>(3 <sup>3</sup> / <sub>4</sub> inches x 6 <sup>27</sup> / <sub>32</sub> inches x 5 <sup>5</sup> / <sub>8</sub> inches) |
| <b>Mass (Weight)</b>     | Approx. 320 g (0.71 lb.)   |
| <b>Power consumption</b> | Standby: Approx. 2.2 W/1.5 W (PQLV1/PQLV256)<br>Maximum: Approx. 4.7 W/3.8 W (PQLV1/PQLV256)   |
| <b>Power output</b>      | 200 mW (max.)  |
| <b>Power supply</b>      | AC adaptor (120 V AC, 60 Hz)   |

### Handset

|                      |  |
|----------------------|--|
| <b>Dimensions</b>    | Approx. height 173 mm x width 48 mm x depth 33 mm<br>(6 <sup>13</sup> / <sub>16</sub> inches x 1 <sup>7</sup> / <sub>8</sub> inches x 1 <sup>5</sup> / <sub>16</sub> inches) |
| <b>Mass (Weight)</b> | Approx. 170 g (0.37 lb.)   |
| <b>Power output</b>  | 200 mW (max.)  |
| <b>Power supply</b>  | Ni-MH battery (3.6 V, 830 mAh)   |

### Charger<sup>\*1</sup>

|                          |   |
|--------------------------|---|
| <b>Dimensions</b>        | Approx. height 51 mm x width 88 mm x depth 100 mm<br>(2 inches x 3 <sup>15</sup> / <sub>32</sub> inches x 3 <sup>15</sup> / <sub>16</sub> inches) |
| <b>Mass (Weight)</b>     | Approx. 94 g (0.21 lb.)   |
| <b>Power consumption</b> | Standby: Approx. 0.8 W/0.3 W (KX-TCA1/PQLV256)<br>Maximum: Approx. 3.6 W/2.4 W (KX-TCA1/PQLV256)  |
| <b>Power supply</b>      | AC adaptor (120 V AC, 60 Hz)  |

\*1 KX-TG5632/KX-TG5633/KX-TG5634/KX-TG5652/KX-TG5653

### Note:

- Design and specifications are subject to change without notice.
- The illustrations in these instructions may vary slightly from the actual product.

## Warranty

PANASONIC CONSUMER  
ELECTRONICS COMPANY, DIVISION  
OF PANASONIC CORPORATION OF  
NORTH AMERICA  
One Panasonic Way,  
Secaucus, New Jersey 07094

PANASONIC PUERTO RICO, INC.  
San Gabriel Industrial Park,  
Ave. 65 de Infantería, Km. 9.5,  
Carolina, Puerto Rico 00985

# Panasonic Telephone Products Limited Warranty

### Limited Warranty Coverage

If your product does not work properly because of a defect in materials or workmanship, Panasonic Consumer Electronics Company or Panasonic Puerto Rico, Inc. (collectively referred to as “the warrantor”) will, for the length of the period indicated on the chart below, which starts with the date of original purchase (“Limited Warranty period”), at its option either (a) repair your product with new or refurbished parts, or (b) replace it with a new or a refurbished product. The decision to repair or replace will be made by the warrantor.

#### Parts

One (1) Year

#### Labor

One (1) Year

During the “Labor” Limited Warranty period there will be no charge for labor. During the “Parts” Limited Warranty period, there will be no charge for parts. You must mail-in your product prepaid during the Limited Warranty period. This Limited Warranty excludes both parts and labor for batteries, antennas, and cosmetic parts (cabinet). This Limited Warranty only applies to products purchased and serviced in the United States or Puerto Rico. This Limited Warranty is extended only to the original purchaser and only covers products purchased as new.

### Mail-In Service

For assistance in the continental U.S.A. in obtaining repairs please ship the product prepaid to:

**Panasonic Services Company Customer Servicenter**

**4900 George McVay Drive Suite B Door #12 McAllen, TX 78503**

For assistance in Puerto Rico call Panasonic Puerto Rico, Inc. (787)-750-4300 or fax (787)-768-2910.

For Limited Warranty service for headsets if a headset is included with this product please call Panasonic Call Center at 1-800-211-PANA (1-800-211-7262).

When shipping the unit carefully pack, include all accessories, and send it prepaid, adequately insured and preferably in the original carton. Include a letter detailing the complaint and provide a day time phone number where you can be reached.

**IF REPAIR IS NEEDED DURING THE LIMITED WARRANTY PERIOD THE PURCHASER WILL BE REQUIRED TO FURNISH A SALES RECEIPT/PROOF OF PURCHASE INDICATING DATE OF PURCHASE, AMOUNT PAID AND PLACE OF PURCHASE. CUSTOMER WILL BE CHARGED FOR THE REPAIR OF ANY UNIT RECEIVED WITHOUT SUCH PROOF OF PURCHASE.**

### Limited Warranty Limits And Exclusions

This Limited Warranty ONLY COVERS failures due to defects in materials or workmanship, and DOES NOT COVER normal wear and tear or cosmetic damage. The Limited Warranty ALSO DOES NOT COVER damages which occurred in shipment, or failures which are caused by products not supplied by the warrantor, or failures which result from accidents, misuse, abuse, neglect, bug infestation, mishandling, misapplication, alteration, faulty installation, set-up adjustments, misadjustment of consumer controls, improper maintenance, power line surge, lightning damage, modification, introduction of sand, humidity or liquids, commercial use such as hotel, office, restaurant, or other business or rental use of the product, or service by anyone other than a Factory Servicenter or other Authorized Servicer, or damage that is attributable to acts of God.

**THERE ARE NO EXPRESS WARRANTIES EXCEPT AS LISTED UNDER "LIMITED WARRANTY COVERAGE". THE WARRANTOR IS NOT LIABLE FOR INCIDENTAL OR CONSEQUENTIAL DAMAGES RESULTING FROM THE USE OF THIS PRODUCT, OR ARISING OUT OF ANY BREACH OF THIS LIMITED WARRANTY.** (As examples, this excludes damages for lost time, lost calls or messages, cost of having someone remove or re-install an installed unit if applicable, travel to and from the servicer. The items listed are not exclusive, but are for illustration only.) **ALL EXPRESS AND IMPLIED WARRANTIES, INCLUDING THE WARRANTY OF MERCHANTABILITY, ARE LIMITED TO THE PERIOD OF THE LIMITED WARRANTY.**

Some states do not allow the exclusion or limitation of incidental or consequential damages, or limitations on how long an implied warranty lasts, so the exclusions may not apply to you.

This Limited Warranty gives you specific legal rights and you may also have other rights which vary from state to state. If a problem with this product develops during or after the Limited Warranty period, you may contact your dealer or Servicenter. If the problem is not handled to your satisfaction, then write to the warrantor's Consumer Affairs Department at the addresses listed for the warrantor.

**PARTS AND SERVICE, WHICH ARE NOT COVERED BY THIS LIMITED WARRANTY, ARE YOUR RESPONSIBILITY.**

## Customer services

### ***Customer Services Directory***

Obtain Product Information and Operating Assistance; locate your nearest Dealer or Servicenter; purchase Parts and Accessories; or make Customer Service and Literature requests by visiting our Web Site at:

**<http://www.panasonic.com/consumersupport>**

or, contact us via the web at:

**<http://www.panasonic.com/contactinfo>**

You may also contact us directly at: 1-800-211-PANA (1-800-211-7262), Monday-Friday 9 am-9 pm; Saturday-Sunday 10 am-7 pm, EST.

TTY users (hearing or speech impaired users) can call 1-877-833-8855.

### ***Accessory Purchases***

Purchase Parts, Accessories and Instruction Books online for all Panasonic Products by visiting our Web Site at:

**<http://www.pasc.panasonic.com>**

or, send your request by E-mail to:

**[npcparts@us.panasonic.com](mailto:npcparts@us.panasonic.com)**

You may also contact us directly at:

1-800-332-5368 (Phone) 1-800-237-9080 (Fax Only)

(Monday - Friday 9 am to 8 pm, EST.)

Panasonic Services Company

20421 84th Avenue South, Kent, WA 98032

(We Accept Visa, MasterCard, Discover Card, American Express, and Personal Checks)

TTY users (hearing or speech impaired users) can call 1-866-605-1277.

### ***Service in Puerto Rico***

Panasonic Puerto Rico, Inc.

San Gabriel Industrial Park, Ave. 65 de Infantería, Km. 9.5,

Carolina, Puerto Rico 00985

Phone (787)750-4300, Fax (787)768-2910

## Index

- A** Answering calls: 23
  - Answering system
    - Erasing messages: 39, 40, 42
    - Listening to messages: 39, 40, 41
    - Turning on/off: 38, 40, 41, 42
  - Auto talk: 23
- B** Battery
  - Charge: 15
  - Installation: 14
  - Level: 16
  - Performance: 16
  - Replacement: 14
- Booster (Clarity booster): 24
- C** Call screening: 38
  - Call share: 25
  - Call Waiting: 24
  - Call Waiting Caller ID: 29
  - Caller ID edit: 31
  - Caller ID number auto edit: 31
  - Caller ID service: 29
  - Caller list
    - Calling back: 31
    - Editing: 31
    - Erasing: 32
    - Storing: 32
    - Viewing: 31
  - Chain dial: 27
  - Conference calls: 45
  - Connections: 13, 14
  - Customer support: 37
- D** Date and time: 21
  - Dialing mode: 20
  - Display
    - Contrast: 35
    - Language: 20
- E** Error messages: 50
- F** Flash: 24
  - Flash time: 36
- G** Greeting message: 38
- H** Handset locator: 44
  - Headset, optional: 49
  - Hold: 23
- I** Intercom: 44
- K** Key tone: 35
- L** Light-up ID: 30
  - Line mode: 36
- M** Making calls: 22
  - Memory capacity (message recording): 38
  - Message alert: 43
  - Missed calls: 29
  - Mute: 24
- N** Navigator key: 18
- P** Pause: 22
  - Phonebook: 26
  - Phonebook copy: 28
  - Pulse service: 24
- R** Recording time: 43
  - Redial list: 22
  - Registration: 46
  - Remote code: 42
  - Remote operation: 41
  - Ring color: 36
  - Ring count: 42
  - Ring ID: 30
  - Ringer off: 23, 36
  - Ringer tone
    - Base unit: 36
    - Handset: 36
  - Rotary service: 24
- S** Soft keys: 19
  - SP-phone: 22
- T** Talking Caller ID: 29
  - Time adjustment: 36
  - Toll saver: 42
  - Tone: 24
  - Transferring calls: 45
  - Troubleshooting: 51

TTY: 9, 61

**V** VE (voice enhancer): 25

Voice guidance: 40, 41

Volume

Base unit ringer: 23

Handset ringer: 36

Receiver: 22

Speaker: 22

**W** Wall mounting

Base unit: 47

Charger: 49

Warranty: 59

## ***If you need assistance with setup or operation***

- 1** Visit our website: <http://www.panasonic.com/phonehelp>
- 2** Contact us via the web at: <http://www.panasonic.com/contactinfo>
- 3** Call us at: 1-800-211-PANA (1-800-211-7262)  
TTY users (hearing or speech impaired users) can call 1-877-833-8855.

### **When you ship the product**

- Carefully pack your unit, preferably in the original carton.
- Attach a letter, detailing the symptom, to the outside of the carton.
- Send the unit to Panasonic Services Company Customer Servicer, prepaid and adequately insured.
- Do not send your unit to Panasonic Consumer Electronics Company listed below or to executive or regional sales offices. These locations do not repair consumer products.

**Panasonic Consumer Electronics Company,  
Division of Panasonic Corporation of North America**  
One Panasonic Way, Secaucus, New Jersey 07094

**Panasonic Puerto Rico, Inc.**  
San Gabriel Industrial Park, Ave. 65 de Infantería, Km. 9.5,  
Carolina, Puerto Rico 00985

#### **Copyright:**

This material is copyrighted by Panasonic Communications Co., Ltd., and may be reproduced for internal use only. All other reproduction, in whole or in part, is prohibited without the written consent of Panasonic Communications Co., Ltd.  
© 2005 Panasonic Communications Co., Ltd. All Rights Reserved.