

Panasonic

2.4GHz Expandable Cordless Phone System

Operating Instructions

Model No. **KX-TG2720S**

Pulse-or-tone dialing capability



Preparation

Basic Operation

Advanced Operation

Useful Information

2 LINE

Caller ID Compatible

PLEASE READ BEFORE USE AND SAVE.

Charge the battery for about 15 hours before initial use.

**Panasonic World Wide Web address: <http://www.panasonic.com>
for customers in the USA or Puerto Rico**

Thank you for purchasing your new Panasonic cordless telephone.

Please read **IMPORTANT SAFETY INSTRUCTIONS** on page 81 before use. Read and understand all instructions.

Caller ID and Call Waiting Service and Voice Mail Service, where available, are telephone company services. After subscribing to Caller ID, this phone will display a caller's name and phone number. Call Waiting Caller ID, which displays a second caller's name and phone number while the user is on the phone line with the first caller, requires a subscription to both Caller ID with Name and Call Waiting Service. After subscribing to Voice Mail Service, this phone's VM indicator will flash when there are new messages left in the voice mail box at phone company.

Attach your purchase receipt here.

Energy Star:

As an ENERGY STAR® Partner, Panasonic has determined that this product meets the ENERGY STAR guidelines for energy efficiency. ENERGY STAR is a U.S. registered mark.



Accessories (included) For extra orders, call 1-800-332-5368.

- AC Adaptor (p. 11)
Order No. PQLV10Z

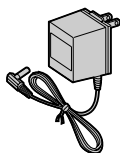

one

- 4-Wire Telephone Line
Cord with Green Plugs
(p. 12, 13)
Order No. PQJA10088Z



one

- 2-Wire Telephone Line
Cord with Transparent
Plugs (p. 13)
Order No. PQJA10075Z



one

- Battery
(p. 14, 72)
Order No.
PQPP511SVC
(P-P511)

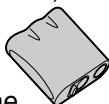

one

- Handset Cover
(p. 14, 72)
Order No.
PQKK10126Z1



one

- Wall Mounting
Adaptor (p. 68)
Order No.
PQKL10044Z1

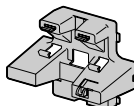

one

- Belt Clip (p. 71)
Order No.
PQKE10340Z1

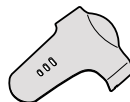

one

To use more than one handset, please purchase the optional handset KX-TGA270S, KX-TGA271V, KX-TGA271W and KX-TGA272S. To order, contact your dealer or call 1-800-211-PANA(7262) to locate a dealer.

For Best Performance

Battery Charge

A rechargeable Ni-Cd battery powers the handset. Charge the battery for about **15 hours** before initial use (p. 14).



Base Unit Location/Noise

Calls are transmitted between the base unit and the handset using wireless radio waves. **For maximum distance and noise-free operation**, the recommended base unit location is:

Away from electrical appliances such as a TV, personal computer or another cordless phone.

In a **HIGH** and **CENTRAL** location with no obstructions such as walls.

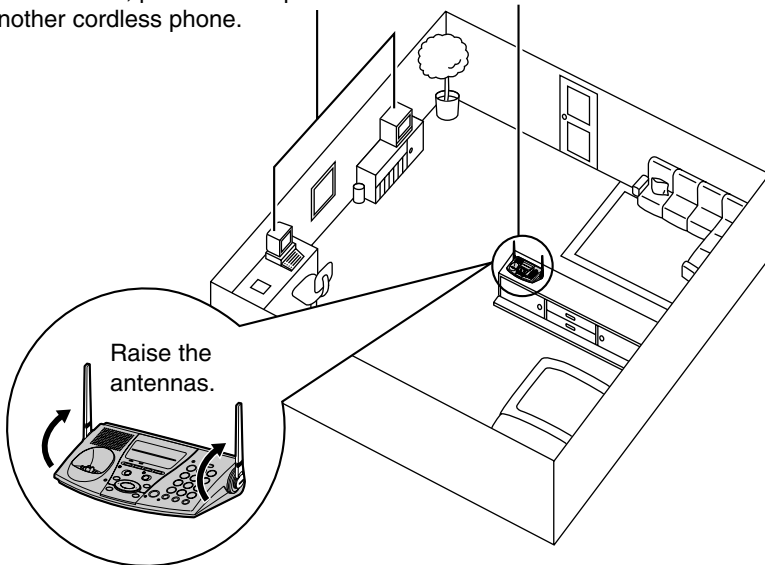

Note:

While using the handset:

- If you are near a microwave oven which is being used, noise may be heard from the receiver or the speaker. Move away from the microwave oven and closer to the base unit.
- If you use the handset near another cordless phone's base unit, noise may be heard. Move away from the other cordless phone's base unit and closer to your base unit.

Contents

Preparation

Location of Controls	6
Display	10
Installation	11
Connecting the AC Adaptor....	11
Connecting the Telephone Line Cord.....	12
Installing the Battery in the Handset	14
Battery Charge	14
Programmable Settings	16
Programming Guidelines.....	16
Function Menu Table	17
Dialing Mode	18
Line Mode.....	19
Auto Talk Feature.....	20
Ringer Volume.....	21
LCD Contrast.....	22
Registration for Additional Handsets	23

Basic Operation

Making Calls	24
Handset	24
Base Unit (Digital Duplex Speakerphone)	28
Answering Calls	30
Handset	30
Base Unit	31
Caller ID Service	32
Using the Caller List	33
Viewing the Caller List.....	33
Calling Back from the Caller List	34
Editing the Caller's Phone Number.....	35

The Caller ID Number Auto Edit Feature	36
Storing Caller List Information in the Directory	37
Erasing Caller List Information.....	38

Advanced Operation

Speed Dialer	39
Storing Phone Numbers	39
Dialing a Stored Number	39
Directory	40
Storing Names and Numbers	40
Dialing from the Directory	42
Editing.....	43
Erasing	44
Sending the Directory (When the System Has Additional Handsets)	45
Using the Other Line During a Conversation	47
Intercom	48
Making Intercom Calls.....	48
Answering Intercom Calls.....	50
Transferring a Call	51
Conference	53
Call Share.....	55
Room Monitor Feature	56
2-Way Radio Communication (When the System Has Additional Handsets)	58

Voice Mail Service	60
Storing a Voice Mail Access Number.....	60
Setting the Voice Mail (VM) Tone Detection	61
Listening to Voice Mail Messages	62
Special Features	63
Muting Your Conversation.....	63
For Call Waiting Service Users	63
How to Use the PAUSE Button (For PBX Line/Long Distance Calls)	63
Temporary Tone Dialing (For Rotary or Pulse Service Users)	64
FLASH Button	64
Ringer Tone.....	65
Line Selection	66
Incoming Call Tone	67

Useful Information

Wall Mounting	68
Adding Another Phone	70
Belt Clip	71
Optional Headset	71
Battery Replacement	72
Canceling Registration/ Re-registration	73
Canceling the Handset Registration	73
Re-registering the Handset ...	74
If the Following Appear	75
Troubleshooting	77
Important Safety Instructions	81
FCC and Other Information ...	83
Specifications	85
Index	86

Location of Controls

Base unit

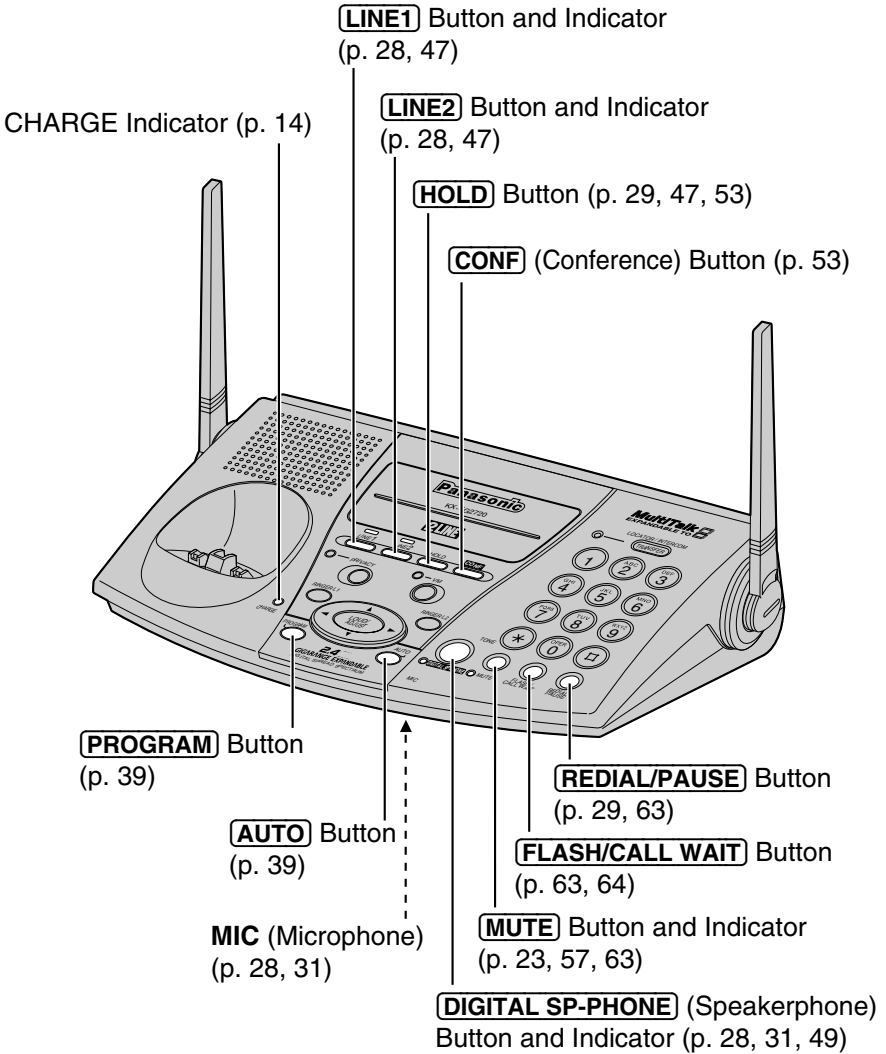



LOCATOR/INTERCOM/TRANSFER

Button and Indicator (p. 49, 50, 51, 52)

VM (Voice mail) Button and Indicator
(p. 60, 62)

PRIVACY Button and Indicator
(p. 55)

Antenna (p. 3, 11)

Antenna (p. 3, 11)
Charge Contacts (p. 15)

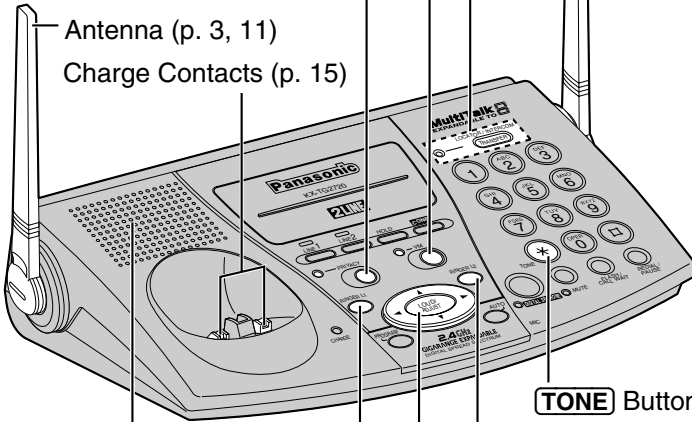

Speaker (p. 29)

TONE Button (p. 64)

RINGER L2 Button
(p. 22, 65)

RINGER L1 Button (p. 22, 65) Navigator Key (▲, ▼, ◀, ▶)
(p. 29, 65)

How to use the Navigator key:

This key has four active areas that are indicated by arrows.

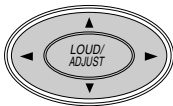

- Pressing the up and down arrows allows you to adjust the speaker volume and the ringer volume.
- Pressing the right and left arrows allows you to select the ringer tone.

Throughout these Operating Instructions, the Navigator key is indicated by the arrows ▼, ▲, ◀ or ▶.

➔ Location of Controls

Handset

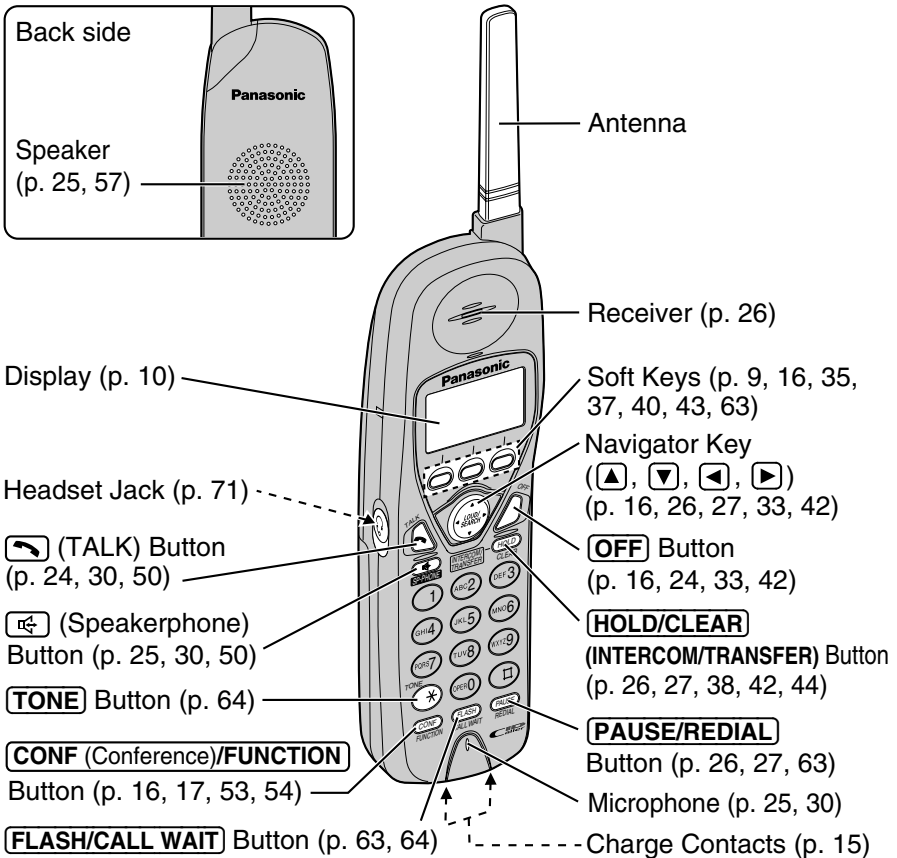

How to use the Navigator key

This key has four active areas that are indicated by arrows.



- Pressing the up and down arrows allows you to scroll through a list of settings, the Caller List and your personal directory. The up and down arrows are also used to adjust the ringer volume and the receiver/speaker volume.
- Pressing the right and left arrows allows you to enter the directory list and to move the cursor when entering directory items.
- The right arrow is also used to select your menu choices.

Throughout these Operating Instructions, the Navigator key is indicated by the arrows ▼, ▲, ◀ or ▶.

How to use the handset soft keys:

Ex. 1

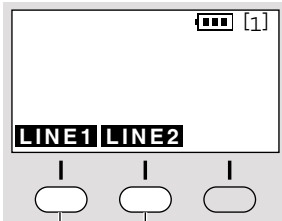

Three soft keys are used to select functions displayed directly above the keys. Functions displayed above the keys will change depending on the state of usage.

For example, on the left display, "**LINE1**" and "**LINE2**" are displayed above the soft keys.

To operate "**LINE2**", press the middle soft key.

To operate "**LINE1**", press the left soft key.

Ex. 2

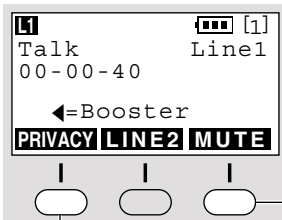

To operate "**MUTE**", press the right soft key.

To operate "**PRIVACY**", press the left soft key.

- When a function does not appear above a soft key, the soft key will not work.

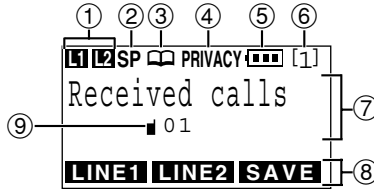

Display

The handset shows you instructions and information on the display. These display prompts are shown below.



① “**L1**” and “**L2**” (Line status icons) function as follows.

Off (invisible)	The line is free.
On	The line is being used.
Flashing	A call is on hold within this system (handset or base unit).
Flashing quickly	A call is being received.

- ② “**SP**” shows when you are using the handset speakerphone during an intercom call, a conference call or while in the 2-Way Radio mode. When you monitor a room from the speaker, “**SP**” will also be displayed.
- ③ “” (directory icon) is displayed when storing, viewing, sending or receiving the directory items (p. 40).
- ④ “**PRIVACY**” indicates the Call Privacy mode is on (p. 55). The base unit and other handsets cannot join your conversation.
- ⑤ The battery icon indicates the battery strength (p. 14).
- ⑥ The extension number of the handset is displayed if the handset has been registered to the base unit (p. 23, 74).
- ⑦ The display shows the dialed number, call status, programming options and directory items etc. If you subscribe to a Caller ID service, caller information will be displayed. “Received calls” will be displayed when new calls have been received.
- ⑧ The prompts on the bottom line will show corresponding functions of the three soft keys which are located directly below the display (p. 9).
Ex. The soft key below “**SAVE**” will function as **SAVE** key.
- ⑨ “” (extension icon) is displayed with the extension numbers during an intercom (p. 48) or a conference call (p. 53), or while using the Room Monitor feature (p. 57) or the 2-Way Radio mode (p. 59).

Backlit LCD display

The lighted handset display will stay on for a few seconds after pressing a handset button to start operations, lifting the handset or pressing a button to complete operations such as hanging up a call, viewing the Caller List/Directory or programming.



Connecting the AC Adaptor

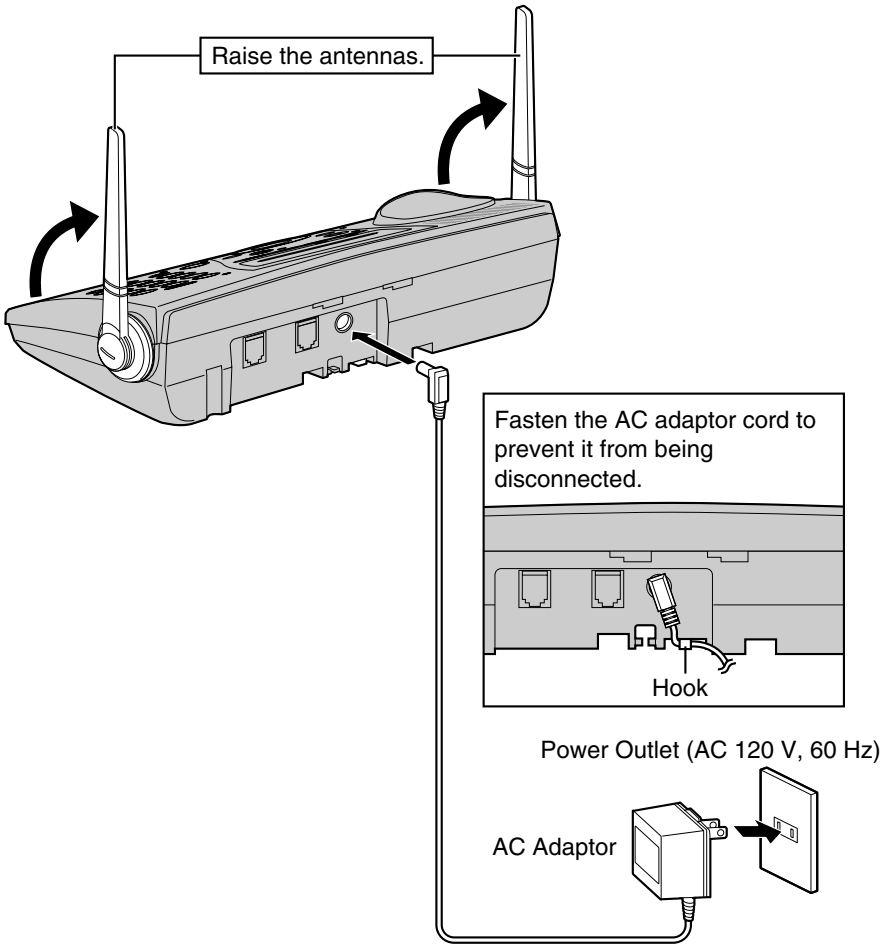

- USE ONLY WITH Panasonic AC ADAPTOR PQLV10 (Order No. PQLV10Z).
- The AC adaptor must remain connected at all times. (It is normal for the adaptor to feel warm during use.)
- To connect a standard telephone on the same line, see page 70.
- If your unit is connected to a PBX which does not support Caller ID and voice mail services, you cannot access those services.

➔ Installation

Connecting the Telephone Line Cord

Connect the telephone line cord(s) to the unit as follows.

To connect a two-line telephone jack

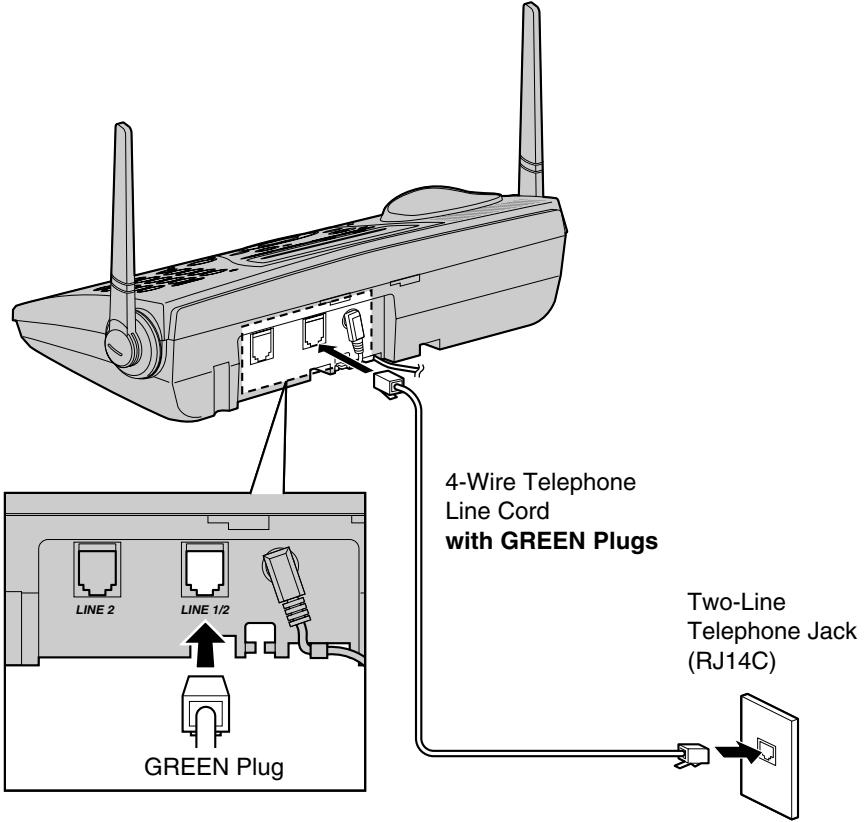



To connect two single-line telephone jacks

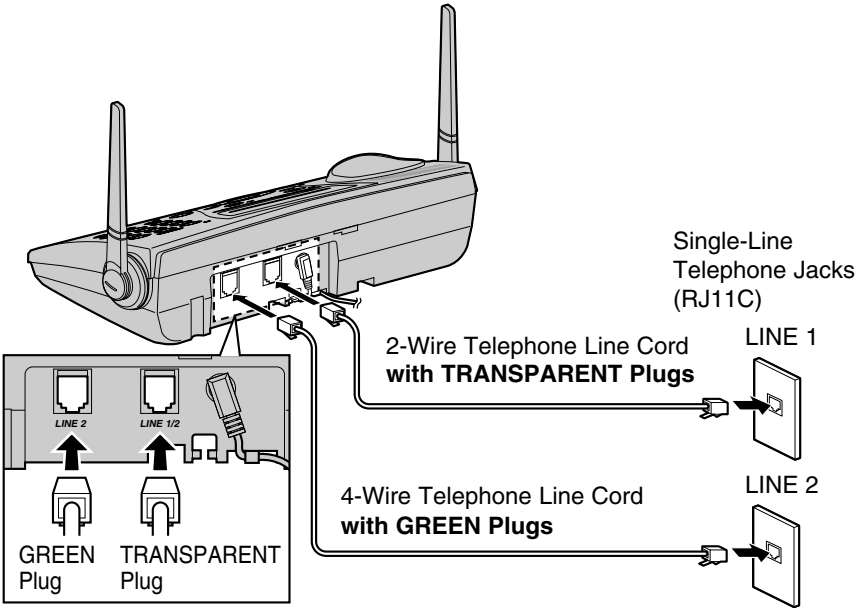

If you use the unit as a single-line telephone only

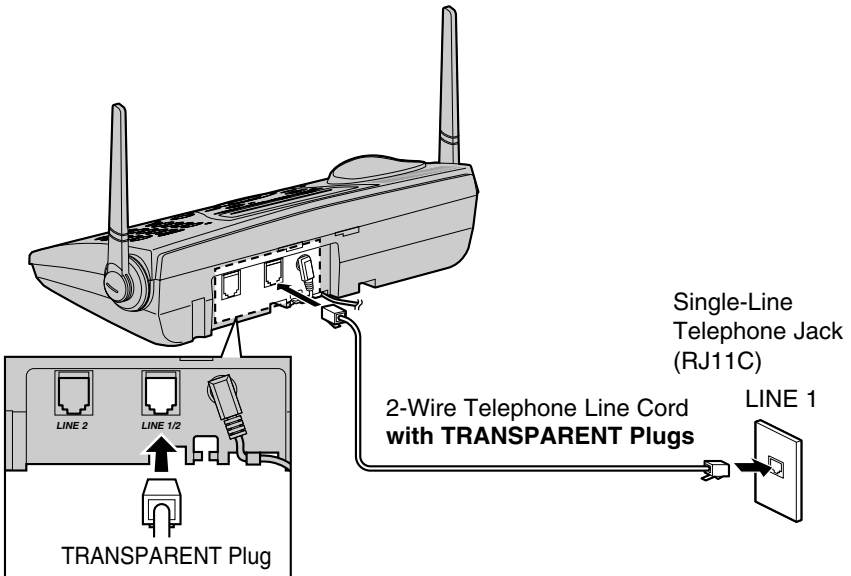

➔ Installation

Installing the Battery in the Handset

Insert the battery into the handset as shown, matching the correct polarity (①). Press the battery down until it places into the compartment (②). When finished, close the cover.

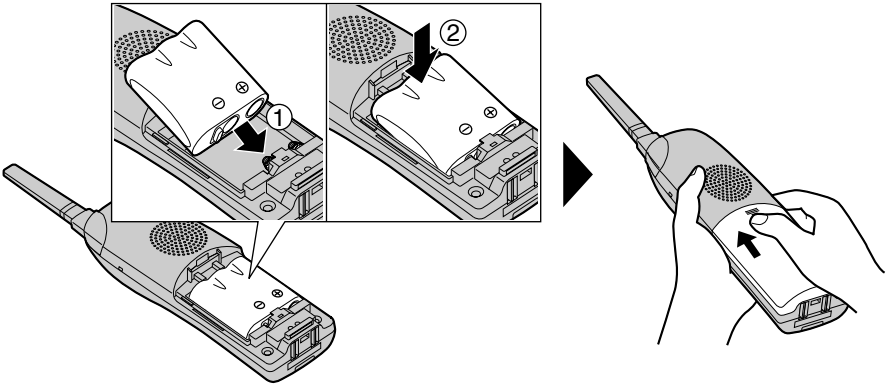

Battery Charge



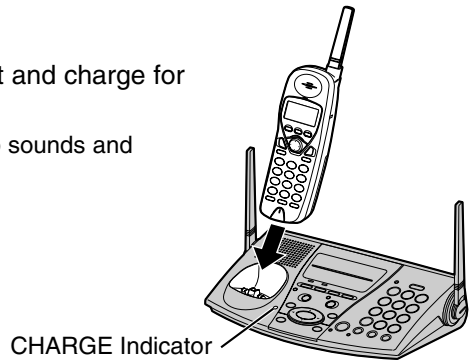

Place the handset on the base unit and charge for about **15 hours** before initial use.

- The CHARGE indicator lights, a beep sounds and "Charging" will be displayed.



Battery strength

You can check the battery strength on the handset display. The battery strength is as shown in the chart below.



Display prompt	Battery strength
	Fully charged
	Medium
	Low
	Needs to be recharged.
	Discharged

Recharge

Recharge the battery when:

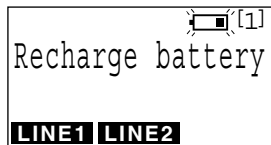
- “Recharge battery” is displayed on the handset,
- “” flashes on the display, or
- the handset beeps intermittently while it is in use.



- If you DO NOT recharge the handset battery for more than 15 minutes, the display will continually indicate “Recharge battery” and/or “” will flash when the handset is lifted off the base unit.
- If the battery has been discharged, the handset will display “Charge for 15HRS” and “” when you place the handset on the base unit. The handset will not work. Keep charging.

Battery information

After your Panasonic battery is fully charged (p. 14):

Operation	Operating time
While in use (TALK)	Up to 4.5 hours
While not in use (Standby)	Up to 11 days
While using the Reception Booster feature (p. 26)	Up to 3.5 hours

When using the 2-Way Radio mode (p. 58) with the battery fully charged:





Operation	Operating time
While in use (TALK)	Up to 4.5 hours
While not in use (Standby)	Up to 12 hours

- The battery operating time may be shortened depending on usage conditions and ambient temperature.
- Clean the handset and the base unit charge contacts with a soft, dry cloth once a month. Clean more often if the unit is subject to grease, dust or high humidity.** Otherwise the battery may not charge properly.
- If the battery is fully charged, you do not have to place the handset on the base unit until “Recharge battery” is displayed and/or “” flashes. This will maximize the battery life.
- The battery cannot be overcharged.

Programmable Settings

Programming Guidelines

This unit has programmable functions. Most of them are selected from the function menu on the display (p. 17).

Navigator key has four active areas that are indicated by arrows. The key is indicated by the arrows , ,  or  in the Operating Instructions.

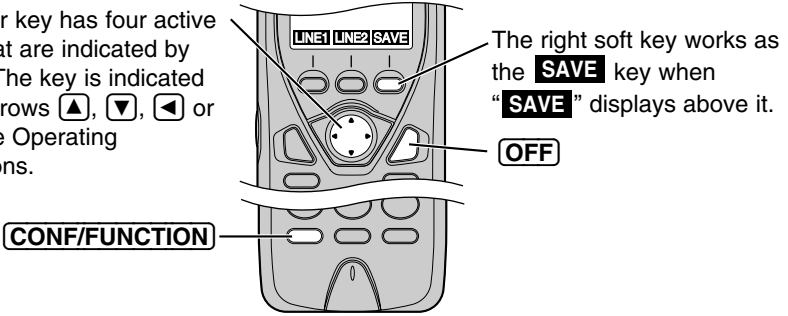





How to select a function item from the menu

Make sure the handset is not being used.

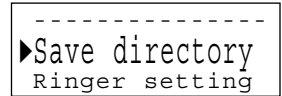
1. Press **CONF/FUNCTION**.



- The main menu is displayed (p. 17).

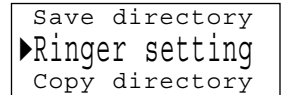

2. You can scroll through the menu by pressing  or . Scroll to the desired item by pressing  or .



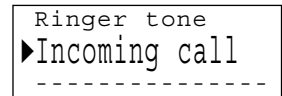

3. Press  to select the item.

4. If the item has a sub-menu I, it will be displayed. Select the sub-menu I item by pressing  or , and press . If the sub-menu I item has the sub-menu II, it will be displayed. Select the sub-menu II item in the same way.



Ex. Incoming Call Tone setting

5. You can then select the desired setting by pressing  or .

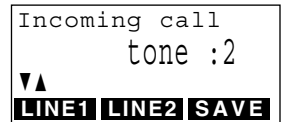

6. To save the setting, press the right soft key (**SAVE**).

- When programming is complete, a confirmation tone sounds. The display will return to the main menu or the sub-menu I or the sub-menu II (if the function item is in the sub-menu I or in the sub-menu II). You can continue programming for the other line or other items. To exit the menu, press **OFF**.



Useful information:

- “-----” indicates the beginning or end of the function menu.
- You can go back to the previous display by pressing except when entering characters or numbers. To return to the main menu from the sub-menu I or sub-menu II, press .
- You can exit the programming mode any time by pressing **OFF**.
- If you do not press any buttons for 60 seconds, the handset will exit the programming mode.
- If the unit detects a problem, an error message will be displayed (p. 75).

Function Menu Table

You can use the following functions to customize your unit. After pressing **CONF/FUNCTION**, the main menu is displayed. Most items in the main menu have a sub-menu I. The sub-menu I is shown after selecting the item in the main menu. If the sub-menu I item has the sub-menu II, it will be displayed after selecting that sub-menu I item. See the corresponding pages for function details.

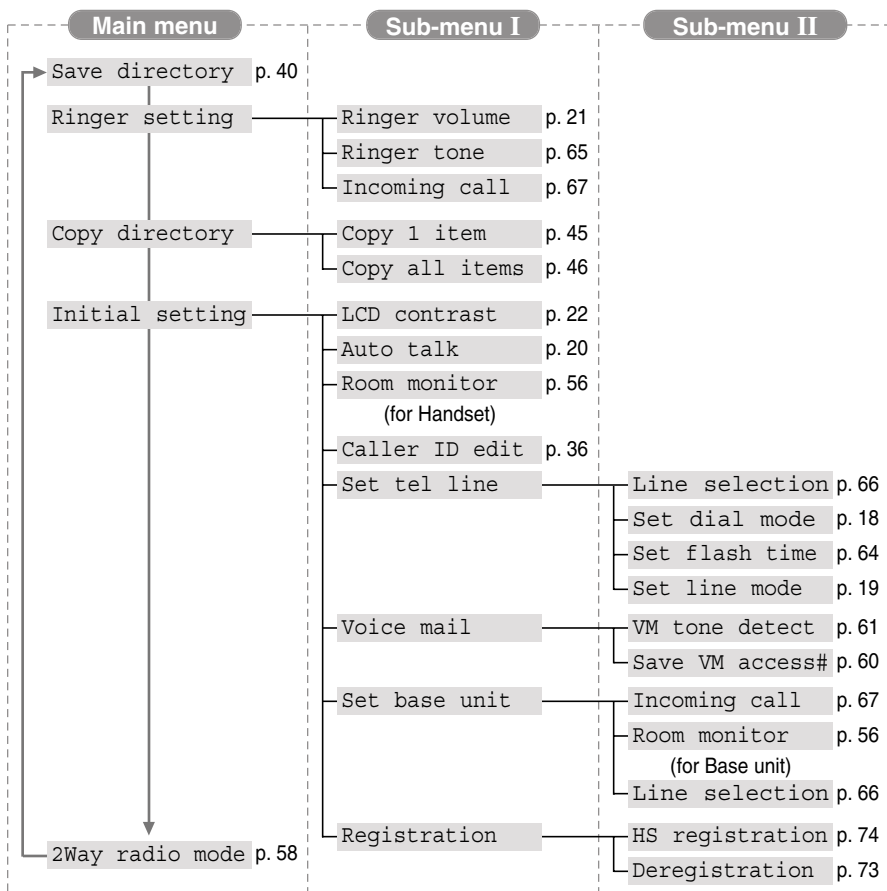

➡ Programmable Settings

Dialing Mode

If you have touch tone service, set to “Tone”. If rotary or pulse service is used, set to “Pulse”. Your phone comes from the factory set to “Tone”.

Make sure the base unit and the handset are not being used.

1 Press **CONF/FUNCTION**.

```
-----
▶Save directory
  Ringer setting
```

2 Scroll to “Initial setting” by pressing ▼ or ▲, and press ▶.

```
Copy directory
▶Initial setting
  2Way radio mode
```

3 Scroll to “Set tel line” by pressing ▼ or ▲, and press ▶.

```
Caller ID edit
▶Set tel line
  Voice mail
```

4 Scroll to “Set dial mode” by pressing ▼ or ▲.

```
Line selection
▶Set dial mode
  Set flash time
```

5 Press ▶.
•The current setting is displayed.

```
Set dial mode
                          :Tone
▼▲
LINE1 LINE2 SAVE
```

6 Select “Pulse” or “Tone” by pressing ▼ or ▲.

```
Set dial mode
                          :Pulse
▼▲
LINE1 LINE2 SAVE
```

7 Press the right soft key (**SAVE**).
•A beep sounds.
•To exit the programming mode, press **OFF**.

```
Set dial mode
                          :Pulse
```

•You can exit the programming mode any time by pressing **OFF**.



Line Mode

If the line is connected to a low voltage system such as a PBX, set to “B”. Your phone comes from the factory set to “A”.

Make sure the base unit and the handset are not being used.

1 Press **CONF/FUNCTION**.

```
-----
▶Save directory
Ringer setting
```

2 Scroll to “Initial setting” by pressing **▼** or **▲**, and press **▶**.

```
Copy directory
▶Initial setting
2Way radio mode
```

3 Scroll to “Set tel line” by pressing **▼** or **▲**, and press **▶**.

```
Caller ID edit
▶Set tel line
Voice mail
```

4 Scroll to “Set line mode” by pressing **▼** or **▲**, and press **▶**.

```
Set flash time
▶Set line mode
-----
```

5 Press **▼** (Line 1) or **▲** (Line 2) to select the line.
•The line’s current setting will be displayed.

```
Set line mode
▼=Line1 ▲=Line2
```

6 Select “B” or “A” by pressing **▼** or **▲**.

```
Set line mode
Line1 :B
▼▲
LINE1 LINE2 SAVE
```



7 Press the right soft key (**SAVE**).
•A beep sounds.
•To program the other line, start again from step 4.
•To exit the programming mode, press **OFF**.

```
Set line mode
Line1 :B
```

•You can exit the programming mode any time by pressing **OFF**.

➔ Programmable Settings



Auto Talk Feature

The Auto Talk feature allows you to answer a call by lifting the handset off the base unit without pressing  or . If you purchase an additional handset (p. 23), you can answer a call by lifting it off the charger. If you want to use this feature, turn the feature ON by programming. Your phone comes from the factory set to OFF.

Make sure the handset is not being used.

1 Press **CONF/FUNCTION**.



```
-----
▶Save directory
Ringer setting
```

2 Scroll to “Initial setting” by pressing  or .

```
Copy directory
▶Initial setting
2Way radio mode
```

3 Press .



```
-----
▶LCD contrast
Auto talk
```

4 Scroll to “Auto talk” by pressing  or .

```
LCD contrast
▶Auto talk
Room monitor
```

5 Press .
•The current setting is displayed.

```
Auto talk
:Off
▼▲
LINE1 LINE2 SAVE
```

6 Select “On” or “Off” by pressing  or .

```
Auto talk
:On
▼▲
LINE1 LINE2 SAVE
```

7 Press the right soft key (**SAVE**).
•A beep sounds.
•To exit the programming mode, press **OFF**.

```
Auto talk
:On
```

- You can exit the programming mode any time by pressing **OFF**.
- In order to view Caller ID information after you lift up the handset to answer a call, leave the Auto Talk feature OFF.



Ringer Volume

Handset

You can select the handset ringer volume for each line. Set to HIGH, MEDIUM, LOW or OFF. If set to OFF, the handset will not ring for the line(s). Your phone comes from the factory set to HIGH.

Make sure the handset is not being used.

- 1 Press **CONF/FUNCTION**.
- 2 Scroll to "Ringer setting" by pressing **▼** or **▲**, and press **▶**.
- 3 Press **▶** at "Ringer volume".
- 4 Press **▼** (Line 1) or **▲** (Line 2) to select the line.
- 5 Select the desired volume by pressing **▼** or **▲**.
 - Each time you press **▼** or **▲**, the volume will change and ring.
 - To turn the ringer OFF: press **▼** repeatedly until "Off ?" displays.
- 6 Press the right soft key (**SAVE**).
 - A beep sounds.

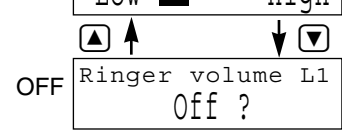
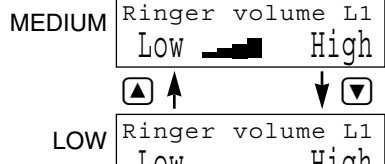
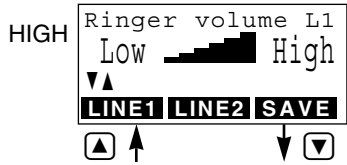
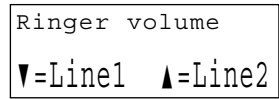
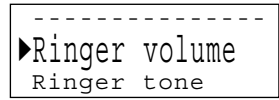
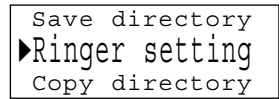

To turn the ringer ON:

Press **▲** in step 5, and press the right soft key (**SAVE**).

- The ringer will sound at the LOW level.
- You can exit the programming mode any time by pressing **OFF**.
- If set to OFF, "Ringer off" will be displayed while the handset is not in use. After receiving a voice mail message, "Ringer off" will not be displayed but "Voice mail" will be displayed.
- You can also select each line's ringer volume while a call is being received for the line. Press **▼** or **▲** while the handset is just ringing for the line.
- To adjust the ringer volume for the 2-Way Radio mode, see page 59.
- You can change the ringer tone for each line. See page 65.

➡ Programmable Settings

Base unit

You can set the base unit ringer volume to HIGH, MEDIUM, LOW or OFF. If set to OFF, the base unit will not ring for the line(s). Your phone comes from the factory set to HIGH.

Make sure the base unit is not being used.

To select **HIGH (preset), MEDIUM or LOW**, press **RINGER L1** or **RINGER L2** repeatedly until the desired volume is selected for line 1 or line 2.

•Each time you press the button, the ringer volume will change and ring.

To turn the ringer **OFF**, press and hold **RINGER L1** or **RINGER L2** until 2 beeps sound.

To turn the ringer **ON**, press **RINGER L1** or **RINGER L2**.

•The ringer will sound at the LOW level.

•You can also select each line's ringer volume while a call is being received for the line. Press **▼** or **▲** while the base unit is just ringing for the line.

•You can change the ringer tone for each line. See page 65.

LCD Contrast

You can program the handset LCD contrast (6 levels). Your phone comes from the factory set to level 3.

Make sure the handset is not being used.

1 Press **CONF/FUNCTION**, and scroll to "Initial setting" by pressing **▼** or **▲**, and press **▶**.

2 Press **▶** at "LCD contrast".

3 Select the desired contrast by pressing **▼** or **▲**.

•Each time you press **▼** or **▲**, the LCD contrast will change.

•The number of steps shows the LCD contrast level.

4 Press the right soft key (**SAVE**).

•A beep sounds.

•To exit the programming mode, press **OFF**.

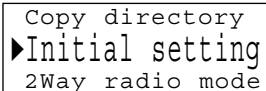

Copy directory
▶Initial setting
2Way radio mode



▶LCD contrast
Auto talk

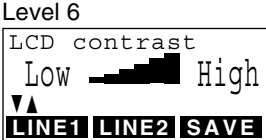

Level 6
LCD contrast
Low ██████████ High
▼▲
LINE1 LINE2 SAVE



Level 4 ▲ ▼
Low ██████ High



Level 1 ▲ ▼
Low █ High

•You can exit the programming mode any time by pressing **OFF**.

Registration for Additional Handsets →

KX-TG2720S includes a handset with the base unit. You can expand the system by adding up to 7 optional handsets to the system. A maximum of 8 handsets can be registered at the base unit.

Generally a maximum of 3 extensions excluding or including the base unit can operate at a time. If 3 other extensions are in use, such as conducting external/internal calls, you may not be able to use your unit. "System is busy. Please try again later." will display when you try to operate your unit. The maximum operating number may decrease, depending on the state of usage, such as using the Reception Booster mode (p. 26).

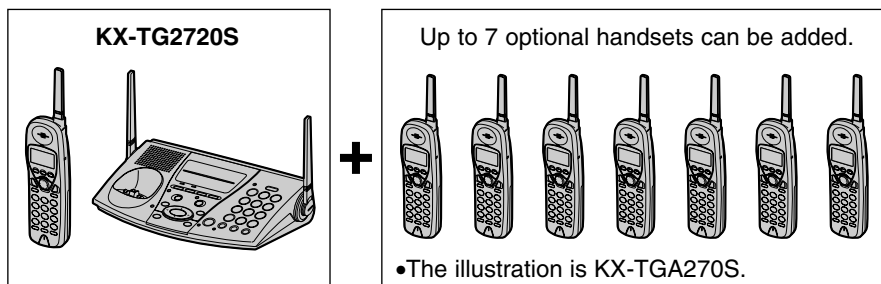

The included handset is pre-registered at the factory and assigned the extension number 1. You do not need to register this handset which has "[1]" on the display.

If you purchase optional handsets, you must register each of them at the base unit. Only one handset can be registered at a time. A handset will be assigned the extension number at registration.

The model numbers of the optional handsets are KX-TGA270S, KX-TGA271V, KX-TGA271W and KX-TGA272S. To order, contact your dealer or call 1-800-211-PANA(7262) to locate a dealer.

Make sure the base unit and the other handsets are not being used. Registration must be completed within 1 minute.

The handset display shows the instructions as shown on the right.

- 1 Base unit:** Press **MUTE**.
 - The MUTE indicator light flashes.

- 2 Handset:**
 - ① Press the right soft key (**OK**).

- ② Wait until a long beep sounds and the display shows the registered number. The registration will be then complete.

- The registered number "[1]" to "[8]" is shown on the top right of the display.

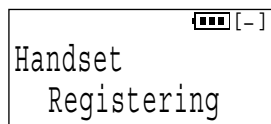
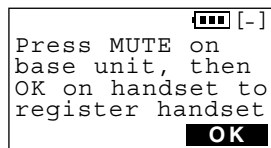

Ex. Extension number 2

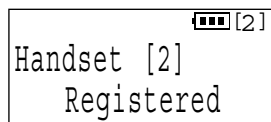

➔ Registration for Additional Handsets

- You can stop registration by pressing **OFF** on the handset and pressing **MUTE** on the base unit.

To re-register a handset to a different base unit of the same model, see pages 73 and 74.

Making Calls

Two calls can be handled simultaneously on separate telephone lines by the handset and the base unit, or by two handsets (when the system has one or more additional handsets, p. 23).

Handset

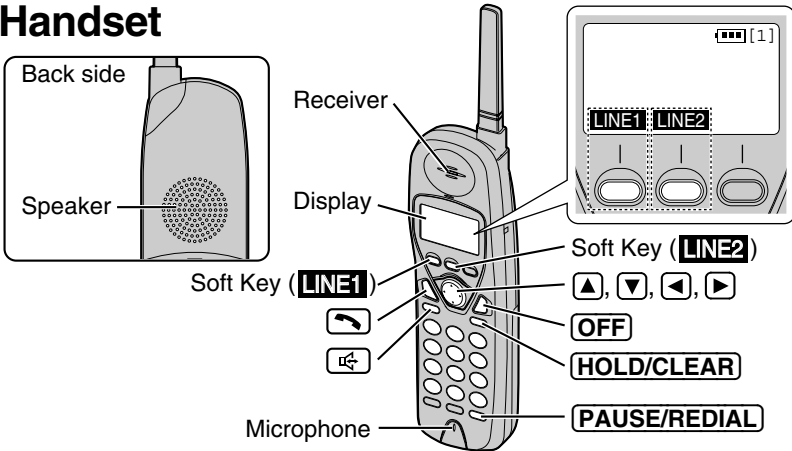

- 1 Press .
 - A free line is automatically selected and the line status icon is displayed. (To change the line selection, see page 66.)
 - You can select a line by pressing the left soft key (**LINE1**) or the middle soft key (**LINE2**), instead of pressing .
- 2 Dial a phone number.
 - The dialed number is displayed.
 - After a few seconds, the display will show the length of the call.
- 3 To hang up, press **OFF** or place the handset on the base unit.
 - The line status icon goes out.
 - "Off" will be displayed.

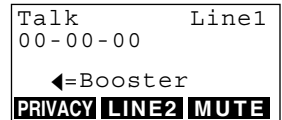
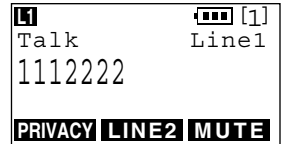
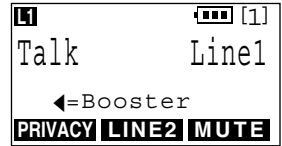



- To use “**PRIVACY**” and “**MUTE**” features using the soft key (p. 9), see pages 55 and 63.
- To use the Reception Booster feature, see page 26.

To have a hands-free phone conversation (Using Digital Duplex Speakerphone)

- 1 Press .
 - A free line is automatically selected and the line status icon is displayed. (To change the line selection, see page 66.)
 - “SP-phone” is displayed.
- 2 Dial a phone number.
 - The dialed number is displayed.
 - After a few seconds, the display will show the length of the call.
- 3 When the other party answers, talk into the microphone.
- 4 To hang up, press **OFF** or place the handset on the base unit.
 - The line status icon goes out.

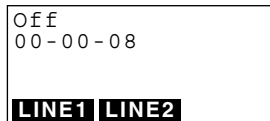
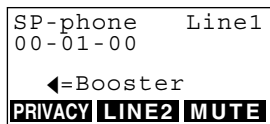
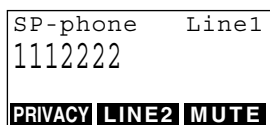
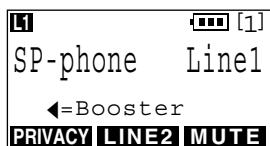

Hands-free Digital Duplex Speakerphone

For best performance, please note the following:

- Talk alternately with the caller in a quiet room.
- If the other party has difficulty hearing you, press to decrease the speaker volume.
- If the other party's voice from the speaker cuts in/out during a conversation, press to decrease the speaker volume.
- While talking using the receiver, you can switch to the hands-free phone conversation by pressing . To switch back to the receiver, press .

Lighted handset keypad

The handset dialing buttons will light when you press a button or lift the handset or when a call is received. The lights will go out a few seconds after pressing a button to start operations, lifting the handset, answering a call or pressing a button to complete operations such as hanging up a call, leaving the Caller List/Directory or programming.

➔ Making Calls

To adjust the receiver volume (HIGH, MEDIUM or LOW) or speaker volume (6 levels) while talking

To increase, press . To decrease, press .

- Each time you press or , the volume level will change.
- The number of steps indicates the volume level.
- The display will return to the length of the call.

Ex. Receiver volume: High
Speaker volume: Level 6



Reception Booster feature

The feature allows the handset to improve the sound quality when using in an area with interference.

Press in the talk or speakerphone mode.

- “Booster on” will flash on the display.
- To turn the feature off, press or .
- The feature will be off after hanging up or when putting a call on hold or making a conference.
- The battery operating time will be shortened using this feature (p. 15).

Ex. Talk mode

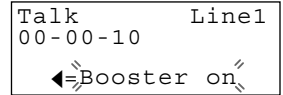
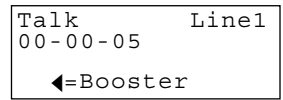

To dial after confirming the entered number

- 1 Enter a phone number.
 - If you misdial, press **HOLD/CLEAR**. One digit will be erased. Dial the correct phone number.
 - To cancel, press **OFF**.

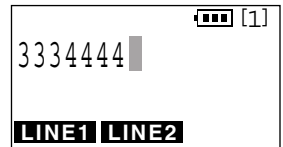

- 2 Press .
 - You can select a line by pressing the left soft key (**LINE1**) or the middle soft key (**LINE2**), instead of pressing .

OR

To have a hands-free phone conversation, press , and when the other party answers, talk into the microphone.

- After a few seconds, the display will show the length of the call.

Ex. Speakerphone mode

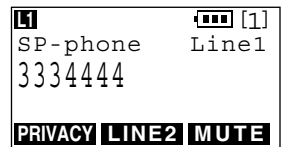

- 3 To hang up, press **OFF** or place the handset on the base unit.



To redial the last number dialed on the handset

Press or , and press **PAUSE/REDIAL**.

- You can select a line by pressing the left soft key (**LINE1**) or the middle soft key (**LINE2**), instead of pressing .

To redial using the redial list (Memory Redial)

The last 5 phone numbers dialed with the handset are stored in the redial list.

1. Press **PAUSE/REDIAL**.

- The last number dialed is displayed with number 1.

```

333-4444
▼▲
--Redial list1--

```

2. Scroll to the desired number by pressing

or .

- You can also scroll down through the list by pressing **PAUSE/REDIAL**.
- To exit the list, press **OFF**.

3. Press or .

- You can select a line by pressing the left soft key (**LINE1**) or the middle soft key (**LINE2**), instead of pressing .

• **To erase an item**, repeat steps 1 and 2, and press **HOLD/CLEAR**.

• If “No items stored” is displayed, the list is empty.

To put a call on hold

Press **HOLD/CLEAR** twice.

- “Hold” and the line are displayed. The line status icon and “**LINE1**” or “**LINE2**” flash.
- To transfer the call to the base unit or another handset (if the system has one or more additional handsets, p. 23), see page 51.

Ex. Line 1 on hold.

```

[1] [1]
Hold Line1
[LINE1] [LINE2]

```

- If a call is kept holding for 6 minutes, an alarm tone will start to sound. After 4 additional minutes on hold the call will be disconnected.

To release the hold

From the handset, press the left soft key (**LINE1**) or the middle soft key (**LINE2**) for the line.

From the base unit, press the line button.

- If another phone is connected on the same line (p. 70), you can also release the hold by lifting its handset.
- If the system has one or more additional handsets (p. 23), another handset user can also release the hold by pressing the left soft key (**LINE1**) or the middle soft key (**LINE2**) for the line.

➔ Making Calls

Base Unit (Digital Duplex Speakerphone)

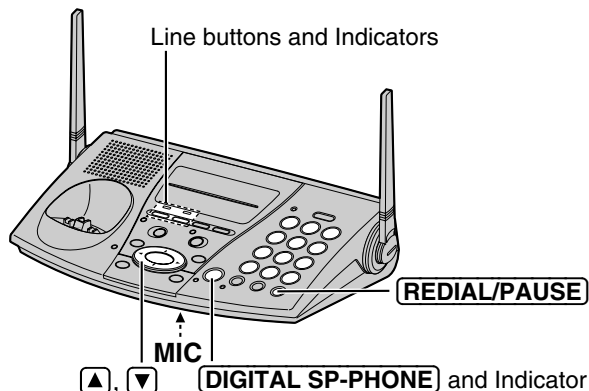

- 1 Press **DIGITAL SP-PHONE**.
 - The DIGITAL SP-PHONE indicator lights.
 - A free line is automatically selected and the line indicator lights. (To change the line selection, see page 66.)
- 2 Dial a phone number.
- 3 When the other party answers, talk into the **MIC** (microphone).
- 4 To hang up, press **DIGITAL SP-PHONE**.
 - The indicator lights go out.

- In step 1, you can select a line by pressing a line button whose indicator does not light, instead of pressing **DIGITAL SP-PHONE**.
- To switch to the handset while using the base unit speakerphone:
 - If the handset is off the base unit, press **LINE1** or **LINE2** for the line, then press **DIGITAL SP-PHONE** on the base unit.
 - If on the base unit, just lift up.
- The line indicators show the line status (p. 29).
- To use **PRIVACY** feature and **MUTE** feature, see pages 55 and 63.

Hands-free Digital Duplex Speakerphone

For best performance, please note the following:

- Talk alternately with the caller in a quiet room.
- If the other party has difficulty hearing you, press ▼ to decrease the speaker volume.
- If the other party's voice from the speaker cuts in/out during a conversation, press ▼ to decrease the speaker volume.



To adjust the speaker volume (8 levels) while talking

To increase, press **▲**.

To decrease, press **▼**.

To redial the last number dialed on the base unit

Press **DIGITAL SP-PHONE** or a line button, and press **REDIAL/PAUSE**.

To put a call on hold

Press **HOLD**.

- The DIGITAL SP-PHONE indicator light goes out and the line indicator flashes.
- If a call is kept holding for 6 minutes, an alarm tone will start to sound.
After 4 additional minutes on hold the call will be disconnected.

To release the hold

From the base unit, press the line button whose indicator is flashing.

From the handset, press the left soft key (**LINE1**) or the middle soft key (**LINE2**) for the line.

- If another phone is connected on the same line (p. 70), you can also release the hold by lifting its handset.

What “**L1**” and “**L2**” (Line status icons) on the handset and the line indicators on the base unit mean

Off	The line is free.
On	The line is being used.
Flashing	A call is on hold within this system (handset or base unit).
Flashing quickly	A call is being received.



Answering Calls

When a call is received, the unit rings and “Incoming call” and the called line are displayed. The line status icon flashes quickly on the handset display and the line indicator flashes quickly on the base unit. The line is automatically selected when you answer the call. (To change the line selection, see page 66.)

If you subscribe to a Caller ID service, the calling party information will be displayed after the first ring (p. 32). In order to view the Caller ID information, please wait until the second ring to answer a call.

Two calls can be handled simultaneously on separate telephone lines by the handset and the base unit, or by two handsets (when the system has one or more additional handsets, p. 23).

Handset



- 1 Press .
 - The called line status icon stops flashing.
 - You can also answer a call by pressing any dialing button (0) to (9), (*), or (#) (**Any Key Talk**).
 - You can answer a call by pressing the left soft key (**LINE1**) or the middle soft key (**LINE2**), instead of pressing .

OR

Press , and when the other party answers, talk into the microphone.

- 2 To hang up, press **OFF**.

Auto Talk

If you set the Auto Talk feature to ON (p. 20), you can answer a call by lifting the handset off the base unit without pressing  or . If you purchase an additional handset (p. 23), you can answer a call by lifting it off the charger.

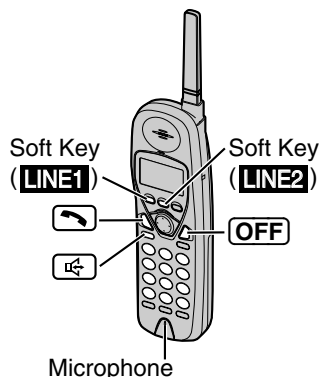

Base Unit

- 1 Press **DIGITAL SP-PHONE**.
 - You can answer a call by pressing the line button instead of pressing **DIGITAL SP-PHONE**.
- 2 Talk into the **MIC**.
- 3 To hang up, press **DIGITAL SP-PHONE**.

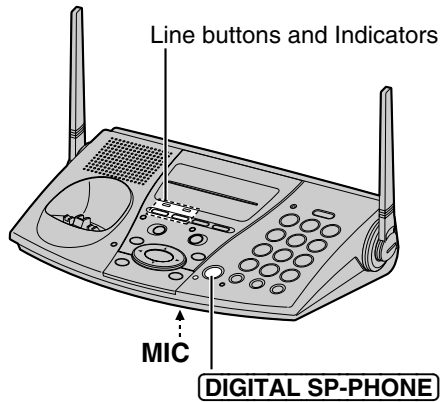

- To transfer the call that you took, to another person, see pages 51 and 52.
- When the ringer volume is OFF for the line(s), the unit will not ring for the line(s) (p. 21, 22).

Caller ID Service

This unit is compatible with a Caller ID service offered by your telephone company. If you subscribe to a Caller ID service, the calling party's information will be shown on the handset after the first ring.

The handset can record information of up to 50 different callers for both lines combined, including the time and date received, the called line, and the number of times called, in the Caller List. The Caller List information is sorted by the most recent to the oldest call. When the 51st call is received, the first call is deleted.

Using the list, you can automatically call back a caller. You can store the callers' names and numbers from the Caller List into the directory.

If you subscribe to both Caller ID and Call Waiting services, when a second call is received on the same line while talking, the new caller's name and phone number will be displayed (p. 63).

How caller information is displayed when a call is received

The handset display shows the caller's name, number and the called line after the first ring.

- After you answer the call, the display will show the length of the call.

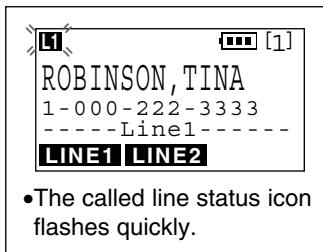

- If both lines receive calls at the same time, each caller's information will be displayed alternately.
- Caller information cannot be displayed in the following cases:
 - If the caller dialed from an area which does not provide a Caller ID service, the display will show "Out of area".
 - If the caller has requested not to display his/her information, the display will show "Private caller".
- If your unit is connected to a PBX which does not support Caller ID and voice mail services, you cannot access those services.
- The name display service may not be available in some areas. For further information, please contact your telephone company.
- If the handset has lost communication with the base unit when a call is received, the caller information will not be recorded in the Caller List.

Using the Caller List



If you have received new calls, "Received calls" will be displayed.

Handset on the base unit

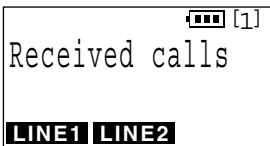

Handset off the base unit

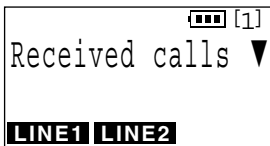

- If the battery needs to be charged, "Received calls" will not be displayed on the handset (p. 15).

Viewing the Caller List

Make sure the handset is not being used.

- 1 Press or to enter the Caller List.

- The display will show, for example, the following.

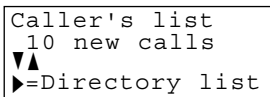

- 2 To search from the most recent call, press . To search from the oldest call, press .

- To scroll between callers, press or .

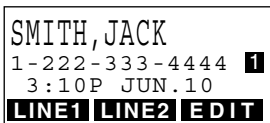

- 3 To exit the list, press .

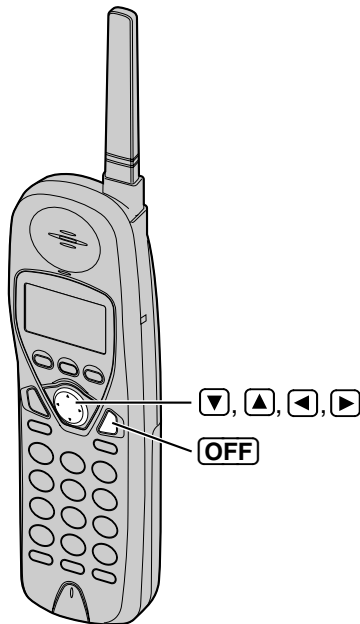

- If "No items stored" is displayed, the Caller List is empty.
- If there is no name information for a caller, the display will only show the phone number.
- After viewing all of the new call entries in the Caller List, "Received calls" will disappear.
- Once new calls have been checked, "√" will be added to caller information.
- If the system has one or more additional handset (p. 23), each handset has the Caller List individually. If you checked the Caller List on your handset, Caller List information in the other handsets will remain still NEW and "√" will not be added.
- In step 1, you can go to the directory list by pressing (p. 42).
- If you do not press any buttons for 60 seconds, the unit will exit the Caller List.

➡ Using the Caller List

What “1” and “2” mean

Indication of which line the caller information was received from.

```
SMITH, JACK
1-222-333-4444 1
3:10P JUN.10
```

What “√” means

When the display shows “√”, you have already viewed this calling information, answered the call or called back the caller. If the same caller calls again, the call entry with “√” will be replaced with the new call entry.

```
SMITH, JACK
1-222-333-4444 1
3:10P JUN.10 √
```



If a caller calls more than once

The number of times the same caller called is displayed (X2 to X9). The date and time of the most recent call will be recorded. After checking, X2 to X9 will be replaced with “√”.



Ex. The caller called 3 times.

```
TURNER, CINDY
1-234-456-7890 2
11:20A JAN.12 X3
```



Calling Back from the Caller List

1 Press  or  to enter the Caller List.



```
Caller's list
3 new calls
▼▲
▶=Directory list
```

2 Scroll to the desired caller by pressing  or .

```
TURNER, CINDY
1-234-456-7890 2
11:20A JAN.12 X3
LINE1 LINE2 EDIT
```

3 Press  or  or the left soft key (**LINE1**) or the middle soft key (**LINE2**).

- The displayed phone number is dialed automatically.

- If the line selection is “Auto” (p. 66), the indicated line will be selected by pressing  or  on the handset. If the indicated line is already being used, select the other line by pressing the soft key (**LINE1** or **LINE2**) on the handset.
- In some cases, you may have to edit the number before dialing (p. 35). (Ex. You may have to delete “1” and the area code.)
- If a phone number is not displayed in the caller information, you cannot call back that caller.



Editing the Caller's Phone Number

You can edit a phone number into one of 3 patterns to call back or store it into the directory.

The Caller ID Number Auto Edit Feature (p. 36)

This feature will allow the unit to edit a Caller ID number into one of 3 patterns you desired for you automatically in the Caller List. For details and activation please see page 36.

Make sure the handset is not being used.

1 Press or to enter the Caller List.

2 Scroll to the desired caller by pressing or .

3 Press the right soft key (**EDIT**) to select a pattern.

- Each time you press the right soft key (**EDIT**), the number is rearranged into one of 3 patterns.

(a)

(b) -

(c) 1 - -

- The order in which patterns (a)–(c) are displayed depends on how the telephone number is displayed in step 2.

4 After editing the number, you can continue with calling back or storing procedures. To call back, press , , or the left soft key (**LINE1**) or the middle soft key (**LINE2**) (p. 34).

To store the number in the directory, press . Follow the instructions on the display (see page 37, from step 4).

Caller's list
3 new calls
▼▲
▶=Directory list

PARKER, FRED
1-234-321-5555 **1**
11:20A JAN.12 ✓
LINE1 LINE2 EDIT

(a) PARKER, FRED
321-5555 **1**
11:20A JAN.12 ✓
LINE1 LINE2 EDIT

(b) PARKER, FRED
234-321-5555 **1**
11:20A JAN.12 ✓
LINE1 LINE2 EDIT

(c) PARKER, FRED
1-234-321-5555 **1**
11:20A JAN.12 ✓
LINE1 LINE2 EDIT

Save directory?
◀=No ▶=Yes

- If a 7-digit number comes without editing, "**EDIT**" will not display with the item and you cannot edit that 7-digit number.

➡ Using the Caller List

The Caller ID Number Auto Edit Feature

There are 3 patterns of phone number (Ⓐ, Ⓑ, and Ⓒ, p. 35). This feature allows your phone to automatically edit an in-coming Caller ID number into one pattern you preferred, and display the Caller ID number with that pattern automatically.

After this feature is activated, Caller ID numbers coming from considered area codes (201, for example), from which the Caller ID numbers have been chosen to follow the desired pattern (7 digit pattern, for example), will be automatically edited from other patterns (11 digit pattern, for example) into the same pattern you have previously selected (which is 7 digit pattern, in the example).

Up to 4 area codes are allowed for this feature for pattern Ⓐ and Ⓑ (p. 35). To activate this feature, you must (1) set this feature to on, and (2) make an out-going call from Caller List (p. 34) with a number which has one of 3 patterns that you have edited with considered area code, and that you prefer to be followed by future Caller ID numbers, so that in the future all the Caller ID numbers coming from the same area code will be displayed in the same pattern.

The Caller ID number Auto Edit feature is preset to ON at factory.

- If you fail to reach your destination when making the call, the phone number you dialed might have an incorrect pattern, please edit the phone number with another pattern (p. 35).

For example, if you move to another area, you may need to turn this feature to OFF to erase previously edited area codes. Then, if still need, you may activate this feature again.

Make sure the handset is not being used.

1. Press **CONF/FUNCTION**.
2. Scroll to "Initial setting" by pressing ▼ or ▲, and press ▶.
3. Scroll to "Caller ID edit" by pressing ▼ or ▲, and press ▶.
4. Select "On" or "Off" by pressing ▼ or ▲.
5. Press the right soft key (**SAVE**).
 - A beep sounds.
 - To exit the programming mode, press **OFF**.

```
Copy directory
▶Initial setting
2Way radio mode
```

```
Room monitor
▶Caller ID edit
Set tel line
```

```
Auto edit                                :On
▼▲
LINE1 LINE2 SAVE
```

- When the feature is set to OFF, the handset will still be able to display Caller ID, like regular Caller ID telephone, but the in-coming Caller ID number will not be edited by pattern and by area codes.



Storing Caller List Information in the Directory

You can store phone numbers that are in the Caller List into the directory.

Make sure the handset is not being used.

1 Press or to enter the Caller List.

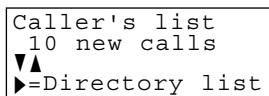

2 Scroll to the caller you want to store in the directory by pressing or .

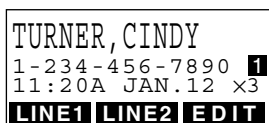

- If the number requires editing, press the right soft key (**EDIT**) (p. 35).

3 Press .

- To stop storing, press .

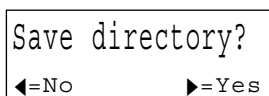

4 Press again.

- A beep sounds.
- To continue storing other items, repeat from step 2.
- To exit the programming mode, press **OFF**.

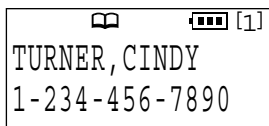

If there is no name information for the caller, "Enter name" will be displayed.

- 1 If a name is not required, press . If a name is required, enter the name (p. 41). When finished, press .

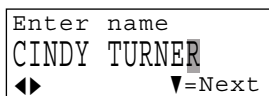
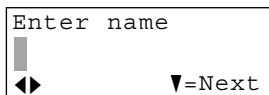

2 Press the right soft key (**SAVE**).

- A beep sounds.
- To continue storing other items, repeat from step 2.
- To exit the programming mode, press **OFF**.

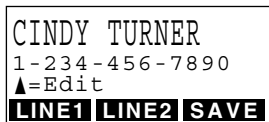

- You can exit the programming mode any time by pressing **OFF**.
- If the display shows "Directory Full" in step 4, press **OFF** to exit the list. To erase other stored items from the directory, see page 44.
- You cannot store caller information in the directory if a phone number is not displayed.

➡ Using the Caller List

Erasing Caller List Information

After checking the Caller List, you can erase some or all of the entries.

To erase a specific caller from the Caller List

Make sure the handset is not being used.

1 Press **▼** or **▲** to enter the Caller List.

```
Caller's list
10 new calls
▼▲
▶=Directory list
```

2 Scroll to the caller you want to erase from the Caller List by pressing **▼** or **▲**.

```
REAGAN, TOM
1-888-777-6666 1
12:20A JAN.12 ✓
```

3 Press **HOLD/CLEAR**.
•A beep sounds and the information is erased.
•To erase other items, repeat from step 2.
•To exit the Caller List, press **OFF**.

```
Clear
```

To erase all entries in the Caller List

Before erasing all entries, make sure that “0 new call” is displayed.

Make sure the handset is not being used.

1 Press **▼** or **▲** to enter the Caller List.

```
Caller's list
0 new call
▼▲
▶=Directory list
```

2 Press **HOLD/CLEAR**.
•To stop erasing, press **◀**.

```
All clear?
◀=No CLEAR=Yes
```

3 Press **HOLD/CLEAR** again.
•A beep sounds and all entries in the Caller List are erased.

```
All clear
```

Speed Dialer

Storing Phone Numbers

You can store up to 10 phone numbers in the base unit. The dialing buttons (0 to 9) function as memory stations.

Make sure the base unit is not being used.

- 1 Press **PROGRAM**.
 - The MUTE indicator flashes.
- 2 Enter a phone number up to 22 digits.
 - If you misdial, press **PROGRAM**, and start again from step 1.
- 3 Press **AUTO**.
- 4 Press a memory station number (0 to 9).
 - A beep sounds.
 - To store other numbers, repeat steps 1 to 4.

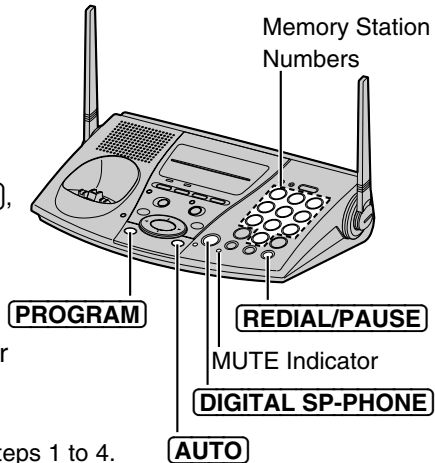

- If a pause is required for dialing, press **REDIAL/PAUSE** where needed. Pressing **REDIAL/PAUSE** counts as one digit (p. 63).

To erase a stored number

Press **PROGRAM**, press **RINGER/AUTO** and press the memory station number (0 to 9) for the phone number to be erased.

Dialing a Stored Number

- 1 Press **DIGITAL SP-PHONE**.
 - You can also press **LINE1** or **LINE2**, instead of pressing **DIGITAL SP-PHONE**.
- 2 Press **AUTO**.
- 3 Press a memory station number (0 to 9).
 - The stored number is dialed.

- Numbers stored in the base unit can only be dialed from the base unit.

Directory



You can store up to 50 names and phone numbers in the directory using the handset. All of the directory items are sorted by the first word in alphabetical order. You can make a call by selecting a name on the display. When the system has one or more additional handsets (p. 23), each handset has the directory list individually, and you can send the directory items from your handset to another handset.

Storing Names and Numbers

Make sure the handset is not being used.

- 1 Press **CONF/FUNCTION**.
- 2 Press **▶** at "Save directory".
 - The display shows the number of stored items in the directory.
- 3 Enter a name, up to 16 characters with the dialing buttons (**0** to **9**) (p. 41).
 - To move the cursor, press **◀** or **▶**.
 - If a name is not required, press **▼** and go to step 5.
- 4 Press **▼**.
- 5 Enter a phone number, up to 22 digits.
 - Each time you press **HOLD/CLEAR**, a digit is erased. To erase all of the digits, press and hold **HOLD/CLEAR**.
- 6 Press **▼**.
 - If you want to change the name or number, press **▲** to reach the desired display and change it.
- 7 Press the right soft key (**SAVE**).
 - A beep sounds.
 - To continue storing other items, repeat from step 2.
 - To exit the programming mode, press **OFF**.

▶Save directory
Ringer setting

Directory
0 item

Enter name
▼=Next

Enter name
Tom Jones
▼=Next

Enter phone no.
▼=Next

Enter phone no.
0987654321
▼=Next

Tom Jones
098-765-4321
▲=Edit
LINE1 LINE2 SAVE

Tom Jones
098-765-4321



- If a pause is required for dialing, **PAUSE/REDIAL** can be stored in a phone number counting as one digit (p. 63).
- You can exit the programming mode any time by pressing **OFF**.
- If the display shows “Directory Full” in step 2 on page 40, press **OFF** to exit the programming mode. To erase other stored items from the directory, see page 44.

Selecting characters to enter names

The dialing buttons (**0** to **9**) can be used to enter letters and symbols. The letters are printed on the dialing buttons. Pressing each button selects a character as shown below.

Keys	Number of times key is pressed										
	1	2	3	4	5	6	7	8	9	10	11
1	#	&	'	()	*	,	-	.	/	1	
2	a	b	c	A	B	C	2				
3	d	e	f	D	E	F	3				
4	g	h	i	G	H	I	4				
5	j	k	l	J	K	L	5				
6	m	n	o	M	N	O	6				
7	p	q	r	s	P	Q	R	S	7		
8	t	u	v	T	U	V	8				
9	w	x	y	z	W	X	Y	Z	9		
0	0	Blank									
◀	Moves the cursor to the left.										
▶	Moves the cursor to the right. (To enter another character using the same number key, move the cursor to the next space.)										
HOLD/CLEAR	Erases characters.										

For example, to enter “Tom Jones”:

1. Press **8** four times.
2. Press **6** three times, then press **▶**.
3. Press **6** once, then press **▶** twice.
4. Press **5** four times, press **6** three times, then press **▶**.
5. Press **6** twice, press **3** twice, then press **7** four times.

T
To
Tom
Tom Jo
Tom Jones

➔ Directory

If you make a mistake while entering a name:

Press ◀ or ▶ to move the cursor to the incorrect character, press **HOLD/CLEAR** to delete and enter the correct character. Each time you press **HOLD/CLEAR** a character is erased. To erase all characters, press and hold **HOLD/CLEAR**.

Dialing from the Directory

Make sure the handset is not being used.

- 1 Press ◀ or ▶ to enter the directory list.
 - The display shows the number of stored items in the directory.

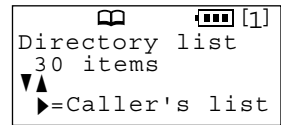

- 2 Scroll to the desired item by pressing ▼ or ▲.
 - All directory items are stored in the order shown on the right.

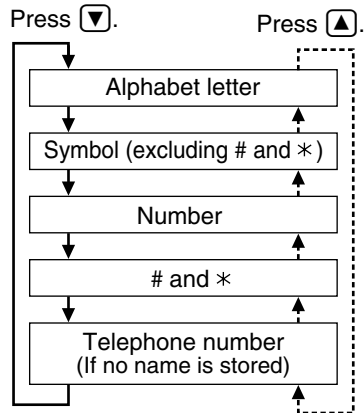

To search for a name by initial:

- ① Press the dialing button for the first letter of the desired name until any name with the same initial is displayed (see the Index table below.)

Ex. To find "Frank", press **3** repeatedly until the first item under "F" is displayed.

- ② Press ▼ repeatedly until the name is displayed.

- 3 Press **CALL** or **END CALL**.

- You can also press the left soft key (**LINE1**) or the middle soft key (**LINE2**), instead of pressing **CALL**.
- The number is dialed automatically.



- If "No items stored" is displayed in step 1, the directory list is empty.
- You can leave the directory list any time by pressing **OFF**.
- In step 1, you can go to the Caller List by pressing ▶ (p. 33).

Index table

Keys	Index	Keys	Index
1	Other symbols, 1	6	M, N, O, 6
2	A, B, C, 2	7	P, Q, R, S, 7
3	D, E, F, 3	8	T, U, V, 8
4	G, H, I, 4	9	W, X, Y, Z, 9
5	J, K, L, 5	0	0



Editing

Make sure the handset is not being used.

1 Press or to enter the directory list.

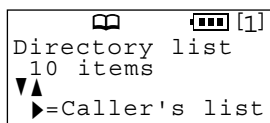

2 Scroll to the directory item you want to change, by pressing or .

- To search for the item by initial, see page 42.

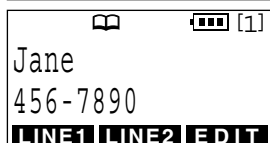

3 Press the right soft key (**EDIT**).

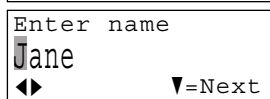

4 Edit the name using the dialing buttons, up to 16 characters (p. 41).

- To move the cursor, press or .
- If you do not need to change the name, press and go to step 6.

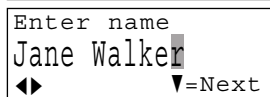

5 Press .

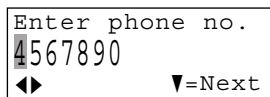

6 Add a number to the current number.

- If you do not need to change the number, press and go to step 8.
- Each time you press **HOLD/CLEAR**, a digit is erased. To erase all digits, press and hold **HOLD/CLEAR**.
- To move the cursor, press or .

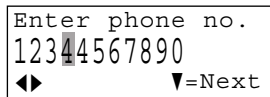

7 Press .

- If you want to change the name or number, press to reach the desired display and change it.



8 When finished, press the right soft key (**SAVE**).

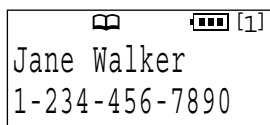

- A beep sounds.
- To continue editing other items, repeat from step 2.
- To exit the directory list, press **OFF**.



•You can exit the edit mode any time by pressing **OFF**.

Erasing

Make sure the handset is not being used.

1 Press  or  to enter the directory list.

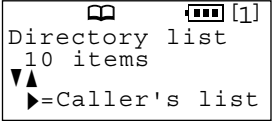

Directory list
10 items
▼▲
▶=Caller's list

2 Scroll to the directory item that you want to erase by pressing  or .

•To search for the item by initial, see page 42.

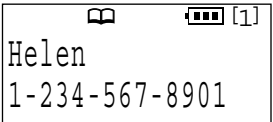

Helen
1-234-567-8901

3 Press **HOLD/CLEAR**.

•To stop erasing, press .

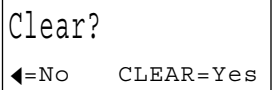

Clear?
◀=No CLEAR=Yes

4 Press **HOLD/CLEAR**.

- A beep sounds and the item is erased.
- To erase other items, repeat from step 2.
- To exit the directory list, press **OFF**.

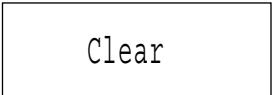

Clear

•You can exit the programming mode any time by pressing **OFF**.



Sending the Directory (When the System Has Additional Handsets)

This feature can be used only when one or more additional handsets have been registered to the base unit (p. 23). You can send a directory item or all the items from your handset to another handset. Entries copied to the destination handset are added to its directory. **(Phone Directory Sharing)**

- If an external call is being received during the directory transfer, the transfer will be stopped. You will need to re-send the item(s).
- After the transfer started, do not place your handset on the base unit or charger until the transfer completes. Otherwise, the transfer will be stopped.

Make sure the base unit, your handset and the destination handset are not being used.

To send one directory item to another handset

- 1 Press **CONF/FUNCTION**.
- 2 Scroll to “Copy directory” by pressing **▼** or **▲**, and press **▶**.
- 3 Press **▶** at “Copy 1 item”.
- 4 Select the destination extension number by pressing **▼** or **▲**.
 - You can also select the extension number by pressing the dialing button (**1** to **8**).
- 5 Press **▶**.
- 6 Scroll to the directory item you want to send by pressing **▼** or **▲**.
 - To search for the item by initial, see page 42.
- 7 Press the right soft key (**SEND**).
 - When the item has been transferred, “Complete” displays and a beep sounds.
 - The destination unit display will show “Directory Receiving” then “Directory Received”.
 - You can continue sending another item. To exit the directory sending mode, press **OFF**.

Ringer setting
▶ Copy directory
Initial setting

▶ Copy 1 item
Copy all items

Enter extension#
:2
▼▲ ▶=Next

Select item
▼▲

Tom Jones
098-765-4321
▼▲
LINE1 LINE2 SEND

Complete

➡ Directory

- If “---Incomplete---” and “Directory full” are displayed with the item in step 7 on page 45, the destination unit directory memory is full. To exit the directory sending mode, press **OFF**. To re-send the item, erase an unnecessary item from the destination unit (p. 44), and make sure the destination unit is not in use and try again.
- You can exit the directory sending mode by pressing **OFF**.

To send all of the items in your directory to another handset

1 Press **CONF/FUNCTION**.

2 Scroll to “Copy directory” by pressing **▼** or **▲**, and press **▶**.

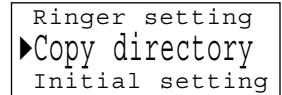

3 Scroll to “Copy all items” by pressing **▼** or **▲**, and press **▶**.

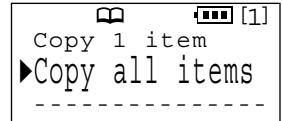

4 Select the destination extension number by pressing **▼** or **▲**.

- You can also select the extension number by pressing the dialing button (**1** to **8**).

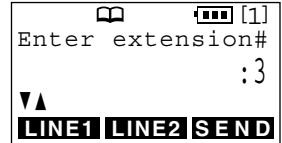

5 Press the right soft key (**SEND**).

- The display will show items one by one and each item's number.
- When all items have been transferred, “Complete” displays and a beep sounds.
- The destination unit display will show “Directory Receiving” then “Directory Received”.
- The display will return to step 3. You can continue sending items to another extension. To exit the directory sending mode, press **OFF**.

Ex. Sending 1st item out of 10 items

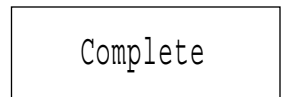

- If “---Incomplete---” and “Directory full” are displayed with an item, the destination unit directory memory is full. That item and items after it have not been transferred to the destination unit. To exit the directory sending mode, press **OFF**. To erase other stored items from the destination unit directory, see page 44. You can re-send all of the items or re-send the items which have not been transferred one by one (p. 45).
- You can exit the directory sending mode by pressing **OFF**.

Using the Other Line During a Conversation

During a conversation, if you hear **two tones**, and the line indicator on the base unit and the line status icon on the handset display will flash quickly, an incoming call is being received on the other line. You can answer the second call while holding the first call. You can also make a call without terminating the first call.

If you subscribe to a Caller ID service, the second caller's information will be displayed when a call is being received on the other line (p. 32).

You can delete the **two tones** (incoming call tone). See page 67.

Handset

- Ex. If you are using LINE 1**
Press **(HOLD/CLEAR)** twice to put the first call (LINE 1) on hold.
 - “**L1**” and “**LINE1**” flash on the display.

Ex. When you are receiving a second call.

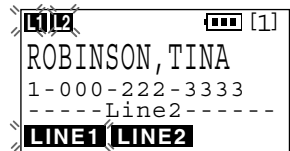

- Press the middle soft key (**LINE2**) to make or answer a second call.
 - “**L2**” is displayed.

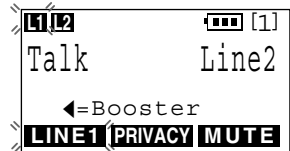

- To return to the first call (LINE 1), press the left soft key (**LINE1**) for the first call (LINE 1).
 - The second call is terminated.

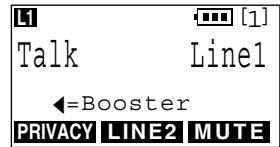

Base unit

- Ex. If you are using LINE 1**
Press **(HOLD)** to put the first call (LINE 1) on hold.
 - The LINE 1 indicator flashes.
- Press the other line button (LINE 2) to make or answer a second call.
 - The LINE 2 indicator lights.
- To return to the first call (LINE 1), press the line button for the first call (LINE 1).
 - The second call is terminated.

To hold the second call in step 3, press **(HOLD/CLEAR)** twice on the handset or **(HOLD)** once on the base unit before pressing the soft key on the handset or line button for the first call.

Intercom

A 2-way intercom is possible between the handset and the base unit. When the system has one or more additional handsets (p. 23), a 2-way intercom is also possible between two handsets. You can call all handsets from the base unit at once.

The handset included with the base unit has the extension number 1 which has "[1]" on the display, and the base unit has the extension number 0. Each additional handset is assigned the number at registration (p. 23).

Making Intercom Calls

Handset

1 Press **(HOLD)** (**INTERCOM**).

Press extension#
to call

LINE1 LINE2 MONITOR

2 To page the base unit, press **(0)**.

- The base unit will ring for 1 minute.
- To stop paging, press **(OFF)**.

Calling [0]

3 When the paged party answers, talk into the handset.

- You can switch to the speaker by pressing **(🔊)**. To switch back to the receiver, press **(📞)**.

Intercom
01

LINE1 LINE2 MUTE

Intercom
00-00-05
01

4 To end the intercom, press **(OFF)**.

Off
00-00-50

To page another handset (when the system has additional handsets, p. 23):

Press **(HOLD)** (**INTERCOM**), and enter the extension number using the dialing button (**(1)** to **(8)**).

- The destination handset will ring for 1 minute.

To end the intercom, press **(OFF)** or place the handset on the base unit or the charger.

Ex. Handset 2 calling

Calling [2]

Intercom
12

LINE1 LINE2 MUTE



Base unit

Using this feature, you can also locate a misplaced handset.

- 1 Press **LOCATOR/INTERCOM/TRANSFER**.
 - The LOCATOR/INTERCOM/TRANSFER indicator and the DIGITAL SP-PHONE indicator light.
- 2 To page the handset, enter the extension number, using the dialing button (**1** to **8**).
 - The handset will ring for 1 minute.
 - To stop paging, press **DIGITAL SP-PHONE** or **LOCATOR/INTERCOM/TRANSFER**.
- 3 When the paged party answers, talk into the **MIC**.
- 4 To end the intercom, press **DIGITAL SP-PHONE** or **LOCATOR/INTERCOM/TRANSFER**.
 - The LOCATOR/INTERCOM/TRANSFER indicator and DIGITAL SP-PHONE indicator lights go out.

To page all handsets (when the system has additional handsets, p. 23):

Press **LOCATOR/INTERCOM/TRANSFER**, and enter **0**.

- All handsets will ring for 1 minute.
- You can only talk with the handset user who answers first.

During an intercom call:

- If you have difficulty hearing the other party, decrease the speaker volume by pressing **▼**.
- If an incoming call is being received, you will hear two tones (incoming call tone, p. 67) and the LINE indicator on the base unit will flash quickly. To answer, if you are using the handset, press the relevant soft key (**LINE1** or **LINE2**). If you are using the base unit, press the called line button.
- If the unit detects a problem, an error message will be displayed (p. 75).

Answering Intercom Calls

Handset

When an intercom call is being received, the handset rings and the display shows the calling extension.

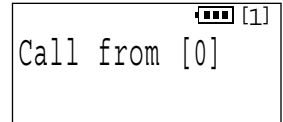



Press ,  or **HOLD (INTERCOM)**.

- You can also answer the call by pressing any dialing button **0** to **9**, ***** or **#** (**Any Key Talk**).



To end the intercom, press **OFF** or place the handset on the base unit or the charger.

Auto Talk:

If you set the Auto Talk feature to ON (p. 20), you can answer a call by lifting the handset off the base unit without pressing ,  or **HOLD (INTERCOM)**. If you purchase an additional handset (p. 23), you can answer a call by lifting it off the charger.

Base unit

When an intercom call is being received, the base unit rings and the LOCATOR/INTERCOM/TRANSFER indicator light flashes.

Press **LOCATOR/INTERCOM/TRANSFER** or **DIGITAL SP-PHONE**.

- The LOCATOR/INTERCOM/TRANSFER indicator and the DIGITAL SP-PHONE indicator light.

To end the intercom, press **DIGITAL SP-PHONE** or **LOCATOR/INTERCOM/TRANSFER**.

- The LOCATOR/INTERCOM/TRANSFER indicator and DIGITAL SP-PHONE indicator lights go out.
- The ringer volume for internal calls follows the higher level of the two lines. When the ringer volume is off for both lines (p. 21, 22), the handset and base unit will ring at the LOW level for internal calls.
- You cannot change the ringer tone for internal calls.

Transferring a Call



You can transfer an external call between the base unit and the handset. When the system has one or more additional handsets (p. 23), you can transfer an external call between two handsets.

To transfer a call from the handset

1 During a call, press **(HOLD)** (**TRANSFER**).
•The line status icon and “**LINE1**” or “**LINE2**” flash on the display and the call is put on hold.

Ex. Line 1 on hold

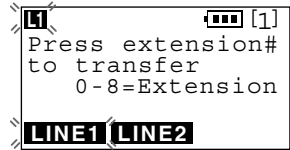

2 To page the base unit, press **(0)**. To page another handset (when the system has additional handsets, p. 23): Enter the extension number using the dialing button (**(1)** to **(8)**).

Ex. Calling Base

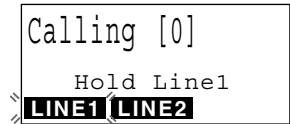

3 If required, wait for the paged party to answer, and you can announce the transfer. If not required, go to step 4.
•If the paged party does not answer, press the relevant soft key (**LINE1** or **LINE2**) to return to the outside call.

Ex. Intercom with Base

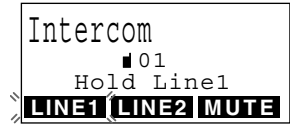

4 To complete the transfer, press **(OFF)**.

To answer from the base unit a transferred call:

–If the paging party announces the transfer, press **(DIGITAL SP-PHONE)** or **(LOCATOR/INTERCOM/TRANSFER)** to answer the page.

•After the paging party hangs up the call or you press the relevant line button, you can talk to the outside caller.

–If the paging party hangs up before you answer the page, press **(DIGITAL SP-PHONE)** or the relevant line button to take the transferred call.

To answer from another handset a transferred call:

–If the paging party announces the transfer, the calling extension is displayed. Press **(CALL)**, **(CALL)** or **(HOLD)** (**INTERCOM**) to answer the page.

•After the paging party hangs up the call or you press the relevant soft key (**LINE1** or **LINE2**), you can talk to the outside caller.

–If the paging party hangs up before you answer the page, “Incoming call” is displayed. Press **(CALL)**, **(CALL)** or the relevant soft key (**LINE1** or **LINE2**) to take the transferred call.

➔ Transferring a Call



To transfer a call from the base unit

- 1 During a call, press **LOCATOR/INTERCOM/TRANSFER**.
 - The call is put on hold and the LINE indicator flashes.
- 2 To page the handset, enter the extension number using the dialing button (**1** to **8**).
To page all handsets (when the system has additional handsets, p. 23), press **0**.
- 3 If required, wait for the handset user to answer, and you can announce the transfer. If not required, go to step 4.
 - If the paged party does not answer, press the relevant line button to return to the outside call.
- 4 To complete the transfer, press **DIGITAL SP-PHONE**.

•Even if you call all handsets, only the handset user who answers first can take the transferred call.



To answer from the handset a transferred call:

Ex. Base calling

–If the paging party announces the transfer, the calling extension is displayed. Press ,  or **HOLD (INTERCOM)** to answer the page.

Call from [0]

•After the paging party hangs up the call or you press the relevant soft key (**LINE1** or **LINE2**), you can talk to the outside caller.

–If the paging party hangs up before you answer the page, “Incoming call” is displayed. Press ,  or the relevant soft key (**LINE1** or **LINE2**) to take the transferred call.

- Any users can take a transferred call by pressing the relevant soft key (**LINE1** or **LINE2**) on the handset or the relevant line button on the base unit.
- If you do not announce the transfer and if the paged party does not answer within 60 seconds after you hang up, the transferred call will be returned to you with ringing. If you still do not answer the caller’s call within 4 minutes, the call will be disconnected. You may answer the caller by pressing the relevant soft key (**LINE1** or **LINE2**) on the handset or the relevant line button on the base unit before or during the ringing.



Conference with two external calls

While having a conversation on one line, you can make or answer a second call on the other line and then combine the calls to make a conference call.

Handset:

- 1 During a call, press **HOLD/CLEAR** twice to put the first call on hold.
- 2 To make or answer a second call, select the other line by pressing the relevant soft key (**LINE1** or **LINE2**).
- 3 When the second call is connected, press **CONF/FUNCTION** to make a conference call.

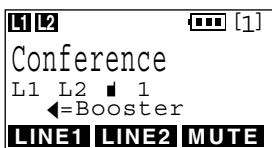

- To hang up both lines, press **OFF**.
 - To hang up only one line, press the relevant soft key (**LINE1** or **LINE2**) for the party with which you want to continue talking.
 - To put both lines on hold, press **HOLD/CLEAR**.
To talk with only one caller, press the relevant soft key (**LINE1** or **LINE2**).
To resume both lines, press **CONF/FUNCTION**.
- You cannot call another extension to make a conference call. To join the conference call from other extensions, press the relevant soft key (**LINE1** or **LINE2**) on the handset or either line button on the base unit. Up to two more extensions can join the conference call if all other extensions are not being used.

Base unit:

- 1 During a call, press **HOLD** to put the first call on hold.
- 2 Press the other line button to make or answer a second call.
- 3 When the second call is connected, press **CONF** to make a conference call.

- To hang up both lines, press **DIGITAL SP-PHONE**.
- To hang up only one line, press the line button for the party with which you want to continue talking.
- To put both lines on hold, press **HOLD**. To talk with only one caller, press the relevant line button. To resume both lines, press **CONF**.

➡ Conference

Conference with an external call and intercom call

While you are talking with an outside caller, you can call the base unit or the handset to make a conference call. When the system has one or more additional handsets (p. 23), you can make a conference call with your handset and another handset.

Handset:

- 1 During a call, press **(HOLD)** (**TRANSFER**).
 - The call is put on hold.
- 2 To page the base unit, press **(0)**.
OR
To page another handset (when the system has additional handsets, p. 23), enter the extension number using the dialing button (**(1)** to **(8)**).
- 3 When the paged party answers, press **(CONF/FUNCTION)** on your handset to make a conference call.

Ex. Conference with Base on Line1

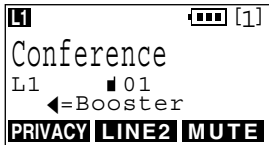

- To leave the conference, press **(OFF)**. The two other parties can continue the conversation.
- During a conference, the outside call can be placed on hold by pressing **(HOLD)** (**TRANSFER**) on the handset or **(HOLD)** on the base unit. Internal communications between extensions are not suspended. Only the person who placed the call on hold can resume the full conference; press **(CONF/FUNCTION)** on the handset or **(CONF)** on the base unit.
- One more extension can join the conference call if all other extensions are not being used. To join the conference call, press the relevant soft key (**(LINE1)** or **(LINE2)**) on the handset or the relevant line button on the base unit.

Base unit

- 1 During a call, press **(LOCATOR/INTERCOM/TRANSFER)**.
 - The call is put on hold.
- 2 To page the handset, enter the extension number using the dialing button (**(1)** to **(8)**).
- 3 When the paged party answers, press **(CONF)** on the base unit to make a conference call.
 - To leave the conference, press **(DIGITAL SP-PHONE)**. The two other parties can continue the conversation.

Call Share

This feature allows the handset or the base unit to join the existing external call.

When the system has one or more additional handsets (p. 23), a handset user can join another handset user's conversation.

To join a conversation (Call Share)

Handset:

Press the relevant soft key (**LINE1** or **LINE2**).

Ex. Using Line 1 on Handset

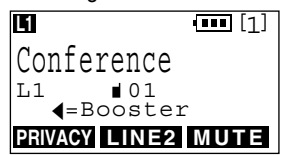

Base unit:

Press the relevant line button.

- A maximum of three units can join a conversation with the outside party(ies) if all other extensions are not being used.

Ex 1. While the handset is engaged in an external call, up to two users can join the conversation.

Ex 2. While the base unit is engaged in two external calls, up to two handsets can join the conversation.

To prevent other users from joining your conversation (Call Privacy feature)

You can turn the feature on during a call.

If you allow other users to join your conversation, leave the feature off.

Handset:

Press the soft key (**PRIVACY**) during a conversation.

- “**PRIVACY**” will be displayed.
- To turn the feature off, press the soft key (**PRIVACY**) again. “**PRIVACY**” will disappear.

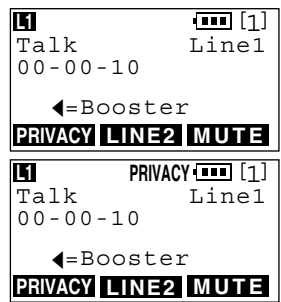

Base unit:

Press **PRIVACY** during a conversation.

- The **PRIVACY** indicator lights.
- To turn the feature off, press **PRIVACY**. The **PRIVACY** indicator light goes out.
- When the Call Privacy feature is turned on, other users cannot join the conversation. The feature will return to off after you hang up the call.

Room Monitor Feature

This feature allows you to monitor a room through the handset or the base unit by using the intercom feature. For example you can monitor a baby from different areas of the house. You can call the handset or the base unit using the extension number, to monitor the room. The called unit will not ring. When the system has one or more additional handsets (p. 23), a handset user can monitor through another handset. If you allow other users to monitor through your handset or base unit, turn the feature on. If you want to prevent your unit from being monitored by other extensions, leave this feature off (factory preset).

The destination unit must not be used and the destination handset must be off the base unit (p. 57).

To turn the handset Room Monitor feature on (to allow other users to monitor through your handset)

Make sure the handset is not being used.

- 1 Press **CONF/FUNCTION**, and scroll to "Initial setting" by pressing **▼** or **▲**, and press **▶**.
- 2 Scroll to "Room monitor" by pressing **▼** or **▲**, and press **▶**.
- 3 Select "On" by pressing **▼** or **▲**, and press the right soft key (**SAVE**).
 - A beep sounds.
 - To exit the programming mode, press **OFF**.

Copy directory
▶Initial setting
2Way radio mode

Auto talk
▶Room monitor
Caller ID edit

Room monitor	:On
▼▲	
LINE1	LINE2 SAVE

- To prevent your handset from being monitored, select "Off" in step 3 and press the right soft key (**SAVE**).

To turn the base unit Room Monitor feature on (to allow the handset to monitor through the base unit)

Use the handset. Make sure the base unit and the handset are not being used.

- 1 Press **CONF/FUNCTION**, and scroll to "Initial setting" by pressing **▼** or **▲**, and press **▶**.
- 2 Scroll to "Set base unit" by pressing **▼** or **▲**, and press **▶**.
- 3 Scroll to "Room monitor" by pressing **▼** or **▲**, and press **▶**.
- 4 Scroll to "On" by pressing **▼** or **▲**, and press the right soft key (**SAVE**).
 - A beep sounds.
 - To exit the programming mode, press **OFF**.

Voice mail
▶Set base unit
Registration

Incoming call
▶Room monitor
Line selection

Room monitor	:On
▼▲	
LINE1	LINE2 SAVE

- To prevent your base unit from being monitored, select "Off" in step 4 and press (**SAVE**).

To monitor with the handset

1 Press **HOLD** (**INTERCOM**).

[1]

Press extension#
to call



LINE1 **LINE2** **MONITOR**

2 Press the right soft key (**MONITOR**).

Press extension#
for room monitor

3 To call the base unit, press **0**.
To call another handset (when the system has additional handsets, p. 23):
Enter the extension number using the dialing button (**1** to **8**).

Room monitor
■ 01

- Your handset will start to monitor the room through the destination unit and “Room monitor” will display.
- To monitor from the speaker, press . You can place the handset on the charger but you cannot place it on the base unit to continue monitoring. Placing the handset on the base unit will disconnect room monitoring. To switch back to the receiver, press .
- “Room monitor” will display on the monitored handset. The DIGITAL SP-PHONE indicator lights on the monitored base unit.

4 To end monitoring, press **OFF** or place the handset on the base unit.

- The base unit user can stop being monitored by pressing **LOCATOR/INTERCOM/TRANSFER** or **DIGITAL SP-PHONE**. The monitored handset user can stop being monitored by pressing **OFF**.
- If the Room Monitor feature of the destination unit is off or the destination handset is on the base unit, “Denied” will be displayed and busy tones will sound.

To monitor with the base unit

1 Press **LOCATOR/INTERCOM/TRANSFER**, and press **MUTE**.

- The LOCATOR/INTERCOM/TRANSFER indicator light flashes.

2 To call the handset, enter the extension number using the dialing button (**1** to **8**).

- The base unit will start to monitor the room through the handset.
- The handset will display “Room monitor”.

3 To end monitoring, press **LOCATOR/INTERCOM/TRANSFER** or **DIGITAL SP-PHONE**.

- The LOCATOR/INTERCOM/TRANSFER indicator light goes out.

- The monitored handset user can stop being monitored by pressing **OFF**.
- If the Room Monitor feature of the destination handset is off or the handset is on the base unit, busy tones will sound.

2-Way Radio Communication (When the System Has Additional Handsets)

If you purchase one or more additional handsets (p. 23), you can use this feature (except for KX-TGA272S). A handset user can talk with another handset user regardless of the base unit location. 2-Way Radio communication, which is the direct communication between a pair of handsets, does not need the base unit interface.

You need to turn the mode on on the handsets.

Once the mode is on, the handset can be used only to talk with another handset, and the following features cannot be used on the handset:

- Making/answering external and internal calls
- Searching the Caller List or directory
- Programming
- Receiving Caller ID information

After finish using this mode, remember to turn the mode off. Otherwise the battery operating time will be shortened (p. 15).

To turn the 2-Way Radio mode on

Make sure the handset is not being used.

- 1 Press **CONF/FUNCTION**.
- 2 Scroll to “2Way radio mode” by pressing **▼** or **▲**.
- 3 Press **▶**.
- 4 Select “On” by pressing **▼** or **▲**.
- 5 Press the right soft key (**SAVE**).
 - A beep sounds and the mode will turn on.

```
Initial setting
▶2Way radio mode
-----
```

```
2Way radio mode
:Off
▼▲
LINE1 LINE2 SAVE
```

```
2Way radio mode
:On
▼▲
LINE1 LINE2 SAVE
```

```
2Way radio mode
```

•You can exit the programming mode any time by pressing **OFF**.



To turn the mode off:

Place the handset on the base unit or the charger.

- You can also turn the mode off by performing the three procedures: (1) press **CONF/FUNCTION**, (2) select “Off” by pressing **▼** or **▲**, and (3) press the right soft key (**SAVE**).
- “2Way radio mode” will disappear and the mode will turn off.

To call another handset

Make sure the mode is on on your handset and the destination handset and the displays show “2Way radio mode”.

1 Press ,  or **HOLD** (**INTERCOM**).

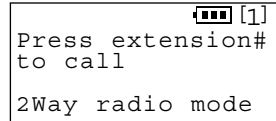

Press extension#
to call
2Way radio mode

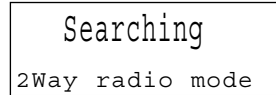

2 Enter the extension number using the dialing button (**1** to **8**).

- The called handset will ring for 1 minute.
- To stop calling, press **OFF**.



Searching
2Way radio mode

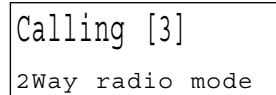

3 When the called party answers, talk into the handset.

- After a few seconds, the display will show the length of the call.
- You can switch to the receiver or the speaker by pressing  or .



Calling [3]
2Way radio mode

4 To end the conversation, press **OFF**.

- To adjust the receiver volume (HIGH, MEDIUM or LOW) or speaker volume (6 levels) while talking, press  or .



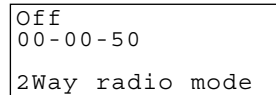

Talk
2Way radio mode
MUTE



Off
00-00-50
2Way radio mode

To adjust the ringer volume for 2-Way Radio mode (High, Medium, Low or OFF):

To increase, press  while the handset is not in use. To decrease, press .

- To turn the ringer off, press  until “Off” is displayed. “Ringer off” will be displayed and the handset will not ring in the 2-Way Radio mode.



Ex. High level (factory preset)



2Way radio mode
Low High



To answer a call

1. After the rings, press ,  or **HOLD** (**INTERCOM**).

- You can also answer a call by pressing any dialing button **0** to **9**, ***** or **#** (**Any key talk**).

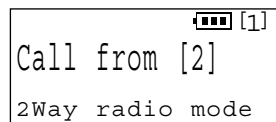

Call from [2]
2Way radio mode

2. To end the conversation, press **OFF**.

Voice Mail Service



Voice mail service is an electronic on-line answering system offered by your telephone company. After subscribing, the voice mail system can answer calls automatically for you when your line is busy or if calls are not answered, and caller can leave their messages at the voice mail box virtually located at the telephone company. After the voice mail box having received messages, the unit will indicate it in two ways: (a) "Voice mail" with the line(s) which received message(s) displayed on the handset, and (b) "MAIL" on the handset and the VM indicator on the base unit will flash.

To use this feature, you must first store your access number.

Storing a Voice Mail Access Number

Make sure the base unit and the handset are not being used.

- 1 Press **CONF/FUNCTION**, and scroll to "Initial setting" by pressing **▼** or **▲**, and press **▶**.
- 2 Scroll to "Voice mail" by pressing **▼** or **▲**, and press **▶**.
- 3 Scroll to "Save VM access#" by pressing **▼** or **▲**, and press **▶**.
- 4 Press **▼** (Line 1) or **▲** (Line 2) to select the line.
 - The line selected should be the line with subscription of Voice Mail service from your telephone company.
 - The line's current setting will be displayed.
- 5 Enter your access number, up to 32 digits.
 - You may enter pauses* (see page 61).
 - Each time you press **HOLD/CLEAR**, a digit is erased. To erase all digits, press and hold **HOLD/CLEAR**.
- 6 Press the right soft key (**SAVE**).
 - A beep sounds.
 - To exit the programming mode, press **OFF**.
 - "**MAIL**" is displayed.

```
Set tel line
▶Voice mail
Set base unit
```

```
VM tone detect
▶Save VM access#
-----
```

```
Save VM access#
▼=Line1 ▲=Line2
```

```
VM access# Line1
|
|
|
◀▶
LINE1 LINE2 SAVE
```

```
VM access# Line1
12344567PPP890|
|
|
|
◀▶
LINE1 LINE2 SAVE
```

•You can exit the programming mode any time by pressing **OFF**.

To erase a stored number

Repeat steps 1 through 5 and press and hold **HOLD/CLEAR** until all of the digits are erased. Press the right soft key (**SAVE**).



*For quick access to your voice mail box by using the right soft key (**MAIL**) on the handset or **VM** on the base unit, you may add pauses between your voice mail box access number and your mail box password in step 5.

EX. 1-222-333-4444 PPPP 8888

Your voice mail box access number | Pauses | Your mail box password

Pressing **PAUSE/REDIAL** once creates a 3.5 seconds delay and counts as one digit. The delay time depends on a telephone company.

Setting the Voice Mail (VM) Tone Detection

Your telephone company sends special signals (Voice mail tones) to activate the VM indicator. Press , or **DIGITAL SP-PHONE** to listen to the dial tone. If you hear a series of dial tones followed by a continuous dial tone, this is indication that a new message was recorded. Your phone comes set to detect these tones (set to "On"). Minutes after you hang up or after the phone stops ringing, your unit will seize the phone line and check if a message has been recorded. If a new message was recorded at your telephone company, "Voice mail" will be displayed on the handset and the base unit VM indicator will flash.

Set this programming to "Off" when:

- you do not subscribe to a voice mail service,
 - your telephone company does not send a series of tones, followed by a continuous tone, or
 - your phone is connected to a business or office telephone system (PBX).
- Please refer to below to set this programming to OFF.

If you are not sure which setting is required, consult your local telephone company or contact Panasonic Customer Call Center.

Make sure the base unit and the handset are not being used.

- 1 Press **CONF/FUNCTION**, and scroll to "Initial setting" by pressing or , and press .
- 2 Scroll to "Voice mail" by pressing or , and press .
- 3 Press at "VM tone detect".
- 4 Press (Line 1) or (Line 2) to select the line.
 - The line's current setting will be displayed.
- 5 Select "Off" or "On" by pressing or , and press the right soft key (**SAVE**).
 - A beep sounds.
 - To exit the programming mode, press **OFF**.

```

-----
▶VM tone detect
  Save VM access#
  
```

```

VM tone detect
▼=Line1 ▲=Line2
  
```

```

VM tone detect
Line1 :On
◀▶
LINE1 LINE2 SAVE
  
```

➡ Voice Mail Service

Listening to Voice Mail Messages

After the voice mail box having received messages, the unit will indicate it in two ways:
(a) "Voice mail" with the line(s) which received message(s) displayed on the handset, and
(b) "MAIL" on the handset and the VM indicator on the base unit will flash. To listen to your voice mail message(s), follow the steps below.

Ex. Line 2 received message(s)



Handset

1 Press the right soft key (**MAIL**).

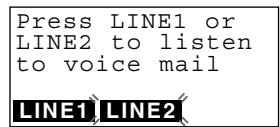

2 Select the indicated line by pressing the left soft key (**LINE1**) or the middle soft key (**LINE2**).

- The handset is connected to the telephone line and dials the access number (p. 60).

3 Follow the pre-recorded instructions, when finished, press **OFF**.

- If "Store VM access#" is displayed and 3 beeps sound, store the number (p. 60).

Base unit

1 Press **VM**.

- The indicator(s) of the line(s) which received message(s) flash(es).

2 Press the line button (**LINE1**) or (**LINE2**) whose indicator is flashing.

- The base unit is connected to the telephone line and dials the access number (p. 60).

3 Follow the pre-recorded instructions, when finished, press **DIGITAL SP-PHONE**.

- If 3 beeps sound, you have not stored the voice mail access number. Store the number (p. 60).

- If "Voice mail" with the line(s) which received message(s) still remains on the handset, "MAIL" on the handset or the VM indicator on the base unit still flashes even if you have listened to your voice mail message(s), press **CONF/FUNCTION**, and press and hold **HOLD/CLEAR** until the unit beeps. "Voice mail" with the line(s) which received message(s) will disappear, "MAIL" will stop flashing and the VM indicator will turn off.

- If your voice mail service uses a voice mail tone and the recorded message is over 3 minutes long, "Voice mail" may not be displayed, "MAIL" and the VM indicator may not flash.

- If your voice mail service uses a voice mail tone, the tone will be heard from any parallel connected phone. If you use another phone to retrieve messages, you have to dial your access number manually.



Muting Your Conversation

During a call, you can make the other party not listen to you. When muting your conversation, you can hear the other party.

For the handset; press the right soft key (**MUTE**).

- “Mute” will be displayed for a few seconds and “**MUTE**” will flash.

- To release the mute, press the right soft key (**MUTE**).

- When you switch between the receiver and speaker, the mute will be released.

For the base unit; press **MUTE**.

- The MUTE indicator will light.

- To release the mute, press **MUTE**.



For Call Waiting Service Users

If another call is received on the same line while talking, you will hear a call-waiting tone. Press **FLASH/CALL WAIT** to answer the second call.

- The first call on the same line is put on hold.

- To return to the first caller, press **FLASH/CALL WAIT** again.

- The call waiting service cannot be used when:

 - the first call on the same line is placed on hold,

 - you are having a conference call on both lines (p. 53), or

 - a parallel connected telephone is in use.

- If this function does not operate properly, consult your telephone company for details.

Call Waiting Caller ID Feature

Call Waiting Caller ID Feature allows your handset to display the second caller's information. After you hear a call-waiting tone while talking, the handset will display the caller's name, the phone number, the called line and “-Waiting-”.

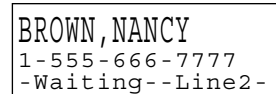

- Please contact your telephone company for details and availability in your area.

How to Use the PAUSE Button (For PBX Line/Long Distance Calls)

We recommend you press **PAUSE/REDIAL** on the handset or **REDIAL/PAUSE** on the base unit if a pause is required for dialing with a PBX or to make a long distance call.

Ex. Line access number **9** (PBX)

9 → **PAUSE/REDIAL** or **REDIAL/PAUSE** → Phone number

- Pressing **PAUSE/REDIAL** or **REDIAL/PAUSE** once creates a 3.5 second pause. This prevents misdialing when you redial or dial a stored number.

- Pressing **PAUSE/REDIAL** or **REDIAL/PAUSE** more than once increases the length of the pause between numbers.

➡ Special Features

Temporary Tone Dialing (For Rotary or Pulse Service Users)

Press **[TONE]** before entering access numbers which require tone dialing.

- The dialing mode changes to tone. You can enter numbers to access an answering service, electronic banking service, etc. When you hang up, the mode will return to pulse.

FLASH Button

Pressing **[FLASH/CALL WAIT]** also allows you to use special features of your host PBX such as transferring an extension call or accessing special telephone services (optional) such as call waiting.

- Pressing **[FLASH/CALL WAIT]** causes to disable the Temporary Tone Dialing mode or the mute (p. 63).

Selecting the flash time

The flash time depends on your telephone exchange or host PBX. You can select the following flash times: “700, 600, 400, 300, 250, 110, 100 or 90 ms (milliseconds)”. Your phone comes from the factory set to “700 ms”. **Make sure the handset is not being used.**

- 1 Press **[CONF/FUNCTION]**.
- 2 Scroll to “Initial setting” by pressing **[▼]** or **[▲]**, and press **[▶]**.
- 3 Scroll to “Set tel line” by pressing **[▼]** or **[▲]**, and press **[▶]**.
- 4 Scroll to “Set flash time” by pressing **[▼]** or **[▲]**, and press **[▶]**.
- 5 Press **[▼]** (Line 1) or **[▲]** (Line 2) to select the line.
 - The line’s current setting will be displayed.
- 6 Select the desired time by pressing **[▼]** or **[▲]**.
- 7 Press the right soft key (**SAVE**).
 - A beep sounds.
 - To program the other line, start again from step 4.
 - To exit the programming mode, press **[OFF]**.

```
Copy directory
▶Initial setting
2Way radio mode
```

```
Caller ID edit
▶Set tel line
Voice mail
```

```
Set dial mode
▶Set flash time
Set line mode
```

```
Set flash time
▼=Line1 ▲=Line2
```

```
Set flash time
Line1 :700ms
▼▲
LINE1 LINE2 SAVE
```

- If the unit is connected via a PBX, PBX functions (transferring a call etc.) might not work correctly. Consult your PBX supplier for the correct setting.



Ringer Tone

You can select one of 6 ringer tones for each line from your handset or from your base unit individually. When a call is being received on the line, the handset and base unit ring in the selected tone.

LINE 1 is preset to "1". LINE 2 is preset to "2".

Handset

Make sure the handset is not being used.

1 Press **CONF/FUNCTION**, and scroll to "Ringer setting" by pressing **▼** or **▲**, and press **▶**.

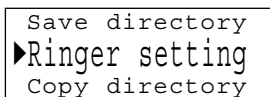

2 Scroll to "Ringer tone" by pressing **▼** or **▲**, and press **▶**.

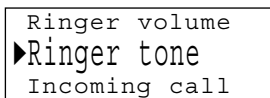

3 Press **▼** (Line 1) or **▲** (Line 2) to select the line.

- The line's current setting will be displayed.

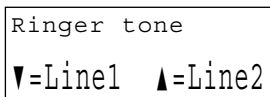

4 Select the desired ringer tone by pressing **▼** or **▲**.

- Each time you press **▼** or **▲**, the tone will change and ring. If the ringer volume has been set to OFF for the line, the handset will not ring (p. 21).
- You can also select the ringer tone by pressing dialing buttons **1** to **6**.

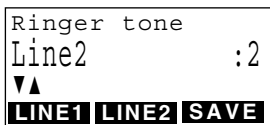

5 Press the right soft key (**SAVE**).

- A beep sounds.
- To program the other line, start again from step 2.
- To exit the programming mode, press **OFF**.

Base unit

Make sure the base unit is not being used.

1 For line 1 ringer tone, press **RINGER L1**.
For line 2 ringer tone, press **RINGER L2**.



- The base unit rings at the current setting.

2 Within 5 seconds, select the desired ringer tone by pressing **▶** or **◀**.

- Each time you press **▶** or **◀**, the ringer tone will change and ring.
- You can also select the ringer tone by pressing dialing buttons **1** to **6**.





- You cannot change the ringer tone for internal calls.

Line Selection

The handset and base unit will automatically select a free line when you make a call by pressing  or  on the handset or **DIGITAL SP-PHONE** on the base unit. The unit will also select the in-coming called line when you answer the in-coming call. You can change the line selection of the handset and base unit. There are three options as following:









Line 1: Line 1 will be selected.

Line 2: Line 2 will be selected.

Auto (factory preset): A free line will be selected (Line 1 has priority) when making a call by pressing  or  on the handset or **DIGITAL SP-PHONE** on the base unit. However, when you call back using Caller ID information (p. 34), the line that is indicated will be selected. You can also select any line by pressing one of line soft keys (**LINE1** or **LINE2**) on the handset or a line button on the base unit. When a call is being received, the called line is selected when you press  or  or **DIGITAL SP-PHONE** to answer the in-coming call.

Handset

Make sure the handset is not being used.

- 1 Press **CONF/FUNCTION**, scroll to “Initial setting” by pressing  or , and press .
- 2 Scroll to “Set tel line” by pressing  or , and press .
- 3 Press  at “Line selection”.
 - The current setting will be displayed.
- 4 Select the desired line selection, “Line1”, “Line2” or “Auto”, by pressing  or .
- 5 Press the right soft key (**SAVE**).
 - A beep sounds.
 - To exit the programming mode, press **OFF**.









```
Caller ID edit
▶Set tel line
Voice mail
```

```
-----
▶Line selection
Set dial mode
```

```
Line selection
:Auto
▼▲
LINE1 LINE2 SAVE
```

Base unit

Make sure the base unit and the handset are not being used.

- 1 Press **CONF/FUNCTION**, and scroll to “Initial setting” by pressing  or , and press .
- 2 Scroll to “Set base unit” by pressing  or , and press .
- 3 Press  at “Line selection”.
 - The current setting will be displayed.
- 4 Select the desired line selection, “Line1”, “Line2” or “Auto”, by pressing  or , and press the right soft key (**SAVE**).
 - A beep sounds.
 - To exit the programming mode, press **OFF**.

```
Voice mail
▶Set base unit
Registration
```

```
Room monitor
▶Line selection
-----
```

```
Line selection
:Auto
▼▲
LINE1 LINE2 SAVE
```

Incoming Call Tone

While using one line, you can be informed if another call arrives on the other line by two tones. During an intercom call (p. 48) or while using the Room Monitor feature (p. 56), you can also be informed by two tones if a call arrives. If you set to ON, this incoming call tone will be heard for as long as the line rings. To delete the incoming call tone, set to OFF. To set the incoming call tone to sound twice, set to "2". Both the handset and base unit are preset to "2".

Handset

Make sure the handset is not being used.

- 1 Press **CONF/FUNCTION**.
- 2 Scroll to "Ringer setting" by pressing **▼** or **▲**, and press **▶**.
- 3 Scroll to "Incoming call" by pressing **▼** or **▲**, and press **▶**.
 - The current setting will be displayed.
- 4 Select the desired setting, "On", "Off" or "2", by pressing **▼** or **▲**.
- 5 Press the right soft key (**SAVE**).
 - A beep sounds.
 - To exit the programming mode, press **OFF**.

```
Save directory
▶Ringer setting
Copy directory
```

```
Ringer tone
▶Incoming call
-----
```

```
Incoming call
tone :2
▼▲
LINE1 LINE2 SAVE
```

Base unit

Use the handset. Make sure the base unit and the handset are not being used.

- 1 Press **CONF/FUNCTION**, and scroll to "Initial setting" by pressing **▼** or **▲**, and press **▶**.
- 2 Scroll to "Set base unit" by pressing **▼** or **▲**, and press **▶**.
- 3 Press **▶** at "Incoming call".
 - The current setting will be displayed.
- 4 Select the desired setting, "On", "Off" or "2", by pressing **▼** or **▲**.
- 5 Press the right soft key (**SAVE**).
 - A beep sounds.
 - To exit the programming mode, press **OFF**.

```
Voice mail
▶Set base unit
Registration
```

```
-----
▶Incoming call
Room monitor
```

```
Incoming call
tone :2
▼▲
LINE1 LINE2 SAVE
```

Wall Mounting

This unit can be mounted on a wall phone plate.

- 1 Connect the AC adaptor.

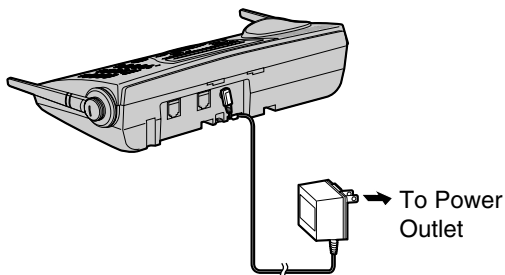

- 2 Tuck the telephone line cord inside the wall mounting adaptor (1). Connect the telephone line cord (2). Fasten the telephone line cord to prevent it from being disconnected (3).

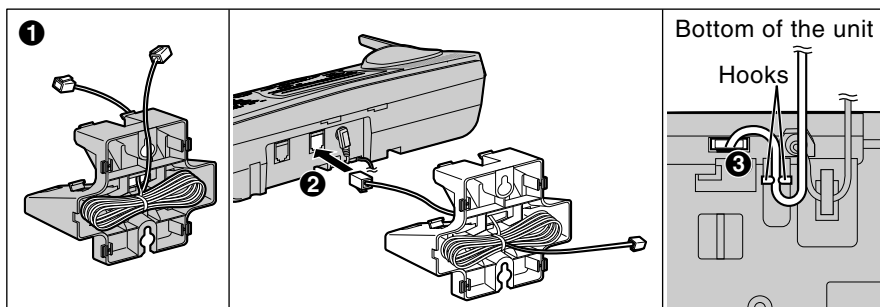

- 3 Insert (A) and (B) hooks on the wall mounting adaptor into the holes on the base unit.

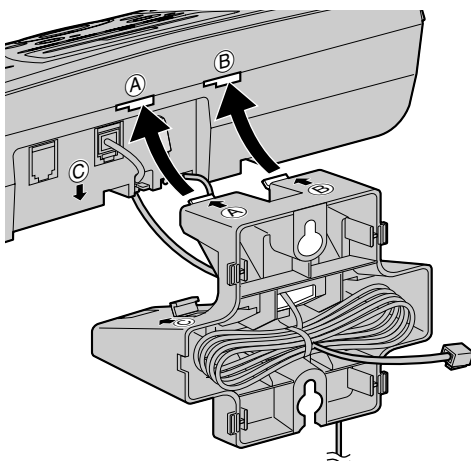



- 4 Adjust the adaptor to hold the base unit, aligning the arrow © on the base unit with the adaptor.

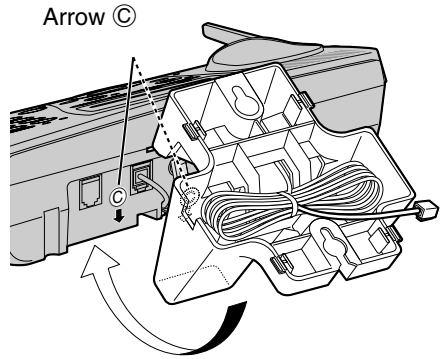
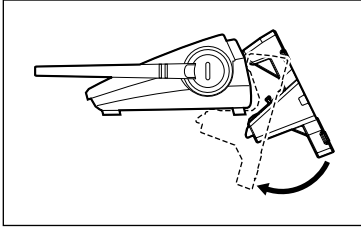

- 5 While keeping the adaptor held to the base unit, slide the wall mounting adaptor to the left until it clicks into place.

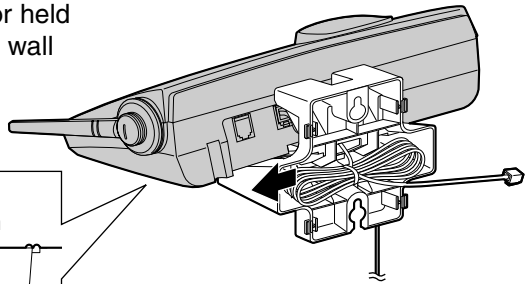
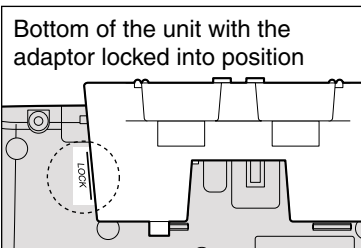

- 6 Connect the telephone line cord. Mount the unit, then slide down.

- Raise the antennas.

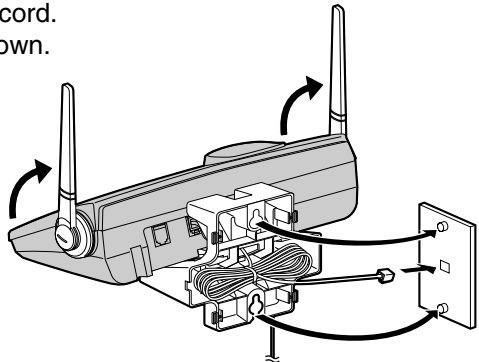

- 7 **To charge the handset battery:**
Place the handset on the base unit.
- The CHARGE indicator lights.

➔ Wall Mounting

To remove the wall mounting adaptor

Push up the **RELEASE LEVER** (❶) with your thumb and slide the adaptor to the right (❷) with the tab kept up to release the lock. Remove the adaptor.

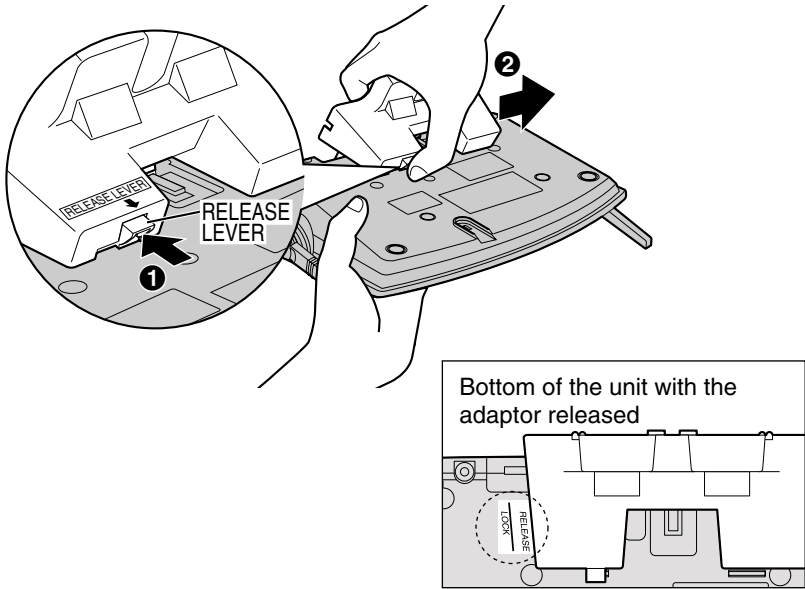

Adding Another Phone

This unit will not function during a power failure. To connect a standard telephone on the same line, use the Panasonic T-adaptor KX-J66. To order, call the accessories telephone number on page 2.

Standard Telephone

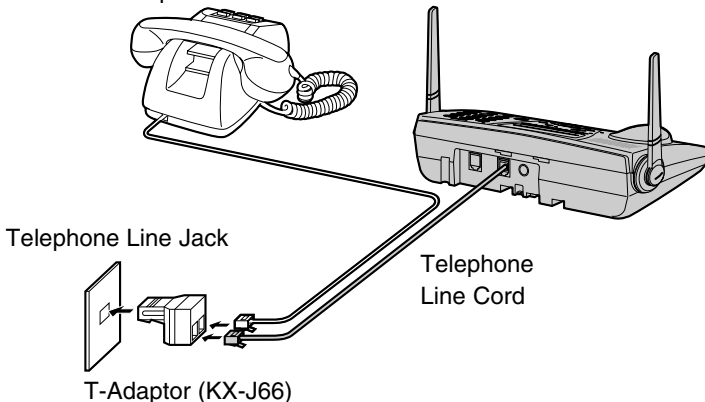

Belt Clip

You can hang the handset on your belt or pocket using the belt clip.

To attach the belt clip

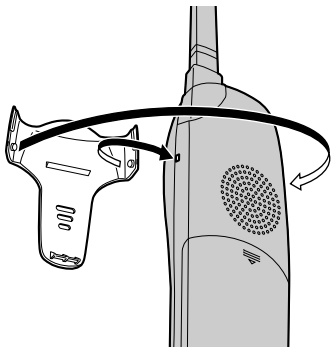

To remove the belt clip

While pressing the top of the clip (A), pull the right edge in the direction of the arrow (B).

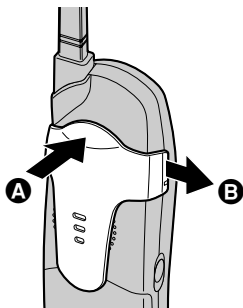

Optional Headset



Plugging the optional headset into the handset allows a hands-free phone conversation. Please use only the Panasonic KX-TCA88 headset. To order, call the accessories telephone number on page 2.

Connecting the optional headset to the handset

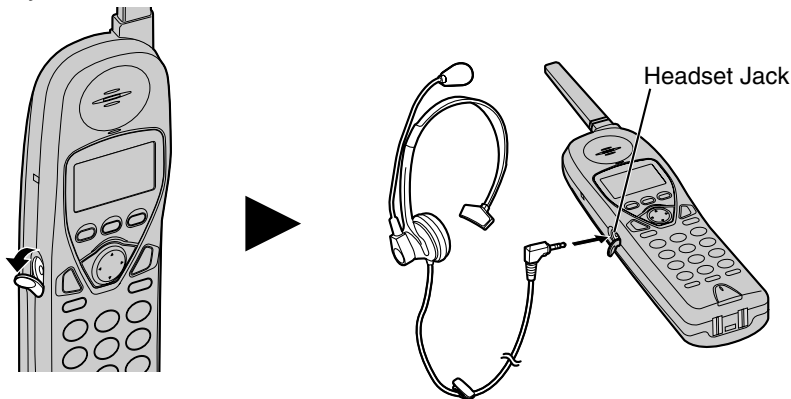
Open the headset jack cover, and connect the optional headset to the headset jack as shown below.



To switch to the speakerphone while using the headset:

Press . To return to the headset, press .

Battery Replacement

Battery will need to be replaced, even if you cleaned the charge contacts and charged the battery fully, but after a few telephone calls, "Recharge battery" is displayed and/or "■" continues to flash, or "Charge for 15HRS" and "■" are displayed. Please order a new Panasonic QPQP511SVC (P-P511) battery at the telephone number shown on page 2.

- 1 Press the notch on the handset cover firmly and slide it as indicated by the arrow.

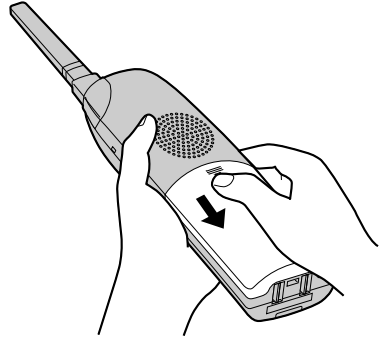

- 2 Remove the old battery. Insert the new battery into the handset as shown, matching the correct polarity (①). Press the battery down until it places into the compartment (②).

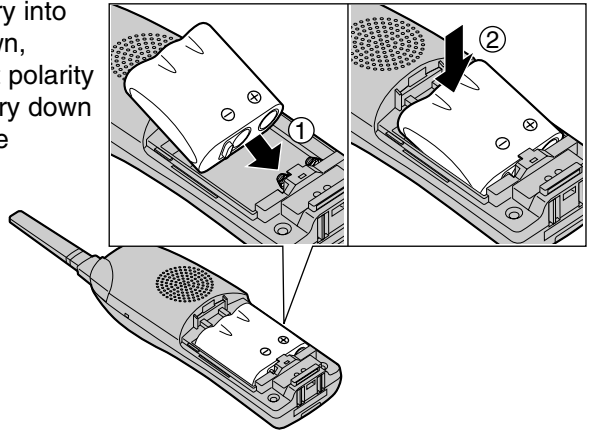

- 3 Close the cover. Make sure you charge the new battery for about 15 hours in order to display the battery strength prompt correctly (p. 14).

A nickel cadmium battery that is recyclable powers the product you have purchased. At the end of its useful life, under various state and local laws, it is illegal to dispose of this battery into your municipal waste stream. Please call 1-800-8-BATTERY for information on how to recycle this battery.



Canceling Registration/Re-registration ➔

Canceling the Handset Registration

If you no longer need to use the handset or if you need to register the handset to a different base unit of the same model, it may be necessary to cancel the registration.

Only one handset can be canceled at a time near the base unit.

Make sure the handset and the base unit are not being used.

- 1 Press **CONF/FUNCTION**.
- 2 Scroll to "Initial setting" by pressing **▼** or **▲**, and press **▶**.
- 3 Scroll to "Registration" by pressing **▼** or **▲**, and press **▶**.
- 4 Scroll to "Deregistration" by pressing **▼** or **▲**.
- 5 Press **▶**.
- 6 Press **335** (DEL.) to delete the registration memory.
 - If you make a mistake, press **HOLD/CLEAR**, and enter "335".
- 7 Press the right soft key (**OK**).
 - A beep sounds and the registration memory will be erased on both the handset and the base unit.
 - If 3 beeps sound, you entered a wrong code. The display will return to step 6. Enter "335".
 - To register the handset to another base unit of the same model, start from step 5 on page 74 or see page 23.

```
Copy directory
▶Initial setting
2Way radio mode
```

```
Set base unit
▶Registration
-----
```

```
HS registration
▶Deregistration
-----
```

```
Deregistration
Enter code:335
:---
```

```
Deregistration
Enter code:335
:335
LINE1 LINE2 OK
```

Ex. Extension number 2

```
■■■■ [-]
Handset [2]
Deregistered
```

```
■■■■ [-]
Press MUTE on
base unit, then
OK on handset to
register handset
OK
```

- "[-]" is shown on the top right of the display.
- You can exit the programming mode any time by pressing **OFF**.
- The handset will not work. To use it again, registration will be required (p. 23, 74).

➡ Canceling Registration/Re-registration

Re-registering the Handset

If you want to re-register the handset to the base unit or a different base unit of the same model, you need to register it to that base unit. The handset will be given a new extension number of that base unit. Only one handset can be registered at a time. **Make sure the base unit and the other handsets are not being used. Registration must be completed within 1 minute.**

If you have canceled the handset registration at the previous base unit (p. 73), start from step 5.

- 1 Handset:** Press **CONF/FUNCTION**.
- 2** Scroll to “Initial setting” by pressing **▼** or **▲**, and press **▶**.
- 3** Scroll to “Registration” by pressing **▼** or **▲**, and press **▶**.
- 4** Press **▶** at “HS registration”.

```
Copy directory
▶Initial setting
2Way radio mode
```

```
Set base unit
▶Registration
-----
```

```
-----
▶HS registration
Deregistration
```

- 5 Base unit:**
Press **MUTE**.
 - The MUTE indicator light flashes.

```
Press MUTE on
base unit, then
OK on handset to
register handset
LINE1 LINE2 OK
```

- 6 Handset:**
 - ① Press the right soft key (**OK**).
 - ② Wait until a long beep sounds and the display shows the registered number. The registration will be then complete.
 - The registered number “[1]” to “[8]” is shown on the top right of the display.
 - You can stop registration by pressing **OFF** on the handset and pressing **MUTE** on the base unit.

```
Handset [ ] [-]
Handset
Registering
```

Ex. Extension number 2

```
Handset [2] [2]
Registered
```

If you have not canceled the handset registration at the previous base unit (p. 73), the handset number still remains on that base unit memory. To erase the handset number from the previous base unit, see the base unit Operating Instructions. For KX-TG2720S base unit: (1) press **PROGRAM**, (2) press **MUTE**, (3) enter “335#”, and (4) enter that handset number (**1** to **8**).



If the Following Appear...



If the unit detects a problem, one of the following messages will be displayed on the handset. Error beeps or a busy tone will sound.

Display message	Cause & Remedy
Recharge battery	The battery needs to be charged. Recharge the battery (p. 15).
Charge for 15HRS	The battery has been discharged. The handset will not work. Charge the battery fully (p. 15).
No link to base. Walk closer to base and try again.	The handset has lost communication with the base unit. Walk closer to the base unit, and try again.
Busy	<ul style="list-style-type: none"> • The called handset/base unit is in use. • Both lines are in use. Wait until one of the line indicators or the line status icons goes out. • The Privacy mode is on for the call you tried to join (p. 55). • The handset you tried to send directory items to is in use. • The handset you are calling is too far from the base unit.
Invalid	The called handset has not been registered to the base unit or you selected your extension number.
Error!!	<ul style="list-style-type: none"> • When you tried to register or deregister the handset, the handset and the base unit could not link for some reason, such as interference from other electrical appliances. Take the handset and the base unit away from the electrical appliances and try again. • If more than 3 units are in use, you may not be able to register/deregister. Try again later. • Another unit tries to send the directory items to you but the transfer has been stopped (p. 45).
System is busy. Please try again later.	<ul style="list-style-type: none"> • If the radio communication between the handset and the base unit is partially impaired, this display will be shown. • If more than 3 units are in use, such as conducting external/internal calls, you may not be able to use another unit. Try again later.

➔ If the Following Appear...

Display message	Cause & Remedy
Directory Full	When trying to store an item in the directory, the directory memory is full. To erase other items from the directory, see page 44.
<pre> ---Incomplete--- Tom Jones 098-765-4321 Directory full (The name/number is an example.) </pre>	<ul style="list-style-type: none"> • When the displayed item is being sent to the destination unit, the directory memory is full. The transfer is stopped. If you tried to send all of the items, the item displayed with “---Incomplete---” and items after it have not been transferred to the destination handset. You can press OFF on the handset to exit the mode (p. 45, 46). To erase other stored items from the destination handset directory, see page 44. You can send all of the items again or send the items which have not been transferred one by one (p. 45, 46). • If the transfer is stopped for another reason, “Directory full” will not be displayed, for example: <ul style="list-style-type: none"> – the destination handset may be out of area, or – the destination unit user may press ,  or the soft key (LINE1 or LINE2) on the handset.
Directory No items stored	Although you tried to send your directory items to another extension, your directory is empty.
Denied	<ul style="list-style-type: none"> • When you call the handset or base unit to monitor, the Room Monitor mode of the destination unit is set to OFF (p. 56). • The called handset is on the base unit. The handset must be off the base unit to be monitored.
Not found 2way radio mode	When you tried to call another handset in the 2-Way Radio mode; <ul style="list-style-type: none"> – the handset is too far from your handset. Walk closer to the handset. – 2-Way Radio mode on the handset is off (p. 58). – The called handset is talking with another handset in the 2-Way Radio mode.
Store VM access#	You have not stored the voice mail access number. Store the number (p. 60).







Display message	Cause & Remedy
Invalid. Please register to the base unit	The handset you tried to make a call has not been registered to the base unit. Register it (p. 23, 74).
Error!! 8 handsets have already been registered.	<ul style="list-style-type: none"> • 8 handsets have already been registered to the base unit. To cancel another handset registration, see page 73. • This base unit has the memory of the handset currently registered to another base unit. Erase the handset memory from the base unit. For KX-TG2720S base unit: (1) Press PROGRAM, (2) Press MUTE, (3) Enter “335#” and (4) Enter that handset number (1 to 8).

Troubleshooting



Problem	Cause & Remedy
The unit does not work.	<ul style="list-style-type: none"> • Check the settings (p. 11–14). • Check whether the dialing mode setting is correct (p. 18). • Charge the battery fully (p. 14). • Clean the charge contacts and charge again (p. 15). • Install the battery properly (p. 14). • Unplug the AC adaptor to reset. Plug in, and try again. • The handset has not been registered to the base unit. Register the handset (p. 23, 74). • Re-install the battery (p. 72) and charge it fully.
“No link to base. Walk closer to base and try again.” is displayed and an alarm tone sounds.	<ul style="list-style-type: none"> • You are too far from the base unit. Walk closer to the base unit and try again. • Plug in the AC adaptor. • Raise the base unit antennas.





➔ Troubleshooting

Problem	Cause & Remedy
<p>Static, sound cuts in/out, fades. Interference from other electrical units.</p>	<ul style="list-style-type: none"> •Locate the handset and the base unit away from other electrical appliances (p. 3). •Walk closer to the base unit. •Raise the base unit antennas. •Press  on the handset to turn on the Reception Booster feature (p. 26).
<p>The handset and/or the base unit does not ring.</p>	<ul style="list-style-type: none"> •The ringer volume is OFF. Set to HIGH or MEDIUM or LOW (p. 21, 59). •If more than 3 other users are using the handsets and base unit, the handset/base unit may not ring. Those users will hear incoming call tones (p. 67) and the IN USE indicator flashes quickly on the base unit.
<p>The handset display is blank.</p>	<ul style="list-style-type: none"> •Charge the battery fully (p. 14).
<p>You cannot program items, such as the dialing mode.</p>	<ul style="list-style-type: none"> •Programming is not possible while the unit is being used. •Do not pause for over 60 seconds while programming. •Walk closer to the base unit. •, ,  or  may have been pressed when you picked up the handset. Press OFF and try again. •If more than 3 other users are using the handsets, you may not be able to program. Try again later. •If the 2-Way Radio mode is on, turn it off (p. 58).
<p>You cannot store a name and phone number in the directory.</p>	<ul style="list-style-type: none"> •You cannot store an item with the handset while the handset is in the talk, speakerphone, intercom or Room Monitor mode or 2-Way Radio mode. •Do not pause for over 60 seconds while storing.
<p>While programming or searching, the handset starts to ring and stops the program/search.</p>	<ul style="list-style-type: none"> •To answer the call, press  or  or the relevant soft key (LINE1 or LINE2) on the handset or DIGITAL SP-PHONE or the called line button on the base unit. Start again from the beginning after hanging up.



Problem	Cause & Remedy
The unit does not display the caller's name and/or phone number.	<ul style="list-style-type: none">• You need to subscribe to a Caller ID service.• Other telephone equipment may be interfering with your phone. Disconnect it and try again.• Other electrical appliances connected to the same outlet may be interfering with the Caller ID information.• Telephone line noise may be affecting the Caller ID information.• The caller requested not to send his/her information. See page 32.• If a call is being transferred to you, the caller information will not be displayed.
The handset display exits the Caller List.	<ul style="list-style-type: none">• Do not pause for over 60 seconds while searching.
You cannot page the handset or base unit.	<ul style="list-style-type: none">• The called handset is too far from the base unit.• The called unit is in use. Try again later.• If more than 3 other users are using the handsets and base unit, you may not be able to page. Try again later.
You cannot redial by pressing PAUSE/REDIAL on the handset or REDIAL/PAUSE on the base unit.	<ul style="list-style-type: none">• If the last number dialed was more than 32 digits long, the number will not be redialed correctly.• The button has a double function as either redial or pause. It will redial the last number dialed if pressed at the outset of a call (p. 26, 29). If another number has been dialed first, it will operate as a pause button (p. 63).
"Recharge battery" is displayed, "■" flashes or the handset beeps intermittently.	<ul style="list-style-type: none">• Charge the battery fully (p. 14).
"Charge for 15HRS" and "■" are displayed and the handset does not work.	<ul style="list-style-type: none">• The battery has been discharged. Charge the battery fully (p. 14).
You cannot answer a call by lifting the handset off the base unit or charger, or pressing the dialing button (0 to 9, # or *).	<ul style="list-style-type: none">• When you set the line selection to "Line 1" or "Line 2" and the call is being transferred to you, press the relevant soft key (LINE1 or LINE2) to answer the call.

➡ Troubleshooting

Problem	Cause & Remedy
<p>You charged the battery fully, but “Recharge battery” is still displayed and/or “” continues to flash, or “Charge for 15HRS” and “” are displayed.</p>	<ul style="list-style-type: none"> •Clean the charge contacts and charge again (p. 15). •Install a new battery (p. 72).
<p>The CHARGE indicator light does not go out after the battery has been charged.</p>	<ul style="list-style-type: none"> •This is normal.
<p>You cannot make a call even if the line is free.</p>	<ul style="list-style-type: none"> •If more than 3 other users are using the handsets and base unit, you may not be able to make a call. Try again later.
<p>You cannot have a conversation using the headset.</p>	<ul style="list-style-type: none"> •Make sure that an optional headset is connected properly (p. 71). • may have been pressed. If “SP-phone” or “SP” is displayed on the handset, press  to switch to the headset.
<p>You cannot register the handset at the base unit.</p>	<ul style="list-style-type: none"> •Charge the battery fully (p. 14). •The maximum of 8 handsets have already been registered to the base unit. •This base unit has the memory of the handset currently registered to another base unit. Erase the handset memory from the base unit. For KX-TG2720S base unit: (1) Press PROGRAM, (2) Press MUTE, (3) Enter “335#” and (4) Enter that handset number (1 to 8).
<p>The line status icons do not display properly and/or the line indicators do not light properly.</p>	<ul style="list-style-type: none"> •Check the settings (p. 11–14). •The line mode selection is incorrect. See page 19.

Problem	Cause & Remedy
You cannot make an internal/external call with the handset.	<ul style="list-style-type: none"> •If the 2-Way Radio mode is on, turn it off (p. 58).
If you cannot solve your problem	<ul style="list-style-type: none"> •Call our customer call center at 1-800-211-PANA(7262). •Panasonic's e-mail address for customer inquiries: consumerproducts@panasonic.com for customers in the USA or Puerto Rico ONLY

Important Safety Instructions

When using this unit, basic safety precautions should always be followed to reduce the risk of fire, electric shock, or personal injury.

1. Read and understand all instructions.
2. Follow all warnings and instructions marked on this unit.
3. Unplug this unit from AC outlets before cleaning. Do not use liquid or aerosol cleaners. Use a damp cloth for cleaning.
4. Do not use this unit near water, for example, near a bathtub, washbowl, kitchen sink, or the like.
5. Place this unit securely on a stable surface. Serious damage and/or injury may result if the unit falls.
6. Do not cover slots and openings on the unit. They are provided for ventilation and protection against overheating. Never place the unit near radiators, or in a place where proper ventilation is not provided.
7. Use only the power source marked on the unit. If you are not sure of the type of power supplied to your home, consult your dealer or local power company.
8. Do not place objects on the power cord. Install the unit where no one can step or trip on the cord.
9. Do not overload wall outlets and extension cords. This can result in the risk of fire or electric shock.
10. Never push any objects through slots in this unit. This may result in the risk of fire or electric shock. Never spill any liquid on the unit.
11. To reduce the risk of electric shock, do not disassemble this unit. Take the unit to an authorized servicer when service is required. Opening or removing covers may expose you to dangerous voltages or other risks. Incorrect reassembly can cause electric shock when the unit is subsequently used.

For assistance, please call: 1-800-211-PANA(7262)

Important Safety Instructions

12. Unplug this unit from the wall outlet and refer servicing to an authorized servicenter when the following conditions occur:
 - A. When the power supply cord or plug is damaged or frayed.
 - B. If liquid has been spilled into the unit.
 - C. If the unit has been exposed to rain or water.
 - D. If the unit does not work normally by following the operating instructions. Adjust only controls covered by the operating instructions. Improper adjustment may require extensive work by an authorized servicenter.
 - E. If the unit has been dropped or physically damaged.
 - F. If the unit exhibits a distinct change in performance.
13. During thunderstorms, avoid using telephones except cordless types. There may be a remote risk of an electric shock from lightning.
14. Do not use this unit to report a gas leak, when in the vicinity of the leak.

SAVE THESE INSTRUCTIONS

CAUTION:

To reduce the risk of fire or injury to persons, read and follow these instructions.

1. Use only the battery(ies) specified.
2. Do not dispose of the battery(ies) in a fire. They may explode. Check with local waste management codes for special disposal instructions.
3. Do not open or mutilate the battery(ies). Released electrolyte is corrosive and may cause burns or injury to the eyes or skin. The electrolyte may be toxic if swallowed.
4. Exercise care in handling batteries in order not to short the battery to conductive materials such as rings, bracelets, and keys. The battery and/or conductor may overheat and cause burns.
5. Charge the battery(ies) provided with or identified for use with this product only in accordance with the instructions and limitations specified in this manual.

WARNING:

TO PREVENT FIRE OR SHOCK HAZARD, DO NOT EXPOSE THIS PRODUCT TO RAIN OR ANY TYPE OF MOISTURE.

- The AC adaptor is used as the main disconnect device, ensure that the AC outlet is located/installed near the unit and is easily accessible.

FCC and Other Information



If requested by the telephone company, inform them as follows:

Registration No.(found on the bottom of the unit)

Ringer Equivalence0.2B

The particular telephone lines to which the equipment is connected.

This unit must not be connected to a coin operated line.

If you are on a party line, check with your local telephone company.

Ringer Equivalence No. (REN):

The REN is useful in determining the quantity of devices you may connect to your telephone line and still have all of those devices ring when your telephone number is called. In most, but not all areas, the sum of the REN's of all devices connected to one line should not exceed five (5.0). To be certain of the number of devices you may connect to your line, as determined by the REN, you should contact your local telephone company to determine the maximum REN for your calling area.

In the event terminal equipment causes harm to the telephone network, the telephone company should notify the customer, if possible, that service may be stopped.

However, where prior notice is impractical, the company may temporarily cease service providing that they:

- (a) Promptly notify the customer.
- (b) Give the customer an opportunity to correct the problem with their equipment.
- (c) Inform the customer of the right to bring a complaint to the Federal Communication Commission pursuant to procedures set out in FCC Rules and Regulations Subpart E of Part 68.

The Telephone Company may make changes in its communications facilities, equipment, operations or procedures, where such action is reasonably required in the operation of its business and is not inconsistent with the rules and regulations in 47 CFR Part 68.

If such changes can be reasonably expected to render any customer terminal equipment incompatible with telephone company communications facilities, or require modification or alteration of such terminal equipment, or otherwise materially affect its use or performance, the customer shall be given adequate notice in writing, to allow the customer an opportunity to maintain uninterrupted service.

When programming emergency numbers and/or making test calls to emergency numbers:

1. Remain on the line and briefly explain to the dispatcher the reason for the call before hanging up.
2. Perform such activities in the off-peak hours, such as early morning hours or late evenings.

This device complies with Part 15 of the FCC Rules. Operation is subject to the following two conditions: (1) This device may not cause harmful interference, and (2) this device must accept any interference received, including interference that may cause undesired operation.

Privacy of communications may not be ensured when using this phone.

➡ FCC and Other Information

CAUTION:

Any changes or modifications not expressly approved by the party responsible for compliance could void the user's authority to operate this device.

Note:

This equipment has been tested and found to comply with the limits for a Class B digital device, pursuant to Part 15 of the FCC Rules. These limits are designed to provide reasonable protection against harmful interference in a residential installation. This equipment generates, uses, and can radiate radio frequency energy and, if not installed and used in accordance with the instructions, may cause harmful interference to radio communications. However, there is no guarantee that interference will not occur in a particular installation. If this equipment does cause harmful interference to radio or television reception, which can be determined by turning the equipment off and on, the user is encouraged to try to correct the interference by one or more of the following measures:

- Reorient or relocate the receiving antenna.
- Increase the separation between the equipment and receiver.
- Connect the equipment into an outlet on a circuit different from that to which the receiver is connected.
- Consult the dealer or an experienced radio/TV technician for help.

Some cordless telephones operate at frequencies that may cause interference to nearby TVs and VCRs. To minimize or prevent such interference, the base of the cordless telephone should not be placed near or on top of a TV or VCR. If interference is experienced, move the cordless telephone further away from the TV or VCR. This will often reduce, or eliminate, interference.

Operating near 2.4GHz electrical appliances may cause interference. Move away from the electrical appliances.

CAUTION:

To comply with FCC RF exposure requirements, the base unit should be installed with its antenna located at 20 cm or more from persons and handset should be carried with the specific belt-clip provided for the handset to ensure compliance. Other non-tested belt-clips or similar body-worn accessories may not comply, therefore, should be avoided

A TIA/EIA-IS-968 compliant telephone cord and modular plug is provided with this equipment. This equipment is designed to be connected to the telephone network or premises wiring using a compatible modular jack that is also TIA/EIA-IS-968 compliant.

This equipment is hearing aid compatible as defined by the FCC in 47 CFR Section 68.316.

When you hold the phone to your ear, noise might be heard in your Hearing Aid. Some Hearing Aids are not adequately shielded from external RF (radio frequency) energy. If noise occurs, use an optional headset accessory or the speakerphone option (if applicable) when using this phone. Consult with your audiologist or Hearing Aid manufacturer about the availability of Hearing Aids which provide adequate shielding to RF energy commonly emitted by digital devices.

- **Environment** — do not place the unit in a room where the temperature is less than 5°C (41°F) or greater than 40°C (104°F). Allow 10 cm (4") clearance around the unit for proper ventilation. Avoid excessive smoke, dust, mechanical vibration, shock, or direct sunlight.
- **Medical** — consult the manufacturer of any personal medical devices, such as pacemakers or hearing aids, to determine if they are adequately shielded from external RF (radio frequency) energy. (The unit operates in the frequency range of 2400MHz to 2480MHz, and the power output level can range 0.04 to 0.4 watts.) Do not use the unit in health care facilities if any regulations posted in the area instruct you not to do so. Hospitals or health care facilities may be using equipment that could be sensitive to external RF (radio frequency) energy.
- **Routine care** — wipe the unit with a soft cloth. Do not use benzine, thinner, or any abrasive powder. When you leave the unit unused for a long period of time, unplug the AC adaptor from the outlet.
- **If there is any trouble** — disconnect the unit from the telephone line and connect a known working phone. If the known working phone operates properly, have your unit repaired by a Factory Servicenter or other Authorized Servicer. If the known working phone does not operate properly, consult your telephone company.

Specifications

■ Base unit

Power Supply:	AC Adaptor (120 V AC, 60 Hz)
Power Consumption:	Standby: Approx. 3.2 W Maximum: Approx. 6 W
Frequency:	2.40 GHz— 2.48 GHz
Dimensions (H x W x D):	Approx. 71 mm x 248 mm x 140 mm (2 13/16" x 9 3/4" x 5 1/2")
Mass (Weight):	Approx. 520 g (1.15 lb.)

■ Handset

Power Supply:	Ni-Cd battery (3.6 V, 850 mAh)
Frequency:	2.40 GHz— 2.48 GHz
Dimensions (H x W x D):	Approx. 242 mm x 53 mm x 40 mm (9 17/32" x 2 3/32" x 1 9/16")
Mass (Weight):	Approx. 220 g (0.48 lb.)
Security Codes:	1,000,000

■ **Dialing Mode:** Tone (DTMF)/Pulse

■ **Operating Environment:** 5 °C – 40 °C (41 °F – 104 °F)

Specifications are subject to change without notice.

Index

A		H	
Accessories.....	2	Headset, optional.....	71
Answering Calls.....	30	Hold alarm.....	27, 29
Auto talk Feature.....	20, 30	I	
B		Incoming Call Tone.....	67
Backlit LCD.....	10	Installation, AC adaptor.....	11
Base Unit Location.....	3	Installation, Adding Another Phone.....	70
Battery Charge.....	3, 14	Installation, Battery.....	14
Battery information.....	15	Installation, Telephone Line Cord..	12, 13
Battery Replacement.....	72	Intercom call.....	48-50
Battery strength.....	14	Intercom paging.....	48-50
Belt Clip.....	71	L	
C		LCD contrast.....	22
Call on hold.....	27, 29, 47	Lighted handset keypad.....	25
Call Share.....	55	LINE Buttons.....	24, 28, 31, 47
Call Waiting Caller ID.....	63	LINE indicators.....	28, 31, 47
Call Waiting Tone.....	63	Line mode.....	19
Caller ID Number Auto Edit feature..	35, 36	Line Selection.....	66
Caller ID service.....	32, 63	Location of controls.....	6, 7, 8
Caller List, editing.....	35	M	
Caller List, erasing.....	38	Making Calls, Base Unit.....	28
Caller List, storing.....	37	Making Calls, Handset.....	24
Caller List, viewing.....	33	Microphone, Base unit.....	28, 49
Calling Back from the Caller List.....	34	Microphone, Handset.....	25, 48
Conference call.....	53, 54	MUTE.....	63
Copy directory.....	45, 46	N	
D		Noise.....	3
Deregistration.....	73	P	
Dialing Mode.....	18	PAUSE.....	63
Directory.....	40	Phone Directory Sharing.....	45, 46
Directory, dialing.....	42	Power failure.....	70
Directory, editing.....	43	Privacy Feature.....	55
Directory, erasing.....	44	Pulse service.....	64
Directory, names and symbols.....	41	R	
Directory, sending.....	45, 46	Reception Booster.....	26
Directory, storing.....	40	Redial.....	26, 29
Display.....	10	Redial list.....	27
E		Registration.....	23, 74
Error messages.....	75	Ringer Off.....	21, 59
Extension number.....	23, 48, 74	Ringer Tone.....	65
F		Ringer Volume.....	21, 59
FCC and Other Information.....	83	Room Monitor.....	56, 57
FLASH Button.....	64	Rotary service, Tone dialing.....	64
Flash time.....	64		
Function Menu, Selection.....	16		
Function Menu, Table.....	17		

S
Safety Instructions 81
Shipping product for service ... Back Cover
Soft keys9, 16
SP-phone, Base Unit 28
SP-phone, Handset..... 25

T
Transferring a Call 51, 52
Troubleshooting 77
Two-Way Radio Communication... 58, 59

V
VM (Voice Mail Service)..... 60
Volume control, Base Unit 29
Volume control, Handset..... 26, 59

W
Wall Mounting68

For product service

- Call 1-800-211-PANA(7262) for the location of an authorized servicer.
- Panasonic's e-mail address for customer inquiries:
consumerproducts@panasonic.com
for customers in the USA or Puerto Rico ONLY

When you ship the product

- Carefully pack your unit, preferably in the original carton.
- Attach a letter, detailing the symptom, to the outside of the carton.

Symptom

- Send the unit to an authorized servicer, prepaid and adequately insured.
- Do not send your unit to the Panasonic Consumer Electronics Company listed below or to executive or regional sales offices. These locations do not repair consumer products.

For your future reference

Serial No. _____

Date of purchase _____

(found on the bottom of the unit)

Name and address of dealer _____

- This cordless telephone is designed for use in the United States of America. Sale or use of this product in other countries may violate local laws.
- Ce téléphone sans fil est conçu pour être utilisé aux États-Unis d'Amérique. La vente ou l'emploi de cet appareil dans certains autres pays peut constituer une infraction à la législation locale.
- Este teléfono sin cordón fue elaborado para uso en los Estados Unidos de América. La venta o el empleo de este producto en ciertos países puede constituir violación de la legislación local.
- このコードレス電話機は、日本国外での使用を目的として設計されており、日本国内での使用は法律違反となります。従って、当社では日本国内においては原則として修理などのサービスは致しかねます。

**If you need assistance with the set-up or operation,
please call 1-800-211-PANA(7262)**

**Panasonic Consumer Electronics Company,
Division of Matsushita Electric Corporation of America**
One Panasonic Way, Secaucus, New Jersey 07094

**Panasonic Sales Company,
Division of Matsushita Electric of Puerto Rico, Inc.**
Ave. 65 de Infantería, Km. 9.5, San Gabriel Industrial Park
Carolina, Puerto Rico 00985

PQQX13350YA-BM S0402-2062