

Panasonic®

Operating Instructions

**Expandable Digital Cordless
Answering System
with 2 Handsets**

Model No. **KX-TG1032**

with 3 Handsets

Model No. **KX-TG1033**

with 4 Handsets

Model No. **KX-TG1034**

with 5 Handsets

Model No. **KX-TG1035**

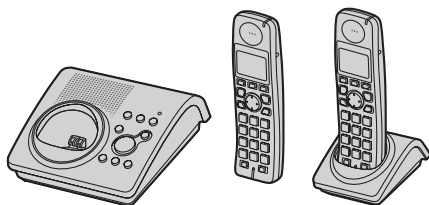

Model shown is KX-TG1032.

DECT

6.0

This unit is compatible with Caller ID. To use this feature, you must subscribe to the appropriate service offered by your telephone service provider.

Charge the handset batteries for 7 hours before initial use.

Please read these Operating Instructions before using the unit and save for future reference.

For assistance, visit our website:

<http://www.panasonic.com/help> for customers in the U.S.A. or Puerto Rico.

Table of Contents

Introduction

Product information	3
Accessory information	4
Important safety instructions	6
For best performance	8

Preparation

Setting up the base unit	9
Setting up the handset	9
Controls	12
Display	14
Setting the unit before use	14

Making/Answering Calls

Making calls	16
Answering calls	16
Useful features during a call	17

Phonebook

Handset phonebook	18
Copying handset phonebook items	20

Caller ID Service

Using Caller ID service	21
Caller list	21

Programming

Programmable settings	23
---------------------------------	----

Answering System

Answering system	26
Turning the answering system on/off	26
Greeting message	27
Listening to messages using the base unit	28
Listening to messages using the handset	28
Remote operation	29
Answering system settings	31

Voice Mail Service

Using Voice Mail service	33
------------------------------------	----

Multi-unit Operation

Intercom	34
--------------------	----

Transferring calls between handsets, conference calls	34
Registering a handset	35

Useful Information

Wall mounting (Base unit only)	36
Belt clip	37
Headset (optional)	38
Error messages	39
Troubleshooting	40
FCC and other information	44
Specifications	47
Customer services	48
Warranty	49

Index

Index	51
-----------------	----

Product information

Thank you for purchasing a Panasonic cordless telephone.

These operating instructions can be used for the following models:

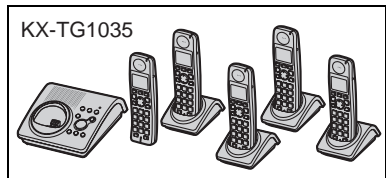
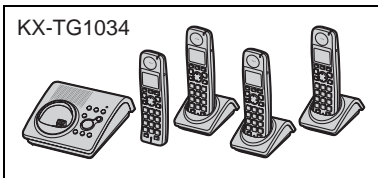
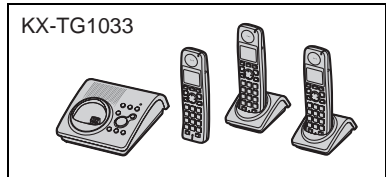
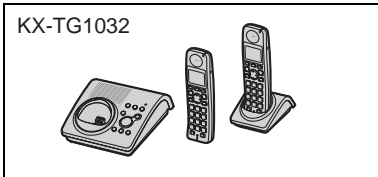

Expanding your phone system

You can expand the phone system by registering optional handsets to a single base unit.

- A maximum of 6 total handsets (included and optional) can be registered to a single base unit.

Handset (optional): KX-TGA101



Accessory information

Included accessories

No.	Accessory item	Order number	Quantity					
			KX-TG 1032S	KX-TG 1032B	KX-TG 1033S	KX-TG 1034S	KX-TG 1034B	KX-TG 1035S
①	AC adaptor for base unit	PQLV207V	1	1	1	1	1	1
②	Telephone line cord	PQJA10075Z	1	1	1	1	1	1
③	Wall mounting adaptor	PQKL10088Z1	1	1	1	1	1	1
④	Batteries	HHR-4DPA (Part No. HHR-55AAABU)	4	4	6	8	8	10
⑤	Handset cover*1	PQYNTG1032SR	2	2	3	4	4	5
⑥	Belt clip	PQKE10456Z2	2	2	3	4	4	5
⑦	Charger	PQLV30053ZS	1	–	2	3	–	4
		PQLV30053ZB	–	1	–	–	3	–
⑧	AC adaptor for charger	PQLV209V	1	1	2	3	3	4

*1 The handset cover comes attached to the handset.

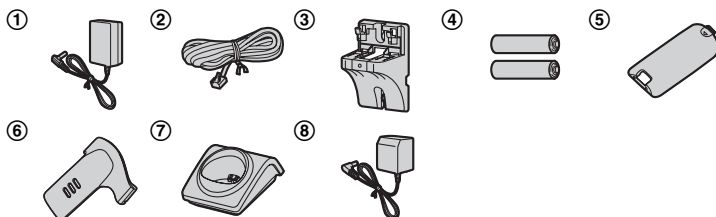

Additional/replacement accessories

Accessory item	Order number
Rechargeable nickel metal hydride (Ni-MH) batteries	HHR-4DPA
Accessory handset with charger	KX-TGA101
Headset	KX-TCA60, KX-TCA86, KX-TCA88HA, KX-TCA92, KX-TCA93, KX-TCA94, or KX-TCA95
T-adaptor	KX-J66

Sales and support information

- To order additional/replacement accessories, call 1-800-332-5368.
- TTY users (hearing or speech impaired users) can call 1-866-605-1277.

Important safety instructions

When using the product, basic safety precautions should always be followed to reduce the risk of fire, electric shock, or personal injury.

1. Read all instructions carefully.
2. Follow all warnings and instructions marked on the product.
3. Unplug the product from power outlets before cleaning. Do not use liquid or aerosol cleaners. Use a moist cloth for cleaning.
4. Do not use the product near water, for example near a bathtub, wash bowl, kitchen sink, etc.
5. Place the product securely on a stable surface. Serious damage and/or injury may result if the product falls.
6. Do not cover slots and openings on the product. They are provided for ventilation and protection against overheating. Never place the product near radiators, or in a place where proper ventilation is not provided.
7. Use only the power source marked on the product. If you are not sure of the type of power supplied to your home, consult your dealer or local power company.
8. Do not place objects on the power cord. Install the product where no one can step or trip on the cord.
9. Do not overload power outlets and extension cords. This can result in the risk of fire or electric shock.
10. Never push any objects through slots in the product. This may result in the risk of fire or electric shock. Never spill any liquid on the product.
11. To reduce the risk of electric shock, do not disassemble the product. Take the product to an authorized service center when service is required. Opening or removing covers may expose you to dangerous voltages or other risks. Incorrect reassembly can cause electric shock when the product is subsequently used.
12. Unplug the product from power outlets and take to an authorized service center when the following conditions occur:
 - A. When the power cord is damaged or frayed.
 - B. If liquid has been spilled into the product.
 - C. If the product has been exposed to rain or water.
 - D. If the product does not work normally by following the operating instructions. Adjust only controls covered by the operating instructions. Improper adjustment may require extensive work by an authorized service center.
 - E. If the product has been dropped or physically damaged.
 - F. If the product exhibits a distinct change in performance.
13. During thunderstorms, avoid using telephones except cordless types. There may be a remote risk of an electric shock from lightning.
14. Do not use the product to report a gas leak, when in the vicinity of the leak.

**SAVE THESE
INSTRUCTIONS**

WARNING:

- To prevent the risk of fire or electrical shock, do not expose the product to rain or any type of moisture.
- Unplug the product from power outlets if it emits smoke, an abnormal smell, or makes an unusual noise. These conditions can cause fire or electric shock. Confirm that smoke has stopped emitting and contact the Panasonic Call Center at 1-800-211-PANA (1-800-211-7262).
- Do not spill liquids (detergents, cleansers, etc.) onto the telephone line cord plug, or allow it to become wet at all. This may cause a fire. If the telephone line cord plug becomes wet, immediately pull it from the telephone wall jack, and do not use.
- Do not place or use this product near automatically controlled devices such as automatic doors and fire alarms. Radio waves emitted from this product may cause such devices to malfunction resulting in an accident.
- Completely insert the AC adaptor/power plug into the power outlet. Failure to do so may cause electric shock and/or excessive heat resulting in a fire.
- Regularly remove any dust, etc. from the AC adaptor/power plug by pulling it from the power outlet, then wiping with a dry cloth. Accumulated dust may cause an insulation defect from moisture, etc. resulting in a fire.

CAUTION:

Installation

- Never install telephone wiring during a lightning storm.
- Never install telephone line jacks in wet locations unless the jack is specifically designed for wet locations.

- Never touch uninsulated telephone wires or terminals unless the telephone line has been disconnected at the network interface.
- Use caution when installing or modifying telephone lines.
- Do not touch the plug with wet hands.
- The AC adaptor is used as the main disconnect device. Ensure that the AC outlet is installed near the product and is easily accessible.

Battery

To reduce the risk of fire or injury to persons, read and follow these instructions.

- Use only the battery(ies) specified.
- Do not mix old and new battery(ies).
- Do not dispose of the battery(ies) in a fire. They may explode. Check with local waste management codes for special disposal instructions.
- Do not open or mutilate the battery(ies). Released electrolyte is corrosive and may cause burns or injury to the eyes or skin. The electrolyte may be toxic if swallowed.
- Exercise care when handling the battery(ies). Do not allow conductive materials such as rings, bracelets or keys to touch the battery(ies), otherwise a short circuit may cause the battery(ies) and/or the conductive material to overheat and cause burns.
- Charge the battery(ies) provided, or identified for use with the product only, in accordance with the instructions and limitations specified in this manual.

Medical

- Consult the manufacturer of any personal medical devices, such as pacemakers or hearing aids, to

Introduction

determine if they are adequately shielded from external RF (radio frequency) energy. (The product operates in the frequency range of 1.92 GHz to 1.93 GHz, and the power output is 125 mW (max.)) Do not use the product in health care facilities if any regulations posted in the area instruct you not to do so. Hospitals or health care facilities may be using equipment that could be sensitive to external RF energy.

For best performance

Base unit location/avoiding noise

The base unit and other compatible Panasonic units use radio waves to communicate with each other.

- For maximum coverage and noise-free communications, place your base unit:
 - at a convenient, high, and central location with no obstructions between the handset and base unit in an indoor environment.
 - away from electronic appliances such as TVs, radios, personal computers, wireless devices or other phones.
 - avoid facing radio frequency transmitters, such as external antennas of mobile phone cell stations (avoid putting the base unit on a bay window or near a window).
- Coverage and voice quality depends on the local environmental conditions.
- If the reception for a base unit location is not satisfactory, move the base unit to another location for better reception.

Environment

- Keep the product away from electrical noise generating devices, such as fluorescent lamps and motors.
- The product should be kept free from excessive smoke, dust, high temperature, and vibration.
- The product should not be exposed to direct sunlight.
- Do not place heavy objects on top of the product.
- When you leave the product unused for a long period of time, unplug the product from the power outlet.
- The product should be kept away from heat sources such as heaters, kitchen stoves, etc. It should not be placed in rooms where the temperature is less than 5 °C (41 °F) or greater than 40 °C (104 °F). Damp basements should also be avoided.
- The maximum calling distance may be shortened when the product is used in the following places: Near obstacles such as hills, tunnels, underground, near metal objects such as wire fences, etc.
- Operating the product near electrical appliances may cause interference. Move away from the electrical appliances.

Routine care

- Wipe the outer surface of the product with a soft moist cloth. Do not use benzine, thinner, or any abrasive powder.

Setting up the base unit

Connecting the AC adaptor and telephone line cord

Connect the telephone line cord until it clicks into the base unit and telephone line jack (1). Connect the AC adaptor cord (2) by pressing the plug firmly (3).

- Use only the included Panasonic AC adaptor PQLV207.

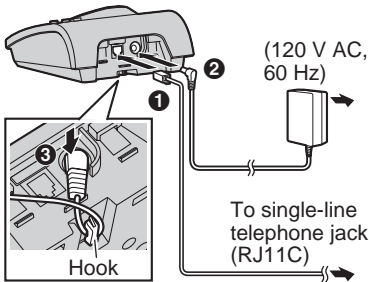

Note:

- The AC adaptor must remain connected at all times. (It is normal for the adaptor to feel warm during use.)
- The AC adaptor should be connected to a vertically oriented or floor-mounted AC outlet. Do not connect the AC adaptor to a ceiling-mounted AC outlet, as the weight of the adaptor may cause it to become disconnected.
- The unit will not work during a power failure. We recommend connecting a corded telephone to the same telephone line or to the same telephone line jack using a Panasonic T-adaptor (page 5).

If you subscribe to a DSL service
Please attach a noise filter (contact your DSL provider) to the telephone line between the base unit and the telephone line jack in the event of the following:

- Noise is heard during conversations.
- Caller ID features do not function properly.

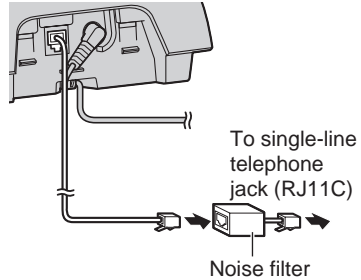

Setting up the handset

Connecting the AC adaptor

- Use only the included Panasonic AC adaptor PQLV209.

(120 V AC, 60 Hz)

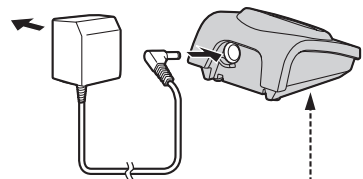

Bottom of the charger



Fasten the AC adaptor cord to prevent it from being disconnected.

Preparation

Battery installation/ replacement

- 1 Press the notch of the handset cover firmly, and slide it in the direction of the arrow.
 - When replacing batteries, remove the old batteries positive (+) end first.

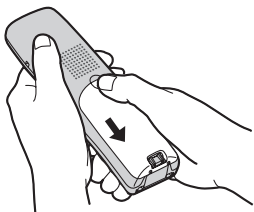

- 2 Insert the batteries negative (-) end first. Close the handset cover.

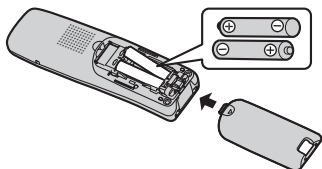

Important:

- USE ONLY Ni-MH batteries AAA (R03) size.
- Do NOT use Alkaline/Manganese/Ni-Cd batteries.
- Install the batteries in proper order (+, -), matching the correct polarity.
- When replacing batteries, we recommend using the Panasonic rechargeable batteries noted on page 5, 7.
- Wipe the battery ends (+, -) with a dry cloth.
- When installing the batteries, avoid touching the battery ends (+, -) or the unit contacts.

Attention:



A nickel metal hydride battery that is recyclable powers the product you have purchased.

Please call 1-800-8-BATTERY (1-800-822-8837) for information on how to recycle this battery.

Battery charge

Place the handset on the base unit or charger for **7 hours** before initial use.

- While charging, "Charging" is displayed and the charge indicator on the handset lights. When the batteries are fully charged, "Charge completed" is displayed.

Base unit:

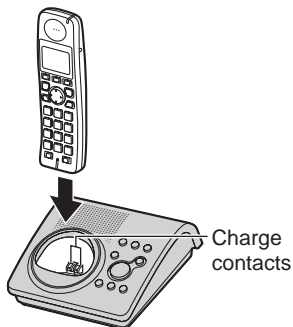

Charger:

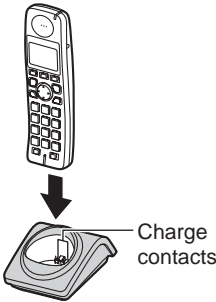

Note:

- It is normal for the handset to feel warm during charging.
- If you want to use the handset immediately, charge the batteries for at least 15 minutes.
- To ensure that the batteries charge properly, clean the charge contacts of the handset, base unit, and charger with a soft, dry cloth once a month. Clean more often if the unit is subject to the exposure of grease, dust, or high humidity.
- When the batteries are empty, the entire display may go blank and "Charging" may not be displayed for about 10 minutes even if you place the handset on the base unit or charger.

Battery level

Battery icon	Battery level
	Fully charged
	Medium
	Low Flashing: needs to be recharged.

Note:

- When the batteries need to be charged, the handset beeps intermittently during use.

Panasonic battery performance

Operation	Operating time
While in use (talking)	Up to 17 hours
While not in use (standby)	Up to 7.5 days

Note:

- Battery operating time may be shortened over time depending on usage conditions and surrounding temperature.
- Battery power is consumed whenever the handset is off the base unit or charger, even when the handset is not in use.
- After the handset is fully charged, displaying "Charge completed", it may be left on the base unit or charger without any ill effect on the batteries.
- The battery level may not be displayed correctly or the entire display may go blank after you replace the batteries. In this case, place the handset on the base unit or charger and let it charge for 7 hours.

Symbols used in these operating instructions

Symbol	Meaning
[] Button name	The words in the brackets indicate button names on the handset and base unit. Example: [↶], [OFF]
→	Proceed to the next operation.
" " Example: "Alarm"	The words in quotations indicate the menu on the display.
Example: [↵]/[▲]: "Off"	Press [↵] or [▲] to select "Off".

Controls

Base unit

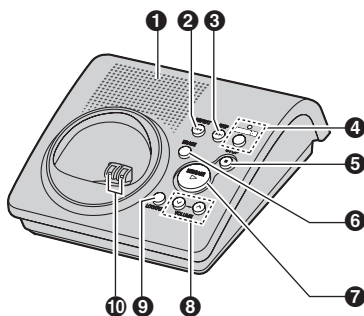

- ❶ Speaker
- ❷ [◀◀] (REPEAT)
- ❸ [▶▶] (SKIP)
- ❹ [ANSWER ON]
ANSWER ON indicator
- ❺ [STOP]
- ❻ [ERASE]
- ❼ [MESSAGE]
MESSAGE indicator
- ❽ VOLUME [▲] [▼]
- ❾ [LOCATOR]
- ❿ Charge contacts

Handset

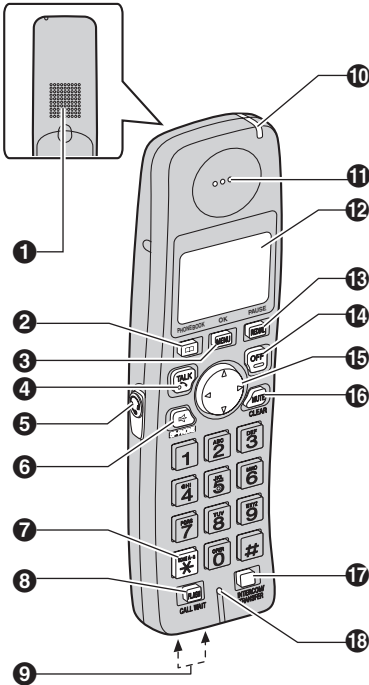

- 1 Speaker
- 2 [☎] (PHONEBOOK)
- 3 [MENU] [OK]
- 4 [☎] (TALK)
- 5 Headset jack
- 6 [☎] (SP-PHONE)
- 7 [*] (TONE)
- 8 [FLASH] [CALL WAIT]
- 9 Charge contacts
- 10 Charge indicator
Ringer indicator
Message indicator
- 11 Receiver
- 12 Display
- 13 [REDIAL] [PAUSE]
- 14 [OFF]

- 15 Navigator key ([▲] [▼] [◀] [▶])
- 16 [MUTE] [CLEAR]
- 17 [INTERCOM] [TRANSFER]
- 18 Microphone

Using the navigator key

The handset navigator key can be used to navigate through menus and to select items shown on the display by pressing [▲], [▼], [◀], or [▶].

Adjusting audio volume

Press [▲] or [▼] repeatedly while talking.

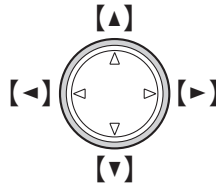

Display

Handset display items

Displayed item	Meaning
Y	Within range of the base unit • When flashing: Handset is searching for base unit. (out of range of base unit, handset is not registered to base unit, no power on base unit)
	Battery level
Example: [1]	The handset's extension number (example shown here: handset 1)
In use	Line or answering system is being used by another handset or the base unit.

Setting the unit before use

Display language

You can select either "English" or "Español" as the display language. The default setting is "English".

- 1 [MENU]
- 2 [▼]/[▲]: "Handset settings" → [OK]
- 3 [▼]/[▲]: "Display settings" → [OK]

4 [▼]/[▲]: "Change language" → [OK]

5 [▼]/[▲]: Select the desired setting.

6 [OK] → [OFF]

Note:

- How to change from Spanish back to English:

- ① [MENU]
- ② [▼]/[▲]: "Ajuste portátil" → [OK]
- ③ [▼]/[▲]: "Ajuste pantalla" → [OK]
- ④ [▼]/[▲]: "Cambiar idioma" → [OK]
- ⑤ [▼]/[▲]: "English" → [OK] → [OFF]

Voice guidance language

You can select either "English" or "Español" as the voice guidance language of the answering system. The default setting is "English".

- 1 [MENU]
- 2 [▼]/[▲]: "Answering device" → [OK]
- 3 [▼]/[▲]: "Settings" → [OK]
- 4 [▼]/[▲]: "Voice prompt" → [OK]
- 5 [▼]/[▲]: Select the desired setting.
- 6 [OK] → [OFF]

Dialing mode

If you cannot make calls, change this setting according to your telephone line service. The default setting is "Tone".

"Tone": For tone dial service.

"Pulse": For rotary/pulse dial service.

- 1 [MENU]
- 2 [▼]/[▲]: "Set tel line" → [OK]
- 3 [▼]/[▲]: "Set dial mode" → [OK]
- 4 [▼]/[▲]: Select the desired setting.
- 5 [OK] → [OFF]

Date and time

Set the correct date and time.

- To use the available alarm function (page 25).
- When you play back a message from the answering system (page 28), the unit announces the day and time it was recorded.

1 [MENU]

2 [▼]/[▲]: "Set date & time" → [OK]

3 [▼]/[▲]: "Date and time" → [OK]

4 Enter the current month, day, and year by selecting 2 digits for each.

Example: August 15, 2007

[0][8] [1][5] [0][7]

5 Enter the current hour and minute (12-hour clock format) by selecting 2 digits for each.

Example: 9:30

[0][9] [3][0]

6 Press [✖] to select "AM" or "PM".

7 [OK] → [OFF]

Note:

- When English is selected as the display language, 12-hour clock format is used. When Spanish is selected, 24-hour clock format is used.
- If you make a mistake when entering the date and time, press [◀], [▶], [▲], or [▼] to move the cursor, then make the correction.
- The date and time may be incorrect after a power failure. In this case, set the date and time again.

Making calls

- 1 Dial the phone number.
 - To correct a digit, press **[CLEAR]**.
- 2 Press **[↶]**.
- 3 When you finish talking, press **[OFF]** or place the handset on the base unit or charger.

Using the speakerphone

- 1 Dial the phone number, and press **[☎]**.
 - Speak alternately with the other party.
- 2 When you finish talking, press **[OFF]**.

Note:

- Use the speakerphone in a quiet environment.
- To switch to the receiver, press **[↶]**.

Adjusting the receiver/speaker volume

Press **[▲]** or **[▼]** repeatedly while talking.

Making a call using the redial list

The last 5 phone numbers dialed are stored in the redial list (each 48 digits max.).

- 1 **[REDIAL]**
- 2 **[▼]/[▲]**: Select the desired phone number.
- 3 **[↶]**

Erasing a number in the redial list

- 1 **[REDIAL]**
- 2 **[▼]/[▲]**: Select the desired phone number.
- 3 **[MENU]**

4 **[▼]/[▲]**: "Erase" → **[OK]**

5 **[▼]/[▲]**: "Yes" → **[OK]** → **[OFF]**

Note:

- Step 3 variation:
Press **[CLEAR]**, then skip to step 5.

PAUSE button (for PBX/long distance service users)

A pause is sometimes required when making calls using a PBX or long distance service. When storing a calling card access number and/or PIN in the phonebook, a pause is also needed (page 19).

For example, if you need to dial the line access number "9" when making outside calls with a PBX:

1 **[9]** → **[PAUSE]** → Dial the phone number.

2 **[↶]**

Note:

- A 3.5 second pause is inserted each time **[PAUSE]** is pressed. Press repeatedly to insert longer pauses.

Answering calls

When a call is being received, the ringer indicator flashes rapidly.

- 1 Press **[↶]** or **[☎]**.
 - You can also answer the call by pressing any dial key from **[0]** to **[9]**, **[*]**, **[#]**, or **[INTERCOM]**.
(Any key talk feature)
- 2 When you finish talking, press **[OFF]**.

Note:

- You can change the ringer tone (page 24). You can also adjust the handset ringer volume (page 24).

Auto talk

This feature allows you to answer a call by simply lifting the handset off the base unit or charger. You do not need to press **[↶]**. To activate this feature, see page 24.

Temporary ringer off

While the handset is ringing for a call, you can turn the ringer off temporarily by pressing **[OFF]**.

Useful features during a call

MUTE button

While mute is turned on, you can hear the other party, but the other party cannot hear you.

To mute your voice, press **[MUTE]**.

- To return to the conversation, press **[MUTE]** or **[↶]**.

FLASH button

Pressing **[FLASH]** allows you to use special features of your host PBX such as transferring an extension call, or accessing optional telephone services such as Call Waiting.

Note:

- To change the flash time, see page 24.

For Call Waiting service users

To use Call Waiting, you must subscribe to Call Waiting service of your telephone service provider.

This feature allows you to receive calls while you are already talking on the phone. If you receive a call while on the

phone, you will hear a Call Waiting tone. Please contact your telephone service provider for details and availability of this service in your area.

Press **[CALL WAIT]** to answer the 2nd call.

- To switch between calls, press **[CALL WAIT]**.

Temporary tone dialing (for rotary/pulse service users)

You can temporarily switch the dialing mode to tone when you need to access touch tone services (for example, answering services, telephone banking services, etc.).

Press **[*]** (TONE) before entering access numbers which require tone dialing.

Call share

This feature allows the handset to join an existing outside call.

To join the conversation, press **[↶]** when the other handset is on an outside call.

Note:

- A maximum of 3 parties (including 1 outside party) can join a conversation using 2 extension.

Handset phonebook

You can add up to 50 items to the handset phonebook and search for phonebook items by name.

Adding items to the phonebook

- 1 **[☐]** → **[MENU]**
- 2 **[▼]/[▲]**: "New entry" → **[OK]**
- 3 Enter the name (max. 16 characters). → **[OK]**
- 4 Enter the phone number (max. 24 digits). → **[OK]**
- 5 **[▼]/[▲]**: "Save" → **[OK]**
 - To add other items, repeat from step 3.
- 6 **[OFF]**

Note:

- Step 1 variation:
[MENU] → **[▼]/[▲]**: "Ph. book settings" → **[OK]**

Character table for entering names

While entering characters, you can switch between uppercase and lowercase by pressing **[*]**.

Key	Character
[1]	Space # & ' () * , - . / 1
[2]	A B C 2 a b c 2
[3]	D E F 3 d e f 3
[4]	G H I 4 g h i 4

Key	Character
[5]	J K L 5 j k l 5
[6]	M N O 6 m n o 6
[7]	P Q R S 7 p q r s 7
[8]	T U V 8 t u v 8
[9]	W X Y Z 9 w x y z 9
[0]	Space 0

- To enter another character that is located on the same dial key, first press **[▶]** to move the cursor to the next space.

Editing/correcting a mistake

Press **[◀]** or **[▶]** to move the cursor to the character or number you want to erase, then press **[CLEAR]**. Enter the appropriate character or number.

- Press and hold **[CLEAR]** to erase all characters or numbers.

Finding and calling a phonebook item

Searching for a name alphabetically by scrolling through all items

- 1 **[☐]**
- 2 **[▼]/[▲]**: Select the desired item.
- 3 Press **[↶]** to dial the phone number.

Searching for a name by initial

- 1 [□]
- 2 Press the dial key ([0] – [9]) that corresponds to the first letter you are searching for (see the character table, page 18).
Example: "LISA"
 Press [5] repeatedly to display the first phonebook entry starting with the initial "L" and go to step 3.
 - If there is no item corresponding to the letter you selected, the next item is displayed.
- 3 Press [▼] to select the desired item.
- 4 Press [↶] to dial the phone number.

Editing items in the phonebook

- 1 Find the desired item (page 18). → [MENU]
- 2 [▼]/[▲]: "Edit" → [OK]
- 3 Edit the name if necessary (see the character table, page 18). → [OK]
- 4 Edit the phone number if necessary. → [OK]
- 5 [▼]/[▲]: "save" → [OK] → [OFF]

Erasing items in the phonebook

Erasing an item

- 1 Find the desired item (page 18).
- 2 [MENU]
- 3 [▼]/[▲]: "Erase" → [OK]
- 4 [▼]/[▲]: "Yes" → [OK] → [OFF]

Note:

- Step 2 variation:
 Press [CLEAR], then skip to step 4.

Erasing all items

- 1 [□]
- 2 [MENU]
- 3 [▼]/[▲]: "Erase all" → [OK]
- 4 [▼]/[▲]: "Yes" → [OK]
- 5 [▼]/[▲]: "Yes" → [OK] → [OFF]

Note:

- Step 2 variation:
 Press [CLEAR], then skip to step 4.

Chain dial

This feature allows you to dial phone numbers in the handset phonebook while you are on a call. This feature can be used, for example, to dial a calling card access number or bank account PIN that you have stored in the handset phonebook, without having to dial manually.

- 1 During an outside call, press [□].
- 2 Find the desired item (page 18). → [OK]

Note:

- When storing a calling card access number and your PIN in the phonebook as one phonebook item, press [PAUSE] to add pauses after the number and PIN as necessary (page 16).
- If you have rotary/pulse service, you need to press [*] before pressing [□] in step 1 to change the dialing mode temporarily to tone.

Copying handset phonebook items

You can copy one or all of the phonebook items from one handset to another.

Copying an item

- 1 Find the desired item (page 18). → **[MENU]**
- 2 **[▼]/[▲]**: "Copy" → **[OK]**
- 3 Select the handset to copy to by pressing the desired handset number (**[1]** – **[6]**).
 - When an item has been copied, "Completed" is displayed.
 - To continue copying another item: **[▼]/[▲]**: "Yes" → **[OK]** → Find the desired item. → **[OK]**
- 4 **[OFF]**

Copying all items

- 1 **[□]** → **[MENU]**
- 2 **[▼]/[▲]**: "Copy all" → **[OK]**
- 3 Select the handset to copy to by pressing the desired handset number (**[1]** – **[6]**).
 - When all items have been copied, "Completed" is displayed.
- 4 **[OFF]**

Using Caller ID service

This unit is Caller ID compatible. To use Caller ID features, you must subscribe to Caller ID service of your telephone service provider.

Caller ID features

When an outside call is being received, the calling party's name and phone number are displayed.

Caller information for the last 50 callers is logged in the caller list by the most recent call to the oldest.

- Generally caller information is displayed from the 2nd ring.
- If the unit cannot receive caller information, the following is displayed:
 - “**Out of area**”: The caller dialed from an area which does not provide Caller ID service.
 - “**Private caller**”: The caller requested not to send caller information.
 - “**Long distance**”: The caller called you long distance.
- If the unit is connected to a PBX system, caller information may not be received properly. Consult your PBX supplier.

Missed calls

If a call is not answered, the unit treats the call as a missed call. The number of missed calls is shown on the display. This lets you know if you should view the caller list to see who called while you were out.

Custom name display

When the Caller ID number is received and it matches a phone number stored in the phonebook, the stored name from

the phonebook is displayed and logged in the caller list.

Call Waiting Caller ID display

If you subscribe to both Caller ID and Call Waiting with Caller ID services, the 2nd caller's information is displayed after you hear a Call Waiting tone (page 17). Please contact your telephone service provider for details and availability of this service in your area.

Caller list

Viewing the caller list and calling back

- 1 [MENU]
- 2 [▼]/[▲]: “View Caller ID” → [OK]
- 3 Press [▼] to search from the most recent call, or [▲] to search from the oldest call.
- 4 To call back, press [↶]. To exit, press [OFF].

Note:

- A ✓ is displayed in caller information which has already been viewed or answered.

Editing a caller's phone number before calling back

You can edit a phone number in the caller list by removing its area code and/or the long distance code “1”.

- 1 [MENU]
- 2 [▼]/[▲]: “View Caller ID” → [OK]
- 3 [▼]/[▲]: Select the desired item. → [MENU]
- 4 [▼]/[▲]: “Edit & Save” → [OK]

Caller ID Service

5 Press **[MENU]** repeatedly until the phone number is shown in the desired format.

① Local phone number

Ex:

② Area code – Local phone number

Ex:

③ 1 – Area code – Local phone number

Ex:

6 **[↶]**

Caller ID number auto edit feature

Once you call back an edited number, the unit will remember the Area Code and Format of the Edited Number. Next time when someone calls from the same Area Code, caller information will be customized by the unit as follows:

- When the call is being received, the Caller ID number will be displayed in the same Format as the Edited Number.
- After the call is ended, the phone number of the caller, when reviewed from the Caller list, will be displayed in the same Format as the Edited Number.

For example, you can use this feature to set the unit to ignore the area code of callers in your area code, so that you can call these local numbers using caller information without dialing the area code.

To activate this feature, you must edit an item in the caller list, then call that number. After that, phone numbers from that caller's area code are edited automatically.

This feature can be turned on or off (page 24).

Note:

- Phone numbers from the 4 most recently edited area codes are automatically edited.

- If you move to another area, you can turn this feature off to erase previously edited area codes. To use this feature again, turn it on and reprogram the area codes you want to edit once again.

Storing caller information into the phonebook

1 **[MENU]**

2 **[▼]/[▲]**: "View Caller ID" → **[OK]**

3 **[▼]/[▲]**: Select the desired item. → **[MENU]**

4 **[▼]/[▲]**: "Edit & Save" → **[OK]**

- To edit the number, press **[MENU]** repeatedly until the phone number is shown in the desired format.

5 **[□□]**

6 Edit the name if necessary (see the character table, page 18). → **[OK]**

7 Edit the phone number if necessary. → **[OK]**

8 **[▼]/[▲]**: "Save" → **[OK]** → **[OFF]**

Erasing caller information

1 **[MENU]**

2 **[▼]/[▲]**: "View Caller ID" → **[OK]**

3 **[▼]/[▲]**: Select the desired item.

4 **[MENU]**

5 **[▼]/[▲]**: "Erase" → **[OK]**

- To erase all items, select "Erase all". → **[OK]**

6 **[▼]/[▲]**: "Yes" → **[OK]** → **[OFF]**

Note:

- If you erase an item, you can also press **[CLEAR]** in step 4, then skip to step 6.

Programmable settings

You can customize the unit by programming the following features using the handset.

Programming by scrolling through the display menus

1 [MENU]

2 Press [▼] or [▲] to select the desired menu. → [OK]

- If there is a sub-menu(s), press [▼] or [▲] to select the desired item. → [OK]

3 Press [▼] or [▲] to select the desired setting. → [OK]

- This step may vary depending on the feature being programmed.

4 [OFF]

Note:

- In the following table, < > indicates the default setting.

Main menu	Sub-menu 1	Sub-menu 2	Page
View Caller ID	–	–	21
Answering device	Play new msg.	–	28
	Play all msg.	–	28
	Record greeting ^{*1}	–	27
	Answer on ^{*1} Answer off ^{*1} Default: Answer on	–	26
	Play greeting	–	27
	Erase message	Erase all ^{*1}	28
		Erase greeting ^{*1}	27
	Settings	Remote code ^{*1} Default: 111	31
		Ring count ^{*1} <4 rings>	31
		Recording time ^{*1} <3 min>	32
		Call screening ^{*1} <On>	32
Voice prompt ^{*1} <English>		14	
Alarm	–	–	25

Programming

Main menu	Sub-menu 1	Sub-menu 2	Page
Ph.book settings	New entry	–	18
	Copy all	–	20
	Erase all	–	19
Handset settings	Ringer settings	Ringer volume <Level 6>	–
		Ringer tone ^{*2} <Tone 1>	–
	Display settings	Change language <English>	14
		Contrast <Level 3>	–
	Registration	HS registration	35
		Deregistration	35
	Other settings	Message alert <Off>	32 33
		Key tone ^{*3} <On>	–
		Auto talk ^{*4} <Off>	17
		Caller ID edit <On>	22
Set date & time	Date and time ^{*1}	–	15
	Time adjustment ^{*1,*5} <Caller ID[auto]>	–	–
Set tel line	Set dial mode ^{*1} <Tone>	–	14
	Set flash time ^{*1,*6} <700ms>	–	17
Customer support	–	–	25

*1 If you program these settings using one of the handsets, you do not need to program the same item using another handset.

*2 If you subscribe to a distinctive ring service (such as IDENTIA-RING), select a tone (tone 1 to 5). If you select a melody, you cannot distinguish lines by their ringers. The preset melodies in this product are used with permission of © 2006 Copyrights Vision Inc.

*3 Turn this feature off if you prefer not to hear key tones while you are dialing or pressing any keys, including confirmation tones and error tones.

*4 If you subscribe to Caller ID service and want to view the caller's information after lifting up the handset to answer a call, turn off this feature.

- *5 This feature allows the unit to automatically adjust the date and time setting when caller information is received. To use this feature, set the date and time first.
 - *6 The flash time depends on your telephone exchange or host PBX. Consult your PBX supplier if necessary. The setting should stay at "700ms" unless pressing **[FLASH]** fails to pick up the call waiting call.
-

Alarm

An alarm will sound once for 3 minutes at the set time. Set the date and time beforehand (page 15).

1 [MENU]

2 [▼]/[▲]: "Alarm" → Press **[OK]** 2 times.

3 [▼]/[▲]: Select the desired alarm mode. → **[OK]**

off	Turns alarm off. Press [OK] again, then press [OFF] to exit.
once	The alarm sounds once at the set time. Enter the desired date.
Daily	An alarm sounds daily at the set time.

4 Set the desired time. → **[OK]**

5 [▼]/[▲]: Select the desired ringer tone. → **[OK]**

- We recommend selecting a different ringer tone from outside call.

6 [▼]/[▲]: "Save" → **[OK]** → **[OFF]**

Note:

- To stop the alarm, press any dial key or place the handset on the base unit or charger.
 - When the handset is in use, the alarm will not sound until the handset is in standby mode.
 - If you select "once", the setting will change to "off" after the alarm sounds.
 - When the ringer volume is set to off, the handset rings at the low level for alarm.
-

Customer support

The handset can display the Internet address where you can download the operating instructions or get further information for this product using your computer.

1 [MENU]

2 [▼]/[▲]: "Customer support" → **[OK]** → **[OFF]**

Answering system

This unit contains an answering system which can answer and record calls for you when you are unavailable to answer the phone.

Important:

- Only 1 person can access the answering system at a time.
- When callers leave messages, the unit records the day and time of each message. Make sure the date and time have been correctly set (page 15).

Memory capacity

The total recording capacity (including your greeting message) is about 16 minutes.

A maximum of 64 messages can be recorded.

- If the message memory becomes full, the MESSAGE indicator flashes rapidly (if the answering system is turned on). Erase unnecessary messages (page 28).
- When the message memory becomes full, the greeting message is different depending on your situation:
 - If you use the prerecorded greeting message, the unit automatically switches to another prerecorded greeting message asking callers to call again later.
 - If you recorded your own greeting message, the same message is still announced to callers even though their messages are not recorded.

Turning the answering system on/off

Base unit

Press **[ANSWER ON]** to turn on/off the answering system.

- When the answering system is turned on, the ANSWER ON indicator lights.
- When the answering system is turned off, the ANSWER ON indicator turns off.

Handset

- 1 **[MENU]**
- 2 **[▼]/[▲]**: "Answering device" → **[OK]**
- 3 **[▼]/[▲]**: "Answer on" or "Answer off" → **[OK]** → **[OFF]**

Screening calls

While a caller is leaving a message, you can listen to the call through the handset's speaker.

You can answer the call by pressing **[📞]** on the handset.

Note:

- To turn this feature off, see page 32.

Greeting message

When the unit answers a call, callers are greeted by a greeting message. You can record your own greeting message or use a prerecorded greeting message.

Recording your greeting message

You can record your own greeting message (max. 2 minutes and 30 seconds). If you do not record a greeting message, a prerecorded greeting message is used.

- 1 [MENU]
- 2 [▼]/[▲]: "Answering device" → [OK]
- 3 [▼]/[▲]: "Record greeting" → [OK]
- 4 After the handset beeps, speak clearly about 20 cm (8 inches) away from the microphone.
- 5 To stop recording, press [OK].
- 6 [OFF]

Using a prerecorded greeting message

If you erase or do not record your own greeting message, the unit plays a prerecorded greeting message for callers and ask them to leave messages.

Playing back the greeting message

- 1 [MENU]
- 2 [▼]/[▲]: "Answering device" → [OK]

- 3 [▼]/[▲]: "Play greeting" → [OK] → [OFF]

Erasing your greeting message

- 1 [MENU]
- 2 [▼]/[▲]: "Answering device" → [OK]
- 3 [▼]/[▲]: "Erase message" → [OK]
- 4 [▼]/[▲]: "Erase greeting" → [OK]
- 5 [▼]/[▲]: "Yes" → [OK] → [OFF]

Listening to messages using the base unit

When new messages have been recorded, the MESSAGE indicator on the base unit flashes.

Press **[MESSAGE]**.

- The base unit plays new messages.
- When you have no new messages, the base unit plays back all messages.

Operating the answering system

Key	Operation
[^] or [v]	Adjust the speaker volume (during playback)
[<<]	Repeat message (during playback)*1
[>>]	Skip message (during playback)
[STOP]	Stop playback
[ERASE]	Erase message currently playing

*1 If pressed within the first 5 seconds of a message, the previous message is played.

Erasing all messages

Press **[ERASE]** 2 times while the unit is not being used.

Listening to messages using the handset

When new messages have been recorded:

- “**New message**” is displayed.
- The message indicator on the handset flashes slowly if the message alert feature is turned on (page 32).

- 1 **[MENU]**
- 2 **[v]/[^]**: “Answering device” → **[OK]**
- 3 **[v]/[^]**: “Play new msg.” Or “Play all msg.” → **[OK]**
- 4 When finished, press **[OFF]**.

Note:

- To switch to the receiver, press **[↶]**.

Calling back (Caller ID subscribers only)

If caller information was received for the call, you can call the caller back while listening to a message.

- 1 Press **[MENU]** during playback.
- 2 **[v]/[^]**: “Edit & Call” → **[OK]**
- 3 Press **[MENU]** repeatedly until the phone number is shown in the desired format.
- 4 **[↶]**

Erasing all messages

- 1 **[MENU]**
- 2 **[v]/[^]**: “Answering device” → **[OK]**
- 3 **[v]/[^]**: “Erase message” → **[OK]**
- 4 **[v]/[^]**: “Erase all” → **[OK]**
- 5 **[v][^]**: “Yes” → **[OK]** → **[OFF]**

Operating the answering system

You can also operate the answering system by pressing dial keys on the handset. To use the following commands:

- ① **[MENU]**
- ② **[▼]/[▲]: "Answering device"**
→ **[OK]**

Key	Operation
[▲] or [▼]	Adjust the receiver/ speaker volume (during playback)
[1] or [←]	Repeat message (during playback) ^{*1}
[2] or [→]	Skip message (during playback)
[3]	Enter the "Settings" menu
[4]	Play new messages
[5]	Play all messages
[6]	Play greeting message
[7][6]	Record greeting message
[8]	Turn answering system on
[9]	Stop (recording, playback)
[0]	Turn answering system off
[*][4]^{*2}	Erase message currently playing
[*][5]	Erase all messages
[*][6]	Erase greeting message

*1 If pressed within the first 5 seconds of a message, the previous message is played.

*2 You can also erase as follows:
[CLEAR] → **[▼]/[▲]: "Yes"** →
[OK]

Remote operation

Using a touch tone phone, you can call your phone number from outside and access the unit to listen to messages. The unit's voice guidance prompts you to press certain dial keys to perform different operations.

Important:

- In order to operate the answering system remotely, you must first set a remote code (page 31). This code must be entered each time you operate the answering system remotely.

Using the answering system remotely

- 1 Dial your phone number from a touch tone phone.
- 2 After the greeting message starts, enter your remote code (page 31).
 - The unit announces the number of new messages.
 - The voice guidance informs you of the available commands. The announcements are different depending on the voice guidance language settings (page 14).
- 3 Control the unit using remote commands (page 30).
- 4 When finished, hang up.

Voice guidance

When the English voice guidance is selected

During remote operation, the unit's voice guidance starts and prompts you to press **[1]** to perform a specific operation, or press **[2]** to listen to more available operations. Operations are presented by voice guidance in the following order:

- Play back all messages
- Play back new messages
- Record a message
- Erase all messages
- Record a greeting message

Note:

- If you do not press any dial keys within 10 seconds after a voice guidance prompt, the unit disconnects your call.

When the Spanish voice guidance is selected

To start the voice guidance, press **[9]**. The voice guidance announces the available remote commands (page 30). See the Spanish Quick Guide for details.

Note:

- If you do not press any dial keys within 10 seconds after a voice guidance prompt, the unit disconnects your call.

Remote commands

You can press dial keys to access certain answering system functions without waiting for the voice guidance to prompt you.

Key	Remote command
[1]	Repeat message (during playback) ^{*1}
[2]	Skip message (during playback)
[4]	Play new messages
[5]	Play all messages
[6]	Play greeting message
[7]	Record greeting message
[9]	Stop recording Stop playback ^{*2} Start voice guidance ^{*3}
[0]	Turn answering system off
[*][4]	Erase message currently playing
[*][5]	Erase all messages
[*][6]	Erase greeting message (during greeting message playback)
[*][#]	End remote operation (or hang up)

^{*1} If pressed within the first 5 seconds of a message, the previous message is played.

^{*2} For English voice guidance only

- To resume operation, enter a remote command within 3 seconds, or the voice guidance starts.

^{*3} For Spanish voice guidance only

Turning on the answering system remotely

If the answering system is off, you can turn it on remotely.

- 1 Dial your phone number from a touch tone phone.
- 2 Let the phone ring 15 times.
- 3 Enter your remote code within 10 seconds after the beep.
 - The unit answers your call with the greeting message.
 - You can hang up, or enter your remote code again and begin remote operation (page 29).

Skipping the greeting message to leave a message

You can leave a message just as any outside caller can. Call your phone number. When the answering system picks up, press **[*]** to skip the greeting message and record your message after the beep.

Answering system settings

Remote code

A remote code must be entered when operating the answering system remotely. This code prevents unauthorized parties from listening to your messages remotely. The default setting is "111".

- 1 **[MENU]**
- 2 **[▼]/[▲]**: "Answering device" → **[OK]**
- 3 **[▼]/[▲]**: "Settings" → **[OK]**
- 4 **[▼]/[▲]**: "Remote code" → **[OK]**

- 5 Enter the desired 3-digit remote code. → **[OK]** → **[OFF]**

Ring count

You can change the number of times the phone rings before the unit answers calls.

The default setting is "4 rings".

"Toll saver": The unit answers on the 2nd ring when new messages have been recorded, and on the 4th ring when there are no new messages. If you call your phone from outside to listen to new messages (page 29), you will know that there are no new messages when the phone rings for the 3rd time. You can then hang up without being charged for the call.

- 1 **[MENU]**
- 2 **[▼]/[▲]**: "Answering device" → **[OK]**
- 3 **[▼]/[▲]**: "Settings" → **[OK]**
- 4 **[▼]/[▲]**: "Ring count" → **[OK]**
- 5 **[▼]/[▲]**: Select the desired setting.
- 6 **[OK]** → **[OFF]**

For Voice Mail service subscribers

If you subscribe to a flat-rate service package that includes Caller ID, Call Waiting, Voice Mail, and unlimited local/regional/long distance calls, please note the following:

- To use the Voice Mail service provided by your telephone service provider rather than the unit's answering system, turn off the answering system (page 26).
- To use this unit's answering system rather than the Voice Mail service provided by your telephone service provider, please contact your telephone service provider to deactivate your Voice Mail service.

Answering System

If your telephone service provider cannot do this:

- Set this unit's "Ring count" setting so that this unit's answering system answers calls before the Voice Mail service of your telephone service provider does. It is necessary to check the ring count required to activate the Voice Mail service provided by your telephone service provider before changing this setting.
- Change the ring count of the Voice Mail service so that the answering system can answer the call first. To do so, consult your telephone service provider.

Caller's recording time

You can change the maximum message recording time allotted to each caller. The default setting is "3 min".

- 1 [MENU]
- 2 [▼]/[▲]: "Answering device" → [OK]
- 3 [▼]/[▲]: "Settings" → [OK]
- 4 [▼]/[▲]: "Recording time" → [OK]
- 5 [▼]/[▲]: Select the desired setting.
- 6 [OK] → [OFF]

Message alert

You can select whether or not the message indicator on the handset flashes slowly when new messages are recorded. The default setting is "off".

Important:

- If there are new Voice Mail messages present (page 33), the message indicator also flashes slowly.

- 1 [MENU]

- 2 [▼]/[▲]: "Handset settings" → [OK]
- 3 [▼]/[▲]: "Other settings" → [OK]
- 4 [▼]/[▲]: "Message alert" → [OK]
- 5 [▼]/[▲]: Select the desired setting.
- 6 [OK] → [OFF]

Note:

- While message alert is on, battery operating time is shortened (page 11).

Call screening

This feature allows you to monitor a message from the handset's speaker when the answering system is recording a message. The default setting is "On".

- 1 [MENU]
- 2 [▼]/[▲]: "Answering device" → [OK]
- 3 [▼]/[▲]: "Settings" → [OK]
- 4 [▼]/[▲]: "Call screening" → [OK]
- 5 [▼]/[▲]: Select the desired setting.
- 6 [OK] → [OFF]

Using Voice Mail service

Voice Mail is an automatic answering service offered by your telephone service provider. After you subscribe to this service, the telephone service provider's Voice Mail system will answer calls for you when you are unavailable to answer the phone or when your line is busy. Messages are recorded by the telephone service provider, not your telephone.

Important:

- To use the Voice Mail service provided by your telephone service provider rather than the unit's answering system, turn off the answering system (page 26).

Voice Mail message indication

The unit lets you know that you have new Voice Mail messages in the following ways:

- “**New Voice Mail**” is displayed on the handset.
- The message indicator on the handset flashes slowly if message alert feature is turned on (page 33).

In order to listen to your Voice Mail messages, you must dial your telephone service provider's Voice Mail access number.

Note:

- If the handset still indicates there are new messages even after you have listened to new messages, turn it off by pressing and holding **[CLEAR]** until the handset beeps.
- The indication of “**New Voice Mail**” may not display properly depending on availability of this service provider.

Please contact your telephone service provider for details.

Message alert

You can select whether or not the message indicator on the handset flashes slowly when there are new recorded messages in the Voice Mail system. The default setting is “**off**”.

Important:

- If there are new answering system messages present (page 26), the message indicator also flashes slowly.

- 1 **[MENU]**
- 2 **[▼]/[▲]**: “**Handset settings**” → **[OK]**
- 3 **[▼]/[▲]**: “**Other settings**” → **[OK]**
- 4 **[▼]/[▲]**: “**Message alert**” → **[OK]**
- 5 **[▼]/[▲]**: Select the desired setting.
- 6 **[OK]** → **[OFF]**

Note:

- While message alert is on, battery operating time is shortened (page 11).

Intercom

Intercom calls can be made between handsets

Note:

- If you receive an outside call while talking on the intercom, you hear 2 tones. To answer the call, press **[OFF]**, then press **[↶]**.
- When paging a unit for an intercom call, the paged unit beeps for 1 minute.

Making an intercom call

- 1 **[INTERCOM]**
- 2 Select the handset you want to page by pressing the desired handset number (**[1]** – **[6]**).
 - To stop paging, press **[OFF]**.
- 3 When you finish talking, press **[OFF]**.

Answering an intercom call

- 1 Press **[↶]** or **[📞]** to answer the page.
- 2 When you finish talking, press **[OFF]**.

Note:

- When the ringer volume is set to off, the handset rings at the low level for the intercom calls.

Handset locator

You can locate a misplaced handset by paging it.

- 1 **Base unit:**
[LOCATOR]
 - The handset beeps for 1 minute.

- 2 To stop paging:

Base unit:

Press **[LOCATOR]**.

Handset:

Press **[OFF]**.

Transferring calls between handsets, conference calls

Outside calls can be transferred between 2 handsets. 2 handsets can have a conference call with an outside party.

- 1 During an outside call, press **[TRANSFER]** to put the call on hold.
- 2 Select the handset you want to transfer to by pressing the desired handset number (**[1]** – **[6]**).
 - If you do not wish to announce the transfer, skip to step 4.
- 3 Wait for the paged party to answer.
 - If the paged party does not answer, press **[↶]** to return to the outside call.
- 4 **To complete the transfer:**
Press **[OFF]**.
 - The outside call is being routed to the handset.**To establish a conference call:**
Press **[MENU]**. → **[1]**
 - To leave the conference, press **[OFF]**. The other parties can continue the conversation.

Note:

- If the paged party does not answer within 1 minute after you hang up, your phone rings and the call is returned to your phone. You can speak to the caller again by pressing **[↶]**.

Answering transferred calls

Press **[\curvearrowright]** to answer the page.

- After the paging party disconnects, you can talk to the outside caller.

Registering a handset

The included handset and base unit are preregistered. If for some reason the handset is not registered to the base unit, register the handset.

1 Handset:

[MENU]

2 **[∇]/[\blacktriangle]: "Handset settings" → **[OK]****

3 **[∇]/[\blacktriangle]: "Registration" → **[OK]****

4 **[∇]/[\blacktriangle]: "HS registration" → **[OK]****

5 Base unit:

Press and hold **[LOCATOR]** until the registration tone sounds.

- If all registered handsets start ringing, press **[LOCATOR]** to stop, then repeat this step.
- After the base unit beeps, the rest of the procedure must be completed within 1 minute and 30 seconds.

6 Handset:

Press **[OK]**, then wait until a beep sounds and **[∇]** stops flashing.

Registering an additional handset

See page 3 for information on the available model.

Start from step 5.

Deregistering a handset

1 **[MENU]**

2 **[∇]/[\blacktriangle]: "Handset settings" → **[OK]****

3 **[∇]/[\blacktriangle]: "Registration" → **[OK]****

4 **[∇]/[\blacktriangle]: "Deregistration" → **[OK]****

5 **[3][3][5]** → **[OK]**

6 Select the handset(s) you want to cancel by pressing the desired handset number (**[1] – [6]**). → **[OK]**

- The selected handset number(s) flashes.
- To cancel a selected handset number, press the number again. The number stops flashing.

7 **[∇]/[\blacktriangle]: "Yes" → **[OK]****

8 After "Deregistered" is displayed, press **[OFF]**.

Wall mounting (Base unit only)

- 1** Lead the AC adaptor cord and telephone line cord through the hole in the wall mounting adaptor in the direction of the arrow.

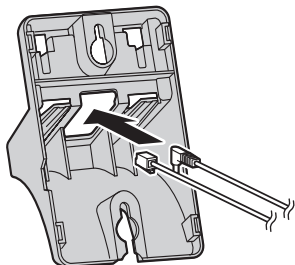

- 2** Tuck the telephone line cord inside the wall mounting adaptor (1). Connect the AC adaptor cord and telephone line cord (2).

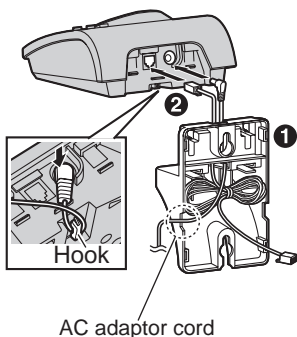

- 3** Insert the hooks on the wall mounting adaptor into the holes **A** and **B** on the base unit.

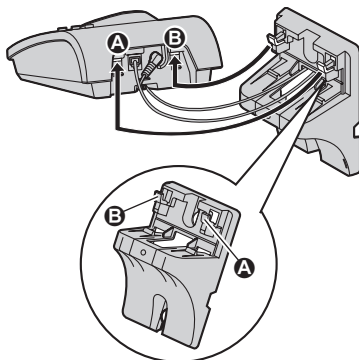

- 4** Adjust the adaptor to hold the base unit, then push it in the direction of the arrow until it clicks into place.

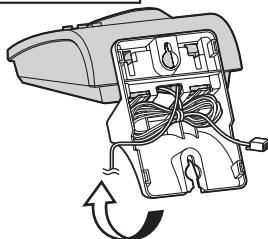
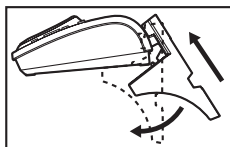

5 Connect the telephone line cord. Mount the unit by inserting the mounting pins into the round openings on the adaptor (for pin **B**, use round cut out at the bottom of the adaptor if you are using the 4 inches phone plate), then sliding the unit down to secure it. Connect the AC adaptor to power outlet (page 9).

- There are two common types of wall phone plates. The distance between **A** and **B** may vary depending on the size of the wall phone plate installed.

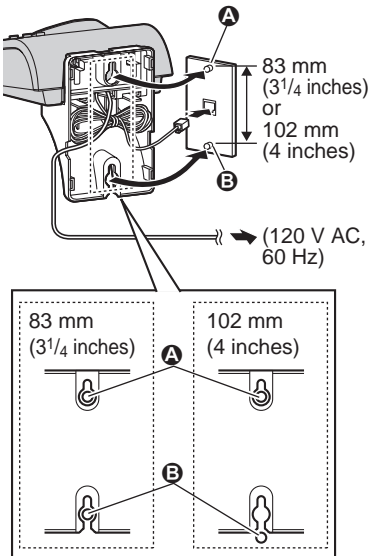

To remove the wall mounting adaptor
While pushing down the release levers (**1**), remove the adaptor (**2**).

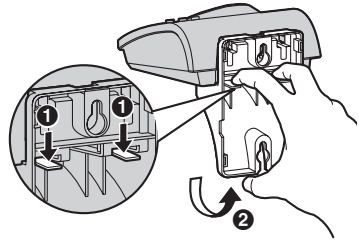

Belt clip

You can hang the handset on your belt or pocket using the included belt clip.

To attach the belt clip

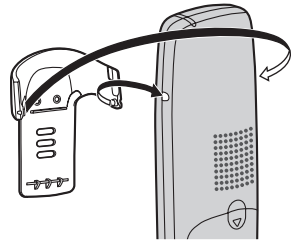

To remove the belt clip

While pressing the top of the clip (**1**), pull the right edge in the direction of the arrow (**2**).

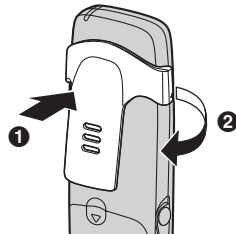

Headset (optional)

Connecting a headset to the handset allows hands-free phone conversations. We recommend using the Panasonic headset noted on page 5.



- Headset shown is KX-TCA86.

Error messages

If the unit detects a problem, one of the following messages is shown on the display.

Display message	Cause/solution
Busy	<ul style="list-style-type: none"> ● The called handset is in use. ● The handset you are calling is too far from the base unit. ● There is no handset registered to the base unit matching the extension number you entered. ● Other units are in use and the system is busy. Try again later.
Error!!	<ul style="list-style-type: none"> ● Recording was too short. Try again.
Failed	<ul style="list-style-type: none"> ● The handset you tried to copy phonebook items to is in use. Try again later.
Incomplete	<ul style="list-style-type: none"> ● The destination handset's phonebook memory is full. Erase unnecessary items from the destination handset's phonebook (page 19).
Memory full	<ul style="list-style-type: none"> ● There is no space to store new items in the phonebook. Erase unnecessary items (page 19).
Messages full	<ul style="list-style-type: none"> ● There is no space in memory to record new messages. Erase unnecessary messages (page 28).
No items stored	<ul style="list-style-type: none"> ● Your phonebook, caller list or redial list is empty.
No link to base. Move closer to base, try again.	<ul style="list-style-type: none"> ● The handset has lost communication with the base unit. Move closer to the base unit, and try again. ● Confirm that the base unit's AC adaptor is plugged in. ● The handset's registration may have been canceled. Re-register the handset (page 35).
Please lift up and try again.	<ul style="list-style-type: none"> ● A handset button was pressed while the handset was on the base unit or charger. Lift the handset and press the button again.
Please set current date & time.	<ul style="list-style-type: none"> ● In order to set the alarm, you must first set the date and time (page 15).

Troubleshooting

General use

Problem	Cause/solution
The unit does not work.	<ul style="list-style-type: none">● Make sure the batteries are installed correctly and fully charged (page 10).● Check the connections (page 9).● Unplug the base unit's AC adaptor to reset the unit. Reconnect the adaptor and try again.● The handset has not been registered to the base unit. Register the handset (page 35).
I cannot hear a dial tone.	<ul style="list-style-type: none">● Confirm the telephone line cord is properly connected (page 9).● Disconnect the unit from the telephone line and connect a known working telephone. If the working telephone operates properly, contact our service personnel to have the unit repaired. If the working telephone does not operate properly, contact your telephone service provider.
The indicator on the top right of the handset flashes slowly.	<ul style="list-style-type: none">● New messages have been recorded. Listen to the new messages (page 28).● New Voice Mail messages have been recorded. Listen to the new Voice Mail messages (page 33).

Programmable settings

Problem	Cause/solution
I cannot program items.	<ul style="list-style-type: none">● Programming is not possible while either the base unit or another handset is being used. Try again later.
While programming, the handset starts to ring.	<ul style="list-style-type: none">● A call is being received. Answer the call and start again after hanging up.

Battery recharge

Problem	Cause/solution
I fully charged the batteries, but  continues to flash.	<ul style="list-style-type: none"> ● Clean the charge contacts and charge again (page 11). ● The batteries may need to be replaced with a new ones (page 10).
I fully charged the batteries, but the operating time seems to be short.	<ul style="list-style-type: none"> ● Wipe the battery ends (\oplus, \ominus) and the unit contacts with a dry cloth.
The handset display is blank.	<ul style="list-style-type: none"> ● Confirm that the batteries are properly installed. ● Fully charge the batteries (page 10, 11).

Making/answering calls, intercom

Problem	Cause/solution
⚡ is displayed, but I cannot make a call.	<ul style="list-style-type: none"> ● The handset and base unit could not communicate for some reason, such as interference from other electrical appliances. Perform the following: <ul style="list-style-type: none"> – Move the handset and base unit away from other electrical appliances. – Move closer to the base unit.
Static is heard, sound cuts in and out. Interference from other electrical units.	<ul style="list-style-type: none"> ● Move the handset and base unit away from other electrical appliances. ● Move closer to the base unit. ● If your unit is connected to a telephone line with DSL service, we recommend connecting a noise filter between the base unit and the telephone line jack. Contact your DSL provider for details.
The handset does not ring.	<ul style="list-style-type: none"> ● The ringer volume is turned off. Adjust it (page 24).
I cannot make a call.	<ul style="list-style-type: none"> ● The dialing mode may be set incorrectly. Change the setting (page 14). ● Another handset is in use. Try again later.
I cannot have a conversation using the headset.	<ul style="list-style-type: none"> ● Make sure that an optional headset is connected properly (page 38).
I cannot make long distance calls.	<ul style="list-style-type: none"> ● Make sure that you have long distance service.
I cannot page the handset.	<ul style="list-style-type: none"> ● The called handset is too far from the base unit. ● The called handset is in use. Try again later.

Useful Information

Caller ID

Problem	Cause/solution
<p>The handset does not display the caller's name and/or phone number.</p>	<ul style="list-style-type: none">● You have not subscribed to Caller ID service. Contact your telephone service provider to subscribe.● If your unit is connected to any additional telephone equipment such as a Caller ID box or cordless telephone line jack, disconnect the unit from the equipment and plug the unit directly into the wall jack.● If your unit is connected to a telephone line with DSL service, we recommend connecting a noise filter between the base unit and the telephone line jack. Contact your DSL provider for details.● The name display service may not be available in some areas. Contact your telephone service provider for details.● Other telephone equipment may be interfering with this unit. Disconnect the other equipment and try again.● The caller requested not to send caller information (page 21).● If a call is being transferred to you, the caller information is not displayed.● Generally, caller information is displayed from the 2nd ring.
<p>The caller list/incoming phone numbers are not edited automatically.</p>	<ul style="list-style-type: none">● The Caller ID number auto edit feature is turned off. Turn it on and try again (page 24).● You need to call back the edited number to activate Caller ID number auto edit.
<p>I cannot dial the phone number edited in the caller list.</p>	<ul style="list-style-type: none">● The phone number you dialed might have an incorrectly edited pattern (for example, the long distance "1" or the area code is missing). Edit the phone number with another pattern (page 21).

Problem	Cause/solution
The 2nd caller's information is not displayed during an outside call.	<ul style="list-style-type: none">● In order to use Caller ID, Call Waiting, or Call Waiting Caller ID (CWID), you must first contact your telephone service provider and subscribe to the desired service. After subscribing, you may need to contact your telephone service provider again to activate this specific service, even if you already subscribed to both Caller ID and Call Waiting with Caller ID services (CWID).

Answering system

Problem	Cause/solution
I cannot listen to messages from a remote location.	<ul style="list-style-type: none">● A touch tone phone is required for remote operation.● Enter the remote code correctly (page 31).● The answering system is off. Turn it on (page 31).
The unit does not record new messages.	<ul style="list-style-type: none">● The answering system is off. Turn it on (page 26, 31).● The message memory is full. Erase unnecessary messages (page 28, 29).● If you subscribe to the Voice Mail service, messages are recorded by the telephone service provider not your telephone (page 31).
I cannot operate the answering system.	<ul style="list-style-type: none">● Someone is operating the answering system.● If someone is talking on a conference call, you cannot operate the answering system. Try again later.

FCC and other information

This equipment complies with Part 68 of the FCC rules and the requirements adopted by the ACTA. On the bottom of this equipment is a label that contains, among other information, a product identifier in the format US:ACJ-----.

If requested, this number must be provided to the telephone company.

- Registration No(found on the bottom of the unit)
- Ringer Equivalence No. (REN).....0.1B

A plug and jack used to connect this equipment to the premises wiring and telephone network must comply with the applicable FCC Part 68 rules and requirements adopted by the ACTA. A compliant telephone cord and modular plug is provided with the product. It is designed to be connected to a compatible modular jack that is also compliant.

The REN is used to determine the number of devices that may be connected to a telephone line. Excessive RENs on a telephone line may result in the devices not ringing in response to an incoming call. In most but not all areas, the sum of RENs should not exceed five (5.0). To be certain of the number of devices that may be connected to a line, as determined by the total RENs, contact the local telephone company. For products approved after July 23, 2001, the REN for the product is part of the product identifier that has the format US:AAAEQ##TXXXX. The digits represented by ## are the REN without a decimal point (e.g., 03 is a

REN of 0.3).

If this equipment causes harm to the telephone network, the telephone company will notify you in advance that temporary discontinuance of service may be required. But if advance notice isn't practical, the telephone company will notify the customer as soon as possible. Also, you will be advised of your right to file a complaint with the FCC if you believe it is necessary.

The telephone company may make changes in its facilities, equipment, operations or procedures that could affect the operation of the equipment. If this happens the telephone company will provide advance notice in order for you to make necessary modifications to maintain uninterrupted service.

If trouble is experienced with this equipment, for repair or warranty information, please contact a Factory Service Center or other Authorized Servicer. If the equipment is causing harm to the telephone network, the telephone company may request that you disconnect the equipment until the problem is resolved.

Connection to party line service is subject to state tariffs. Contact the state public utility commission, public service commission or corporation commission for information.

If your home has specially wired alarm equipment connected to the telephone line, ensure the installation of this equipment does not disable your alarm equipment. If you have questions

about what will disable alarm equipment, consult your telephone company or a qualified installer.

This equipment is hearing aid compatible as defined by the FCC in 47 CFR Section 68.316.

When you hold the phone to your ear, noise might be heard in your Hearing Aid. Some Hearing Aids are not adequately shielded from external RF (radio frequency) energy. If noise occurs, use an optional headset accessory or the speakerphone option (if applicable) when using this phone. Consult with your audiologist or Hearing Aid manufacturer about the availability of Hearing Aids which provide adequate shielding to RF energy commonly emitted by digital devices.

WHEN PROGRAMMING EMERGENCY NUMBERS AND(OR) MAKING TEST CALLS TO EMERGENCY NUMBERS:

- 1) Remain on the line and briefly explain to the dispatcher the reason for the call.
- 2) Perform such activities in the off-peak hours, such as early morning or late evenings.

This device complies with Part 15 of the FCC Rules. Operation is subject to the following two conditions:

(1) This device may not cause harmful interference, and (2) this device must accept any interference received, including interference that may cause undesired operation.

Privacy of communications may not be ensured when using this phone.

CAUTION:

Any changes or modifications not expressly approved by the party responsible for compliance could void the user's authority to operate this device.

NOTE:

This equipment has been tested and found to comply with the limits for a Class B digital device, pursuant to Part 15 of the FCC Rules. These limits are designed to provide reasonable protection against harmful interference in a residential installation. This equipment generates, uses, and can radiate radio frequency energy and, if not installed and used in accordance with the instructions, may cause harmful interference to radio communications. However, there is no guarantee that interference will not occur in a particular installation. If this equipment does cause harmful interference to radio or television reception, which can be determined by turning the equipment off and on, the user is encouraged to try to correct the interference by one or more of the following measures:

- Reorient or relocate the receiving antenna.
- Increase the separation between the equipment and receiver.
- Connect the equipment into an outlet on a circuit different from that to which the receiver is connected.
- Consult the dealer or an experienced radio/TV technician for help.

Some cordless telephones operate at frequencies that may cause interference to nearby TVs and VCRs. To minimize or prevent such interference, the base of the cordless telephone should not be placed near or on top of a TV or VCR. If

Useful Information

interference is experienced, move the cordless telephone further away from the TV or VCR. This will often reduce, or eliminate, interference.

FCC RF Exposure Warning:

- This product complies with FCC radiation exposure limits set forth for an uncontrolled environment.
- To comply with FCC RF exposure requirements, the base unit must be installed and operated 20 cm (8 inches) or more between the product and all person's body (excluding extremities of hands, wrist and feet).
- This product may not be collocated or operated in conjunction with any other antenna or transmitter.
- The handset may be carried and operated with only the specific provided belt-clip. Other non-tested belt-clips or similar body-worn accessories may not comply and must be avoided.

Notice

- This product is designed for use in the United States of America. Sale or use of this product in other countries may violate local laws.
- Cet appareil est conçu pour être utilisé aux États-Unis d'Amérique. La vente ou l'emploi de cet appareil dans certains autres pays peut constituer une infraction à la législation locale.
- Este producto está diseñado para usarse en los Estados Unidos de América. La venta o el empleo de este producto en ciertos países puede constituir violación de la legislación local.
- 本產品專為美國使用而設。若在其他國家銷售或使用，可能會違反當地法例。
- この製品は、日本国外での使用を目的として設計されており、日本国内での使用は法律違反となります。従って、当社では日本国内においては原則として修理などのサービスは致しかねます。

ENERGY STAR

As an ENERGY STAR[®] Participant, Panasonic has determined that this product meets the ENERGY STAR guidelines for energy efficiency. ENERGY STAR is a U.S. registered mark.



Specifications

■ **Standard:**

DECT 6.0 (Digital Enhanced Cordless Telecommunications 6.0)

■ **Number of channels:**

60 Duplex Channels

■ **Frequency range:**

1.92 GHz to 1.93 GHz

■ **Duplex procedure:**

TDMA (Time Division Multiple Access)

■ **Channel spacing:**

1,728 kHz

■ **Bit rate:**

1,152 kbit/s

■ **Modulation:**

GFSK (Gaussian Frequency Shift Keying)

■ **RF transmission power:**

Approx. 100 mW

■ **Voice coding:**

ADPCM 32 kbit/s

■ **Power source:**

120 V AC, 60 Hz

■ **Power consumption:**

Base unit:

Standby: Approx. 1.8 W

Maximum: Approx. 5.0 W

Charger:

Standby: Approx. 0.7 W

Maximum: Approx. 3.5 W

■ **Operating conditions:**

5 °C – 40 °C (41 °F – 104 °F), 20 % – 80 % relative air humidity (dry)

■ **Dimensions:**

Base unit: Approx. 54 mm × 122 mm × 137 mm

(2 ¹/₈ inches × 4 ¹³/₁₆ inches × 5 ³/₈ inches)

Handset: Approx. 169 mm × 49 mm × 35 mm

(6 ²¹/₃₂ inches × 1 ¹⁵/₁₆ inches × 1 ³/₈ inches)

Charger: Approx. 51 mm × 81 mm × 91 mm

(2 inches × 3 ³/₁₆ inches × 3 ¹⁹/₃₂ inches)

■ **Mass (weight):**

Base unit: Approx. 220 g (0.49 lb.)

Handset: Approx. 140 g (0.31 lb.)

Charger: Approx. 70 g (0.15 lb.)

Note:

- Design and specifications are subject to change without notice.
- The illustrations in these instructions may vary slightly from the actual product.

Customer services

Customer Services Directory

Obtain Product Information and Operating Assistance; locate your nearest Dealer or Service Center; purchase Parts and Accessories; or make Customer Service and Literature requests by visiting our Web Site at:

<http://www.panasonic.com/help>

or, contact us via the web at:

<http://www.panasonic.com/contactinfo>

You may also contact us directly at: 1-800-211-PANA (1-800-211-7262), Monday - Friday 9 am to 9 pm; Saturday - Sunday 10 am to 7 pm, EST.

TTY users (hearing or speech impaired users) can call 1-877-833-8855.

Accessory Purchases

Purchase Parts, Accessories and Instruction Books online for all Panasonic Products by visiting our Web Site at:

<http://www.pasc.panasonic.com>

or, send your request by E-mail to:

npcparts@us.panasonic.com

You may also contact us directly at:

1-800-332-5368 (Phone) 1-800-237-9080 (Fax Only)

(Monday - Friday 9 am to 9 pm, EST.)

Panasonic Service and Technology Company

20421 84th Avenue South, Kent, WA 98032

(We Accept Visa, MasterCard, Discover Card, American Express, and Personal Checks.)

TTY users (hearing or speech impaired users) can call 1-866-605-1277.

Service in Puerto Rico

Panasonic Puerto Rico, Inc.

San Gabriel Industrial Park, Ave. 65 de Infantería, Km. 9.5,

Carolina, Puerto Rico 00985

Phone (787)750-4300, Fax (787)768-2910

Warranty

PANASONIC CONSUMER
ELECTRONICS COMPANY, DIVISION
OF PANASONIC CORPORATION OF
NORTH AMERICA
One Panasonic Way,
Secaucus, New Jersey 07094

PANASONIC PUERTO RICO, INC.
San Gabriel Industrial Park,
Ave. 65 de Infantería, Km. 9.5,
Carolina, Puerto Rico 00985

Panasonic Telephone Products Limited Warranty

Limited Warranty Coverage

If your product does not work properly because of a defect in materials or workmanship, Panasonic Consumer Electronics Company or Panasonic Puerto Rico, Inc. (collectively referred to as "the warrantor") will, for the length of the period indicated on the chart below, which starts with the date of original purchase ("Limited Warranty period"), at its option either (a) repair your product with new or refurbished parts, or (b) replace it with a new or a refurbished product. The decision to repair or replace will be made by the warrantor.

Parts

One (1) Year

Labor

One (1) Year

During the "Labor" Limited Warranty period there will be no charge for labor. During the "Parts" Limited Warranty period, there will be no charge for parts. You must mail-in your product prepaid during the Limited Warranty period. This Limited Warranty excludes both parts and labor for batteries, antennas, and cosmetic parts (cabinet). This Limited Warranty only applies to products purchased and serviced in the United States or Puerto Rico. This Limited Warranty is extended only to the original purchaser and only covers products purchased as new.

Mail-In Service

For assistance in the continental U.S.A. in obtaining repairs please ship the product prepaid to:

**Panasonic Service and Technology Company Customer Service Center
4900 George McVay Drive Suite B Door #12 McAllen, TX 78503**

For assistance in Puerto Rico call Panasonic Puerto Rico, Inc. (787)-750-4300 or fax (787)-768-2910.

For Limited Warranty service for headsets if a headset is included with this product please call Panasonic at 1-800-332-5368.

When shipping the unit carefully pack, include all accessories, and send it prepaid, adequately insured and preferably in the original carton. Include a letter detailing the complaint, a return address and provide a day time phone number where you can be reached.

Useful Information

IF REPAIR IS NEEDED DURING THE LIMITED WARRANTY PERIOD THE PURCHASER WILL BE REQUIRED TO FURNISH A SALES RECEIPT/PROOF OF PURCHASE INDICATING DATE OF PURCHASE, AMOUNT PAID AND PLACE OF PURCHASE. CUSTOMER WILL BE CHARGED FOR THE REPAIR OF ANY UNIT RECEIVED WITHOUT SUCH PROOF OF PURCHASE.

Limited Warranty Limits And Exclusions

This Limited Warranty ONLY COVERS failures due to defects in materials or workmanship, and DOES NOT COVER normal wear and tear or cosmetic damage. The Limited Warranty ALSO DOES NOT COVER damages which occurred in shipment, or failures which are caused by products not supplied by the warrantor, or failures which result from accidents, misuse, abuse, neglect, bug infestation, mishandling, misapplication, alteration, faulty installation, set-up adjustments, misadjustment of consumer controls, improper maintenance, power line surge, lightning damage, modification, introduction of sand, humidity or liquids, commercial use such as hotel, office, restaurant, or other business or rental use of the product, or service by anyone other than a Factory Service Center or other Authorized Servicer, or damage that is attributable to acts of God.

THERE ARE NO EXPRESS WARRANTIES EXCEPT AS LISTED UNDER "LIMITED WARRANTY COVERAGE". THE WARRANTOR IS NOT LIABLE FOR INCIDENTAL OR CONSEQUENTIAL DAMAGES RESULTING FROM THE USE OF THIS PRODUCT, OR ARISING OUT OF ANY BREACH OF THIS LIMITED WARRANTY. (As examples, this excludes damages for lost time, lost calls or messages, cost of having someone remove or re-install an installed unit if applicable, travel to and from the servicer. The items listed are not exclusive, but are for illustration only.) **ALL EXPRESS AND IMPLIED WARRANTIES, INCLUDING THE WARRANTY OF MERCHANTABILITY, ARE LIMITED TO THE PERIOD OF THE LIMITED WARRANTY.**

Some states do not allow the exclusion or limitation of incidental or consequential damages, or limitations on how long an implied warranty lasts, so the exclusions may not apply to you.

This Limited Warranty gives you specific legal rights and you may also have other rights which vary from state to state. If a problem with this product develops during or after the Limited Warranty period, you may contact your dealer or Service Center. If the problem is not handled to your satisfaction, then write to the warrantor's Consumer Affairs Department at the addresses listed for the warrantor.

PARTS AND SERVICE, WHICH ARE NOT COVERED BY THIS LIMITED WARRANTY, ARE YOUR RESPONSIBILITY.

Index

- A** Alarm: 25
Answering calls: 16
Answering system
 Erasing messages: 28, 29, 30
 Listening to messages: 28, 29, 30
 Turning on/off: 26, 29, 30, 31
Auto talk: 17
- B** Battery: 10, 11
Belt clip: 37
- C** Call screening: 26, 32
Call share: 17
Call Waiting: 17
Call Waiting Caller ID: 21
Caller ID edit: 21
Caller ID number auto edit: 22
Caller ID service: 21
Caller list: 21, 22
Chain dial: 19
Conference calls: 34
Connections: 9
Customer support: 25
- D** Date and time: 15
Deregistration: 35
Dialing mode: 14
Display
 Contrast: 24
 Language: 14
- E** Error messages: 39
- F** Flash: 17
Flash time: 24
- G** Greeting message: 27
- H** Handset locator: 34
Headset, optional: 38
- I** Intercom: 34
- K** Key tone: 24
- M** Making calls: 16
Memory capacity (message recording): 26
Message alert: 32, 33
Missed calls: 21
Mute: 17
- N** Navigator key: 13
- P** Pause: 16
Phonebook: 18
Phonebook copy: 20
Power failure: 9
Pulse service: 17
- R** Recording time: 32
Redial list: 16
Registration: 35
Remote code: 31
Remote operation: 29
Ring count: 31
Ringer off: 17
Ringer tone: 24
Rotary service: 17
- S** SP-phone: 16
- T** Time adjustment: 24
Toll saver: 31
Tone: 17
Transferring calls: 34
Troubleshooting: 40
TTY: 5, 48
- V** Voice guidance: 30
Voice guidance language: 14
Voice Mail: 31, 33
Volume
 Handset ringer: 24
 Receiver: 16
 Speaker: 16
- W** Wall mounting: 36
Warranty: 48

If you need assistance with setup or operation

- 1 Visit our website: <http://www.panasonic.com/help>
- 2 Contact us via the web at: <http://www.panasonic.com/contactinfo>
- 3 Call us at: 1-800-211-PANA (1-800-211-7262)
TTY users (hearing or speech impaired users) can call 1-877-833-8855.

When you ship the product

- Carefully pack your unit, preferably in the original carton.
- Attach a letter, detailing the symptom, to the outside of the carton.
- Send the unit to Panasonic Service and Technology Company Customer Service Center, prepaid and adequately insured.
- Do not send your unit to Panasonic Consumer Electronics Company listed below or to executive or regional sales offices. These locations do not repair consumer products.

We recommend keeping a record of the following information for future reference.

Serial No. _____ Date of purchase _____
(found on the bottom of the base unit)

Name and address of dealer _____



Panasonic Consumer Electronics Company,
Division of Panasonic Corporation of North America
One Panasonic Way, Secaucus, New Jersey 07094

Panasonic Puerto Rico, Inc.
San Gabriel Industrial Park, Ave. 65 de Infantería, Km. 9.5,
Carolina, Puerto Rico 00985

Copyright:

This material is copyrighted by Panasonic Communications Co., Ltd., and may be reproduced for internal use only. All other reproduction, in whole or in part, is prohibited without the written consent of Panasonic Communications Co., Ltd.
© 2007 Panasonic Communications Co., Ltd. All Rights Reserved.



TG1032

PQQX15791XA FC0107FF2077