

Panasonic

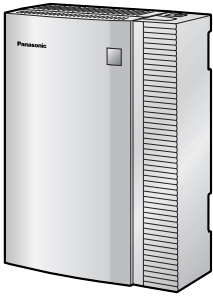

Hybrid IP-PBX User Manual

Model No. **KX-TDA50**



Thank you for purchasing the Panasonic Hybrid IP-PBX, KX-TDA50.
Please read this manual carefully before using this product and save this manual for future use.

Feature Highlights

Call Center

This PBX can establish Incoming Call Distribution Groups (ICD Group) by which a large volume of calls from the external customers could be received. One extension can act as the supervisor, and monitor other group members.

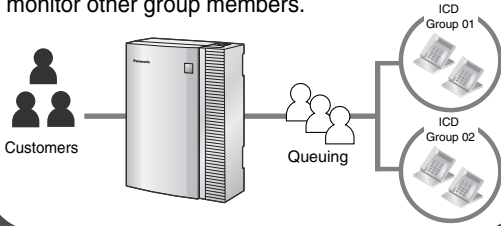

1.8 Call Center (Page 85)

Voice Mail Integration

You can forward your calls to a voice processing system and let calling parties leave messages in your mailbox when you are unable to receive calls.

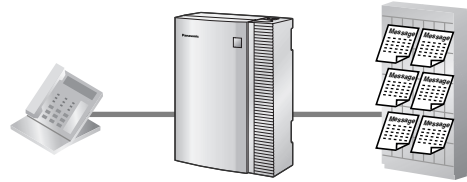

1.9.3 Voice Processing System (Page 93)

Wireless System

This PBX optionally supports a Portable Station (PS) system. PSs can be used on the PBX with other wired telephones.

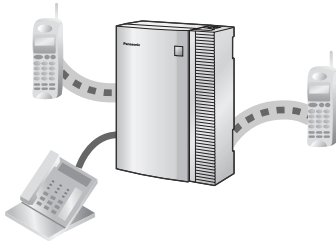

Appendix (Page 139)

PC Phone/PC Console

This PBX supports the PC Phone/PC Console when your computer is connected to certain Panasonic telephones via USB interface. The PC Phone/PC Console provides advanced control and monitoring of your PBX.



Consult your dealer

Easy Operation

If you are using a certain Panasonic telephone that is equipped with a Navigator Key/Jog Dial and a display, it helps you to access the desired feature easily. Also, you will be informed of the arrival of an incoming call or a message waiting by the lamp if it is equipped.

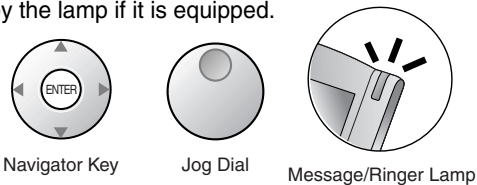

1.1 Before Operating the Telephones (Page 16)

Call Record (Station Message Detail Recording)

This PBX can record or print out call information: date, time, extension no., dialed no., duration, etc.

Date	Time	Ext
01/02/02	10:03AM	1230
01/02/02	11:07AM	2230

Consult your dealer

In This Manual,

- The Proprietary Telephone is abbreviated as "PT".
The Single Line Telephone is abbreviated as "SLT".
The Portable Station is abbreviated as "PS".
The Proprietary Telephone with a Display is abbreviated as "Display PT".
The Digital Proprietary Telephone is abbreviated as "DPT".
- The following icons are used frequently.



Hints



Conditions

Important Information

WARNING

- **THIS UNIT MAY ONLY BE INSTALLED AND SERVICED BY QUALIFIED SERVICE PERSONNEL.**
- **WHEN A FAILURE OCCURS WHICH EXPOSES ANY INTERNAL PARTS, DISCONNECT THE POWER SUPPLY CORD IMMEDIATELY AND RETURN THIS UNIT TO YOUR DEALER.**
- **DISCONNECT THE TELECOM CONNECTION BEFORE DISCONNECTING THE POWER CONNECTION PRIOR TO RELOCATING THE EQUIPMENT, AND RECONNECT THE POWER FIRST.**
- **THIS UNIT IS EQUIPPED WITH A GROUNDING CONTACT PLUG. FOR SAFETY REASONS, THIS PLUG MUST ONLY BE CONNECTED TO A GROUNDING CONTACT SOCKET WHICH HAS BEEN INSTALLED ACCORDING TO REGULATIONS.**
- **THE POWER SUPPLY CORD IS USED AS THE MAIN DISCONNECT DEVICE. ENSURE THAT THE SOCKET-OUTLET IS LOCATED/INSTALLED NEAR THE EQUIPMENT AND IS EASILY ACCESSIBLE.**
- **TO PREVENT THE RISK OF FIRE OR ELECTRIC SHOCK, DO NOT EXPOSE THIS PRODUCT TO RAIN OR MOISTURE.**
- **TO PROTECT THIS UNIT FROM STATIC ELECTRICITY, DO NOT TOUCH ANY CONNECTORS OF THE UNIT.**

IMPORTANT SAFETY INSTRUCTIONS

When using your telephone equipment, basic safety precautions should always be followed to reduce the risk of fire, electric shock and injury to persons, including the following:

1. Read and understand all instructions.
2. Follow all warnings and instructions marked on the product.
3. Unplug this product from the wall outlet before cleaning. Do not use liquid cleaners or aerosol cleaners. Use a damp cloth for cleaning.
4. Do not use this product near water, for example, near a bathtub, wash bowl, kitchen sink, or laundry tub, in a wet basement, or near a swimming pool.
5. Do not place this product on an unstable cart, stand, or table. The product may fall, causing serious damage to the product.
6. Slots and openings in the cabinet and the back or bottom are provided for ventilation; to protect it from overheating, these openings must not be blocked or covered. The openings should never be blocked by placing the product on a bed, sofa, rug, or other similar surface. This product should never be placed near or over a radiator or other heat source. This product should not be placed in a built-in installation unless proper ventilation is provided.
7. This product should be operated only from the type of power source indicated on the product label. If you are not sure of the type of power supply to your home, consult your dealer or local power company.
8. This product is equipped with a 3-wire grounding type plug, a plug having a third (grounding) pin. This plug will only fit into a grounding type power outlet. This is a safety feature. If you are unable to insert the plug into the outlet, contact your electrician to replace your obsolete outlet. Do not defeat the safety purpose of the grounding type plug.
9. Do not allow anything to rest on the power cord. Do not locate this product where the cord will be abused by people walking on it.
10. Do not overload wall outlets and extension cords as this can result in the risk of fire or electric shock.
11. Never push objects of any kind into this product through cabinet slots as they may touch dangerous voltage points or short out parts that could result in a risk of fire or electric shock. Never spill liquid of any kind on the product.
12. To reduce the risk of electric shock, do not disassemble this product, but take it to a qualified person when some service or repair work is required. Opening or removing covers may expose you to dangerous voltages or other risks. Incorrect reassembly can cause electric shock when the appliance is subsequently used.
13. Unplug this product from the wall outlet and refer servicing to qualified service personnel under the following conditions:
 - a) When the power supply cord or plug is damaged or frayed.
 - b) If liquid has been spilled into the product.
 - c) If the product has been exposed to rain or water.
 - d) If the product does not operate normally by following the operating instructions. Adjust only those controls that are covered by the operating instructions because improper adjustment of other controls may result in damage and will often require extensive work by a qualified technician to restore the product to normal operation.
 - e) If the product has been dropped or the cabinet has been damaged.

-
- f) If the product exhibits a distinct change in performance.
 - 14. Avoid using a telephone (other than a cordless type) during an electrical storm. There may be a remote risk of electric shock from lightning.
 - 15. Do not use the telephone to report a gas leak in the vicinity of the leak.

SAVE THESE INSTRUCTIONS

Attention

- If there is any trouble, disconnect the unit from the telephone line. Plug the telephone directly into the telephone line. If the telephone operates properly, do not reconnect the unit to the line until the problem has been repaired by an authorized Panasonic Factory Service Center. If the telephone does not operate properly, chances are that the problem is in the telephone system, and not in the unit.
- Keep the unit away from heating appliances and electrical noise generating devices such as fluorescent lamps, motors and televisions. These noise sources can interfere with the performance of the unit.
- This unit should be kept free of dust, moisture, high temperature (more than 40 °C [104 °F]) and vibration, and should not be exposed to direct sunlight.
- Never attempt to insert wires, pins, etc., into the vents or holes of this unit.
- Do not use benzene, thinner, or the like, or any abrasive powder to clean the cabinet. Wipe it with a soft cloth.
- Do not use any handset other than a Panasonic handset for KX-TDA50 use.

When you ship the product

Carefully pack and send it prepaid, adequately insured and preferably in the original carton. Attach a postage-paid letter, detailing the symptom, to the outside of the carton. **DO NOT** send the product to the Executive or Regional Sales offices. They are **NOT** equipped to make repairs.

Product service

Panasonic Factory Servicenters for this product are listed in the servicenter directory. Consult your certified Panasonic dealer for detailed instructions.

The serial number of this product may be found on the label affixed to the side of the unit. You should note the model number and the serial number of this unit in the space provided and retain this manual as a permanent record of your purchase to aid in identification in the event of theft.

MODEL NO.: _____

SERIAL NO.: _____

For your future reference

DATE OF PURCHASE _____

NAME OF DEALER _____

DEALER'S ADDRESS _____

DEALER'S TELEPHONE NO. _____

F.C.C. REQUIREMENTS AND RELEVANT INFORMATION

1. Notification to the Telephone Company

This equipment complies with Part 68 of the FCC rules and the requirements adopted by the ACTA. On the side of this equipment is a label that contains, among other information, a product identifier in the format US: ACJMF03AKX-TDA50. If requested, this number must be provided to the telephone company.

Installation must be performed by a qualified professional installer. If required, provide the telephone company with the following technical information:

- Telephone numbers to which the system will be connected
- Make: Panasonic
- Model: KX-TDA50
- Certification No.: found on the side of the unit
- Ringer Equivalence No.: 0.3A
- Facility Interface Code: 02LS2
- Service Order Code: 9.0F
- Required Network Interface Jack: RJ11

2. Ringer Equivalence Number (REN)

The REN is used to determine the number of devices that may be connected to a telephone line. Excessive RENs on a telephone line may result in the devices not ringing in response to an incoming call. In most, but not all areas, the sum of RENs should not exceed five (5.0). To be certain of the number of devices that may be connected to a line, as determined by the total RENs, contact the local telephone company. The REN for this product is part of the product identifier that has the format US: ACJMF03AKX-TDA50. The digits represented by 03 are the REN without a decimal point (e.g., 03 is a REN of 0.3). For earlier products, the REN is separately shown on the label.

3. Incidence of Harm to the Telephone Lines

If this equipment causes harm to the telephone network, the telephone company will notify you in advance that temporary discontinuance of service may be required. But if advance notice isn't practical, the telephone company will notify the customer as soon as possible. Also, you will be advised of your right to file a complaint with the FCC if you believe it is necessary.

4. Changes in Telephone Company Communications Facilities, Equipment, Operations and Procedures

The telephone company may make changes in its facilities, equipment, operations or procedures that could affect the operation of the equipment. If this happens the telephone company will provide advance notice in order for you to make necessary modifications to maintain uninterrupted service.

5. Trouble with this equipment

If trouble is experienced with this equipment, for repair or warranty information, please see the attached warranty, which includes the Servicer Directory. If the equipment is causing harm to the telephone network, the telephone company may request that you disconnect the equipment until the problem is resolved.

6. Connection to Party Line

Connection to party line service is subject to state tariffs. Contact the state public utility commission, public service commission or corporation commission for information.

7. Combined Use with Alarm Equipment

If your home has specially wired alarm equipment connected to the telephone line, ensure the installation of this equipment does not disable your alarm equipment. If you have questions about what will disable alarm equipment, consult your telephone company or a qualified installer.

Note

This equipment has been tested and found to comply with the limits for a Class B digital device, pursuant to Part 15 of the FCC Rules. These limits are designed to provide reasonable protection against harmful interference in a residential installation. This equipment generates, uses, and can radiate radio frequency energy and, if not installed and used in accordance with the instructions, may cause harmful interference to radio communications. However, there is no guarantee that interference will not occur in a particular installation. If this equipment does cause harmful interference to radio or television reception, which can be determined by turning the equipment off and on, the user is encouraged to try to correct the interference by one or more of the following measures:

- Reorient or relocate the receiving antenna.
- Increase the separation between the equipment and receiver.
- Connect the equipment into an outlet on a circuit different from that to which the receiver is connected.
- Consult the dealer or an experienced radio/TV technician for help.

CAUTION

Any changes or modifications not expressly approved by the party responsible for compliance could void the user's authority to operate this device.

When programming emergency numbers and/or making test calls to emergency numbers:

1. Remain on the line and briefly explain to the dispatcher the reason for the call before hanging up.
2. Perform such activities in the off-peak hours, such as early morning hours or late evenings.

For Cell Station

CAUTION

Any changes or modifications not expressly approved by the party responsible for compliance could void user's authority to operate this device.

Note

This equipment has been tested and found to comply with the limits for a Class B digital device, pursuant to Part 15 of the FCC Rules. These limits are designed to provide reasonable protection against harmful interference in a residential installation. This equipment generates, uses, and can radiate radio frequency energy and, if not installed and used in accordance with the instructions, may cause harmful interference to radio communications. However, there is no guarantee that interference will not occur in a particular installation. If this equipment does cause harmful interference to radio or television reception, which can be determined by turning the equipment off and on, the user is encouraged to try to correct the interference by one or more of the following measures:

- Reorient or relocate the receiving antenna.
- Increase the separation between the equipment and receiver.
- Connect the equipment into an outlet on a circuit different from that to which the receiver is connected.
- Consult the dealer or an experienced radio/TV technician for help.

Some wireless telephones operate at frequencies that may cause interference to nearby TVs and VCRs. To minimize or prevent such interference, the base of the wireless telephone should not be placed near or on top of a TV or VCR. If interference is experienced, move the wireless telephone further away from the TV or VCR. This will often reduce, or eliminate, interference. Operating near 2.4 GHz electrical appliances may cause interference. Move away from the electrical appliances.

CAUTION

To comply with FCC RF exposure requirements in uncontrolled environment:

- This equipment must be installed and operated in accordance with provided instructions and a minimum 20 cm (8 in) spacing must be provided between antenna and all person's body (excluding extremities of hands, wrist and feet) during wireless modes of operation.
- This transmitter must not be co-located or operated in conjunction with any other antenna or transmitter.

Medical—consult the manufacturer of any personal medical devices, such as pacemakers, to determine if they are adequately shielded from external RF (radio frequency) energy. (The unit operates in the frequency range of 2401 MHz to 2480 MHz, and the power output level can range from 0.004 W to 0.4 W.) Do not use the unit in health care facilities if any regulations posted in the area instruct you not to do so. Hospitals or health care facilities may be using equipment that could be sensitive to external RF (radio frequency) energy.

Table of Contents

1	Operation.....	15
1.1	Before Operating the Telephones	16
1.1.1	Before Operating the Telephones	16
1.2	Making Calls.....	25
1.2.1	Basic Calling.....	25
1.2.2	Easy Dialing.....	28
1.2.3	Redial	32
1.2.4	When the Dialed Line is Busy or There is No Answer	32
1.2.5	Alternate Calling—Ring/Voice	38
1.2.6	Calling without Restrictions	38
1.2.7	Direct Inward System Access (DISA)	40
1.2.8	Remote Setting.....	42
1.3	Receiving Calls	44
1.3.1	Answering Calls.....	44
1.3.2	Hands-free Answerback	44
1.3.3	Call Pickup.....	45
1.3.4	Trunk Answer From Any Station (TAFAS)	46
1.3.5	ANSWER/RELEASE Button	46
1.4	During a Conversation	49
1.4.1	Call Transfer.....	49
1.4.2	Call Hold	51
1.4.3	Call Splitting.....	54
1.4.4	Call Waiting.....	56
1.4.5	Multiple Party Conversation.....	59
1.4.6	Mute.....	64
1.4.7	Off-hook Monitor.....	65
1.4.8	Headset Operation	66
1.5	Absence Settings	68
1.5.1	Call Forwarding.....	68
1.5.2	Absent Message.....	71
1.5.3	Extension Lock	72
1.6	Paging.....	74
1.6.1	Paging.....	74
1.6.2	Answering/Denying a Paging Announcement.....	75
1.7	Extension Settings	76
1.7.1	Timed Reminder	76
1.7.2	Do Not Disturb (DND).....	77
1.7.3	Call Waiting/Off-hook Call Announcement (OHCA)/Whisper OHCA	78
1.7.4	Connected Line Identification Restriction (COLR).....	79
1.7.5	Calling Line Identification Restriction (CLIR)	80
1.7.6	Executive Busy Override Deny	80
1.7.7	Background Music (BGM).....	81
1.7.8	Data Line Security	81
1.7.9	Time Service	81
1.7.10	Paralleled Telephone	82
1.7.11	Wireless XDP Parallel Mode.....	83
1.7.12	Extension Feature Clear	83

1.8	Call Center	85
1.8.1	Log-in/Log-out, Wrap-up	85
1.8.2	Incoming Call Distribution Group Monitor	87
1.8.3	Manual Queue Redirection	89
1.9	User-supplied Equipment.....	91
1.9.1	Doorphone/Door Opener	91
1.9.2	Host PBX.....	92
1.9.3	Voice Processing System.....	93
1.10	Walking Extension	99
1.10.1	Walking Extension.....	99
1.11	Display Proprietary Telephone	100
1.11.1	Call Log.....	100
1.11.2	Directories.....	104
1.11.3	System Feature Access	107
2	Manager Operation.....	109
2.1	Control Features	110
2.1.1	Extension Control.....	110
2.1.2	Time Service Mode Control	110
2.1.3	Dial Tone Transfer	111
2.1.4	External Background Music (BGM).....	112
2.1.5	Outgoing Messages (OGM)	112
3	Customizing Your Phone & System.....	115
3.1	Personal Programming.....	116
3.1.1	Personal Programming.....	116
3.1.2	Settings on the Programming Mode.....	117
3.1.3	Customizing the Buttons	126
3.2	Manager Programming	131
3.2.1	Programming Information.....	131
3.2.2	Manager Programming	132
3.3	System Programming	133
3.3.1	Programming Information.....	133
3.3.2	System Programming.....	135
4	Appendix	139
4.1	Troubleshooting	140
4.1.1	Troubleshooting.....	140
4.2	Feature Number Table	143
4.2.1	Feature Number Table.....	143
4.3	Tone.....	150
4.3.1	Tone	150
Index.....		155



Section 1

Operation

This chapter shows you step by step how to use each feature. Read this chapter to become familiar with the many useful features of this PBX.

1.1 Before Operating the Telephones

1.1.1 Before Operating the Telephones

◆◆ What Kind of Telephone Can Be Used?

You can use a single line telephone (SLT), such as a rotary pulse telephone or a Panasonic proprietary telephone (PT) such as the KX-T7636. You can also use a Panasonic Portable Station (PS), e.g., KX-TD7690. Use the feature depending on the telephone you are using. If you are using

a Panasonic proprietary telephone with a special feature button such as  or a display (Display PT) or both, you can follow the operation with the button or display messages for easy programming. If you use a large display telephone (e.g., KX-T7636), you can follow the displayed messages to use the features. If your telephone does not have feature buttons and/or a display, you may operate the PBX by entering a feature number instead. Follow the operation for your type of telephone. If you use a Console, you can use the buttons on the Console as the buttons on the connected proprietary telephone.

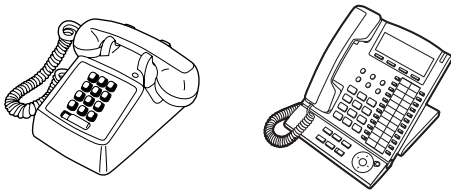

- If you use a Panasonic proprietary telephone which does not have feature buttons, you may change one of the unused flexible buttons to a feature button. Refer to "3.1.3 Customizing the Buttons".

Portable Station (PS) Registration

You must register your PS in the PBX and determine its extension number before initial use. For PS registration, consult your dealer.

◆◆ Feature Numbers

To use certain features, you need to enter specified feature numbers (and an additional parameter, if required).

There are two types of feature numbers as follows:

- Flexible feature number
- Fixed feature number

Fixed feature numbers cannot be changed. However, you can change the flexible numbers to other numbers for easier use. If you want to change the numbers, consult your dealer. In this manual, the default numbers (factory installed) are used for operations.

A flexible number is shown as  (half-shaded key). Use the new programmed number if you have changed the feature number. Write the new number in the "Feature Number Table" (Appendix).



If you use a single line telephone which does not have the "*" or "#" keys; it is not possible to access features that have "*" or "#" in their feature numbers.

◆◆ Tone

You will hear various tones, during or after an operation, for confirmation. Refer to "4.3.1 Tone" (Appendix).

◆◆ Display

In this manual, you will see "the display ...". This refers to the display of a Panasonic proprietary telephone. If your telephone is not a Panasonic display proprietary telephone, the message will not be displayed.

If you use a Panasonic display proprietary telephone, the display helps you confirm the settings.

Some proprietary telephones also give you easy access to features. A message is displayed depending on the feature. By pressing the corresponding button on the side or at the bottom of the display, or pressing the Navigator Key, you can access the desired feature.

Furthermore, depending on the display proprietary telephone, you can operate features or make calls using the display message. Refer to "1.11 Display Proprietary Telephone".

Your Extension Number

If you use a Panasonic display proprietary telephone, you can check your own extension number on the display. Press the TRANSFER button or Soft (S1) button while on-hook.

◆◆ Using a Navigator Key/Jog Dial/Volume Key

The Navigator Key can be used for the display contrast and the volume control or you can search for desired items on the display. Press the Navigator Key/Volume Key or rotate the Jog Dial in the desired direction. The contrast or the volume level and the items will change as follows:

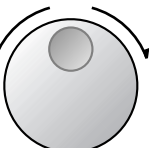
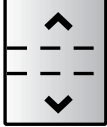
Navigator Key	Jog Dial	Volume Key
<p style="text-align: center;">Up (Level increases)</p>  <p style="text-align: center;">Down (Level decreases)</p>	<p style="text-align: center;">Left (counter-clockwise)</p>  <p style="text-align: center;">Right (clockwise)</p> <p style="text-align: center;">Level decreases Level increases</p>	<p style="text-align: center;">Up (Level increases)</p>  <p style="text-align: center;">Down (Level decreases)</p>

◆◆ Examples

The displays and the illustrations shown as examples are from a telephone connected to the KX-TDA50.

◆◆ Restrictions

Some features may be restricted at your extension under the system programming. Consult your manager or dealer.

◆◆ Icon Descriptions











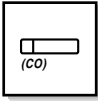
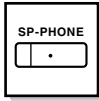

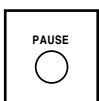
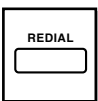
The following icons show you the feature availability, notes and action to use the features.





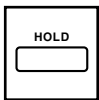

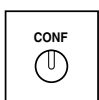







	This feature cannot be used with a single line telephone.		Seize a CO line (One of the following).
	See "Programming" for Related Programming if necessary.		<ul style="list-style-type: none"> • Press the CO button. • Dial automatic line access number 9. • Dial CO line group access number and CO line group number.
	Off-hook (One of the following). <ul style="list-style-type: none"> • Lift the handset. • Press the SP-PHONE button. • Press the MONITOR button. (To start talking, lift the handset.) • Press TALK button. 		Press the Call button on the Doorphone.
	On-hook (One of the following). <ul style="list-style-type: none"> • Hang up. • Press the SP-PHONE button. • Press the MONITOR button. • Press CANCEL button. 		Press the hookswitch lightly.
	Press the corresponding feature button on the proprietary telephone.		Talk.
	Enter the required number. <Example> Enter the account code.		You will hear a busy, confirmation, dial, ring or ringback tone. <ul style="list-style-type: none"> B. Tone: Busy Tone C. Tone: Confirmation Tone D. Tone: Dial Tone R. Tone: Ring Tone R. B. Tone: Ringback Tone
	Dial an extension number.		Dial outside phone number.
	Dial the telephone number.		

◆◆ When You Use a Panasonic Proprietary Telephone

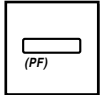
If you use a Panasonic proprietary telephone and the Console, they may have some of the useful feature buttons described below. For a PS user, refer to "Operating Instructions" for PS. These buttons make operations simple. The illustrations may differ from the buttons on your telephone.

Fixed Buttons

	<p>CO: Used to make or receive an outside call. (Button assignment is required.) Also used as feature buttons. (Button assignment is required.) (Only the CO line "number" [e.g., 1, 2] may be shown on some telephones.)</p>		<p>SP-PHONE: Used for hands-free operation.</p>
	<p>AUTO DIAL/STORE: Used for System/Personal Speed Dialing or storing program changes.</p>		<p>PAUSE: Used to insert a pause when storing a telephone number. This button also functions as the PROGRAM button when there is no PROGRAM button on your telephone.</p>
	<p>REDIAL: Used to redial the last dialed number.</p>		<p>MESSAGE: Used to leave a message waiting indication or call back the party who left the message waiting indication.</p>
	<p>INTERCOM: Used to make or receive intercom calls.</p>		<p>Soft Buttons: Used to select the item displayed on the bottom of the display.</p>
	<p>MONITOR: Used for hands-free dialing. You can monitor the party's voice in hands-free mode.</p>		<p>AUTO ANS (Auto Answer)/MUTE: Used to receive an incoming call in hands-free mode or mute the microphone during a conversation.</p>
	<p>TRANSFER: Used to transfer a call to another party.</p>		<p>HOLD: Used to place a call on hold.</p>
	<p>FLASH/RECALL: Used to disconnect the current call and make another call without hanging up. This button also functions as a CANCEL button while on-hook.</p>		<p>CONF (Conference): Used to establish a multiple party conversation.</p>
	<p>VOICE CALL/MUTE: Used to monitor an intercom call automatically, but it cannot be used for hands-free conversations. It also mutes the handset microphone during a conversation.</p>		<p>Call Forwarding (FWD)/Do Not Disturb (DND): Used to perform Call Forwarding (FWD) or Do Not Disturb (DND).</p>

 	<p>PROGRAM: Used to enter and exit the Programming mode.</p>		<p>ANSWER: Used to answer an incoming call.</p>
	<p>RELEASE: Used to disconnect the line.</p>	   	<p>Navigator Key/Jog Dial/Volume Key: Used to adjust the volume and the display contrast or select desired items.</p>
	<p>Programmable Feature (PF): <i>Located on the upper part of the CO button array or on the DSS Console.</i> Assigns the desired button and used to access the stored feature. Mostly used as a One-touch Dialing button. (Only the "F and number" may be shown on some telephones.)</p>		<p>MODE: Used to shift the display to access various features.</p>
	<p>SELECT: Used to select the displayed item or to call the displayed phone number.</p>		<p>SHIFT: Used to access the second level of Soft button features.</p>
	<p>ENTER: Used to confirm the selected item.</p>		<p>CANCEL: Used to cancel the selected item.</p>

Customized Buttons

If the term is in parentheses like (Account) in this section, it means a flexible button has been made into an "Account" button. To customize, refer to "3.1.3 Customizing the Buttons".

Buttons	Feature
Loop-CO (L-CO)	Used to access an idle CO line for making outside calls. Incoming outside calls from any CO line arrive at this button.

Buttons	Feature
Group-CO (G-CO)	Used to access an idle CO line in a specified CO line group for making outside calls. Incoming calls from CO lines in the assigned CO line group arrive at this button.
Single-CO (S-CO)	Used to access a specified CO line for making or receiving outside calls.
Direct Station Selection (DSS)	Used to access an extension with one-touch. It is also possible to be changed to the other feature button.
One-touch Dialing	Used to access a desired party or system feature with one-touch.
Group Directory Number (G-DN)	Used to access a specified incoming call distribution group for making or receiving calls.
Message	Used to leave a message waiting indication or call back the party who left the message waiting indication.
Message for another extension	Used to have a Message button for another extension.
Call Forwarding (FWD)/Do Not Disturb (DND)—Both calls	Used to forward all calls to a specified destination or refuse.
FWD/DND—Outside calls	Used to forward CO line calls to a specified destination or refuse.
FWD/DND—Intercom calls	Used to forward intercom calls to a specified destination or refuse.
Group FWD—Both calls	Used to forward all the calls to your group to a specified destination.
Group FWD—Outside calls	Used to forward the CO line calls to your group to a specified destination.
Group FWD—Intercom calls	Used to forward the intercom calls to your group to a specified destination.
Account	Used to enter an account code.
Conference	Used to establish a multiple party conversation.
Terminate	Used to disconnect the current call and make another call without hanging up.
External Feature Access (EFA)	Used to access special features offered by a host PBX or a telephone company.
Call Park	Used to park or retrieve a call in a preset parking zone.
Call Park (Automatic Park Zone)	Used to park a call in an idle parking zone automatically.
Call Log	Used to show the incoming call information.
Call Log for ICD Group	Used to have a Call Log button for incoming call distribution group.
Log-in/Log-out	Used to switch between the log-in and log-out mode.
Log-in/Log-out of a specified group	Used to have a Log-in/Log-out button for another incoming call distribution group.
Log-in/Log-out for all groups	Used to have a Log-in/Log-out button for all groups.
Hurry-up	Used to transfer the longest waiting call in the queue of an incoming call distribution group to the overflow destination.
Wrap-up	Used to switch the wrap-up status, Ready and Not Ready mode.

1.1 Before Operating the Telephones

Buttons	Feature
System Alarm	Used to confirm a PBX error. For more details, consult your dealer.
Time Service (Day/Night/ Lunch/Break)	Used to switch the time service mode.
Answer	Used to answer an incoming call.
Release	Used to disconnect the line during or after a conversation or to complete a Call Transfer.
Toll Restriction (TRS)	Used to change the toll restriction level of other extension users temporarily.
Calling Line Identification Restriction (CLIR)	Used to switch between the CLIP and CLIR services.
Connected Line Identification Restriction (COLR)	Used to switch between the COLP and COLR services.
Headset	Used to talk using the headset.
Time Service Switching Mode (Automatic/Manual)	Used to switch the time service mode, Automatic or Manual.
Two-way Record	Used to record a conversation into your own mailbox.
Two-way Transfer	Used to record a conversation into the mailbox of a specific extension.
One-touch Two-way Transfer	Used to record a conversation into the mailbox of a specific extension with one-touch.
Live Call Screening (LCS)	Used to monitor your own voice mailbox while an incoming caller is leaving a message and, if desired, intercept the call.
Voice Mail Transfer	Used to transfer a call to the mailbox of a specified extension.

◆◆ How to Follow the Steps

An example of system operation is shown below.

◆◆ **Calling Another Extension** Feature title

To another extension (Intercom Call)

PT/SLT/PS

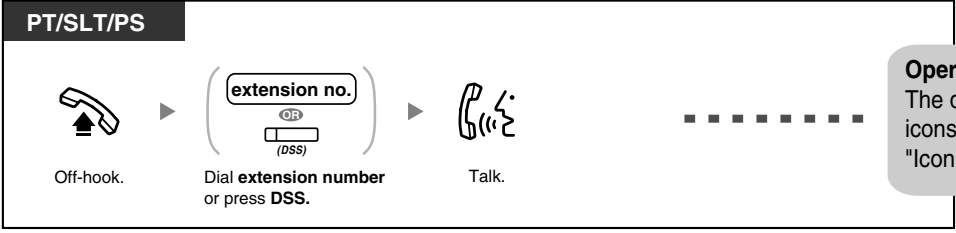

Off-hook.





Dial **extension no.**
or press **DSS**.



Talk.

Operation steps
The description of the icons are explained on "Icon Descriptions".

 • The DSS button light shows the current status as follows:
Off: The extension is idle.
Red on: Your or another extension is using the line. Conditions

 • To call using a directory, refer to "1.11.2 Using the Directories". Hints
• **For quick operation**
If you are an operator or dial some extensions frequently, DSS buttons are useful.

 **Customizing Your Phone**

- 3.1.3 Customizing the Buttons
Create or edit a Direct Station Selection (DSS) button.

Programming References: The related or required programming is noted.

◆◆ Connection Example

This diagram shows you a connection example.

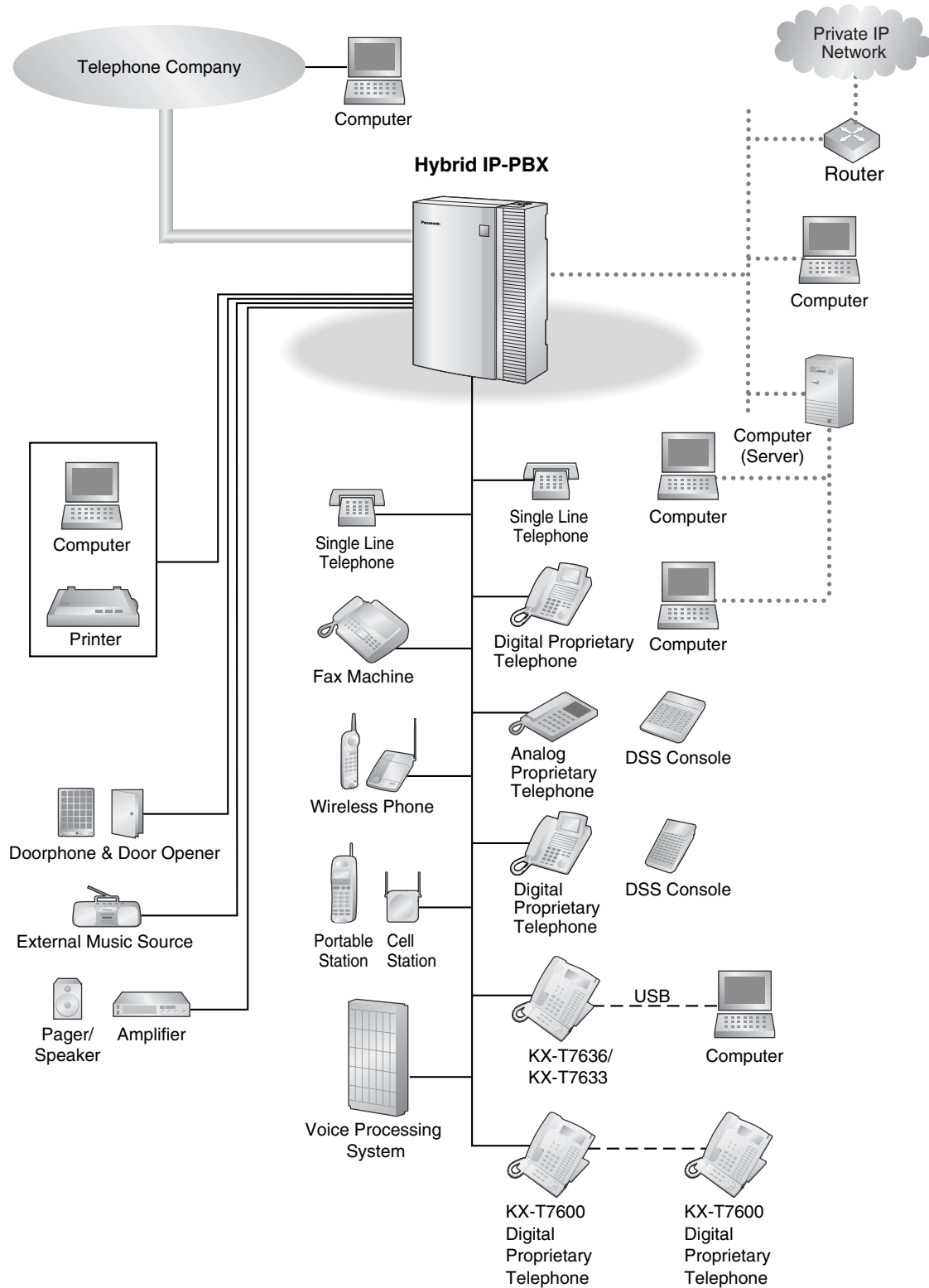

1.2 Making Calls

1.2.1 Basic Calling

- Calling Another Extension
- Calling an Outside Party
- TIE Line Access
- Account Code Entry

◆◆ Calling Another Extension

Intercom Call

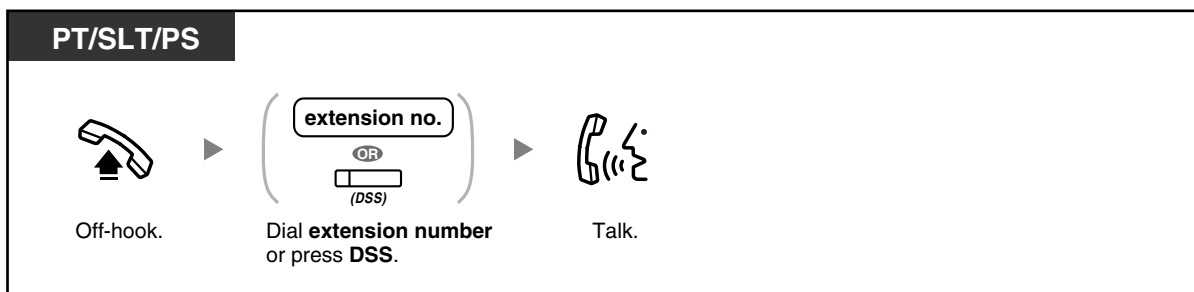

- The DSS button light shows the current status as follows:
Off: The extension is idle.
Red on: Your or another extension is using the line.



- To call using a directory, refer to "1.11.2 Directories".
- **For quick operation**
 If you are an operator or dial some extensions frequently, DSS buttons are useful.



Customizing Your Phone

- 3.1.3 Customizing the Buttons
 Create or edit a Direct Station Selection (DSS) button.

Operator Call

You can call an extension or a group assigned as the operator.

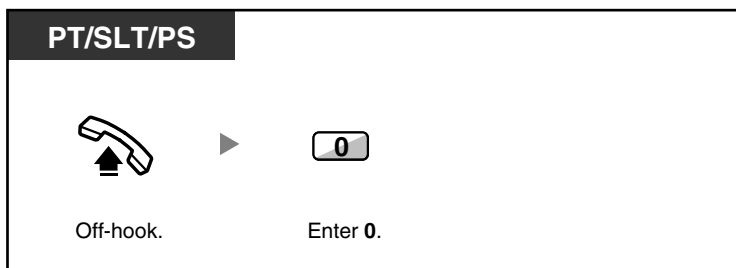

◆◆ Calling an Outside Party

You have to seize a CO line before dialing an outside phone number because external calls are made via your PBX.

Select one of the following methods:

Automatic Line Access

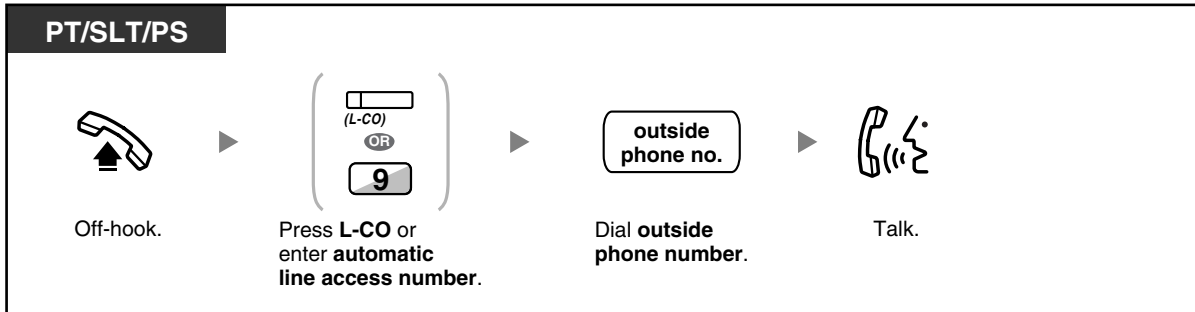

CO Line Group Access

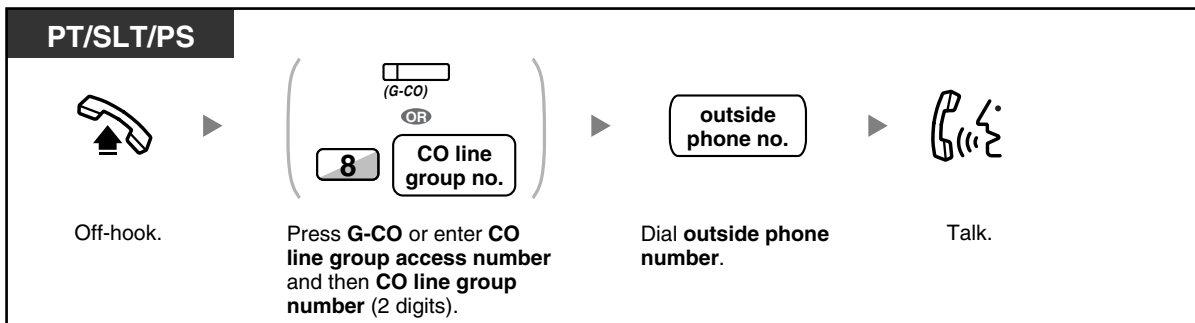

To select the specified CO line

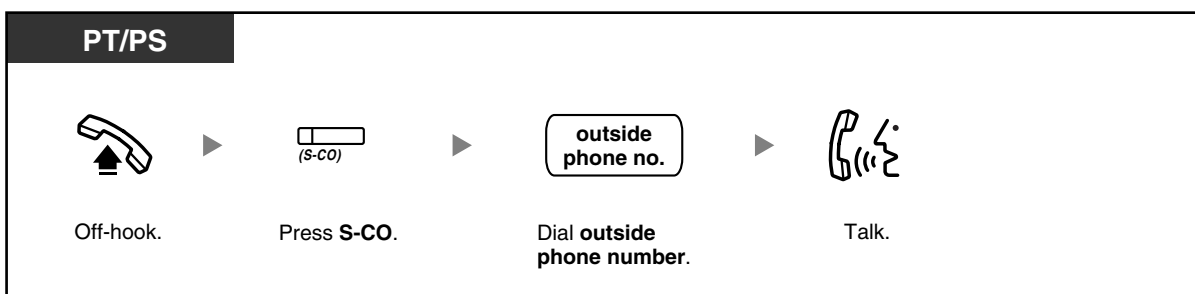

- Each of the S-CO button or G-CO button light shows the current status as follows:
Off: The line is idle.
Red on: The line is in use.
- You may be restricted from making a call to the specified outside party. To make a call, refer to "1.2.6 Calling without Restrictions".



- **To confirm number before dialing**, you can enter a phone number and confirm it on the display and then go off-hook. (Predialing)
- **To make a call to another party without going on-hook**, press the FLASH/RECALL button. It will re-access the CO line and provide external dial tone. Pressing the Terminate button will provide intercom dial tone. You can dial the new phone number without going on/off-hook.



Customizing Your Phone

- 3.1.2 Settings on the Programming Mode—**Preferred Line Assignment—Outgoing**
Select the seized line when going off-hook.
- 3.1.3 Customizing the Buttons
Create or edit a Loop-CO (L-CO) button, a Group-CO (G-CO) button, a Single-CO (S-CO) button or a Terminate button.

◆◆ TIE Line Access

When your PBX is connected to a private network, you can access it.

To call

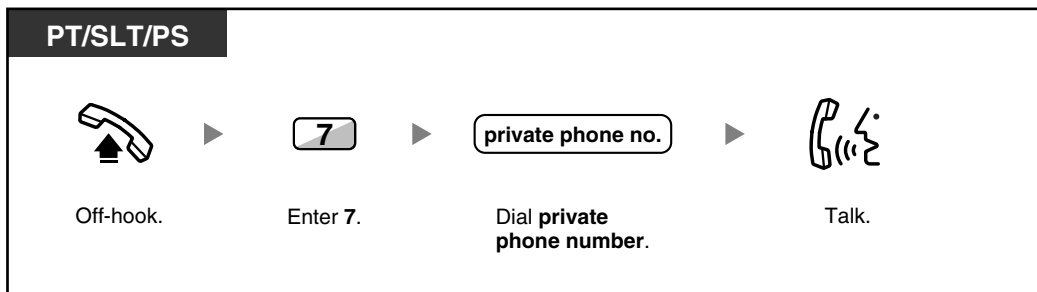

◆◆ Account Code Entry

You may give a specified account code to extension users and check their telephone usage. You can specify an account code for each client and check the call duration.

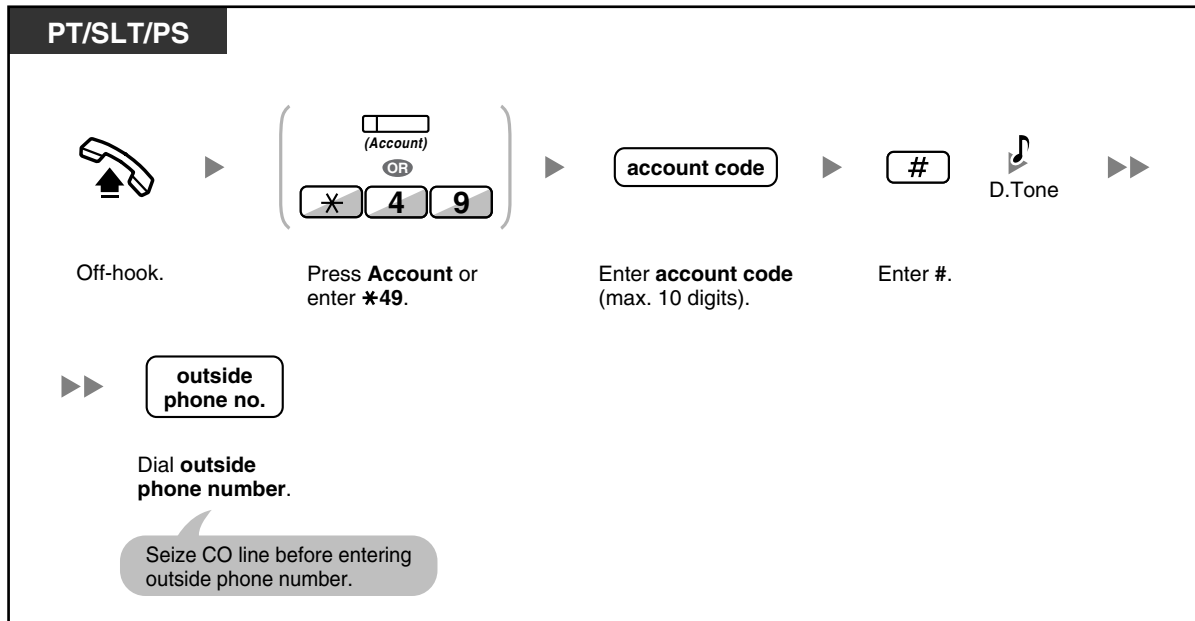

- **A Panasonic proprietary telephone extension user** can enter an account code during a conversation and when hearing reorder tone after the other party hangs up.
- Account codes may use the digits "0" through "9".
- **If you enter the wrong code**, press the "*" key and re-enter the account code.



- You may not be able to make an outside call without an account code. Entry mode is assigned to each user. Ask your manager for your mode.
- **For your convenience**, you can store the code with the phone number in the memory (e.g., Speed Dialing).



Customizing Your Phone

- 3.1.3 Customizing the Buttons
Create or edit an Account button.

1.2.2 Easy Dialing

This is convenient for frequently dialed phone numbers.

- One-touch Dialing
- Personal Speed Dialing
- System Speed Dialing
- Hot Line
- Quick Dialing

◆◆ One-touch Dialing

You can store a phone number into the flexible button for one-touch operation.

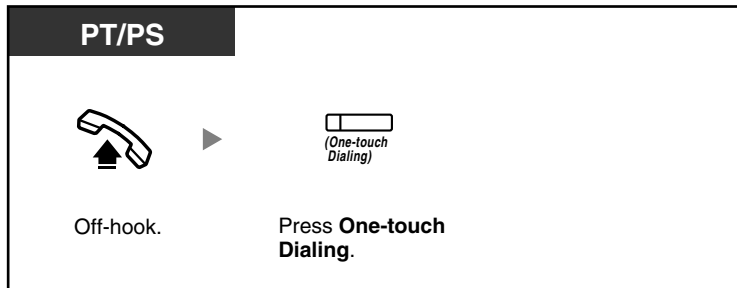

Customizing Your Phone

- 3.1.3 Customizing the Buttons
Create or edit a One-touch Dialing button, store the desired phone number or feature number.

◆◆ Personal Speed Dialing

You can store numbers at your extension for your personal use. (Default: 10 numbers, 00-09)
This feature is also known as Station Speed Dialing.

To store a phone number

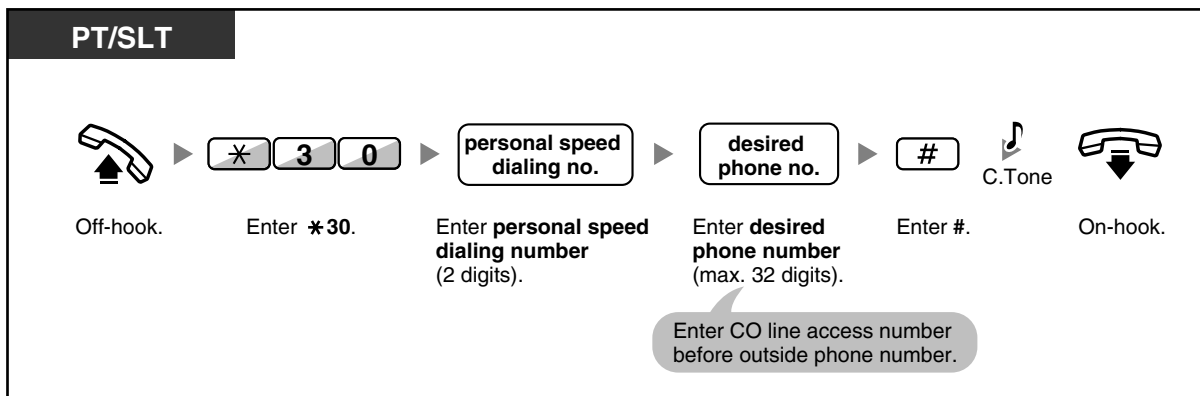

To dial

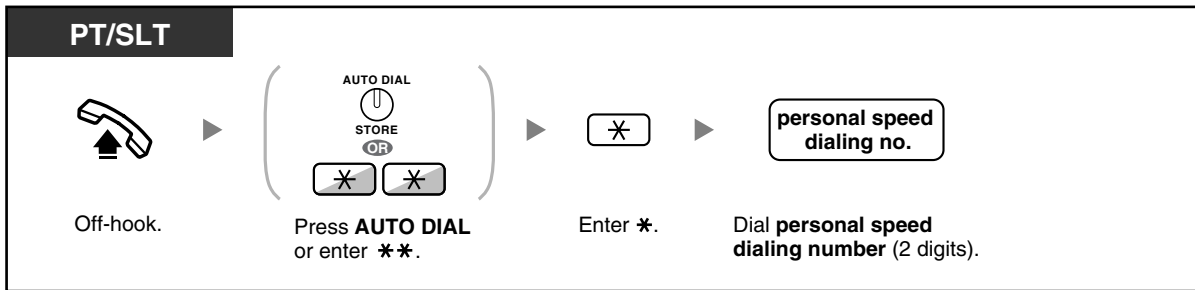

- To call using a directory, refer to "1.11.2 Directories".

◆◆ **System Speed Dialing**

You can make calls using speed dialing numbers stored in the PBX.

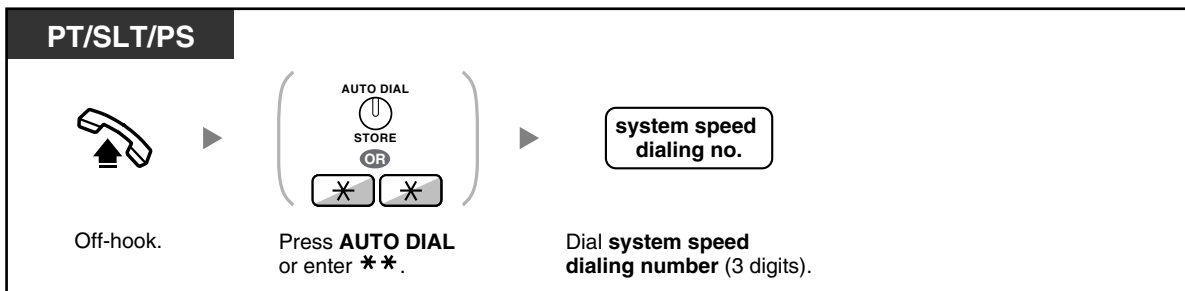

- To call using a directory, refer to "1.11.2 Directories".

◆◆ **Hot Line**

You can make an outside call simply by going off-hook if you have preprogrammed your phone. This feature is also known as Pickup Dialing.

To store a phone number

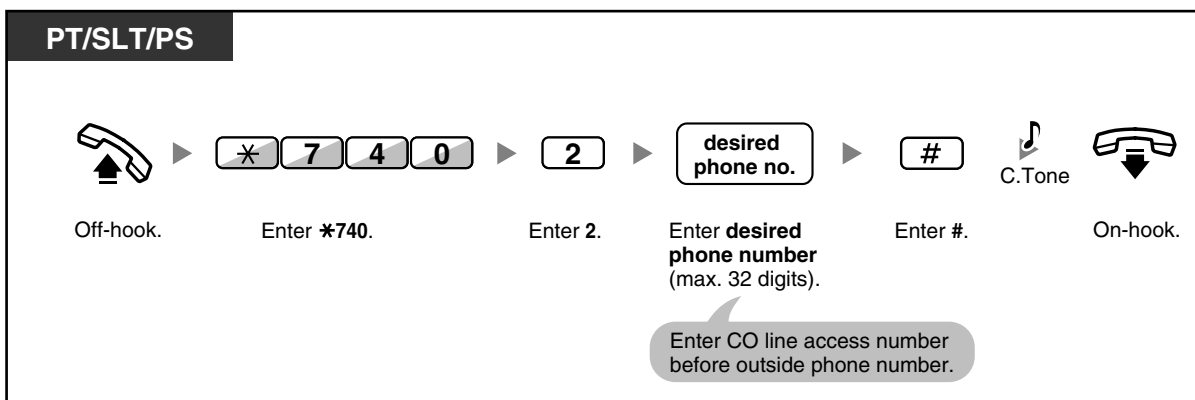

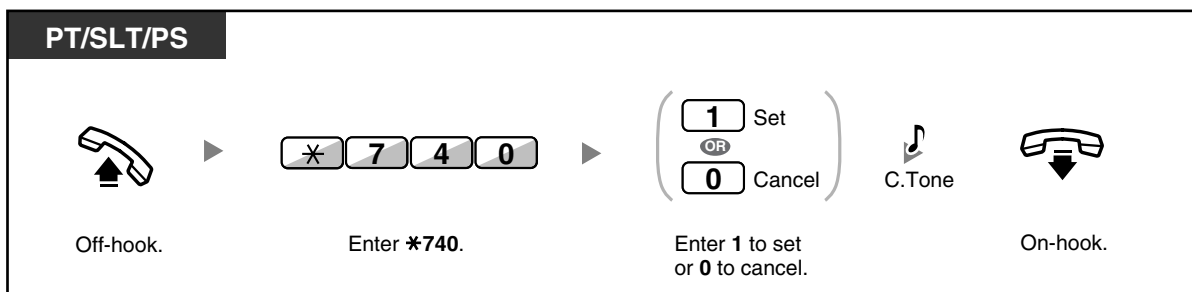
To set/cancel**To dial**

- **To call another party**, dial the desired party's phone number before the preprogrammed number is dialed.
- You should assign the intercom line as the seized line when going off-hook. (Preferred Line Assignment— Outgoing)
- If canceling Hot Line is difficult because this feature is activated immediately after going off-hook, consult your dealer.

Customizing Your Phone

- 3.1.2 Settings on the Programming Mode—**Preferred Line Assignment—Outgoing**
Select the seized line when going off-hook.

Quick Dialing

You can make a call simply by pressing the preprogrammed number for quick dialing. For details, consult your manager or dealer.

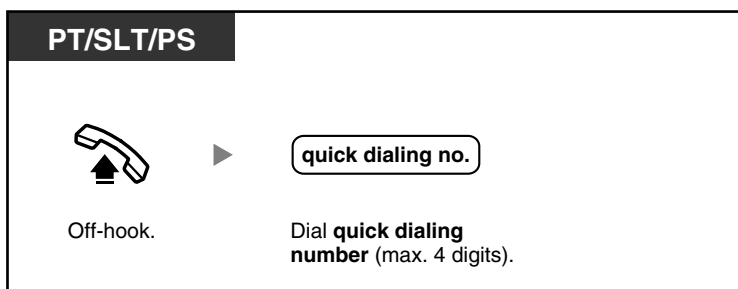

- It is a useful feature for Hotel.
For example, to dial the Room Service, dial the digit "3", not the full extension number.

1.2.3 Redial

This is convenient when calling the same outside party again.

— Last Number Redial

◆◆ Last Number Redial

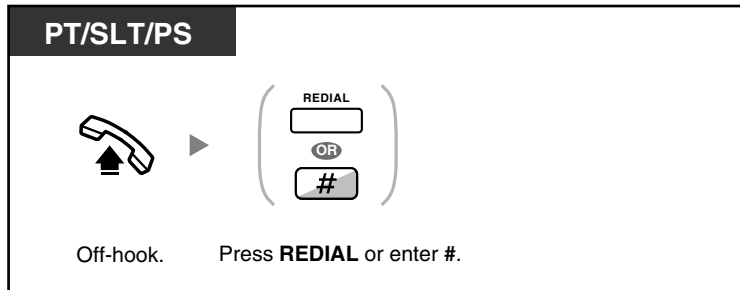

- Up to 32 digits can be stored and redialed.
- After pressing REDIAL, if you hear a busy tone again, press REDIAL to retry.

1.2.4 When the Dialed Line is Busy or There is No Answer

- Automatic Callback Busy
- Call Waiting
- Message Waiting
- Executive Busy Override
- Call Monitor
- DND Override

◆◆ Automatic Callback Busy

You can set the telephone to receive callback ringing:

- when a dialed extension becomes idle.
- when your desired CO line that is in use by another extension becomes idle.

You cannot set Automatic Callback Busy for a busy party outside of the PBX.

When you answer the callback ringing:

- For an outside call: The line is seized.
- For an intercom call: The called extension starts ringing automatically.

To set (for both extension and CO line)

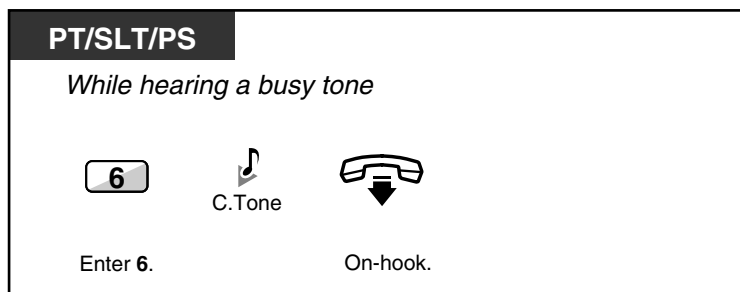

To answer the callback ringing from an idle extension

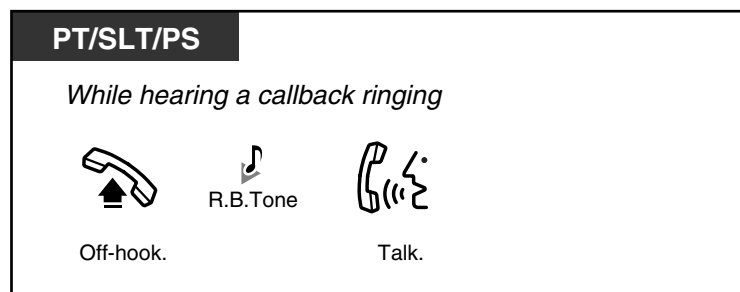

To answer the callback ringing from an idle CO line

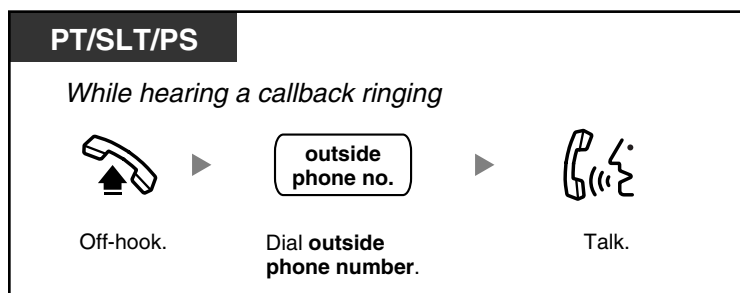

- If you do not answer the callback ringing within 10 seconds, this feature will be canceled.

Automatic Callback Busy Cancel

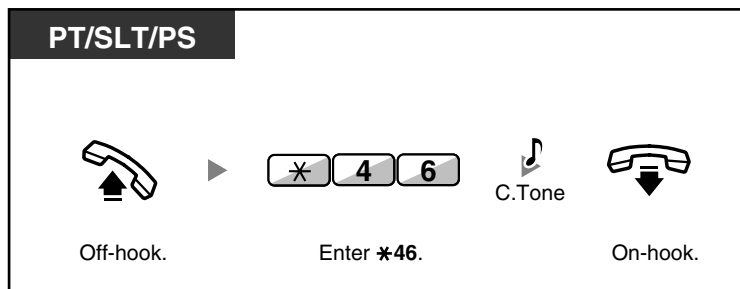

◆◆ Call Waiting

You can inform the called party that your call is waiting.
This feature is also known as Busy Station Signaling (BSS).

PT/SLT/PS

While hearing a busy tone

1

Enter 1.



- **Depending on the other party's telephone**, the "Off-hook Call Announcement (OHCA)" and the "Whisper OHCA" features can be used. You can talk to the other party through the speaker and the microphone (OHCA) or you only send a call announcement through the handset (Whisper OHCA), if they are having another conversation using the handset. Refer to "1.7.3 Call Waiting/Off-hook Call Announcement (OHCA)/Whisper OHCA".

◆◆ Message Waiting

◆ For a caller

When the called extension is busy or does not answer your call, you can leave a notification so that the called party may call you back.

◆ For a called extension

As a message receiver, the Message button light or Message/Ringer Lamp lets you know that a call has been received. If you receive notification, you can call back the caller by a simple operation.

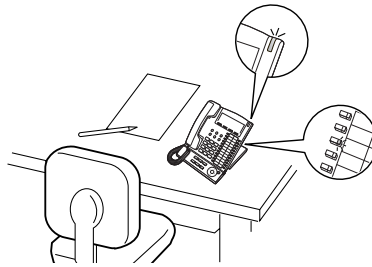

◆ For a caller

To leave a message waiting indication

PT/SLT/PS

When the called extension is busy or does not answer

MESSAGE

OR

4

C.Tone

On-hook.

Press **MESSAGE** or enter **4**.

To leave/cancel a message waiting indication

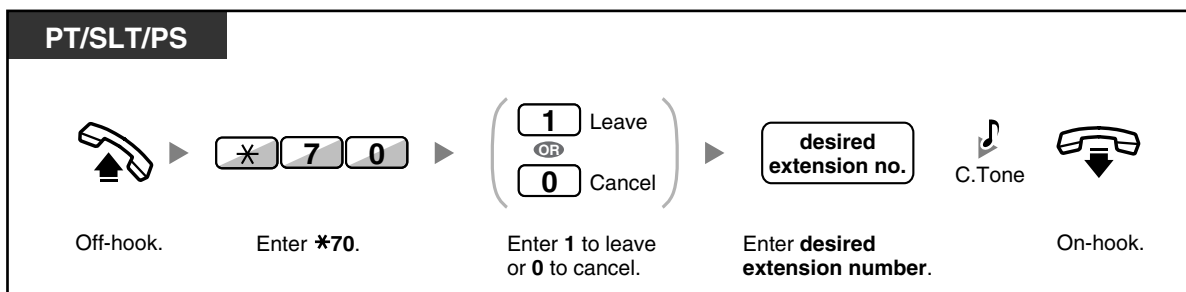

◆ **For a called extension**

To check the left message and call back

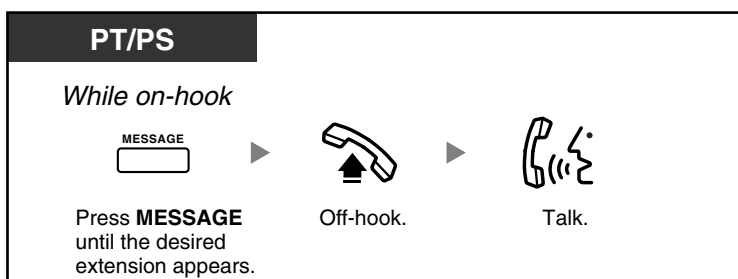

To call back

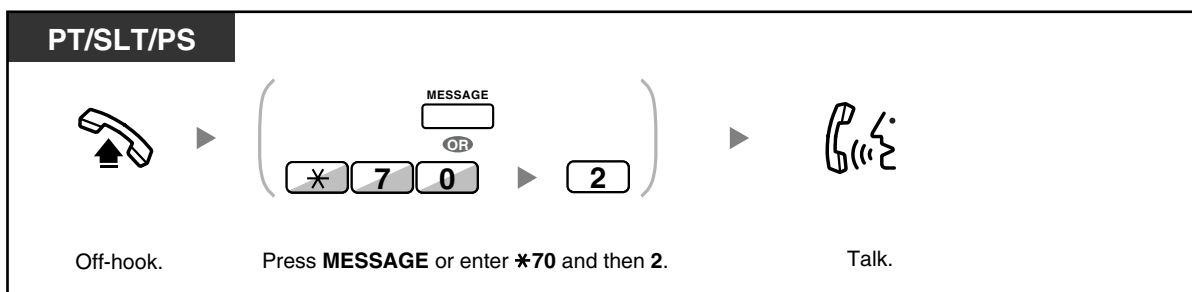

To clear message waiting indications left on your extension

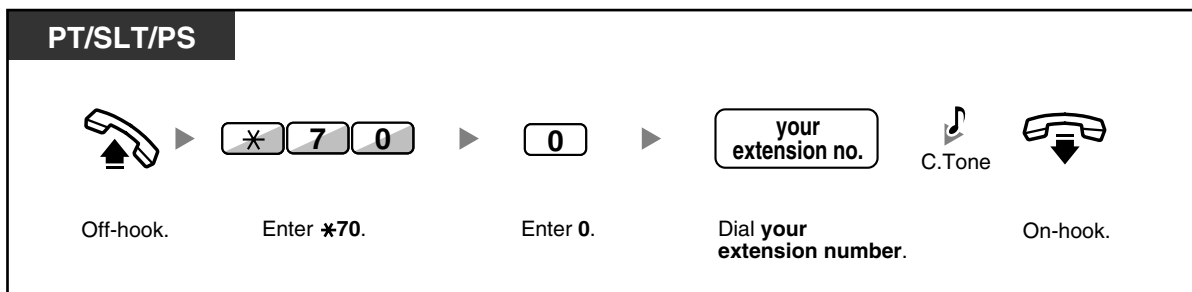



- The Message button light or Message/Ringer Lamp shows the current status as follows:
Off: No message
Red on: You have a message.
- The display shows the messages starting with the most recent call.
- At a called extension, the MESSAGE button allows you to clear message waiting indications if you do not want to call the callers back. To clear, press the MESSAGE button and then press the soft button.
- On your PT, you can establish one or more "Message for another extension" buttons. These buttons can accept the message waiting notification of other extensions or various incoming call distribution groups. In other words, you can monitor the message waiting notifications of other telephones.
- A single line telephone extension user will hear a special dial tone as the message waiting notification when going off-hook.



Customizing Your Phone

- 3.1.3 Customizing the Buttons
 Create or edit a Message button or Message for another extension button.

◆◆ Executive Busy Override

The preprogrammed extension can call someone who is busy on the telephone and establish a three-party conversation.

To join

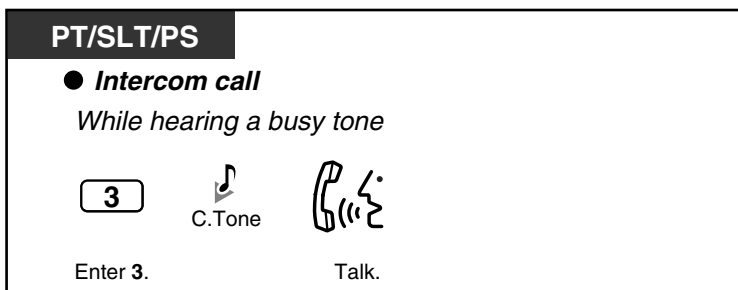
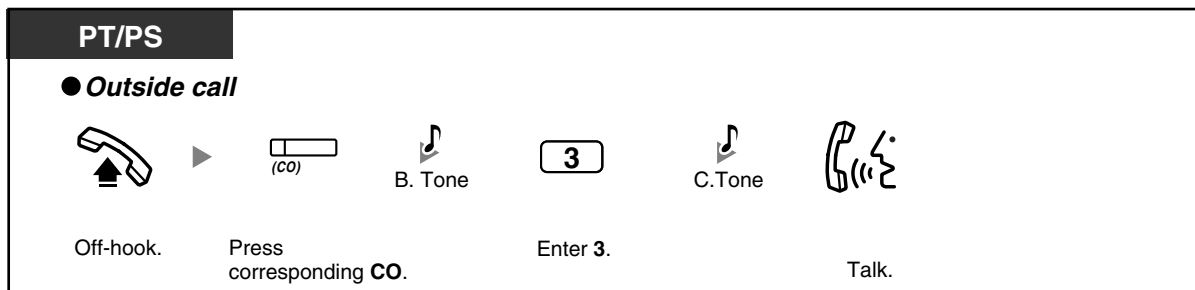

◆ For the joined extension

To talk to each party alternately

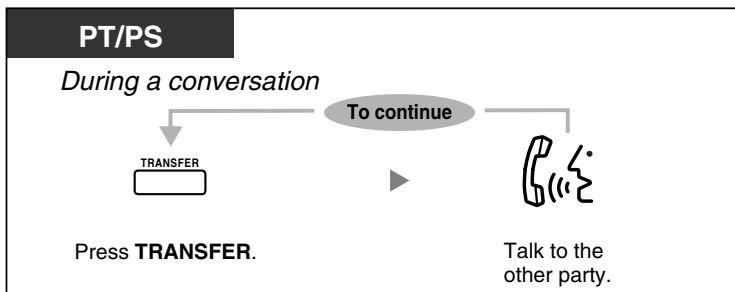

- You can also deny others the possibility of joining your conversation (Default: Allow). Refer to "1.7 Extension Settings".

◆◆ Call Monitor

The preprogrammed extension can monitor another extension.

To monitor

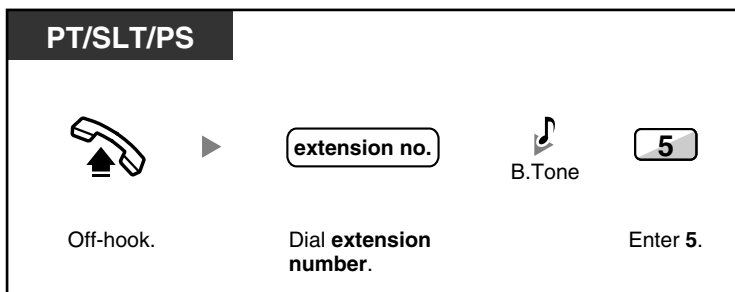

◆◆ DND Override

The preprogrammed extension can call someone who has set the DND feature.

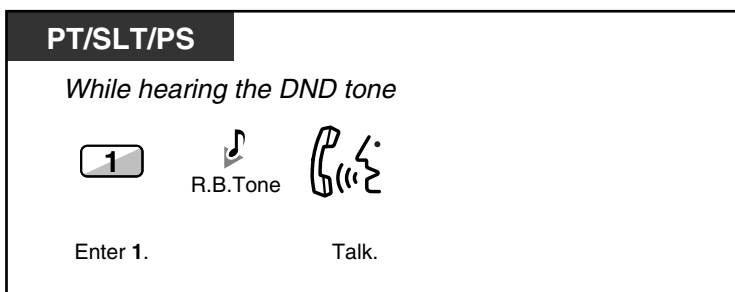

1.2.5 Alternate Calling—Ring/Voice

The caller can alternate the alerting method, either ring or voice, when making an intercom call. On the other hand, any extension can set the alerting method, either ring or voice, when receiving an intercom call.

Ringring (Default): You can call the other party with a ring tone.

Voice-Calling: You can talk to the other party immediately after confirmation tone.

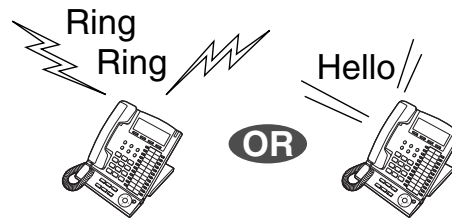

To change the method

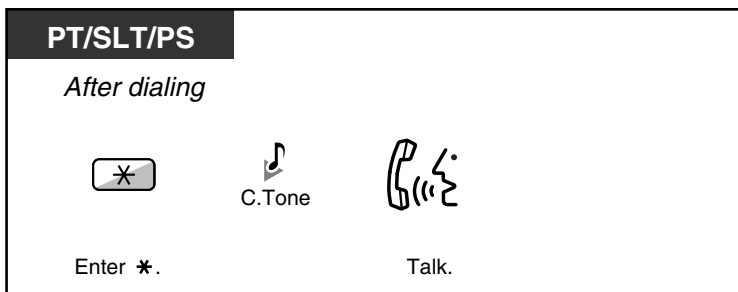

- If the called party uses a single line telephone or portable station, Voice-Calling is not available.
- This feature is not available when the called party's telephone is in the Voice Call Deny mode.



Customizing Your Phone

- 3.1.2 Settings on the Programming Mode—**Alternate Receiving—Ring/Voice**
Select the alerting method, either ring or the other party's voice.

1.2.6 Calling without Restrictions

— Remote COS Access

◆◆ Remote COS Access

You can use your calling privileges (Class of Service) at another extension. You may override restrictions which have been set. To use this feature, an original extension number and an extension PIN (Personal Identification Number) are required. You can make a call by entering a verified code and verified code PIN. For the available verified code, ask your manager.

To call (Walking COS)

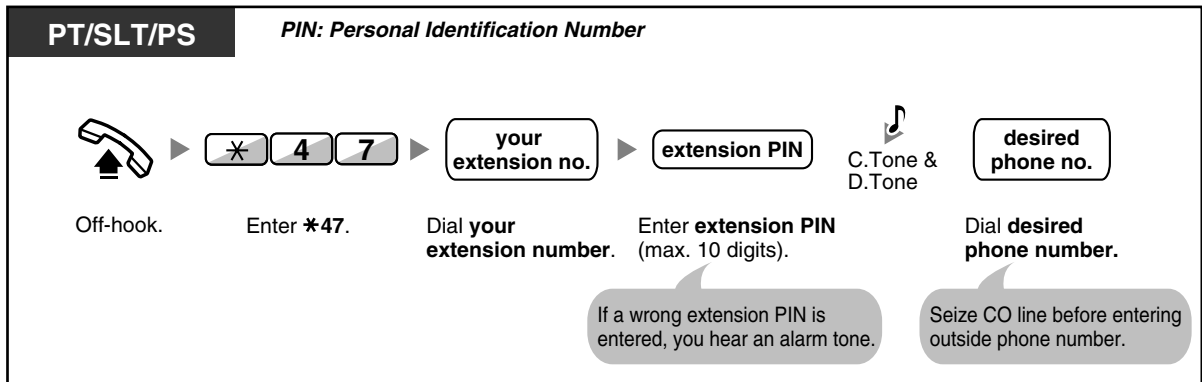

To call (Verified Code Entry)

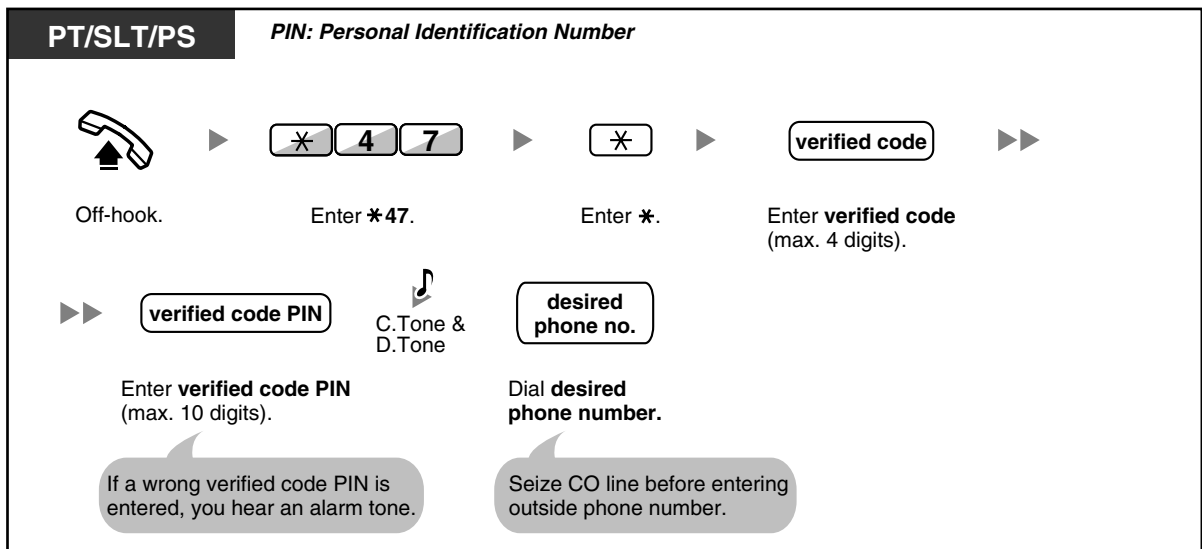

1.2.7 Direct Inward System Access (DISA)

— Calling through DISA

◆◆ Calling through DISA

When outside callers access extensions in the PBX, a prerecorded message greets the caller and gives information about how to access an extension. You do not need the operator's assistance.

You may be able to access system features or call an outside party with your password depending on the security mode. Ask your manager for the mode assigned to your PBX.

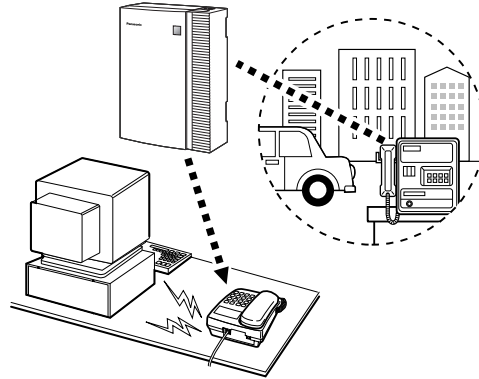

To call an extension

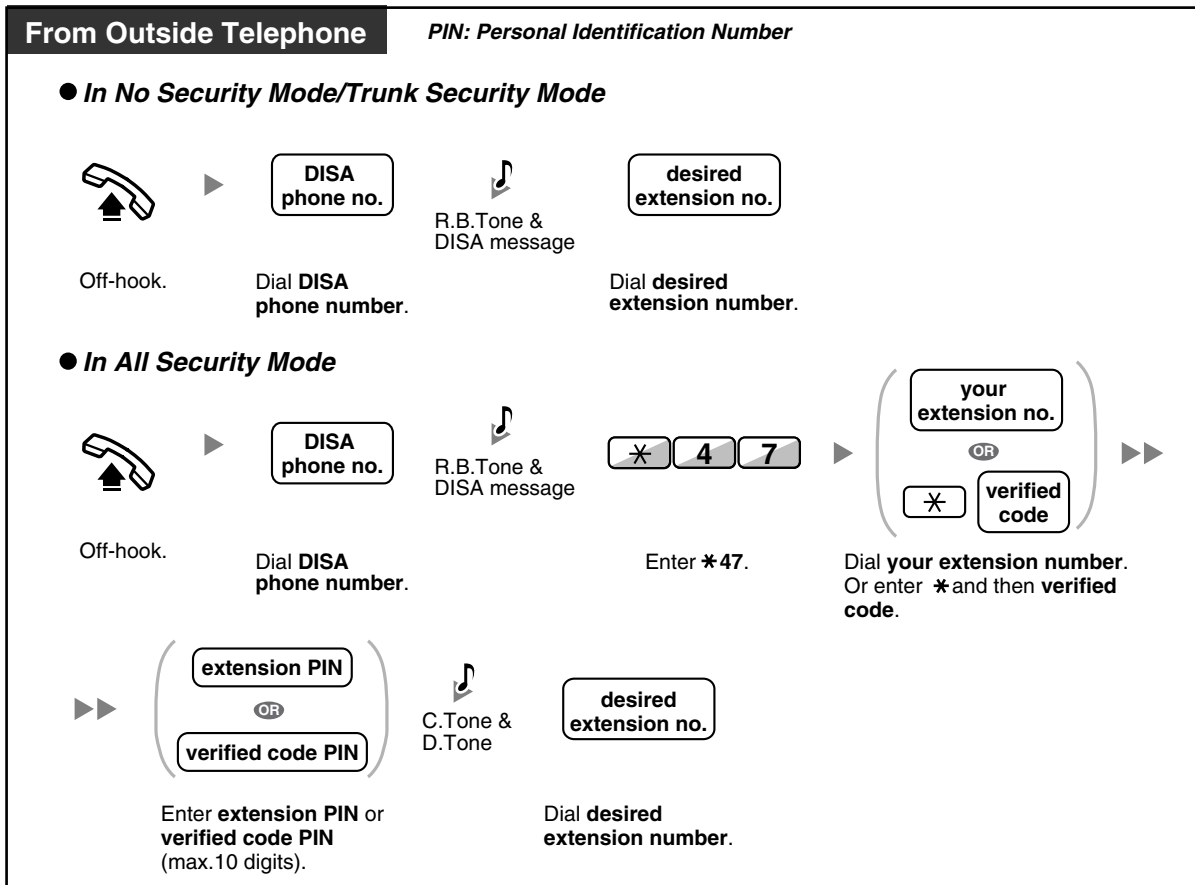

To call an outside party

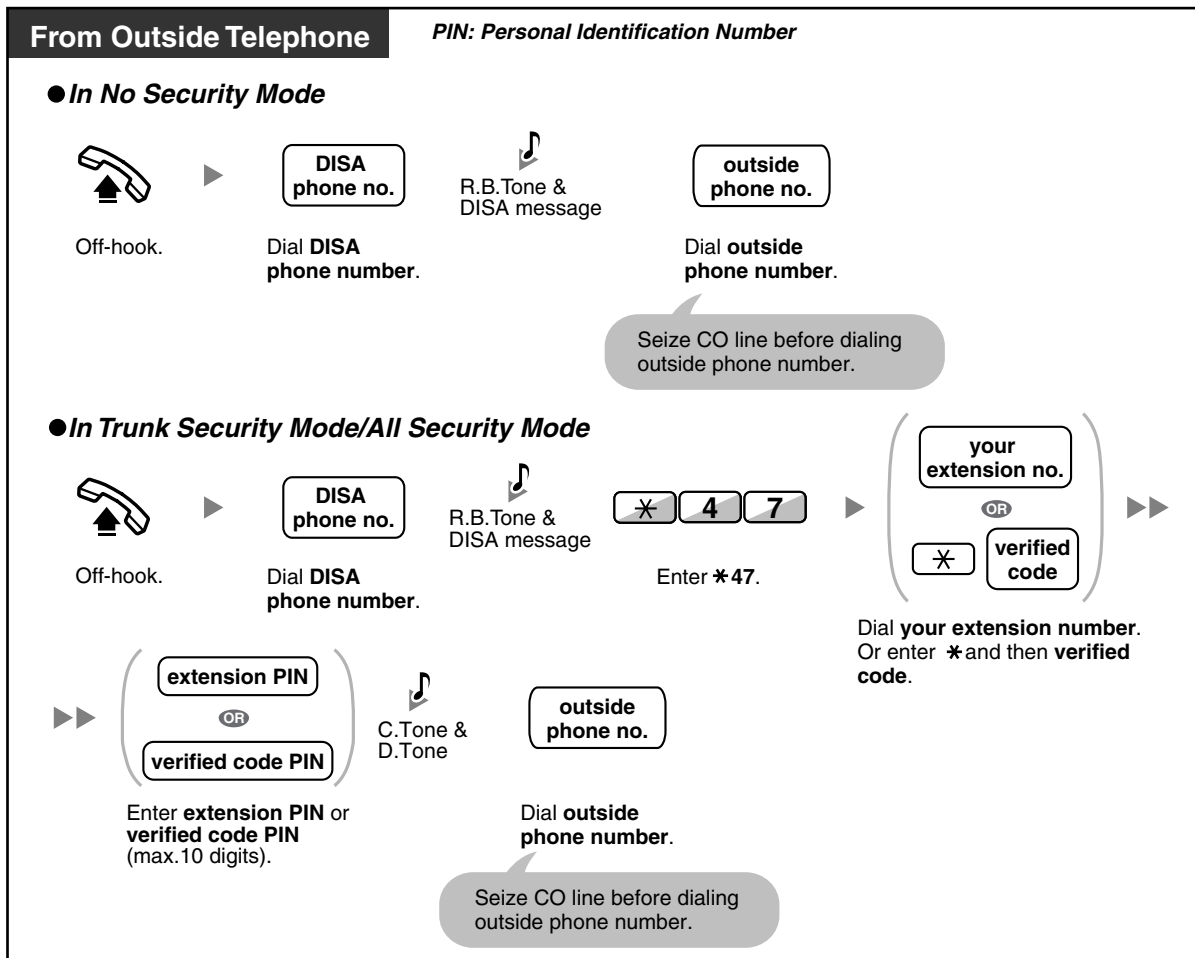

To retry

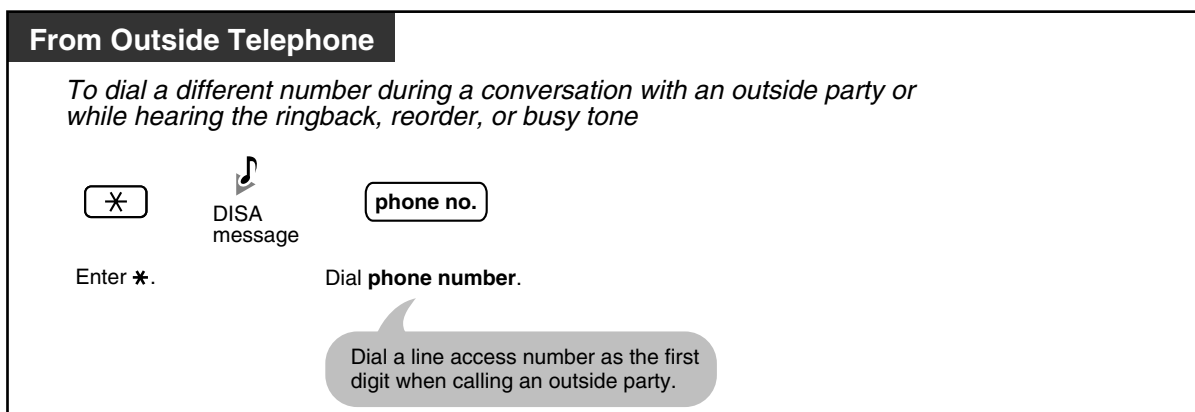



- **WARNING**
 When you enable the Outside-to-Outside Call feature of DISA, and a third party discovers the password (verified code PIN/extension PIN) of the PBX, there will be a risk that they will make fraudulent phone calls using the telephone line, and the cost will be charged to your own account. In order to avoid this problem, we strongly recommend the following points:
 - a) Carefully maintain the secrecy of the PIN.
 - b) Specify a complicated PIN as long and random as you can make it.
 - c) Change the PIN frequently.
- **Time limit**
 Both parties will hear an alarm tone fifteen seconds before the specified time limit. To extend, press any dial button except ✖.
- **If Built-in Automated Attendant service is set**, you can access the desired extension simply by pressing a single digit (0-9) from the options given the prerecorded message.

1.2.8 Remote Setting

You can set the following features on your telephone from another extension or through DISA.

- Call Forwarding (FWD)/Do Not Disturb (DND)
- Changing the Log-in/Log-out Status of Extensions
- Absent Message
- Extension Lock
- Time Service—Changing the Time Mode (Day/Night/Lunch/Break)

From another extension

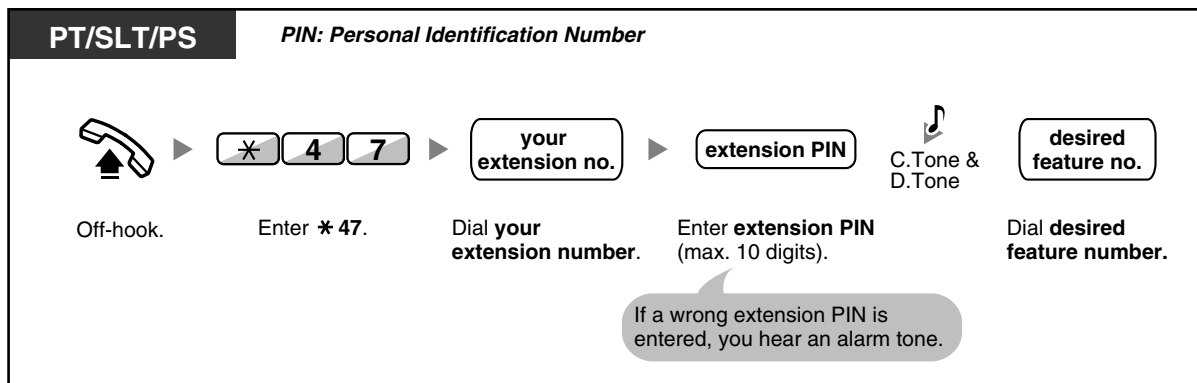

Through DISA

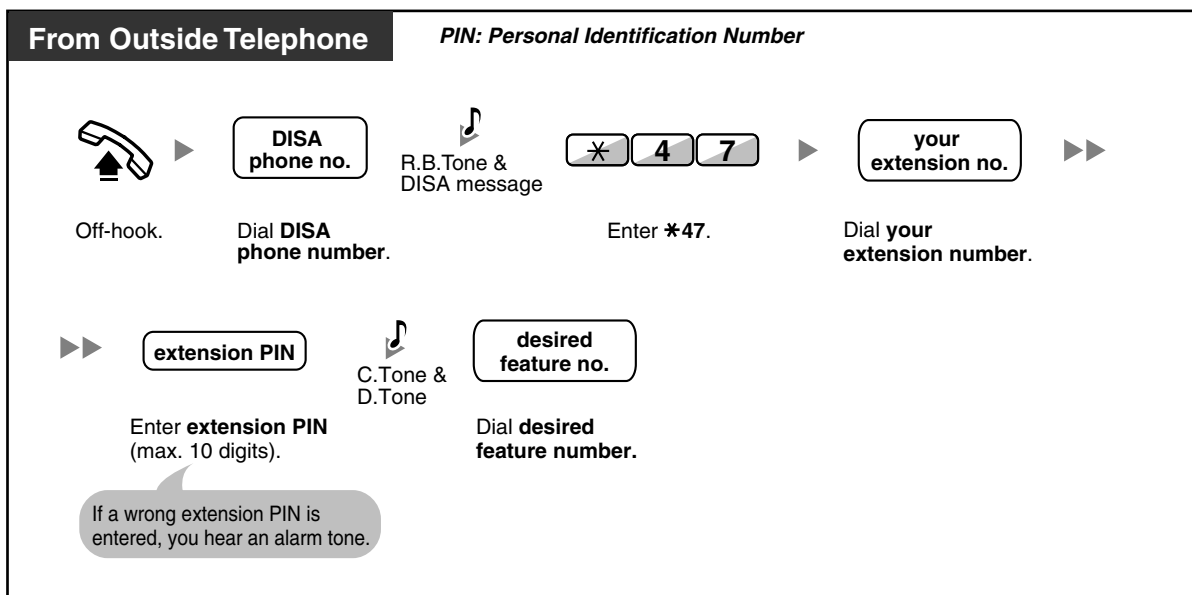

1.3 Receiving Calls

1.3.1 Answering Calls

PT/SLT/PS



Off-hook.

▶



Talk.

Select one of the following methods:

- Lift the handset to receive the preferred line. (Default: Ringing line is selected.)
- Press the SP-PHONE button.
- Press the flashing CO, INTERCOM or G-DN button directly.
- Press the ANSWER button.



- The G-DN button light shows the current status as follows:
 - Off:** Idle
 - Green on:** The line is in use. (You are using the line.)
 - Red on:** Your extension is in Log-out mode from the incoming call distribution group.



Customizing Your Phone

- 3.1.2 Settings on the Programming Mode—**Preferred Line Assignment—Incoming**
Select the seized line when going off hook.
- **Alternate Receiving—Ring/Voice**
Select the Calling method, either ring or the other party's voice.
- 3.1.3 Customizing the Buttons
Create or edit a Group Directory Number (G-DN) button.

1.3.2 Hands-free Answerback

You can answer an incoming call without going off-hook as soon as the line is connected. When an intercom call arrives, you will hear the caller talking without the phone ringing. When an outside call arrives, you will hear the caller talking after a preprogrammed number of rings. Hands-free Answerback for outside calls requires System Programming. Consult your dealer.



To set/cancel

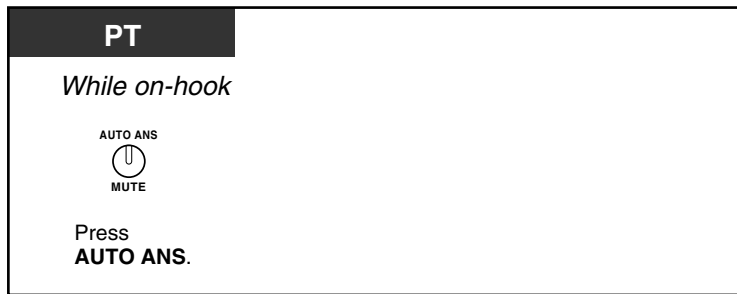

- The AUTO ANS button light shows the current status as follows:
 - Off:** Not set
 - On:** Set
- For a PS user, refer to "Operating Instructions" for PS.

1.3.3 Call Pickup

- Call Pickup
- Call Pickup Deny

◆◆ Call Pickup

You can answer an incoming call that is ringing at another extension or group from your phone without leaving your desk.

The following types of pickup are available:

Group Call Pickup: Picks up a call within your group.

Directed Call Pickup: Picks up a specified extension's call.

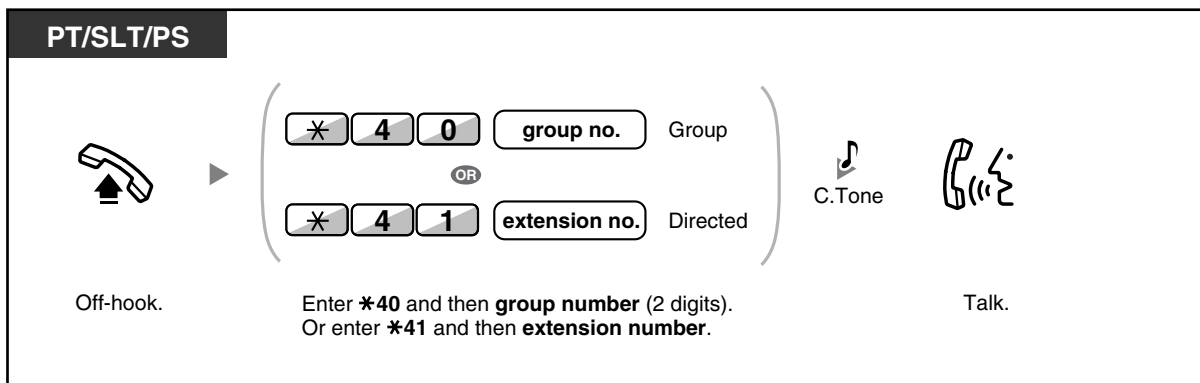

- If you receive a call waiting tone**, you can ask a third party to pick up your second call with Directed Call Pickup.
- If there are multiple incoming calls for the same group, the longest waiting call is received first.

◆◆ Call Pickup Deny

You can deny or allow other people to pick up your calls.

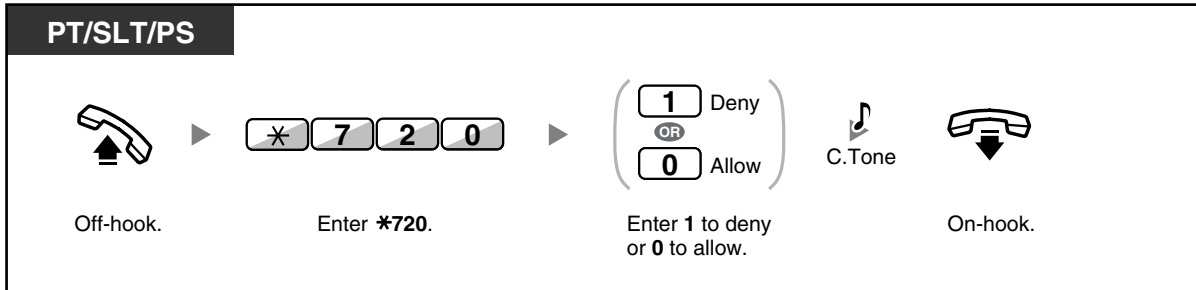

1.3.4 Trunk Answer From Any Station (TAFAS)

You can be notified of incoming outside calls through an external speaker. These calls can be answered from any extension.

Through an external speaker

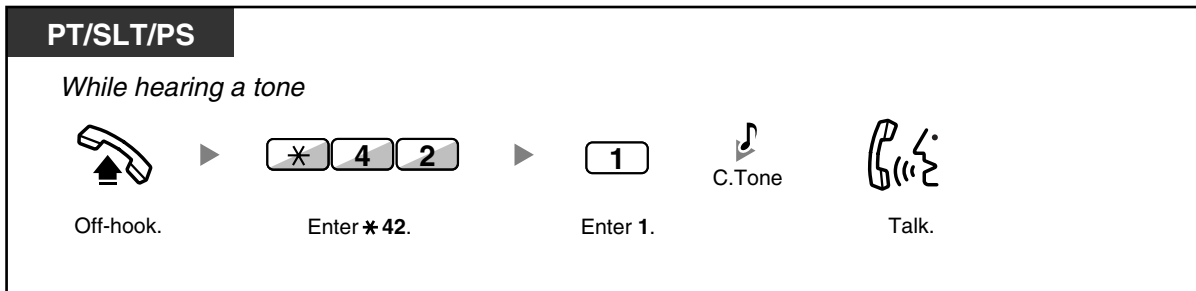

- You can also receive a paging announcement via a speaker with this operation.

1.3.5 ANSWER/RELEASE Button

The ANSWER and RELEASE buttons are convenient for operators using headsets.

With the ANSWER button, you can answer all incoming calls.

With the RELEASE button, you can disconnect the line during or after a conversation, or complete transferring a call.



To answer



To transfer a call

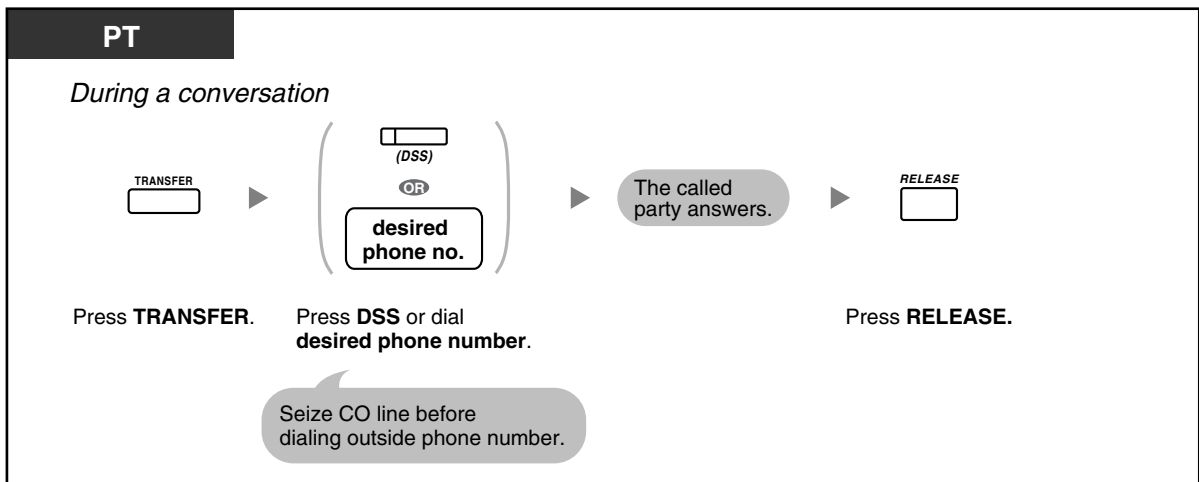

To talk to a waiting caller

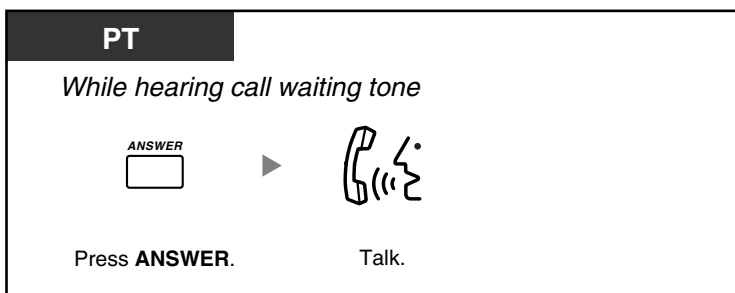

To transfer an outside call to an extension with a one-touch operation

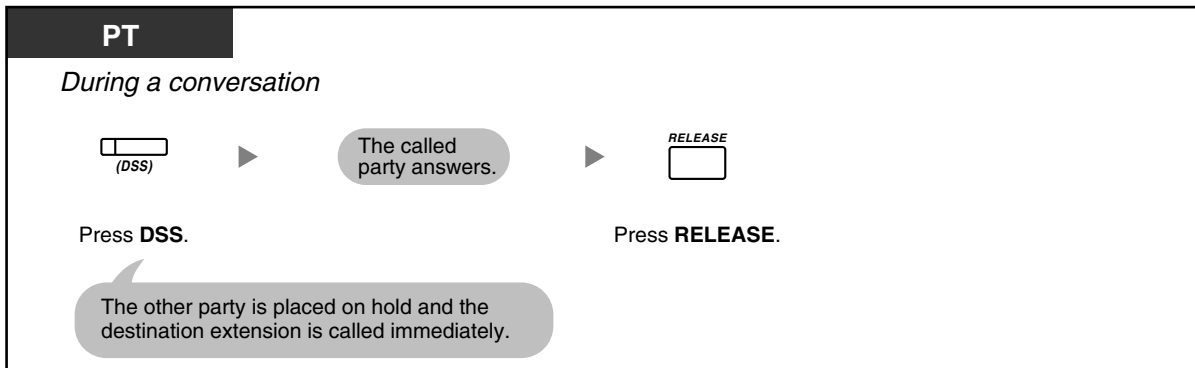

To end a conversation

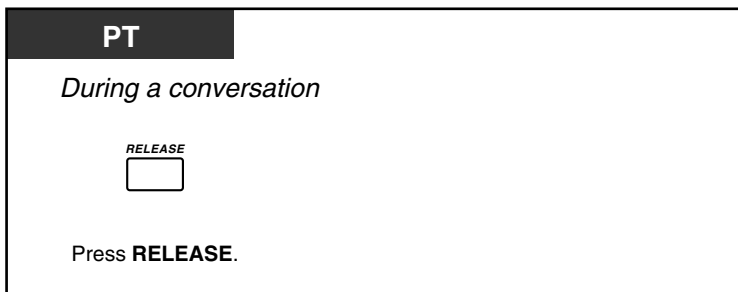

Customizing Your Phone

- 3.1.3 Customizing the Buttons
Create or edit an Answer button or a Release button.

1.4 During a Conversation

1.4.1 Call Transfer

- Transferring to an Extension on the PBX
- Transferring to an Outside Party Using the PBX Service



- You can transfer a held call without talking by going on-hook. If a call is not retrieved within a specified time, you will hear an alarm as a reminder. And, if an outside call is not answered within a specified time, it is automatically disconnected.
- **If you hear an alarm tone**, the destination extension did not answer the call. Answer the call.

◆◆ Transferring to an Extension on the PBX

To transfer

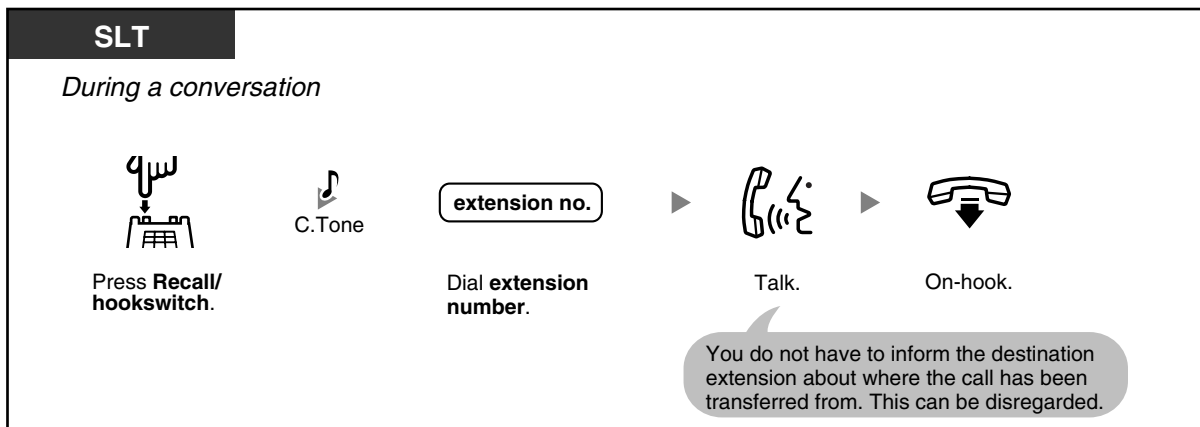
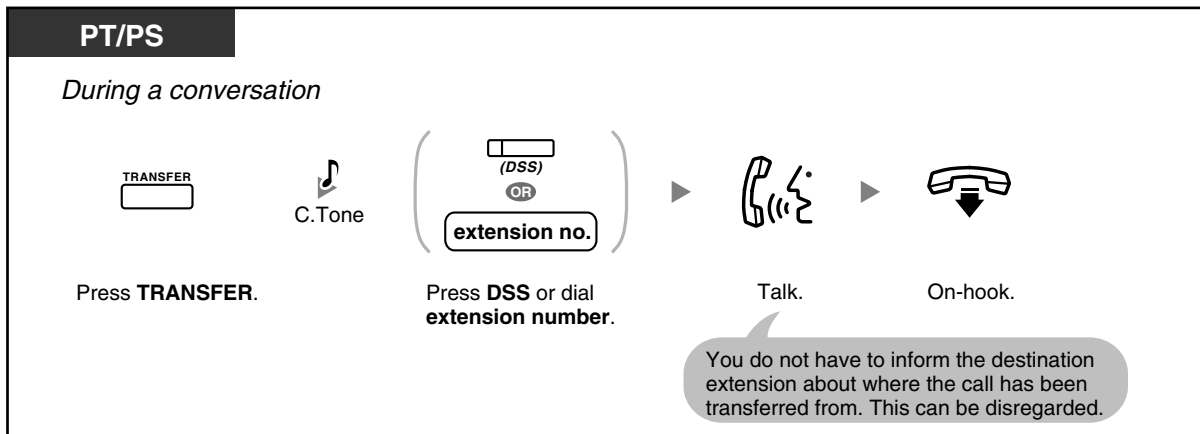

To transfer with one-touch (One-touch Transfer)

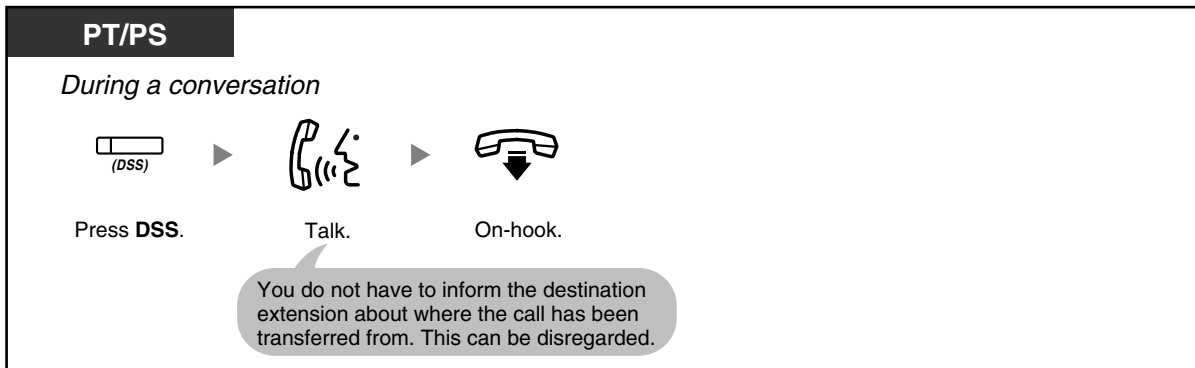

- Even if the transferred party does not answer, you can go on-hook.

◆◆ Transferring to an Outside Party Using the PBX Service

Some extensions may be restricted from performing this feature.

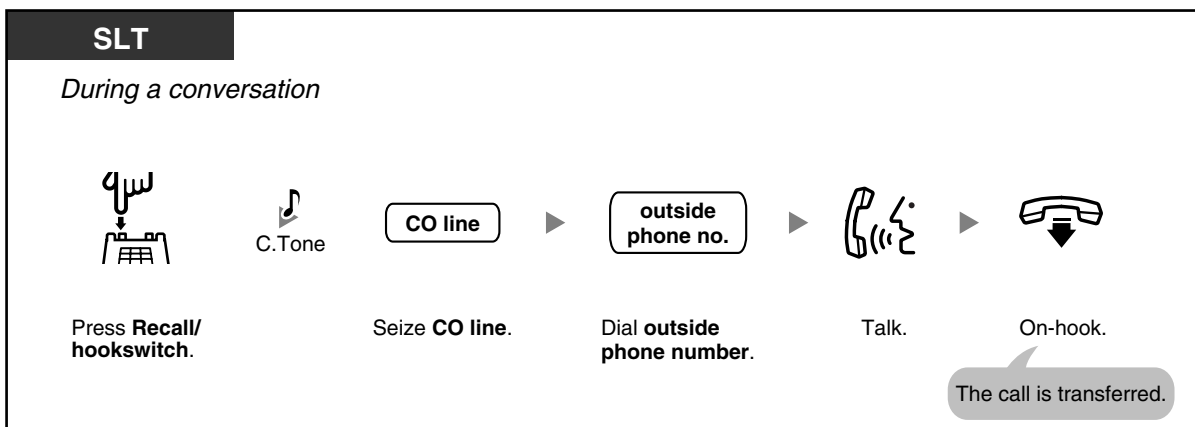
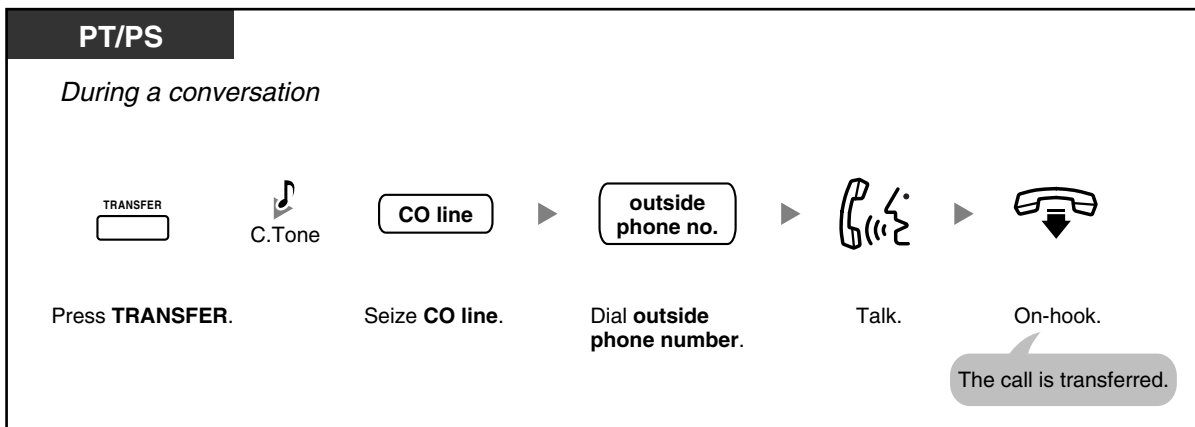



- **Time limit**
Both the caller and the transferred party will hear an alarm tone fifteen seconds before a specified time period.
- **To return to the held call before the destination answers**, press the TRANSFER button, corresponding CO, G-DN or INTERCOM button, or the hookswitch.



Customizing Your Phone

- 3.1.3 Customizing the Buttons
Create or edit a Direct Station Selection (DSS) button.

1.4.2 Call Hold

- Call Hold
- Call Park



- **If a call is not retrieved within a specified time**, you will hear an alarm as a reminder. And, if an outside call is not answered within a specified time, it is automatically disconnected.

◆◆ Call Hold

There are two types of hold. The difference between them is that other people can retrieve your held call (Regular Hold) or not (Exclusive Call Hold). As they can be alternated, ask your manager what the current mode is.

Call Hold

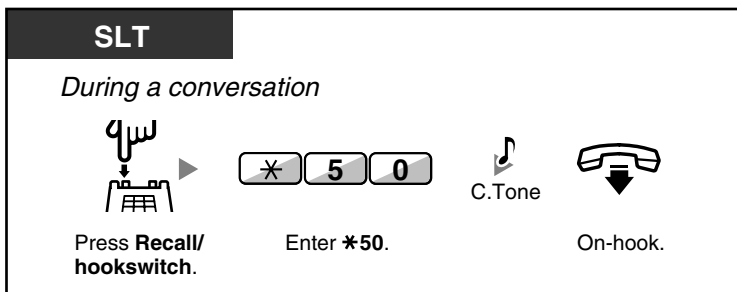
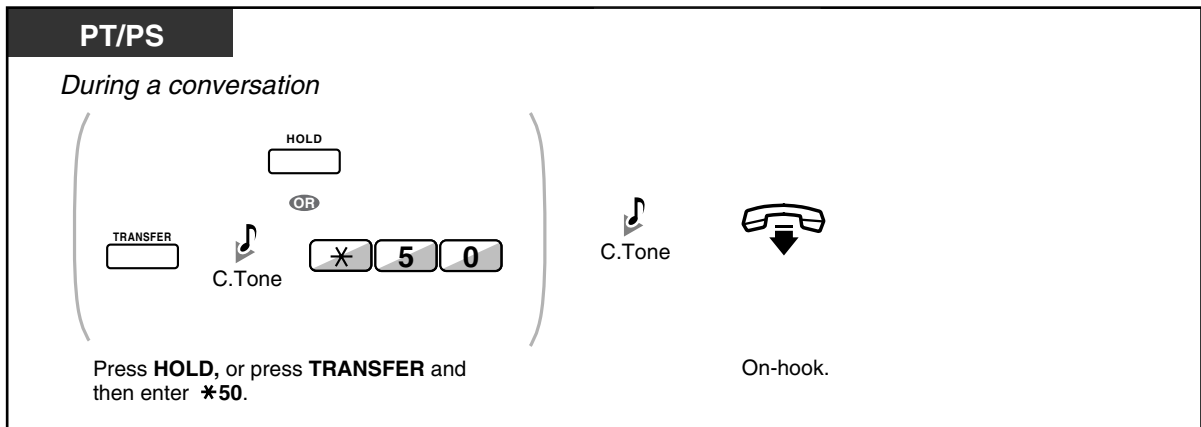

Call Hold Retrieve

PT/SLT/PS

- **At the holding extension (Call Hold Retrieve)**

Off-hook. Press flashing **CO** or **INTERCOM**, or enter *** 50**. Talk.
- **To retrieve an outside call from another extension—only Regular Hold (Call Hold Retrieve—Specified with a held line number)**

Off-hook. Press **CO**, or enter ***53** and then **held line number** (3 digits). C.Tone Talk.
- **To retrieve an intercom call or outside call from another extension—only Regular Hold (Call Hold Retrieve—Specified with a holding extension number)**

Off-hook. Enter ***51**. Press **DSS** or dial **holding extension number**. C.Tone Talk.



- The CO or INTERCOM button light shows the current status as follows:

 - Regular Hold mode
 - Flashing green slowly:** Your held call
 - Flashing red:** Another extension's held call
 - Exclusive Call Hold mode
 - Flashing green rapidly:** Your held call
 - Red on:** Another extension's held call
- **Hold Mode Change (PT only)**

After pressing the HOLD button, if you press the HOLD button again, the status switches from the Regular Hold mode to the Exclusive Call Hold mode or from the Exclusive Call Hold mode to the Regular Hold mode.



- **For simple operation**, you can automatically hold a call by pressing another CO, G-DN or INTERCOM button, only if preprogrammed. **(Automatic Call Hold)** Consult your dealer.

◆◆ Call Park

You can put a call on hold in a common parking zone of the PBX so that any extension can retrieve the parked call. You can use this feature as a transferring feature.

A call can be put into either a specified parking zone (Specified) or any idle parking zone (Auto). If a Call Park button and Call Park (Automatic Park Zone) button have been established, you can select either way to park by simply pressing the corresponding button.

When a call is parked automatically, or more than one call has been parked at the same time, you need to specify the parking zone number to retrieve the required call.

To set

PT/PS

During a conversation

(Call Park)

Press **Call Park**.

PT/PS

During a conversation

Press **TRANSFER**.

Enter ***52**.

parking zone no.

 Specified
 OR

*

 Auto

C.Tone

On-hook.

Enter a specified **parking zone number** (2 digits) or press ***** to park at an idle parking zone automatically.

If you hear a busy tone, enter another parking zone number or press ***** again.

SLT

During a conversation

Press **Recall/hookswitch**.

Enter ***52**.

parking zone no.

C.Tone

On-hook.

Enter a specified **parking zone number** (2 digits).

If you hear a busy tone, enter another parking zone number.

Call Park Retrieve

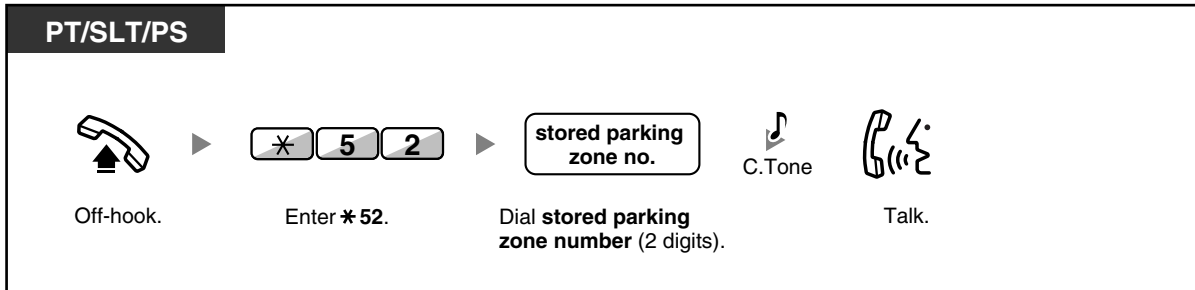
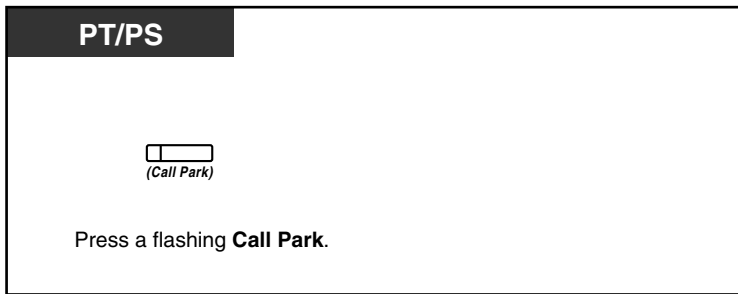

- If a call is parked automatically, confirm the parking zone number on the display.



- **If you hear a reorder tone when retrieving a parked call**, there is no held call. Confirm the stored parking zone number.
- After you park a call, you can perform other operations.



Customizing Your Phone

- 3.1.3 Customizing the Buttons
Create or edit a Call Park button or Call Park (Automatic Park Zone) button.

1.4.3 Call Splitting

When talking to one party while the other party is on hold, you can swap the calls back and forth (alternately).

To alternate between the parties leaving one party on hold temporarily

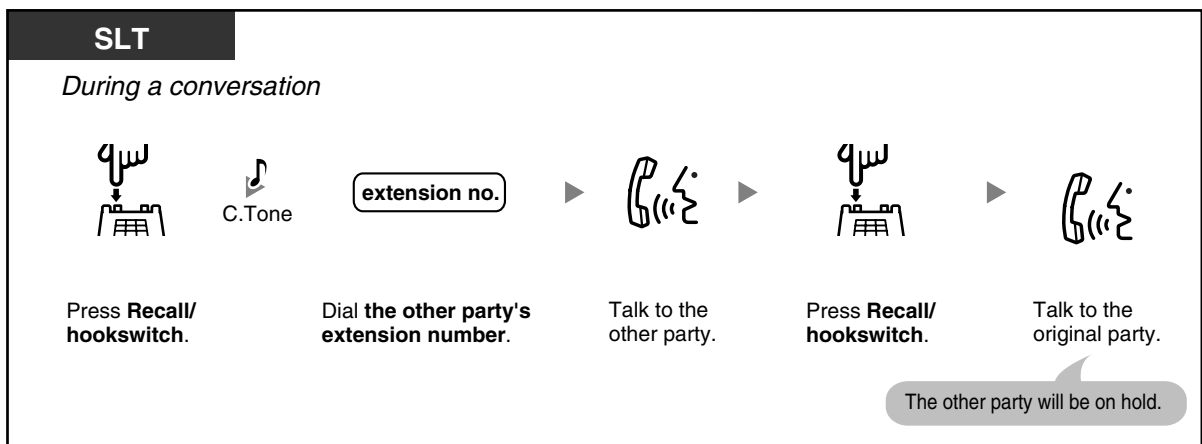
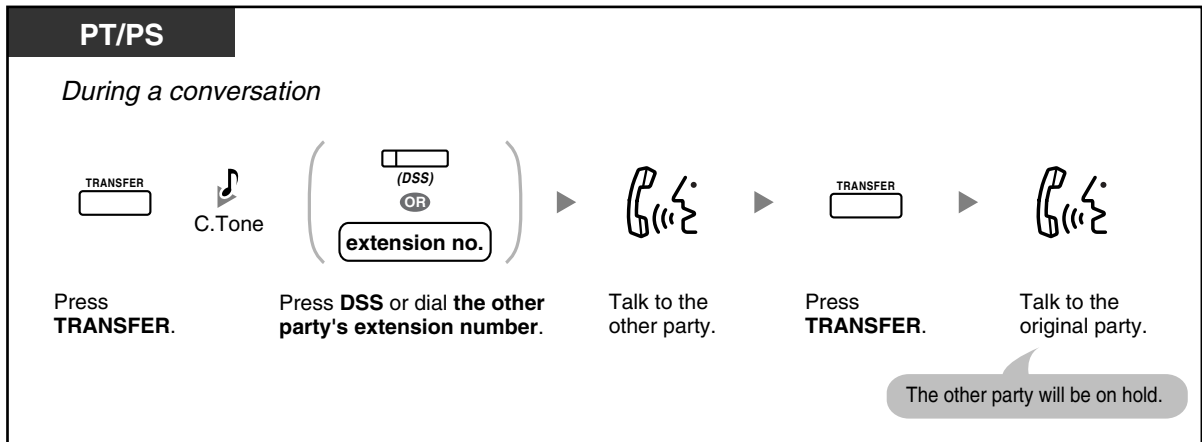

To leave the conversation and then let the two parties talk

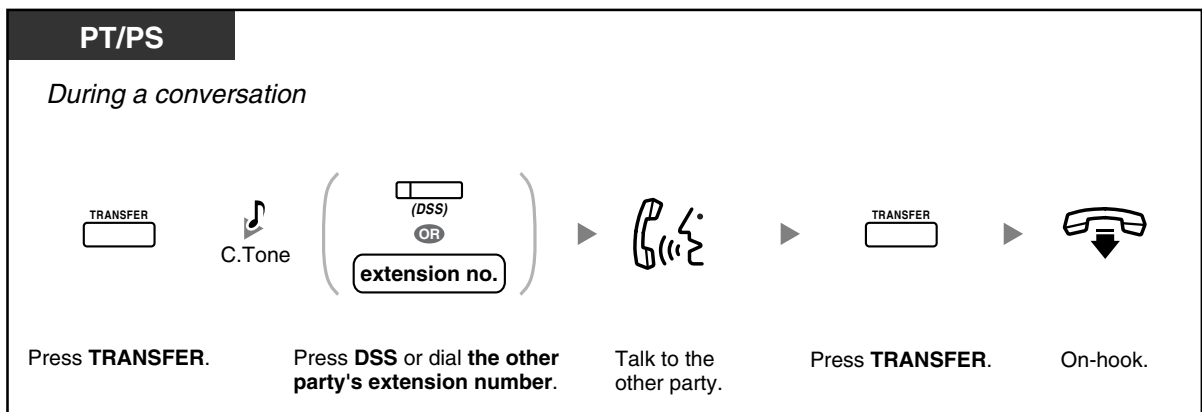

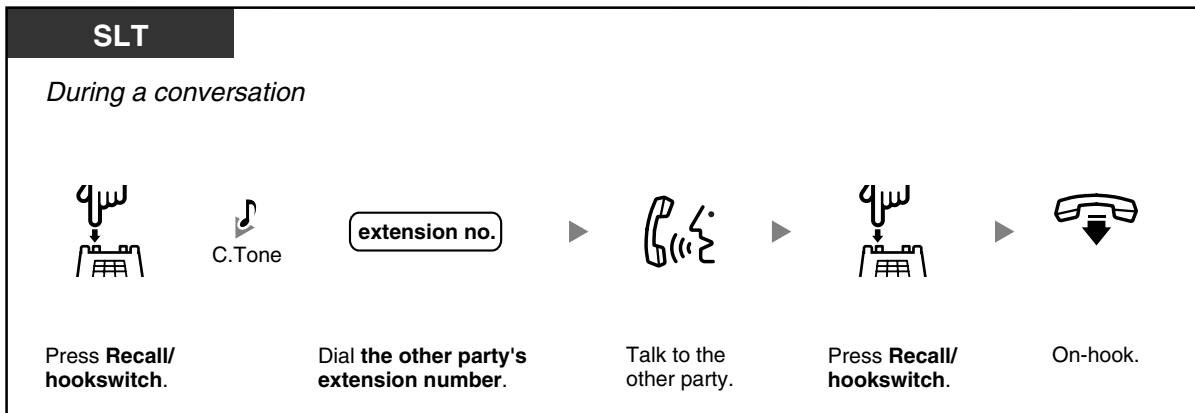

1.4.4 Call Waiting

- Answering Call Waiting in the PBX
- Answering Call Waiting from the Telephone Company

◆◆ Answering Call Waiting in the PBX

During a conversation, a call waiting tone or voice announcement through the speaker or the handset occurs when an outside call has been received or another extension is letting you know a call is waiting. You must activate this feature to use it. (Default: Enable—Tone)

You can answer the second call by disconnecting (1) or holding (2) the current call.

1. To disconnect the current call and then talk to the new party

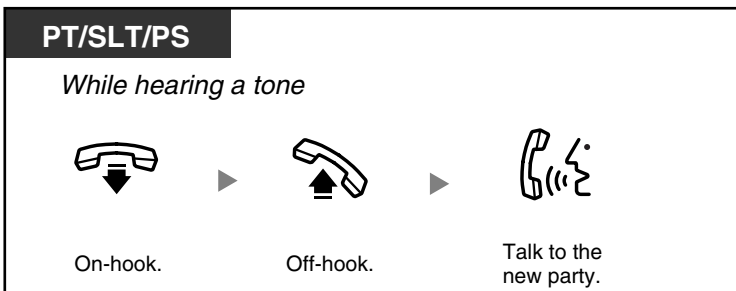

2. To hold the current call and then talk to the new party

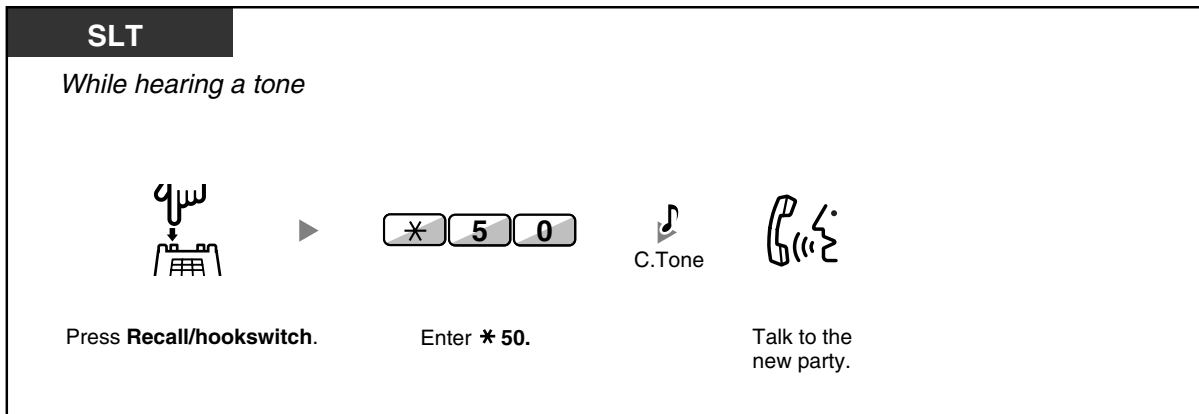
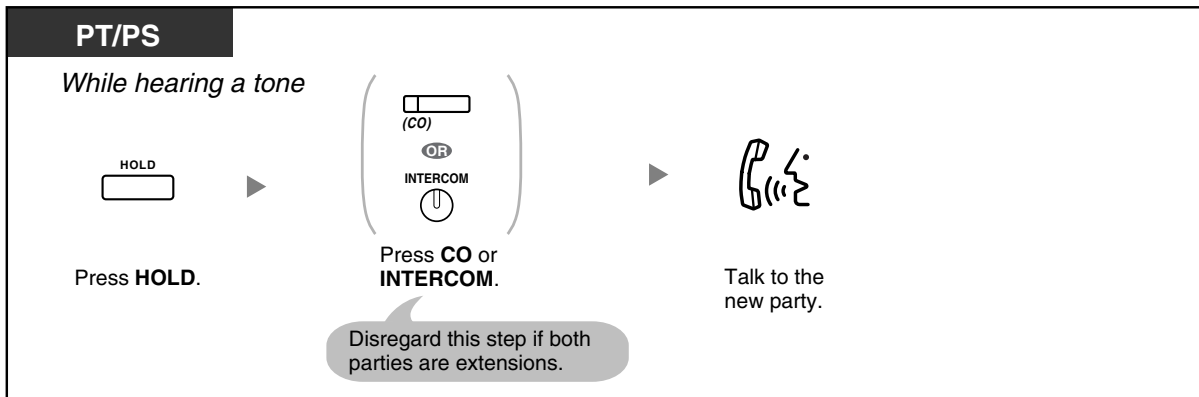

After talking to the new party (second call), you can disconnect (2.1) or hold (2.2) it and then retrieve the first call.

2.1 To disconnect the second call and then talk to the original party

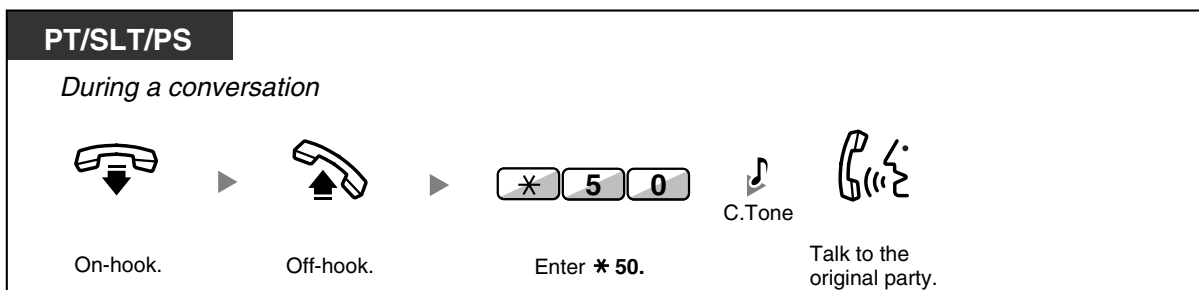
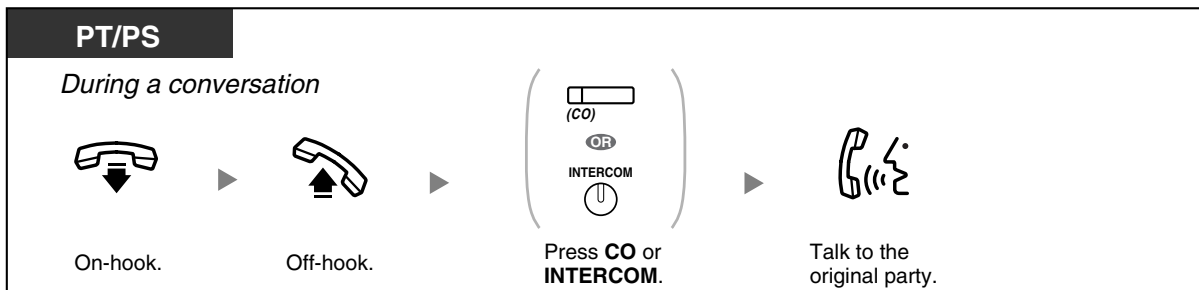

2.2 To hold the second call and then talk to the original party

After holding it, you can talk to the original party. Then, you can disconnect it and then talk to the new party again.

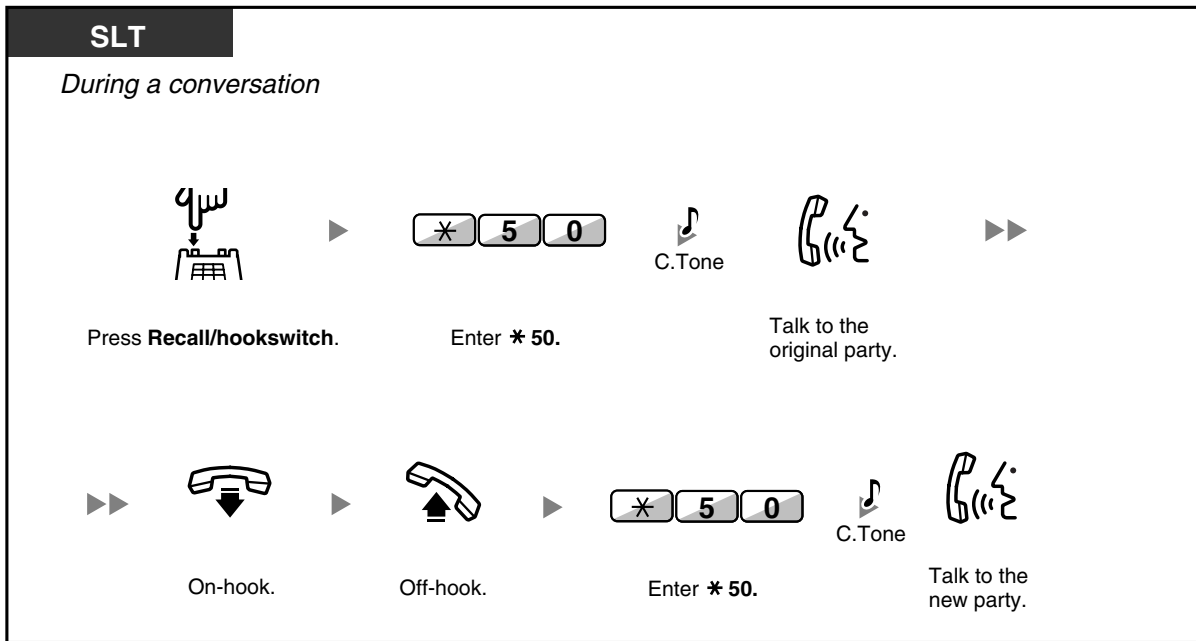
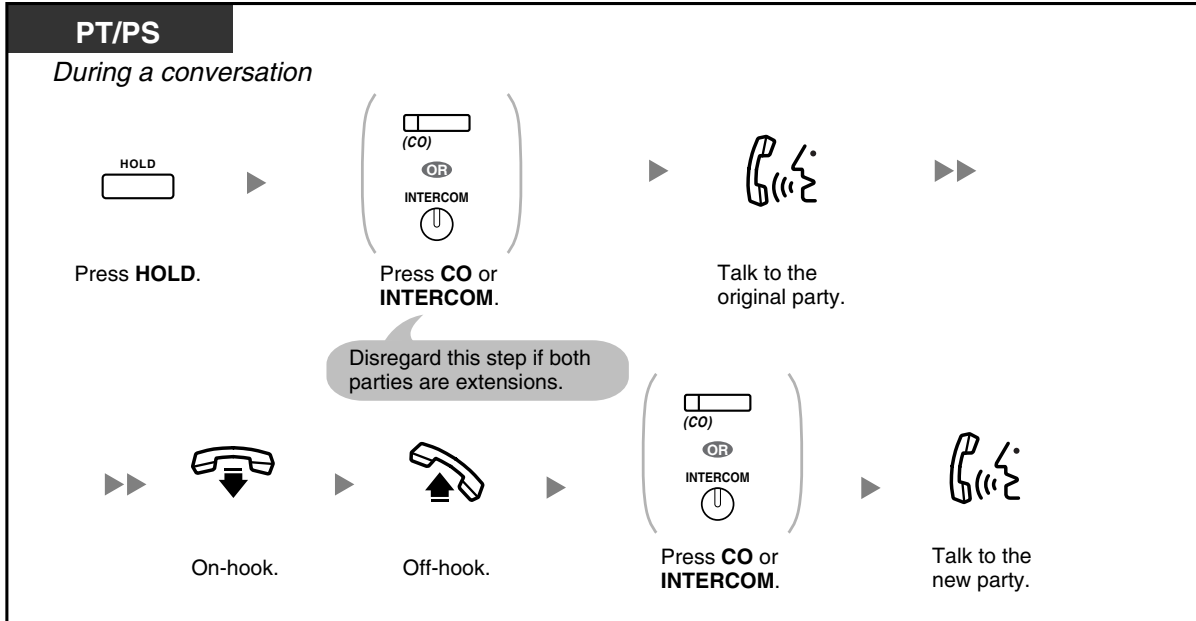

- **Depending on your telephone**, the "Off-hook Call Announcement (OHCA)" and the "Whisper OHCA" features can be used. You can talk to the other party through the speaker and the microphone (OHCA) or you can receive an announcement through the handset (Whisper OHCA), if you are having a conversation using the handset. Refer to "1.7.3 Call Waiting/Off-hook Call Announcement (OHCA)/Whisper OHCA".
- The caller's name or number is displayed for five seconds in ten second intervals while waiting to be answered.



Customizing Your Phone

- 3.1.2 Settings on the Programming Mode—**Call Waiting Tone Type Selection**
If you select "Tone 1", you will hear the same tone for Call Waiting from an outside party and an extension. If you select "Tone 2", you will hear different tones for Call Waiting from an outside party and an extension.

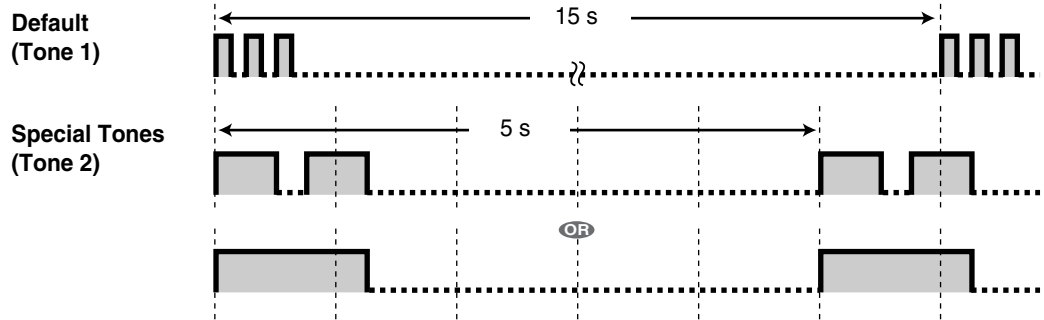

Answering Call Waiting from the Telephone Company

This is an optional telephone company service. You can receive a call waiting tone and the caller's telephone number information. (The caller's name will not be received.) For details, consult your telephone company.

PT/PS	PT/SLT/PS
<p><i>While hearing a tone</i></p> <div style="display: flex; align-items: center; justify-content: center;"> <div style="border: 1px solid black; padding: 5px; margin: 5px;">FLASH/ RECALL</div> <div style="margin: 0 10px;">OR</div> <div style="border: 1px solid black; padding: 5px; margin: 5px;">(EFA)</div> </div> <p>Press FLASH/RECALL or EFA.</p>	<p><i>While hearing a tone</i></p> <div style="display: flex; align-items: center; justify-content: center;"> <div style="border: 1px solid black; padding: 5px; margin: 5px;">TRANSFER</div> <div style="margin: 0 10px;">OR</div> <div style="text-align: center;"> </div> </div> <p>Press TRANSFER or Recall/hookswitch.</p> <div style="display: flex; align-items: center; justify-content: center; margin-top: 10px;"> <div style="margin-right: 10px;">▶</div> <div style="border: 1px solid black; padding: 2px 10px;">* 6 0</div> </div> <p>Enter *60.</p>



- To return to the original party, repeat the operation.
- In this case, FLASH/RECALL button on proprietary telephones is in the External Feature Access (EFA) mode.
- The caller's telephone number will not be displayed on telephones or wireless phones connected to SLT ports.



Customizing Your Phone

- 3.1.3 Customizing the Buttons
Create or edit an External Feature Access (EFA) button.

1.4.5 Multiple Party Conversation

- Conference
- Unattended Conference
- Leaving 3 Parties Conference

— Privacy Release

◆◆ Conference

You can add one or more parties to your conversation.

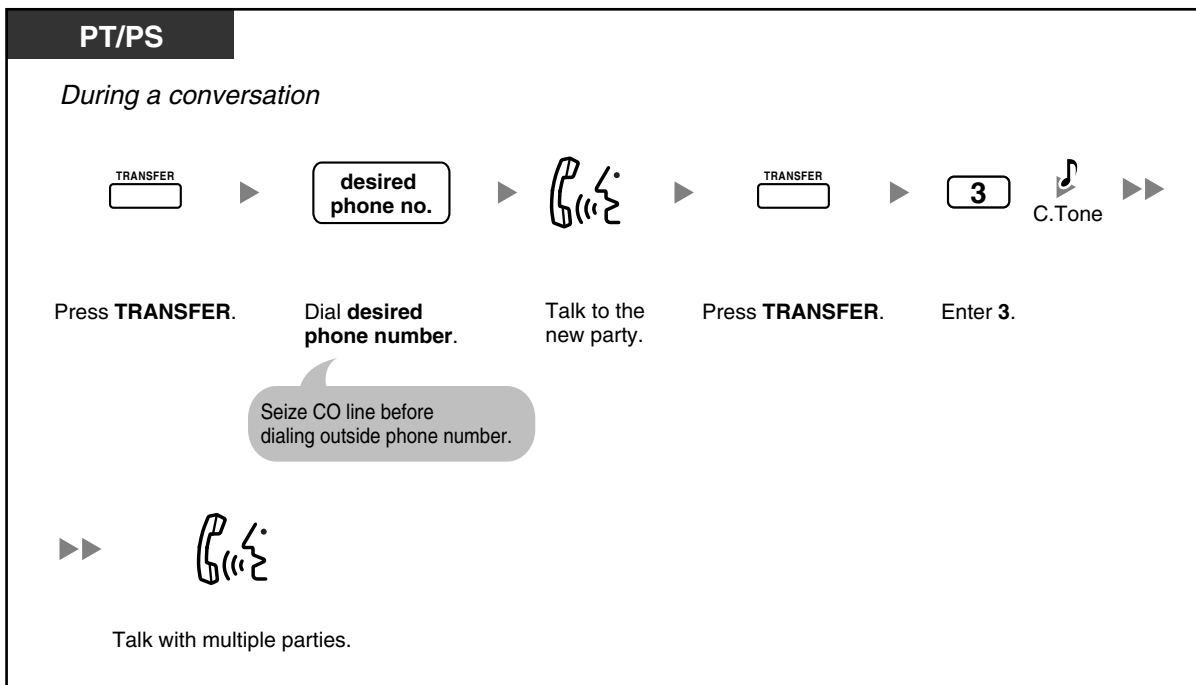
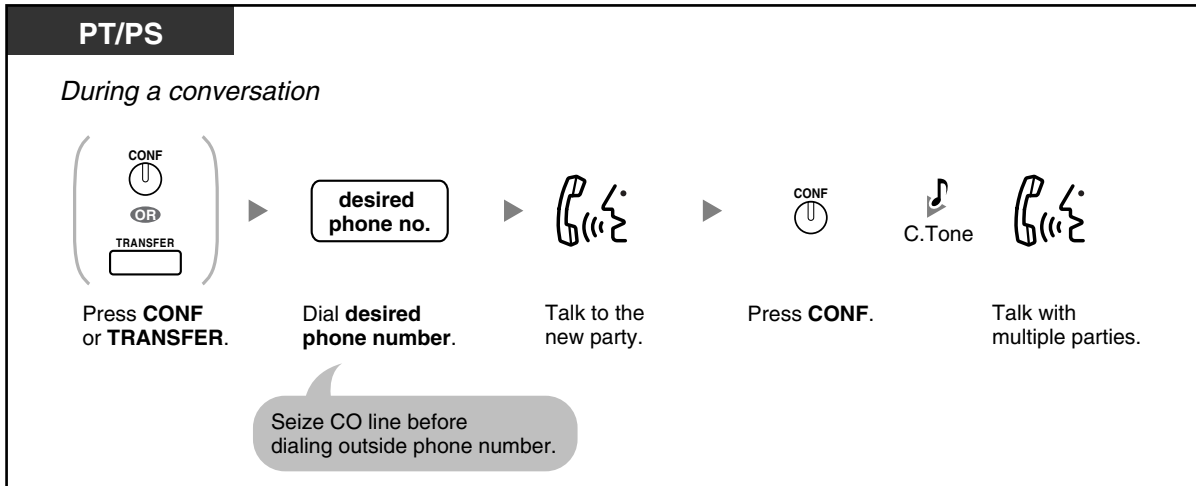

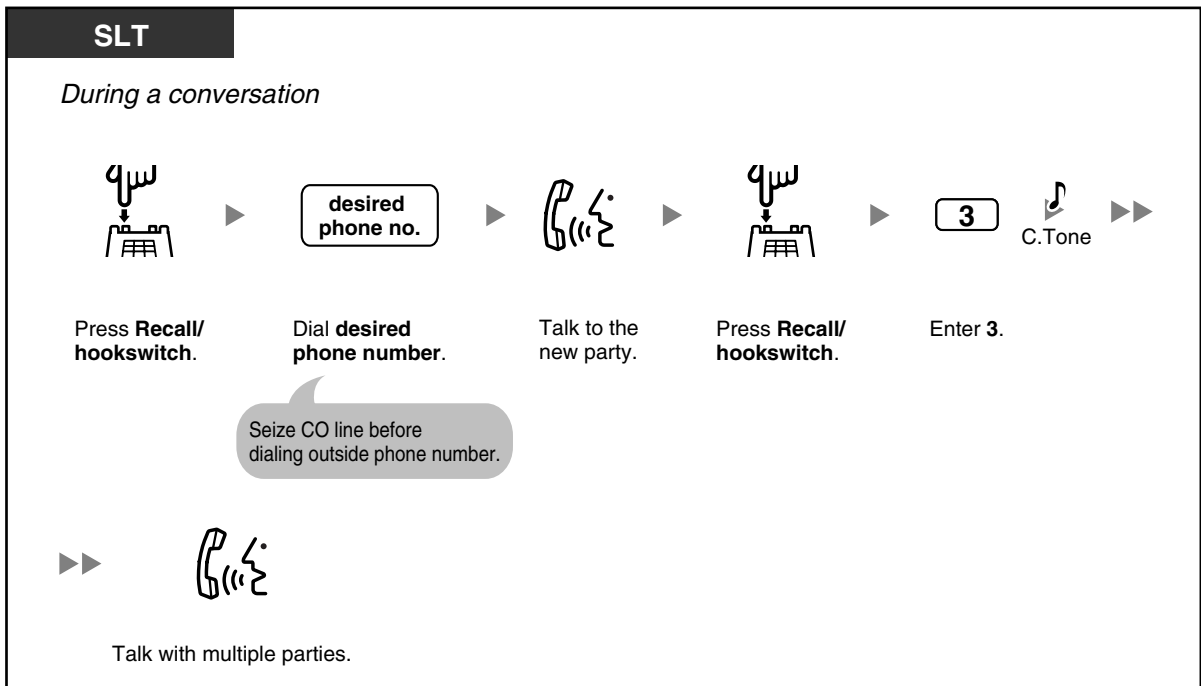

To add four or more parties to a conference

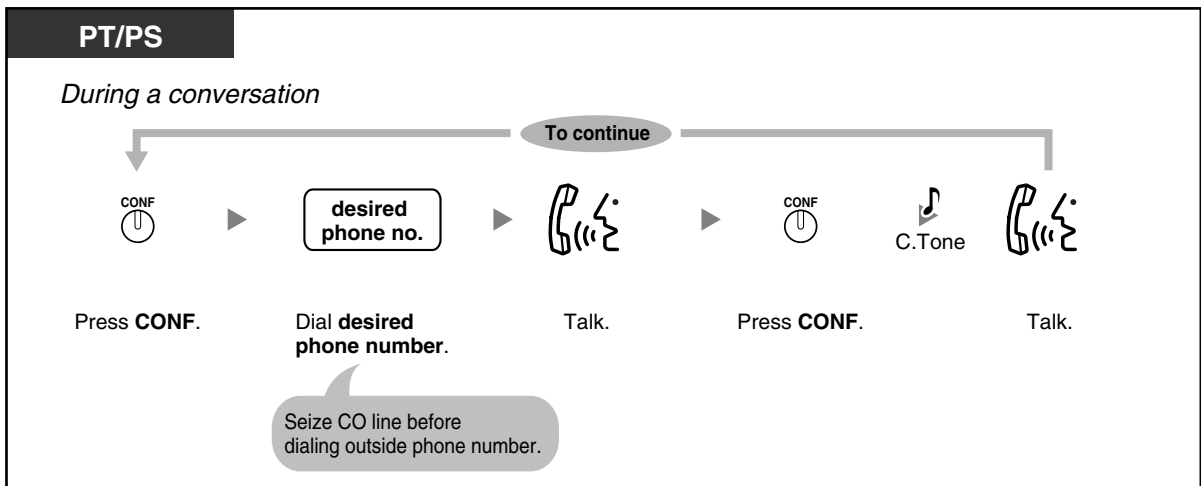

To talk alternately on three-party conversation



SLT

During a conversation



Press **Recall/hookswitch**.



- During a three-party conversation, when you press TRANSFER, Recall/hookswitch, you can talk to the party who had a conversation previously. If you want to talk to the third party, press TRANSFER, Recall/hookswitch again.
- You can have a conference with maximum eight parties (comprising intercom or CO lines) simultaneously.



Customizing Your Phone

- 3.1.3 Customizing the Buttons
Create or edit a Conference button.

◆◆ Unattended Conference

The other parties can continue their conversation.

To leave a conference

PT/PS

During 3- to 7-party conference



Press **CONF**. On-hook.

To return while others are talking

PT

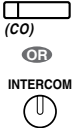

Press flashing green **CO** or **INTERCOM**.

To complete a conversation

PT/SLT/PS

During a conversation



On-hook.



- **Time limit**

Both parties will hear an alarm tone before a specified timeout. The originating extension will hear an alarm tone before timeout. The call is disconnected when the time runs out unless the originating extension returns to the conference.



- **Customizing Your Phone**

- 3.1.3 Customizing the Buttons
Create or edit a Conference button.

◆◆ Leaving 3 Parties Conference

The other two parties can continue their conversation.

To leave a conference

PT/PS

During 3-party conference

TRANSFER

▶



Press **TRANSFER**. On-hook.

SLT

During 3-party conference



▶



Press **Recall/hookswitch**. On-hook.

To complete a conversation

PT/SLT/PS

During a conversation



On-hook.

◆◆ Privacy Release

You can let a third party join your current outside call.



To set

PT/PS

During a conversation



Press green **S-CO**.

Ask the third party to perform the step below.

⋮



Press flashing green **S-CO** within 5 seconds.

To prolong, press **S-CO** again.



C.Tone



Talk.

A three-party conversation is now established.



- Only an S-CO button can be used for this operation.

1.4.6 Mute

You can disable the microphone or the handset to consult privately with others in the room while listening to the other party on the phone through the speaker or the handset.

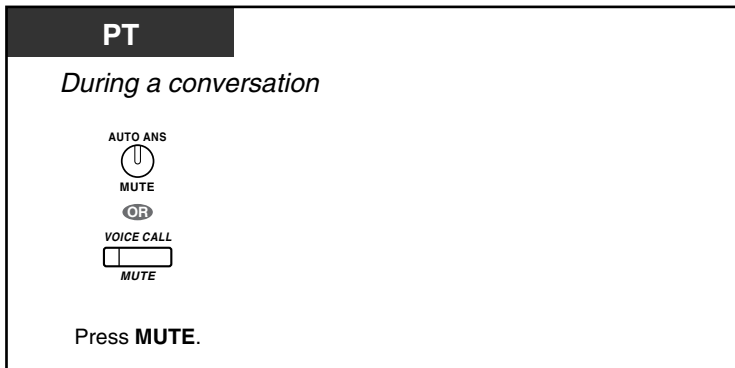

To set/cancel

- The AUTO ANS/MUTE or VOICE CALL/MUTE button light shows the current status as follows:
 - Off:** Normal
 - Flashing red:** Mute
- If mute is used during OHCA, it will become Handset Mute.

1.4.7 Off-hook Monitor

You can let other people in the room listen to the conversation through the speaker while continuing the conversation using the handset.

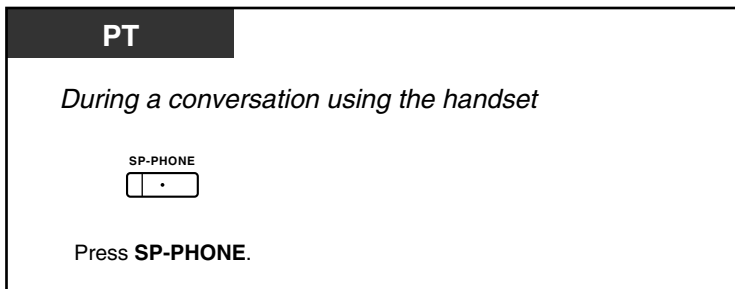
**To set/cancel**

- The SP-PHONE button light shows the current status as follows:
 - Off:** The voice is heard through the handset.
 - On:** The voice is heard through the speaker and the handset.
- This feature is controlled work by programming. Ask your manager.
- This feature may not be available with certain proprietary telephones. For more details, consult your dealer.



- **Hands-free operation**

You can have a conversation in hands-free mode using the SP-PHONE button. You can perform other tasks simultaneously.

Helpful hints for hands-free operation:

- **If it is difficult to hear the other party's voice;**
Raise the sound level using the Speaker Volume Control.
- **If the other party has difficulty hearing you;**
Lower the sound level.
- **Absorbing echoes;**
Using this unit in a room which has curtains or carpeting or both.
- **To avoid missing part of the conversations;**
If you and the other party speak at the same time, parts of your conversation will be lost. To avoid this, speak alternately.

1.4.8 Headset Operation

You can have a conversation using a headset.

In this case, you must select "Headset on" in programming mode or set the Headset button on (red) in advance.

This feature is also known as Handset/Headset Selection.



To talk using the headset

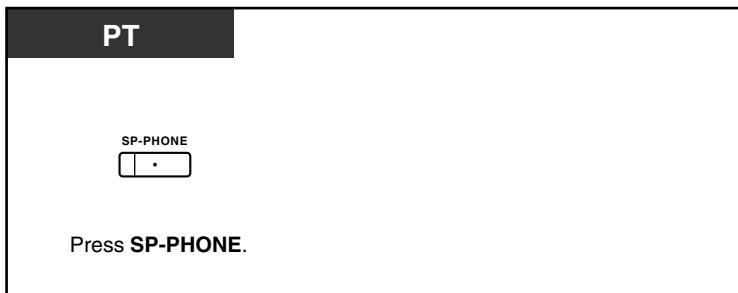

To use the handset during a conversation using the headset



To talk in hands-free mode during a conversation using the headset



- The Headset button light shows the current status as follows:
Off: Headset mode off
Red on: Headset mode on



Customizing Your Phone

- 3.1.2 Settings on the Programming Mode—**Headset Operation**
Select the equipment to use.
- 3.1.3 Customizing the Buttons
Create or edit a Headset button.

1.5 Absence Settings

1.5.1 Call Forwarding

— Call Forwarding (FWD)

◆◆ Call Forwarding (FWD)

You can have your incoming calls forwarded to a specified destination.

All Calls:

All calls are forwarded. Preset extensions may also forward from their own receiving group.

Busy:

All calls are forwarded when your extension is busy.

No Answer:

All calls are forwarded when you do not answer the call within a specified time period.

Busy/No Answer (BSY/NA):

All calls are forwarded when you do not answer within a specified time period or when your extension is busy.

Follow Me (From):

If you fail to set the above-mentioned "All Calls" to forward before you leave your desk, you can set the same feature from the destination extension.

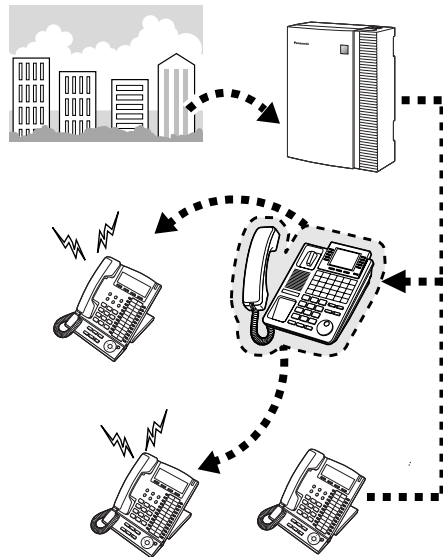

- You can set the voice mail floating extension number as a forward destination to receive calls into your mailbox.
- You can set your mobile telephone as the forward destination. The voice mail can be used to receive calls if you are unable to answer.
- Incoming calls can be forwarded up to four times.
- **Boss & Secretary feature**
The extension which has been set as the destination can call the forwarding extension.

<Example>

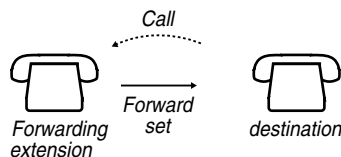

To set/cancel

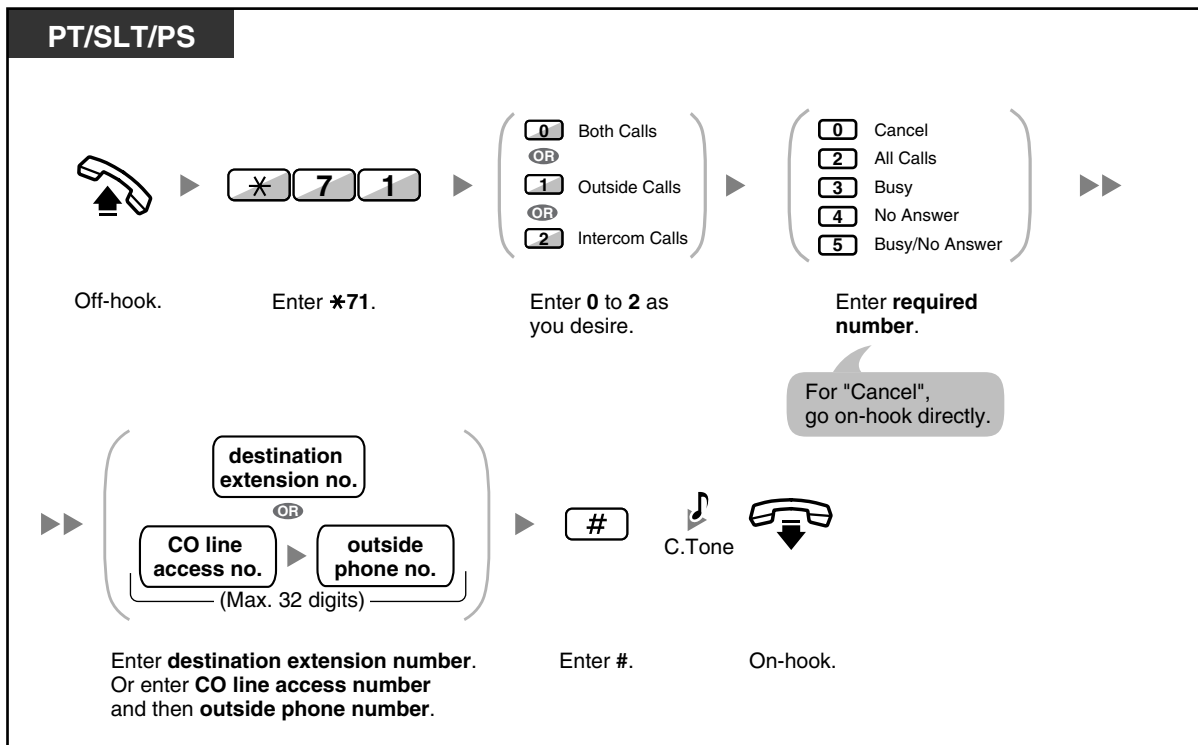

To set from another extension

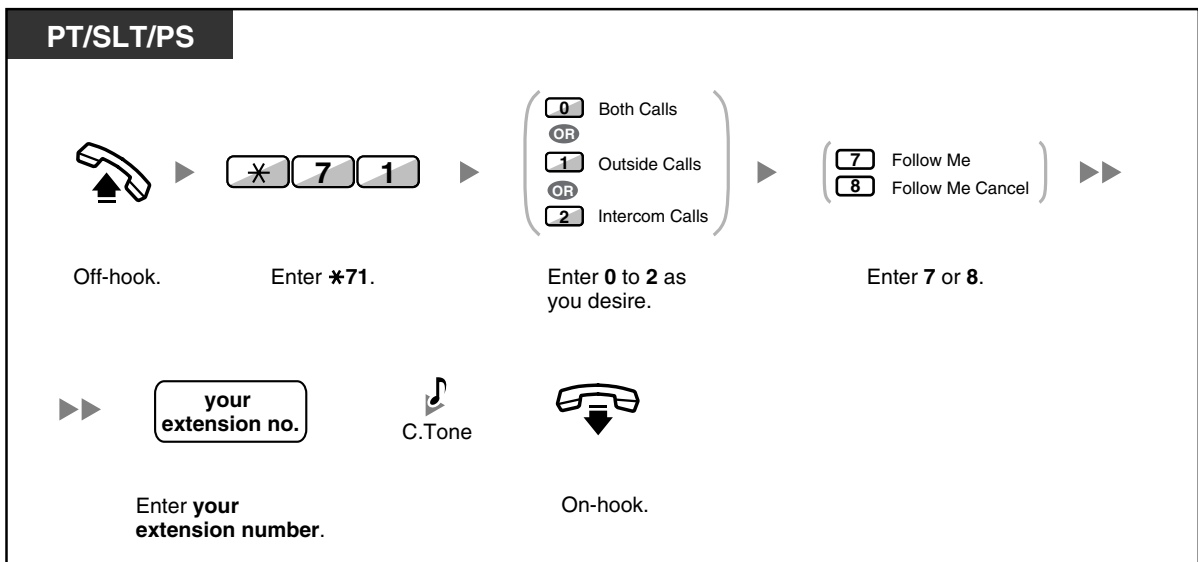

- When using a proprietary telephone, you can set or cancel Call Forwarding by pressing the FWD/DND button (fixed button) instead of "*710".

To set the timer for "No Answer" and "Busy/No Answer"

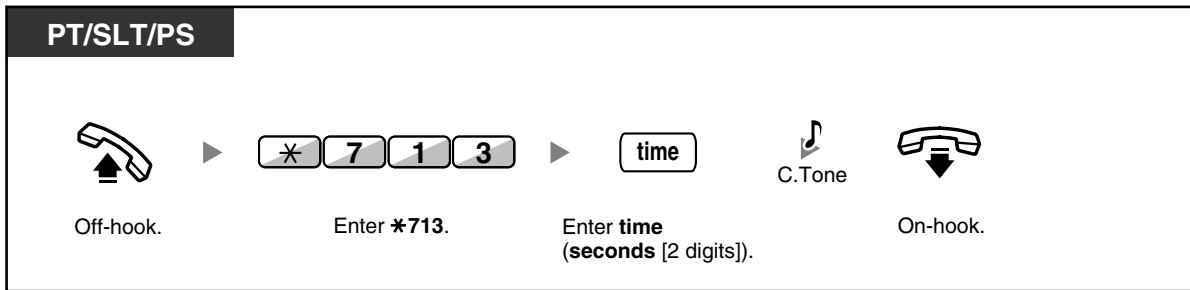

Call Forwarding (FWD) for your Incoming Call Distribution Group

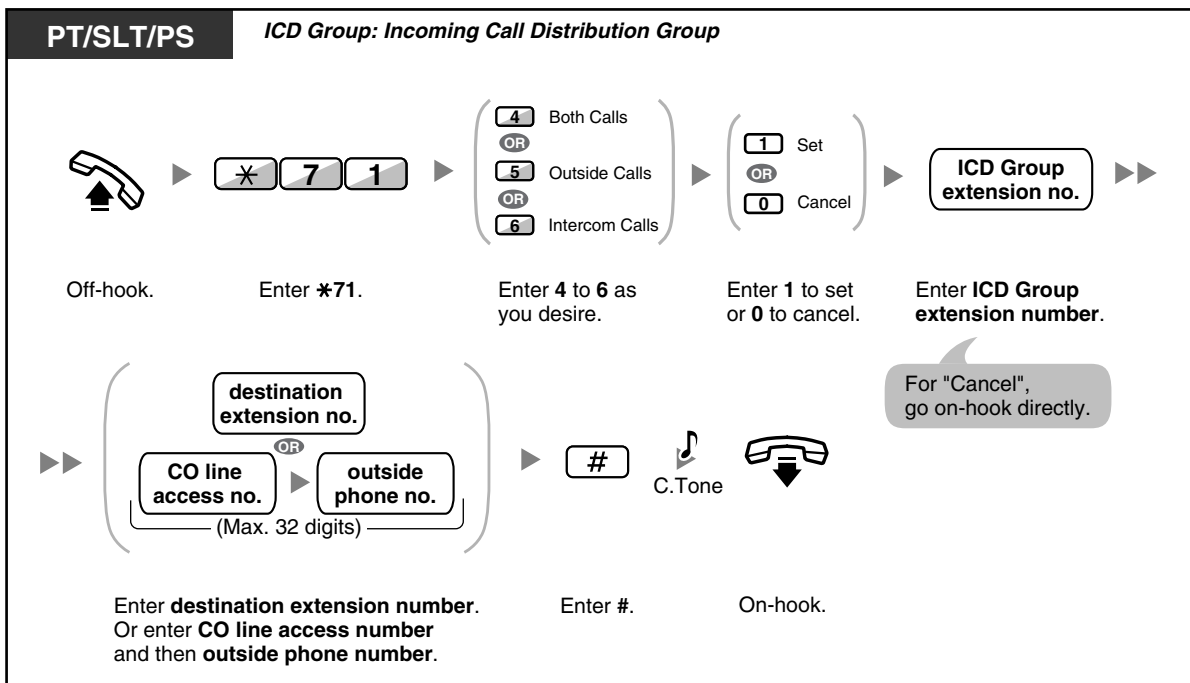

- The FWD/DND button light shows the current status as follows:
 - Off:** Both features are not set.
 - Flashing red slowly:** FWD mode
 - Red on:** DND mode
- The Group FWD button light shows the current status as follows:
 - Off:** No set
 - Red on:** FWD mode

- The system has two modes: (1) FWD/DND Cycle Switch Mode and (2) FWD/DND Setting Mode. Ask your manager what mode your system is in if you are not sure.

(1) When in the FWD/DND Cycle Switch Mode:

Pressing the FWD/DND button (fixed button) while in idle status will cycle the setting as shown below:



(2) When in the FWD/DND Setting Mode:

Pressing the FWD/DND button (fixed button) while in idle status will take you directly to the programming mode for the FWD/DND setting. (Refer to "3.1.2 Settings on the Programming Mode".)

Note

A FWD/DND button (customized button) is always in FWD/DND Cycle Switch Mode: the mode cannot be changed.

- Transferred outside calls are also forwarded to the destination assigned for outside calls.
- When intercom calls are set to be handled differently from outside calls (forwarding type, forward destination), we recommend establishing buttons for both FWD/DND—Outside calls and FWD/DND—Intercom calls, and/or Group FWD—Outside calls and Group FWD—Intercom calls, because:
 - the light patterns of the FWD/DND—Both calls button (including FWD/DND button [fixed button]) and the Group FWD—Both calls button will indicate the setting for either outside calls or intercom calls, but not both.

Note

The FWD icon on PS display reflects the setting for outside calls only.

- pressing the FWD/DND—Both calls button (including FWD/DND button [fixed button]) or the Group FWD—Both calls button will not change the FWD or DND mode for intercom calls and outside calls separately.



Customizing Your Phone

- 3.1.3 Customizing the Buttons
Create or edit FWD/DND (Both calls, Outside calls, Intercom calls) buttons, or Group FWD (Both calls, Outside calls, Intercom calls) buttons.

1.5.2 Absent Message

You can show the reason you do not answer, if the caller uses a Panasonic display proprietary telephone. There are eight preprogrammed messages and one for your personal message (16 characters). The selected message is shown on the display of your telephone.

Message no.	Message (Example)
1	Will Return Soon
2	Gone Home
3	At Ext %%%% (Extension number)
4	Back at %:%% (Hour:Minute)
5	Out until %%/%% (Month/Day)

Message no.	Message (Example)
6	In a Meeting
7	
8	
9	<i>A message assigned for each extension. (Personal Absent Message)</i>

To set

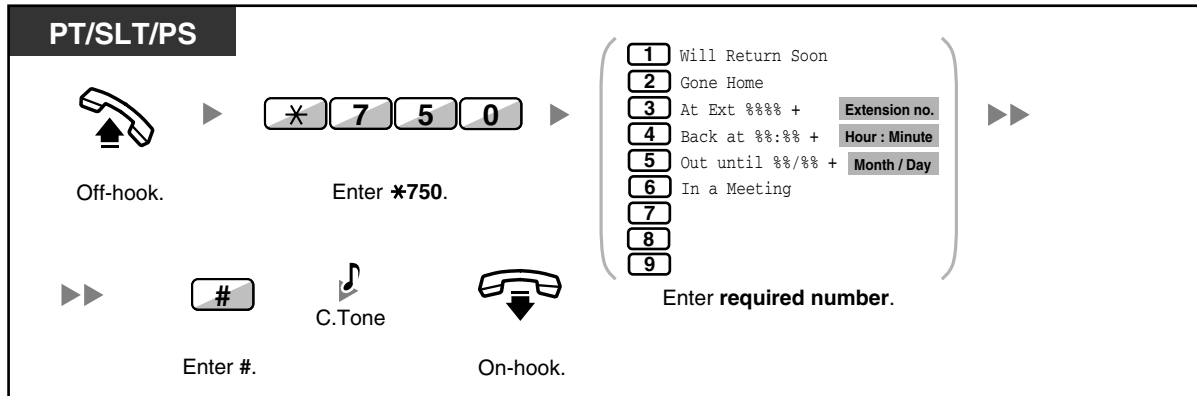

To cancel

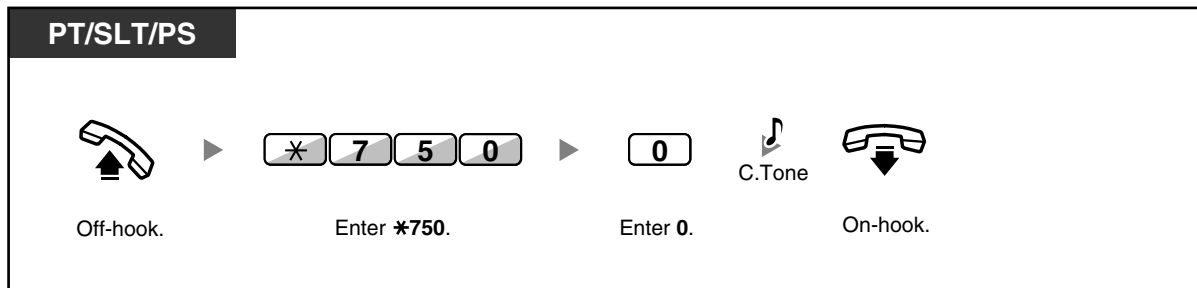

- Enter the desired value in the "%" positions. You must enter the correct number of characters as represented by the "%" using 0 to 9 or *.
- The default messages can be changed. Consult your dealer.
- To create your personal message (Message no. 9), refer to "3.1.2 Settings on the Programming Mode".

1.5.3 Extension Lock

You can lock your extension so that other users cannot make inappropriate outside calls. This feature is also known as Electronic Station Lockout.

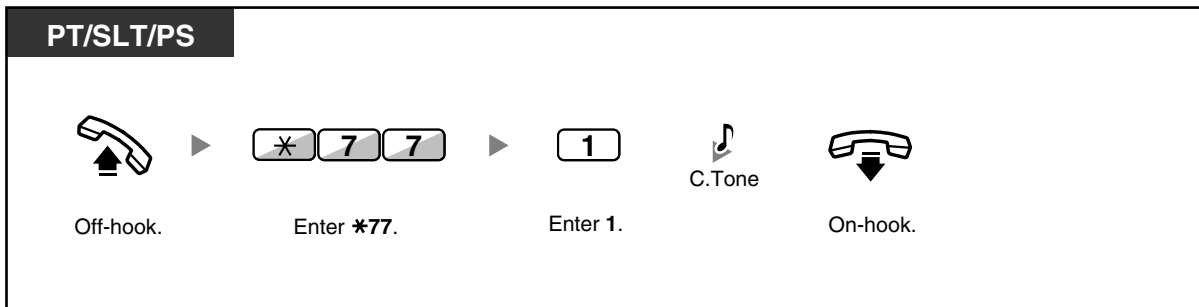
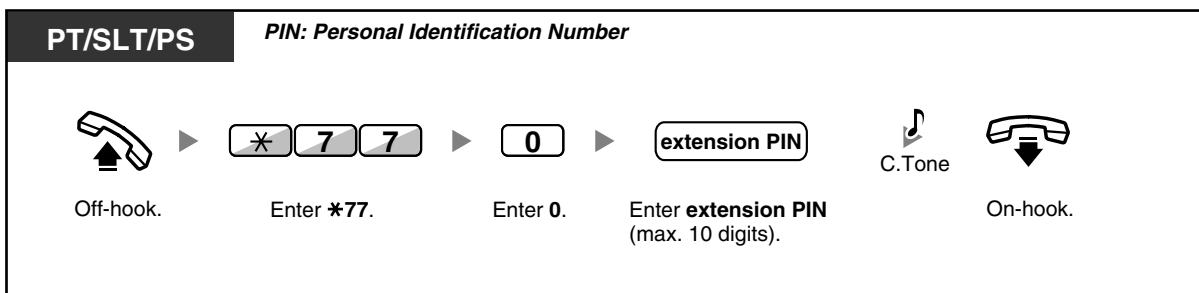
To lock**To unlock**

- **If you forget the extension PIN or cannot unlock your phone**, consult your manager. He can clear your extension PIN. Then, you can set the new PIN and unlock your extension by entering it.
- If your extension is locked by this feature, it cannot perform features as follows:
 - Making outside calls
 - Changing the call forwarding destination
- If you do not set extension PIN, you cannot lock and unlock.

1.6 Paging

1.6.1 Paging

- Group Paging
- Paging and then Transferring a Call

◆◆ Group Paging

You can make a voice announcement to proprietary telephones or external speakers or both in the preset group simultaneously.

To page

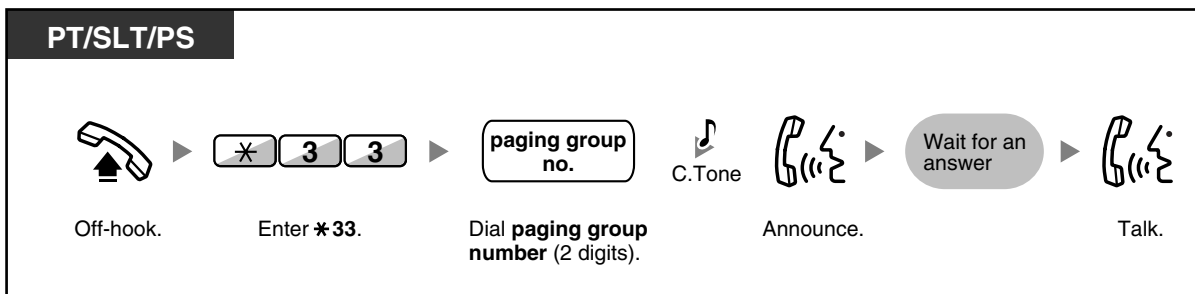

- If the group which you paged is already being used for paging, you hear a busy tone.

◆◆ Paging and then Transferring a Call

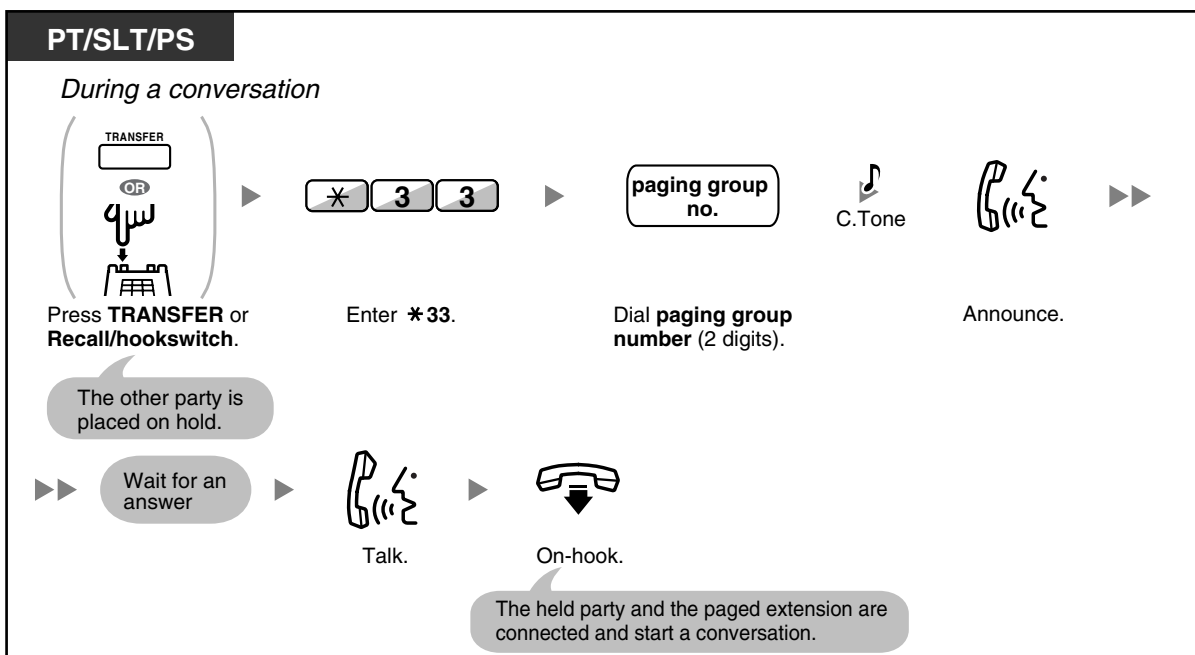



- After you go on-hook, the caller can talk to the person who answers the page.

1.6.2 Answering/Denying a Paging Announcement

To answer

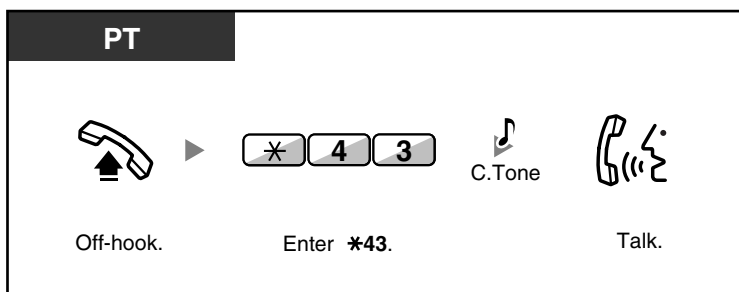

Paging Deny

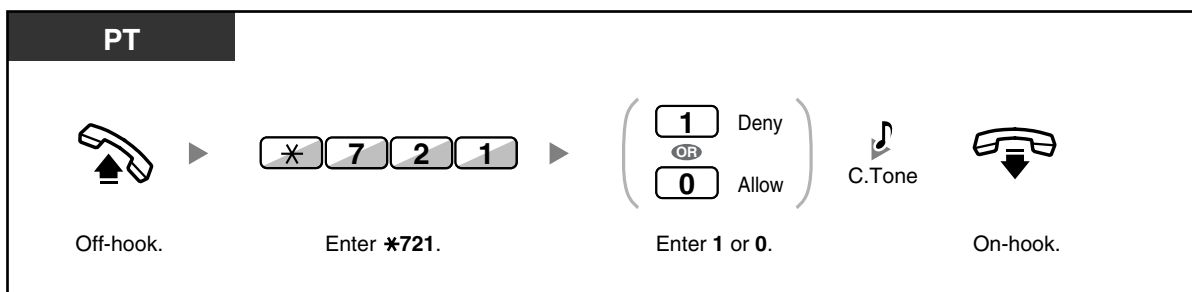

- The following are extensions that cannot receive a paging announcement:
 - Portable station
 - Single line telephone
 - Proprietary telephone that is ringing or busy
 - Proprietary telephone in Paging Deny mode
 - Proprietary telephone in DND mode
- Even if the announcement is not paging your extension, you can answer it, if it is paging your group.

1.7 Extension Settings

1.7.1 Timed Reminder

You can receive an alarm at your telephone to remind you of a meeting, appointment or as a wake-up call. The alarm can occur either once or daily (every day until canceled) at a preset time. When you go off-hook to answer, you will hear a special dial tone or prerecorded message.

To set

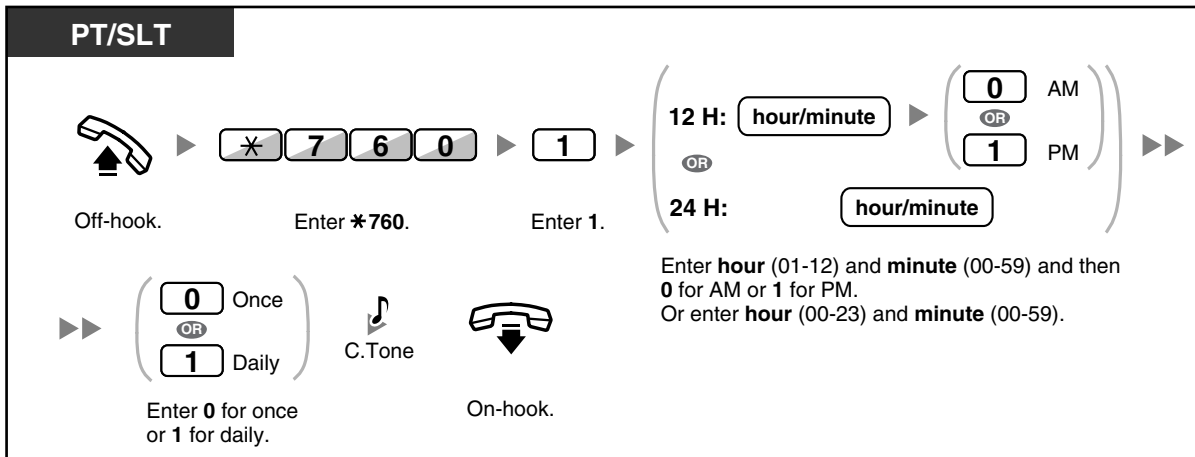

To cancel

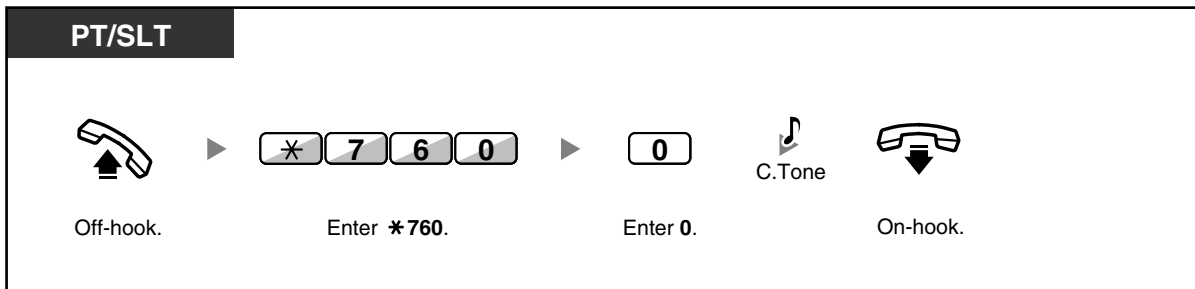

To stop or answer the ringback

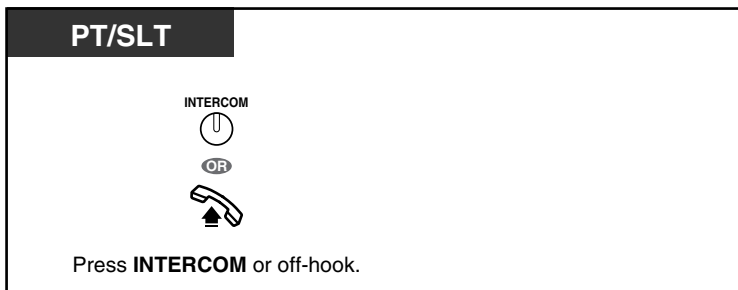

To confirm

- You can also confirm the Timed Reminder by using the soft button.
- The alarm keeps ringing for preprogrammed seconds.
- **If you receive an incoming call during ringback**, the ringing starts after the ringback stops.
- **If you are having a conversation exceeding alarm ringing period**, the ringback will start after your conversation.

1.7.2 Do Not Disturb (DND)

You may set this feature when you are in a meeting or busy.

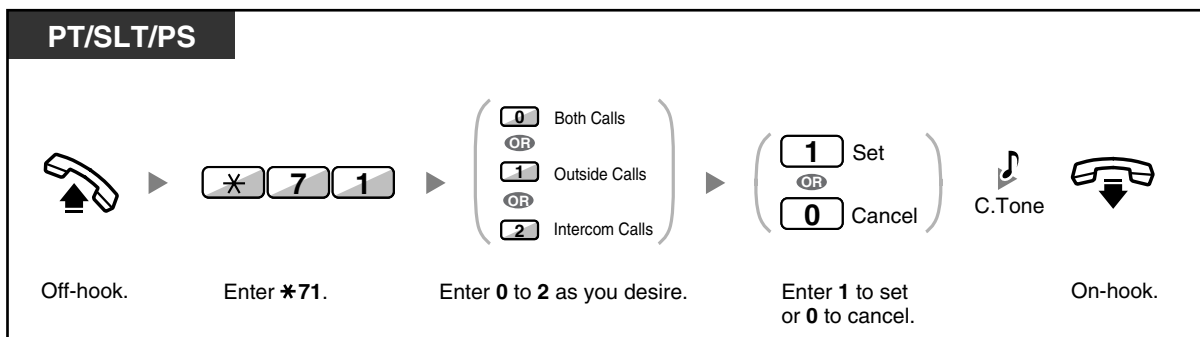
To set/cancel

- When using a proprietary telephone, you can set or cancel Do Not Disturb by pressing the FWD/DND button (fixed button) instead of "*710".



- The FWD/DND button light shows the current status as follows:
Off: Both features are not set.
Flashing red slowly: FWD mode
Red on: DND mode
- The system has two modes: (1) FWD/DND Cycle Switch Mode and (2) FWD/DND Setting Mode. Ask your manager what mode your system is in if you are not sure.

(1) When in the FWD/DND Cycle Switch Mode:

Pressing the FWD/DND button (fixed button) while in idle status will cycle the setting as shown below:



(2) When in the FWD/DND Setting Mode:

Pressing the FWD/DND button (fixed button) while in idle status will take you directly to the programming mode for the FWD/DND setting. (Refer to "3.1.2 Settings on the Programming Mode".)

Note

A FWD/DND button (customized button) is always in FWD/DND Cycle Switch Mode: the mode cannot be changed.

- If your extension has set this feature, a calling extension will hear DND tone.
- If this feature is set, the Call Forwarding (FWD) feature does not work.
- Specified extensions can override this feature and call DND extensions (DND Override).
- When intercom calls are set to be handled differently from outside calls (DND set/cancel), we recommend establishing buttons for both FWD/DND—Outside calls and FWD/DND—Intercom calls, because:
 - the light patterns of the FWD/DND—Both calls button (including FWD/DND button [fixed button]) will indicate the setting for either outside calls or intercoms calls, but not both.

Note

The DND icon on PS display reflects the setting for outside calls only.

- pressing the FWD/DND—Both calls button (including FWD/DND button [fixed button]) will not change the FWD or DND mode for intercom calls and outside calls separately.



Customizing Your Phone

- 3.1.3 Customizing the Buttons
 Create or edit FWD/DND (Both calls, Outside calls, Intercom calls) buttons.

1.7.3 Call Waiting/Off-hook Call Announcement (OHCA)/Whisper OHCA

During a conversation, you can be informed of a call waiting with a tone or voice announcement through your built-in speaker or handset. (Default: Enable—Tone)

Call Waiting Tone:

a waiting tone through the built-in speaker of PT/handset of SLT. To change the tone from PT, refer to "3.1.2 Settings on the Programming Mode".

OHCA:

a voice announcement through the built-in speaker

Whisper OHCA:
a voice announcement through the handset

To set/cancel for intercom calls

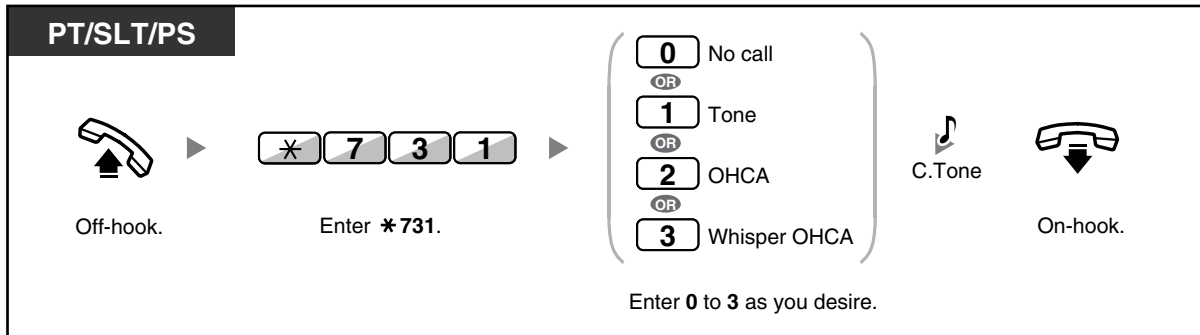

To set/cancel for outside calls

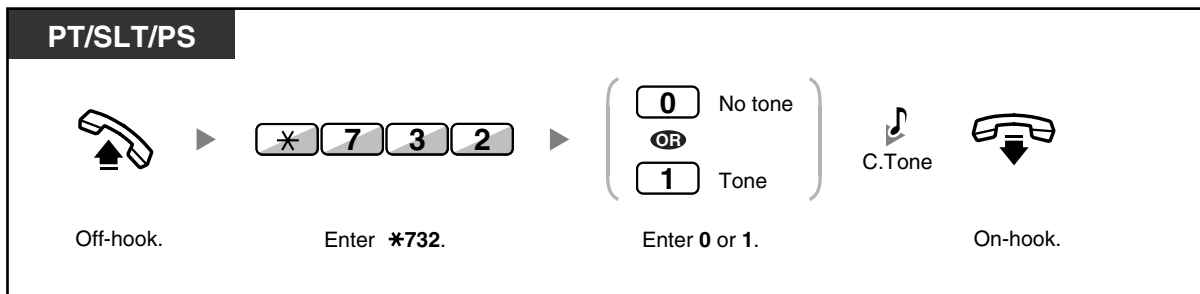

- OHCA and Whisper OHCA can be activated only on certain digital proprietary telephones. In addition, Whisper OHCA requires that both you and the other party are using supported telephones. For more details, consult your dealer.

1.7.4 Connected Line Identification Restriction (COLR)

When receiving a call through a private network, you can select whether the caller can see your extension number or not.

To show/prevent

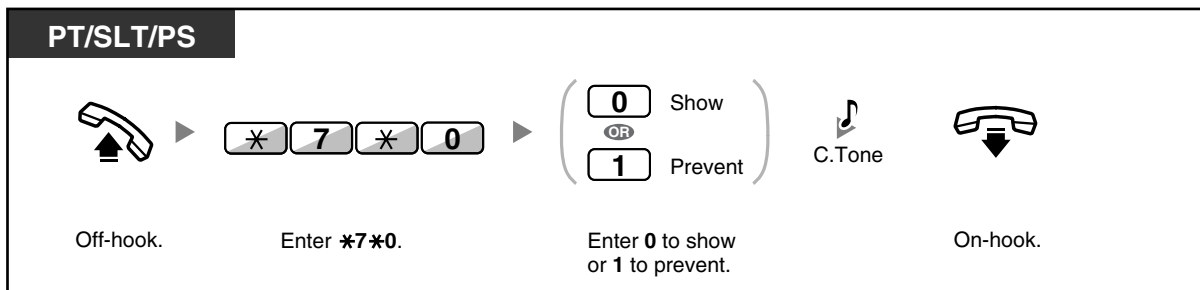



- You can change the mode by pressing a preset COLR button while on-hook. The COLR button light shows the current status as follows:
Off: shows your extension number.
Red on: prevents your extension number being displayed.



Customizing Your Phone

- 3.1.3 Customizing the Buttons
 Create or edit a Connected Line Identification Restriction (COLR) button.

1.7.5 Calling Line Identification Restriction (CLIR)

When making a call through a private network, you can select whether the called party can see your extension number or not.

To show/prevent

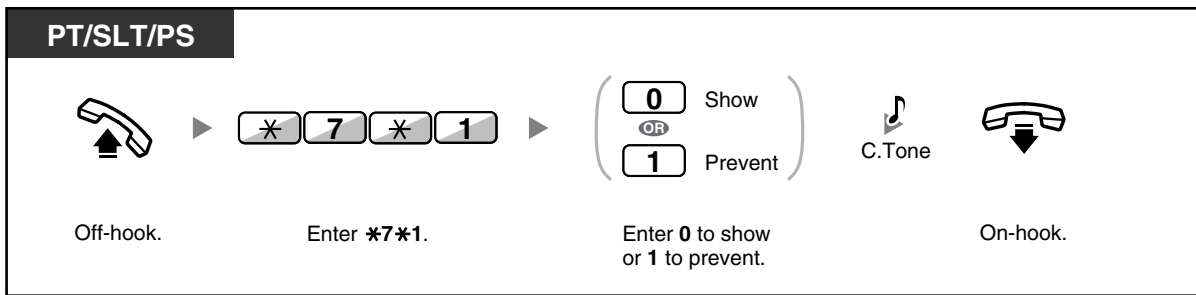

- You can change the mode by pressing a preset CLIR button while on-hook. The CLIR button light shows the current status as follows:
Off: shows your extension number.
Red on: prevents your extension number being displayed.



Customizing Your Phone

- 3.1.3 Customizing the Buttons
 Create or edit a Calling Line Identification Restriction (CLIR) button.

1.7.6 Executive Busy Override Deny

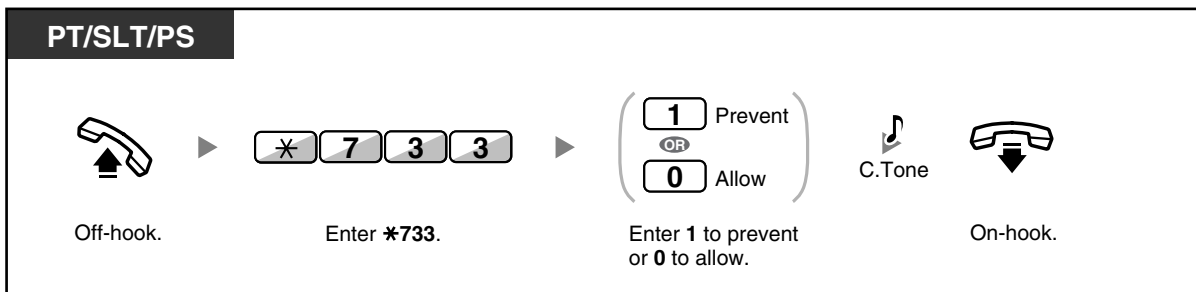



- Some extensions may be prohibited from performing this feature.

1.7.7 Background Music (BGM)

You can listen to the background music through your telephone speaker while on-hook. An external music source, such as a radio, can be connected. If your extension becomes busy (off-hook, making or receiving a call etc.), the music stops temporarily. When you go back on-hook, the music starts again.



To select and set/cancel

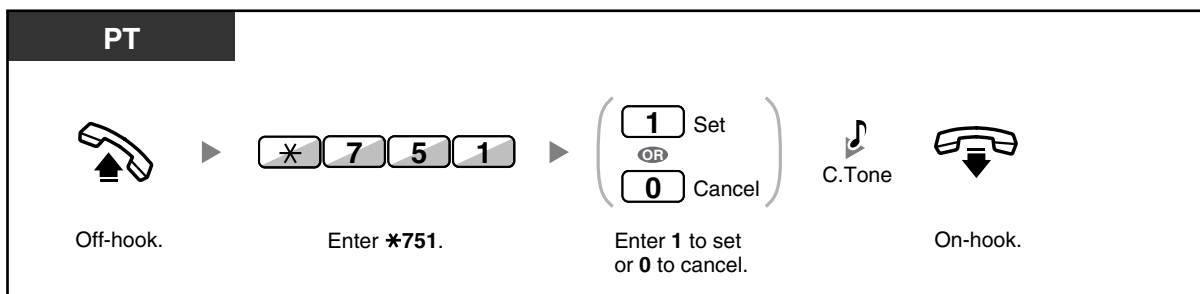

1.7.8 Data Line Security

You can protect the line against audible notification tones, such as a call waiting tone during a conversation. Set this feature if your extension has a data communication device, such as a computer or fax machine connected to ensure secure data transmission.

To set/cancel

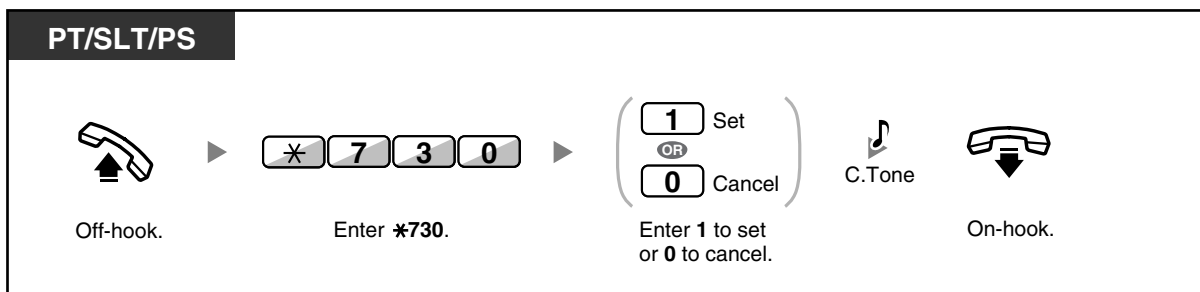

1.7.9 Time Service

You can check the current status of the Time Service on the display.



PT

While on-hook

Press **TRANSFER** or **Time Service (Day/Night/Lunch/Break)**.



- The Time Service (Day/Night/Lunch/Break) button light always shows the current status as follows:
 - Off:** Day mode
 - Green on:** Lunch mode
 - Flashing Green:** Break mode
 - Red on:** Night mode
 - Flashing Red:** Holiday mode
- Any extension user except the managers can check the current status by pressing the Time Service (Day/Night/Lunch/Break) button.



Customizing Your Phone

- 3.1.3 Customizing the Buttons
Create or edit a Time Service (Day/Night/Lunch/Break) button.

1.7.10 Paralleled Telephone

A digital proprietary telephone extension user can choose whether the single line telephone connected in parallel will ring or not, when an incoming call is received.
(Default: Ring)



DPT

Off-hook.

Enter ***39**.

1 Ring
OR
0 No ring

Enter **1** to ring
or **0** not to ring.

C.Tone

On-hook.



- Even if "No ring" is selected,** calls can be made and answered on the single line telephone by lifting the handset.
- If you go off-hook while your paralleled telephone is in use,** the call will switch over to you.

1.7.11 Wireless XDP Parallel Mode

Your PS can be used in parallel with a PT or SLT.

When in this mode, incoming calls to a wired telephone also ring the paired PS.

To set

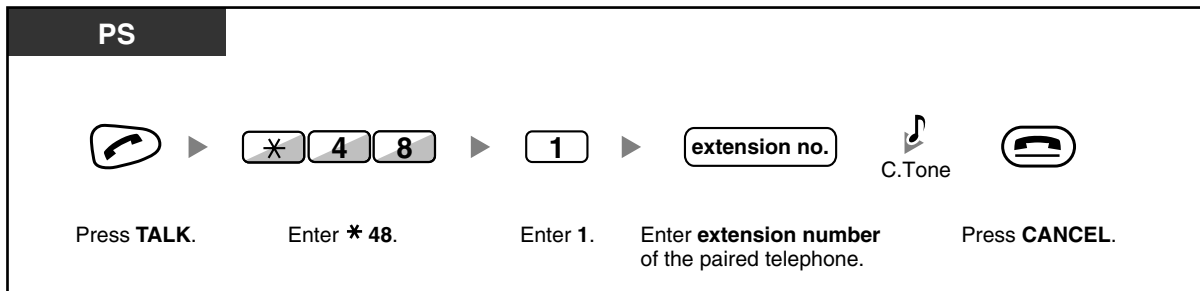

To cancel

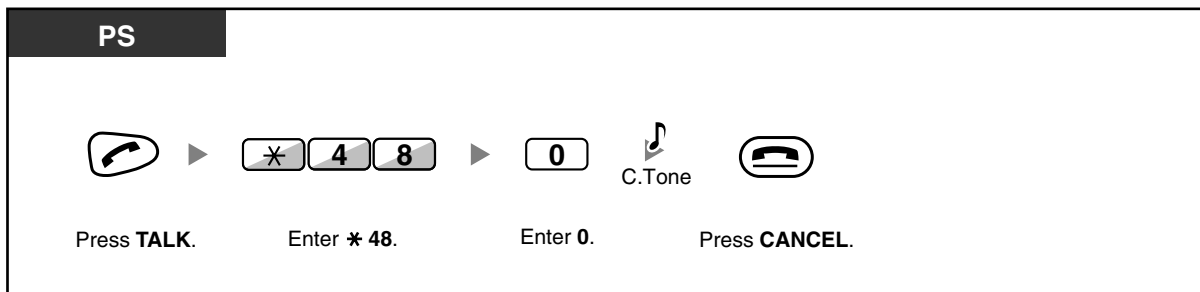

- Some wired telephones are prohibited from using this feature.
- **If you go off-hook while your paralleled telephone is in use**, the call will switch over to you.

1.7.12 Extension Feature Clear

You can reset the settings of the following features on your extension to the default settings with one operation.

This feature is also known as Station Program Clear.

Features	Default Setting
Hot Line*	Off
Message Waiting—(All the messages that have been left by other extension users)	Off
Call Pickup Deny	Allow
Call Forwarding (FWD)*	Off
Absent Message	Off
Paging Deny	Allow
Timed Reminder	Cleared

1.7 Extension Settings

Features	Default Setting
Do Not Disturb (DND)*	Off
Call Waiting*	Enable—Tone
Executive Busy Override Deny	Allow
BGM	Off
Data Line Security	Off
Paralleled Telephone	The telephone in parallel rings.
Log-in/Log-out	Log-in

* These features may not be reset depending on the system programming.

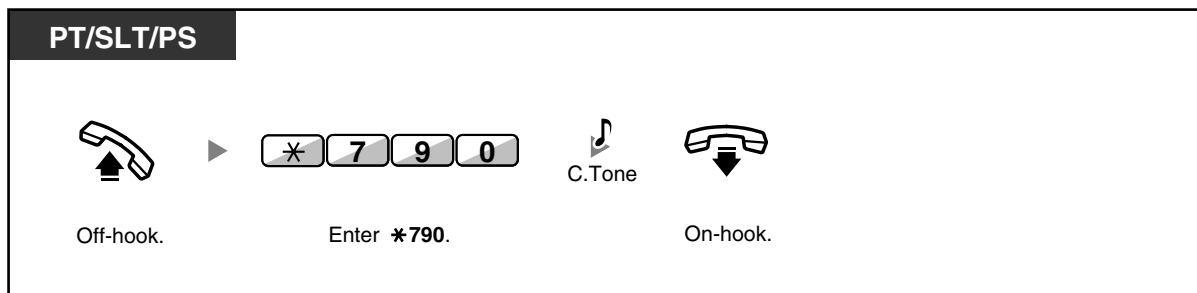

- After performing Extension Feature Clear, the setting of Call Waiting becomes "Enable—Tone". In this case, dial tone 2 will be heard when you go off-hook.

1.8 Call Center

1.8.1 Log-in/Log-out, Wrap-up

You can control your status in an incoming call distribution group. When in the Log-out mode, incoming calls to the group will not ring at your extension. When you return, calls will again ring at your extension. (Default: Log-in)

Even if your extension is logged-in, you can have a specified time period (wrap-up time) when you will not receive calls after completing a previous call. This time can be used for you to write a report and so on. You can also manually select "Not Ready" mode to temporarily leave a distribution group.

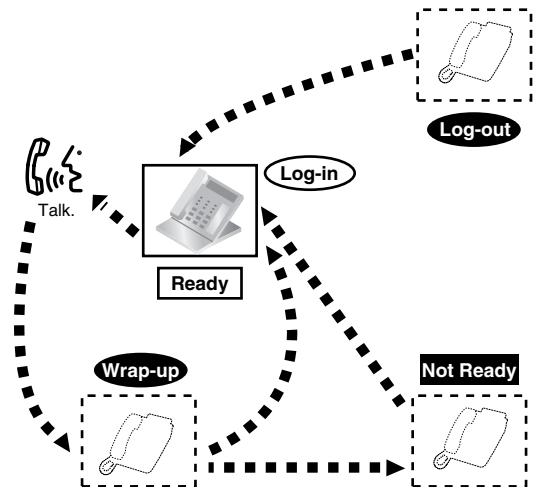

To set Log-in/Log-out

PT/SLT/PS	ICD Group: Incoming Call Distribution Group	
Off-hook.	Enter *736.	Enter 0 or 1.
Enter ICD Group extension number or *.		On-hook.

PT/PS *ICD Group: Incoming Call Distribution Group*

While on-hook

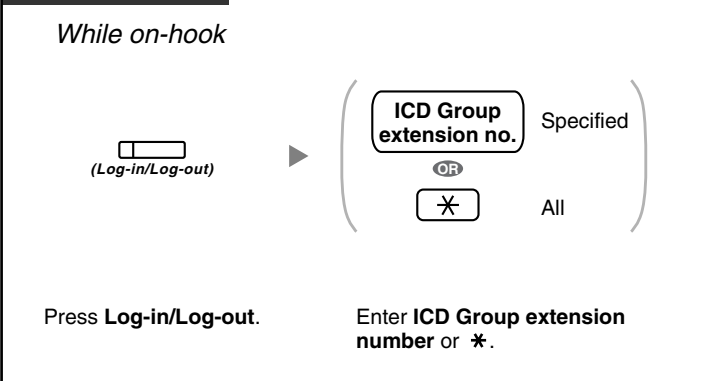

Press **Log-in/Log-out**. Enter **ICD Group extension number** or *****.

PT/PS

While on-hook

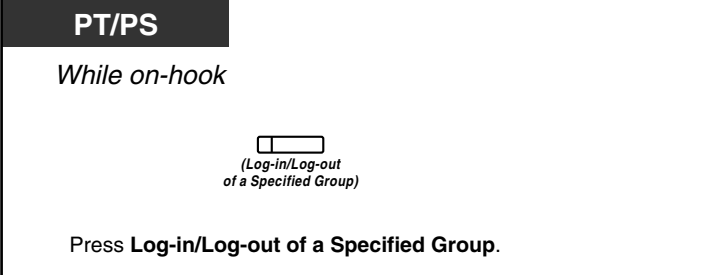

Press **Log-in/Log-out of a Specified Group**.

To enter/leave the Not Ready mode

PT/SLT/PS

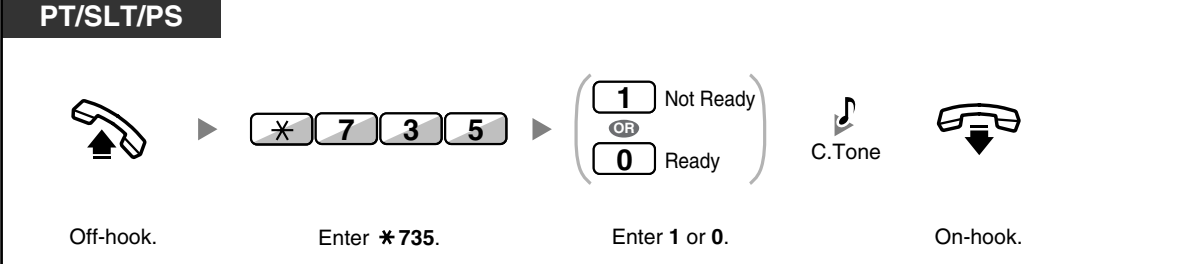

Off-hook. Enter *** 735**. Enter **1** or **0**. On-hook.

To set/cancel the Not Ready mode or to leave the Wrap-up mode (To enter the Ready mode)

PT/PS

While on-hook

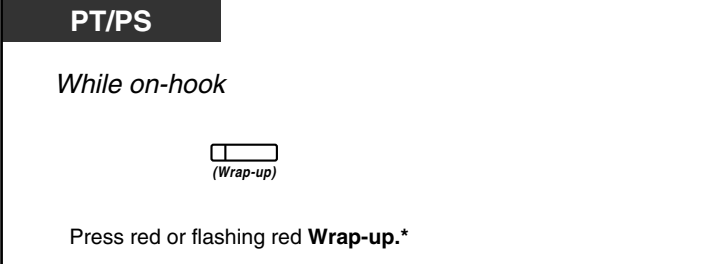

Press red or flashing red **Wrap-up.***



- * The status will be as follows:
Ready → Not Ready
Not Ready → Ready
Wrap-up → Not Ready
- The Log-in/Log-out of a specified group button light shows the current status as follows:
Off: Log-in mode
Red on: Log-out mode
- The Wrap-up button alternates the setting of Wrap-up mode, Not Ready mode or Ready mode.
The Wrap-up button light shows the current status as follows:
Off: Ready mode
Red on: Not Ready mode
Flashing red: Wrap-up mode
- In Wrap-up mode/Not Ready mode, your extension does not receive calls through any group, even if it belongs to multiple groups.
- There may be at least one extension in the incoming call distribution group that is in the Log-in mode.
- The Supervisor extension can control the Log-in/Log-out status of other extensions. For more information, refer to "1.8.2 Incoming Call Distribution Group Monitor".



Customizing Your Phone

- 3.1.3 Customizing the Buttons
Create or edit a Log-in/Log-out button, a Log-in/Log-out of a specified group button or a Wrap-up button.

1.8.2 Incoming Call Distribution Group Monitor

— Monitoring the Status of Waiting Calls

— Monitoring and Changing the Log-in/Log-out Status of Extensions

The extension assigned as a Supervisor extension can monitor and control the status of other extensions in an incoming call distribution group. It should have a PT with 6-line display. The display and DSS buttons show as follows:

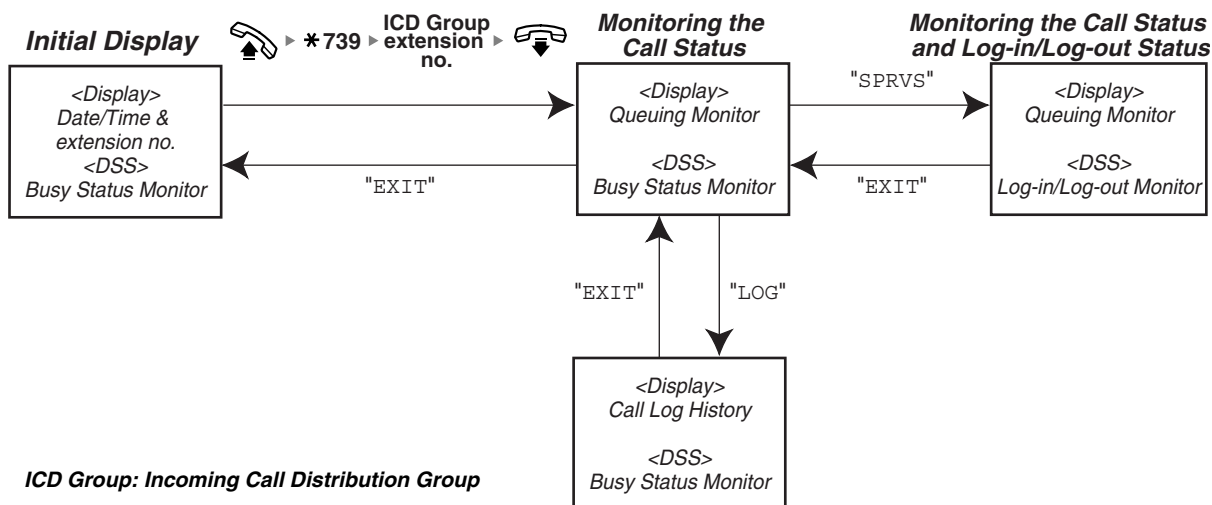

◆◆ Monitoring the Status of Waiting Calls

The Supervisor extension can monitor the status of calls waiting to be answered in the queue. If an incoming call distribution group has an overflowed call, the display shows the status automatically. The following information is displayed.

<Queuing Monitor>

- The current date/time
- The ICD Group extension number/name
- The number of waiting calls
- The longest waiting time

<Call Log History>

- The date/time when cleared at last time
- The total number of received calls
- The number of overflowed calls
- The number of unanswered calls
- The average waiting time of queuing calls

To monitor

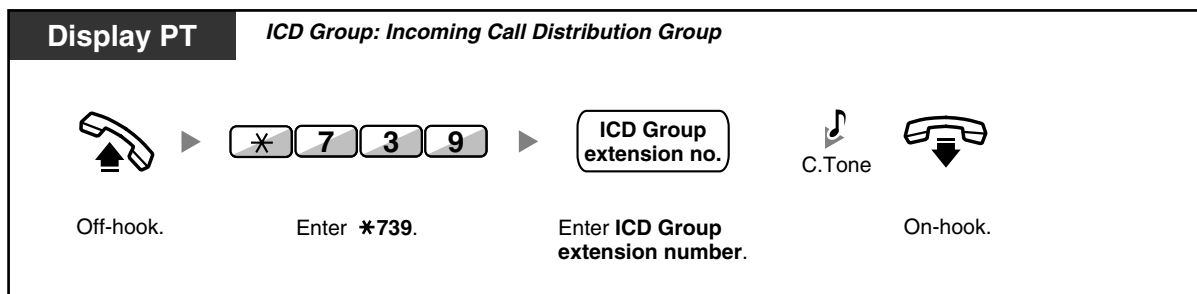

To clear Call Log History



- The accumulated data is cleared.
"*****" shows if the number to be displayed exceeds the maximum displayable digits.

◆◆ Monitoring and Changing the Log-in/Log-out Status of Extensions

The Supervisor extension can monitor the Log-in/Log-out status of the incoming call distribution group members by the DSS button light. It can also change their Log-in/Log-out status if needed.

To monitor

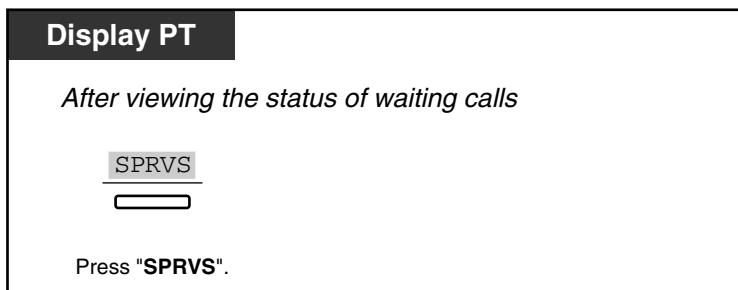

To change the Log-in /Log-out mode

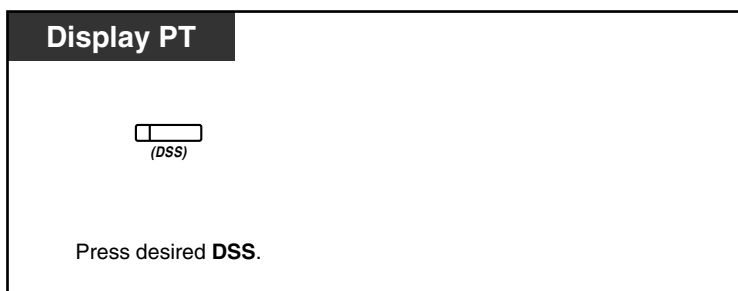

- The DSS button light shows the current status as follows:
Off: The extension is not in the group.
Green on: Log-in (Ready) mode
Flashing green: Log-in (Not Ready) mode
Red on: Log-out mode

1.8.3 Manual Queue Redirection

When your incoming call distribution group is busy and other outside calls arrive, the arriving calls are put in a waiting queue.

Extensions can check the status of the queue with the Hurry-up button light, and forward the longest waiting call in the queue to a preset destination manually.

This feature is also known as Hurry-up Transfer.

To forward the waiting call

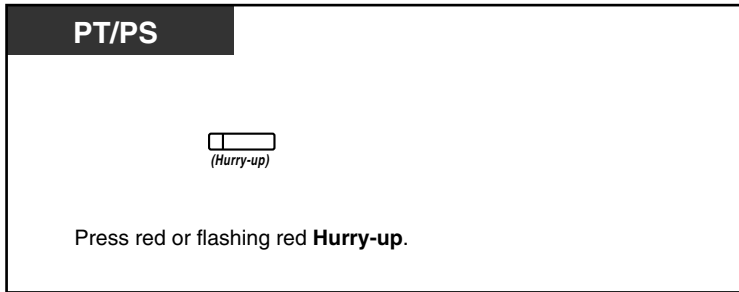

- The Hurry-up button light shows the current status as follows:
Off: No waiting call.
Red on: Some calls are waiting.
Flashing red: The number of calls exceeds the manual queue redirection level.



Customizing Your Phone

- 3.1.3 Customizing the Buttons
Create or edit a Hurry-up button.

1.9 User-supplied Equipment

1.9.1 Doorphone/Door Opener

You can talk to a person at the door through the doorphone. Preprogrammed extensions or an outside party can receive the calls from the doorphone. You can open the door.

- Doorphone Call
- Door Open

◆◆ Doorphone Call

To call from the doorphone

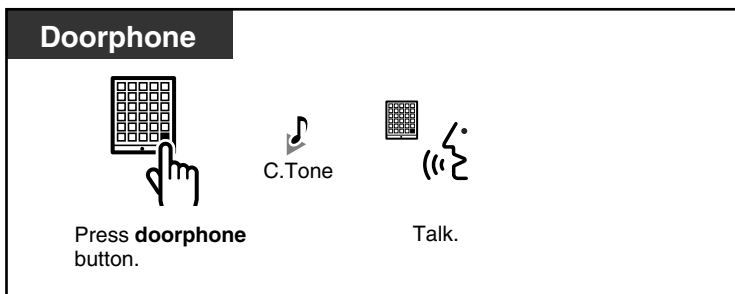

To answer a call from the doorphone

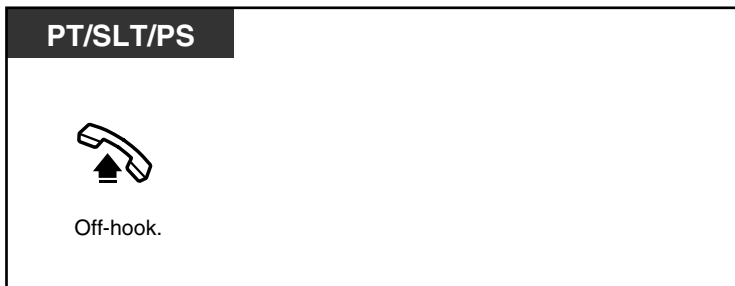

To call the doorphone

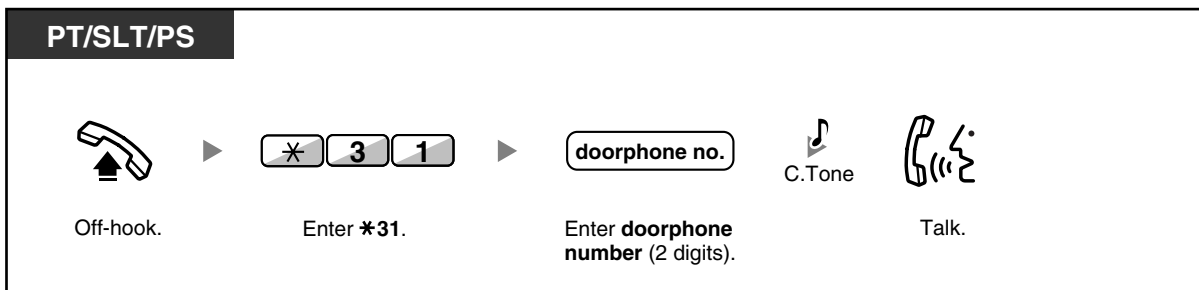

- If no one answers a doorphone call within a specified time period, the call is canceled.

◆◆ Door Open

Some extensions may be prohibited from using this feature.

From a specified extension

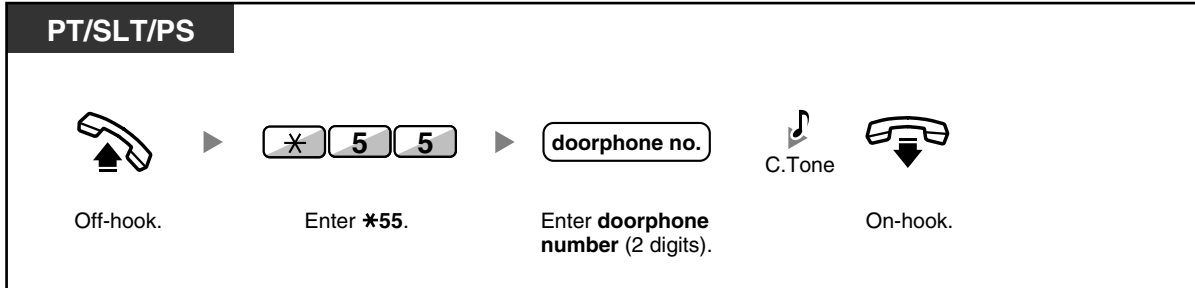

From any extension while talking to the doorphone

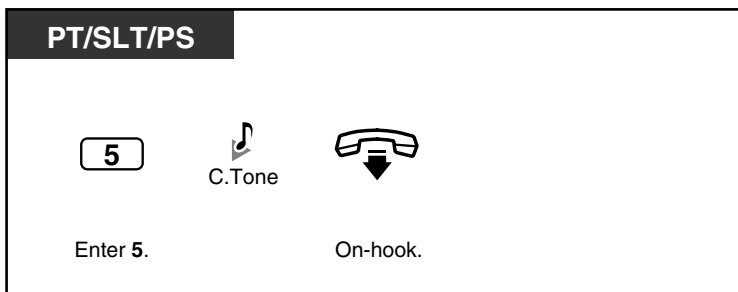

- The door open will be triggered for a specified time period.

1.9.2 Host PBX

— External Feature Access (EFA)

◆◆ External Feature Access (EFA)

You can access special features (e.g., Call Waiting) offered by a host PBX or telephone company. This feature is only effective for an outside call.

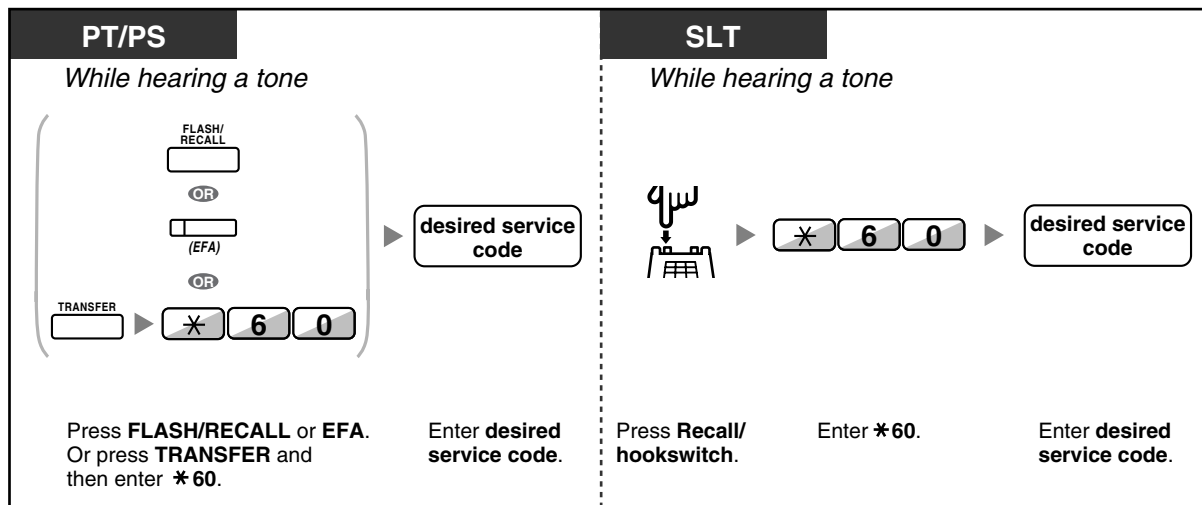
<Example> To hold the current call and then talk to the new party

- In this case, FLASH/RECALL button on a proprietary telephone is in the External Feature Access (EFA) mode.
- Regarding the service code, consult your dealer.

**Customizing Your Phone**

- 3.1.3 Customizing the Buttons
Create or edit an External Feature Access (EFA) button.

1.9.3 Voice Processing System

You or an outside party can access the Voice Processing System from a telephone.

— Call Forwarding to Voice Mail (Voice Mail Integration)

If your PBX has a Panasonic Voice Processing System connected (e.g., KX-TVS series) using digital integration, the following features are also available:

— Live Call Screening (LCS)

— Two-way Record

◆◆ Call Forwarding to Voice Mail (Voice Mail Integration)

— To forward your calls to your mailbox

— To transfer a call to a mailbox

— To listen to messages

If you cannot answer calls, you can forward them to your mailbox. You can select the type of incoming calls (Intercom Calls/Outside Calls/Both Calls). If your telephone has a Message button, the Message light turns on and lets you know you have messages. Even if a Message button is not provided, you will hear an indication tone* when going off-hook.

You can also transfer received outside calls to a mailbox so that calling parties can leave messages. If you create a Voice Mail Transfer button on your phone, the transfer is done without knowing the mailbox number (Voice Mail Transfer).

The duration for recording depends on the voice processing system.

To forward your calls to your mailbox

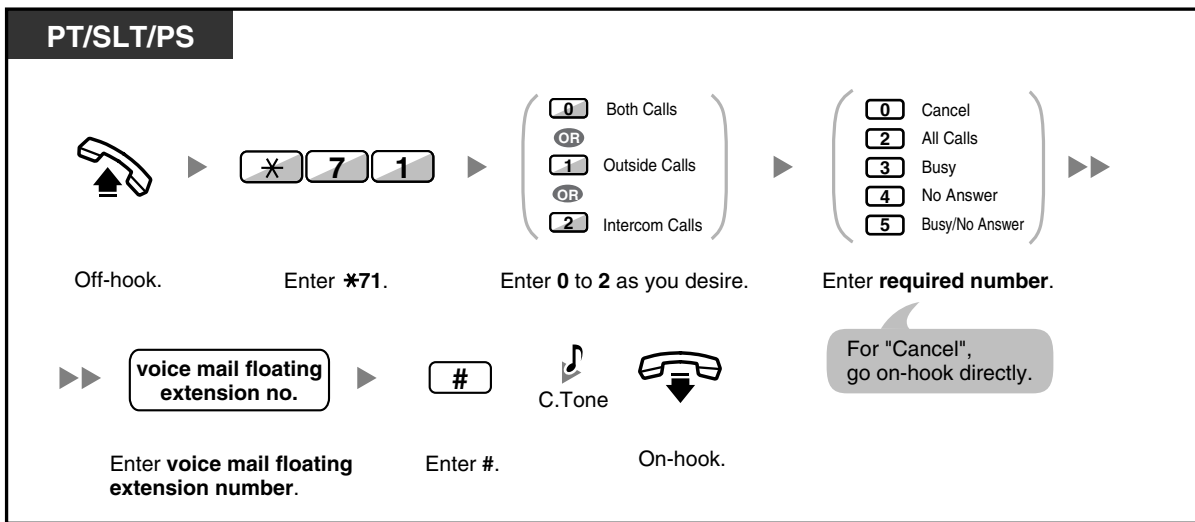

To transfer a call to a mailbox

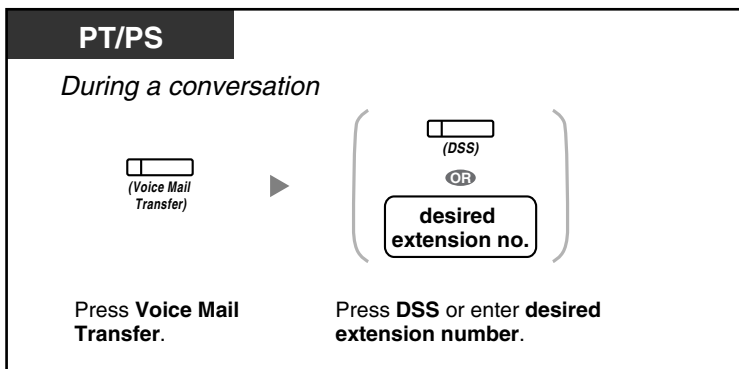

To listen to messages

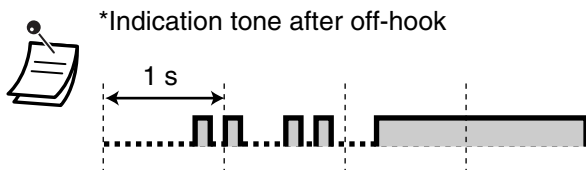
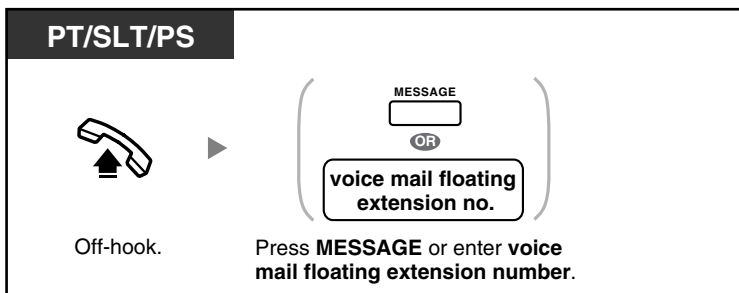

- You can access a voice mail with one-touch.



Customizing Your Phone

- 3.1.3 Customizing the Buttons
Create or edit a Voice Mail Transfer button or a Message button.

◆◆ Live Call Screening (LCS)

While a caller is leaving a message in your mailbox, you can monitor the call without answering. If you so desire, you can answer the call while monitoring. There are two methods available (Default: Hands-free mode).

Hands-free mode:

You can monitor the message automatically, live through the telephone speaker.

Private mode:

You will hear an alarm tone while the caller is leaving a message.

Before operating

- Create a Live Call Screening (LCS) button (Personal Programming).
- Select the mode, either Hands-free or Private (Personal Programming).
- Set the extension PIN (Personal Identification Number).
- Set the Live Call Screening feature.

To set Live Call Screening

PT/PS

PIN: Personal Identification Number

(Live Call Screening)

▶

extension PIN

Press **Live Call Screening**.

Enter **extension PIN**
(max. 10 digits).

This is required only when an extension PIN is stored.

To cancel Live Call Screening

PT/PS

(Live Call Screening)

Press red **Live Call Screening**.

Operation Flowchart

The operations in the shaded areas can be done hands-free.

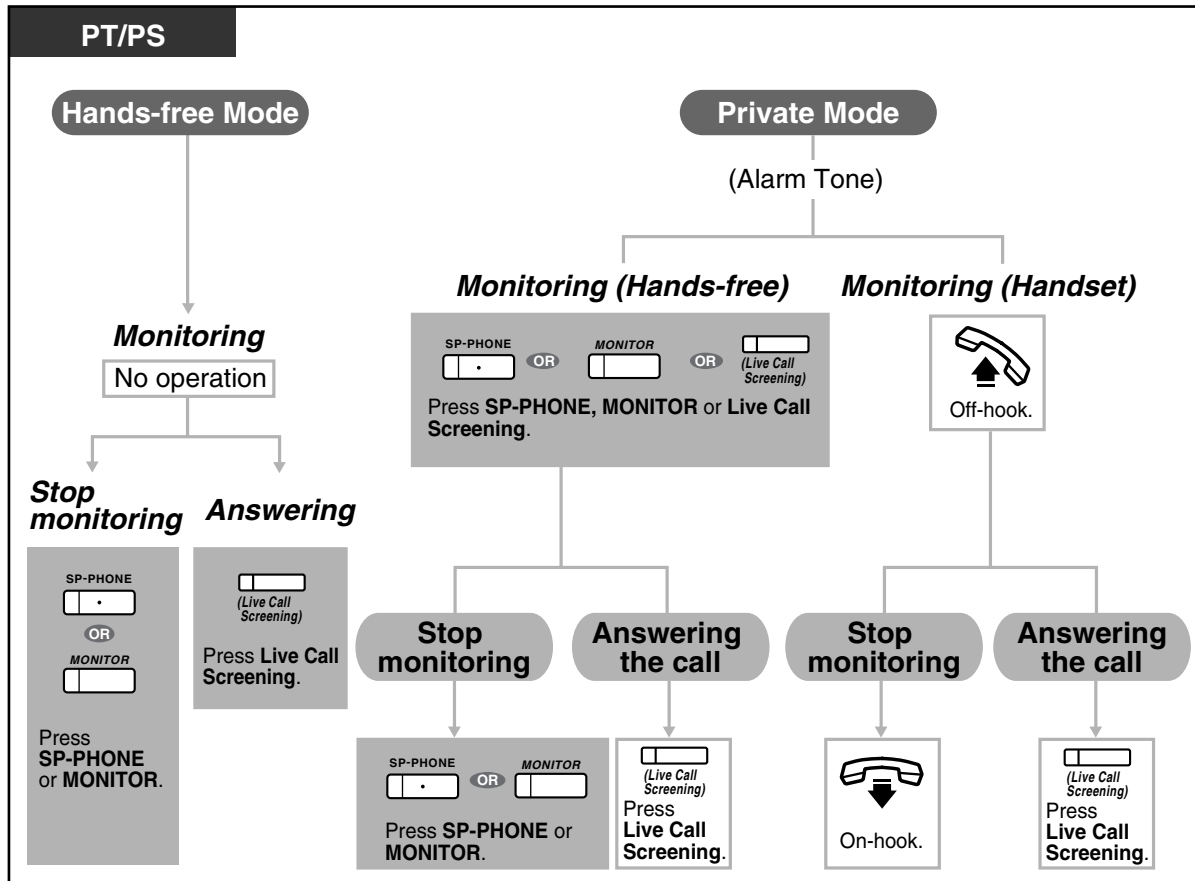

- The Live Call Screening (LCS) button light shows the feature status as follows:
 - Off:** LCS is off.
 - Flashing green rapidly:** Alerting in the Private mode.
 - Flashing green slowly:** Monitoring.
 - Red on:** LCS is on.
- The manager extension can clear an extension PIN.
- This feature is available for a single line telephone if it is connected to a proprietary telephone in parallel. (Private mode only)
 - To answer the call while monitoring, press Recall/hookswitch.
- Only the handset monitoring in the Private mode is available for PS users.



Customizing Your Phone

- 3.1.2 Settings on the Programming Mode—**Live Call Screening Mode Set**
 - Select the mode, either monitoring the message through the speaker automatically or receiving, while the caller leaves a message.
- 3.1.3 Customizing the Buttons
 - Create or edit a Live Call Screening (LCS) button.

◆◆ Two-way Record

You can record a conversation into a mailbox while talking on the phone. You can select the mailbox each time you record a conversation.



To record into your mailbox

PT/PS

During a conversation

 (Two-way Record)

To stop recording, press this button again.

Press **Two-way Record**.

To record into another mailbox (Two-way Transfer)

PT/PS

During a conversation

 (Two-way Transfer)

Press **Two-way Transfer**.

 (DSS)
OR
another extension no.

Press **DSS** or enter **another extension number**.

To stop recording, press this button again.

To record into another mailbox with one-touch (One-touch Two-way Transfer)

PT/PS

During a conversation

 (One-touch Two-way Transfer)

Press **One-touch Two-way Transfer**.



- The Two-way Record button light, Two-way Transfer button light or One-touch Two-way Transfer button light shows the current status as follows:

Off: Not recording.

On: Recording the conversation.



- **Note:**
Many states have imposed regulations on the manner in which 2-way telephone conversations may be recorded, so you should inform the other party that the conversation is being recorded.
Consult your local telephone company for further information.



Customizing Your Phone

- 3.1.3 Customizing the Buttons
Create or edit a Two-way Record button, a Two-way Transfer button and a One-touch Two-way Transfer button.

1.10 Walking Extension

1.10.1 Walking Extension

You can use the same functions assigned on your previous extension even if you move to another extension in the office.

You can retain your settings such as extension number or One-touch Dialing memory etc. on the new extension.

This feature is also known as Walking Station.

To set

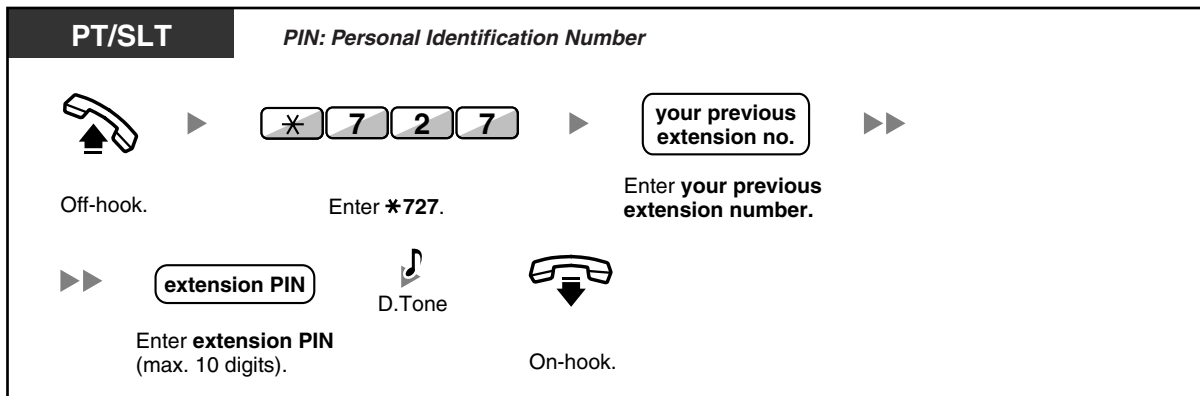

- Your previous extension will get the old settings of your new extension.
- This feature is available for movement between SLT and SLT, PT and PT or SLT and PT.
- For more information, refer to "3.1.1 Personal Programming".

1.11 Display Proprietary Telephone

1.11.1 Call Log

This is available for the display proprietary telephone and the portable station.

- Incoming Call Log
- Outgoing Call Log

◆◆ Incoming Call Log

When you receive an outside call, the caller's information is recorded automatically in the incoming call log. A preprogrammed number of calls can be logged per extension.

When the call log is full and other call arrives, the oldest call is deleted.

You can modify the logged telephone number.

When the Call Log button light turns on, there is a call which you did not answer.

The following information is logged.

Information	Telephone	3-line display PT except KX-T7735/ KX-T7633/KX-T7630	KX-T7735	1-line or 2-line display PT
	KX-T7636/KX-T7633/ KX-T7630			Wireless phone (KX-T7885/KX-TD7895)
	KX-TD7690/KX-TD7680	6-line display PT		
Caller's Name	✓	✓	✓	✓
Caller's Phone Number	✓	✓	✓	—*
Date/Time call received	✓	—	✓	—
Answered or Not Answered	✓	—	—	—
Confirmed or Not Confirmed	✓	—	—	—

*: If the caller's name is not logged, the caller's phone number is displayed.
If the caller's name is logged, the caller's phone number is not displayed.

To confirm the log information with the Call Log button

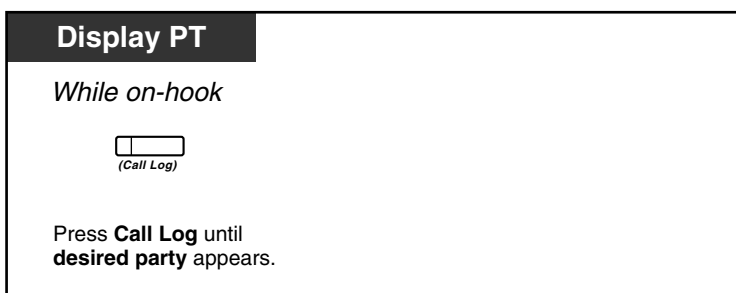

To confirm the log information with the Navigator key

T7600

While on-hook



Press **Left** twice. Press **Up** or **Down** until **desired party** appears.

To clear the log information

Display PT

While confirming the log information



Press **Call Log**, or **Up** or **Down** until **desired party** appears. Press **TRANSFER**.

To call

Display PT

While confirming the log information



Press **Call Log**, or **Up** or **Down** until **desired party** appears. Off-hook.



- The Call Log button light shows the current status as follows:
Off: No incoming call. Or you have already viewed the call log.
Red on: You have missed calls to view.
- If your call is answered by another extension, the caller's information is recorded on the displays of both your extension and the answering extension.
- You can lock your call log by using an extension PIN (Personal Identification Number), so that you can prohibit access to your logged information. Refer to "3.1.2 Settings on the Programming Mode".
- You can also have a Call Log button for an ICD Group (Incoming Call Distribution Group).
- If a call arrives while you are using the call log, the call log display will be replaced with the caller's information.
- For a PS user, refer to "Operating Instructions" for PS.
- Caller's information received with a call waiting tone from the telephone company will not be logged in the call log.



Customizing Your Phone

- 3.1.3 Customizing the Buttons
Create or edit a Call Log button or Call Log for ICD Group button.

◆◆ Outgoing Call Log

You can redial using the outgoing call log.

To call

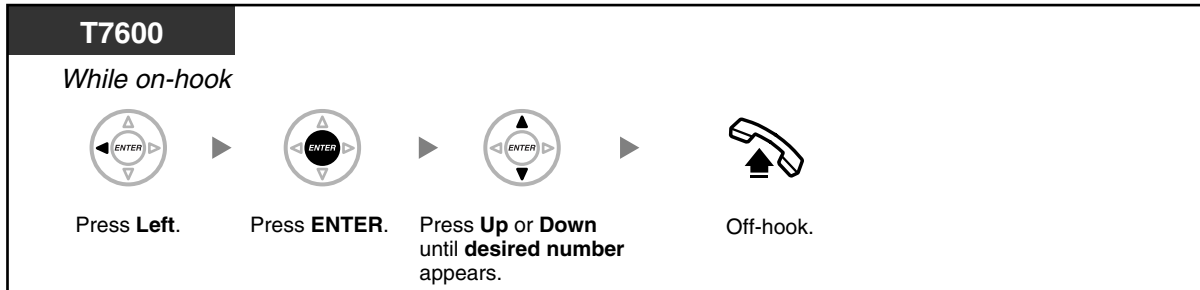

To call with the REDIAL button

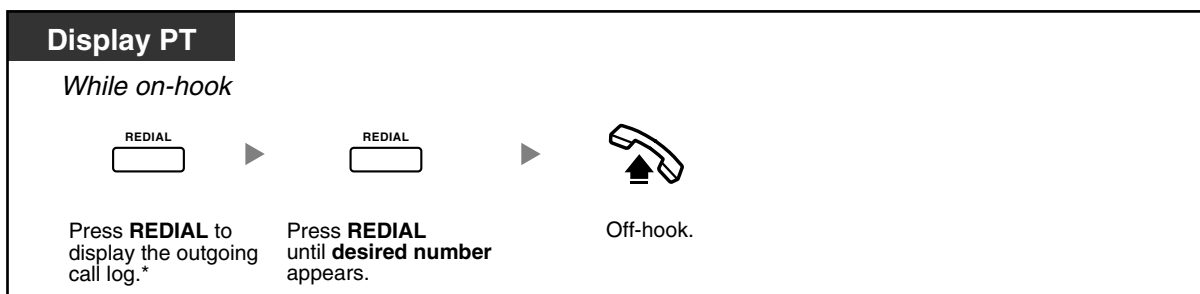

- * System programming is required for this operation. Consult your dealer.
- This operation is available only for digital proprietary telephones with a display.

To store the caller's information in personal speed dialing

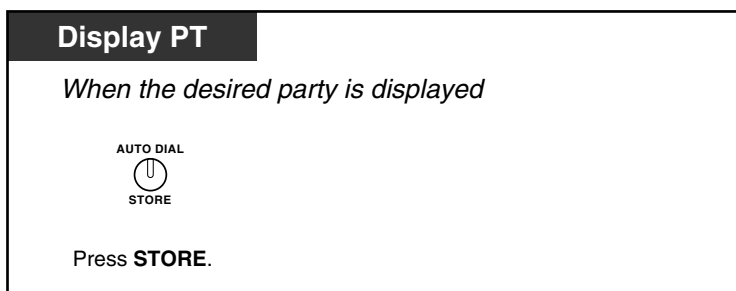

- You can lock your call log by using an extension PIN (Personal Identification Number), so that you can prohibit access to your logged information. Refer to "3.1.2 Settings on the Programming Mode".
- If a call arrives while you are using the call log, the call log display will be replaced with the caller's information.
- For a PS user, refer to "Operating Instructions" for PS.

1.11.2 Directories

You can select and call using the directories (*Personal Speed Dialing Directory, System Speed Dialing Directory and Extension Number Directory*).

Only personal directories can be stored, edited or deleted on your extension.

If a call arrives while you are using a directory, the display will be replaced with the caller's information.

- Calling with the Directory
- Storing Names and Numbers
- Entering Characters

◆◆ Calling with the Directory

To select and call

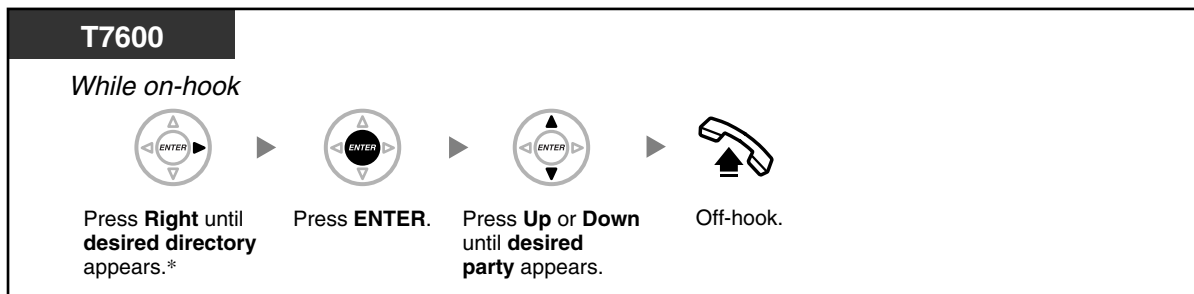

- * The display order is as follows:
One time: Personal Speed Dialing Directory
Two times: System Speed Dialing Directory
Three times: Extension Number Directory
- To cancel or exit, press the CANCEL or FLASH button, or press "EXIT" on the display.



- Directory entries generally should include name and number. If the name is not registered, an entry cannot be displayed.
- The System Speed Dialing Directory can be displayed simply by pressing the AUTO DIAL button while on-hook.

◆◆ Storing Names and Numbers

To store a Personal Speed Dialing Directory item

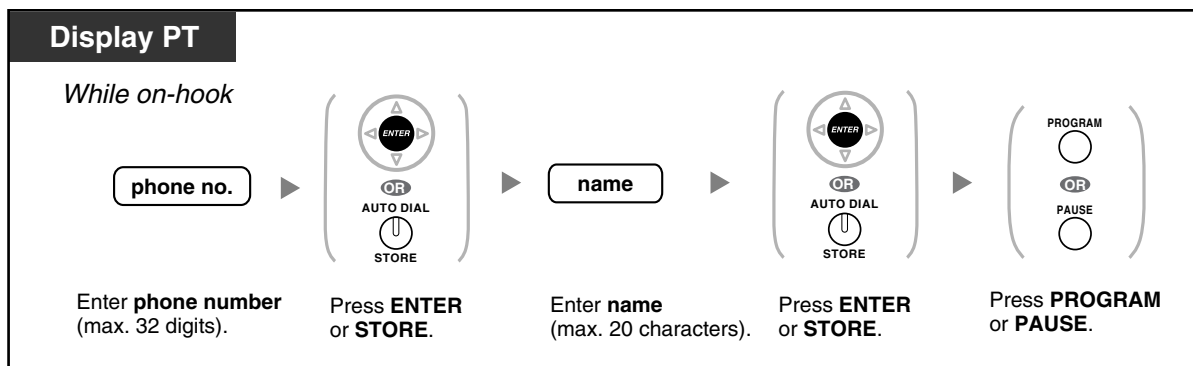



- Telephone number and name on the display are stored using the first spare Personal Speed Dialing memory available.
- For a PS user, refer to "Operating Instructions" for PS.



- For more details, refer to "To store the names and numbers in personal speed dialing" in "3.1.2 Settings on the Programming Mode".

◆◆ Entering Characters

You can enter the following characters. The tables show you the characters available for each button. Table 1 or Table 2 can be programmed.

Table 1 (Standard mode)

Times Buttons	1	2	3	4	5	6	7	8	9
1	!	?	"	1					
2	A	B	C	a	b	c	2		
3	D	E	F	d	e	f	3		
4	G	H	I	g	h	i	4		
5	J	K	L	j	k	l	5		
6	M	N	O	m	n	o	6		
7	P	Q	R	S	p	q	r	s	7
8	T	U	V	t	u	v	8		
9	W	X	Y	Z	w	x	y	z	9
0	(space)	.	,	'	:	;	0		
*	/	+	-	=	<	>	*		
#	\$	%	&	@	()	€	£	#

Table 2 (Option mode)

Times Buttons	1	2	3	4	5	6	7	8	9	10	11	12	13	14	15
1	!	?	"	ä	ö	ü	1								
2	A	B	C	a	b	c	À	Á	Â	Ã	Ä	Å	Æ	Ç	2
3	D	E	F	d	e	f	Ð	È	É	Ê	Ë	3			
4	G	H	I	g	h	i	Î	Í	Ï	4					
5	J	K	L	j	k	l	5								
6	M	N	O	m	n	o	Ñ	Ò	Ó	Ô	Õ	Ö	Ø	Œ	6
7	P	Q	R	S	p	q	r	s	ß	7					
8	T	U	V	t	u	v	Û	Ú	Û	Ü	8				
9	W	X	Y	Z	w	x	y	z	Ý	9					
0	(space)	.	,	'	:	;	0								
*	/	+	-	=	<	>	*								
#	\$	%	&	@	()	€	£	#						

1.11.3 System Feature Access

You can access a feature with the "Feature Access" menu.

To access "Feature Access" menu and select the feature

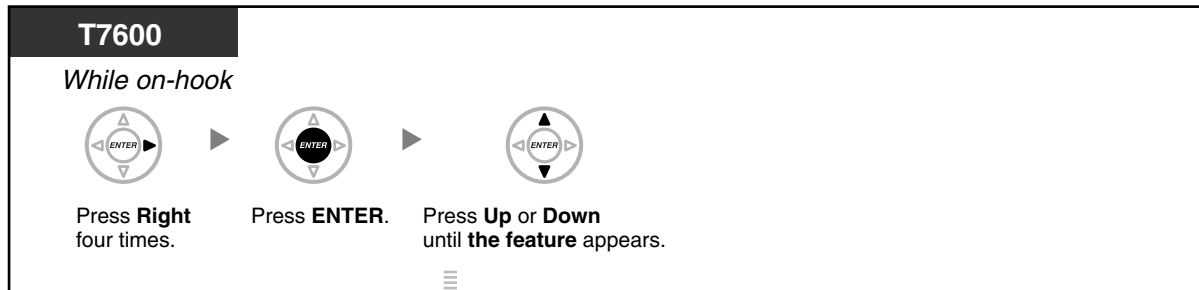

Features	Refer to
Automatic Callback Busy Cancel	1.2.4 When the Dialed Line is Busy or There is No Answer
Group Call Pickup	1.3.3 Call Pickup
Directed Call Pickup	1.3.3 Call Pickup
Doorphone Call	1.9.1 Doorphone/Door Opener
Door Open	1.9.1 Doorphone/Door Opener
External Background Music	2.1.4 External Background Music (BGM)
Paging	1.6.1 Paging

Section 2

Manager Operation

This chapter shows the manager how to control the other extensions or the PBX.

2.1 Control Features

2.1.1 Extension Control

The manager extension can control the settings of other extensions.
 — Changing the Settings of Other Extensions

◆◆ Changing the Settings of Other Extensions

Remote Extension Lock

This feature is also known as Remote Station Lock Control.

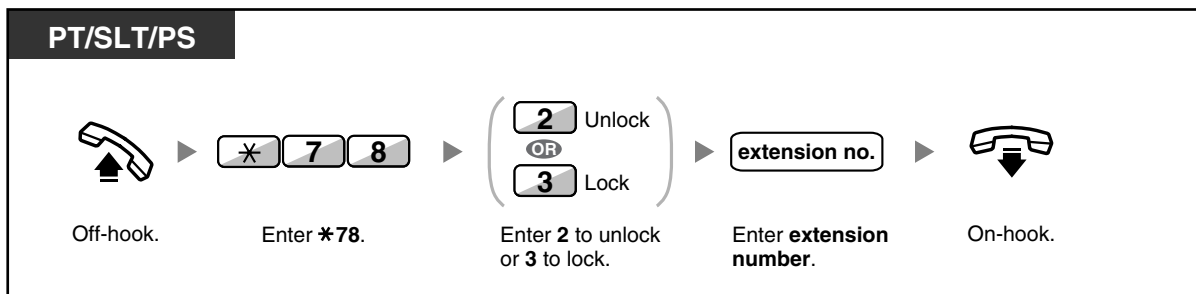

- If your extension is unlocked by the Remote Extension Lock feature, the Extension Lock assigned by itself will be unlocked.

2.1.2 Time Service Mode Control

The manager extension or the preprogrammed extension can change the time mode (Day, Lunch, Break or Night).

There are two methods (Automatic or Manual) of changing the time modes.

Automatic: enables the time mode for each day of the week to change automatically. You may also change it manually.

Manual: enables to change a mode in manual as follows.

To change the time mode (Day/Night/Lunch/Break)

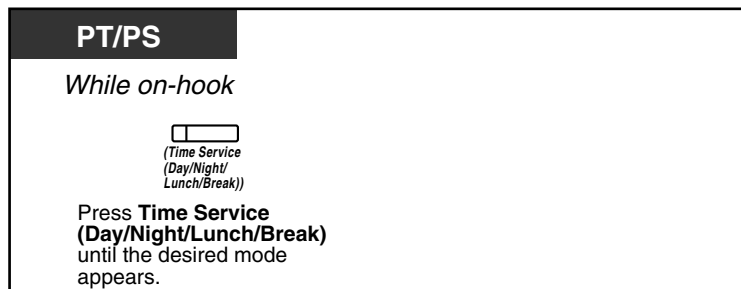

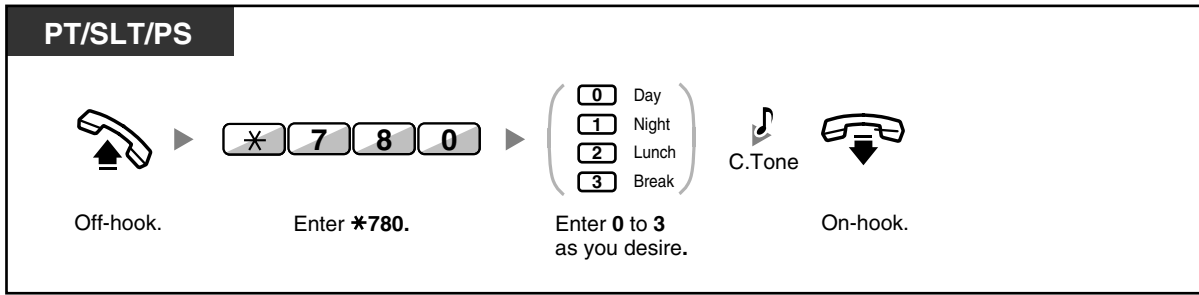

To select the time service switching mode (Automatic/Manual)

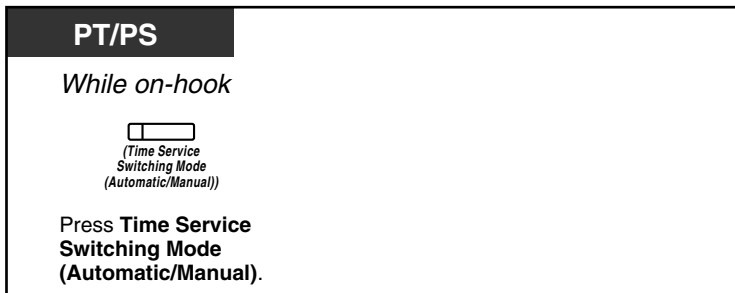

-  • Besides the time mode, there is Holiday mode. It can change mode once on a specified date.
- The Time Service (Day/Night/Lunch/Break) button light shows the current status as follows:
 - Off:** Day mode
 - Green on:** Lunch mode
 - Flashing Green:** Break mode
 - Red on:** Night mode
 - Flashing Red:** Holiday mode
- The Time Service Switching Mode (Automatic/Manual) button light shows the current status as follows:
 - Off:** Automatic
 - Red on:** Manual

Customizing Your Phone

- 3.1.3 Customizing the Buttons
Create or edit a Time Service (Day/Night/Lunch/Break) button or a Time Service Switching Mode (Automatic/Manual) button.

2.1.3 Dial Tone Transfer

The manager can change the restriction level, permitting an extension to make a call.



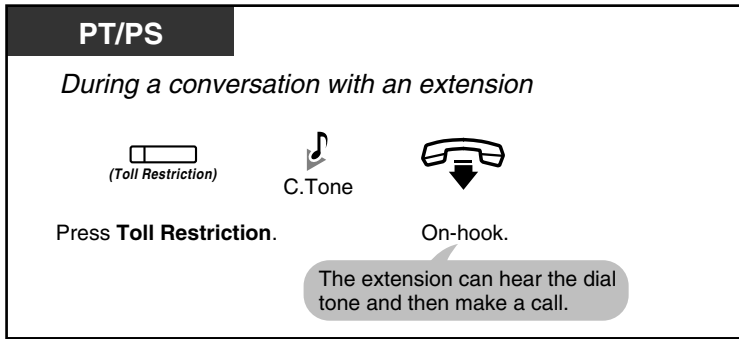

- The restriction level is changed to the preprogrammed level of Toll Restriction button.



Customizing Your Phone

- 3.1.3 Customizing the Buttons
Create or edit a Toll Restriction (TRS) button.

2.1.4 External Background Music (BGM)

The manager extension can broadcast background music in the office through external speakers.

To start/stop the background music

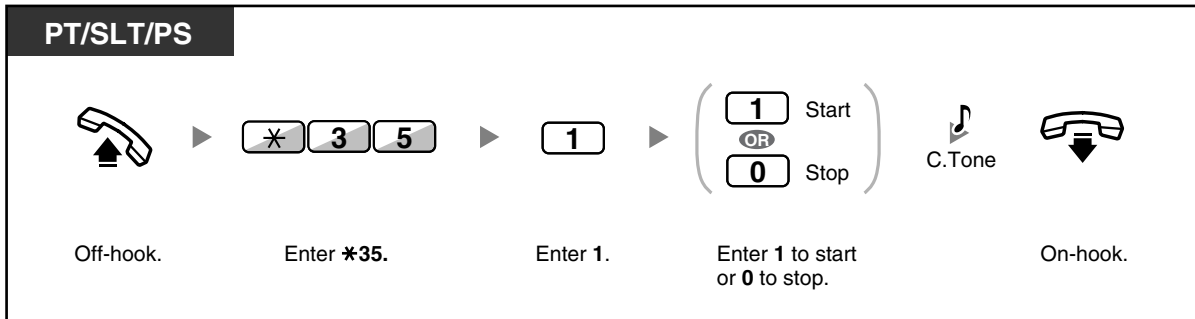

2.1.5 Outgoing Messages (OGM)

The manager extension can record three kinds of greeting messages (OGM) as follows:

1. **DISA message:** Used to greet and guide callers so that they access extension group or outside party without operator assistance.
2. **Incoming Call Distribution Group message:** Used to greet and guide callers to an incoming call distribution group.
3. **Timed Reminder message:** Used for a wake-up call message when the extension answers the Timed Reminder.



All messages have their own extension numbers. You can select the desired message. You have two methods for recording a message. One is recorded using the handset, and the other is recorded from an external BGM (MOH) port.

To record

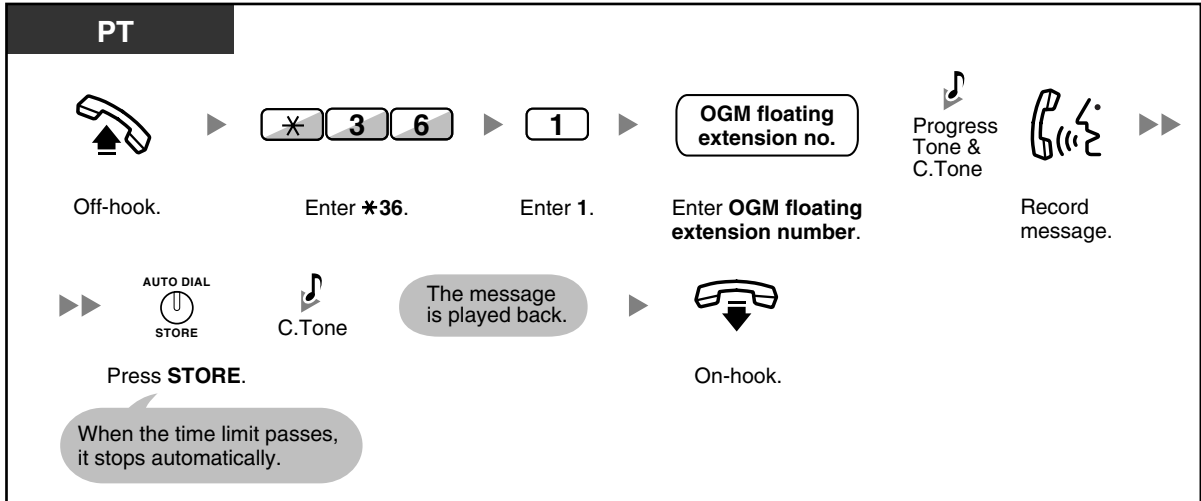

To play back

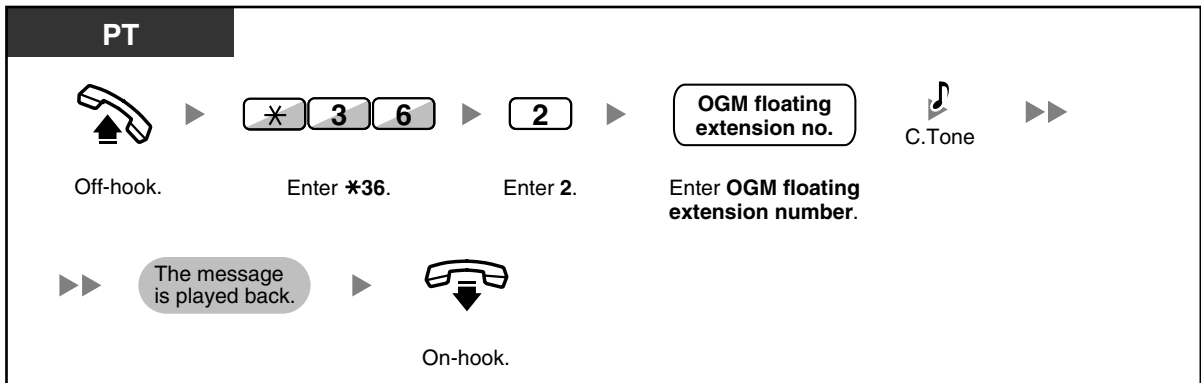

To record from an external BGM (MOH) port

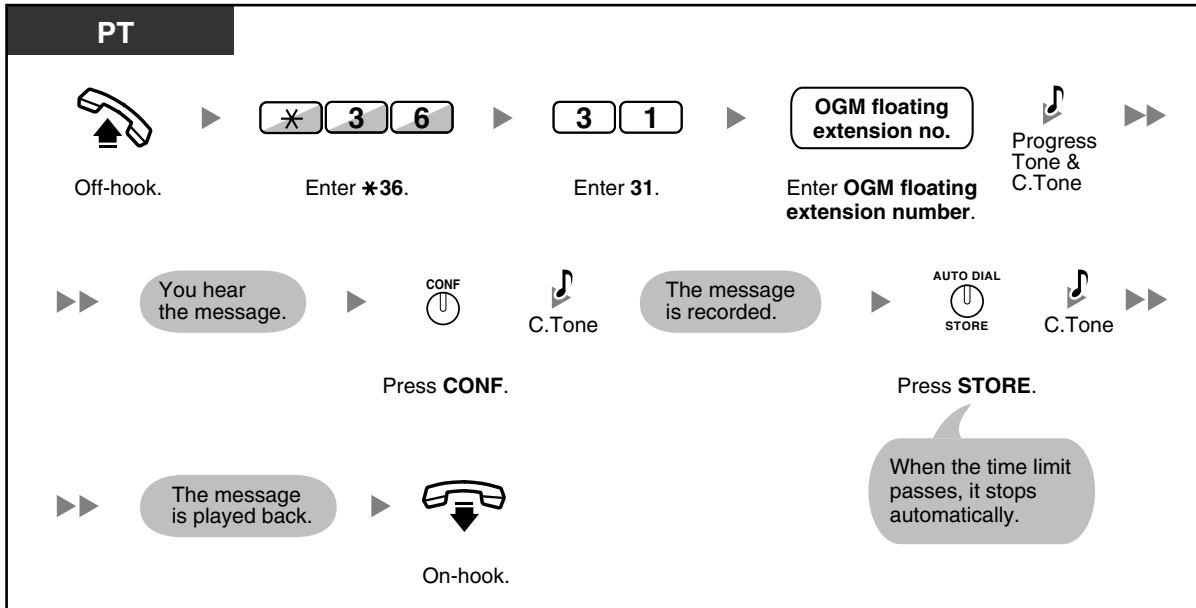

To clear the message

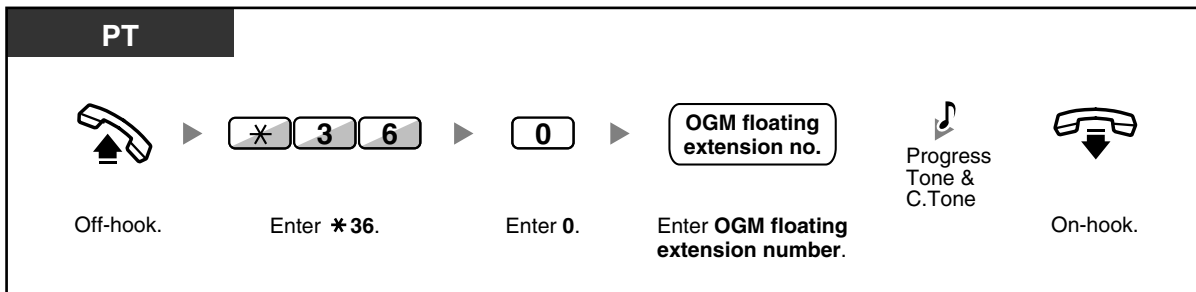

- Record voice messages only; avoid the recording of music.



Section 3

Customizing Your Phone & System

This chapter shows you how to customize your individual telephone or PBX according to your needs. Find the desired setting and program as necessary.

3.1 Personal Programming

3.1.1 Personal Programming

You can customize your telephone features. For example, you can change the initial settings or button features according to your needs.

— Extension PIN (Personal Identification Number)



- If you change your desk and extension, refer to "1.10.1 Walking Extension".

◆◆ Extension PIN (Personal Identification Number)

You can assign a password to each extension.
The following features require an extension PIN.

1. Screening calls (Live Call Screening [LCS])
2. Prohibiting other people from seeing your personal directory and call log (Directory and Call Log Lock)
3. Using the same settings as your extension at other extensions (Walking Extension)
4. Remote Control Operation (Walking COS)
5. Extension Lock Clear

To set

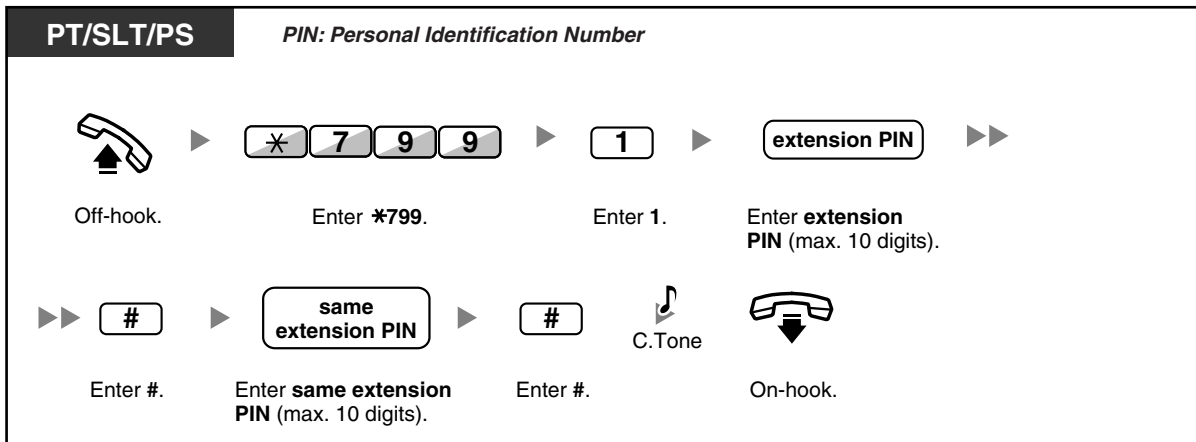

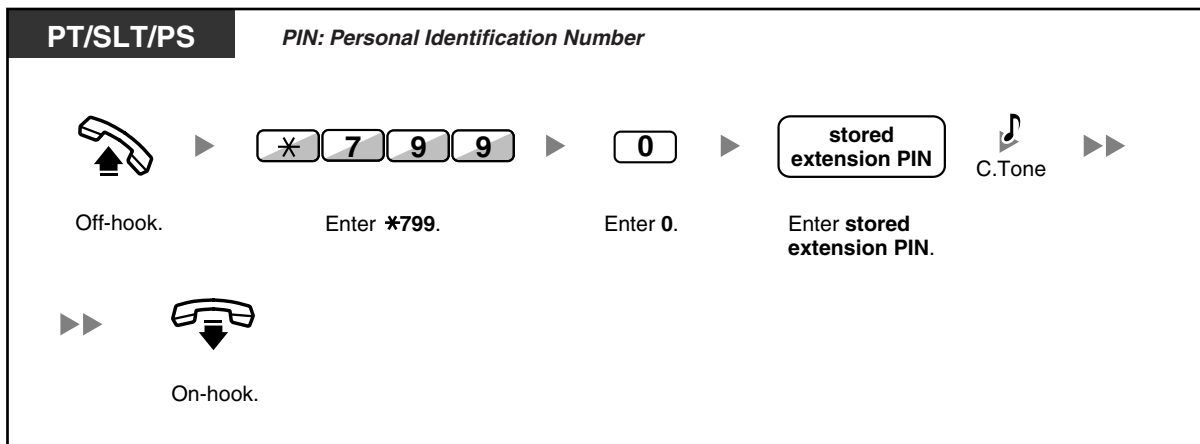
To cancel

- **WARNING**
When a third party discovers the password (extension PIN) of the PBX, there will be a risk that they will make fraudulent phone calls using the telephone line, and the cost will be charged to your own account. In order to avoid this problem, we strongly recommend the following points:
 - a) Carefully maintain the secrecy of the PIN.
 - b) Specify a complicated PIN as long and random as you can make it.
 - c) Change the PIN frequently.
- Valid numbers for an extension PIN are "0" through "9".
- If the wrong extension PIN is entered for a preprogrammed number of times, the PIN is locked.
- If you forget your extension PIN or your extension PIN is locked, your manager can clear the extension PIN and extension PIN lock.

3.1.2 Settings on the Programming Mode

You can program features using the programming mode.

- Setting Features
- Clearing Features



- To exit at any time, lift the handset.
- To enter the programming mode when using a PS, refer to "Operating Instructions" for PS.



◆◆ Setting Features

The default settings are shown in bold letters. For later reference, place a check mark in the boxes below to indicate your customized setting.

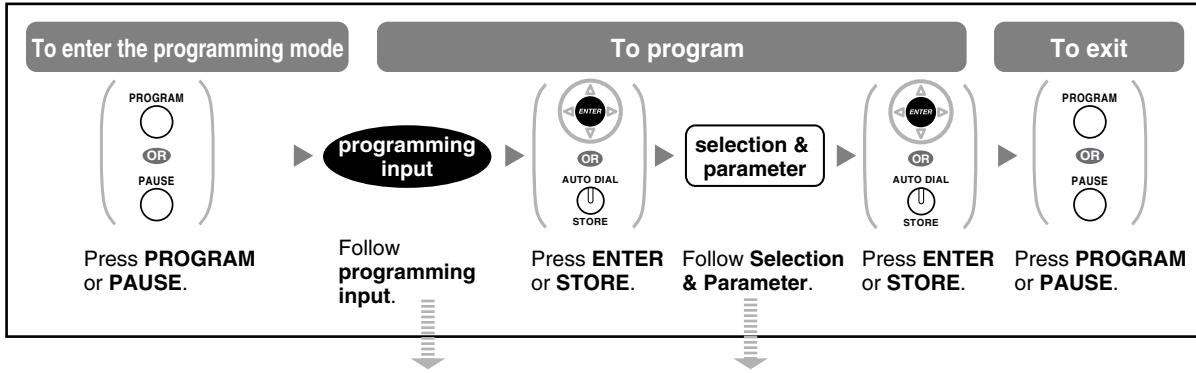
3.1 Personal Programming



Item	Programming Input	Selection & Parameter
Your extension information	[0] [0]	<p>PT: The display shows the PBX number, slot number and port number. <example></p> <p style="text-align: center;">EXT1050:10308 PBX no. Port no. Slot no.</p> <p>PS: The display shows the PS number. <example></p> <p style="text-align: center;">EXT3001:99001 PS no.</p>
Preferred display contrast level from the 4 levels available. (Display Contrast Selection)*1	[0] [1]	[1] <input type="checkbox"/> Light
		[2] <input type="checkbox"/> Little Light
		[3] <input type="checkbox"/> Little Dark
		[4] <input type="checkbox"/> Dark
Which display language do you prefer? (Display Language Selection)	[0] [2]	[1] <input type="checkbox"/> English
		[2] <input type="checkbox"/> 2nd Language
		[3] <input type="checkbox"/> 3rd Language
		[4] <input type="checkbox"/> 4th Language
		[5] <input type="checkbox"/> 5th Language

Item	Programming Input	Selection & Parameter	
Would you like the call duration to be shown automatically on the display when answering an outside call? (Display Switching Mode)	<input type="checkbox"/> 0 <input type="checkbox"/> 3	<input type="checkbox"/> 0	<input type="checkbox"/> No—Manual (The display keeps showing all of the outside caller's information unless you change it to the call duration manually.)
		<input type="checkbox"/> 1	<input type="checkbox"/> Yes—Automatic (The first line of the display will change to the call duration automatically when you answer an outside call.)
Would you like to turn on the display backlight of the KX-T7633/KX-T7636? (Display Backlight Selection)*1	<input type="checkbox"/> 0 <input type="checkbox"/> 4	<input type="checkbox"/> 0	<input type="checkbox"/> Yes—ON in use
		<input type="checkbox"/> 1	<input type="checkbox"/> Yes—always ON
		<input type="checkbox"/> 2	<input type="checkbox"/> No—always OFF
Would you like to dial a preset number simply by going off-hook?	<input type="checkbox"/> 1 <input type="checkbox"/> 1	desired no. (max. 32 digits)	
	<input type="checkbox"/> 1 <input type="checkbox"/> 2	<input type="checkbox"/> 0	<input type="checkbox"/> Do not use
		<input type="checkbox"/> 1	<input type="checkbox"/> Use
Should you prevent your number being displayed on the called party's telephone? (Calling Line Identification Restriction [CLIR])	<input type="checkbox"/> 1 <input type="checkbox"/> 3	<input type="checkbox"/> 0	<input type="checkbox"/> No—Allows your number to be displayed
		<input type="checkbox"/> 1	<input type="checkbox"/> Yes—Prevents your number being displayed
Which do you prefer to seize when you go off-hook to make calls? (Preferred Line Assignment—Outgoing)	<input type="checkbox"/> 1 <input type="checkbox"/> 9	<input type="checkbox"/> 0	<input type="checkbox"/> No line
		<input type="checkbox"/> 1	<input type="checkbox"/> An idle CO line
		<input type="checkbox"/> 2 + CO button no.*2 (01-36) or  (CO)	<input type="checkbox"/> A CO/G-DN button
		<input type="checkbox"/> 3 or INTERCOM 	<input type="checkbox"/> Intercom

3.1 Personal Programming

Item	Programming Input	Selection & Parameter	
Which line do you prefer to answer when you go off-hook? (Preferred Line Assignment—Incoming)	2 0	0	<input type="checkbox"/> No line
		1	<input type="checkbox"/> The longest ringing line (when multiple calls arrive)
		2 + CO button no.*2 (01-36) or <input type="checkbox"/> (CO)	<input type="checkbox"/> A assigned outside button
How do you prefer to receive an intercom call? (Alternate Receiving—Ring/Voice)*1	2 1	0	<input type="checkbox"/> Ringing (Tone Call)
		1	<input type="checkbox"/> Directly—The party's voice is heard without ringing.
		2	<input type="checkbox"/> Ring only—Prohibiting the caller switching to the voice mode.
Should the single line telephone in parallel ring? (Paralleled Telephone)*1	2 2	0	<input type="checkbox"/> No—The telephone will not ring.
		1	<input type="checkbox"/> Yes—The telephone will ring.
Do you prefer to answer a call without going off-hook regardless of the AUTO ANS button status? (Forced Answerback Selection)*1	2 3	0	<input type="checkbox"/> No—Disable
		1	<input type="checkbox"/> Yes—Enable
Which service do you prefer when a calling party is recording a message in your mailbox? (Live Call Screening Mode Set)*1	2 5	0	<input type="checkbox"/> You can monitor the message through the telephone speaker. (Hands-free mode)
		1	<input type="checkbox"/> Only an alarm tone is heard. (Private mode)
Would you like to keep recording after answering the call in the LCS mode? (LCS Mode Set [After Answering])	2 6	0	<input type="checkbox"/> No—Stop recording
		1	<input type="checkbox"/> Yes—Keep recording

Item	Programming Input	Selection & Parameter	
Do you prefer to receive call waiting for outside calls?	3 0	0	<input type="checkbox"/> No (No tone)
		1	<input type="checkbox"/> Yes (Tone)
Which type of call waiting for intercom calls do you prefer? (Call Waiting Selection)	3 1	0	<input type="checkbox"/> No call
		1	<input type="checkbox"/> Tone
		2	<input type="checkbox"/> Voice announcement through the built-in speaker (OHCA)*3
		3	<input type="checkbox"/> Voice announcement through the handset (Whisper OHCA)*3
Which type of call waiting tone do you prefer? (Call Waiting Tone Type Selection)	3 2	0	<input type="checkbox"/> Tone 1
		1	<input type="checkbox"/> Tone 2
Would you like to show a message on the caller's telephone display? (Absent Message)	4 0	0	<input type="checkbox"/> No—Off
		message no. (1-8)	<input type="checkbox"/> Yes—Shows the selected message.
		9	<input type="checkbox"/> Yes—Shows your personal message.
Creating your personal message. (Personal Absent Message)	4 1	message (max. 16 characters)	

3.1 Personal Programming

Item	Programming Input	Selection & Parameter	
Where are your incoming calls forwarded or refused? (Call Forwarding [FWD]/Do Not Disturb [DND])		0	<input type="checkbox"/> Off
	5 0 / 	1	<input type="checkbox"/> Do Not Disturb (DND)
	(for both calls)	2 + desired no. (max. 32 digits)	<input type="checkbox"/> All—Forward all calls
	5 1 (for outside calls)	3 + desired no. (max. 32 digits)	<input type="checkbox"/> Busy—Forwarded when your extension is busy.
	5 2 (for intercom calls)	4 + desired no. (max. 32 digits)	<input type="checkbox"/> No Answer—Forwarded when you do not answer.
		5 + desired no. (max. 32 digits)	<input type="checkbox"/> Busy/No Answer—Forwarded when you do not answer or when your extension is busy.
To set the timer for "No Answer" and "Busy/No Answer". (FWD N/A Timer)	5 3	<input type="text"/> (0-120) seconds (Default: 15 seconds)	
Should you prohibit other people from picking up your calls? (Call Pickup Deny)	6 0	0	<input type="checkbox"/> No—Allow
		1	<input type="checkbox"/> Yes—Deny
Do you use the headset? (Headset Operation)*1	6 1	0	<input type="checkbox"/> No—Headset off
		1	<input type="checkbox"/> Yes—Headset on
Do you prohibit other people from joining your conversation? (Executive Busy Override Deny)	6 2	0	<input type="checkbox"/> No—Allow
		1	<input type="checkbox"/> Yes—Deny
Would you like to prohibit paging announcements? (Paging Deny)*1	6 3	0	<input type="checkbox"/> No—Allow
		1	<input type="checkbox"/> Yes—Deny
Do you prefer to hear the key pad tone? (Key Pad Tone Set)*1	6 4	0	<input type="checkbox"/> No—Off
		1	<input type="checkbox"/> Yes—On

Item	Programming Input	Selection & Parameter	
Do you want back ground music through your telephone speaker while on-hook? (Background Music [BGM])* ¹	6 5	0	<input type="checkbox"/> No—Off
		1 1	<input type="checkbox"/> Yes—On
Would you like to set your extension PIN or change a stored extension PIN to new one? (Extension PIN [Personal Identification Number])	9 0	extension PIN (max. 10 digits) + ENTER/STORE + same extension PIN	To set an extension PIN
		stored extension PIN + new extension PIN (max. 10 digits) + ENTER/STORE + same extension PIN	To change a stored extension PIN to new one
To prevent other people from using your telephone. (Extension Lock)	9 1	extension PIN (max. 10 digits) + 0	<input type="checkbox"/> To unlock
		extension PIN (max. 10 digits) + 1	<input type="checkbox"/> To lock
To prevent other people from seeing your personal directory and call log. (Directory and Call Log Lock)* ¹	9 2	extension PIN (max. 10 digits) + 0	<input type="checkbox"/> To unlock
		extension PIN (max. 10 digits) + 1	<input type="checkbox"/> To lock
Do you prefer to set the One-touch dialing only? (One-touch Dialing Assignment Mode Selection)	# *	0	<input type="checkbox"/> No—Normal (Any Flexible CO buttons can be modified.)
		1	<input type="checkbox"/> Yes—Only One-touch dialing buttons can be modified. However, to modify them, there is no need to enter "2" before the number.

*1: Not available for a PS

*2: CO button numbers (25-36) are available only when the Add-on Key Module is set up to your telephone.

*3: Only available for certain digital proprietary telephones. Consult your dealer.



- **WARNING**
When a third party discovers the password (extension PIN) of the PBX, there will be a risk that they will make fraudulent phone calls using the telephone line, and the cost will be charged to your own account. In order to avoid this problem, we strongly recommend the following points:
a) Carefully maintain the secrecy of the PIN.
b) Specify a complicated PIN as long and random as you can make it.
c) Change the PIN frequently.
- After the program number is entered, the program title is displayed.
The programming screen can be changed with the Navigator key (Up or Down).



- You can select the parameter with the Navigator Key (Up or Down) instead of entering a number.

To store the names and numbers in personal speed dialing

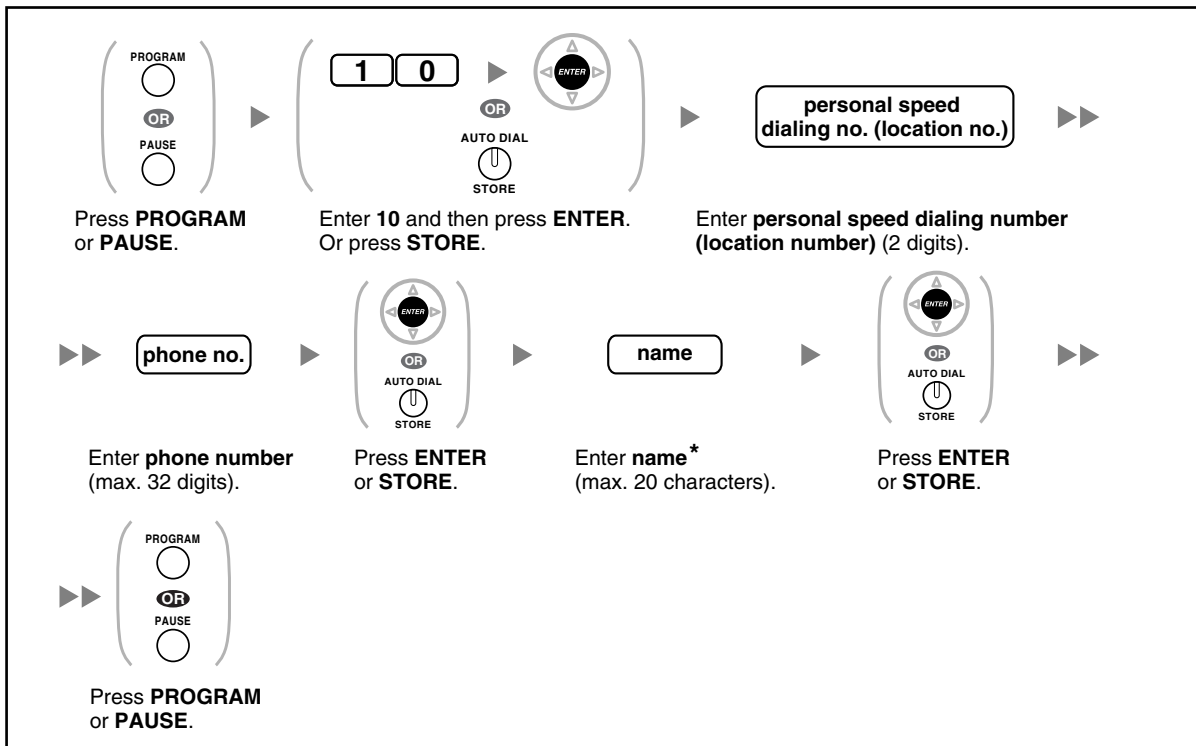

- * To enter characters, refer to "Entering Characters".

To edit the names and numbers of personal speed dialing

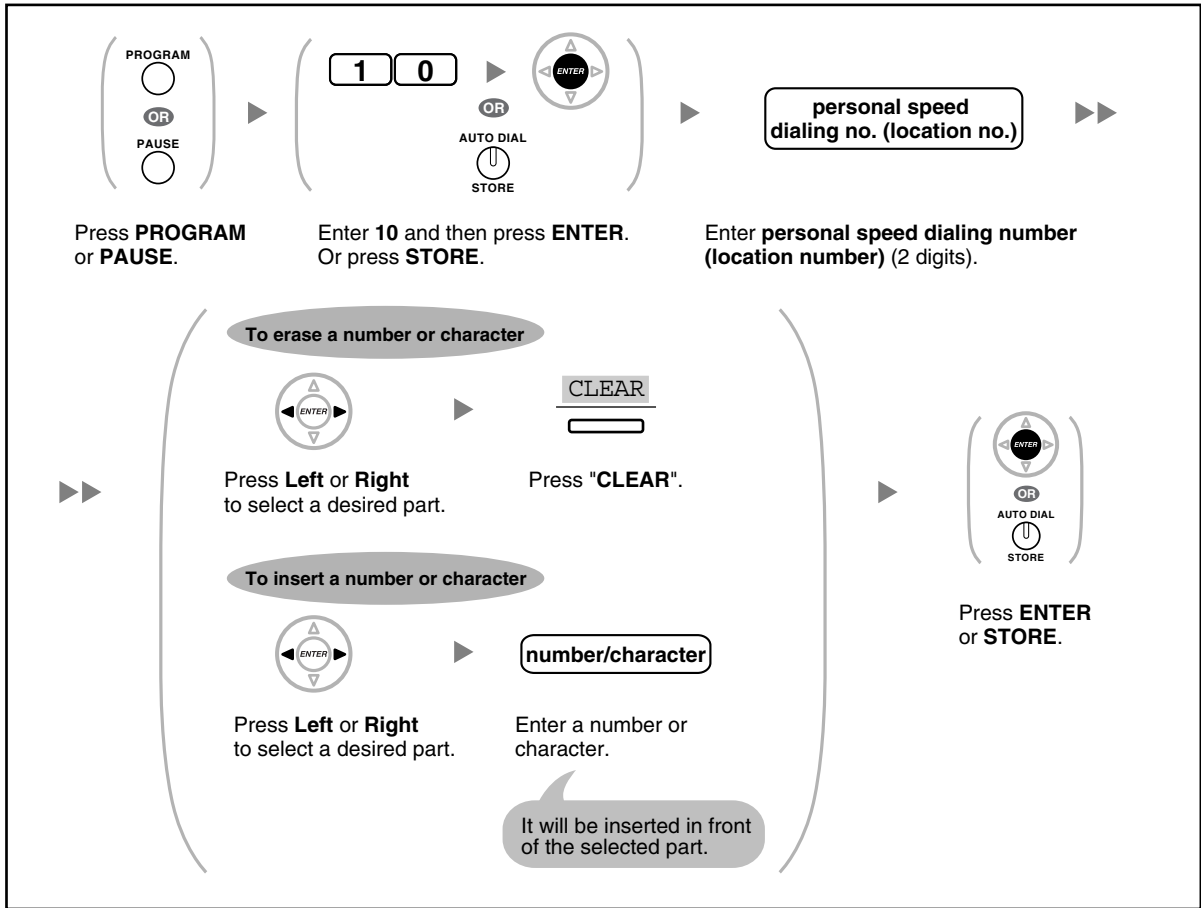

◆◆ Clearing Features

You can reset the settings of the following features on your extension to the default settings with one operation.

Features	Default Setting
Display Switching Mode	Automatic
Hot Line	Off
Calling Line Identification Restriction [CLIR]	Allow
Preferred Line Assignment—Outgoing	Intercom
Preferred Line Assignment—Incoming	The longest ringing line
Alternate Receiving—Ring/Voice	Ringing (Tone Call)
Paralleled Telephone	Paired SLT will ring
Forced Answerback Selection	Disable
Live Call Screening Mode Set	Hands-free mode
LCS Mode Set [After Answering]	Stop recording

3.1 Personal Programming

Features	Default Setting
Call Waiting Selection—Intercom Calls/Outside Calls	Enable (Tone)
Call Waiting Tone Type Selection	Tone 1
Absent Message	Off
Personal Absent Message	Cleared
Call Forwarding [FWD]/Do Not Disturb [DND]—Intercom Calls/Outside Calls	Off
FWD N/A Timer	15 seconds
Call Pickup Deny	Allow
Headset Operation	Headset off
Executive Busy Override Deny	Allow
Paging Deny	Allow
Key Pad Tone Set	On
Background Music [BGM]	Off
Data Line Security	Off
Log-in/Log-out	Log-in
Message Waiting	Off
Timed Reminder	Cleared

To set

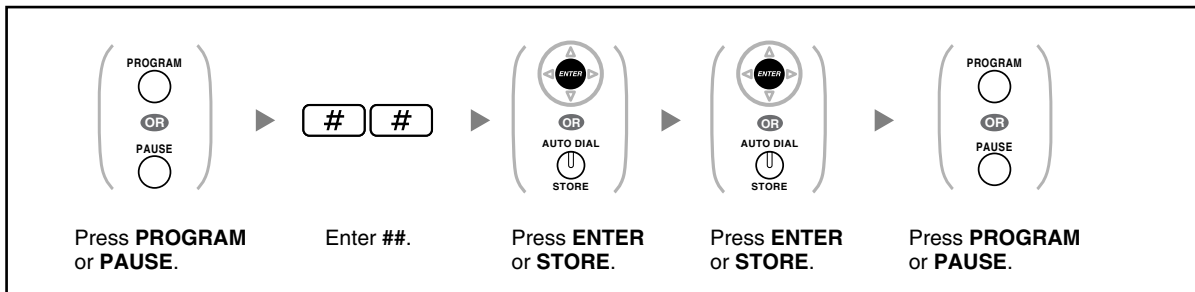

- If you do not desire that the Call Waiting, FWD/DND or Hot Line to be cleared by this feature, please ask your dealer.

3.1.3 Customizing the Buttons

You can change the flexible CO buttons/DSS buttons, and programmable feature (PF) buttons on PTs, DSS Consoles, Add-on Key Modules, and PSs to the following function buttons. For example, if your telephone has more CO buttons than available CO lines, you may change unused CO buttons to one touch buttons.



- To enter the programming mode when using a PS, refer to "Operating Instructions" for PS.

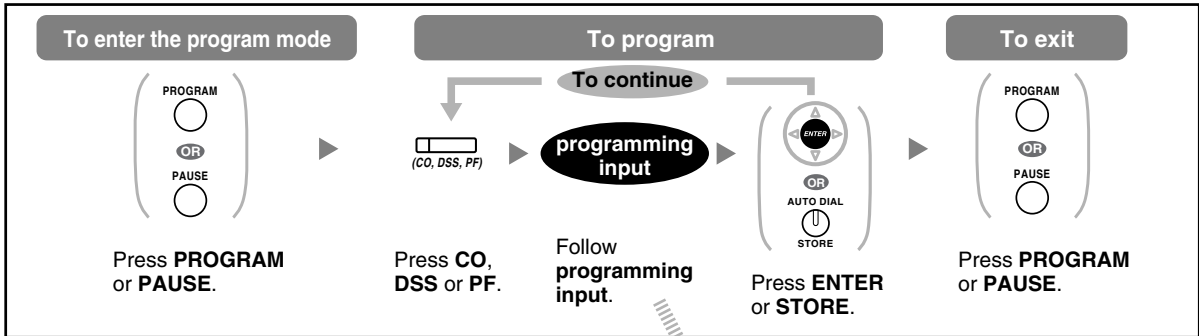

Buttons	Programmable Button			Programming Input
	CO	DSS	PF	
Loop-CO (L-CO)	✓	✓		*
Group-CO (G-CO)	✓	✓		# + CO line group no. (2 digits)
Single-CO (S-CO)	✓	✓		0 + CO line no. (3 digits)
Direct Station Selection (DSS)	✓	✓		1 + Extension no.
One-touch Dialing* ¹	✓	✓	✓	2 ^{*2} + Desired no. (max. 32 digits)
Group Directory Number (G-DN)	✓	✓		3 0 + Incoming call distribution group extension no.
Message	✓	✓		4 0
Message for another extension	✓	✓		4 0 + Extension no./Incoming call distribution group extension no.
Call Forwarding (FWD)/Do Not Disturb (DND)—Both calls	✓	✓		4 1
FWD/DND—Outside calls	✓	✓		4 2
FWD/DND—Intercom calls	✓	✓		4 3
Group FWD—Both calls	✓	✓		4 4 + Incoming call distribution group extension no.
Group FWD—Outside calls	✓	✓		4 5 + Incoming call distribution group extension no.

3.1 Personal Programming

Buttons	Programmable Button			Programming Input
	CO	DSS	PF	
Group FWD—Intercom calls	✓	✓		4 6 + Incoming call distribution group extension no.
Account	✓	✓		4 8
Conference	✓	✓		4 9
Terminate	✓	✓		5 0
External Feature Access (EFA)	✓	✓		5 1
Call Park	✓	✓		5 3 + Parking zone no. (2 digits)
Call Park (Automatic Park Zone)	✓	✓		5 3 *
Call Log* ³	✓	✓		5 4
Call Log for ICD Group* ³	✓	✓		5 4 + Incoming call distribution group extension no.
Log-in/Log-out	✓	✓		5 5
Log-in/Log-out of a specified group	✓	✓		5 5 + Incoming call distribution group extension no.
Log-in/Log-out for all groups	✓	✓		5 5 *
Hurry-up	✓	✓		5 6 + Incoming call distribution group extension no.
Wrap-up	✓	✓		5 7
System Alarm* ³	✓	✓		5 8
Time Service (Day/Night/Lunch/Break)	✓	✓		5 9 + 0/1/2/3* ⁴ (+ # + Tenant no.)
Answer* ³	✓	✓		6 0
Release* ³	✓	✓		6 1
Toll Restriction (TRS)	✓	✓		6 2 + Toll Restriction (TRS) Level (1-7)
Calling Line Identification Restriction (CLIR)	✓	✓		6 4

Buttons	Programmable Button			Programming Input
	CO	DSS	PF	
Connected Line Identification Restriction (COLR)	✓	✓		[6] [5]
Headset*3	✓	✓		[6] [7]
Time Service Switching Mode (Automatic/Manual)	✓	✓		[6] [8] (+ Tenant no.)
Two-way Record*5	✓	✓		[9] [0] + Voice mail floating extension no.
Two-way Transfer*5	✓	✓		[9] [1] + Voice mail floating extension no.
One-touch Two-way Transfer*5	✓	✓		[9] [1] + Voice mail floating extension no. + # + Extension no./Incoming call distribution group extension no.
Live Call Screening (LCS)*5	✓	✓		[9] [2]
Voice Mail Transfer*5	✓	✓		[9] [4] + Voice mail floating extension no.



- *1 "×," "#," FLASH/RECALL, PAUSE, SECRET (INTERCOM) and T (Transfer) can also be stored.

If you do not want to display the stored number when making a call, press the SECRET (INTERCOM) button before and after the numbers you wish to conceal.

If you store an outside party's number, you should first store a line access number.

If you need to enter an account code, you can enter the specified account code before the line access number.

<Example>

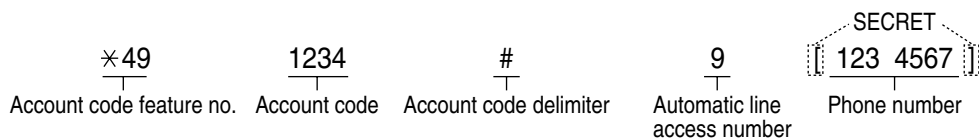

- *2 For a PF button, "2" is not required to enter before the desired number.
- *3 This button is not available for a PS.
- *4 0: Day/Night/Lunch/Break, 1: Day/Night/Break, 2: Day/Night/Lunch, 3: Day/Night
- *5 This button is used for the integrated voice mail features.
- To exit at any time**, lift the handset.



- You can select the parameter with the Navigator key (Up or Down) instead of entering a number.

To distinguish the ringing tones for each CO, INTERCOM or G-DN button (Digital proprietary telephone only)

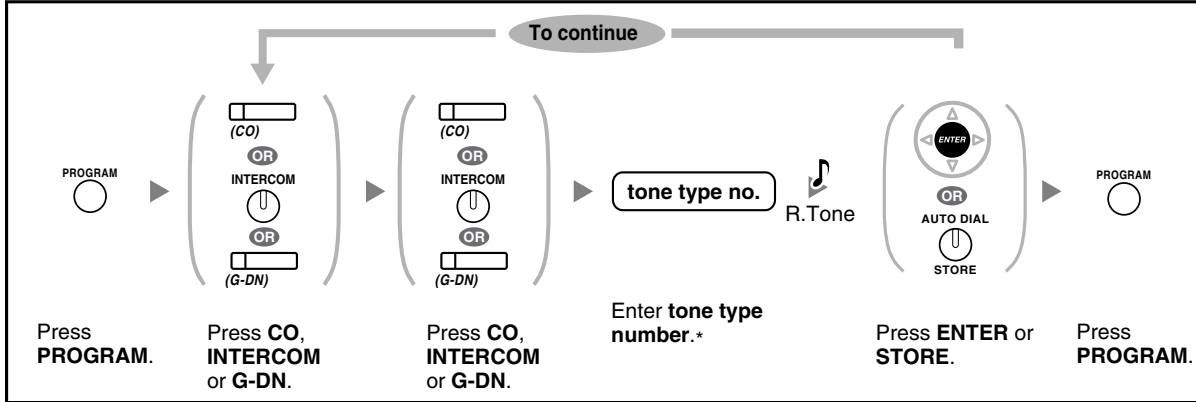

- * Available tone types vary depending on the telephone you are using:
 - KX-T7600 series: Tone types "01" to "30" are available.
 - Other telephones: Only tone types "01" to "08" are available. It is possible to enter a tone type number from "09" to "30", but you will hear tone type "02".

To clear the button

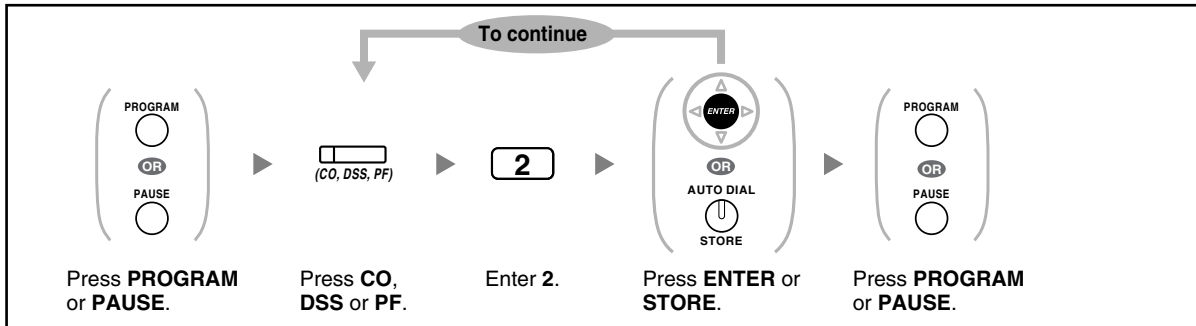

3.2 Manager Programming

3.2.1 Programming Information

The manager can program the following item.

- Other Extensions Control

Available Extension

The extension assigned as a manager

Required Telephone

A Panasonic Proprietary Telephone with display (over 2 lines)
(e.g., KX-T7636)

Manager Password

To enter programming mode, the manager password (max. 10 digits) is required. (Default: 1234)

Conditions

The programming extension must be idle, on-hook and holding no calls.

3.2.2 Manager Programming

◆◆ Changing the Settings and Extension Control

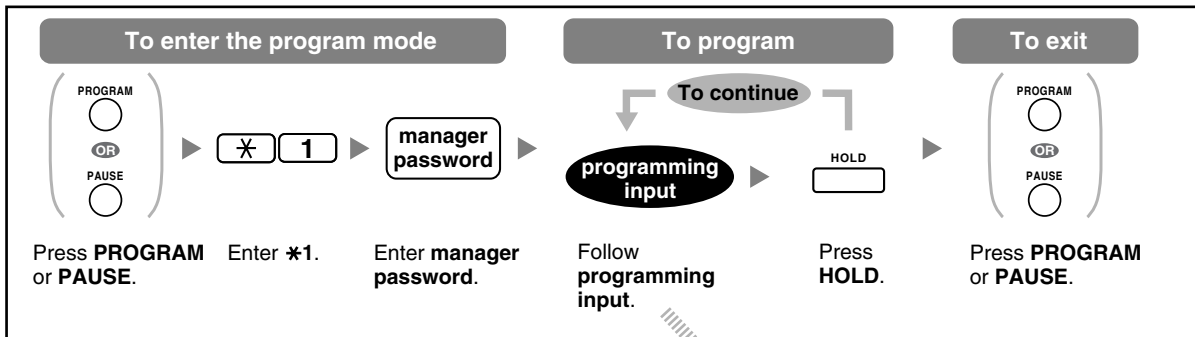

Item	Programming Input
Changing the manager password.	[0] [0] + + Password (max. 10 digits) +
Locking/unlocking other extensions. (Remote Extension Lock)	[9] [0] + + Extension no. + [1] (to lock)/ [0] (to unlock) +
Clearing the PIN and PIN lock for extensions.	[9] [1] + + Extension no. +
Clearing the PIN and PIN lock for verified codes.	[9] [2] + + Verified code +
Setting the verified code PIN.	[9] [3] + + Verified code + PIN (max. 10 digits) +



WARNING

When a third party discovers the password (verified code PIN) of the PBX, there will be a risk that they will make fraudulent phone calls using the telephone line, and the cost will be charged to your own account. In order to avoid this problem, we strongly recommend the following points:

- a) Carefully maintain the secrecy of the PIN.
- b) Specify a complicated PIN as long and random as you can make it.
- c) Change the PIN frequently.

3.3 System Programming

3.3.1 Programming Information

You can customize your system according to your requirements.
[Your system already has default settings (factory installed).]

The programming is shown below. (Program number)

- The date and time [000]
- System speed dialing numbers and names [001]/[002]
- Extension number and name [003]/[004]

Available Extension

The extension allowed through COS programming

Required Telephone

A Panasonic Proprietary Telephone with display (over 2 lines)
(e.g., KX-T7636)

System Password

To enter programming mode, the system password (max. 10 digits) is required. (Default: 1234)



















Conditions

The programming extension must be idle, on-hook and holding no calls.

List

Before programming, decide the settings and write them down. Your notes will provide a useful record of the programming for future reference. Your dealer also has programming records which contain all of the system programming. You may ask for photo copies of these tables to be aware of the facilities and features available.

◆◆ Icon Descriptions

Fixed Buttons		Function
T7600	T7200/T7400	
		PREVIOUS (PREV)
		NEXT
		➔
		➔
		STORE (ENTER)
	None	Back to Previous Menu (CANCEL)
		SHIFT
		PROGRAM
		END
		SELECT
		FLASH
		CLEAR
		SECRET

◆◆ Procedure

The basic steps are shown below.

1. *Entering the programming mode*

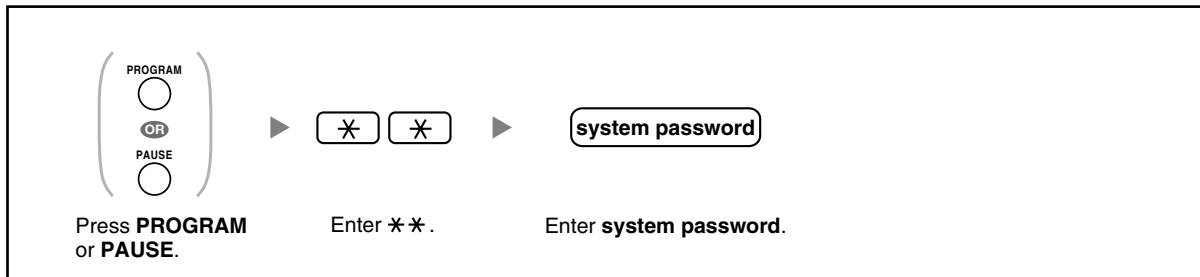

2. *Programming*

You can enter each program number (3 digits).



- To exit the programming mode at any time, lift the handset.

3. *Exiting the mode*

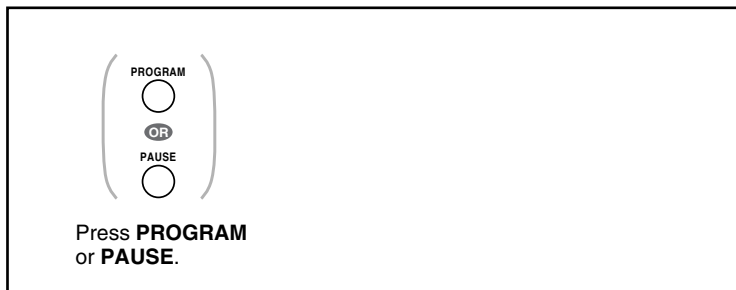

- To exit the programming mode at any time, lift the handset.

3.3.2 System Programming

◆◆ Date & Time [000]

The proprietary telephones display the current date and time while on-hook.

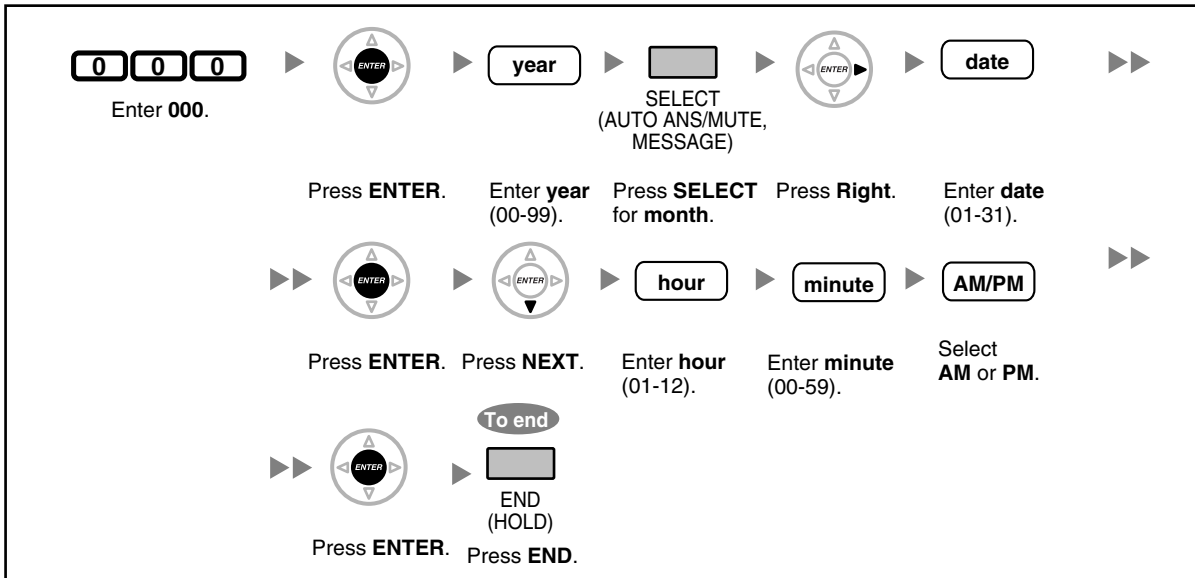

- **After changing the desired values**, you can press the ENTER button. You do not have to perform the rest of the steps.
- The clock starts immediately after the ENTER button is pressed.
- You cannot leave a value empty.
- You can clear the entry by pressing the CLEAR button.
- **To confirm your entry after storing data:**
 - The STORE button light: Lights red.
 - Confirmation Tone:
 - One beep: Your entry is accepted.
 - Three beeps: Your entry is rejected.

◆◆ System Speed Dialing Number [001]

You can store the phone numbers of frequently dialed numbers.

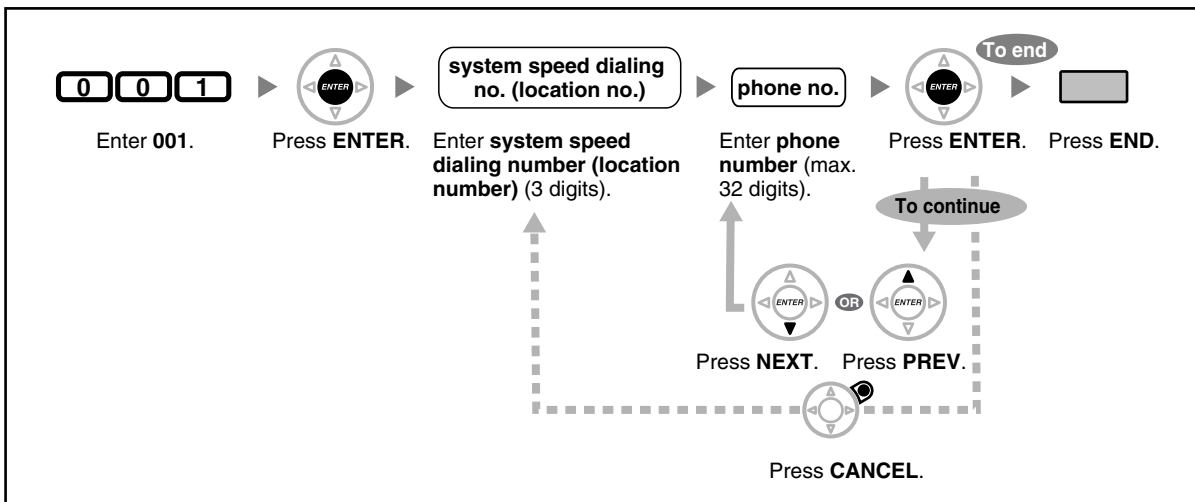



- If the desired number is more than 32 digits, divide the number and store it into a speed dialing number.
- "*", "#", FLASH/RECALL, PAUSE, and SECRET (INTERCOM) can also be stored.
If you do not want to display the stored number when making a call, press the SECRET (INTERCOM) button before and after the numbers you wish to conceal.
If you store an outside party's number, you should first store a line access number.
If you need to enter an account code, you can enter the specified account code before the line access number.
<Example>

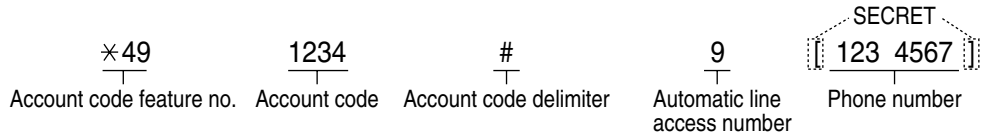

◆◆ System Speed Dialing Name [002]

You can store the name associated with the speed dialing number. These names are displayed when making calls using the display operation. To enter characters, refer to "Entering Characters".

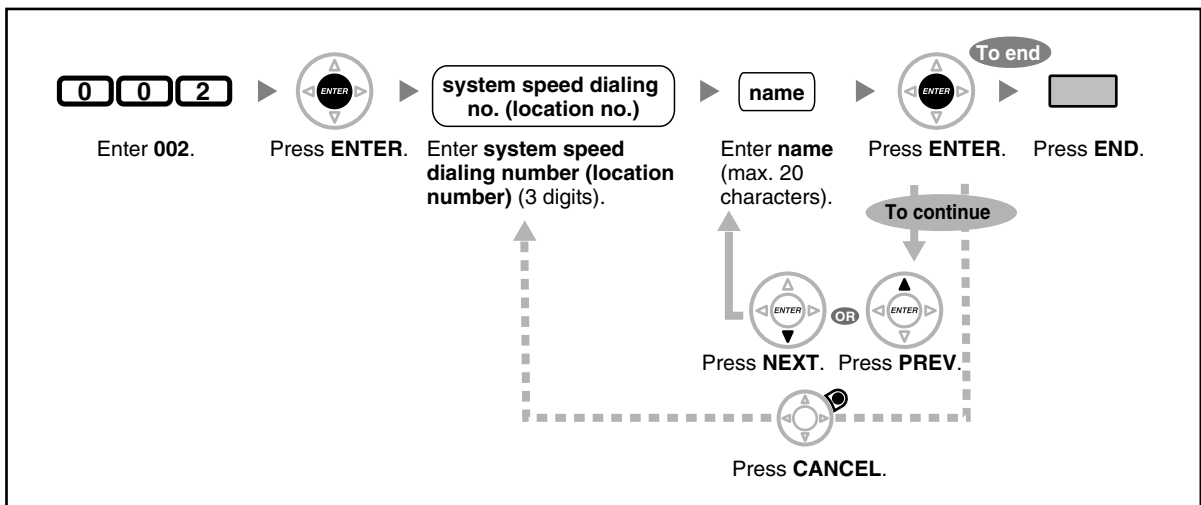

◆◆ Extension Number [003]

You can assign an extension number to each extension.

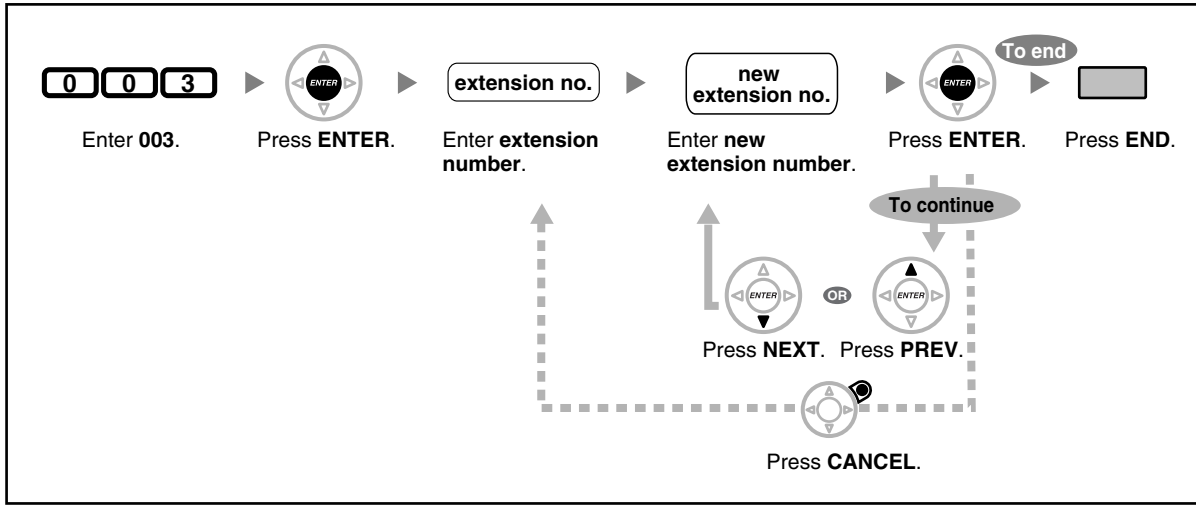

- The leading number(s) should be the same as the number(s) assigned for Flexible Numbering. Consult your dealer.
- A duplicate entry is invalid.

◆◆ Extension Name [004]

You can store the name of an extension user. This is useful if you want to know who is calling, or who you are calling when making an intercom call using the directory.
To enter characters, refer to "Entering Characters".

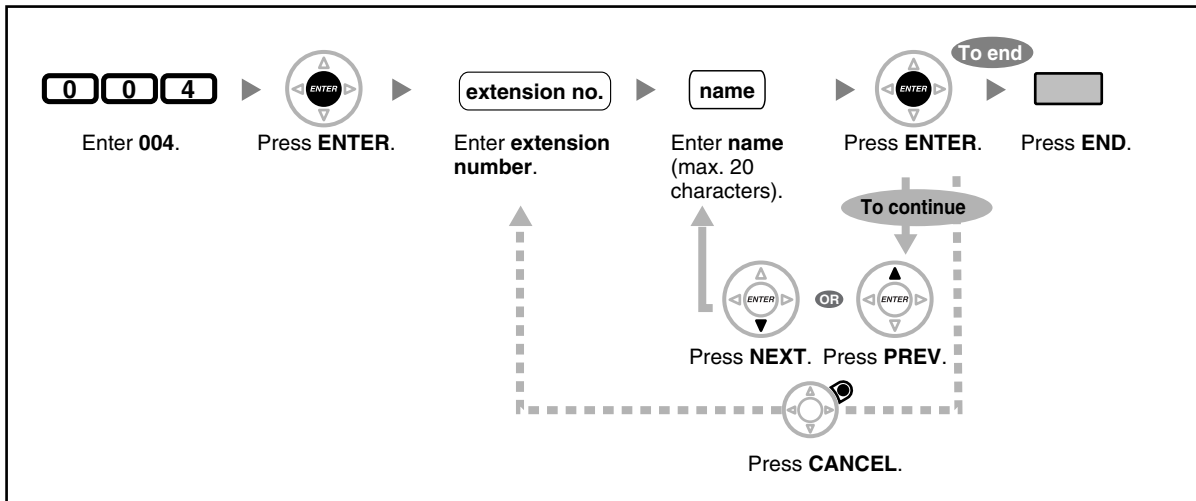

Section 4

Appendix













This chapter provides the Troubleshooting, the Feature Number Table and Tone List. Check the Troubleshooting section before consulting your dealer.







4.1 Troubleshooting

4.1.1 Troubleshooting

◆◆ Troubleshooting

Problem	Remedy
The telephone does not work properly.	<ul style="list-style-type: none"> ▶ Consult your dealer.
I cannot use the telephone.	<ul style="list-style-type: none"> • The telephone is locked. <ul style="list-style-type: none"> ▶ Unlock your telephone. (☞ 1.5.3 Extension Lock, 2.1.1 Extension Control) • Your telephone is connected to an eXtra Device Port. <ul style="list-style-type: none"> ▶ System programming is required. Consult your dealer.
Some features do not work.	<ul style="list-style-type: none"> • System management may restrict certain features. <ul style="list-style-type: none"> ▶ Consult your manager. • The feature numbers have changed. <ul style="list-style-type: none"> ▶ Confirm the revised number and try again.
Even though following the manual instructions, none of the operations work when using a proprietary telephone.	<ul style="list-style-type: none"> • The Intercom line was not seized. The seized line, when going off-hook, was changed by personal setting. (☞ 3.1.2 Settings on the Programming Mode) <ul style="list-style-type: none"> ▶ In the manual, going off-hook means an Intercom line is seized. If the setting has been changed, press the INTERCOM button after going off-hook and follow the instructions.
The paralleled single line telephones do not ring.	<ul style="list-style-type: none"> • "No ring" may be selected. Change the setting to ring. (☞ 1.7.10 Paralleled Telephone)
The telephone does not work using the personal settings or with other settings. (One-touch dialing, forwarding destination, etc.)	<ul style="list-style-type: none"> • The extension line has been changed. The previous telephone's settings have not been cleared. <ul style="list-style-type: none"> ▶ Clear the settings and then program your desired settings again. (☞ 1.7.12 Extension Feature Clear, 3.1.1 Personal Programming, 3.1.3 Customizing the Buttons)

Problem	Remedy
My proprietary telephone does not have a feature button.	<ul style="list-style-type: none"> • Some models do not have the feature button. <ul style="list-style-type: none"> ▶ Change a flexible button to the desired button. ( 3.1.3 Customizing the Buttons) ▶ Enter the specified feature number instead of the feature button. ( 1.1.1 Before Operating the Telephones)
A reorder tone is audible or "Restricted" is displayed.	<ul style="list-style-type: none"> • The telephone is locked. <ul style="list-style-type: none"> ▶ Unlock your telephone. ( 1.5.3 Extension Lock, 2.1.1 Extension Control) • Toll restriction is activated. <ul style="list-style-type: none"> ▶ Consult your manager or dealer. • An account code is required. ( 1.2.6 Calling without Restrictions, Account Code Entry in 1.2.1 Basic Calling)
I cannot make an outside call using the One-touch Dialing button or speed dialing.	<ul style="list-style-type: none"> • A line access number was not stored. <ul style="list-style-type: none"> ▶ A line access number is required for outside calls. ( 1.2.1 Basic Calling, 3.1.3 Customizing the Buttons)
I cannot remember the feature numbers.	<ul style="list-style-type: none"> • ▶ Ask your dealer to change the feature numbers for easier use.
While talking to an outside party, the line is disconnected.	<ul style="list-style-type: none"> • The time limit has run out. ( 1.4.1 Call Transfer, 1.4.5 Multiple Party Conversation) <ul style="list-style-type: none"> ▶ Consult your dealer to extend the time, if necessary.
Redialing does not function.	<ul style="list-style-type: none"> • The stored number was more than 32 digits or an extension number. ( 1.2.3 Redial)
The personal computer and fax machine communication failed.	<ul style="list-style-type: none"> • An indication tone may have interrupted communication. ( 1.7.8 Data Line Security)
I cannot send a call waiting tone to the dialed extension.	<ul style="list-style-type: none"> • The other party has not set the Call Waiting feature. <ul style="list-style-type: none"> ( Call Waiting, 1.4.4 Call Waiting, 1.7.3 Call Waiting/Off-hook Call Announcement (OHCA)/Whisper OHCA) • The other party has set Data Line Security. ( 1.7.8 Data Line Security)
I forgot the password.	<ul style="list-style-type: none"> • Ask the manager to assist you. ( 2.1.1 Extension Control)
The background music started suddenly.	<ul style="list-style-type: none"> • ▶ Turn off the music. ( 1.7.7 Background Music (BGM), 2.1.4 External Background Music (BGM))

Problem	Remedy
I do not want to display a number which is stored in memory.	<ul style="list-style-type: none">  Conceal the number. ( Storing Names and Numbers, 3.1.3 Customizing the Buttons)
I want to confirm my extension number.	<ul style="list-style-type: none"> ( Your Extension Number in 1.1.1 Before Operating the Telephones)
The date and time are not correct.	<ul style="list-style-type: none"> Set the date and time by system programming. ( Date & Time [000] in 3.3.2 System Programming)
The display is not shown well.	<ul style="list-style-type: none">  Change the Display contrast level. ( 3.1.2 Settings on the Programming Mode)
I want to distinguish the tones.	<ul style="list-style-type: none"> ( To distinguish the ringing tones for each CO, INTERCOM or G-DN button (Digital proprietary telephone only), 3.1.3 Customizing the Buttons)
The MESSAGE button light lit.	<ul style="list-style-type: none"> Another extension left you a message waiting indication while you were on the phone or away from your desk.

4.2 Feature Number Table

4.2.1 Feature Number Table

Numbers listed below are the default settings. There are flexible feature numbers and fixed feature numbers. If you change the flexible feature numbers, fill in your assigned numbers (new) in the list for future reference.

Feature (While dial tone is heard)	Default (New)	Additional digits
1.2.1 Basic Calling		
Operator Call	0 ()	
Automatic Line Access	9 ()	outside phone no.
CO Line Group Access	8 ()	CO line group no. (2 digits) + outside phone no.
TIE Line Access	7 ()	private phone no.
Account Code Entry	*49 ()	account code + # + outside phone no.
1.2.2 Easy Dialing		
Personal Speed Dialing		
– To store	*30 ()	personal speed dialing no. (2 digits) + outside phone no. + #
– To dial	** ()	* + personal speed dialing no. (2 digits)
System Speed Dialing		
– To dial	** ()	system speed dialing no. (3 digits)
Hot Line	*740 ()	
– To store		2 + phone no. + #
– To set		1
– To cancel		0
1.2.3 Redial		
Last Number Redial	# ()	

4.2 Feature Number Table

Feature (While dial tone is heard)	Default (New)	Additional digits
<p>1.2.4 When the Dialed Line is Busy or There is No Answer</p> <p>Automatic Callback Busy Cancel</p> <p>Message Waiting</p> <p>For a caller</p> <ul style="list-style-type: none"> – To leave/cancel <p>For a called extension</p> <ul style="list-style-type: none"> – To call back – To clear 	<p>×46 ()</p> <p>×70 ()</p>	<p>1/0 + extension no.</p> <p>2 0 + your extension no.</p>
<p>1.2.6 Calling without Restrictions</p> <p>Remote COS Access</p> <p>To call (Verified Code Entry)</p>	<p>×47 ()</p>	<p>extension no. + extension PIN + phone no.</p> <p>× + verified code + verified code PIN + phone no.</p>
<p>1.2.7 Direct Inward System Access (DISA)</p> <p>Calling through DISA</p> <ul style="list-style-type: none"> – To an extension (In All Security Mode only) – To an outside party (In Trunk Security Mode/All Security Mode only) 		<p>your extension no./(× + verified code) + extension PIN/verified code PIN + extension no.</p> <p>your extension no./(× + verified code) + extension PIN/verified code PIN + outside phone no.</p>
<p>1.2.8 Remote Setting</p> <ul style="list-style-type: none"> – From another extension – Through DISA 		<p>your extension no. + extension PIN + feature no.</p>
<p>1.3.3 Call Pickup</p> <p>Call Pickup</p> <ul style="list-style-type: none"> – Group – Directed <p>Call Pickup Deny</p> <ul style="list-style-type: none"> – To deny – To allow 	<p>×40 ()</p> <p>×41 ()</p> <p>×720 ()</p>	<p>group no. (2 digits)</p> <p>extension no.</p> <p>1 0</p>

Feature (While dial tone is heard)	Default (New)	Additional digits
1.3.4 Trunk Answer From Any Station (TAFAS) – Calls through an external speaker	×42 ()	1
1.4.2 Call Hold Call Hold/Call Hold Retrieve Call Hold Retrieve – Specified with a held line number – Specified with a holding extension number Call Park – To set – To retrieve	×50 () ×53 () ×51 () ×52 ()	CO line no. which is held (3 digits) extension no. which has a held call parking zone no. (2 digits)/× stored parking zone no. (2 digits)
1.4.4 Call Waiting Answering Call Waiting in the PBX Answering Call Waiting from the Telephone Company	×50 () ×60 ()	
1.5.1 Call Forwarding Call Forwarding (FWD)/ 1.7.2 Do Not Disturb (DND) – Both Calls – Outside Calls – Intercom Calls	×710 () ×711 () ×712 ()	0 (Cancel)/ 1 (Do Not Disturb [DND])/ 2 (All calls) + phone no. + #/ 3 (Busy) + phone no. + #/ 4 (No Answer) + phone no. + #/ 5 (Busy/No Answer) + phone no. + #/ 7 (Follow Me) + your extension no./ 8 (Follow Me Cancel) + your extension no.

4.2 Feature Number Table

Feature (While dial tone is heard)	Default (New)	Additional digits
–To set the timer for "No Answer" and "Busy/No Answer" Call Forwarding (FWD) for your Incoming Call Distribution Group – Both Calls – Outside Calls – Intercom Calls	*713 () *714 () *715 () *716 ()	00-99 (second) 1 (Set) + ICD Group extension no. + phone no. + #/0 (Cancel) + ICD Group extension no.
1.5.2 Absent Message – To set – To cancel	*750 ()	1-9 (+ parameter) + # 0
1.5.3 Extension Lock – To lock – To unlock	*77 ()	1 0 + extension PIN
1.6.1 Paging Group Paging	*33 ()	paging group no. (2 digits)
1.6.2 Answering/Denying a Paging Announcement – To answer – To deny – To allow	*43 () *721 ()	1 0
1.7.1 Timed Reminder – To set – To cancel	*760 ()	12H: 1 + time (hour/minute) + 0 (AM)/1 (PM) + 0 (once)/1 (daily) 24H: 1 + time (hour/minute) + 0 (once)/1 (daily) 0
1.7.3 Call Waiting/Off-hook Call Announcement (OHCA)/Whisper OHCA – For intercom calls (No call/Tone/OHCA/Whisper OHCA) – For outside calls (No tone/Tone)	*731 () *732 ()	0 (No call)/1 (Tone)/2 (OHCA)/3 (Whisper OHCA) 0 (No tone)/1 (Tone)

Feature (While dial tone is heard)	Default (New)	Additional digits
1.7.4 Connected Line Identification Restriction (COLR) – To show – To prevent	*7*0 ()	0 1
1.7.5 Calling Line Identification Restriction (CLIR) – To show – To prevent	*7*1 ()	0 1
1.7.6 Executive Busy Override Deny – To prevent – To allow	*733 ()	1 0
1.7.7 Background Music (BGM) – To set – To cancel	*751 ()	1 0
1.7.8 Data Line Security – To set – To cancel	*730 ()	1 0
1.7.10 Paralleled Telephone – Ring – No Ring	*39 ()	1 0
1.7.11 Wireless XDP Parallel Mode – To set – To cancel	*48 ()	1 + paired wired extension no. 0
1.7.12 Extension Feature Clear	*790 ()	
1.8.1 Log-in/Log-out, Wrap-up Log-in Log-out To enter/leave the Not Ready mode	*736 () *735 ()	1 + ICD Group extension no./* 0 + ICD Group extension no./* 1 (Not Ready)/0 (Ready)
*2 1.8.2 Incoming Call Distribution Group Monitor	*739 ()	ICD Group extension no.

4.2 Feature Number Table

Feature (While dial tone is heard)	Default (New)	Additional digits
1.9.1 Doorphone/Door Opener Doorphone Call Door Open	×31 () ×55 ()	doorphone no. (2 digits) doorphone no. (2 digits)
1.9.2 Host PBX External Feature Access (EFA)	×60 ()	service code
1.9.3 Voice Processing System Call Forwarding to Voice Mail (Voice Mail Integration) – Both Calls – Outside Calls – Intercom Calls	×710 () ×711 () ×712 ()	0 (Cancel)/ 2 (All Calls)/ 3 (Busy)/ 4 (No Answer)/ 5 (Busy/No Answer) + voice mail floating extension no. + #
1.10.1 Walking Extension	×727 ()	your previous extension no. + extension PIN
2.1.1 Extension Control *1 Remote Extension Lock – To unlock – To lock	×782 () ×783 ()	extension no. extension no.
*1 2.1.2 Time Service Mode Control – Day/Night/Lunch/Break	×780 ()	0/1/2/3
*1 2.1.4 External Background Music (BGM) – To play – To stop	×35 ()	11 10

Feature (While dial tone is heard)	Default (New)	Additional digits
*1 2.1.5 Outgoing Messages (OGM) – To record – To play back – To record from an external BGM (MOH) port – To clear	×36 ()	1 + OGM floating extension no. 2 + OGM floating extension no. 31 + OGM floating extension no. 0 + OGM floating extension no.
3.1.1 Personal Programming Extension PIN (Personal Identification Number) – To set – To cancel	×799 ()	1 + extension PIN + # + same extension PIN + # 0 + stored extension PIN

*1 : Manager only

*2 : Supervisor only

Feature (While busy, DND or call tone is heard)	Default
1.2.4 When the Dialed Line is Busy or There is No Answer Call Waiting	1
DND Override	
Executive Busy Override	3
Message Waiting – To leave	4
Call Monitor	5
Automatic Callback Busy	6
1.2.5 Alternate Calling—Ring/Voice	×

Feature (While dialing or talking)	Fixed Number
1.4.5 Multiple Party Conversation Conference	3
1.9.1 Doorphone/Door Opener From any extension while talking to the doorphone	5

4.3 Tone

4.3.1 Tone

While on-hook

Ring Tones

The following tones are programmable allowing recognition of call type (Outside, Intercom or Doorphone).

Tone 1

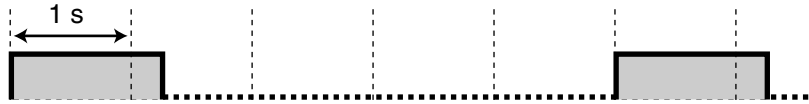

Tone 2

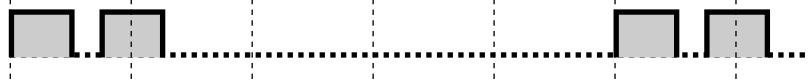

Tone 3



Tone 4

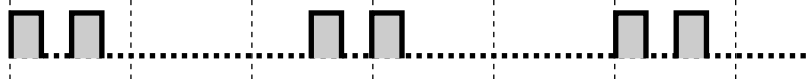

When going off-hook

Dial Tones

Tone 1

Normal

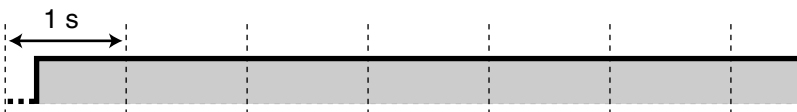

Tone 2

Any one of the following features is set:

- Absent Message
- Background Music
- Call Forwarding
- Call Pickup Deny
- Call Waiting
- Do Not Disturb
- Extension Lock
- Executive Busy Override Deny
- Hot Line
- Timed Reminder

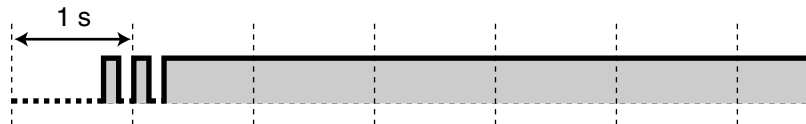
**Tone 3**

- After pressing TRANSFER or Recall/hookswitch to hold a call temporarily (e.g., Call Splitting)
- While a called PS is being searched
- When Account Code Entry is performed
- When answering a Timed Reminder call with no message

**Tone 4**

Message waiting indication was received.

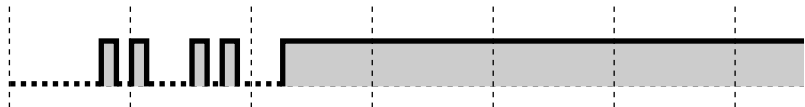
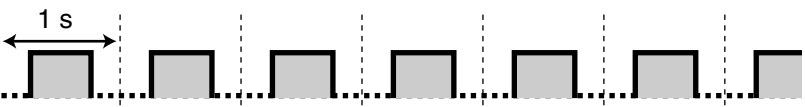
**When you make calls****Busy Tone****Reorder Tone**

The CO line you tried to seize is not assigned or denied.

**Ringback Tone 1**

Normal ringback tone



Ringback Tone 2

Special ringback tone for DISA call

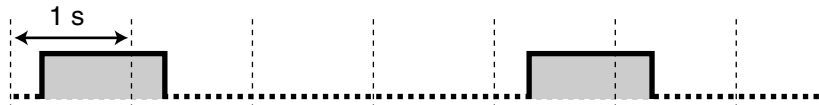

Do Not Disturb (DND) Tone

The dialed extension is refusing incoming calls.



While off-hook

Indication Tones

Tone 1

Call waiting tone

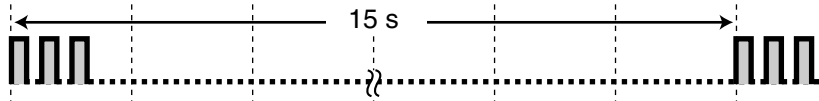

Tone 2

A call is on hold longer than the specified time.

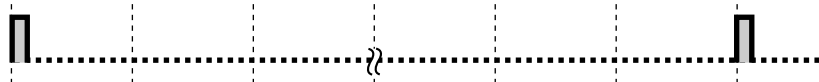

When talking to an outside party

Warning Tone

This tone is sent 15, 10 and 5 seconds before the specified time for disconnection.



When setting the features or programming

Confirmation Tones

Tone 1

The feature setting was set successfully.



Tone 2

Before receiving a page through an external speaker

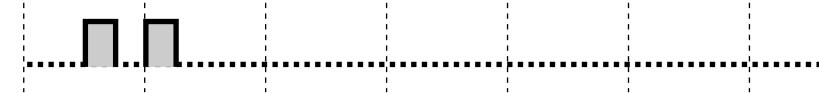

Tone 3

Before the following features activate:

- Retrieving a held call
- Picking up another call
- Paging/Answering a paging announcement
- Answering the call through a speaker

**Tone 4**

Establishing or leaving a conference

**Tone 5**

A call has been put on hold.

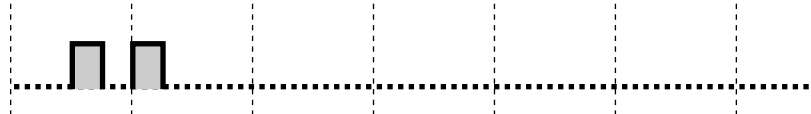

Index

A

Absence Settings 68
 Absent Message 71, 121, 146
 Account 21, 128
 Account Code Entry 28, 143
 Alternate Calling—Ring/Voice 38, 149
 Alternate Receiving—Ring/Voice 120
 Answer 20, 22, 46, 128
 ANSWER/RELEASE Button 46
 Answering Call Waiting from the Telephone Company 59
 Answering Call Waiting in the PBX 56
 Answering Calls 44
 Answering/Denying a Paging Announcement 75
 Appendix 139
 AUTO ANS (Auto Answer)/MUTE 19
 AUTO DIAL/STORE 19
 Automatic Call Hold 53
 Automatic Callback Busy 32, 149
 Automatic Callback Busy Cancel 33, 144
 Automatic Line Access 26, 143
 Available Extension 131, 133

B

Background Music (BGM) 81, 123, 147
 Basic Calling 25
 Before Operating the Telephones 16
 Boss & Secretary feature 68
 Busy Station Signaling (BSS) → Call Waiting 34
 Busy Tone 151

C

Call Center 85
 Call Forwarding 68
 Call Forwarding (FWD) 19, 68
 Call Forwarding (FWD)/Do Not Disturb (DND)—Both calls 21, 127
 Call Forwarding [FWD] for your Incoming Call Distribution Group 70
 Call Forwarding to Voice Mail (Voice Mail Integration) 93
 Call Hold 51, 145
 Call Hold Retrieve 52, 145
 Call Log 21, 128
 Call Log for ICD Group 21, 128
 Call Monitor 37, 149
 Call Park 21, 53, 128, 145
 Call Park (Automatic Park Zone) 21, 53, 128, 145
 Call Park Retrieve 54
 Call Pickup 45
 Call Pickup Deny 46, 144
 Call Splitting 54
 Call Transfer 49
 Call Waiting 34, 56, 78, 146, 149
 Call Waiting from the Telephone Company 145
 Call Waiting in the PBX 145
 Call Waiting Selection 121
 Call Waiting Tone Type Selection 121
 Call Waiting/Off-hook Call Announcement (OHCA)/Whisper OHCA 78
 Calling an Outside Party 26
 Calling Another Extension 25
 Calling Line Identification Restriction (CLIR) 22, 80, 119, 128,

147
 Calling through DISA 40
 Calling without Restrictions 38
 CANCEL 20
 Changing the Settings and Extension Control 132
 Changing the Settings of Other Extensions 110
 Clearing Features 125
 CO 19
 CO Line Group Access 26, 143
 Conditions 131, 133
 Conference 19, 21, 60, 128
 Confirmation Tones 152
 Connected Line Identification Restriction (COLR) 22, 79, 129, 147
 Connection Example 24
 Control Features 110
 Customized Buttons 20
 Customizing the Buttons 126
 Customizing Your Phone & System 115

D

Data Line Security 81, 147
 Date & Time [000] 135
 Dial Tone Transfer 111
 Dial Tones 150
 Direct Inward System Access (DISA) 40
 Direct Station Selection (DSS) 21, 127
 Directories 104
 Directory and Call Log Lock 123
 Display 17
 Display Backlight Selection 119
 Display Language Selection 118
 Display Proprietary Telephone 100
 Display Switching Mode 119
 DND Override 37, 149
 Do Not Disturb (DND) 19, 77
 Do Not Disturb (DND) Tone 152
 Door Open 92, 148
 Doorphone Call 91, 148
 Doorphone/Door Opener 91
 During a Conversation 49

E

Easy Dialing 28
 Electronic Station Lockout → Extension Lock 72, 123, 146
 ENTER 20
 Entering Characters 105
 Examples 17
 Exclusive Call Hold 51
 Executive Busy Override 36, 149
 Executive Busy Override Deny 80, 122, 147
 Extension Control 110
 Extension Feature Clear 83, 147
 Extension Lock 72, 123, 146
 Extension Name [004] 138
 Extension Number [003] 138
 Extension PIN (Personal Identification Number) 116, 123, 149
 Extension Settings 76
 External Background Music (BGM) 112, 148

External Feature Access (EFA) 21, 92, 128, 148

F

Feature Highlights 2
 Feature Number Table 143
 Feature Numbers 16
 Fixed Buttons 19
 FLASH/RECALL 19
 Forced Answerback Selection 120
 FWD N/A Timer 122
 FWD/DND Cycle Switch Mode 71, 78
 FWD/DND Setting Mode 71, 78
 FWD/DND—Intercom calls 21, 127
 FWD/DND—Outside calls 21, 127

G

Group Directory Number (G-DN) 21, 127
 Group FWD—Both calls 21, 127
 Group FWD—Intercom calls 21, 128
 Group FWD—Outside calls 21, 127
 Group Paging 74, 146
 Group-CO (G-CO) 21, 127

H

Handset/Headset Selection → Headset Operation 66, 122
 Hands-free Answerback 44
 Hands-free Operation 66
 Headset 22, 66, 129
 Headset Operation 66, 122
 HOLD 19
 Host PBX 92
 Hot Line 30, 143
 How to Follow the Steps 23
 Hurry-up 21, 128
 Hurry-up Transfer → Manual Queue Redirection 89

I

Icon Descriptions 18, 134
 Incoming Call Distribution Group Monitor 87, 88, 147
 Incoming Call Log 100
 Indication Tones 152
 INTERCOM 19
 Intercom Call 25

J

Jog Dial 20

K

Key Pad Tone Set 122

L

Last Number Redial 32, 143
 LCS Mode Set (After Answering) 120
 Leaving 3 Parties Conference 63
 List 133
 Live Call Screening (LCS) 22, 95, 129
 Live Call Screening Mode Set 120

Log-in/Log-out 21, 85, 128, 147
 Log-in/Log-out for all groups 21, 128
 Log-in/Log-out of a specified group 21, 128
 Log-in/Log-out, Wrap-up 85
 Loop-CO (L-CO) 20, 127

M

Making Calls 25
 Manager Operation 109
 Manager Password 131
 Manager Programming 131, 132
 Manual Queue Redirection 89
 Message 19, 21, 127
 Message for another extension 21, 127
 Message Waiting 34, 144, 149
 MODE 20
 MONITOR 19
 Monitoring and Changing the Log-in/Log-out Status of Extensions 89
 Monitoring the Status of Waiting Calls 88
 Multiple Party Conversation 59
 Mute 64

N

Navigator Key 20

O

Off-hook Call Announcement (OHCA) 78
 Off-hook Monitor 65
 One-touch Dialing 21, 29, 127
 One-touch Dialing Assignment Mode Selection 123
 One-touch Transfer 50
 One-touch Two-way Transfer 22, 97, 129
 Operation 15
 Operator Call 25, 143
 Outgoing Call Log 103
 Outgoing Messages (OGM) 112, 149

P

Paging 74
 Paging and then Transferring a Call 74
 Paging Deny 75, 122
 Paralleled Telephone 82, 120, 147
 PAUSE 19
 Personal Absent Message 121
 Personal Programming 116
 Personal Speed Dialing 29, 143
 Pickup Dialing → Hot Line 30, 143
 Portable Station (PS) Registration 16
 Predialing 27
 Preferred Line Assignment—Incoming 120
 Preferred Line Assignment—Outgoing 119
 Privacy Release 64
 Procedure 135
 PROGRAM 20
 Programmable Feature (PF) 20
 Programming Information 131, 133

Q

Quick Dialing 31

R

Receiving Calls 44
Redial 19, 32
Release 20, 22, 46, 128
Remote COS Access 38, 144
Remote Extension Lock 110, 148
Remote Setting 42, 144
Remote Station Lock Control → Remote Extension Lock 110, 148
Reorder Tone 151
Required Telephone 131, 133
Restrictions 17
Ring Tones 150

S

SELECT 20
Setting Features 117
Settings on the Programming Mode 117
SHIFT 20
Single-CO (S-CO) 21, 127
Soft Buttons 19
SP-PHONE 19
Station Program Clear → Extension Feature Clear 83, 147
Station Speed Dialing → Personal Speed Dialing 29, 143
Storing Names and Numbers 104
System Alarm 22, 128
System Feature Access 107
System Password 133
System Programming 133, 135
System Speed Dialing 30, 143
System Speed Dialing Name [002] 137
System Speed Dialing Number [001] 136

T

Terminate 21, 128
TIE Line Access 27, 143
Time Service 81
Time Service (Day/Night/Lunch/Break) 22, 81, 110, 128, 148
Time Service Mode Control 110
Time Service Switching Mode (Automatic/Manual) 22, 111, 129
Timed Reminder 76, 146
To store the caller's information in personal speed dialing 103
Toll Restriction 22, 128
Tone 17, 150
Tone 1 152
Tone 2 152
TRANSFER 19
Transferring to an Extension on the PBX 49
Transferring to an Outside Party Using the PBX Service 50
Troubleshooting 140
Trunk Answer From Any Station (TAFAS) 46, 145
Two-way Record 22, 97, 129
Two-way Transfer 22, 97, 129

U

Unattended Conference 62

User-supplied Equipment 91
Using a Navigator Key/Jog Dial/Volume Key 17

V

Verified Code Entry 39, 144
VOICE CALL/MUTE 19
Voice Mail Integration 93, 148
Voice Mail Transfer 22, 93, 129
Voice Processing System 93
Volume Key 20

W

Walking COS 39
Walking Extension 99, 148
Walking Station → Walking Extension 99, 148
Warning Tone 152
What Kind of Telephone Can Be Used? 16
When the Dialed Line is Busy or There is No Answer 32
When You Use a Panasonic Proprietary Telephone 19
Whisper OHCA 78
Wireless XDP Parallel Mode 83, 147
Wrap-up 21, 85, 128

Y

Your Extension Number 17

**Panasonic Consumer Electronics Company
Division of Matsushita Electric Corporation of America**

One Panasonic Way
Secaucus, NJ 07094

**Panasonic Sales Company
Division of Matsushita Electric of Puerto Rico, Inc.**

Ave. 65 de Infantería, Km. 9.5
San Gabriel Industrial Park
Carolina, Puerto Rico 00985

<http://www.panasonic.com/csd>

Copyright:

This manual is copyrighted by Panasonic Communications Co., Ltd. (PCC).
You may print out this manual solely for internal use with this model. Except above, you may not reproduce this manual in any form, in whole or part, without the prior written consent of PCC and its licensee.

© 2004 Panasonic Communications Co., Ltd. All Rights Reserved.

PSQX3120ZA KK0104TM0