

Lucent Technologies  
Bell Labs Innovations



**MERLIN<sup>®</sup> Plus**  
COMMUNICATIONS SYSTEM  
Release 2  
System Manual

999-507-148  
Issue 3  
August 1990

© 1990 AT&T  
All Rights Reserved  
Printed in U.S.A.

999-507-148  
Issue 3  
August 1990

**NOTICE**

The information in this document is subject to change without notice. Lucent Technologies assumes no responsibility for any errors that may appear in this document.

MERLIN is a registered trademark of Lucent Technologies.

To order copies of this document, call the Lucent Technologies Customer Information Center, 1-888-582-3688 and refer to document number 999-507-148 with your order.

Intellectual property related to this product (including trademarks) and registered to AT&T Corporation has been transferred to Lucent Technologies Incorporated.

Any references within this text to American Telephone and Telegraph Corporation or AT&T should be interpreted as references to Lucent Technologies Incorporated. The exception is cross references to books published prior to December 31, 1996, which retain their original AT&T titles.

Lucent Technologies – formed as a result of AT&T's planned restructuring – designs, builds, and delivers a wide range of public and private networks, communication systems and software, consumer and business telephone systems, and microelectronic components. The world-renowned Bell Laboratories is the research and development arm for the company.

# Contents

---

---

## **Section 1: Introduction**

FCC Notification and Repair Information	1-1
Quick Start Procedure	1-3
What's in This Manual	1-4
How to Use This Manual	1-6
The MERLIN Plus Communications System	1-7

---

## **Section 2: Planning the System**

Introduction	2-1
System Configuration Form	2-2
Line Assignments Form	2-9
Call Restrictions Forms	2-18
System Speed Dial Forms	2-23
MERLIN Plus System Planning Forms	2-25

---

## **Section 3: Administering the System**

Introduction	3-1
Administration Preview	3-2
Basic Administration	3-10
Line Assignments for Voice Terminals	3-24
Systemwide Options	3-33
Quick Reference Guide to System Administration	3-37
Quick Reference Guide to Administration Codes	3-48

---

## **Section 4: Using The Attendant Console**

Overview	4-1
Handling Calls	4-4

---

## **Section 5: Reference**

MERLIN Plus System Features	5-1
Quick Reference Guide to MERLIN Plus Features	5-166
Quick Reference Guide to Using the ASA Features	5-170
Quick Reference Guide to Using the Programming Codes	5-171

---

## **Section 6: Accessory Equipment**

Answering Machines	6-2
Basic Telephones	6-4
Basic Telephone and Modem Interface 2	6-7
Data Collector and Printer	6-9
Doorphone Controller	6-11
General Purpose Adapter (GPA)	6-13
Headset and Headset Adapter	6-15
Loudspeaker Paging System	6-17
Music-on-Hold (MOH) and Background Music	6-21
Supplemental Alert Adapter (SAA)	6-23

---

## **Section 7: Troubleshooting the System**

Troubleshooting Procedures	7-1
System Test	7-13

---

## **Section 8: Installation**

---

## **Index**

## Section 1: Introduction

---

# FCC Notification and Repair Information

---

## INTERFERENCE INFORMATION NOTICE

This equipment generates, uses, and can radiate radio frequency energy and, if not installed and used in accordance with the instructions in this manual, may cause interference to radio communications. The equipment has been tested and found to comply with the limits for a Class A computing device pursuant to Subpart J or Part 15 of FCC Rules, which are designed to provide reasonable protection against such interference when the equipment is operated in a commercial environment. Operating this equipment in a residential area is likely to cause interference, in which case the user, at his or her own expense, will be required to do whatever is necessary to correct the interference.

## FCC REGISTRATION AND REPAIR INFORMATION

This equipment is registered with the FCC in accordance with Part 68 of its rules. In compliance with the rules, you are to be advised of the following:

- 1 *Means of Connection:* Connection of this equipment to the telephone network must be through a standard network interface jack: USOC RJ11C or RJ14C, or a multiline network interface cable and connector USOC R121.
  - Connection to off-premises stations requires a USOC RJ2GX.
  - This equipment must be ordered from your local telephone company.
  - This equipment may not be used with party lines or coin telephone lines.
- 2 *Notification of the Local Telephone Company:* Before connecting this equipment, you or your equipment supplier must notify your local telephone company's business office of the following:
  - The telephone numbers you will be using with this equipment.
  - The registration number for the MERLIN® Plus system:  
**AS593M-13529-KF-E**
  - The ringer equivalent number (REN) for the MERLIN Plus system:  
**0.8A**

You must also notify your local telephone company if and when this equipment is permanently disconnected from the lines.

- 3 *Installation and Operational Procedures:* The System Manual and the MERLIN Plus Installation Guide contain information about installation and operational procedures.
- 4 *Repair Instructions:* If you experience trouble because your equipment is malfunctioning, the FCC requires that the equipment not be used and that it be disconnected from the network until the problem has been corrected. Repairs to this equipment can only be made by the manufacturers, their authorized agents, or by others who may be authorized by the FCC.

- 
- 5 *Rights of the Local Telephone Company:* If this equipment causes harm to the telephone network, the telephone company may discontinue your service temporarily. If possible, they will notify you in advance. If advance notice is not practical, you will be notified as soon as possible. You will also be informed of your right to file a complaint with the FCC.

Your local telephone company may make changes in its facilities, equipment, operations, or procedures that affect the proper functioning of this equipment. If they do, you will be notified in advance to give you an opportunity to maintain uninterrupted service.

- 6 *Hearing Aid Compatibility:* The custom telephone sets for this system are compatible with inductively coupled hearing aids.

# Quick Start Procedure

---

## **IF YOU'RE IN A HURRY**

If you need to make and receive calls the moment your MERLIN Plus system is installed, and before you've had time to learn how to implement the entire system, this "Quick Start" information is for you. Follow this short procedure and in a few minutes you'll hear the familiar sound of a dial tone, enabling you to make and receive calls, so that your business can continue uninterrupted while the rest of the system is being planned.

- 1** Connect the system to a grounded ac power outlet.
- 2** Connect the system to the Central Office line in jack A.
- 3** Plug a voice terminal into Intercom #10.
- 4** Turn on the system power switch.

You now can make unrestricted calls on Touch-Tone lines only from the voice terminal.



# What's in This Manual

---

You'll find the information in this MERLIN Plus Communications System manual conveniently divided into eight sections, as described below. You'll also find ten copies of the *MERLIN Plus System User's Guide* enclosed.

## **SECTION 1. INTRODUCTION**

This section tells you what's in this manual and how to use it. It also offers a brief introduction to the system's control unit and the voice terminals (telephones).

## **SECTION 2. PLANNING THE SYSTEM**

Use the information in this section to make some key decisions about how you want the system to operate. This section includes planning forms to record your decisions. If someone else will be system administrator, have that person fill out the planning forms.

## **SECTION 3. ADMINISTERING THE SYSTEM**

This section tells you how to use the information on the planning forms to customize the system to meet your business needs. If someone else will be system administrator, have that person administer the system following the steps in this section.

## **SECTION 4. USING THE ATTENDANT CONSOLE**

If your system will have an attendant manage incoming call traffic, that person can find helpful information in this section on using the administrator/attendant telephone.

## **SECTION 5. REFERENCE**

This section contains a detailed discussion of every component, option, and feature in the MERLIN Plus system. The entries are organized alphabetically to help you find the information you need quickly. As you become familiar with the system, you'll probably go to this section first when you want to change a system setting or a voice terminal feature, or when you simply want to find out more about some aspect of the system.

## **SECTION 6. ACCESSORY EQUIPMENT**

Accessory Equipment includes the additional hardware that can be used with the MERLIN Plus system. The accessories are listed alphabetically.

## **SECTION 7. TROUBLESHOOTING THE SYSTEM**

The tables in this section can help you isolate and solve any of the technical problems that may cause your system to malfunction.

## **SECTION 8. INSTALLATION**

Insert your *MERLIN Plus Release 2 Installation Manual* in this section for future reference.

---

**USER'S GUIDE**

This guide is a handy reference for anyone who uses a MERLIN Plus system voice terminal on the job. Give one to everyone in your business who uses a voice terminal.

**CF/RLA CARD**

This card should be given to anyone in your company who works at home or travels frequently but still needs to make or receive business calls. It contains instructions for using Call Forwarding and Remote Line Access, convenient features for people who spend a lot of time out of the office. (Refer to Section 5, "Reference," for more details about these two features.)

**DOCUMENT LIST**

Call the AT&T Customer Information Center at 1-800-432-6600 to order any of the following documents for the MERLIN Plus system:

<b>Document</b>	<b>Order No.</b>
System Manual	999-507-148
CF/RLA Card	999-502-148
Installation Manual	518-600-008
User's Guide	999-500-148
Customization Chart	999-503-148
Customer Training Video Tape	775-358

# How to Use This Manual

---

How you should use this manual at any particular time depends on what you want to do, as the following information suggests.

## **ADMINISTERING A NEW SYSTEM?**

Use the information in Section 2, “Planning the System,” to decide which options and features you want for your system, then follow the instructions in Section 3, “Administering the System,” and in Section 5, “Reference,” to set up the system with the options and features you’ve selected.

## **NEED TO USE THE PHONE BEFORE THE SYSTEM IS RUNNING?**

Refer to the “Quick Start Procedure” at the beginning of this section.

## **MAKING CHANGES TO A RUNNING SYSTEM?**

Change the planning forms to reflect the changes you want to make, then see the relevant entries in Section 5, “Reference,” and Section 6, “Quick Reference Guides,” to make the changes.

## **MANAGING INCOMING CALL TRAFFIC AS SYSTEM ATTENDANT?**

See Section 4, “Using the Attendant Console,” for information on how to use the attendant’s telephone to handle incoming calls.

## **USING A VOICE TERMINAL FOR THE FIRST TIME?**

See the relevant entries and quick reference guides in Section 5, “Reference,” and keep the *MERLIN Plus System User’s Guide* handy.

## **HAVING TROUBLE WITH THE SYSTEM?**

Find the symptom in Section 7, “Troubleshooting,” then follow the suggestions for solving the problem.

# The MERLIN Plus Communications System

---

The basic MERLIN Plus system provides connections to up to four outside telephone lines and ten voice terminals. We use the term “voice terminal” instead of “telephone” because a basic telephone only lets you make and receive calls, while a voice terminal can be programmed to do a whole lot more, which you will soon discover as you read this manual.

To accommodate your growing communications needs, the system expands easily and economically to support up to eight outside lines and 20 voice terminals. If your business eventually outgrows even the fully expanded MERLIN Plus system, you can protect your investment in voice terminals, accessory equipment, and training time with the purchase of a larger MERLIN system.

The paragraphs that follow offer a brief introduction to the system’s control unit and voice terminals. The optional equipment you can add to your system is described under the heading “Accessory Equipment” in Section 5, “Reference.”

## THE CONTROL UNIT

The control unit is the system’s brain. It manages all incoming, outgoing, and intercom call traffic. It makes all of the system’s decisions and controls all of the system’s responses. For an illustration of the control unit with its major components labeled, see “Administration Preview” in Section 3, “Administering the System.”

## THE VOICE TERMINALS

A voice terminal is a MERLIN system telephone that provides basic telephone functions and allows you to take advantage of the special MERLIN system features. All voice terminals have buttons for fixed features such as Conference, Drop, Transfer, and Hold. They differ from one another in the number of buttons above and to the right of the dial pad that can be used for outside lines and programmable features. The 10-button voice terminal with the “HFAI” designation has the hands-free intercom feature. Voice terminals with “SP” or “BIS” designations also have the hands-free answer on intercom feature and a built-in speakerphone. For more information on using basic telephones with the MERLIN Plus system, see “Basic Telephones” in Section 5, “Reference.” Your MERLIN Plus system works best with the following voice terminals:

- BIS-10 Voice Terminal
- BIS-22 Voice Terminal
- BIS-22D Voice Terminal with Display
- BIS-34 Voice Terminal
- BIS-34D Voice Terminal with Display
- 5-Button Voice Terminal
- 10-Button Voice Terminal
- 10-Button Hands-Free Answer on Intercom (HFAI-10) Voice Terminal
- 34-Button Voice Terminal
- 34-Button (SP-34) Voice Terminal with Speakerphone
- 34-Button (SP-34D) Voice Terminal with Speakerphone and Display
- 34-Button Deluxe Voice Terminal

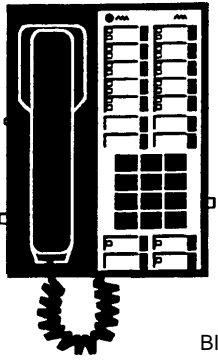

BIS 10

### **BIS-10, BIS-22, BIS-34, and BIS-34D Voice Terminals**

The *BIS-10 Voice Terminal* allows you to make and receive outside and intercom calls without lifting the handset. There are two columns of five buttons above the dial pad for incoming lines, auto intercom, and programmable features. The dual lights next to each button indicate the current status of selected features and lines.

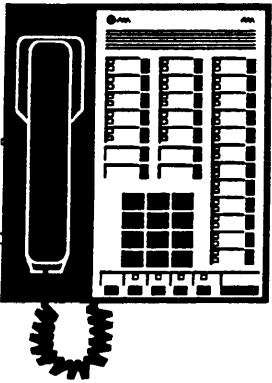

BIS 22

The *BIS-22 Voice Terminal* allows you to make and receive outside and intercom calls without lifting the handset. There are two columns of five buttons above the dial pad and one column of 12 buttons to the right of the dial pad, each with dual lights that indicate the current status of selected features and lines. You can use the buttons above the dial pad for incoming lines, auto intercom, and programmable features. You can also use the 12 buttons to the right of the dial pad for programmable features.

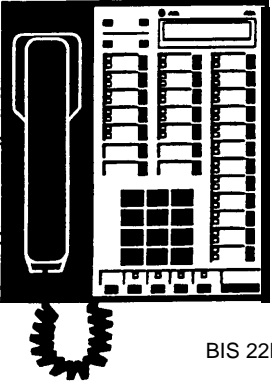

BIS 22D

The *BIS-22D Voice Terminal with Display* allows you to make and receive outside and intercom calls without lifting the handset. There are two columns of five buttons above the dial pad and one column of 12 buttons to the right of the dial pad, each with dual lights that indicate the current status of selected features and lines. You can use the buttons above the dial pad for incoming lines, auto intercom, and programmable features. You can also use the 12 buttons to the right of the dial pad for programmable features. The display, located in the top portion of the voice terminal, offers a variety of visual aids for most features.

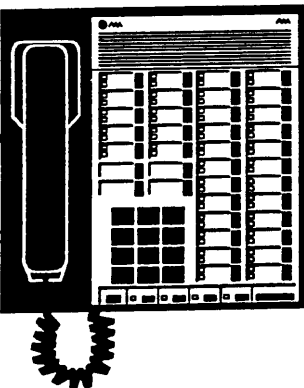

BIS 34

The *BIS-34 Voice Terminal* allows you to make and receive outside and intercom calls without lifting the handset. There are two columns of five buttons above the dial pad for outside lines, auto intercom, and programmable features and two columns of 12 buttons to the right for programmable features. The dual lights next to each button indicate the status of the selected features and lines.

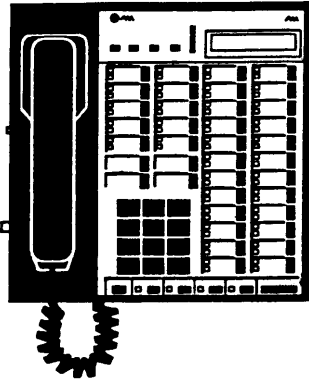

BIS 34D

The *BIS-34D Voice Terminal with Display* allows you to make and receive outside and intercom calls without lifting the handset. There are two columns of five buttons above the dial pad for incoming lines, auto intercom, and programmable features and two columns of 12 buttons to the right for programmable features. The dual lights next to each button indicate the status of the selected features and lines. The display, located in the top portion of the voice terminal, offers a variety of visual aids for most features.

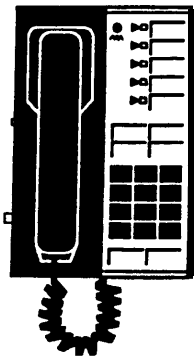

5-Button

### **5-Button Voice Terminal**

The 5-button voice terminal has one column of five buttons (an Intercom button and four additional buttons above the dial pad) that you can use for outside lines and/or programmable features.

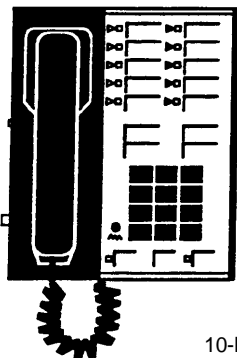

10-Button

### **10-Button Voice Terminals**

The *10-Button Voice Terminal* has two columns of five buttons (an Intercom button and nine additional buttons above the dial pad) for outside lines and programmable features.

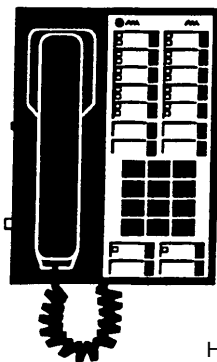

HFAI-10

The *10-Button (HFAI-10) Voice Terminal* has a built-in speaker that allows you to answer intercom calls without lifting the handset. It also has two columns of five buttons (an Intercom button and nine additional buttons above the dial pad) for outside lines and programmable features.

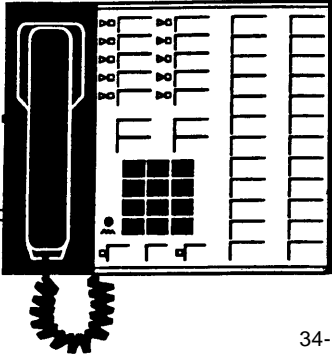

34-Button

### 34-Button Voice Terminal

The *34-Button Voice Terminal* is a basic voice terminal that provides two columns of five buttons above the dial pad for outside lines and programmable features. The two columns of 12 buttons to the right of the dial pad can be used for Auto Intercom buttons and other programmable features that do not require lights.

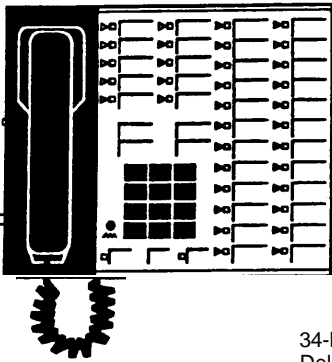

34-Button  
Deluxe

The *34-Button Deluxe Voice Terminal* has two columns of five buttons located above the dial pad and two columns of 12 buttons to the right of the dial pad. You can use the buttons above the dial pad for lines and programmable features. You can use the 24 buttons, with two lights per button, located to the right of the dial pad for programmable features.

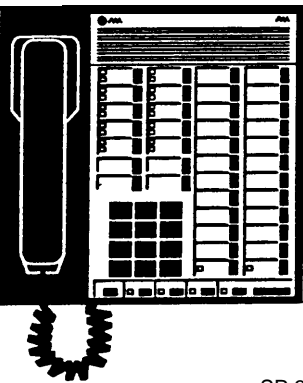

SP 34

The *34-Button (SP-34) Voice Terminal with Speakerphone* has a built-in speakerphone that allows you to initiate and answer both outside and intercom calls without using the handset. Above the dial pad are two columns of five buttons (an Intercom button and nine additional buttons) for outside lines and Auto Intercom buttons and programmable features. The two columns of 12 buttons located to the right of the dial pad can be used for programmable features that do not require lights.

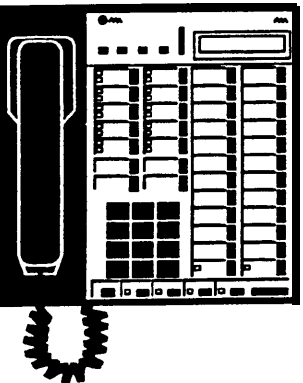

SP-34D

The *34-Button (SP-34D) Voice Terminal with Speakerphone and Display* has all the features of the SP-34 voice terminal combined with a display in the top portion.

---

### **Summary**

Voice terminal models BIS-34 and BIS-34D are ideal for the system administrator/attendant console because their features allow you to easily use all the system's features. You can also use the BIS-22 and the 34-Button Deluxe models as the console. However, the SP-34, SP-34D, BIS-10, HFAI-10, 10-Button, and 5-Button voice terminals are not recommended for use as an administrator/attendant console because the administrator would be unable to see which buttons were being assigned special features during system administration. In addition, 10- and 22-Button voice terminals cannot be used to program certain system features.



# Section 2: Planning the System

---

# Introduction

---

You can begin making and receiving calls as soon as your MERLIN Plus Communications System is installed. But to take full advantage of the system's power, you should customize it to fit your business needs. Customizing the system is called *administering* the system throughout this manual.

Administering the system involves entering information into the system's memory about how you want the system to operate. You enter this information by touching buttons and dialing numbers on the telephone referred to in this manual as the *administrator/attendant console*.

This section of the manual helps you decide what information you want to enter into the system's memory and shows you how to record that information on forms. A checklist of the forms appears below. You can find copies at the end of this section. Remove them now, make a photocopy of each, and put the originals back in this binder. Keep the copies on hand so you can fill them out as you plan your system.

- System Configuration Form
- Line Assignments Form
- Call Restrictions Forms
- System Speed Dial Forms

**NOTE:** In this section of the manual, the information that appears before the boxes helps you make important decisions about your system. Then the instructions in the boxes tell you where to enter these decisions on the forms.

# System Configuration Form

---

Use the System Configuration Form to record information about the following:

- Dial Signals
- Long Distance Dialing
- Transfer Return Interval
- Call Report
- Music-on-Hold
- Background Music
- Outside Telephone Lines
- Voice Terminals

The following information should help you make the appropriate entries for your system on the System Configuration Form.

## DIAL SIGNALS

The MERLIN Plus system comes set to generate Touch-Tones when you dial an outside call. This means that if one or more of your outside telephone lines transmits rotary (pulse) signals, you have to administer the system for rotary dialing. Otherwise you won't be able to dial out over the rotary lines.

**NOTE:** If some of your outside lines are Touch-Tone and some rotary, you may want to ask your local telephone company to replace the rotary lines with Touch-Tone lines.

Under "Dial Signals" on the form . . .

Check the box next to "Touch-Tone" if all the outside telephone lines connected to your system are Touch-Tone lines.

Check the box next to "Rotary (Pulse)" if one or more of the outside lines connected to your system are rotary lines.

## LONG DISTANCE DIALING

Under "Long Distance Dialing". . .

Check the box next to "Toll-Prefix" if you have to dial toll prefix (1 or 0) before the area code when you dial the telephone number for a long distance call.

Check the box next to "Area Code Only" if you do *not* have to dial a toll prefix (1 or 0) before the area code when you dial the telephone number for a long distance call.

---

## TRANSFER RETURN INTERVAL

Initially, when someone in the MERLIN Plus system transfers a call and it is not answered in four rings, the call returns to the sender. You can change that setting so that calls don't return, or return after up to nine rings.

Under "Transfer Return Interval" . . .

Check "No Return" if you don't want transferred calls to return to the originator, if the call is unanswered.

Check "\_\_\_ Rings" then fill in a number between 1 and 9, depending on the number of times you want a transferred call to ring before it's returned to the originator.

The following three features, Call Report, Music-on-Hold, and Background Music require optional equipment. If your business is *not* using these features, skip these discussions and continue with "Outside Telephone Lines."

## CALL REPORT

Call Report, also called Station Message Detail Recording (SMDR), enables businesses to keep records of incoming and outgoing calls. This optional feature requires a MERLIN PLUS system data collector and an AT&T 475/476 or 572/573 printer or its equivalent.

The Call Report feature gives you information in a report that is printed automatically as calls occur. The report includes the date and time of each call, its duration, the number dialed (if the call is outgoing), and the line and voice terminal on which the call is made. An account code is printed if the user enters one when the call is made. (See "Account Code Entry" in Section 5, "Reference.")

During system administration you can set the system to generate call records for outgoing calls only or for both incoming and outgoing calls. The minimum call duration, when calls begin to be recorded, can be set as short as 10 seconds or as long as nine minutes. The default setting is 0 which represents ten seconds — the time it takes to connect a call and to avoid recording busy or unanswered calls. The other durations that can be selected are given in minutes (1 to 9).

Under "Call Report" . . .

Check "Outgoing Calls Only" if you want only outgoing calls reported.

Check "Incoming and Outgoing Calls" if you want both incoming and outgoing calls reported.

Write in the time you've selected as the minimum length for a call to be reported (0-9).

---

## MUSIC-ON-HOLD

If you have an optional audio system, you can connect it with an RCA-type phonograph jack to the Music-on-Hold jack provided at the top of the Control Unit. Then when callers are placed on hold, they hear background music while they're waiting.

You can control the music volume or turn off the music from the administrator/attendant console.

Under "Music-on-Hold" . . .

If you have the optional audio equipment connected to the Music-on-Hold jack, check that volume selection you desire.

## BACKGROUND MUSIC

If you have an optional audio source connected to the Music-on-Hold jack and an optional loudspeaker paging system connected to the paging jack or a CO line jack, you can provide background music throughout your building.

You can control the background music volume either at the audio source or at the administrator/attendant console.

Under "Background Music" . . .

If you want to adjust the volume of the background music at the administrator/attendant console check that volume selection you desire.

## OUTSIDE TELEPHONE LINES

Your local telephone company gives you the telephone numbers for your outside lines. The control unit jacks where the outside lines connect to the system are labeled alphabetically: A through D for a system with four or fewer outside lines, and A through H for a system with five to eight outside lines.

To simplify system administration, plan to assign your outside lines to an unbroken sequence of jacks beginning with jack A. Begin with the lines for your local published telephone numbers. Group special line types such as WATS lines together in the sequence, and place any personal lines at the end of the sequence.

Under "Outside Telephone Lines" . . .

Write in the telephone number and the line type for each of your outside lines next to the appropriate letter.

If you have an optional loudspeaker paging system that you are planning to connect to a CO line instead of the Paging jack on the Control Unit, write "CO Paging" under line type for the CO line you plan to use for paging.

---

**HOLD DISCONNECT INTERVAL**

The MERLIN Plus system comes set for a long (450 milliseconds) hold disconnect interval because most telephone company switching systems use the long interval. If your telephone company uses a short (50 millisecond) interval, you'll need to reset your system to prevent calls from remaining on hold after callers have hung up. Refer to "Hold Disconnect Interval" in Section 5, "Reference," for more information on how to detect the hold disconnect interval.

Under "Hold Disconnect Interval" on the "Outside Telephone Lines" form . . .  
Check the column under "Long" if you want the 450 millisecond Hold Disconnect Interval.  
Check the column under "Short" if you want the 50 millisecond Hold Disconnect Interval.

**VOICE TERMINALS**

Each MERLIN Plus system voice terminal (telephone) in your system will have a 2-digit intercom number corresponding to the number of the voice terminal jack on the control unit where the voice terminal connects to the system. The valid intercom numbers for a control unit with 10 voice terminal jacks are 10 through 19. For a control unit with 20 voice terminal jacks, the valid intercom numbers are 10 through 29. The jack locations are illustrated on a label to the left of the modules in the control unit.

**Intercom Number 10**

By design, the intercom 10 position is the primary call-handling position in the system, and it is also the system administration point. If your system will have an attendant, you should assign intercom number 10 to the voice terminal at the system attendant's location. For complete system administration, the voice terminal assigned intercom 10 should be either a BIS-22 or a BIS-34 model. If you have 10 or fewer voice terminals, you may prefer to use a BIS-22 voice terminal.

Under "Voice Terminals" . . .  
Write in the name of the system attendant/administrator and that person's location on the line next to number 10.

**Intercom Number 18**

Notice on the form that "ASA" appears in the "Name" column next to intercom number 18. ASA stands for Automatic System Access, a group of features that includes Call Forwarding, Direct Extension Dialing, System Answer, and Remote Line Access. These features allow you to take advantage of the economy and efficiency of your MERLIN Plus system and its long-distance service lines when you're away from the office on business, or even when you're at home.

---

Activation of the ASA features requires a dedicated voice terminal jack on the control unit. At startup, the system automatically reserves jack (intercom number) 18 for the ASA features. But you can choose another voice terminal jack for ASA during system administration, or you may decide not to use any of the ASA features and assign intercom number 18 to a voice terminal. (To find out more about the Automatic System Access features— Call Forwarding, Direct Extension Dialing, System Answer, and Remote Line Access—see the entries for them in Section 5, “Reference.”)

Under “Voice Terminals” . . .

Do *not* write in a name next to intercom number 18 if you plan to use any of the Automatic System Access features (unless you plan to assign an intercom number other than 18 to ASA during system administration).

Cross out “(ASA)” next to intercom number 18 if you do *not* plan to use any of the ASA features or you are assigning the ASA features to a different intercom number. You can then treat intercom number 18 just like any other intercom number as you assign them. If you are assigning the ASA features to a different intercom number, write “ASA” next to the intercom number you plan to use instead of intercom number 18.

#### **Intercom Number 19**

Notice on the form that “BB” and “Reports” appear in parentheses in the “Name” column next to intercom number 19. The Busy Buster feature automatically redials the last number you dialed up to 10 times and signals you if and when the line begins to ring.

Operation of the BB feature requires a dedicated voice terminal jack on the control unit. At startup, the system automatically reserves jack (intercom number) 19 for Busy Buster. You can choose another voice terminal jack for Busy Buster during system administration, or you may choose not to use the BB feature and assign intercom number 19 to a voice terminal. (For more information on Busy Buster, see the entry for “Busy Buster” in Section 5, “Reference.”)

Under “Voice Terminals” . . .

Do *not* write in a name next to intercom number 19 if you plan to use the Busy Buster feature.

Cross out “(BB)” next to intercom number 19 if you plan to deactivate Busy Buster during system administration or if you plan to assign it to a different intercom number. (Intercom number 19 will still be reserved for the data collector and printer which are used to print reports.) You can then treat intercom number 19 just like any other intercom number when you assign intercom numbers to voice terminals at the appropriate point in this planning sequence. If you are assigning BB to a different intercom number, write BB next to the intercom number you plan to use instead of intercom number 19.

---

Notice that “Reports” also appears in parentheses in the “Name” column next to intercom 19 on the form. If your system has the Call Report option, intercom 19 is automatically reserved for the data collector and printer required to print this report. If your system also has BB, both features can share the same port with the use of the adapter supplied with the data collector. You can designate an intercom number other than 19 for the Call Report or System Feature Report equipment when you administer the system, but you cannot assign both the Call Report and System Feature Report equipment *and* a voice terminal to the same intercom number. If you change the voice terminal jack assignment for the data collector and printer, you should administer the new jack assignment for *both* report features. (For more information on the Call Report and System Feature Report options and equipment, see the appropriate entries in Section 5, “Reference.”)

Under “Voice Terminals” . . .

Do *not* write in a name next to intercom “number 19 if your system has the Call Report and/or System Feature Report option (unless you plan to assign an intercom number other than 19 to the Call Report or System Feature Report equipment when you administer the system).

Cross out “(Reports)” next to intercom 19 if your system does *not* have the Call Report or the System Feature Report option or if you want to assign them to a different intercom number. Then you can treat intercom 19 just like any other intercom number as you assign intercom numbers below. If you are assigning Reports to a different intercom number, write Reports next to the intercom number you plan to use instead of intercom number 19.

### **Intercom Numbers 11 through 29**

To simplify system administration, you should assign consecutive intercom numbers, beginning with 11, to the remaining voice terminals in your system. (As explained earlier, intercom number 10 goes to the administrator/attendant voice terminal, and intercom numbers 18 and 19 are reserved for system features unless reassigned.)

If you are using the ASA feature, Direct Extension Dialing, you can assign an alternate attendant to handle returning DXD calls that are busy, misdialed, or unanswered. All other calls are directed to the main attendant. For more information, see “Alternate Attendant” in Section 5, “Reference.”

Under “Voice Terminals” . . .

Next to intercom numbers that areas yet unassigned, write in the names and work locations of the people to be assigned voice terminals.

If assigning an alternate attendant to handle returning Direct Extension Dialing calls, write “Alt. Attendant” and the name of the person next to the appropriate intercom number.

### **Paging Groups**

The MERLIN Plus system lets you page the people in your business through the speakers on their voice terminals. You don’t need an external paging system for this feature.



---

The system automatically assigns all voice terminals to a single paging group, called the Page-All Group. You can't change the makeup of the Page-All Group. (See the "Group Page" entry in Section 5, "Reference," for more information on the Page-All feature.) The system also assigns intercoms 10 through 19 to Paging Group 1 and intercoms 20 through 29 to Paging Group 2. You can keep these groups as they are or you can change the makeup of Paging Groups 1 and 2 during system administration to fit the needs of your business.

You can assign as few or as many voice terminals as you want to Groups 1 and 2. You can also assign the same voice terminal to both groups.

Under "Paging Groups" . . .

Check the appropriate column(s) next to the intercom number, name, and location of each person to indicate the Paging Group(s) you plan to assign the person to.

### Templates

There are four voice terminal templates designed to make administration of voice terminal features easier. The four templates are the Clear Template, Dialer Template, Feature Template, and the Receptionist/Secretary Template.

The Clear Template is used to erase previous voice terminal features so that new features can be assigned. The Dialer Template is for personnel who do not require special phone features and aren't likely to need to make toll calls. The Feature Template is for managers and owners who need unrestricted phone use along with special additional features. The Receptionist/Secretary Template is for receptionists, secretaries, and backup call handlers who process several calls. See "Voice Terminal Templates" in Section 5, "Reference" for more details.

Under "Template" on the "Voice Terminal" form . . .

Write a "1" if you want to assign the Clear Template to a voice terminal and erase any features currently assigned to that voice terminal.

Write a "2" if you want to assign the Dialer Template to a voice terminal.

Write a "3" if you want to assign the Feature Template to a voice terminal.

Write a "4" if you want to assign the Secretary/Receptionist Template to a voice terminal.

### PROGRAM MODE LOCK

The Program Mode Lock feature allows you to lock specified voice terminals so that individuals *cannot* change the features assigned to their voice terminals.

Under "Lock" on the "Voice Terminals" form . . .

Put a check mark next to each voice terminal you want to assign Program Mode Lock.

You should now have a completed System Configuration Form.

# Line Assignments Form

---

## **NAME AND INTERCOM NUMBER**

You can use the information already entered on your System Configuration Form to complete this part of the Line Assignments Form.

In the “Name” column on the form . . .

Write the names of the people in your business next to their intercom numbers.

## **LINE ASSIGNMENTS FOR VOICE TERMINALS**

When your system is first installed all your outside telephone lines appear on the same buttons on every voice terminal in the system. These are the voice terminals’ *original* line assignments. Figure 2-1 shows the original line assignments for 5-, 10-, 22-, and 34-button voice terminals. A voice terminal retains its original line assignments until someone administer it differently.

**FIGURE 2-1 Original Line Assignments.**

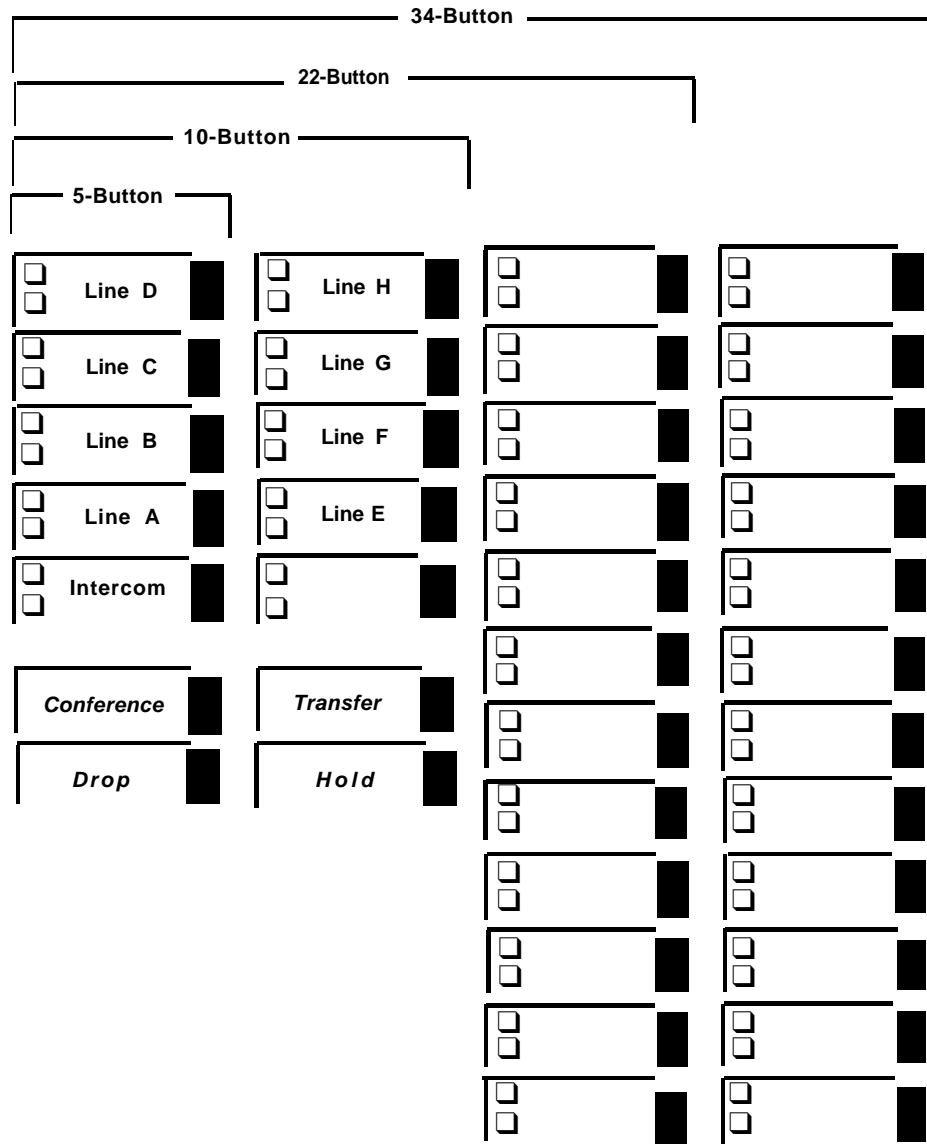

---

MERLIN Plus system line administration offers you these options:

- Customize the line assignments on some or all of your voice terminals.
- Keep the original line assignments on some or all of your voice terminals.

The following paragraphs offer guidelines for choosing a line assignment option for each voice terminal and recording your choices on the form.

### **Guidelines for Choosing Line Assignment Options**

As you decide whether to keep the original line assignments or customize the line assignments on one or more voice terminal, review your business calling patterns and each person's telephoning responsibilities. You may find that by customizing line assignments, you can help control costs and increase the efficiency of your communications system.

Let's say, for example, that you are the MERLIN Plus system administrator for a branch office of a large company. Your system has six outside telephone lines:

- Lines A, B, and C are local, general purpose lines with your office's published telephone numbers. They're listed first, second, and third respectively in directories and advertisements.
- Line D is a WATS line to the distant area where most of your company's suppliers are located.
- Line E is a foreign exchange (FX) line to the distant city where the company's headquarters are located.
- Line F is a general purpose line with an unpublished telephone number that the branch manager wants as a personal line.

Figure 2-1 shows how these lines appear on all voice terminals before you customize line assignments.

Now let's consider the following facts about the calling requirements of three people in the office: the buyer, the branch manager, and the clerk.

- Most of the buyer's outgoing calls are to suppliers in the area served by the WATS line and to the purchasing and accounting departments at company headquarters. The buyer receives relatively few incoming calls, but they are usually important.
- The branch manager calls company headquarters often and wants a personal line for other calls.
- The clerk handles most of the incoming calls from customers and prospective customers, and has no need to call suppliers or the headquarters offices.

Figure 2-2 shows how you might customize the line assignments on the buyer's, the manager's, and the clerk's voice terminals to best meet their individual needs and responsibilities.

**FIGURE 2-2 Customized Line Assignments.**

<input type="checkbox"/> Line B	<input type="checkbox"/>	<input type="checkbox"/>	<input type="checkbox"/>
<input type="checkbox"/> Line C	<input type="checkbox"/>	<input type="checkbox"/> Line C	<input type="checkbox"/>
<input type="checkbox"/> Line E	<input type="checkbox"/>	<input type="checkbox"/> Line B	<input type="checkbox"/>
<input type="checkbox"/> Line D	<input type="checkbox"/>	<input type="checkbox"/> Line A	<input type="checkbox"/>
<input type="checkbox"/> Intercom	<input type="checkbox"/>	<input type="checkbox"/> Intercom	<input type="checkbox"/>
<i>Conference</i>	<i>Transfer</i>	<i>Conference</i>	<i>Transfer</i>
<i>Drop</i>	<i>Hold</i>	<i>Hold</i>	<i>Hold</i>

**BUYER**

**CLERK**

<input type="checkbox"/>	<input type="checkbox"/>
<input type="checkbox"/>	<input type="checkbox"/>
<input type="checkbox"/> Line E	<input type="checkbox"/>
<input type="checkbox"/> Line F	<input type="checkbox"/>
<input type="checkbox"/> Intercom	<input type="checkbox"/>
<i>Conference</i>	<i>Transfer</i>
<i>Drop</i>	<i>Hold</i>

**MANAGER**

- Line A = Primary listed telephone number
- Line B = Second listed telephone number
- Line C = Third listed telephone number
- Line D = WATS line
- Line E = FX line
- Line F = Manager's personal line

---

### **Original Line Assignments**

You can keep the original line assignments on the voice terminals of those people who need access to every outside line in the system.

In the “Line” columns to the right of each appropriate intercom number . . .  
On the top row work 1 under Line A, 2 under Line B, and soon for as many lines as you have in your system.

### **Customized Line Assignments**

After you’ve reviewed the responsibilities of the people in your business, you can determine who needs customized line assignments.

In the “Line” columns to the right of each appropriate intercom number. . .  
On the top row write a “1” for the line you want to appear on the first button, a “2” for the line to appear on the second button, and so on up to eight.

## **RINGING OPTIONS**

For each line that is assigned to a voice terminal, you can select one of three ringing options:

### **Immediate Ring**

People who have primary responsibility for answering calls or handling a particular line should have that line administered for immediate ring.

### **Delayed Ring**

People who are providing secondary coverage for a line should have that line assigned for delayed ring so that the line rings only after ringing first at the person’s voice terminal who has primary responsibility for that line.

### **No Ring**

In places like office lobbies, conference rooms, and public places, the no ring option may be appropriate.

In the “Line” columns to the right of each appropriate intercom number. . .  
In the bottom row for every line that is being assigned to a voice terminal, write an “I” if the line should ring immediately, a “D” if it should ring only after ringing at another voice terminal first, or an “N” if the line should not ring at this voice terminal.

---

**BUTTON-FREE LINE OPERATION**

You can use this option to assign outside lines to a voice terminal without assigning them to specific line buttons. This feature is useful for 5-Button and 10-Button voice terminals so that buttons are available for programmable features. You can also select either the immediate ring or no ring option with Button-Free Line Operation.

**Immediate Ring**

Those people with primary responsibility for answering calls coming in on a shared line should have that line administered for immediate ring.

**No Ring**

For voice terminals located in public places, such as lobbies and conference rooms, so they do not ring for outside calls.

In the bottom row for ringing options of each appropriate intercom number. . .  
Circle the "I" or "N" if the line will be Button-Free, assigned to the voice terminal but not to a specific line button.

**AUTOMATIC LINE SELECTION SEQUENCE**

When you touch **Speakerphone** or lift the voice terminal handset to make an outside call, the system automatically scans the outside telephone lines in the order in which they appear on your voice terminal's line buttons until it finds a free line for your call. For example, if your voice terminal has the original line assignments, the system gives you Line A, if it's free, when you touch **Speakerphone** or lift the handset. If Line A is busy, the system tries Line B, and so on in alphabetical order until it finds a free line for your call. Likewise, if your voice terminal has customized line assignments, the system will search for a free line following the customized sequence.

In most cases, you probably want a voice terminal's automatic line selection sequence to be the same as the sequence in which the lines appear on the voice terminal's line buttons. If, however, you want a special automatic line selection sequence for a voice terminal, you can program that sequence when you administer the system's outside lines.

**NOTE:** A special automatic line selection sequence for a voice terminal can contain any or all of the lines that appear on the voice terminal's line buttons.

**LINE ASSIGNMENTS FOR ASA FEATURES**

Four ASA features require the assignment of at least one incoming line on which you want to use the feature. These features are: Call Forwarding (CF), Direct Extension Dialing (DXD), Remote Line Access (RLA), and System Answer (SA). Call Forwarding also requires the assignment of at least one outgoing line.

**Call Forwarding (CF)**

This ASA feature connects incoming calls on assigned lines to the Voice Synthesis Processor (VSP) so that callers hear a prerecorded message before calls are forwarded to the designated number. The CF feature requires the assignment of at least one incoming line and one outgoing line. They *cannot* be the same line.

---

In the “CF” row under the “Line Assignments for ASA Features” . . .

Write an “I” in the column of the line(s) where incoming calls are being forwarded.

Write an “O” in the column of the line where you want to send the outgoing forwarded calls.

The system is factory set to answer CF calls after two rings. You can change the number of rings from 0 to 9. If the number of rings is set to 0, the voice terminal will not ring, and calls will be forwarded immediately.

Under “Ring Interval” in the “CF” row . . .

Write the number of rings (0-9) before incoming calls will be answered by the VSP and forwarded.

When in CF mode, callers hear the message:

*“Your call is being forwarded. Please hold.”*

You can modify this message to include the incoming phone number:

*“You have reached [number]. Your call is being forwarded.  
Please hold.”*

You can modify the message for all incoming CF lines or just for some of the incoming CF lines. You can also turn off the message so that calls are forwarded immediately without notifying the caller.

Under “Modify Message” in the row for “CF” . . .

Write the incoming phone number if you want it added to the VSP message, or write a “0” if you want to turn off the VSP message.

### **Direct Extension Dialing (DXD)**

This ASA feature allows incoming callers using Touch-Tone phones to direct their calls to specific extensions. Direct Extension Dialing can be assigned to one or more lines so that incoming calls are answered by the Voice Synthesis Processor (VSP) which prompts callers to dial the desired extension number.

In the “DXD” row under “Line Assignments for ASA Features” . . .

Write an “I” in the column of the line(s) where incoming calls are being directed to specific extensions.

The system is factory set to answer DXD calls after two rings. You can change the number of rings from 0 to 9. If the number of rings is set to 0, the voice terminal will not ring, and calls are answered immediately by the VSP.



---

Under “Ring Intend” in the “DXD” row . . .

Write the number of rings (0-9) before DXD calls are answered.

Callers on DXD incoming lines are prompted with the following message:

*“Please dial desired extension number.”*

Once the caller dials the two-digit extension number (which is the two-digit intercom number), the call is transferred to the extension and the caller hears the following message:

*“Please hold.”*

You can also modify the voice message so that callers first hear the number they’ve reached, followed by the request for the extension number

*“You have reached [number]. Please dial desired extension number.”*

Under “Modify Message” in the “DXD” row . . .

Write in the incoming phone number if you want it added to the VSP message.

#### **Remote Line Access (RLA)**

This ASA feature allows you to call in from outside and use a password to gain access to one of the system’s outside lines. Remote Line Access can also be used from a remote location to change the call forwarding number. This feature requires the assignment of at least one incoming line.

In the “RLA” row under “Line Assignments for ASA Features” . . .

Write an “I” in the column of the line(s) where incoming lines can be used for RLA.

The system is factory set to answer RLA calls after two rings. You can change the number of rings from 0 to 9. If the number of rings is set to 0, the voice terminal will not ring, and calls are answered immediately by the VSP.

Under “Ring Interval” in the “RLA” row . . .

Write the number of rings (0-9) before RLA calls are answered.

---

### System Answer (SA)

System Answer can be used as an automated attendant to answer a call and provide a brief message before placing the caller on hold until someone is available to take the call. System Answer can have up to eight incoming lines assigned to it.

In the “SA” row under “Line Assignments for ASA Features” . . .

Write an “I” in the column of the line(s) where incoming calls are being answered and placed on hold by System Answer.

The system is factory set to answer SA calls after two rings. You can change the number of rings from 0 to 9. If the number of rings is set to 0, the voice terminal will not ring, and calls will be forwarded immediately.

Under “Ring Interval” in the “SA” row on the “Line Assignments for ASA Features” form . . .

Write the number of rings (0-9) before CF calls are answered.

You can select one of four ways to have incoming SA calls answered. You can choose the default voice message, a shortened version of it, or a longer version of it. The default message says:

*“Please hold. Your call will be handled momentarily.”*

The shorter message says:

*“Please hold.”*

The longer message says:

*“You have reached [number]. Please hold. Your call will be handled momentarily.”*

You can also elect to have no voice message so that incoming SA calls are immediately placed on hold.

Under “Modify Message” in the “SA” row . . .

Write a “0” if you do not want the voice message.

Write a “1” if you want the message just to say, *“Please hold.”*

Write a “2” if you want the message to say, *“Please hold. Your call will be handled momentarily.”*

Write the incoming phone number if you want the longer message preceded with the phrase, *“You have reached [number].”*

You should now have a completed Line Assignments Form. Keep it in a place where you can find it when you want to administer the system or program individual voice terminals.

# Call Restrictions Forms

---

You can use call restrictions to prevent some or all voice terminals from making outside calls (both local and long distance). You can also use the Disallowed List to prevent some or all voice terminals from making billable calls to 900 numbers, the 976 exchange, or other numbers as desired.

**NOTE:** System Speed Dial with Restriction Override, which can be used as a password to access an otherwise restricted number, takes precedence over Disallowed List. Disallowed List takes precedence over everything else.

You can use Allowed Lists of numbers and/or special Speed Dial codes to permit call restricted voice terminals to call specified telephone numbers, local exchanges, or area codes. By combining call restrictions with selected exceptions, you can control your outgoing call traffic and associated costs without placing unreasonable constraints on the people in your business. (Disallowed List, Allowed Lists, and System Speed Dial codes are explained in detail in this section of the manual.)

**NOTE:** Call restrictions do *not* affect a voice terminal's ability to receive incoming calls nor to make intercom calls.

## DISALLOWED LIST

When you assign a Disallowed List of numbers to a voice terminal, the person trying to dial a number on this list will not be able to place the call.

The system can store up to 20 disallowed numbers with up to 16 digits for a given number. You can also use "wild card" digits to prevent calls to certain exchanges within any area code, or similar combinations. Here are some examples of how to use wild card digits:

- Disallowing calls to the 976 exchange in any area code:  
**1Hold 976** or **0Hold 976** where the wild card digits are entered by pressing **Hold** three times.
- Disallowing calls to any area code:  
**1Hold** or **0Hold** where the wild card digits are entered by pressing **Hold** three times.

For many restrictions, you don't have to use wild card digits. Here are some examples:

- Disallowing calls to any 976 number in the 201 area code:  
1201976
- Disallowing calls to the 201 area code:  
1201
- Disallowing calls to a specific number in the 201 area code; 555-9876 for example:  
12015559876.
- Disallowing local calls to a specific number such as 555-5432:  
555-5432

---

### Creating the Disallowed List

Once you've decided how many billable numbers you want to disallow, you write each entry next to a separate item (labeled 01 through 20) on the Disallowed List Entry Form located at the beginning of the Call Restrictions Form.

On the "Disallowed List Entry Form— List 09" . . .

Write billable numbers, area codes, etc., in the "Number" column to create your Disallowed List.

### Assigning the Disallowed List

Now that you have created your Disallowed List, you should decide to which voice terminals it is to be assigned when you administer the system. Enter this information on the of the Call Restrictions Assignment Form.

In the "Disallowed Lists" column of the Call Restrictions Assignment Form . . .

Put a check mark next to the intercom number of each voice terminal to which the list is to be assigned when you administer the system.

### UNRESTRICTED

When your system is first installed, all voice terminals are unrestricted, that is, there are no limitations on outgoing call traffic including long distance and local toll calls.

In the "Unrestricted" column on the Call Restrictions Assignment Form . . .

Put a check mark for each voice terminal that will not have either outward or toll restrictions.

### TOLL RESTRICTED

Some people in your business may need to be able to call any local telephone number but have little need to make long distance calls. You can place a *toll call restriction* on their voice terminals. The system will allow local calls from those voice terminals but will ignore attempts to dial long distance numbers. Then, if there are certain areas of the country these people have to call on business, you can set up an Allowed List of those long distance area codes and assign the list to the toll restricted voice terminals when you administer the system. You can also mark selected long distance telephone numbers for Restriction Override and store them under Speed Dial codes in the system's memory. Then anyone in your system, including those with toll restricted voice terminals, can use the Speed Dial codes to dial those long distance numbers.

Under "Toll Restricted" on the Call Restrictions Assignment Form . . .

Put a check mark next to the intercom number of each voice terminal that will be restricted from making long distance calls.

---

## OUTWARD RESTRICTED

Some people in your business may have little need to make any outside calls, either local or long distance. During system administration you can place an *outward call restriction* on their voice terminals, and the system will ignore attempts to dial outside telephone numbers from those voice terminals. Then if you want these people to be able to make local calls in business or personal emergencies, you can assign them an Allowed List of local exchanges and, perhaps, emergency numbers such as 911 when you assign the call restrictions.

You can also use System Speed Dial codes (called passwords in some telephone systems) with Restriction Override to allow restricted voice terminals to call selected local or long distance telephone numbers. You simply mark the numbers for Restriction Override and store them in the system's memory under Speed Dial codes when you administer the system. Then anyone in your system, including those with restricted voice terminals, can use the Speed Dial codes to call the stored numbers.

On the Call Restrictions Assignment Form . . .

Put a check mark in the "Outward Restricted" column next to the intercom numbers for the voice terminals you want to place outward restrictions on when you administer the system.

## ALLOWED LISTS

When you assign an Allowed List of numbers to a voice terminal, the person using the voice terminal can call the numbers on the list regardless of any call restriction placed on the voice terminal.

The system can store up to eight Allowed Lists of numbers with up to 10 entries in each list. Each entry can have up to eight digits. You might, therefore, want to create one or more Allowed Lists with entries such as the following:

- Local exchange codes  
A local exchange code is the first three digits in a 7-digit telephone number.
- Long distance area codes
- Area codes plus local exchange codes
- Emergency numbers with eight or fewer digits  
For example, 911 is a multipurpose emergency number in many areas.

---

### **Naming Allowed Lists**

Once you've decided how many Allowed Lists you want and what numbers should be included in each, you may want to identify each list by name (for example, "New England Customers" or "Local Emergency Numbers") in addition to the numbers that already appear on the form (List 01, List 02, etc.).

On the "Allowed Lists Entry Form" . . .

Write the name, if any, that you want to use to identify each list on the line next to the list's code number (List 01, List 02, List 03, etc.)

### **Creating Allowed Lists**

Under "Number" on the appropriate "Allowed Lists Entry Form" . . .

Write area codes, local exchange codes, emergency or other telephone numbers, on the lines next to the "Item" numbers.

### **Assigning Allowed Lists**

Now that you've created some Allowed Lists, you should decide how you want to assign them to restricted voice terminals when you administer the system. You'll need to refer to the "Call Restrictions Assignment Form".

Under "Allowed Lists Assigned" on the Call Restrictions Assignment Form . . .

Put a check mark in the appropriate box representing the allowed lists that you want to assign to each voice terminal when you administer the system.

Keep your completed Call Restrictions Forms in a place where you can find it easily for system administration.

### **Call Restrictions Flow Chart**

The following flowchart shows how the MERLIN Plus system processes outgoing calls. For example, if a call is dialed manually or with Personal Speed Dial, the system first checks to see if the voice terminal is toll or outward call restricted. If the voice terminal is unrestricted, the number dialed is checked against the Disallowed List. If the number is not on the Disallowed List, the call goes through.

FIGURE 2-3 MERLIN Plus System Processing Flowchart.

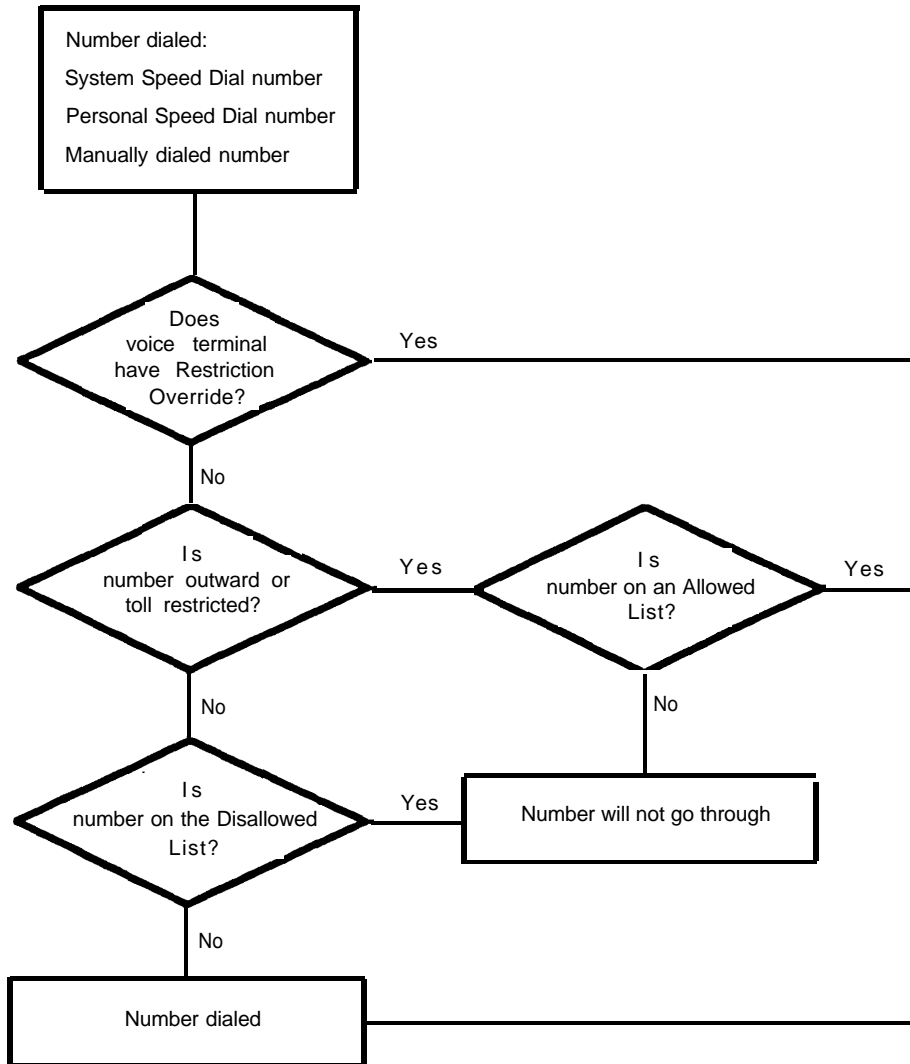

# System Speed Dial Forms

---

You can assign System Speed Dial codes to frequently called telephone numbers. Then, people in your business can call any of these telephone numbers by dialing its 3- or 4-character System Speed Dial code. You can also assign these codes to account numbers that you want printed on Call Reports if your system has the Call Report (also referred to as the Station Message Detail Recording [SMDR]) feature. People can then dial an account's code during a call to add the account number to the information on the Call Report.

You can store up to 130 telephone and/or account numbers under System Speed Dial codes. The available codes are #60 through #89 and #900 through #999. Each stored number can have up to 16 characters, including any of the following special characters:

- P for pause
- R for a switchhook flash (Recall)
- S for stop
- T for Touch-Tone enable

See the “Special Characters in Dialing Sequences” entry in Section 5, “Reference,” to find out how to use these special characters.

## PRIVATE

You can identify private numbers that you do not want to appear on displays or print on Call Reports by entering a \* before the number on the System Speed Dial Form. Then, voice terminal displays and Call Report printouts will show the System Speed Dial code instead of the number.

In the “Private” column on the System Speed Dial form . .

Put a star (\*) in front of those numbers you want to mark for privacy when you administer the system. When you enter a star (\*), before the telephone number, the number will *not* appear on displays or print on Call Reports. See “System Speed Dial” in Section 5 “Reference” for more information on Call Reports.



---

**NUMBER AND IDENTIFICATION**

In the “Number” column on the System Speed Dial form . . .

Write the telephone numbers or account numbers you want to encode on the line containing the dial codes (#60, #61, #62, etc.) of your choice. Put a check mark in the telephone column if the number is a telephone number or put a check mark in the account column if the number is an account number.

**NOTE:** Do *not* assign the same System Speed Dial code to both a telephone number and an account number.

To prevent confusion when entering both account numbers and telephone numbers, reserve codes #60 through #89 for telephone numbers and #900 through #949 for account numbers or vice versa. Also, it may be helpful to use the last four digits of a firm’s telephone number to create an account number, so the account number can be easily identified.

In the “Name” column. . .

Write the name of the person or organization to identify each number.

**RESTRICTION OVERRIDE**

When you encode the telephone numbers during system administration, you can mark some or all of them for Restriction Override. Then people with restricted voice terminals or voice terminals that have been assigned a Disallowed List can call these marked numbers by dialing the System Speed Dial codes.

In the “Restriction Override” column . . .

Put a check mark on the line for each telephone number you want to mark for Restriction Override when you administer the system.

You should now have a complete set of planning forms. Keep them together in a safe place until you are ready to install and administer your system.

# MERLIN Plus System Planning Forms

---

The following forms are shown in this section:

- System Configuration
- Line Assignments
- Call Restrictions
- System Speed Dial

Please make copies of these forms for use with your system.



# System Configuration Form

---

## Required Settings:

### Dial Signals

- Touch-Tone
- Rotary (Pulse)

### Long Distance Dialing

- Toll Prefix
- Area Code Only

### Transfer Return Interval

- No Return
- \_\_\_ Rings

## Optional Settings:

### Call Report

- Outgoing Calls Only
- Incoming and Outgoing Calls

Minimum Duration for Recorded Calls \_\_\_\_\_

### Music-on-Hold

- Low Volume
- Medium Volume
- High Volume

### Background Music

- Low Volume
- Medium Volume
- High Volume

## Outside Telephone Lines

Control Unit Jack/Line	Telephone Number	Hold Disconnect Interval		Line Type (Local, WATS, FX, etc.)
		Short	Long	
A				
B				
C				
D				
E				
F				
G				
H				

(continued)

## Voice Terminals

Intercom Number	Name	Location	Paging Groups		Template	Lock
			1	2		
10	(Attendant)					
11						
12						
13						
14						
15						
16						
17						
18	(ASA)					
19	(BB & Reports)					
20						
21						
22						
23						
24						
25						
26						
27						
28						
29						

# Line Assignments Form

## Line Assignments for Voice Terminals

Name	Icom No.	Line A Ring	Line B Ring	Line C Ring	Line D Ring	Line E Ring	Line F Ring	Line G Ring	Line H Ring
	10								
	11								
	12								
	13								
	14								
	15								
	16								
	17								
	18								
	19								
	20								
	21								
	22								
	23								
	24								
	25								
	26								
	27								
	28								
	29								

I=Immediate Ring; D=Delayed Ring; N=No Ring; Circled=Button-Free

(continued)

---

### Line Assignments for ASA Features

<b>ASA Feature</b>	<b>Line A</b>	<b>Line B</b>	<b>Line C</b>	<b>Line D</b>	<b>Line E</b>	<b>Line F</b>	<b>Line G</b>	<b>Line H</b>	<b>Ring Interval</b>	<b>Modify Message</b>
CF										
DXD										
RLA										
SA										

CF=Call Forwarding; DXD=Direct Extension Dialing; RLA=Remote Line Access; SA=System Answer

# Call Restrictions Form

---

## Disallowed List Entry Form

List 09	
Item	Number
01	
02	
03	
04	
05	
06	
07	
08	
09	
10	
11	
12	
13	
14	
15	
16	
17	
18	
19	
20	

## Allowed Lists Entry Form

List 01 _____		List 02 _____	
Item	Number	Item	Number
01		01	
02		02	
03		03	
04		04	
05		05	
06		06	
07		07	
08		08	
09		09	
10		10	

(continued)



List 03 _____		List 04 _____	
Item	Number	Item	Number
01		01	
02		02	
03		03	
04		04	
05		05	
06		06	
07		07	
08		08	
09		09	
10		10	

List 05 _____		List 06 _____	
Item	Number	Item	Number
01		01	
02		02	
03		03	
04		04	
05		05	
06		06	
07		07	
08		08	
09		09	
10		10	

List 07 _____		List 08 _____	
Item	Number	Item	Number
01		01	
02		02	
03		03	
04		04	
05		05	
06		06	
07		07	
08		08	
09		09	
10		10	

(continued)

## Call Restrictions Assignment Form

Intercom Number	Disallowed List	Unrestricted	Toll Restricted	Outward Restricted	Allowed Lists Assigned								
					01	02	03	04	05	06	07	08	
10													
11													
12													
13													
14													
15													
16													
17													
18													
19													
20													
21													
22													
23													
24													
25													
26													
27													
28													
29													



# System Speed Dial Form

Dial Code	Private	Number	(Check one)		Name	Restriction Override
			Telephone	Account		
#60						
#61						
#62						
#63						
#64						
#65						
#66						
#67						
#68						
#69						
#70						
#71						
#72						
#73						
#74						
#75						
#76						
#77						
#78						
#79						
#80						
#81						
#82						
#83						
#84						
#85						
#86						
#87						
#88						
#89						
#900						
#901						
#902						
#903						
#904						
#905						
#906						
#907						
#908						
#909						

(continued)

Dial Code	Private	Number	(Check one)		Name	Restriction Override
			Telephone	Account		
#910						
#911						
#912						
#913						
#914						
#915						
#916						
#917						
#918						
#919						
#920						
#921						
#922						
#923						
#924						
#925						
#926						
#927						
#928						
#929						
#930						
#931						
#932						
#933						
#934						
#935						
#936						
#937						
#938						
#939						
#940						
#941						
#942						
#943						
#944						
#945						
#946						
#947						
#948						
#949						

(continued)

Dial Code	Private	Number	(Check one)		Name	Restriction Override
			Telephone	Account		
#950						
#951						
#952						
#953						
#954						
#955						
#956						
#957						
#958						
#959						
#960						
#961						
#962						
#963						
#964						
##65						
#966						
#967						
#968						
#969						
#970						
#971						
#972						
#973						
#974						
#975						
#976						
#977						
#978						
#979						
#980						
#981						
#982						
#983						
#984						
#985						
#986						
#987						
#988						
#989						

(continued)

---

Dial Code	Private	Number	(Check one)		Name	Restriction Override
			Telephone	Account		
#990						
#991						
#992						
#993						
#994						
#995						
#996						
#997						
#998						
#999						

# Section 3: Administering the System

---



# Introduction

---

You can begin using your MERLIN Plus Communications System right now. Just make sure the system is set to generate the right dial signals for your outside telephone lines and to recognize the long distance dialing procedure for your area. To make these simple checks, see “Dial Signals” and “Long Distance Dialing” under “Basic Administration” later in this section.

To take full advantage of your system’s advanced features you should plan to customize it to fit the needs of your business. However, you do not need to customize it all at once. Look through this section for options and features that best suit the way your business operates, and make the most important settings first. You can always change these or add others later.

Before you begin to customize your system, you should understand the meaning of the terms “administer” and “program” as they are used in this manual:

- *Administer* means to establish options and features that have systemwide impact, such as assigning the outside lines that each voice terminal can access or defining System Speed Dial codes for everyone to use.
- *Program* means to assign features to an individual voice terminal. Most people will probably program their own voice terminals. But you may want to program certain features that can affect the calling patterns of your business.

## **INITIAL ADMINISTRATION**

Although an AT&T technician may perform the initial administration of your system, you can assist with the setup by familiarizing yourself with the time-saving instructions located under the following headings:

- Administration Preview
- Basic Administration
- Customized Line Assignments
- Systemwide Options

## **ONGOING ADMINISTRATION**

Use the “Quick Reference Guide to System Administration” and the “Quick Reference Guide to Administration Codes” at the end of this section to make changes to the system once it has been setup and administered. If you need more information on an administration procedure than is provided in the Quick Reference Guides, see Section 5, “Reference.”

# Administration Preview

## PLANNING FORMS

The information about your system recorded on the planning forms listed below is important to both initial and ongoing system administration.

- System Configuration Form
- Line Assignments Form
- Call Restrictions Forms
- System Speed Dial Form

If you haven't filled out any planning forms yet, you should do so now. It won't take long, and it will save you time later. Section 2, "Planning the System," contains copies of the forms and instructions for completing them. When you've completed the forms, go on to "Key System Components."

## KEY SYSTEM COMPONENTS

Read the following to get acquainted with the system's control unit and the administrator/attendant console.

### Control Unit

The control unit is the vital core of the system. It provides the power and intelligence for all voice terminals, and it directs all incoming and outgoing call traffic. All the system's memory, including systemwide administration and voice terminal programming, resides in the control unit. Figure 3-1 shows the control unit with the front cover removed.

FIGURE 3-1 MERLIN Plus system Control Unit.

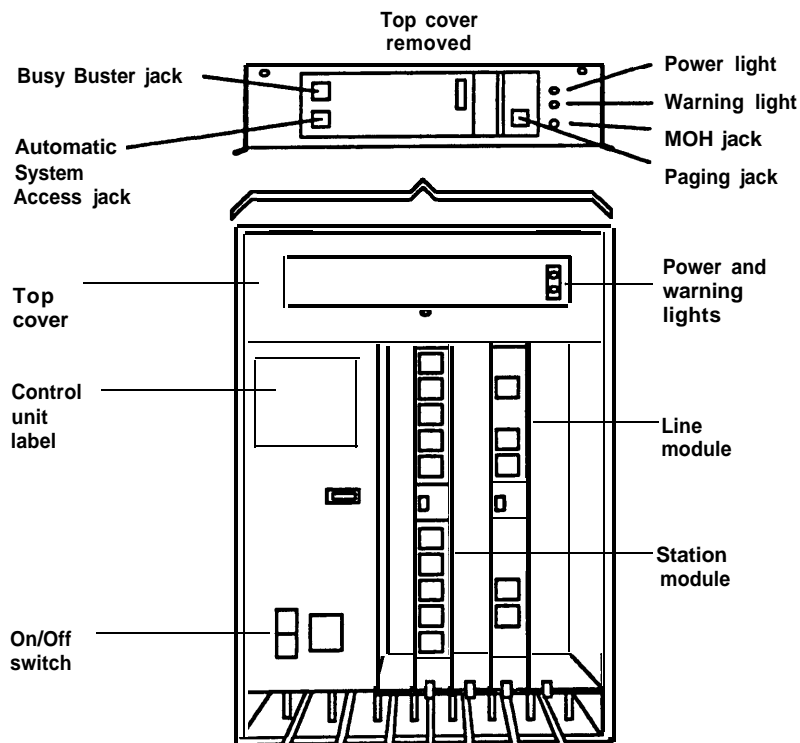

---

### Administrator/Attendant Console

A BIS-34 voice terminal or a BIS-34D voice terminal with display, both of which have lights for every outside line and voice terminal button, are ideal administrator/attendant consoles for MERLIN Plus systems with more than 10 voice terminals. Figure 3-2 shows a BIS-34D with display used as a console. The line buttons above the dial pad and the Auto Intercom buttons to the right of the dial pad give you one-touch access to each line and voice terminal. The lights allow you to keep track of administration procedures as well as changes in the status of the voice terminals and the outside lines during normal call handling.

A BIS-22 voice terminal or a BIS-22D voice terminal is a good selection for an administrator/attendant console if you have 10 voice terminals or less. When using a BIS-22 voice terminal with more than 10 voice terminals on the system, some features require that you enter the intercom numbers of the voice terminals that do not have Auto Intercom buttons at the console. Also the following features are administered using a dial code (see “The BIS-22 Voice Terminal as an Administrator Console” in this section) instead of an intercom number:

- Change the makeup of paging groups  
(See the “Group Page” entry in Section 5, “Reference,” for details.)
- Assign Disallowed List systemwide or to selected voice terminals  
(See the “Disallowed Lists” entry in Section 5, “Reference,” for details.)
- Assign Allowed Lists to restricted phones  
(See the “Allowed Lists” entry in Section 5, “Reference,” for details.)
- Lock voice terminals so that individuals cannot reprogram them.  
(See the “Program Mode Lock” entry in Section 5, “Reference,” for details.)

The position of the T/P switch on the left side of the administrator/attendant console depends on the task you are performing. There are three positions and four functions as follows:

Position	Function
<i>T (up)</i>	Tests lights and ringing
<i>Center</i>	Normal call-handling mode
<i>P (down)</i>	Programming mode for the voice terminal Administration mode for the system after touching <b>Administer</b> or dialing #49

The functions of some buttons on the administrator/attendant console change as you switch from one mode to the other. The double entries on some of the button labels shown in Figures 3-2 and 3-3 indicate these changes in function. The button’s function in the normal call-handling mode is shown *above* the line on the label, and its function in administration mode is shown *below* the line.

FIGURE 3-2 BIS-34D with Display as Administrator/Attendant Console.

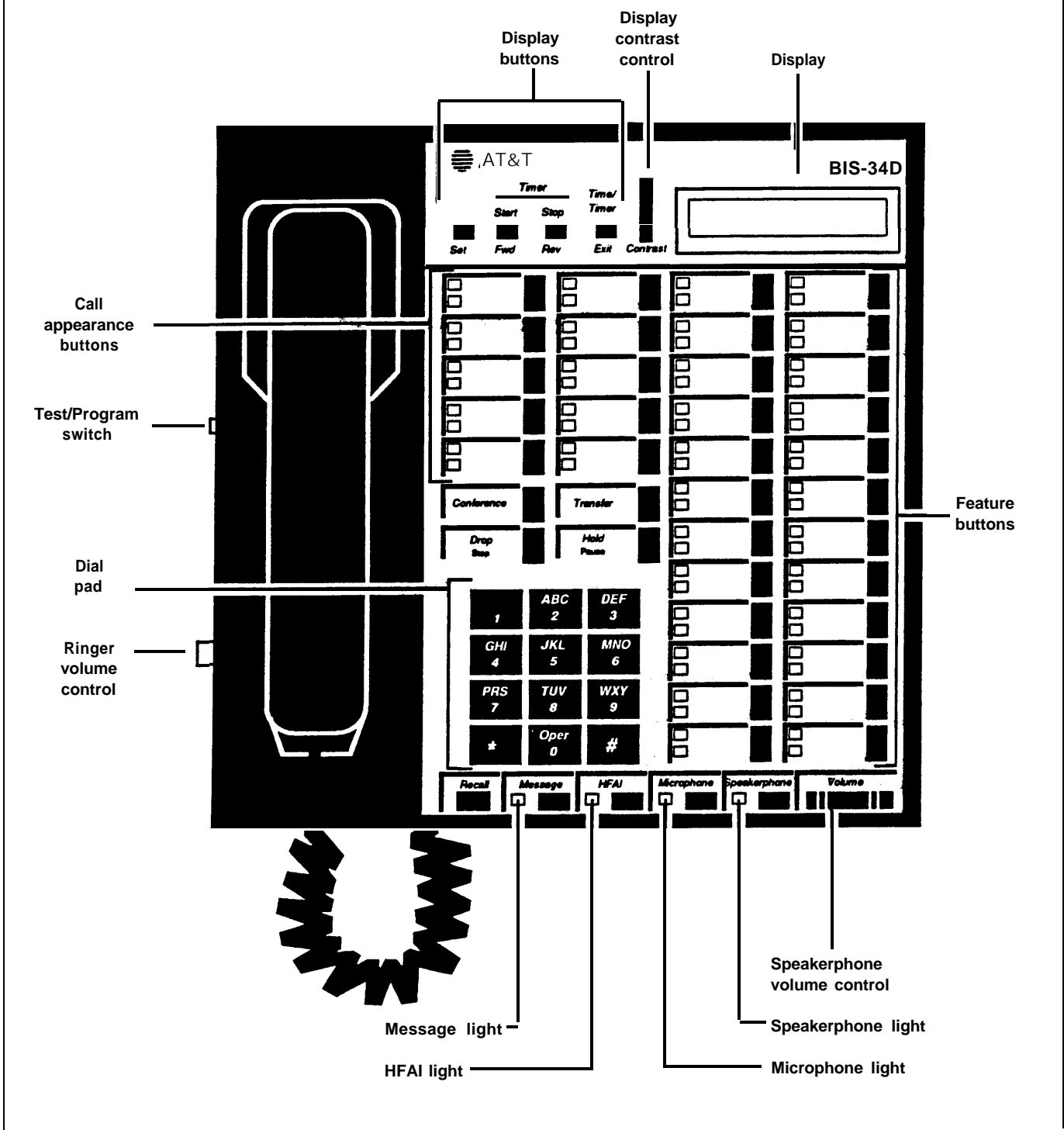
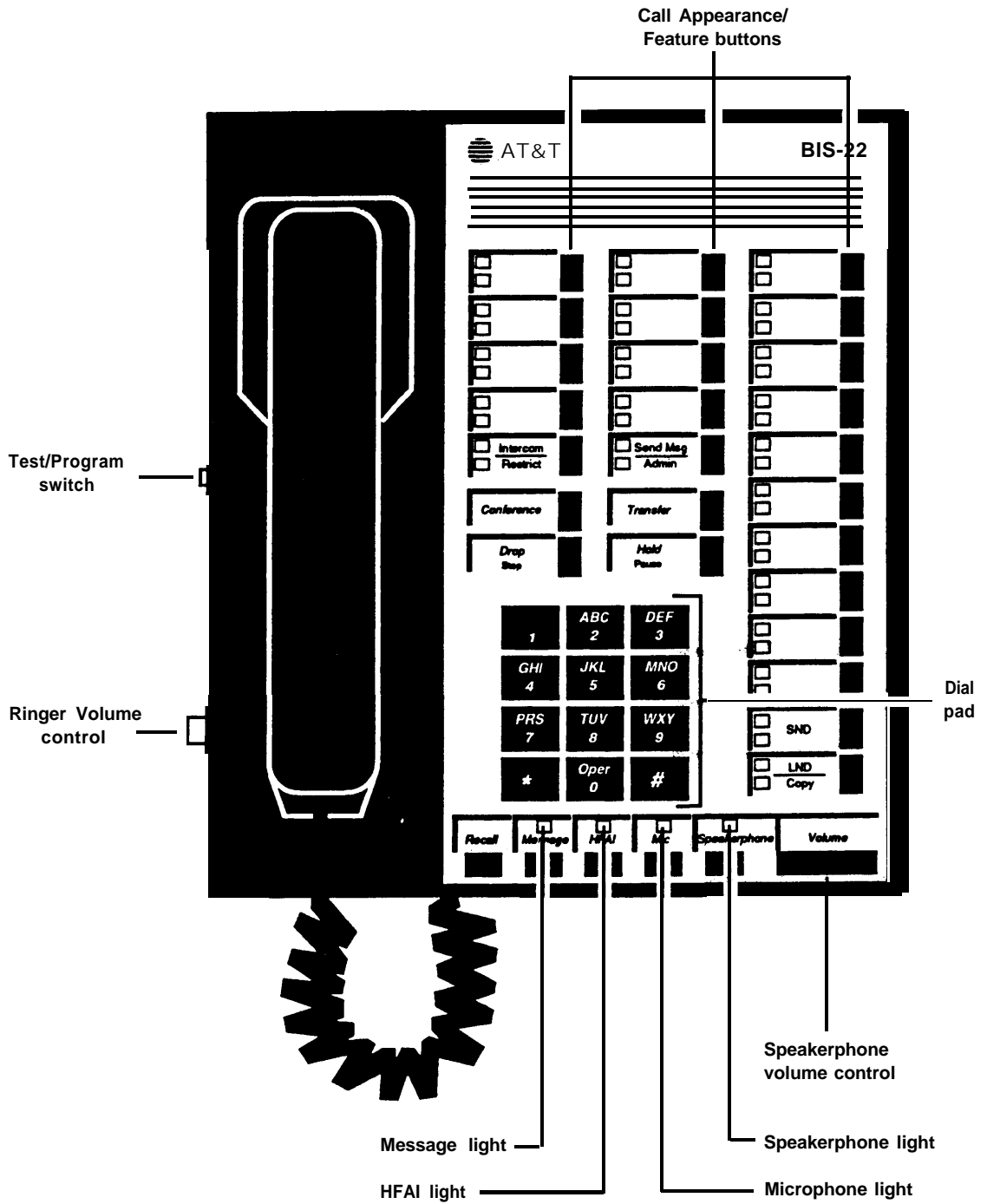

FIGURE 3-3 BIS-22 as Administrator/Attendant Console.



**THE BIS-34, BIS-34D, OR 34-BUTTON DELUXE VOICE TERMINAL USED AS AN ADMINISTRATOR CONSOLE**

If you are using a BIS-34, BIS-34D, or 34-Button deluxe voice terminal as the administrator/attendant console, you have the ideal arrangement for your MERLIN Plus system. You can administer all the features, including Disallowed and Allowed Lists, Busy Buster, and Group Page, for all the voice terminals on your system by using the Auto Intercom buttons (intercom numbers 10 through 29.) The lights next to each button indicate the status of the voice terminal as you administer each feature. The administrator console is automatically assigned the following features when you initially set up your MERLIN Plus system:

- Lines are assigned to 4 of the 10 buttons above the dial pad if the control unit has one line module.
- Lines are assigned to 8 of the 10 buttons above the dial pad if the control unit has two line modules.
- Auto Intercom buttons for intercom numbers 10 through 19 are assigned to the top 10 buttons in the first-column of buttons to the right of the dial pad.
- Auto Intercom buttons for intercom numbers 20 through 29 are assigned to the top 10 buttons in the second column of buttons to the right of the dial pad.

**THE BIS-22 OR BIS-22D VOICE TERMINAL USED AS AN ADMINISTRATOR CONSOLE**

If you are using a BIS-22 or BIS-22D voice terminal as the administrator/attendant console, the voice terminal is automatically assigned the following features when you initially set up the MERLIN Plus system:

- Lines are assigned to 4 of the 10 buttons above the dial pad if the control unit has one line module.
- Lines are assigned to 8 of the 10 buttons above the dial pad if the control unit has two line modules.
- Auto Intercom buttons for intercom numbers 10 through 19 are assigned to the top 10 buttons in the column of buttons to the right of the dial pad.
- If your system has more than 10 voice terminals (intercom numbers 20 through 29), you will *not* have buttons at the console for these voice terminals. Therefore, when you administer Group Page, Program Mode Lock, or program the Allowed and Disallowed Lists, you need to dial a code from the Dial Code Chart that corresponds with the voice terminal. When using the dial codes, you do *not* touch an Auto Intercom button.

Dial codes are *not* the same as intercom numbers.

Dial Code Chart			
If the Intercom number k:	Dial this code:	If the intercom number is:	Dial this code:
Intercom 20	#03	Intercom 25	#08
Intercom 21	#04	Intercom 26	#09
Intercom 22	#05	Intercom 27	#10
Intercom 23	#06	Intercom 28	#11
Intercom 24	#07	Intercom 29	#12

For example, if you want to assign voice terminal 21 to a Group Page group or add the voice terminal to an Allowed List, use the dial code, #04, that corresponds with intercom number 21.

**NOTE:** It is important that you record your decisions about Allowed and Disallowed Lists on the Call Restrictions Assignment Form; record decisions about your Call Report and/or System Feature Report jack assignment and Group Page on the System Configuration Form. Keep these forms handy in case you decide to make changes.

**THE BIS-10 VOICE  
TERMINAL USED AS AN  
ADMINISTRATOR  
CONSOLE**

The BIS-10 voice terminal is not recommended to be used as the administrator/attendant console because the administrator cannot see the buttons being administered. Furthermore, some features cannot be programmed from this voice terminal. However, if you are using a BIS-10 voice terminal as an administrator/attendant console to perform the administration procedures for many of the special features, follow the instructions provided for the BIS-22 voice terminal, which generally require that you enter the dial codes (see chart below) directly *without* touching an Auto Intercom button.

<b>If the intercom number is:</b>	<b>Dial this code:</b>	<b>If the intercom number is:</b>	<b>Dial this code:</b>
Intercom 10	#22	Intercom 20	#03
Intercom 11	#21	intercom 21	#04
Intercom 12	#20	Intercom 22	#05
Intercom 13	#19	Intercom 23	#06
Intercom 14	#18	Intercom 24	#07
Intercom 15	#17	Intercom 25	#08
Intercom 16	#16	Intercom 26	#09
Intercom 17	#15	Intercom 27	#10
Intercom 18	#14	Intercom 28	#11
Intercom 19	#13	Intercom 29	#12

**ADMINISTRATION MODE**

The information under the next three headings tells you how to do the following:

- Make button label sheets for the administrator/attendant console
- Enter administration mode
- Leave administration mode

**Labeling Buttons**

The button label sheets on your administrator/attendant console have to show how the functions of certain buttons change when you shift from the normal call-handling mode to the administration mode. Figure 3-2 shows you what the button labels should look like for a BIS-34D voice terminal with Display. Figure 3-3 shows the button labels for a BIS-22 voice terminal.

---

To make button labels for the voice terminal you plan to use as your administrator/attendant console, do the following:

- 1 Remove the blank button labels from the voice terminal according to the instructions that came with the voice terminal.
- 2 Fill in the button labels with pencil or ballpoint pen since either can be erased if you make changes later.
  - > For any BIS-34 and 34-button voice terminals, follow the button labeling shown in Figure 3-2.
  - > For any BIS-22 voice terminal, follow the button labeling shown in Figure 3-3.

**NOTE:** On the button labels divided by a horizontal line, the term *above* the line identifies the button's function when the console is in the normal call-handling mode. The term *below* the line identifies the button's function in administration mode.

- 3 Reinsert the labels following the instructions that came with the voice terminal.

### Entering Administration Mode

You have to enter administration mode to set up the system initially and any time you use the attendant console to administer the system. Follow the boxed instructions below whenever you have to enter administration mode.

#### Entering Administration Mode

To enter administration mode:

- 1 Slide the T/P switch on the left side of the console to *P* (down).  
*The green lights next to the line buttons begin flashing.*  
*The console rings every 5 seconds to remind you that it's in programming mode.*
- 2 Touch **Administer**, or dial #49.  
*The green lights go off.*  
*The red lights go on next to **Administer** and **Restrict**.*

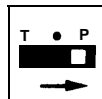



---

### Leaving Administration Mode

Follow the boxed instructions below when you've finished an administration session.

#### Leaving Administration Mode

To leave administration mode:

- 1 Slide the T/P switch on the left side of the console to the center position.  
*The red light goes off next to **Administer** and **Restrict**.*  
The red light goes on next to a line button.

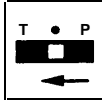

### CONFIRMATION AND ERROR SIGNALS

Many of the administration and programming procedures described in this manual require you to enter a star code (that is, dial \* plus one or more digits). Many procedures also require you to enter intercom numbers or other sequences of digits.

#### Confirmation Signal

If you enter a star code that the system recognizes, the console beeps twice when you touch **Administer** to conclude the procedure. The two beeps confirm allowable input.

#### Error Signal

You will hear only one beep from the attendant console if you make one of the following errors:

- You enter an unrecognized star code.
- You enter a nonexistent intercom number.
- You enter one or more digits that are inconsistent with the administration procedure.
- You attempt to administer a voice terminal that is active on a call or in program mode.
- You attempt to assign an alternate attendant position with the System Answer feature on.

To recover from the error, touch **Administer** and begin the procedure again.

# Basic Administration

---

Basic administration should take no more than a few minutes. All the information you need should be on the System Configuration Form.

## OUTSIDE TELEPHONE LINES

This simple procedure tells the control unit how many outside telephone lines your system has. But it works only if your outside lines are plugged into an unbroken sequence of line jacks on the control unit beginning with line jack A. The System Configuration Form shows the number of lines you have and the control unit line jack for each line under the heading “Outside Telephone Lines.”

To set the systemwide line assignments, do the following:

- 1 Enter administration mode.  
*The red lights go on next to **Administer** and **Restrict**.*
- 2 Dial \*4 plus the number of outside lines in the system.  
(For example, dial \*43 for a system with three lines.)
- 3 Touch **Administer**.  
*The console beeps twice.*
- 4 Continue to administer the system, or leave administration mode.

## GHOST LINES

When you first turn on the system, the control unit thinks there are the same number of outside lines in the system as there are line jacks on the control unit. This causes the control unit to create “ghost” lines in a system that has fewer lines than line jacks. Since ghost lines can interfere with some system features, you should eliminate them using the procedure described above for designating the number of lines in the system.

## DIAL SIGNALS

Locate the column headed “Dial Signals” on the System Configuration Form. Is the box next to “Touch-Tone” checked? If so, *you don’t have to do anything here*. Your system is factory set to generate Touch-Tones when you dial an outside call on any of your outside telephone lines.

But if the box next to “Rotary (Pulse)” is checked, you have to set the system to generate rotary (pulse) signals when you dial outside calls. Set the system for pulse dialing as follows:

- 1 Enter administration mode.  
*The red lights go on next to **Administer** and **Restrict**.*
- 2 Dial \*39.  
**NOTE:** If you ever have to reset the system for Touch-Tone dialing, dial \*38 instead of \*39 in step 2.
- 3 Touch **Administer**.  
*The console beeps twice.*
- 4 Continue with administration, or leave administration mode.

---

## LONG DISTANCE DIALING

Locate the column headed “Long Distance Dialing” on the System Configuration Form. Is the box next to “Toll Prefix” checked? If so, *you don’t have to do anything here*. Your system is factory set for this type of long-distance dialing: toll prefix (1 or 0) + area code + telephone number.

But if the box next to “Area Code Only” has a check, you have to set the system for this type of long-distance dialing (area code + telephone number) as follows:

- 1 Enter administration mode.  
*The red lights go on next to **Administer** and **Restrict**.*
- 2 Dial \*37.
- 3 Touch **Administer**.  
*The console beeps twice.*
- 4 Continue to administer the system, or leave administration mode.

### Reversing the Procedure

If you ever have to reset your system to toll-prefix dialing, follow the above procedure but dial \*36 instead of \*37 in step 2.

## TRANSFER RETURN INTERVAL

Locate the column headed “Transfer Return Interval” on the System Configuration Form. If the box next to “\_\_\_ Rings” is checked and the number 4 is filled in, the system is factory set to return unanswered transferred calls after four rings. *You don’t have to do anything*.

But if the “No Rings” box is checked, or the “\_\_\_ Rings” box is filled in with a number other than 4, then you have to change the system as follows:

- 1 Enter administration mode.
- 2 Dial \*2 plus the number of rings (0 through 9) you want before a call returns.  
**NOTE:** For use with answering machines, set the transfer return interval to six rings or more. If 0 is selected, calls will not be transferred back to the originator.
- 3 Touch **Administer**.  
*The console beeps twice.*
- 4 Continue to administer the system or leave administration mode.

---

## CALL REPORT

If you have the optional data collector and printer necessary to generate Call Reports, you can keep records of incoming and outgoing calls. You will first need to set the date using the following procedure:

- 1 Enter administration mode.  
*The red lights go on next to **Administer** and **Restrict**.*
- 2 Dial \*80.
- 3 Dial two digits for the month (01 through 12).
- 4 Dial two digits for the day (01 through 31).
- 5 Dial two digits for the year (00 through 99).
- 6 Touch **Administer**.  
*The console beeps twice.*
- 7 Continue to administer the system, or leave administration mode.

Now set the time:

- 1 Enter administration mode.  
*The red lights go on next to **Administer** and **Restrict**.*
- 2 Dial \*81.
- 3 Dial two digits for the hour (00 through 23) using 24-hour time.
- 4 Dial two digits for the minute (00 through 59).
- 5 Touch **Administer**.  
*The console beeps twice.*
- 6 Continue to administer the system, or leave administration mode.

Since the system is factory set to have no calls reported, you must now select the type of calls you want reported. Locate the column headed "Call Report" on the System Configuration Form and follow the procedures below:

- 1 Enter administration mode.  
*The red lights go on next to **Administer** and **Restrict**.*
- 2 Dial \*84.
- 3 Dial a number code 0 through 2 to specify the kind of calls to be reported:
  - > If you do not want any calls reported, dial 0.
  - > If you only want outgoing calls reported, dial 1.
  - > If you want outgoing and incoming calls reported, dial 2.
- 4 Touch **Administer**.  
*The console beeps twice.*
- 5 Continue to administer the system, or leave administration mode.

Once you've selected the type of report, you need to specify the duration of the calls reported. If you filled in "1" next to "Minimum Duration of Recorded Calls," *you don't have to do anything here* since the system is set for one minute.

---

If you specified another duration (0, or 2 through 9) follow this procedure:

- 1 Enter administration mode.  
*The red lights go on next to **Administer** and **Restrict**.*
- 2 Dial \*83.
- 3 Dial one digit from 0 to 9 for the number of minutes.
- 4 Touch **Administer**.  
*The console beeps twice.*
- 5 Continue to administer the system, or leave administration mode.

## MUSIC-ON-HOLD

If you have an optional audio source and want to control the volume through system administration, locate the column headed “Music-on-Hold” on the System Configuration Form, then dial the appropriate code given in the procedure below:

- 1 Enter administration mode.  
*The red lights go on next to **Administer** and **Restrict**.*
- 2 Dial one of the following codes to set the volume you prefer:
  - > Dial \*12 to turn off Music-on-Hold.
  - > Dial \*13 to set the volume to low.
  - > Dial \*14 to set the volume to medium.
  - > Dial \*15 to set the volume to high.
- 3 Touch **Administer**.  
*The console beeps twice.*
- 4 Continue to administer the system, or leave administration mode.

## BACKGROUND MUSIC

If you have an optional audio source connected to the Music-on-Hold jack and an optional loudspeaker paging system, you can regulate the volume of background music with a dial code in system administration. Locate the column headed “Background Music” on the System Configuration Form, then dial the appropriate code given in the procedure below:

- 1 Enter administration mode.  
*The red lights go on next to **Administer** and **Restrict**.*
- 2 Dial one of the following codes to set the volume you prefer:
  - > Dial \*16 to turn off the background music.
  - > Dial \*17 to set the volume to low.
  - > Dial \*18 to set the volume to medium.
  - > Dial \*19 to set the volume to high.
- 3 Touch **Administer**.  
*The console beeps twice.*
- 4 Continue to administer the system, or leave administration mode.

---

## HOLD DISCONNECT INTERVAL

If you placed a check mark in the column marked “Short” under “Hold Disconnect Interval” on the System Configuration Form, then your local telephone company uses the 50 millisecond disconnect interval instead of the 450 millisecond interval. If your local telephone company uses a short interval, you must administer this setting for each incoming line in the system.

Follow the procedure below to administer a short hold disconnect interval:

- 1 Enter administration mode.

*The red lights go on next to **Administer** and **Restrict**.*

- 2 Dial \*69.

- 3 Touch each incoming line button to change the disconnect interval.

*Green light on = line assigned the long disconnect interval*

*Green light off = line assigned the short disconnect interval*

- 4 Touch **Administer**.

*The console beeps twice.*

- 5 Continue to administer the system, or leave administration mode.

## VOICE TERMINAL JACK ASSIGNMENTS

Your MERLIN Plus system has twenty jacks for voice terminals and special features. If you are using the ASA features (CF, DXD, RLA, or SA), Busy Buster (BB), Call Report, or System Feature Report (Reports), you need to assign a jack for them. The “Voice Terminal” form indicates the default jack assignments for these features and the main attendants, if you have changed these assignments on your form, use the appropriate procedure below to change the jack assignments accordingly:

**NOTE:** You *cannot* reassign any of the following features to jack 10 since it is reserved for the main attendant.

Changing the Automatic System Access (ASA) jack assignment:

- 1 Enter administration mode.

*The red lights go on next to **Administer** and **Restrict**.*

- 2 Dial \*59.

*The green light goes on next to the Auto Intercom button of the jack assigned to ASA.*

- 3 Perform one of the following procedures:

- > Touch the Auto Intercom button of the jack you want to assign to ASA.

*The green light goes off next to the old Auto Intercom button, and the green light goes on next to the newly assigned Auto Intercom button.*

- > Dial the intercom number of jack you’re assigning to ASA.

**NOTE:** If you hear a denial tone, the feature is on or the VSP port is active. You can either wait or turn off the feature.

- 4 Touch **Administer**.

*The console beeps twice.*

- 5 Continue to administer the system, or leave administration mode.

---

Changing the Busy Buster (BB) jack assignment:

**NOTE:** If you are going to use the Call Report or System Feature Report option, you can assign BB to the same jack as ASA by using the adapter provided with the optional data collector or memory module.

- 1 Enter administration mode.

*The red lights go on next to **Administer** and **Restrict**.*

- 2 Dial \*35.

*The green light goes on next to the Auto Intercom button of the jack assigned to BB.*

- 3 Perform one of the following procedures:

- > Touch the Auto Intercom button of the jack you want to assign to BB.

*The green light goes off next to the old Auto Intercom button, and the green light goes on next to the newly assigned Auto Intercom button.*

- > Dial the intercom number of jack you're assigning to BB.

- 4 Touch **Administer**.

*The console beeps twice.*

- 5 Continue to administer the system, or leave administration mode.

Changing the Reports jack assignment for Call Report:

**NOTE:** If you are using the same printer and data collector for producing Call Reports and System Feature Reports, you must administer the new jack assignment for both features.

- 1 Enter administration mode.

*The red lights go on next to **Administer** and **Restrict**.*

- 2 Dial \*82.

*The green light goes on next to the Auto Intercom button of the jack assigned to Call Report.*

- 3 Perform one of the following procedures:

- > Touch the Auto Intercom button of the jack you want to assign to Call Report.

*The green light goes off next to the old Auto Intercom button, and the green light goes on next to the newly assigned Auto Intercom button.*

- > Dial the intercom number of jack you're assigning to Call Report.

- 4 Touch **Administer**.

*The console beeps twice.*

- 5 Continue to administer the system, or leave administration mode.

---

Changing the Reports jack assignment for System Feature Report:

**NOTE:** If you are using the same printer and data collector for producing Call Reports *and* System Feature Reports, you must administer the new jack assignment for both features.

**1** Enter administration mode.

*The red lights go on next to **Administer** and **Restrict**.*

**2** Dial \*85.

*The green light goes on next to the Auto Intercom button of the jack assigned to System Feature Report.*

**3** Perform one of the following procedure:

> Touch the Auto Intercom button of the jack you want to assign to System Feature Report.

*The green light goes off next to the old Auto Intercom button, and the green light goes on next to the newly assigned Auto Intercom button.*

> Dial the intercom number of jack you're assigning to System Feature Report.

**4** Touch **Administer**.

*The console beeps twice.*

**5** Continue to administer the system, or leave administration mode.

Assigning an Alternate Attendant position:

**1** Enter administration mode.

*The red lights go on next to **Administer** and **Restrict**.*

**2** Dial \*79.

**3** Perform one of the following procedures:

> Touch the Auto Intercom button of the voice terminal you want to assign as the Alternate Attendant position.

> Dial the intercom number of voice terminal you're assigning for the Alternate Attendant.

**4** Touch **Administer**.

*The console beeps twice.*

**5** Continue to administer the system, or leave administration mode.



---

## PAGING GROUPS

When you filled in the “Paging Groups” columns on the System Configuration Form, you learned the following about paging groups:

- All voice terminals are automatically assigned to a single paging group, the Page-All Group, which you cannot change.
- Intercoms 10 through 19 are automatically assigned to Page Group 1; intercoms 20 through 29 are automatically assigned to Page Group 2.
- You can assign the same voice terminal to both paging groups.
- If you are using a BIS-10 or a BIS-22 voice terminal, you must administer the Group Page feature in a slightly different way.

Look at the “Paging Groups” columns on the System Configuration Form. If you plan to keep intercoms 10 through 19 in Page Group 1 and the remaining intercoms in Page Group 2, *you don't have to do anything here*. If you plan to change the makeup of the paging groups, follow the procedure below:

**1** Enter administration mode.

*The red lights go on next to **Administer** and **Restrict**.*

**2** Dial \*71 for Page Group 1 or \*72 for Page Group 2.

*If you have the corresponding Auto Intercom buttons, a green light goes on next to each one that already is assigned to that paging group.*

**3** Perform one of the following procedures:

> Touch the appropriate Auto Intercom button(s).

*The green light goes on.*

> Dial a code from the Dial Code chart (located earlier in this section under “Using the BIS-22 Voice Terminal as an Administrator Console”) that corresponds with the voice terminal.

**4** Touch **Administer**.

*The console beeps twice.*

**5** Follow steps 2 through 4 for each paging group you want to administer.

**6** Continue to administer the system, or leave administration mode.

---

## VOICE TERMINAL TEMPLATES

If you have entered a number 1 through 4 under the “Template” column of your “Voice Terminal” form, use the following procedure to assign the template to the voice terminal:

- 1 Enter administration mode.  
*The red lights go on next to **Administer** and **Restrict**.*
- 2 Dial \*10 followed by the option number of the template:
  - 1 = Clear Template
  - 2 = Dialer Template
  - 3 = Feature Template
  - 4 = Receptionist/Secretary Template
- 3 Touch the Auto Intercom button or dial the intercom number of the source voice terminal(s).  
*The console beeps twice after each voice terminal is administered a template.*
- 4 Touch **Administer**.  
*The console beeps twice.*
- 5 Label the target voice terminal buttons with the corresponding features as shown in Figures 3-4, 3-5, 3-6, and 3-7.  
**NOTE:** Features previously administered on a voice terminal that do not appear on the template still apply, such as Voice Announcement Enable/Disable and Personalized Ring.
- 6 Continue to administer the system, or leave administration mode.

### Option 1: Clear Template

This template is used to erase previously programmed features on a voice terminal so that new features can be assigned. The Clear Template removes any features assigned to a voice terminal, but does not erase line assignments. see Figure 3-4.

FIGURE 3-4 The Clear Template.

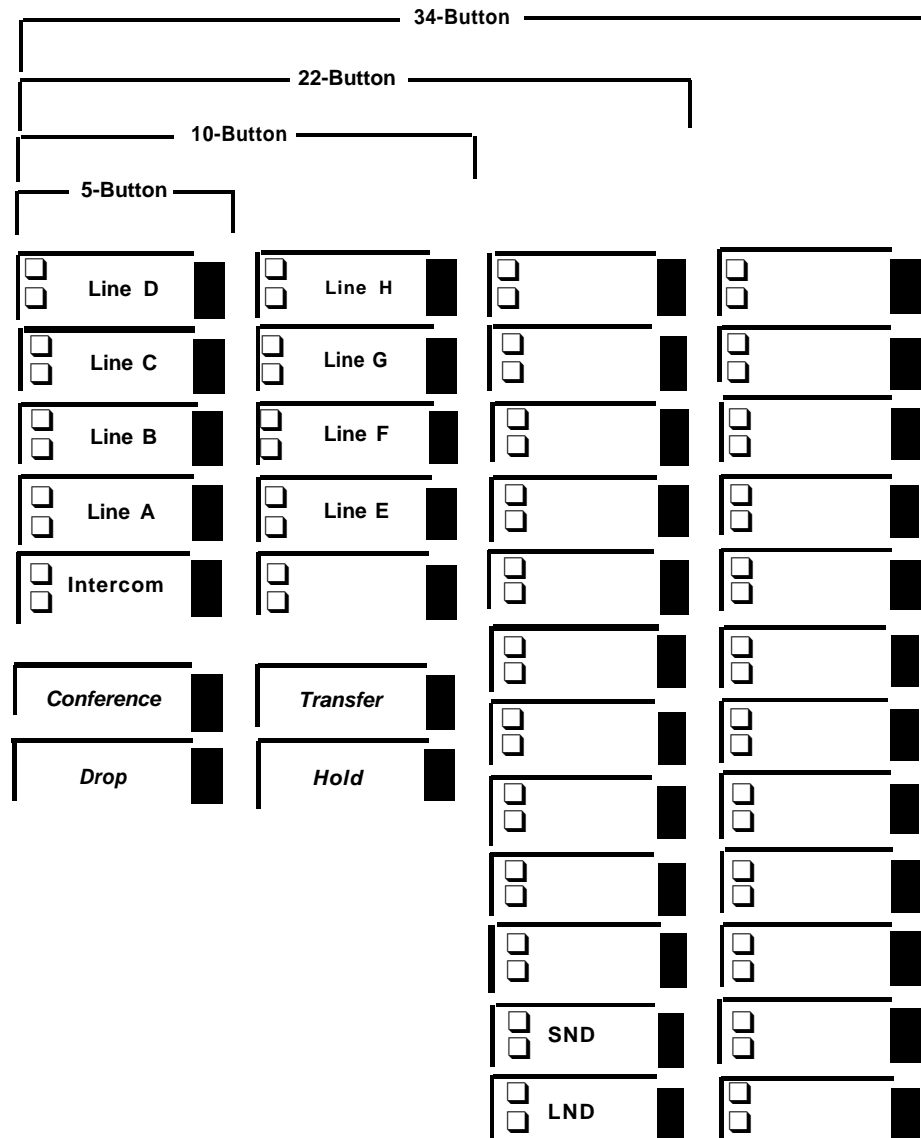

### Option 2: Dialer Template

This template is for personnel who do not require special features, and who are likely to have no need to make toll calls. This template can be assigned to even the smallest voice terminals, including the 5-button voice terminals.

See Figure 3-5 for button assignments.

FIGURE 3-5 The Dialer Template.

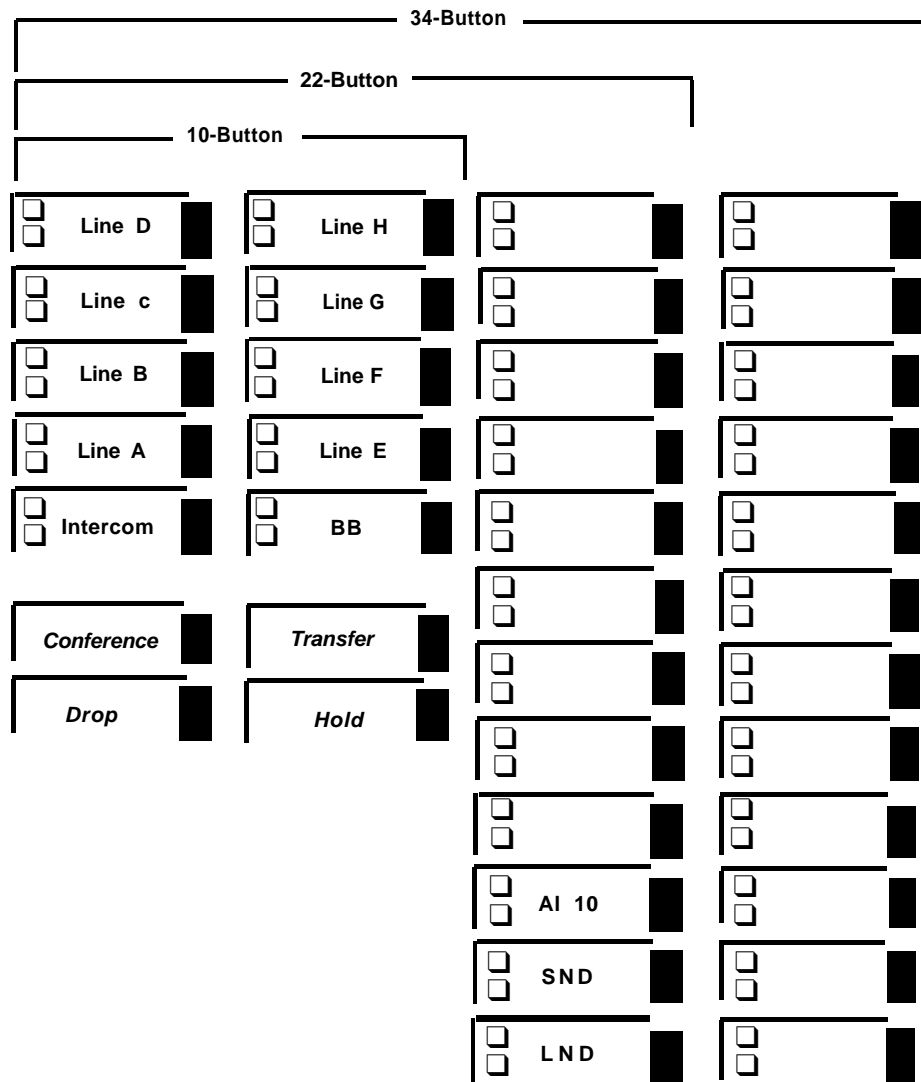

### Option 3: Feature Template

This template is designed for managers, owners, and personnel who need unrestricted phone use along with several additional features. This template is for 22-button or larger voice terminals. See Figure 3-6 for button assignments.

FIGURE 3-6 The Feature Template.

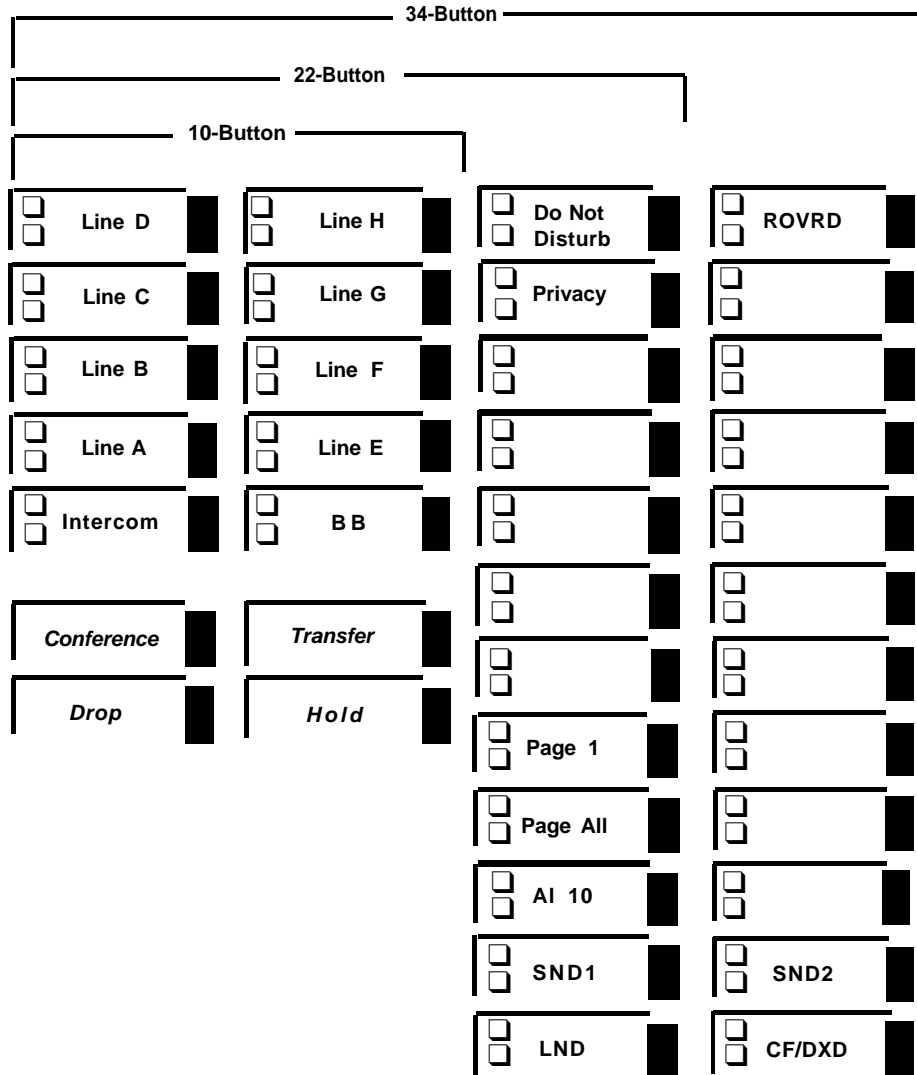

### Option 4: Receptionist/Secretary Template

This template is for receptionists, secretaries, and backup call handlers, including the system attendant, and is designed for use with 22-button or larger voice terminals. See Figure 3-7 for button assignments.

FIGURE 3-7 The Receptionist/Secretary Template.

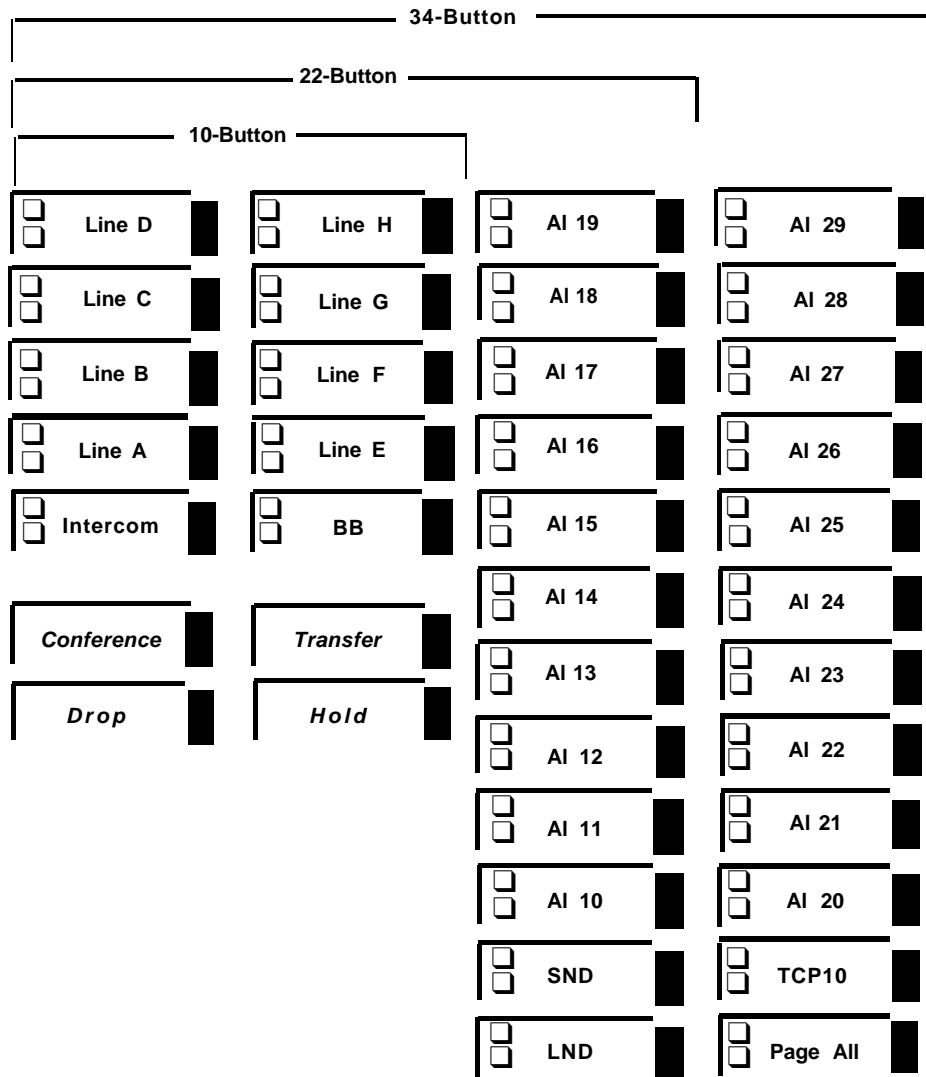

---

## PROGRAM MODE LOCK

If you placed a check mark in the “Lock” column of the “Voice Terminal” form you want to prevent the voice terminal from reprogramming any of the features assigned to it. Use the procedure below to prevent the user of a voice terminal from reprogramming any of the features assigned to it:

- 1 Enter administration mode.  
*The red lights go on next to **Administer** and **Restrict**.*
- 2 Dial \*89.
- 3 Perform one of the following procedures:
  - > Touch the Auto Intercom button of the voice terminal you are administering.
  - > Dial the intercom number of the voice terminal you are administering.
- 4 Touch **Administer**.  
*The console beeps twice.*
- 5 Continue to administer the system, or leave administration mode.

This concludes basic administration. You can use your system now, just as it is, and leave further administration until later, or you can go on and customize the outside telephone line assignments to individual voice terminals.

# Line Assignments for Voice Terminals

---

As you filled out the Line Assignments Form, you learned that customizing line assignments to voice terminals can help control costs and increase the efficiency of your communications system. All the information you need to customize line assignments should be on the Line Assignments Form.

When you enter administration mode and touch the Auto Intercom button for a voice terminal, the green lights next to the line buttons on the console show you which outside lines are currently assigned to that voice terminal.

*Green light on = line is resigned to the voice terminal*  
*Green light off = line is not assigned to the voice terminal*

Your system comes from the factory configured so that all your outside lines appear on the same line buttons on every voice terminal. These are the system's *original* line assignments. A voice terminal retains its original line assignments until someone administers it differently. If this is the first time anyone has administered your system, all your voice terminals should have their original line assignments.

**NOTE:** If you have not performed the procedure under the heading "Outside Telephone Lines" earlier in this section, the green lights next to the line buttons on your administrator/attendant console may show that your system has more outside lines than it really has. If this is the case, go back now to "Basic Administration" and enter the correct number of outside lines following the instructions under the heading, "Outside Telephone Lines."

MERLIN Plus system line administration offers two choices:

- You can keep the original line assignments on some or all of your voice terminals.
- You can customize the line assignments to some or all of your voice terminals to suit the needs of your business and voice terminal users.

## ORIGINAL LINE ASSIGNMENTS

On the Line Assignments Form, find the voice terminals that are keeping their original line assignments, then do the following:

- 1 Enter administration mode.  
*The red lights go on next to **Administer** and **Restrict**.*
- 2 One after another, touch the Auto Intercom buttons for each of these voice terminals.

The green lights next to the line buttons should show that all of your outside lines appear on each of these voice terminals. If you discover that one or more lines do not appear on a voice terminal designated to keep the original line assignments, you can use the procedure in the entry for "Customized Line Assignments" in Section 5, "Reference," to give that voice terminal the original line assignments.

- 3 Leave administration mode.



## CUSTOMIZED LINE ASSIGNMENTS

On the Line Assignments form, the numbers 1 through 8 on the top row to the right of the intercom numbers should show how you plan to customize the line assignments to voice terminals.

Customizing a voice terminal's line assignments is simply a matter of removing and adding lines. But keep the following points in mind:

- On every voice terminal (except a 5-button model), the button directly above **Conference** is always the Intercom button. You can't assign a line or feature to it.
- On every voice terminal (except a 5-button model), the button above **Transfer** is always a programmable feature button. You can't assign a line to it.
- When you assign lines to a voice terminal, the system assigns them to line buttons in the order shown in Figure 3-8 below. This sequence is also the voice terminal's automatic line selection sequence—the order in which the system selects lines for the voice terminal's outgoing calls—unless you program a different automatic line selection sequence.
- On any voice terminal, line buttons without lines assigned to them can have feature buttons programmed on them.

**FIGURE 3-8** The order in which the system assigns lines to buttons.

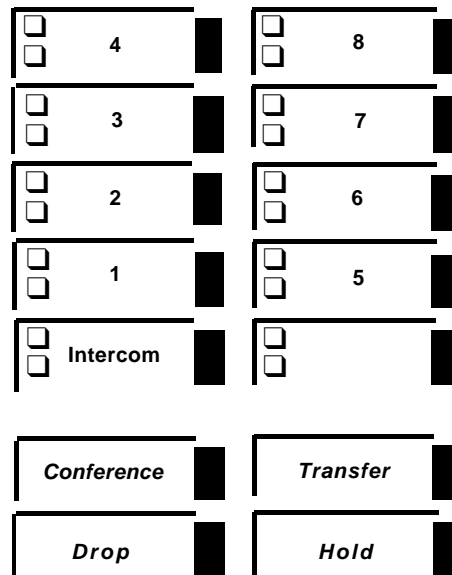

---

To assign lines to a voice terminal:

- 1 Enter administration mode.  
*The red lights go on next to **Administer** and **Restrict**.*
- 2 Perform one of the following procedures:
  - > Touch the Auto Intercom button for the voice terminal you're administering.  
*A green light goes on next to the Auto Intercom button. Green lights also go on next to the buttons of any lines already assigned to the voice terminal.*
  - > Dial the intercom number for the voice terminal you are administering.  
*Green lights go on next to the buttons of any lines already assigned to the voice terminal.*
- 3 Touch all the line buttons that have a green light on next to them.  
*The green light next to each line button goes off.*
- 4 In the order that you want lines to appear on the voice terminal, touch all the line buttons again. If you want to reserve a button(s) for feature programming, touch that button(s) last.  
*The green light goes on next to the button you touch.*
- 5 Touch **Administer**.  
*The console beeps twice.*
- 6 Continue to administer the system, or leave administration mode.

## RINGING OPTIONS

Perform the following procedure to select the ringing option for each line assigned to your voice terminals:

- 1 Slide the T/P switch to *P*.
- 2 Touch the line button you want to program.
- 3 Dial one of the codes for the type of ringing you have indicated on the Line Assignments Form:
  - > Dial \*35 for no ring (N).  
*The red light next to the button goes off.*
  - > Dial \*36 for delayed ring (D).  
*The red light next to the button flashes.*
  - > Dial \*37 for immediate ring (I).  
*The red light next to the button goes on steady.*
- 4 Repeat steps 2 and 3 for each line button.
- 5 When you've finished programming, slide the T/P switch to the center position.

---

## BUTTON-FREE LINE OPERATION

If you selected Button-Free Line Operation, so that incoming lines on a voice terminal are not assigned to buttons, you can administer whether or not calls should ring at the voice terminal. If the voice terminal is in a public place, such as a building lobby, you can select the no ring option.

If you circled “I” for Immediate Ring or “N” for No Ring on the Line Assignments for Voice Terminals form, follow the procedure below:

**1** Enter administration mode.

*The red lights go on next to **Administer** and **Restrict**.*

**2** Follow the appropriate procedure:

- > Touch the Auto Intercom button for the voice terminal you’re administering.

*The green light goes on.*

- > Dial the intercom number for the voice terminal you’re administering.

**3** Touch the line button until the green light shows the assignment you want:

*Green light on = the line is assigned to the voice terminal  
Green light off = the line is not assigned to the voice terminal*

**4** To make the line Button Free, dial one of these two codes:

- > Dial \*31 if you want the voice terminal to ring.

*The green light next to the Auto Intercom button flashes rapidly.*

- > Dial \*32 if you do not want the voice terminal to ring.

*The green light next to the Auto Intercom button flashes slowly.*

**5** Touch **Administer**.

*The console beeps twice.*

**6** Continue with administration, or leave administration mode.

---

## LINE ASSIGNMENTS FOR ASA FEATURES

The four Automatic System Access (ASA) features require the assignment of incoming lines and one requires the additional assignment of outgoing lines.

### Call Forwarding (CF)

If there is an “I” and an “O” entered under two lines in this row, perform the following procedure to administer the incoming and outgoing call forwarding lines:

- 1 Enter administration mode.  
*The red lights go on next to **Administer** and **Restrict**.*
- 2 Dial the code for the type of line group you want to administer
  - > Dial \*51 for a Call Forwarding incoming line group.
  - > Dial \*52 for a Call Forwarding outgoing line group.
- 3 Touch the line buttons until the green lights show the assignments you want to each line group.

*Green light on = line is assigned to the group  
Green light off = line is not assigned to the group*

- 4 Touch **Administer**.  
*The console beeps twice.*
- 5 Continue to administer the system, or leave administration mode.

If you entered a number other than 2 in the “Ring Interval” column for call forwarding, follow the procedure below to change the ring interval for incoming CF calls:

- 1 Enter administration mode.  
*The red lights go on next to **Administer** and **Restrict**.*
- 2 Dial \*762 plus the number of rings (0 through 9).  
**NOTE:** If 0 is selected, the voice terminal will not ring, and calls will be forwarded immediately.
- 3 Touch **Administer**.  
*The console beeps twice.*
- 4 Continue to administer the system, or leave administration mode.

If you put a telephone number in the column headed “Modify Message” for Call Forwarding, follow the procedure below:

- 1 Enter administration mode.  
*The red lights go on next to **Administer** and **Restrict**.*
- 2 Dial \*50.
- 3 Touch the line button for the line on which you want to hear the modified message.  
*The green light goes on.*

- 
- 4 Dial the telephone number you want to include in the message.

**NOTE:** For special phone numbers, such as 800 numbers, you may prefer to have the recorded voice pronounce the number as “Eight hundred” followed by the number, instead of “Eight, zero, zero.” To do this, touch **Hold** to enter a pause after the toll prefix and again after the 800 area code and then again after the exchange. For example, 1-800-555-1212 would be entered as:

1 **Hold** 800 **Hold** 555 **Hold** 1212

- 5 Repeat the procedure for each line you are administering.
- 6 Touch **Administer**.
- 7 Continue to administer the system, or leave administration mode.

If you put a “0” in the column headed “Modify Message” for CF, follow this procedure to turn off the voice message:

- 1 Enter administration mode.  
*The red lights go on next to **Administer** and **Restrict**.*
- 2 Dial \*30.
- 3 Dial 0 to turn off the message.  
**NOTE:** To turn on the message, dial 1 instead of 0 in step 3.

- 4 Touch **Administer**.  
*The console beeps twice.*

- 5 Continue to administer the system, or leave administration mode.

To enter or change the call forwarding destination number from the administrator console, use the following procedure:

- 1 Enter administration mode.  
*The red lights go on next to **Administer** and **Restrict**.*
- 2 Dial \*53.
- 3 Dial the destination number.
- 4 Touch **Administer**.  
*The console beeps twice.*
- 5 Continue to administer the system, or leave administration mode.

---

### Direct Extension Dialing (DXD)

If there is an "I" entered in this row, perform the following procedure to administer the incoming Direct Extension Dialing line(s):

- 1 Enter administration mode.  
*The red lights go on next to **Administer** and **Restrict**.*
- 2 Dial \*58 for the Direct Extension Dialing incoming line group.
- 3 Touch the line buttons until the green lights show the assignments you want.

*Green light on = line is assigned to DXD  
Green light off = line is not assigned to DXD*

- 4 Touch **Administer**.  
*The console beeps twice.*
- 5 Continue to administer the system, or leave administration mode.

If you entered a number other than 2 in the "Ring Interval" column for Direct Extension Dialing, follow the procedure below to change the ring interval for incoming DXD calls:

- 1 Enter administration mode.  
*The red lights go on next to **Administer** and **Restrict**.*
- 2 Dial \*761 plus the number of rings (0 through 9).  
**NOTE:** If 0 is selected, the voice terminal will not ring, and calls will be answered immediately.
- 3 Touch **Administer**.  
*The console beeps twice.*
- 4 Continue to administer the system, or leave administration mode.

If you put a telephone number in the column headed "Modify Message" for DXD, follow the procedure below:

- 1 Enter administration mode...  
*The red lights go on next to **Administer** and **Restrict**.*
- 2 Dial \*50.
- 3 Touch the line button for the line on which you want to hear the modified message.  
*The green light goes on.*
- 4 Dial the telephone number you want to include in the message.  
**NOTE:** For special phone numbers, such as 800 numbers, you may prefer to have the recorded voice pronounce the number as "Eight hundred" followed by the number, instead of "Eight, zero, zero." To do this, touch **Hold** to enter a pause after the toll prefix and again after the 800 area code and then again after the exchange. For example, 1-800-555-1212 would be entered as:  
**1 Hold 800 Hold 555 Hold 1212.**

- 
- 5 Repeat the procedure for each line you are administering.
  - 6 Touch **Administer**.
  - 7 Continue to administer the system, or leave administration mode.

#### **Remote Line Access (RLA)**

If there is an “I” entered in this row, perform the following procedure to administer the incoming Remote Line Access line group:

- 1 Enter administration mode.  
*The red lights go on next to **Administer** and **Restrict**.*
- 2 Dial \*54 for the Remote Line Access incoming line group.
- 3 Touch the line buttons until the green lights show the assignments you want.

*Green light on = line is assigned to RLA  
Green light off = line is not assigned to RLA*

- 4 Touch **Administer**.  
*The console beeps twice.*
- 5 Continue to administer the system, or leave administration mode.

If you entered a number other than 2 in the “Ring Interval” column for RLA, follow the procedure below to change the ring interval for incoming RLA calls:

- 1 Enter administration mode.  
*The red lights go on next to **Administer** and **Restrict**.*
- 2 Dial \*763 plus the number of rings (0 through 9).  
**NOTE:** If 0 is selected, the voice terminal will not ring, and calls will be answered immediately.
- 3 Touch **Administer**.  
*The console beeps twice.*
- 4 Continue to administer the system, or leave administration mode.

To use RLA, you must assign a 5-digit password (the first two digits are the caller’s intercom number) to gain access to the system from a remote location. You also need this password when changing the call forwarding destination number when off-site.

To assign the password, follow this procedure:

- 1 Enter administration mode.  
*The red lights go on next to **Administer** and **Restrict***
- 2 To create a password for a particular intercom number, dial the intercom number plus any three digits except 000.
- 3 Touch **Administer**.  
*The console beeps twice.*
- 4 Continue to administer the system, or leave administration mode.

---

### System Answer (SA)

If there is an "I" entered in this row, perform the following procedure to administer the incoming System Answer line(s):

- 1 Enter administration mode.  
*The red lights go on next to **Administer** and **Restrict**.*
- 2 Dial \*75 for the System Answer incoming line group.
- 3 Touch the line buttons until the green lights show the assignments you want.

*Green light on = line is assigned to SA  
Green light off = line is not assigned to SA*

- 4 Touch **Administer**.  
*The console beeps twice.*
- 5 Continue to administer the system, or leave administration mode.

If you entered a number other than 2 in the "Ring Interval" column for SA, follow the procedure below to change the ring interval for incoming SA calls:

- 1 Enter administration mode.  
*The red lights go on next to **Administer** and **Restrict**.*
- 2 Dial \*764 plus the number of rings (0 through 9).  
**NOTE:** If 0 is selected, the voice terminal will not ring, and calls will be answered immediately.
- 3 Touch **Administer**.  
*The console beeps twice.*
- 4 Continue to administer the system, or leave administration mode.

If you put an entry in the column headed "Modify Message" for SA, follow the procedure below:

- 1 Enter administration mode.  
*The red lights go on next to **Administer** and **Restrict**.*
- 2 Dial \*77 and the message number desired:  

0	=	No voice message; call is placed on hold immediately
1	=	Message says, "Please hold"
2	=	Message says, "Please hold. Your call will be handled momentarily."

- 3 Touch **Administer**.
- 4 Continue to administer the system, or leave administration mode.

This concludes outside line administration. You can go on now to "Systemwide Options," or you can leave further administration for another time.



# Systemwide Options

---

Now that your MERLIN Plus system is up and running, you can continue with system administration at a pace that best suits your work schedule. Under this heading you'll find a menu of options and features from which to choose.

## CALL RESTRICTIONS TO VOICE TERMINALS

When your system is first installed, all voice terminals are *unrestricted*. The Call Restrictions Assignment Form should show whether you plan to restrict any of your voice terminals or assign Disallowed or Allowed Lists.

## DISALLOWED LIST

If you plan to prevent all or some voice terminals from making billable calls, you should have filled in one or more entries on the Disallowed List Entry Form and put a check next to each voice terminal being assigned the Disallowed List on the Call Restrictions Assignment Form.

Use the following procedure to setup a Disallowed List:

- 1 Enter administration mode.  
*The red lights go on next to **Administer** and **Restrict**.*  
Dial \*09 followed by the Disallowed List code (01 through 20).
- 2 Dial the disallowed number (up to 16 digits). If the number includes wild card digits, touch **Hold** once for each one.
- 3 Touch **Administer**.  
*The console beeps twice.*
- 4 Continue to administer the system, or leave administration mode.

## ALLOWED LISTS

If you plan to create lists of numbers that restricted voice terminals are allowed to call, you should have filled in one or more of the lists on the Allowed List Entry Form. As the directory shows, you can have up to eight Allowed Lists with up to 10 entries on each list.

To setup an Allowed List:

- 1 Enter administration mode.  
*The red lights go on next to **Administer** and **Restrict**.*  
Dial a \* and a 2-digit code (01 through 08) that corresponds to the number of the list.
- 2 Dial the 2-digit number of the item in the Allowed List (between 01 and 10).
- 3 Dial the allowed number, toll-prefix, and area code, if necessary, or exchange to be added to the list (maximum eight digits).
- 4 Touch **Administer**.  
*The console beeps twice.*
- 5 Continue to administer the system, or leave administration mode.

---

## CALL RESTRICTIONS ASSIGNMENT FORMS

For those voice terminals with a check mark in the “Disallowed List” column on the form, follow the procedure below:

- 1 Enter administration mode.  
*The red lights go on next to **Administer** and **Restrict**.*
- 2 Dial \*0900.
- 3 Follow the appropriate procedure below:  
**NOTE:** To assign the Disallowed List to all voice terminals, touch **Conference**.
  - > Touch the Auto Intercom button for the voice terminal you want to assign the Disallowed List.  
*The green light goes on next to the Auto Intercom button.*
  - > Dial the appropriate code from the Dial Code chart located earlier in this section under the heading “The BIS-22 Voice Terminal Used as an Administrator Console” for the voice terminal to which the Disallowed List is to be assigned.
- 4 Touch **Administer**.  
*The console beeps twice.*
- 5 Continue to administer the system, or leave administration mode.

For those voice terminals with a check mark in the “Unrestricted” column on the form, *you don’t have to do anything here* because when your system is first installed, all voice terminals are unrestricted.

Check marks in the “Toll Restricted” and “Outward Restricted” columns show the type of restriction you want to place on the voice terminal.

To assign either *outward* call restrictions or *toll* call restrictions to voice terminals, follow the procedure below:

- 1 Enter administration mode.  
*The red lights go on next to **Administer** and **Restrict**.*
- 2 Follow the appropriate procedure:
  - > Touch the Auto Intercom button of the voice terminal you want to restrict.
  - > Dial the intercom number of the voice terminal you want to restrict.
- 3 Touch **Restrict** until the green light next to it shows the kind of call restriction you want the voice terminal to have:

<i>Steady green light on</i>	=	<i>Unrestricted (all talk permitted)</i>
<i>Flashing green light</i>	=	<i>Toll restricted (local and intercom calls only)</i>
<i>Green light off</i>	=	<i>Outward restricted (intercom calls only)</i>
- 4 Touch **Administer**.  
*The console beeps twice.*
- 5 Continue to administer the system, or leave administration mode.

---

For restricted voice terminals, if there is a check mark in one or more of the “Allowed List Assigned” columns, do the following:

- 1 Enter administration mode.  
*The red lights go on next to **Administer** and **Restrict**.*
- 2 Dial a \* and a two-digit code (01 through 08) that corresponds to the list you checked off to assign to the voice terminal.
- 3 Dial 00.  
*The green light goes on next to the Auto Intercom button for each voice terminal that has been assigned this list.*
- 4 Perform one of the following procedures:
  - > Touch the Auto Intercom button for the voice terminal that you want to assign the list.
  - > Use the appropriate code from the Dial Code chart earlier in this section under the heading “Using the BIS-22 Voice Terminal as an Administrator Console” for the voice terminal to which the allowed list is to be assigned.
- 5 Touch **Administer**.  
*The console beeps twice.*
- 6 Continue to administer the system, or leave administration mode.

---

## SYSTEM SPEED DIAL

You can assign System Speed Dial codes to frequently called telephone numbers or to account numbers you want to appear on call reports (if you have the Call Report option). All system voice terminals will have access to these System Speed Dial codes.

### Assigning Codes to Telephone Numbers

As you learned when you planned your system, you can store telephone numbers under System Speed Dial codes with or without Restriction override. You can also specify which telephone numbers stored under codes will be printed out in full on call reports and which will be identified in the reports by System Speed Dial code only. Your System Speed Dial Form should show which, if any, numbers you have designated for Restriction Override and which, if any, you have designated as private (that is, not to be printed on Call Reports).

To assign System Speed Dial codes:

- 1 Enter administration mode.  
*The red lights go on next to **Administer** and **Restrict**.*
- 2 Dial the code (#60 through #89 or #900 through #999) that you are assigning to the telephone number.
- 3 Dial one of the following codes:
  - > If you did *not* put a check mark in the “Restriction Override” column, dial \*90.
  - > If you put a check mark in the “Restriction Override” column, dial \*92.
- 4 Dial the telephone number. If you checked the “Private” column next to the number, dial a \* before the telephone number.  
**NOTE:** Private numbers will not appear on Call Reports or on display voice terminals. However, private numbers will appear on System Feature Reports.
- 5 Touch **Administer**.  
*The console beeps twice.*
- 6 Repeat steps 2 through 4 for each telephone number to which you are assigning a System Speed Dial code.
- 7 Continue to administer the system, or leave administration mode.

### Assigning Codes to Account Numbers

An account number on a call report allows you to identify the person or organization to whom the call should be charged. As you learned when you planned your system, you can store account numbers in the system under System Speed Dial codes. Your System Speed Dial Form should show the codes you plan to assign to your account numbers. Then, in step #3 of the above procedure enter the account number instead of the phone number.

# Quick Reference Guide to System Administration

---

The following table is a quick guide to administration procedures for the MERLIN Plus Communications System. If you need more information on a procedure than the table gives you, look up the procedure in Section 5, "Reference."

Before you perform the steps given for any procedure, you first have to enter administration mode as follows:

- 1 Slide the T/P switch on the left side of the console to *P*.  
*The red lights next to the line buttons go on steady.*  
*The green lights next to the line buttons begin flashing.*  
*The console rings every 5 seconds to remind you that it's in programming mode.*

- 2 Touch **Administer**.  
*The red lights go on steady next to **Administer** and **Restrict**.*  
*All other lights go off, and the ringing stops.*

**NOTE:** If you are performing several of these procedures in one administration session, you don't have to leave administration mode after each one. Simply dial the appropriate code or touch the appropriate button to begin the next procedure.

When you finish administering the system, leave administration mode as follows:

- 1 Slide the T/P switch to the center position.
- 2 Change any voice terminal (telephone) button labels and any entries on forms or directories to reflect the administration or programming changes you've made.

Administration Procedure	Do This
Specify <b>toll-prefix</b> or <b>area-code-only</b> dialing.	<ol style="list-style-type: none"> <li>1 Enter administration mode.</li> <li>2 Dial the appropriate code:  *36 for toll-prefix dialing  *37 for area-code-only dialing.</li> <li>3 Touch <b>Administer</b>.  <i>The console beeps twice.</i></li> <li>4 Leave administration mode.</li> </ol>
Specify <b>Touch-Tone</b> or <b>rotary</b> (pulse) dialing.	<ol style="list-style-type: none"> <li>1 Enter administration mode.</li> <li>2 Dial the appropriate code:  *38 for Touch-Tone dialing  *39 for rotary (pulse) dialing.</li> <li>3 Touch <b>Administer</b>.  <i>The console beeps twice.</i></li> <li>4 Leave administration mode.</li> </ol>

(continued)

Administration Procedure	Do This
Make Line A and/or Line E <b>Private</b> .	<ol style="list-style-type: none"> <li>1 Enter administration mode.</li> <li>2 Dial * 57. The green lights next to the buttons for Line A and Line E indicate their status: <i>Green light on = privacy active</i> <i>Green light off = privacy inactive</i></li> <li>3 Touch the line button until the green light indicates the privacy status you want.</li> <li>4 Touch <b>Administer</b>. <i>The console beeps twice.</i></li> <li>5 Leave administration mode.</li> </ol>
Customize line assignments to a telephone.	<ol style="list-style-type: none"> <li>1 Enter administration mode.</li> <li>2 Touch the Auto Intercom button or dial the intercom number for the phone.</li> <li>3 Touch the line buttons to add or remove lines. Add the lines in the order that they should appear. <i>Green light on = line is assigned</i> <i>Green light off = line is not assigned</i></li> <li>4 Leave administration mode.</li> </ol>
Specify <b>number of lines</b> in the system	<ol style="list-style-type: none"> <li>1 Enter administration mode.</li> <li>2 Dial *4.</li> <li>3 Dial the number of lines in the system (1-8).</li> <li>4 Touch <b>Administer</b>. <i>The console beeps twice.</i></li> <li>5 Leave administration mode.</li> </ol>
Assign <b>Button-Free Line Operation</b> to a telephone.	<ol style="list-style-type: none"> <li>1 Enter administration mode.</li> <li>2 Touch the Auto Intercom button or dial the intercom number for the phone.</li> <li>3 Touch the line button until the green light next to it shows the line assignment you want: <i>Green light on = the line is assigned to the voice terminal</i> <i>Green light off = the line is not assigned to the voice terminal</i></li> <li>4 Dial either *31 if you want the phone to ring on incoming calls or *32 if you don't want it to ring.</li> <li>5 Touch <b>Administer</b>. <i>The console beeps twice.</i></li> <li>6 Leave administration mode.</li> </ol> <p><b>NOTE:</b> To make all outside lines reappear on the voice terminal, enter administration mode, touch the Auto Intercom button or dial the intercom number of the phone, dial *34, touch <b>Administer</b>, and leave administration mode.</p>

(continued)

Administration Procedure	Do This
Assign <b>Call Restrictions</b> to a telephone.	<ol style="list-style-type: none"> <li>1 Enter administration mode.</li> <li>2 Touch the Auto Intercom button or dial the intercom number for the phone.</li> <li>3 Touch <b>Restrict</b> repeatedly until the green light indicates the desired restriction.  <i>Green light on steady = Unrestricted (all calls permitted)</i>  <i>Green light flashing = Toll restricted (no long distance permitted)</i>  <i>Green light off = Outward restricted (no outside calls)</i></li> <li>4 Touch <b>Administer</b>.  <i>The console beeps twice.</i></li> <li>5 Leave administration mode.</li> </ol>
Add an entry to an <b>Allowed List</b> .	<ol style="list-style-type: none"> <li>1 Enter administration mode.</li> <li>2 Dial the code for the right list; for lists 1 through 8 dial *01 through *08.</li> <li>3 Dial the item number (01 through 10).</li> <li>4 Dial the entry (up to eight digits).  <i>The console beeps twice on the eighth digit.</i></li> <li>5 Touch <b>Administer</b>.  <i>The console beeps twice.</i></li> <li>6 Leave administration mode.</li> </ol>
Remove an entry from an <b>Allowed List</b> .	<ol style="list-style-type: none"> <li>1 Enter administration mode.</li> <li>2 Dial the code for the right list; for lists 1 through 8 dial *01 through *08</li> <li>3 Dial the item number (01 through 10).</li> <li>4 Touch <b>Drop</b>.</li> <li>5 Touch <b>Administer</b>.  <i>The console beeps twice.</i></li> <li>6 Leave administration mode.</li> </ol>
Assign an <b>Allowed List</b> to a voice terminal.	<ol style="list-style-type: none"> <li>1 Enter administration mode.</li> <li>2 Dial the code for the right list; for lists 1 through 8 dial *01 through *08.</li> <li>3 Dial 00.</li> <li>4 Touch the Auto Intercom button or dial the appropriate intercom code number for the telephone.  <i>Green light on = list is assigned to the telephone</i>  <i>Green light off = list is not assigned to the telephone</i></li> <li>5 Touch <b>Administer</b>.  <i>The console beeps twice.</i></li> <li>6 Leave administration mode.</li> </ol>

(continued)

Administration Procedure	Do This
Add an entry to the Disallowed List.	<ol style="list-style-type: none"> <li>1 Enter administration mode.</li> <li>2 Dial "09 followed by the Disallowed List code (01 to 20).</li> <li>3 Dial the disallowed number (up to 16 digits).</li> <li>4 Touch <b>Administer</b>. <i>The console beeps twice.</i></li> <li>5 Leave administration mode.</li> </ol>
Remove an entry from the <b>Disallowed List</b> .	<ol style="list-style-type: none"> <li>1 Enter administration mode.</li> <li>2 Dial *09 and the Disallowed List code (01-20).</li> <li>3 Touch <b>Administer</b>. <i>The console beeps twice.</i></li> <li>4 Leave administration mode.</li> </ol>
Assign a <b>Disallowed List</b> to a voice terminal.	<ol style="list-style-type: none"> <li>1 Enter administration mode.</li> <li>2 Dial *09 then 00.</li> <li>3 Touch the Auto Intercom or dial the appropriate intercom code number of the voice terminal you want to assign the list to. <i>Green light on = list is assigned</i> <i>Green light off = list is not assigned</i></li> <li>4 Touch <b>Administer</b>. <i>The console beeps twice.</i></li> <li>5 Leave administration mode.</li> </ol>
Copy line assignments, call restrictions, and programmed features from one telephone (the source) to another (the target).	<ol style="list-style-type: none"> <li>1 Enter administration mode.</li> <li>2 Touch the Auto Intercom button or dial the intercom number for the target voice terminal.</li> <li>3 Touch <b>Copy</b>.</li> <li>4 Touch the Auto Intercom button or dial the intercom number for the source voice terminal.</li> <li>5 Touch <b>Administer</b>. <i>The console beeps twice.</i></li> <li>6 Leave administration mode.</li> </ol>
Change the <b>Hold Disconnect Interval</b> .	<ol style="list-style-type: none"> <li>1 Enter administration mode.</li> <li>2 Dial *69.</li> <li>3 Touch the line button of the incoming line that you want to change the hold disconnect interval. <i>Green light on = the long (450 millisecond) interval is selected.</i> <i>Green light off = the short (50 millisecond) interval is selected.</i></li> </ol>

(continued)



Administration Procedure	Do This
Assign <b>System Speed Dial codes</b> to telephone numbers and account numbers.	<ol style="list-style-type: none"> <li>1 Enter administration mode.</li> <li>2 Dial the code (#60 through #89 or #900 through #999) you are assigning to the number.</li> <li>3 Dial either: <ul style="list-style-type: none"> <li>*90 to assign the code without Restriction Override</li> <li>*92 to assign the code with Restriction Override</li> <li>*88 to assign the code to an account number.</li> </ul> </li> <li>4 Dial the telephone number or account number. <p><b>NOTE:</b> To designate a telephone number as private (not printed on call reports), dial * <i>before</i> the number in step 4.</p> <p><i>If the telephone number or account number has the maximum allowed 16 digits, the console beeps twice when you enter the sixteenth digit.</i></p> </li> <li>5 Touch <b>Administer</b>. <i>The console beeps twice.</i></li> <li>6 Leave administration mode.</li> </ol>
Assigning or removing a voice terminal from a <b>paging group</b> .	<ol style="list-style-type: none"> <li>1 Enter administration mode.</li> <li>2 Dial the code for the paging group (*71 or *72).</li> <li>3 Touch the Auto Intercom button or dial the appropriate code from the dial code chart for the phone you want to add or remove. <p><i>Green light on = telephone is assigned</i> <i>Green light off = telephone is removed</i></p> <p><b>NOTE:</b> Touch <b>DROP</b> to remove all voice terminals from a paging group.</p> </li> <li>4 Touch <b>Administer</b>. <i>The console beeps twice.</i></li> <li>5 Leave administration mode.</li> </ol>
Set the <b>Transfer Return Interval</b> .	<ol style="list-style-type: none"> <li>1 Enter administration mode.</li> <li>2 Dial the code for the transfer return interval you want (up to nine rings): <ul style="list-style-type: none"> <li>*2 plus the number of rings wanted (*25 = five rings).</li> <li>*20 for transferred calls to not be returned.</li> </ul> </li> <li>3 Touch <b>Administer</b>. <i>The console beeps twice.</i></li> <li>4 Leave administration mode.</li> </ol>

(continued)

Administration Procedure	Do This
Set the <b>Music-on-Hold volume</b> .	<ol style="list-style-type: none"> <li><b>1</b> Enter administration mode.</li> <li><b>2</b> Dial the code for the volume you want: <ul style="list-style-type: none"> <li>*12 to turn off Music-on-Hold.</li> <li>*13 to set the volume to low.</li> <li>*14 to set the volume to medium.</li> <li>*15 to set the volume to high.</li> </ul> <p><i>Or use the music source volume control instead.</i></p> </li> <li><b>3</b> Touch <b>Administer</b>. <i>The console beeps twice.</i></li> <li><b>4</b> Leave administration mode.</li> </ol>
Set the <b>background music volume</b> .	<ol style="list-style-type: none"> <li><b>1</b> Enter administration mode.</li> <li><b>2</b> Dial the code for the volume you want: <ul style="list-style-type: none"> <li>*16 to turn off the background music.</li> <li>*17 to set the volume to low.</li> <li>*18 to set the volume to medium.</li> <li>*19 to set the volume to high.</li> </ul> <p><i>Or use the music source volume control instead.</i></p> </li> <li><b>3</b> Touch <b>Administer</b>. <i>The console beeps twice.</i></li> <li><b>4</b> Leave administration mode.</li> </ol>
Set the <b>date</b> for <b>Call Reports</b> and <b>System Feature Reports</b> .	<ol style="list-style-type: none"> <li><b>1</b> Enter administration mode.</li> <li><b>2</b> Dial *80.</li> <li><b>3</b> Dial two digits for the month (01 through 12), two for the day (01 through 31), and two for the year (00 through 99).</li> <li><b>4</b> Touch <b>Administer</b>. <i>The console beeps twice.</i></li> <li><b>5</b> Leave administration mode.</li> </ol>
Set the <b>time</b> for <b>Call Reports</b> and <b>System Feature Reports</b> .	<ol style="list-style-type: none"> <li><b>1</b> Enter administration mode.</li> <li><b>2</b> Dial *81.</li> <li><b>3</b> Dial two digits for the hour (00 through 23) and two for the minute (00 through 59).</li> <li><b>4</b> Touch <b>Administer</b>. <i>The console beeps twice.</i></li> <li><b>5</b> Leave administration mode.</li> </ol>

(continued)

Administration Procedure	Do This
Designate a telephone jack on the control unit for <b>Call Reports</b> .	<ol style="list-style-type: none"> <li>1 Enter administration mode.</li> <li>2 Dial *82. <i>The green light goes on next to the Auto Intercom button for the jack to which the data collector and printer are currently assigned.</i></li> <li>3 Touch the Auto Intercom button for the new telephone jack to which you are assigning the data collector and printer. <i>The green light goes off next to the Auto Intercom button for the old jack, and the green light next to the Auto Intercom button for the new jack goes on.</i></li> <li>4 Touch <b>Administer</b>. <i>The console beeps twice.</i></li> <li>5 Leave administration mode.</li> </ol>
Set the minimum call duration for <b>Call Report</b> records.	<ol style="list-style-type: none"> <li>1 Enter administration mode.</li> <li>2 Dial *83.</li> <li>3 Dial one digit (0 through 9) for the minimum number of minutes. <b>NOTE:</b> The system adds 10 seconds to the number of minutes you select.</li> <li>4 Touch <b>Administer</b>. <i>The console beeps twice.</i></li> <li>5 Leave administration mode.</li> </ol>
Set the calls reported option for <b>Call Reports</b> .	<ol style="list-style-type: none"> <li>1 Enter administration mode.</li> <li>2 Dial *84.</li> <li>3 Dial the code for the calls reported option you want: 0 = no calls reported 1 = outgoing calls only 2 = outgoing and incoming calls</li> <li>4 Touch <b>Administer</b>. <i>The console beeps twice.</i></li> <li>5 Leave administration mode.</li> </ol>
Print a <b>System Feature Report</b> .	<ol style="list-style-type: none"> <li>1 Enter administration mode.</li> <li>2 Dial the code for the report or set of reports you want: *60 for one system administration report and individual phone reports. *61 for a system administration report. *62 plus touch one or more Auto Intercom buttons or dial one or more intercom numbers for individual phone reports. *63 to abort a printout and cancel all other report requests.</li> <li>3 Touch <b>Administer</b>. <i>The console beeps twice.</i></li> <li>4 Leave administration mode.</li> </ol>

(continued)

Administration Procedure	Do This
Designate a voice terminal jack on the control unit for <b>System Feature Reports</b> .	<ol style="list-style-type: none"> <li>1 Enter administration mode.</li> <li>2 Dial *85. <i>If previously administered, the green light goes on next to the Auto Intercom button for the jack to which the data collector and printer are currently assigned.</i></li> <li>3 Touch the Auto Intercom button of the jack to which the data collector and printer are connected. <i>The green light goes off next to the Auto Intercom button for the old jack, and the green light next to the Auto Intercom button for the new jack goes on.</i></li> <li>4 Touch <b>Administer</b>. <i>The console beeps twice.</i></li> <li>5 Leave administration mode.</li> </ol>
Program a telephone using <b>Centralized Programming</b> .	<ol style="list-style-type: none"> <li>1 Enter administration mode.</li> <li>2 Touch the Auto Intercom button or dial the intercom number for the phone you want to program.</li> <li>3 Touch <b>Conference</b>.</li> <li>4 Program the telephone.</li> <li>5 Touch <b>Conference</b>.</li> <li>6 Leave administration mode.</li> </ol>
<b>Lock the programming function</b> at a voice terminal	<ol style="list-style-type: none"> <li>1 Enter administration mode.</li> <li>2 Dial *89.</li> <li>3 Touch the Auto Intercom button or dial the dial code of the voice terminal you are administering. <i>Green light on = the voice terminal is locked</i> <i>Green light off = the voice terminal is unlocked and can be programmed</i></li> <li><b>NOTE:</b> Touch <b>CONFERENCE</b> to enable program mode lock systemwide. Touch <b>DROP</b> to disable program mode lock systemwide.</li> <li>4 Touch <b>Administer</b>. <i>The console beeps twice.</i></li> <li>5 Leave administration mode.</li> </ol>
Designate a voice terminal jack on the control unit for <b>Busy Buster</b> .	<ol style="list-style-type: none"> <li>1 Enter administration mode.</li> <li>2 Dial *35.</li> <li>3 Touch the Auto Intercom button or dial the intercom number for the voice terminal jack to which you want the BB jack connected.</li> <li>4 Touch <b>Administer</b>. <i>The console beeps twice.</i></li> <li>5 Leave administration mode.</li> </ol>

(continued)

Administration Procedure	Do This
Designate a jack for the <b>ASA features</b> (jack 18 is the initial assignment).	<ol style="list-style-type: none"> <li>1 Enter administration mode.</li> <li>2 Dial *59.</li> <li>3 Touch the Auto Intercom button or dial the intercom number for the jack you want to assign to ASA.</li> <li>4 Touch <b>Administer</b>. <i>The console beeps twice.</i></li> <li>5 Leave administration mode.</li> </ol>
Assign an alternate attendant to handle ASA calls.	<ol style="list-style-type: none"> <li>1 Enter administration mode.</li> <li>2 Dial *79.</li> <li>3 Touch the Auto Intercom button or dial the intercom number of the voice terminal you want to assign as the alternate attendant console.</li> <li>4 Touch <b>Administer</b>. <i>The console beeps twice.</i></li> <li>5 Leave administration mode.</li> </ol>
Select the lines, except tie lines, that you want to add to or remove from <b>CF/DXD, RLA, or SA line groups</b> .	<ol style="list-style-type: none"> <li>1 Enter administration mode.</li> <li>2 Dial the appropriate code: *51 for the CF <i>incoming</i> line group *52 for the CF <i>outgoing</i> line group *58 for the DXD incoming line group *54 for the RLA incoming line group *75 for SA incoming line group</li> <li>3 Touch line buttons until the green light next to it indicates its assignment to the list. <i>Green light on = line is assigned to the list</i> <i>Green light off = line is not assigned to the list</i></li> <li>4 Touch <b>Administer</b>. <i>The console beeps twice.</i></li> <li>5 Leave administration mode.</li> </ol>
Enable or disable the voice message for all lines in your <b>CF and/or DXD incoming line groups</b> .	<ol style="list-style-type: none"> <li>1 Enter administration mode.</li> <li>2 Dial *30.</li> <li>3 Dial the appropriate code: 1 to turn on the Call Forwarding voice message 0 to turn off the voice message</li> <li>4 Touch <b>Administer</b>. <i>The console beeps twice.</i></li> <li>5 Leave administration mode.</li> </ol>
Modify the voice message for one or more lines in your <b>CF, RLA, SA and/or DXD incoming line groups</b> .	<ol style="list-style-type: none"> <li>1 Enter administration mode.</li> <li>2 Dial *50.</li> <li>3 Touch the line button(s) for the line(s) on which you want to modify the message.</li> <li>4 Dial the telephone number you want to include in the message.</li> <li>5 Touch <b>Administer</b>. <i>The console beeps twice.</i></li> <li>6 Leave administration mode.</li> </ol>

(continued)

Administration Procedure	Do This
Change the password for the <b>CF</b> or <b>RLA</b> feature.	<ol style="list-style-type: none"> <li>1 Enter administration mode.</li> <li>2 Dial *56.</li> <li>3 Dial an intercom number plus three digits. <b>NOTE:</b> To invalidate any password, dial the intercom number and 000.</li> <li>4 Touch <b>Administer</b>. <i>The console beeps twice.</i></li> <li>5 Leave administration mode.</li> </ol>
Designate the number of rings before a call will be answered by ASA features.	<ol style="list-style-type: none"> <li>1 Enter administration mode.</li> <li>2 Dial *76.</li> <li>3 Dial the number that corresponds to the ASA feature you've selected: 1 = DXD 2 = CF 3 = RLA 4 = SA</li> <li>4 Dial 0-9 (for the number of rings).</li> <li>5 Touch <b>Administer</b>. <i>The console beeps twice.</i></li> <li>6 Leave administration mode.</li> </ol>
Modify the voice message for one or more lines in your CF, RLA, SA or DXD incoming line groups.	<ol style="list-style-type: none"> <li>1 Enter administration mode.</li> <li>2 Dial *50.</li> <li>3 Touch the line button(s) for the line(s) on which you want to modify the message.</li> <li>4 Dial the telephone number you want to include in the message.</li> <li>5 Touch <b>Administer</b>. <i>The console beeps twice.</i></li> <li>6 Leave administration mode.</li> </ol>
Enter or change the telephone number to which you want calls forwarded.	<ol style="list-style-type: none"> <li>1 Enter administration mode.</li> <li>2 Dial *53.</li> <li>3 Dial the new CF destination telephone number.</li> <li>4 Touch <b>Administer</b>. <i>The console beeps twice.</i></li> <li>5 Leave administration mode.</li> </ol>
Set the Call Forwarding/Remote Line Access Disconnect Timer interval for systems where no forward disconnect signal is provided by the Central office.	<ol style="list-style-type: none"> <li>1 Enter administration mode.</li> <li>2 Dial *68.</li> <li>3 Dial the desired value (must be 3 digits).</li> <li>4 Touch <b>Administer</b>. <i>The console beeps twice.</i></li> <li>5 Leave administration mode.</li> </ol>

(continued)

Administration Procedure	Do This
<b>Reset the system.</b>	<p><b>WARNING:</b> This procedure erases all system administration and telephone programming, returns the system to its factory settings, and restores initial feature assignments to the phones. Use this feature <i>only</i> when you want to change the system radically.</p> <ol style="list-style-type: none"> <li>1 Enter administration mode.</li> <li>2 Dial *99198. <i>The console beeps twice.</i></li> <li>3 Turn the power off, wait 10 seconds, and then turn it on again.</li> <li>4 Leave administration mode.</li> </ol>
Select a <b>message</b> to be played with <b>System Answer</b> .	<ol style="list-style-type: none"> <li>1 Enter administration mode.</li> <li>2 Dial *77 followed by the desired option: <ul style="list-style-type: none"> <li>0 = no voice message</li> <li>1 = "Please hold"</li> <li>2 = "Please hold, your call will be handled momentarily"</li> </ul> <p><b>NOTE:</b> If a line number is administered using *50, the following message is appended to the end of message 1 and 2: "You have reached . . ." where . . . is a number entered by the system administrator for Call Forwarding.</p> </li> <li>3 Touch <b>Administer</b>. <i>The console beeps twice.</i></li> <li>4 Leave administration mode.</li> </ol>
Select <b>number of rings</b> before a call is picked up by an ASA feature.	<ol style="list-style-type: none"> <li>1 Slide the T/P switch to <i>P</i> and touch <b>Administer</b>.</li> <li>2 Dial *76 plus the ASA feature number: <ul style="list-style-type: none"> <li>1 = DXD</li> <li>2 = CF</li> <li>3 = RLA</li> <li>4 = SA</li> </ul> </li> <li>3 Dial the number of rings (between 0 and 9) before the ASA feature picks up the call. <p><b>NOTE:</b> If the number of rings is set to 0, the voice terminal will not ring and the calls will be immediately answered.</p> </li> <li>4 Touch <b>Administer</b>. <i>The console beeps twice.</i></li> <li>5 Leave administration mode by sliding the T/P switch to the center position.</li> </ol>
Assign a <b>template</b> to a <b>voice terminal</b> .	<ol style="list-style-type: none"> <li>1 Enter administration mode.</li> <li>2 Dial* 10 followed by the desired template: <ul style="list-style-type: none"> <li>1 = Clear template</li> <li>2 = Dialer template</li> <li>3 = Feature template</li> <li>4 = Receptionist/Secretary template</li> </ul> </li> <li>3 Touch the Auto Intercom button or dial the intercom number for the voice terminal being assigned the template.</li> <li>4 Touch <b>Administer</b>. <i>The console beeps twice.</i></li> <li>5 Leave administration mode.</li> </ol>

# Quick Reference Guide to Administration Codes

Administration Code	Other Numbers/Buttons	Feature
*01 through *08	00 01 through 10 plus up to eight telephone number digits	Add (or remove) an Allowed List (1 through 8) to a voice terminal Add telephone numbers to an Allowed List (1 through 8)
*09	00 01 through 10 plus up to 20 telephone number digits	Add (or remove) a Disallowed List to a voice terminal Add telephone numbers to a Disallowed List
*2	0 through 9 (rings)	Set the Transfer Return Interval for 0 through 9 rings.
*4	0 through 8 (lines)	Assign the number of lines in the system
*10	plus template option 1 = Clear 2 = Dialer 3 = Feature 4 = Receptionist/Secretary and intercom number	Assign a template to a voice terminal
*11	the line button(s) for the line(s) on which you want to reinstate restriction	Reinstate restriction
*12		Turn off Music-on-Hold
*13		Set Music-on-Hold to low volume
*14		Set Music-on-Hold to medium volume (the default setting)
*15		Set Music-on-Hold to high volume
*16		Turn off background music
*17		Set background music to low volume
*18		Set background music to medium volume (the default setting)
*19		Set background music to high volume
*30	1 = to turn on the Call Forwarding voice message 0 = to turn off the Call Forwarding voice message	Enable or disable the voice message on one or more lines in your CF and/or DXD incoming line groups
*31		Set a line for immediate ring on a voice terminal with Button-Free Line Operation
*32		Set a line for no ring on a voice terminal with Button-Free Line Operation
*34		Reassign lines to a voice terminal that has Button-Free Line Operation
*35	jack number assigned to BB	Set the control unit jack for the Busy Buster feature

(continued)



Administration Code	Other Numbers/Buttons	Feature
*36		Set the system for toll prefix, a 0 or a 1
*37		Set the system for area code only
*38		Set the system for Touch-Tone dialing
*39		Set the system for rotary dialing
*50	the line button(s) for the line(s) on which you want the modified message the telephone number you want to include in the message	Modify the Call Forwarding, Direct Extension Dialing, Remote Line Access, or System Answer voice messages for one or more lines in your CF, DXD, RLA, or SA incoming line groups
*51	the line buttons of the lines you want to add to or remove from the group	Select lines that will be included in the Call Forwarding <i>incoming</i> line group
*52	the line buttons of the lines you want to add to or remove from the group	Choose lines that will compose the Call Forwarding <i>outgoing</i> line group
*53	the new Call Forwarding destination telephone number	Enter or change the telephone number to which you want calls forwarded
*54	the line buttons of the lines you want to add to or remove from the group	Select lines that will be included in the Remote Line Access <i>incoming</i> line group
*56	the ASA password (a MERLIN Plus system intercom number plus any three digits)	Choose at least one valid 5-digit password so that you can gain access to an outside line using Remote Line Access or change the current call forward number from a remote location
*57	line A or E only	Assign Privacy to Line A or E
*58	the line buttons of the lines you want to add to or remove from the group	Select lines that will compose the Direct Extension Dialing <i>incoming</i> line group
*59	the intercom number for the jack you want to assign to ASA	Change the jack assignment of the ASA features from jack 18, the initial assignment
*60		Print a System Feature Report for the system and for every voice terminal in the system
*61		Print a System Feature Report for the whole system
*62	an intercom number of the voice terminal	Print a System Feature Report for an individual voice terminal
*63		Cancel a System Feature Report in progress and all report requests
*68	three-digit timer interval	Set the CF/RLA Disconnect Timer interval (if no forward disconnect is provided by the Central Office)
*69	the outside line buttons	Set Hold Disconnect Interval

(continued)

Administration Code	Other Numbers/Buttons	Feature
*71	the intercom numbers	Assign voice terminals to Group Page group 1
*72	the intercom numbers	Assign voice terminals to Group Page group 2
*75	the outside line buttons	Assign lines that can be answered by System Answer
*76	ASA feature number (1-4) and number of rings (0-9)	Set number of rings before an ASA feature picks up a call
*77	plus message option 0 = no message 1 = "Please hold" 2 = "Please hold. Your call will be answered momentarily"  <b>NOTE:</b> You can also append message 1 or 2 to the call forwarding message modified with the *50 code.	Choose a message to be played with System Answer.
*79	an intercom number of the voice terminal	Assign an alternate attendant position
*80	a 2-digit month, a 2-digit day of the month, and a 2-digit year	Set the date for the Call Report and System Feature Report feature
*81	a 2-digit hour, a 2-digit minute of the hour	Set the time for the Call Report and System Feature Report feature
*82	an intercom number	Set the control unit jack for the Call Report feature
*83	0 through 9 (minutes)	Set the minimum call duration for the Call Report feature
*84	0 = no calls reported 1 = only outgoing calls reported 2 = outgoing and incoming calls reported	Set the type of calls that are printed on the call report
*85	an intercom number	Set the control unit jack for the System Feature Report
*88	an account number	Assign System Speed Dial codes to account numbers for the Account Number Entry feature
*89	the intercom number	Enable or disable a person from changing programmed features at his or her voice terminal
*90	system speed dial code and telephone number digits  a * plus the telephone number digits	Assign System Speed Dial codes to outside telephone numbers  Assign System Speed Dial codes to outside telephone numbers that are private (only the dial code is printed on the call report)

(continued)

Administration Code	Other Numbers/Buttons	Feature
*92	system speed dial code and telephone number digits a * plus the telephone number digits	Assign System Speed Dial codes with Restriction Override to outside telephone numbers Assign System Speed Dial codes with Restriction Override to outside telephone numbers that are private (only the dial code is printed on the call report)
*99198		Reset the system (for service personnel only)

# Section 4: Using The Attendant Console

---

As your company's system attendant, you will probably answer most calls that come into the business and transfer many of those calls to other people in the office. This section includes descriptions, instructions, and suggestions that will help you transfer calls and use Auto Intercom buttons and Group Page features, the Send Message feature, and the headset. For more information about any of the MERLIN Plus Communications System features discussed here, refer to Section 5, "Reference."

## THE ATTENDANT CONSOLE

The main attendant console, plugged into jack 10 on the control unit, also serves as the administration console. All of the company's lines appear on separate buttons on this console. It is important, especially if you answer most of the incoming calls, that as the attendant, you have an Auto Intercom button with lights for each voice terminal in the system. Therefore, most attendants use a BIS-34 or BIS-34D model voice terminal that has enough buttons for lines and Auto Intercom buttons. When you plug in your BIS-34 or BIS-34D model voice terminal into intercom jack 10 on the control unit, your console automatically has a button for every line and an Auto Intercom button for every voice terminal in the system.

If you are using a BIS-22 or BIS-22D voice terminal as an administrator/attendant console, all the lines to which your system has access will appear on separate buttons on your voice terminal, but you may not have an Auto Intercom button for each person's voice terminal in your system. Therefore, when you want to place an intercom call or transfer a call, you may need to dial the person's intercom number rather than use an Auto Intercom button.

**NOTE:** Since the BIS-10 voice terminal does not have separate buttons for outside and Auto Intercom lines, its use as an attendant console is severely limited and so not recommended for that use.

Since the BIS-22 or BIS-22D voice terminal may not have Auto Intercom buttons for every voice terminal in your MERLIN Plus system, you may need to use the special procedure described in "Using the Send Message Feature" in this section to turn on the Message light at the voice terminal of the person who has a message waiting.

Figures 4-1 and 4-2 on the following pages are illustrations of the BIS-34D and BIS-22 voice terminals respectively. Look at the picture of the type of voice terminal that you are using and check the location of the buttons and the dial pad.

If you need to check the initial button assignments for any voice terminal with 34 buttons to be used as an administrator/attendant console in regular call-handling mode, see Section 3, "Administering the System."

FIGURE 4-1 The BIS-34D with display as attendant console.

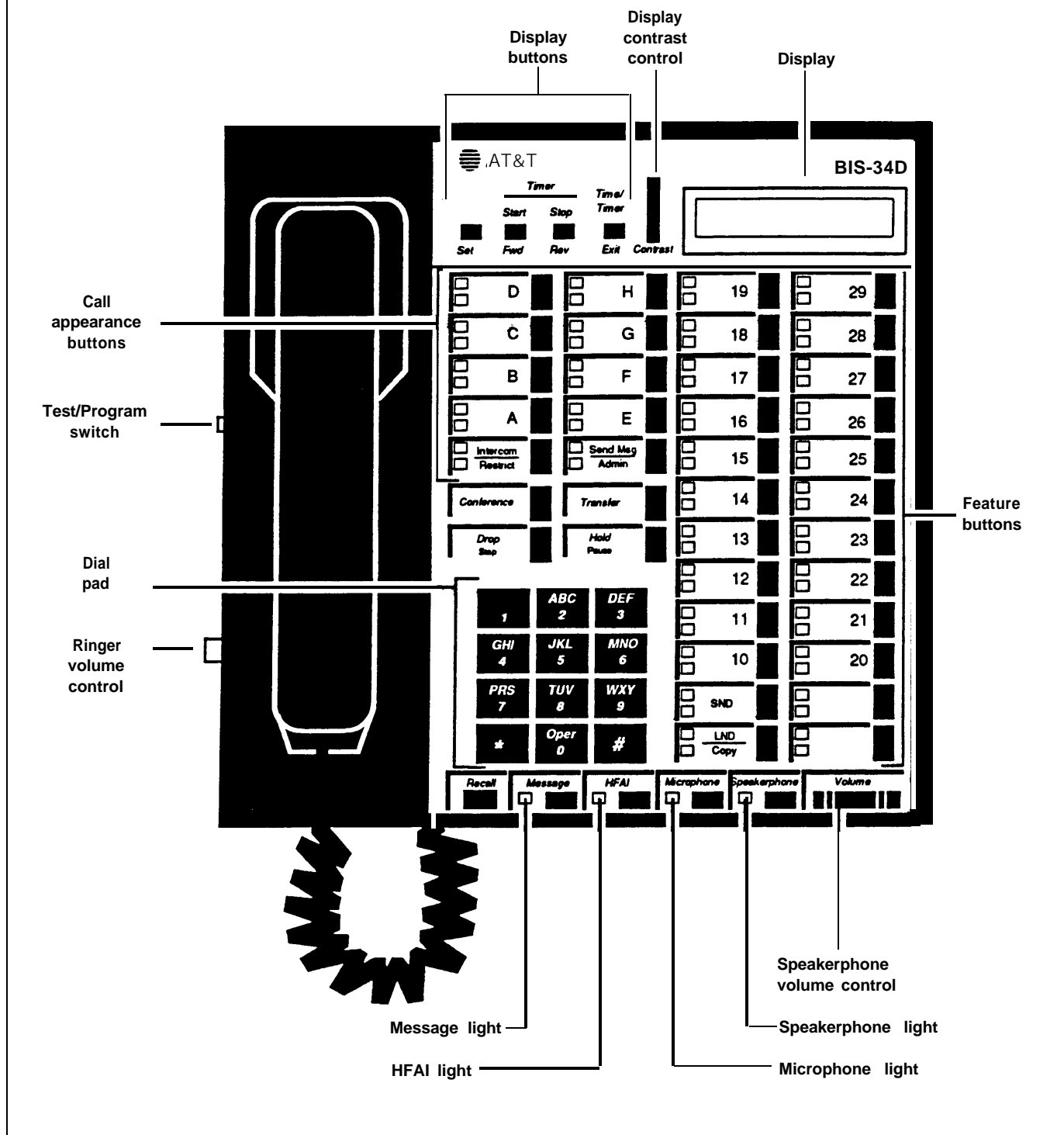
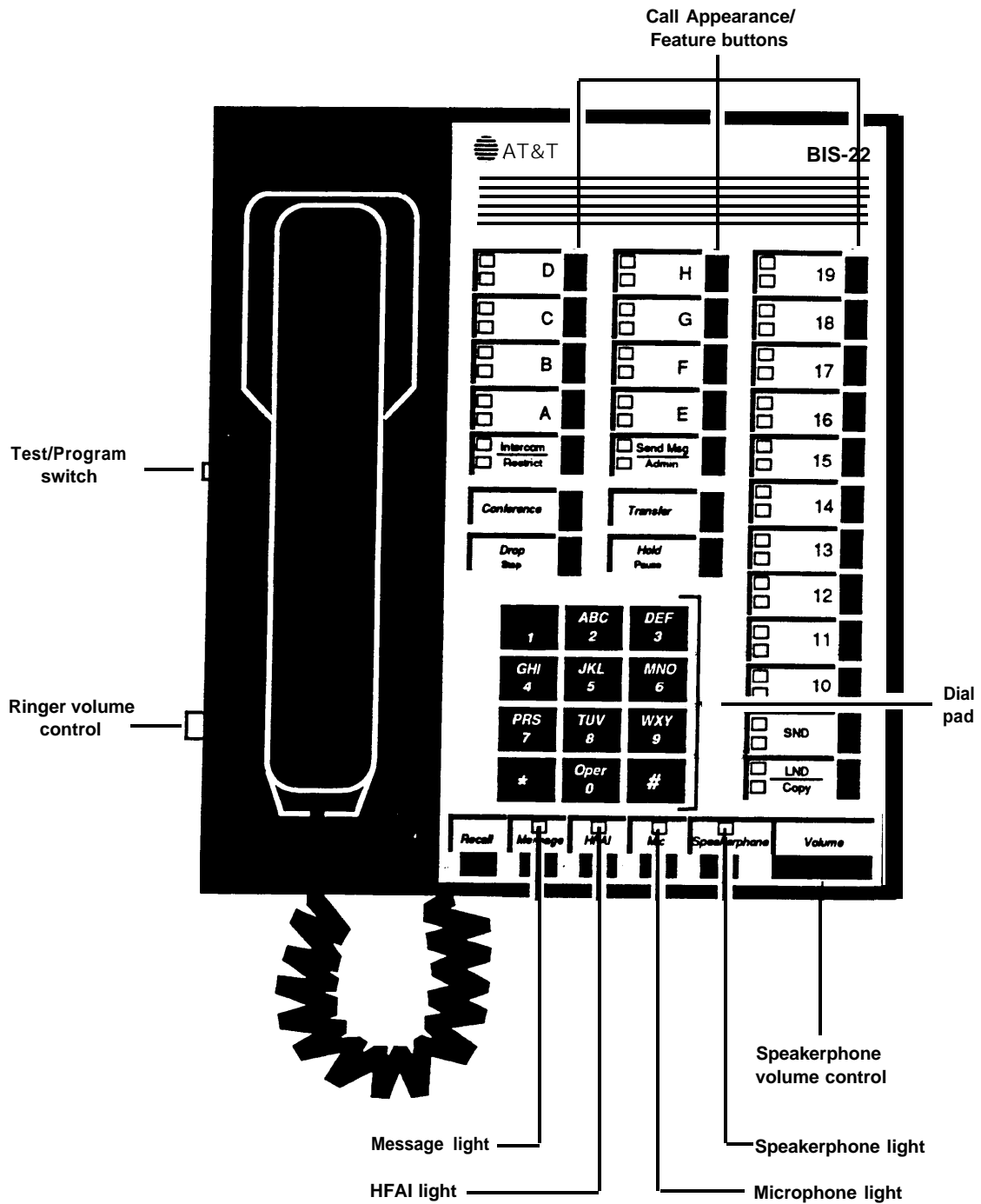

FIGURE 4-2 The BIS-22 voice terminal as attendant console.



# Handling Calls

---

As the system attendant, you will be answering most of the incoming calls. To handle the calls efficiently, you will find it helpful to know about the following features and procedures:

- Transferring calls
- Using the Auto Intercom buttons for people in your system
- Paging through the voice terminal speakers
- Using the Send Message feature
- Changing the ringing options of the outside lines on your console or helping others to change the ringing options for the lines on their voice terminals
- Using Night Service when you are off duty
- Activating System Answer when you are away from the Console for a short period of time or busy on other calls
- Using an alternate attendant position to handle returning ASA calls
- Using the headset

## TRANSFERRING CALLS

Since an important part of your job may be to screen calls and then transfer them to the appropriate people, you should be familiar with the following ways to transfer calls.

### • Transferring Calls by Dialing the Intercom Number

To transfer a call to someone by dialing his or her intercom number:

- 1 Touch **Transfer**.
- 2 Dial the person's intercom number.
- 3 Hang up.

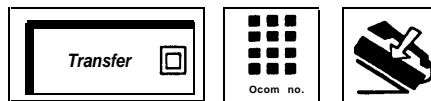

### • Transferring Calls with One-Touch Transfer

To transfer a call to someone using One-Touch Transfer:

- 1 With the call in progress, touch the Auto Intercom button of the person to whom you want to transfer the call.
- 2 When you hear a beep, announce the call.
- 3 Hang up.

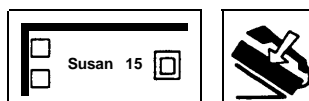

If the person has activated the Voice Announcement Disable feature or if the person is using the intercom line at his or her voice terminal, you cannot announce the call because it will ring automatically.



---

- **Screening Calls**

When you screen a call, you first discuss the call with the person to whom it is to be transferred. There are many reasons for consulting about the call. For example, a person may want to obtain a file before taking the call, may be busy and not want to answer the call at the moment, or may want the attendant to answer the call and take a message.

To screen a call:

- 1 Touch **Hold**.
- 2 Touch **Intercom** and dial the intercom number of the person to whom the call may be transferred.

*or*

Touch the person's Auto Intercom button.

- 3 Announce the call and ask if it will be accepted.

**NOTE:** If the person has activated the Voice Announcement Disable feature or if the person is using the intercom line at his or her voice terminal, you cannot announce the call because it will ring automatically.

If the person chooses not to accept the call:

- a Touch the held call's line button.
- b Advise the caller.
- c Hang up.

If the person chooses to accept the call:

- a Advise the person to touch the appropriate line button.
- b Hang up.

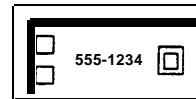
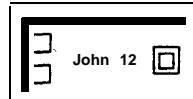
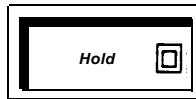

## USING AUTO INTERCOM BUTTONS

Auto Intercom buttons on your attendant console allow you to handle calls efficiently in several ways:

- Auto Intercom buttons allow you to quickly and easily transfer calls.
- The lights next to Auto Intercom buttons indicate when others in your office are using their voice terminals. If the green light is on next to an Auto Intercom button, it means the person at that intercom number is using the voice terminal or has activated the Do Not Disturb feature.
- If the green light next to the person's Auto Intercom button is flashing, it means that the person is calling you.

Be sure to type or write the names of the people in your office on the appropriate Auto Intercom buttons.

To call someone in your MERLIN Plus system with one touch:

- 1 Touch the Auto Intercom button for the person you want to call.
- 2 When you hear the person answer, begin speaking into your speakerphone or lift the handset and begin speaking.

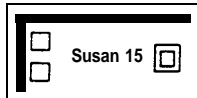

## USING GROUP PAGE FEATURES

The Group Page feature allows you to make announcements to groups of people or to page individuals for calls. When a call comes in, you can put the call on hold and page the person for whom the call is intended. To use a programmed button to make an announcement through a group of voice terminal speakers:

- 1 Touch the Group Page button for the group you want to page.
- 2 When you hear a beep, touch **Speakerphone** or lift your handset and make the announcement.

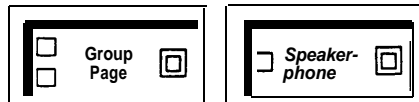

To page a group using a dial code:

- 1 Touch **Intercom**.
- 2 Touch **Speakerphone** or lift your handset.
- 3 Dial a code for the group you want to page.
  - 70 = Page-All (all voice terminals in the system)
  - 71 = group 1
  - 72 = group 2
- 4 When you hear a beep, begin speaking.

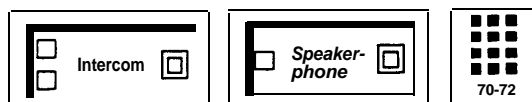

**USING THE SEND MESSAGE FEATURE**

When someone in the MERLIN PIUS system has a message, you can turn on the Message light at the person’s voice terminal to indicate that there is a message waiting.

1 Touch **Send Message**.

2 Touch an Auto Intercom button, if you have one for the person.

*or*

Dial the 3-character dial code opposite the person’s intercom number as found on the following table.

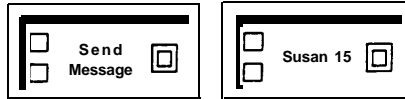

If the intercom number is:	Dial this code:	If the intercom number is:	Dial this code:
Intercom 10	#22	Intercom 20	#03
Intercom 11	#21	Intercom 21	#04
Intercom 12	#20	Intercom 22	#05
Intercom 13	#19	Intercom 23	#06
Intercom 14	#18	Intercom 24	#07
Intercom 15	#17	Intercom 25	#08
Intercom 16	#16	Intercom 26	#09
Intercom 17	#15	Intercom 27	#10
Intercom 18	#14	Intercom 28	#11
Intercom 19	#13	Intercom 29	#12

For example, if you want to turn on the Message light at Intercom 24, but do not have an Auto Intercom button for that person, look for Intercom 24 on the table above. Opposite Intercom 24 you will find the Send Message dial code, #07. Then you would touch **Send Message** and dial #07 to send the message.

To turn off the message light, repeat the steps.



---

## SELECTING RINGING OPTIONS

You can program any outside line at your console to ring immediately, to ring after a delay, or not ring at all. You will probably want most lines at your console to ring immediately (the factory-set condition), but if you answer calls on a certain line only when someone else doesn't answer them, program that line for delayed ringing. You may want to program the lines at other people's voice terminals for no ring so that they are not interrupted while they work.

If you want someone in the office to answer calls when you are busy or not at your desk, program the lines at that person's voice terminal for delayed ring. The backup person may also want to program a Ring Override button for his or her voice terminal. When the backup person must answer calls that would ordinarily ring at your console, he or she can touch the Ring Override button and have all calls ring immediately at his or her voice terminal.

## USING NIGHT SERVICE

During the night or on weekends when you are off duty, you can still make it convenient for someone else, such as a guard, to answer calls. You do so with the Night Service feature. There are three ways to provide Night Service for your office:

- You can provide the person with a voice terminal that has all the lines, or the person can monitor the attendant console and answer calls there. Be sure that all lines on which calls can come in after hours are set for immediate ring. If the lines are not normally set for this ringing option, the person can activate a Ring Override button that he or she has programmed for the voice terminal. (See "Ring Override" in Section 5, "Reference.")
- The backup person can also answer calls that come in after hours by programming a Call Pickup button so that he or she can pickup calls that come in at the administrator/attendant console. Since the attendant console has all the lines of your MERLIN Plus system, the person answering calls after hours can pick up calls by touching the Call Pickup button whenever the attendant console rings. (See "Call Pickup" in Section 5, "Reference.") If the person is in another part of the building, the attendant can connect his or her console and an extra alert device to a Supplementary Alert Adapter (See "Supplementary Alert Adapter" under "Accessory Equipment" in Section 5, "Reference.") so that each time a call comes in, an extra alert device goes on.
- Your system administrator can also administer and activate the Call Forwarding feature for after-hours use. When the system is in Call Forwarding mode, incoming calls on designated lines are connected to a Voice Synthesis Processor (VSP) in the control unit for a message that informs the caller that the call will be forwarded. While the caller is listening to the message, the control unit calls the telephone number to which calls are being forwarded and uses the system's Conference feature to connect the incoming call to the outgoing call. For more information about this feature, refer to "Automatic System Access" in Section 5, "Reference."

---

## ACTIVATING SYSTEM ANSWER

You can activate the System Answer feature with a System Answer button so that when selected calls come in, the system automatically answers them, then plays a pre-recorded message before placing them on hold. This feature can only be activated from the attendant console or the alternate attendant console. If your system has an alternate attendant, the System Answer feature must be administered to that voice terminal.

To activate the System Answer feature:

- 1 Touch **System Answer**.

*The green light goes on.*

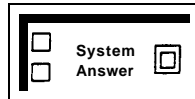

## USING AN ALTERNATE ATTENDANT CONSOLE

When Automatic System Answer (ASA) calls are not answered, they normally return to the main attendant console. However, you may prefer to assign an alternate attendant position to handle just ASA calls; all other calls are directed to the main attendant console. The alternate attendant position is assigned by the system administrator.

If you are assigned the alternate attendant console, you can do anything the main attendant can do, except you cannot turn on message lights at voice terminals nor perform administration procedures from that console. The only calls handled by the alternate attendant are returned ASA calls. For example, if a Direct Extension Dialing (DXD) call is unanswered or busy, the call will be transferred to the alternate attendant console, if one has been assigned.

## USING THE HEADSET

If you have a heavy call-handling load, you may want to use a headset and headset adapter. (For more information about the headset and the headset adapter that connects the headset to the voice terminal, see Section 5, “Reference.”)

To place a call using your headset:

- 1 Touch **On/Quiet** on the headset adapter.

*The green light next to the button goes on.*

- 2 Dial the outside number.

To answer a call:

- 1 Touch **On/Quiet** on the headset adapter.

To mute the microphone:

- 1 Hold down **On/Quiet** on the headset adapter.

To hang up:

- 1 Touch **Off** on the headset adapter.

*The green light next to **On/Quiet** goes off.*

---

**SPEAKERPHONE  
PERFORMANCE TIPS**

For optimal use of the speakerphone on the BIS, HFAI, or SP voice terminals, follow these guidelines:

- Place the voice terminal in an area with low background noise.  
Room acoustics and background noise may affect the proper operation of your voice terminal's speakerphone. High background noise is caused by loud voices and loud electronic devices (radios, typewriters, office equipment, etc.).
- Keep the area under and next to the microphone free of books and papers.
- Let one person talk at a time. When both parties speak at the same time, transmission can be broken.
- Always face your terminal when talking.
- Place your voice terminal at least six inches away from the edge of the desk or table upon which it rests.

## Section 5: Reference

---

# MERLIN Plus System Features

---

Your MERLIN Plus system offers features that provide effective telephone service both on a business-wide and personal basis. In order to meet company priorities and needs, the system administrator can assign lines and add features that will benefit the whole system. The voice terminals (telephones) in the MERLIN Plus system come ready to use with many preassigned features, such as Transfer and Hold. However, people in your system can also add features to their individual voice terminals, such as Privacy or Saved Number Dial, that will help them handle calls easily and efficiently.

The information included in each feature description in “MERLIN Plus System Features” is divided into five headings:

- **Description**

The description of the feature tells what it does and its advantages for those people using it.

- **Considerations**

Special considerations include any qualifications the person using the feature should know about. It also includes ways in which the feature can or cannot be used, or other features it can be or cannot be used with.

- **Administration**

Administration procedures tell the system administrator how to administer the features using the administrator/attendant console. For complete information on system administration, refer to Section 3, “Administering the System.”

- **Programming**

The term “Programming” refers to customizing a voice terminal to suit the needs of the person who will be using it. Brief programming instructions and programming codes are included for each programmable feature. Directions for programming features onto available programmable buttons on a voice terminal also appear in the *MERLIN Plus System User’s Guide*.

- **How to Use**

Procedures for using each feature are divided into specific steps so that a person can easily and efficiently use his or her voice terminal.



---

## Abbreviated Ringing

<b>DESCRIPTION</b>	<p>When another line rings while you are busy on a call, your voice terminal rings only once. In this way you are aware that you have another call, but it does not interrupt the call in progress.</p> <p>After the ringing cycle stops, the green light continues to flash to remind you of the other call.</p>
<b>CONSIDERATIONS</b>	None
<b>ADMINISTRATION</b>	None
<b>PROGRAMMING</b>	None
<b>HOW TO USE</b>	<p>If you want to pick up the new call, you can place the call in progress on hold or Exclusive Hold and touch the line button of the new call. You don't need to hang up first.</p>

---

## Account Number Entry

### DESCRIPTION

You can use account numbers to identify the department, project, or client to whom the call should be charged. If your system uses the Call Report feature (often referred to as Station Message Detail Recording [SMDR]), you can include these account numbers in the Call Reports. (See “Call Report.”)

There are two methods you can use to enter account numbers on a printed Call Report: a quick method and a general method. Most businesses will be satisfied with the quick method of entering account numbers on a Call Report. The general method is recommended for businesses that have many accounts, or in which there is no central accounting organization and users must invent their own codes.

- **Option A—The General Method:** The general method of entering an account number on a Call Report is to use a programmed Account Number Entry button. While you have a call in progress, you simply touch the Account Number Entry button (a light goes on beside the button so that you know the account number will be entered) and dial all the digits of the account number. You can also program buttons or speed dial codes for frequently used account numbers. If necessary, you can dial extra numbers for subaccounts.
- **Option B—The Quick Method:** The quick method of entering an account number on a Call Report is to dial a System Speed Dial code (60 through 89 or 900 through 999) that the system administrator has stored in the system (see “System Speed Dial”) or a 3-character Personal Speed Dial code that you have assigned to an account number (see “Personal Speed Dial”). While you have a call in progress, you simply dial the speed dial code that corresponds with the account code. You can dial the code with one touch by programming a System Speed Dial or Personal Speed Dial button.

### CONSIDERATIONS

This feature can be used only with outside calls; it cannot be used with intercom calls.

If the system administrator has specified that the Call Report feature does not report incoming calls, account codes can be entered only for outgoing calls.

There is a maximum of 16 characters available for an Account Number Entry. The system beeps twice if the administrator attempts to enter more than 16 characters. If the administrator dials fewer than 16 characters, the system does not beep.

The system administrator should give a copy of the System Speed Dial code assignments to each person in the system who will use those codes.

---

## ADMINISTRATION

If your responsibilities do not include system administration, skip this information.

Before you assign a System Speed Dial code (#60 through #89 or #900 through #999) to a specific account number, refer to the System Speed Dial Form that you have filled out.

To administer Account Number Entry codes:

- 1 Enter administration mode by sliding the T/P switch to *P* and touching **Administer**.
- 2 Dial the System Speed Dial code (#60 to #89 or #900 through #999) that you are assigning to the account number. Make certain that you have not already assigned a telephone number to that speed dial code, unless you are making a change.
- 3 Dial \*88.
- 4 Dial the account number.

You can also use a client's telephone number as an account number. For that purpose dial \*88 and then dial the telephone number.

- 5 Touch **Administer**.  
*The console beeps twice.*
- 6 Repeat steps 2 through 5 for each account number or telephone number to which you are assigning a System Speed Dial code.
- 7 Leave administration mode by sliding the T/P switch to the center position.

## PROGRAMMING

To program a general Account Number Entry button (program this feature on a button with lights):

- 1 Label the button **Account Number Entry**.
- 2 Slide the T/P switch to *P*.  
*The voice terminal rings every 5 seconds to remind you that you are programming and that you cannot place or receive calls.*
- 3 Touch the button you want to program.
- 4 Dial \*82.
- 5 Slide the T/P switch to the center position.

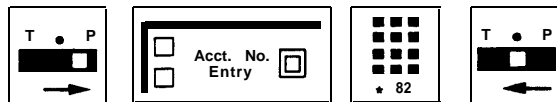

To program a button for a specific account number or System Speed Dial code assigned to an account number:

- 1 Label the button **Account Number** plus the name of a client or project.
- 2 Slide the T/P switch to *P*.  
*The voice terminal rings every 5 seconds to remind you that you are programming and that you cannot place or receive calls.*
- 3 Touch the button you want to program.

- 4 Dial \*88 plus the account number.

*or*

Dial \*95 plus the System Speed Dial code (60 through 89 and 900 through 999) from a list that your administrator can give you.

- 5 Slide the T/P switch to the center position.

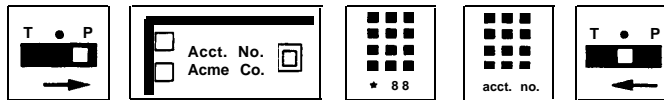

## HOW TO USE

To use a general Account Number Entry button:

- 1 While you have a call in progress, touch **Account Number Entry**.

*The green light next to the button goes on.*

- 2 Dial the account number of the account to be charged for the call.

*or*

Dial a System Speed Dial code (#60 through #89 or #900 through #999) for the account number to which you want to charge the call.

- 3 Touch **Account Number Entry** again.

*The green light goes off.*



If you enter the account code incorrectly, keep the call in progress and follow this procedure:

- 1 Touch **Account Number Entry** twice.

*The green light goes off and back on again.*

- 2 Dial \*.

- 3 Dial the account number correctly.

- 4 Touch **Account Number Entry** again.

*The green light goes off.*

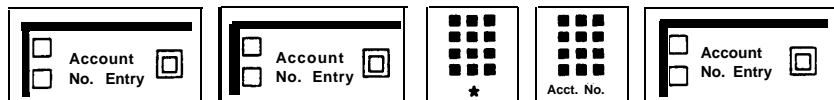

To use a button for a specific account number:

- 1 While you have a call in progress, touch the programmed Account Number button for the particular account number to be recorded.

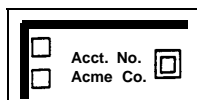

---

## Allowed Lists

### DESCRIPTION

When the system is installed, people can use their voice terminals to place intercom, local, and toll calls. However, the system administrator can restrict any voice terminal to intercom or local calls. (See “Call Restriction.”) If restricted voice terminals require additional calling access, the administrator can designate a list of numbers (an Allowed List) that people may call despite the established restrictions.

### CONSIDERATIONS

Allowed Lists help you control the cost of your monthly phone bill, but still allow you to place all the business calls you need from any voice terminal in your system.

The administrator may decide to stem one or more System Speed Dial codes with Restriction Override. All voice terminals in the system can use those codes as a type of password that allows the person to dial certain outside numbers. Those numbers may be called regardless of toll or outward call restrictions previously placed on a voice terminal. (See “System Speed Dial.”)

The system administrator can establish eight Allowed Lists for the system. They are numbered 01 through 08 and each can have a maximum of 10 entries, numbered 01 through 10. Each entry may consist of a toll prefix, if necessary (1 or 0), an area code (for example, 201), and/or an exchange code (for example, 834), and/or emergency numbers (for example, 911). When the administrator has dialed the maximum eight digits for an Allowed List entry, the system beeps twice to remind the administrator that he or she cannot dial any more digits. If the administrator dials fewer than eight digits, the system does not beep.

### ADMINISTRATION

If your responsibilities do not include system administration, skip this information.

Before you administer Allowed Lists for your system, refer to the Allowed List Form that you have filled out.

To setup an Allowed List:

- 1 Enter administration mode by sliding the T/P switch to *P* and touching **Administer**.
- 2 Dial a \* and a 2-digit code (01 through 08) that corresponds to the number of the list.  
For example, to add an entry to List 5, dial \*05.
- 3 Dial the 2-digit number of the item in the Allowed List (between 01 and 10).  
For example, to add an entry to List 3 as the first item on the list, dial \*03 01.
- 4 Dial the number, toll-prefix and area code if necessary, or exchange to be added to the list (maximum eight digits).

For example, to add the 201 area code with the toll-prefix, and 834 exchange to List 2 as the seventh item on the list, dial \*02 07 1 201 834.

**5 Touch Administer.**

*The console beeps twice.*

**6 Leave administration mode by sliding the T/P switch to the center position.**

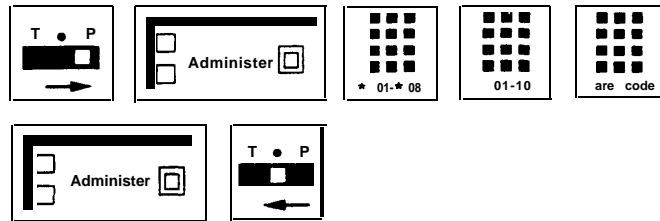

To delete an entry from an Allowed List:

- 1 Enter administration mode by sliding the T/P switch to *P* and touching **Administer**.**
- 2 Dial a \* and a 2-digit code (01 through 08) that corresponds to the number of the list.**
- 3 Dial the 2-digit item number (01 through 10) of the entry you want to delete.**  
For example, to delete the eighth entry of List 1, dial \*01 08.
- 4 Touch **Drop**.**
- 5 Touch **Administer**.**  
*The console beeps twice.*
- 6 Leave administration mode by sliding the T/P switch to the center position.**

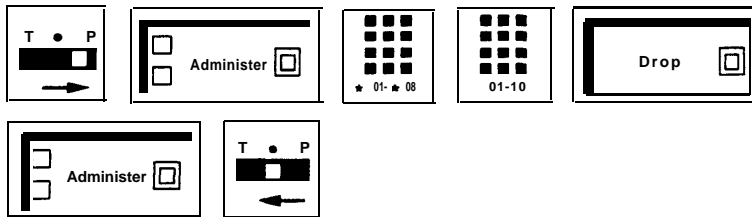

To clear all the entries from an Allowed List:

- 1 Enter administration mode by sliding the T/P switch to *P* and touching **Administer**.**
- 2 Dial a \* and a 2-digit code (01 through 08) that corresponds to the number of the list you want to clear.**  
For example, to clear all entries from List 6, dial \*06.
- 3 Touch **Drop**.**  
*The console beeps twice.*
- 4 Touch **Administer**.**  
*The console beeps twice.*

- 5 Leave administration mode by sliding the T/P switch to the center position.

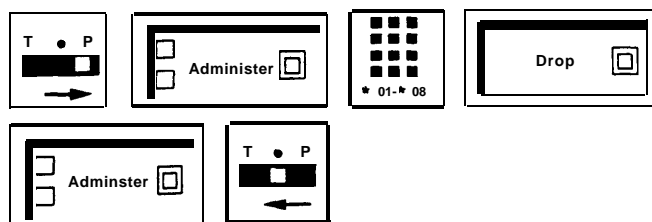

Before you assign Allowed Lists to voice terminals in your system, refer to the Call Restrictions, Allowed and Disallowed Lists Forms that you have filled out. Then use the following procedures to assign or remove voice terminals for access to Allowed Lists:

- 1 Enter administration mode by sliding the T/P switch to *P* and touching **Administer**.
- 2 Dial a \* and a 2-digit code (01 through 08) that corresponds to the list you want to assign to the voice terminal.
- 3 Dial 00.  
*The green light goes on next to the Auto Intercom button for each voice terminal to which this list is already assigned.*  
  
For example, to assign List 2 to a voice terminal, dial \*0200.
- 4 Perform one of the following procedures:
  - > Touch the Auto Intercom button, if you have one, for the voice terminal for which you are giving access or removing access to the Allowed List.  
  
*Green light on = the list is assigned to the voice terminal*  
*Green light off = the list is not assigned to the voice terminal*
  - > If you do not have an Auto Intercom button for the voice terminal that you want to assign the list to or remove the list from, use the code from the dial code chart in Section 3.
- 5 Touch **Administer**.  
*The console beeps twice.*
- 6 Leave administration mode by sliding the T/P switch to the center position.

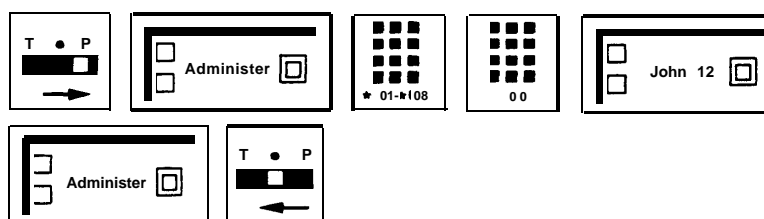

## PROGRAMMING

None

## HOW TO USE

Ask your system administrator what call restrictions, if any, he or she has assigned to your voice terminal.

---

# Alternate Attendant

## DESCRIPTION

You can assign a voice terminal, other than intercom 10, to be used as an Alternate Attendant. When Direct Extension Dialing (DXD) calls are busy or do not answer, they can be directed to the Alternate Attendant position. All other calls are directed to the main attendant position. When an Alternate Attendant position is assigned, System Answer must be activated from there.

## CONSIDERATIONS

The alternate attendant console position can do anything the main attendant position can do, except turn on message lights at voice terminals and perform administration procedures.

The only calls transferred to the alternate attendant console are DXD calls that are busy, dialed incorrectly, or unanswered.

The Alternate Attendant cannot be designated if your system has a MERLIN Attendant.

The System Answer (SA) feature must be off when assigning the alternate attendant position.

## ADMINISTRATION

If your responsibilities do not include system administration, skip this section.

To assign an alternate attendant position:

- 1 Enter administration mode by sliding the T/P switch to *P* and touching **Administer**.
- 2 Dial \*79.
- 3 Touch the Auto Intercom button or dial the intercom number of the voice terminal you want to assign as the alternate attendant console.
- 4 Touch **Administer**.  
*The console beeps twice.*
- 5 Leave administration mode by sliding the T/P to the center position.

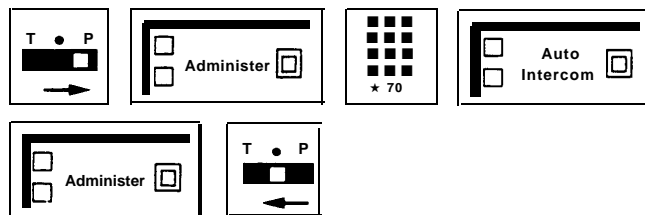



---

## PROGRAMMING

If you will be using the System Answer feature, see “System Answer” later in this section, you must program the SA button. Only the attendant or the alternate attendant can have the SA button.

- 1 Label the button “System Answer.”
- 2 Slide the T/P switch to *P*.  
*The voice terminal rings every 5 seconds to remind you that you are programming and that you cannot place or receive calls.*
- 3 Touch the button you want to program.
- 4 Dial \*58.
- 5 Slide the T/P switch to the center position.

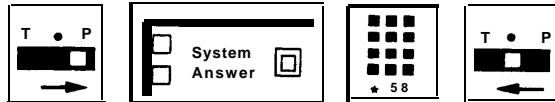

## HOW TO USE

To activate System Answer from the Alternate Attendant position:

- 1 Touch **System Answer**.

*Green light on = SA on*  
*Green light off = SA off*  
*Green light flashing = Problem with SA*

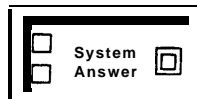

If the green light next to the System Answer button is flashing, notify the system administrator who should refer to Section 7, “Troubleshooting,” to correct the problem.

---

## Auto Answer-All

**NOTE:** This feature requires a General Purpose Adapter and can be used with a modem, an answering machine, a facsimile machine, or a cordless telephone.

### DESCRIPTION

If you want an optional piece of equipment, such as a modem, an answering machine, or a facsimile machine, connected to your voice terminal, to turn on automatically when you receive ringing calls, you need to program an Auto Answer-All button.

### CONSIDERATIONS

You *cannot* have both the Auto Answer-All *and* Auto Answer-Intercom features activated at the same time. If you have a Hands-Free Unit (HFU) and Auto Answer-All is activated, all incoming calls will be answered at once.

This feature only answers ringing incoming calls. It will *not* answer voice announced calls. You should program Voice Announcement Disable on your voice terminal if you want all your incoming calls to ring. (See “Voice Announcement Enable/Disable” later in this section for more information.)

### ADMINISTRATION

None

### PROGRAMMING

Program the Auto Answer-All feature on a button with lights.

To program an Auto Answer-All button for your voice terminal:

**1** Label the button **Auto Answer-All**.

**2** Slide the T/P switch to *P*.

*The voice terminal rings every 5 seconds to remind you that you are programming and that you cannot place or receive calls.*

**3** Touch the button you want to program.

**4** Dial \*75.

**5** Slide the T/P switch to the center position.

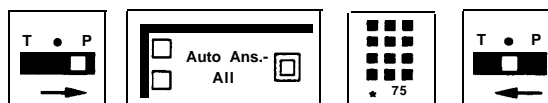

---

## HOW TO USE

To have a modem, answering machine, or facsimile machine answer calls automatically:

**1 Touch **Auto Answer-All**.**

*The green light next to the button goes on.*

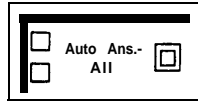

This feature remains active until you:

**1 Touch **Auto Answer-All** again.**

*The green light next to the button goes off.*

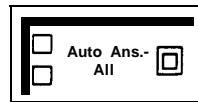

---

## Auto Answer-Intercom

**NOTE:** This feature is used with a Hands-Free Unit.

### DESCRIPTION

If your voice terminal has the Hands-Free-Answer-on-Intercom (HFAI) feature or is connected to a Hands-Free Unit (HFU), you can have your speakerphone go on automatically whenever you receive an intercom call. To do this with an HFU, you must program an Auto Answer-Intercom button.

### CONSIDERATIONS

You can have both Auto Answer-Intercom and Auto Answer-All programmed for your voice terminal, but both features *cannot* be activated at the same time.

### ADMINISTRATION

None

### PROGRAMMING

Program the Auto Answer-Intercom feature on a button with lights.

To program an Auto Answer-Intercom button for your voice terminal:

**1** Label the button **Auto Answer-Intercom**.

**2** Slide the T/P switch to *P*.

*The voice terminal rings every 5 seconds to remind you that you are programming and that you cannot place or receive calls.*

**3** Touch the button you want to program.

**4** Dial \*70.

**5** Slide the T/P switch to the center position.



---

## HOW TO USE

To have your hands-free unit turn on automatically when you receive intercom calls with voice announcement:

**1 Touch HFAI or Auto Answer-Intercom.**

*The green light next to the button goes on.*

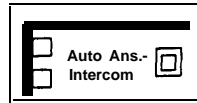

To return to answering calls yourself

**1 Touch HFAI or Auto Answer-Intercom again.**

*The green light next to the button goes off.*

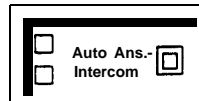

---

# Auto Intercom

## DESCRIPTION

You can use an Auto Intercom button for one-touch dialing of intercom numbers. Program any 2-digit intercom number onto an Auto Intercom button and use the button whenever you want to call the intercom number.

## CONSIDERATIONS

In the MERLIN Plus system, you place an intercom call with a voice announcement. Your co-worker hears your voice through the voice terminal speaker and can respond to you without lifting the handset. If the co-worker does *not* have a BIS model voice terminal or HFAI enabled, he or she cannot respond to you without lifting the handset.

However, if the person you are calling has activated the Voice Announcement Disable feature, your intercom call rings rather than beeps at the person's voice terminal.

You cannot announce an intercom call to a person active on the voice terminal's speaker.

You *cannot* have both an Auto Intercom button *and* a Manual Signaling button for the same person. If you try to program both, you deactivate the one that you programmed earlier. You can use either feature to place an intercom call. (See "Manual Signaling.")

If you program this feature onto a button with lights, the green light next to the button goes on when the person at that intercom number uses the voice terminal or uses the Do Not Disturb feature. When the person calls you, the green light next to the person's Auto Intercom button flashes.

## ADMINISTRATION

None

## PROGRAMMING

A button with lights is recommended but not required for the Auto Intercom feature.

To program an Auto Intercom button for your voice terminal:

1 Label the button with a name and intercom number.

2 Slide the T/P switch to *P*.

*The voice terminal rings every 5 seconds to remind you that you are programming and that you cannot place or receive calls.*

3 Touch the button you want to program.

4 Dial \*91 plus an intercom number.

5 Slide the T/P switch to the center position.

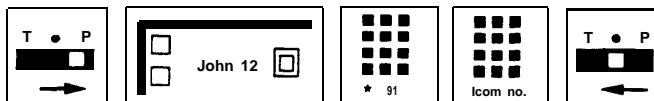

---

## HOW TO USE

To place an intercom call with one touch:

- 1 Touch the Auto Intercom button for the intercom number you want to dial.
- 2 If you hear a short beep, begin speaking or lift your handset. If you hear a long beep, wait for someone to answer on the other end.

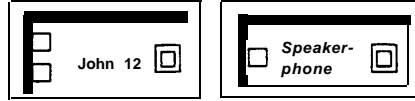

If the line is busy or if no one answers:

- 1 Touch **Speakerphone** to cancel the call.

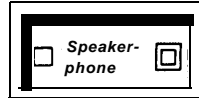

---

## Automatic Call Restriction Reset

**DESCRIPTION** Use Automatic Call Restriction Reset to ensure the integrity of assigned call restrictions.

**CONSIDERATIONS** None.

**ADMINISTRATION** If your responsibilities do not include system administration, skip this section.

- 1 Enter administration mode by sliding the T/P switch to *P* and touching **Administer**.
- 2 Dial \*11 plus the line button you want to reset.

*Green light on = line is restriction reset.*

*Green light off = line is not restriction reset. (System default.)*

- 3 Touch **Administer**.

*The console beeps twice.*

- 4 Leave administration mode by sliding the T/P switch to the center position.

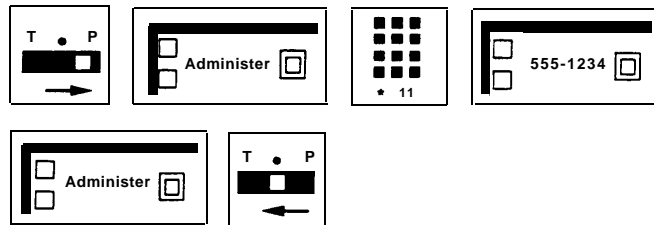

**PROGRAMMING** None

**HOW TO USE** Ask your system administrator what call restrictions, if any, he or she has assigned to your voice terminal.



---

## Automatic Line Selection

### DESCRIPTION

You can program the order in which your system selects outside lines when you touch **Speakerphone** or lift your handset to place a call. For example, you can program the line you use most often to be the first line in the Automatic Line Selection sequence. A line you use less often can be programmed to be the next line the system selects. Then, when you touch **Speakerphone** or lift your handset, the system automatically selects the line you usually use. If that line is busy, the system then selects your second choice, such as a WATS or Readyline, unless that line is busy too, and so on.

You can include all or only some of your outside lines in an Automatic Line Selection sequence.

### CONSIDERATIONS

If you plan to program other features when you program Automatic Line Selection, you must program Automatic Line Selection first. If you are already in the middle of a programming session, slide the T/P switch to the center position and then back to *P* before programming this feature.

The Automatic Line Selection order is only for outside lines; the line selection does not include intercom lines. However, if you remove all outside lines from your Automatic Line Selection sequence, your system will select an intercom line when you touch **Speakerphone** or lift the handset. (See “Intercom Preference.”)

If you don’t program an Automatic Line Selection sequence, you will get outside lines according to the sequence in which they are plugged into the control unit.

### ADMINISTRATION

None

### PROGRAMMING

To program an Automatic Line Selection sequence for your voice terminal:

- 1 Slide the T/P switch to *P*.  
*The voice terminal rings every 5 seconds to remind you that you are programming and that you cannot place or receive calls.*
- 2 Dial \*\*.
- 3 Touch the line buttons in the order you prefer.
- 4 If you want to continue programming other features, dial \*\* again. Otherwise slide the T/P switch to the center position.

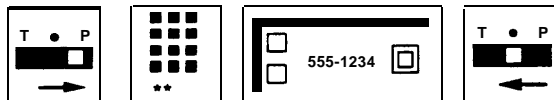

---

## HOW TO USE

When you want to place an outside call:

- 1 Touch **Speakerphone** or lift your handset.

*The MERLIN Plus system connects you to the first available line in the Automatic Line Selection sequence.*

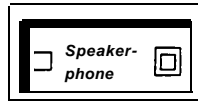

---

## Automatic System Access (ASA)

### DESCRIPTION

Automatic System Access (ASA) includes four features that allow more flexible use of your MERLIN plus system and your outside lines. The features are described in this section under separate entries:

- Call Forwarding (CF)

When the system is in CF mode, incoming calls on designated lines are connected to a Voice Synthesis Processor (VSP) in the control unit for a message. Meanwhile, the control unit calls the telephone number to which calls are being forwarded and uses the system's Conference feature to connect the incoming call to the outgoing call.

- Direct Extension Dialing (DXD)

When you put the system in DXD mode, the control unit connects incoming calls on designated lines to the VSP for a message. Meanwhile, the caller dials the extension number (a 2-digit intercom number), and the control unit transfers the call to that extension.

- System Answer (SA)

When the attendant or the alternate attendant activates the System Answer button, selected incoming calls are answered automatically and placed on hold. The system administrator can choose to have the caller hear a special message before being placed on hold or, if connected to a compatible audio-source, a pre-recorded message or music can be played instead.

- Remote Line Access (RLA)

When the system is in RLA mode, you can call in from outside and use a password to gain access to one of the system's outside lines. You can also use the RLA feature to change the telephone number to which calls are being forwarded during CF operation. The VSP prompts you through the necessary procedures.

### CONSIDERATIONS

If your Central Office (CO) or PBX does not provide a "forward disconnect" on the serving lines, you must use the Call Forwarding/Remote Line Access Disconnect Timer to set a disconnect interval for CF and RLA.

All lines in the system must be assigned to the ASA port.

Refer to the individual features in this section for specific considerations for each feature. ASA features work differently when used in conjunction with the MERLIN Attendant.

---

## ADMINISTRATION

If your responsibilities do not include system administration, skip this information.

### ASA Jack Assignment

The Automatic System Access features require a dedicated jack on the control unit into which you can plug one end of the Auto Access cord. The cord also plugs into the memory module where the Voice Synthesis Processor (VSP) is located. The VSP provides taped messages to callers when ASA features are being used. At startup, jack 18 is automatically assigned to ASA. To change the assignment, use the following procedures:

**NOTE:** You *cannot* assign jack 19, usually assigned to Busy Buster and/or Call Report, unless you have reassigned the jack for these features.

- 1 Enter administration mode by sliding the T/P switch to *P* and touching **Administer**.
- 2 Dial \*59.  
*The green light goes on next to the Auto Intercom button of the jack assigned to ASA.*
- 3 Perform one of the following procedures:
  - > Touch the Auto Intercom button for the jack you want to assign to ASA.  
*The green light goes off next to the button for the old number, and the green light goes on next to the button for the new number. If you hear a denial tone, the feature is on or the VSP port is active. Either wait or turn off the feature.*
  - > Dial the intercom number of the voice terminal you want to assign to ASA.
- 4 Touch **Administer**.  
*The console beeps twice.*
- 5 Leave administration mode by sliding the T/P switch to the center position.

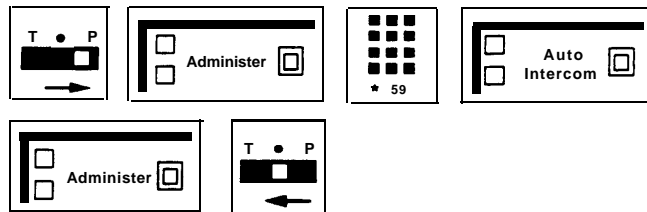

## PROGRAMMING

Refer to the individual features in this section.

## HOW TO USE

Refer to the individual features in this section.

---

## Auxiliary Lines

### DESCRIPTION

The MERLIN Plus system provides an auxiliary jack, labeled “AUX,” at the top of each Line Module. This auxiliary line is bridged directly to outside Line A or Line E, and does not go through the MERLIN Plus system control unit. You can connect accessory devices to the system, and use these devices independently of the system. These devices include:

- **Basic Telephones** —During an electrical power outage, your MERLIN Plus system will not function. However, you can plug a basic telephone (not a MERLIN Plus system voice terminal) into the AUX jack, and use it to place and receive calls on Line A or Line E.
- **Facsimile Machines** —You can also plug a facsimile machine into the AUX jack. When calls come in on Line A or Line E, the FAX machine will respond to them as it would if plugged into any other outside telephone line.
- **Modems and Computers** —You can plug a modem into the AUX line and use it for transmitting and receiving data on Line A or Line E. The modem will function on this line as it would on any other outside telephone line. When using a modem, it is important that you prevent other employees from using voice terminals connected to Line A or Line E since this could interfere with data transmissions. You can program Line A or Line E for privacy (see “Privacy on Lines A and E”), thus preventing others from bridging onto calls on Line A or Line E. To have the modem answer incoming calls automatically, simply set it up for auto-answer as you would on any telephone line. You can place outside calls with the modem either by connecting a basic telephone and dialing manually, or by using the modem’s autodial capabilities.
- **Telecommunication Devices for the Deaf and Dictation Machines** —You can plug these devices into the AUX jack and transmit or receive data on Line A or Line E. The machines will respond as if they were plugged into any other outside telephone line.
- **Answering Machines** —You can plug an answering machine into the AUX jack so that when calls come in on line A or Line E, the answering machine will record messages as it would if plugged into any other outside telephone line.

### CONSIDERATIONS

When a call comes in on Line A or Line E, it will ring both on the voice terminal that is assigned to Line A or Line E and on any device connected to the auxiliary jack bridged to Line A or Line E. If you are using the auxiliary line for a device such as a FAX or modem, you may want to use the No Ring option (see “Ringling Options”) to prevent calls from ringing on a voice terminal connected to Line A or Line E. This will prevent employees from answering calls that should be going to the accessory device connected to the auxiliary line.

If you do not want the accessory device to ring on incoming calls, you can simply turn it off or set it not to ring, and program Line A or Line E for normal ringing.

You *cannot* use a MERLIN Plus system voice terminal on the auxiliary jack.

You *cannot* connect a loudspeaker paging system into the auxiliary jack.

---

The system administrator can administer the privacy feature for Line A and/or Line E so that no one else in the system can bridge onto or monitor these lines while a call is active on them. For more information, see “Privacy (on Lines A and E).”

**ADMINISTRATION**

If you want calls that come in on the line connected to an auxiliary jack to ring at that device but not at any other voice terminal that has the same line assigned to it, program the other voice terminals to not ring on that line. (See “Ringing Options.”)

If you don’t want calls that come in on the line connected to an auxiliary jack to ring at that device, you will have to see if the device has a switch to turn off the ring and set it accordingly.

**PROGRAMMING**

None

**HOW TO USE**

Use the basic telephone, facsimile machine, or modem and computer connected to the auxiliary jack as you normally would.

Plug in the auxiliary telephone whenever you want to bridge or monitor Line A or Line E.

---

## Bridging

### DESCRIPTION

If you share a line with another person, you can join (or “bridge” onto) a call in progress on that line. In this way you can easily join a conference call by just touching a line button and **Speakerphone** or lifting your handset. (See “Conference.”)

### CONSIDERATIONS

Up to three people connected to the MERLIN Plus system, including the originator of the call, can bridge onto a call at one time. When a person bridges onto a call in progress, the red and green lights next to the line button on your voice terminal flash alternately so that you know that someone else has joined the call.

You cannot use the Bridging feature on a voice terminal with Button-Free Line Operation.

If a person has activated the Privacy feature on his or her voice terminal, you cannot bridge onto a call in progress at that voice terminal. (See “Privacy.”)

### ADMINISTRATION

None

### PROGRAMMING

None

### HOW TO USE

To bridge onto a call in progress:

- 1 Touch the line button associated with the call.
- 2 Touch **Speakerphone** or lift your handset.

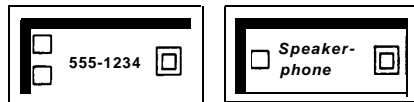

---

## Busy Buster (BB)

### DESCRIPTION

The Busy Buster feature automatically redials the number you most recently dialed up to ten times at 60-second intervals. If the called telephone begins to ring within this time, your voice terminal alerts you. To use this feature, the system administrator must have assigned the feature to a voice terminal jack on the control unit, a connection must have been made from that voice terminal jack to the BB jack on the memory module, and a button must be programmed at each applicable voice terminal.

### CONSIDERATIONS

The Busy Buster feature is shared by everyone in the MERLIN Plus system. When you and other people in your system use this feature at the same time, the system places the telephone number each person has dialed in a queue. The system then dials each number in the queue.

The system redials the call on the same line on which the call was placed. If you use a stop character in the dialing sequence of a System Speed Dial number, you *cannot* use Busy Buster to retry the number for you.

Each person in the system can have only one Busy Buster number active at a time.

If you or someone else places or accepts another call on a voice terminal that has activated Busy Buster, the system will continue to try to complete the call, even though your voice terminal is in use. When the BB call goes through, the voice terminal will alert you with an abbreviated ring even if you're on another call.

If you are using an SP-34 or an SP-34D voice terminal, Busy Buster can only be programmed onto one of the two rows of buttons *above* the dial pad.

Occasionally when Busy Buster is activated the voice terminal rings even when the call was not connected. This is due to noisy Central Office lines that can provide false indications to the MERLIN Plus system.

When a Busy Buster call is answered, your voice terminal is alerted. If there is a significant delay between the time that the called party answers and the time you pick up your alerting voice terminal, the party you called may become confused by the silence and hang up. Therefore, if you are expecting a Busy Buster call, you may want to activate the Do Not Disturb feature so that only transfer return calls, which include Busy Buster calls, will ring at your voice terminal.

If you activate Busy Buster for a number that is in the same local exchange as the number you're calling from, there is a chance that when successful, the call will be answered so quickly that the exchange network cannot provide the information to alert your voice terminal. The party you called could become confused and hang up.



## ADMINISTRATION

If your responsibilities do not include system administration, skip this information.

The system is factory-set to have the Busy Buster feature assigned to voice terminal jack 19 on the control unit. However, you can use the following procedure to assign the feature to any other voice terminal jack in the system, except jack 10.

- 1 Enter administration mode by sliding the T/P switch to *P* and touching **Administer**.
- 2 Dial \*35.
- 3 Touch the Auto Intercom button or dial the intercom number of the jack to which the Busy Buster feature will be assigned.  
*The green light goes on next to the Auto Intercom button to which the feature will be assigned.*
- 4 Touch **Administer**.  
*The console beeps twice.*
- 5 Leave administration mode by sliding the T/P switch to the center position.
- 6 Make sure the BB jack is moved to the corresponding voice terminal jack you've just assigned.

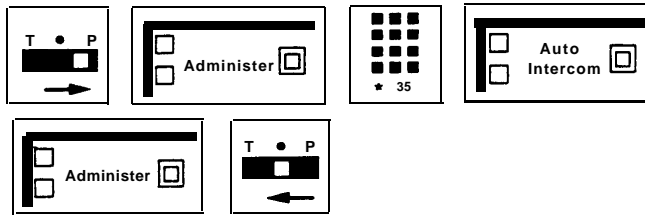

## PROGRAMMING

This feature requires a button with lights.

To program a button on your voice terminal for the Busy Buster feature:

- 1 Label the button **Busy Buster**.
- 2 Slide the T/P switch to *P*.  
*The voice terminal rings every 5 seconds to remind you that you are programming and that you cannot place or receive calls.*
- 3 Touch the button you want to program.
- 4 Dial \*31 (you do not need to dial an outside number).
- 5 Slide the T/P switch to the center position.

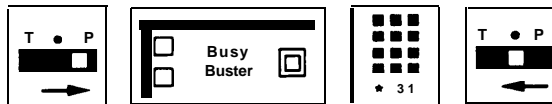

---

## HOW TO USE

If the number you are calling is busy and you want to use the BB feature, follow this procedure:

- 1 *Before* you hang up, touch the **Busy Buster** button.

*The green light next to the Busy Buster button flashes.*

- 2 Hang up.

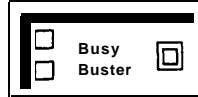

When the dialed number rings, your voice terminal rings. To begin the call:

- 1 Touch **Speakerphone** or lift the handset.

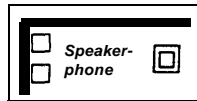

If you no longer want to have the system repeatedly redial the last number you dialed, you can deactivate the feature.

- 1 Without lifting the handset, touch **Busy Buster**.

*The green light next to the button goes off.*

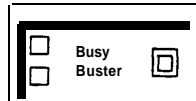

---

## Button-Free Line Operation

### DESCRIPTION

Button-Free Line Operation allows people with a 5-button or any 10-button voice terminal to access lines, even though the lines do not appear on the voice terminal buttons. Therefore, those voice terminals have additional free buttons for needed programmed features. This feature is ideal for people who need several lines, but who rarely handle more than one call at a time. To place or answer a call, they just lift their handset, and the MERLIN Plus system selects a free line for outgoing calls or the ringing line for incoming calls.

### CONSIDERATIONS

The system administrator can assign a maximum of eight lines to a button-free voice terminal. However, if the administrator again wants lines assigned to buttons on a voice terminal, he or she can assign only the number of lines for which the voice terminal has line buttons. For example, if the administrator has assigned eight lines to a 5-button voice terminal with Button-Free Line Operation and decides to assign lines to voice terminal buttons, only four of those eight lines can appear. The features that the administrator or user has programmed onto the voice terminal buttons will be replaced by lines.

With Button-Free Line Operation, the system administrator can administer the individual voice terminals so that they ring or do not ring when calls come in. (See “Ringing Options.”) Button-Free Line Operation with the no ring option is appropriate for voice terminals in public places, such as lobbies.

When anyone in your system uses the Button-Free Line Operation feature:

- There are no red and green lights associated with lines to keep track of call-handling features, such as Transfer or Hold.
- The person with Button-Free Line Operation can answer transferred calls and ringing lines by picking up the handset.
- There is no way of knowing which line the system has selected for an outgoing call. Therefore, make sure that all lines assigned to these voice terminals are of the same type. Do not mix regular lines, WATS lines, and Foreign Exchange lines.
- You cannot program an Automatic Line Selection sequence on voice terminals with Button-Free Line Operation. In this case, only your system administrator can assign the sequence of lines for your voice terminal.
- You can use the Intercom, Hold, Transfer, and Call Pickup features, but you *cannot* use the Bridging or the Conference feature.

### ADMINISTRATION

If your responsibilities do not include system administration, skip this information.

To make lines on a voice terminal button-free:

- 1 Enter administration mode by sliding the T/P switch to *P* and touching **Administer**.

- 2 Touch the Auto Intercom button or dial the intercom number for the voice terminal you are administering.

*A green light goes on next to the Auto Intercom button. Green lights go on next to the buttons of any lines already assigned to the voice terminal.*

- 3 Touch the line button until the green light next to it shows the line assignment you want:

*Green light on = the line is assigned to the voice terminal*

*Green light off = the line is not assigned to the voice terminal*

- 4 To make the line Button-Free, dial one of these two codes:

- > Dial \*31 if you want the voice terminal to ring.

*The green light next to the Auto intercom button flashes rapidly.*

- > Dial \*32 if you do not want the voice terminal to ring.

*The green light next to the Auto Intercom button flashes slowly.*

- 5 Touch **Administer**.

*The console beeps twice.*

- 6 Leave administration mode by sliding the T/P switch to the center position.

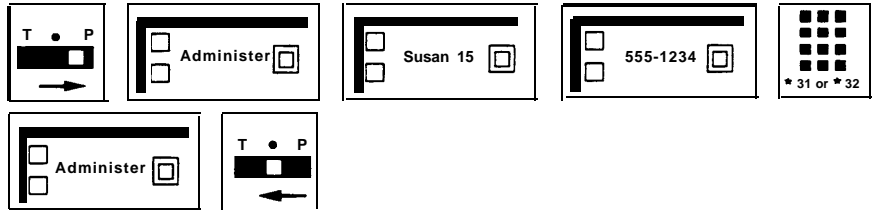

To remove Button-Free Line Operation by reassigning lines to separate buttons on a voice terminal:

- 1 Enter administration mode by sliding the T/P switch to *P* and touching **Administer**.

- 2 Touch the Auto Intercom button for the voice terminal you are administering.

- 3 Dial \*34.

*A green light should go on next to the lines that have been assigned to the voice terminal.*

- 4 Touch **Administer**.

*The console beeps twice.*

- 5 Leave administration mode by sliding the T/P switch to the center position.

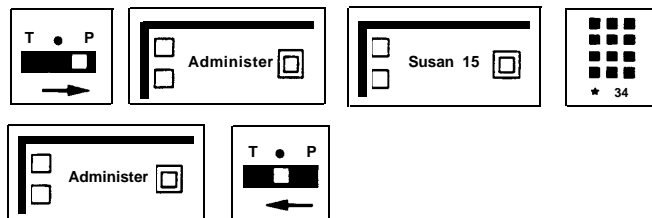

---

**PROGRAMMING**

None

**HOW TO USE**

If you do not have a line button for a call that you have received or that has been transferred to you, you can still put the call on hold using the Hold button. To retrieve the call, you can use the Hold Retrieve feature. (See “Hold Retrieve.”)

---

## Call Forwarding (CF)

**NOTE:** Call Forwarding is an ASA feature and therefore requires the assignment of the ASA jack. If the ASA jack assignment has not yet been made, refer to “Automatic System Access” in this section before attempting to administer this feature.

### DESCRIPTION

When in CF mode, incoming calls on designated lines are connected to the Voice Synthesis Processor (VSP), then while the caller is listening to the message, the control unit dials the telephone number where calls are being forwarded. When the person at the CF number answers, the system then uses the conferencing feature to connect the two calls, and the call progresses normally.

You have the option to change the message or you can have calls forwarded without the message so that callers are unaware that their calls are being forwarded. You can also change the call forwarding number from any Touch-Tone phone.

### CONSIDERATIONS

Call Forwarding requires the following:

- A programmed button with green and red lights labeled **CF/DXD**.

You use the CF/DXD button to activate either Call Forwarding or Direct Extension Dialing (discussed later in this section). To put the system in either of these modes, or in normal mode, you touch the CF/DXD button. The green and red lights show you what mode you are in.

**NOTE:** Direct Extension Dialing does not work with the MERLIN Attendant.

- > If the system is in normal mode, touch the button *twice* to put the system in CF mode

*Only red light on = CF mode*

**NOTE:** You must first assign a CF number before touching the CF/DXD button to put the system in CF mode.

- > Touch the button a third time to put the system back into normal mode.

*Green and red light off = normal mode*

- A valid 5-digit password to gain access from a remote location to enter a call forwarding number or to change the current call forwarding number.

To enter a password, follow the administration procedure discussed later in this entry.

- 
- That there can be more than one CF/DXD button in the system, but a voice terminal can have only one CF/DXD button:

If two or more users have a CF/DXD button programmed on their voice terminals, each of them can turn the features on and off. For example, if one of these users activates Call Forwarding, the red light goes on next to the CF/DXD button on all the voice terminals that have that button. When a person deactivates the feature by touching the CF/DXD button, the light goes off next to the button on all the voice terminals that have the programmed CF/DXD button.
  - A synthesized voice message:

This message is automatically supplied by the VSP in the control unit. The administrator can modify the message when necessary or may choose to turn off the message.
  - That one jack on the control unit be dedicated to the ASA features.

See “Automatic System Access” in this section for administration procedures.
  - That you administer at least one line to an incoming and one line to an outgoing line group:

At startup, none of the system’s lines are assigned to the CF incoming or outgoing line group.
  - If there is only one line in the incoming line group and one line in the outgoing line group, they *cannot* be the same line. The green light next to the CF button will flash when you try to turn it on.
  - When the system is in CF mode, the feature’s operation affects only those calls that come in on lines in the CF incoming line group. Likewise, the system only uses the lines in the CF outgoing line group to forward calls. Calls coming in on lines not assigned to the CF incoming line group are not automatically answered for call forwarding.
  - Call Forwarding should be used only at night if your system has one or more MERLIN Attendants, and you do not have dedicated lines for Call Forwarding. To use Call Forwarding at night with the MERLIN Attendant, activate this feature before leaving the office at the end of the business day, and deactivate it as soon as your business day begins.
  - The Call Forwarding/Remote Line Access Disconnect Timer should be used in conjunction with CF if your Central Office (CO) does not provide a “forward disconnect” signal to your MERLIN Plus system. (See “Call Forwarding/Remote Line Access Disconnect Timer” in this section.)

---

## ADMINISTRATION

If your responsibilities do not include system administration, skip this information.

### Call Forwarding Line Groups

At startup, *none* of the system's outside lines are assigned to the CF incoming or outgoing line group. To use this feature YOU must assign line(s) to each group.

**NOTE:** To use Call Forwarding with the MERLIN Attendant, you should have one outgoing line for each incoming line in every Call Forwarding line group.

**1** Enter administration mode by sliding the T/P switch to *P* and touching **Administer**.

**2** Dial the code for the type of line group list you want to administer:

> CF *incoming* line group, dial \*51

*Green light on = line is assigned to the group*  
*Green light off = line is not assigned to the group*

> For a CF *outgoing* line group, dial \*52

*Green light on = line is assigned to the group*  
*Green light off = line is not assigned to the group*

**3** Touch the line buttons until the green lights show the makeup you want for the line group.

**4** Touch **Administer**.

*The console beeps twice.*

**5** Leave administration mode by sliding the T/P switch to the center position.

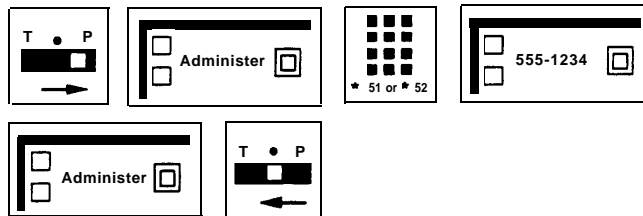



## Voice Messages

The system automatically provides the following default voice message for call forwarded calls:

*“Your call is being forwarded. Please hold.”*

You can modify this message to include the following statement:

*“You have reached nnn...”*

where *nnn...* is the telephone number of one of your outside lines. The number can be up to 16 digits, including \* or #. You can modify the message for all lines in an incoming line group, or you can modify the message for some and leave others unmodified. To modify the CF message for one or more lines in your incoming line groups, do the following:

- 1 Enter administration mode by sliding the T/P switch to *P* and touching **Administer**.
- 2 Dial \*50.
- 3 Touch the line button for the line on which you want the modified message.  
*The green light goes on.*
- 4 Dial the telephone number you want to include in the message.

**NOTE:** For special phone numbers, such as an 800 number, you may prefer to have the recorded voice say “Eight hundred” followed by the number, instead of “Eight, zero, zero.” In this case, you would touch the Hold button to enter a pause after the toll prefix, then again after the 800 area code, and again after the exchange. For example, 1-800-555-1212 would be entered as follows:

1 **Hold** 800 **Hold** 555 **Hold** 1212

- 5 Repeat for other lines.
- 6 Touch **Administer**.  
*The console beeps twice.*
- 7 Leave administration mode by sliding the T/P switch to the center position.

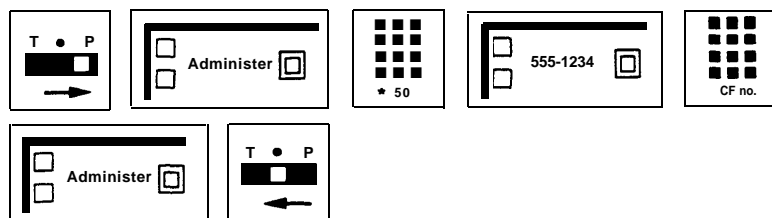

To return to the message provided with the system:

- 1 Enter administration mode by sliding the T/P switch to *P* and touching **Administer**.
- 2 Dial \*50.

- 3 Touch the line button.  
*The green light goes off.*
- 4 Touch **Administer**.  
*The console beeps twice.*
- 5 Leave administration mode by sliding the T/P switch to the center position.

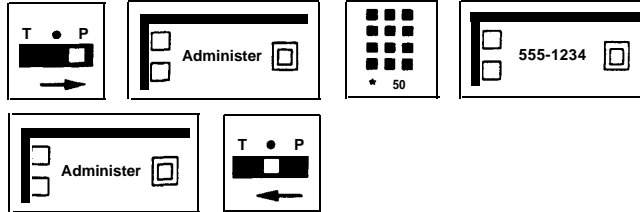

You may also choose to forward your calls without a message:

- 1 Enter administration mode by sliding the T/P switch to *P* and touching **Administer**.
- 2 Dial \*30.
- 3 Dial 0 to turn off the message.  
**NOTE:** To turn on the message, dial 1 instead of 0 in step 3.
- 4 Touch **Administer**.  
*The console beeps twice.*
- 5 Leave administration mode by sliding the T/P switch to the center position.

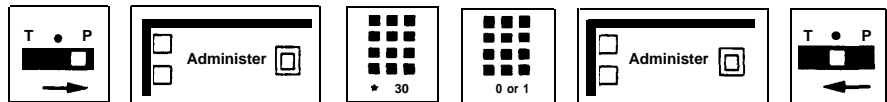

### Numbers of Rings

To change the number of rings (the default is two rings) before the CF call is answered:

- 1 Slide the T/P switch to *P* and touch **Administer**.
- 2 Dial \*762 plus the number of rings (between 0 and 9) before CF picks up the call.  
**NOTE:** If the number of rings is set to 0, the voice terminal will not ring, and the calls will be forwarded immediately.
- 3 Touch **Administer**.  
*The console beeps twice.*
- 4 Leave administration mode by sliding the T/P switch to the center position.

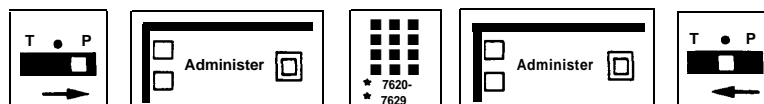

## Passwords

You and others in your business need at least one valid 5-digit password in order to change a call forwarding number from a remote location. The first two numbers in the password are the caller's intercom number.

To create or invalidate a password, follow this procedure:

- 1 Enter administration mode by sliding the T/P switch to *P* and touching **Administer**.
- 2 Dial \*56
- 3 Perform the appropriate step below:
  - > To create a password for a particular intercom number, dial a MERLIN Plus system intercom number plus any three digits except 000.  
*The console beeps twice.*
  - > To invalidate any password beginning with a particular intercom number, dial the intercom number plus 000. Repeat the procedure for more passwords.  
*The console beeps twice.*
- 4 Touch **Administer**.  
*The console beeps twice.*
- 5 Leave administration mode by sliding the T/P switch to the center position.

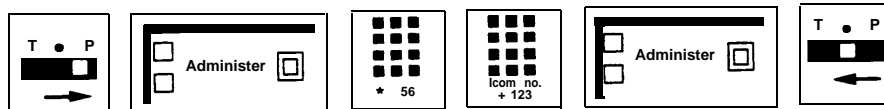

## Call Forward Destination Number

You can enter or change the telephone number where you want calls forwarded (the CF destination number) in either of two ways:

- Follow the first procedure below to enter or change the CF destination telephone number *from the administrator/attendant console* with the system in administration mode.
- Follow the second procedure below to enter or change the CF destination telephone number *from a phone outside the system* with the system in CF mode.

**From the Administrator/Attendant Console** To enter, change, or delete the CF destination telephone number from the administrator/attendant console, follow this procedure.

- 1 Press **CF/DXD** to go into normal mode.  
*Green and red lights go off.*
- 2 Enter administration mode by sliding the T/P switch to *P* and touching **Administer**.
- 3 Dial \*53.
- 4 Perform the appropriate step below:
  - > To enter or change a CF destination telephone number, dial the new number.
  - > To remove the current CF destination number without replacing it with another number, touch **Administer**.
- 5 Touch **Administer**.  
*The console beeps twice.*
- 6 Leave administration mode by sliding the T/P switch to the center position.

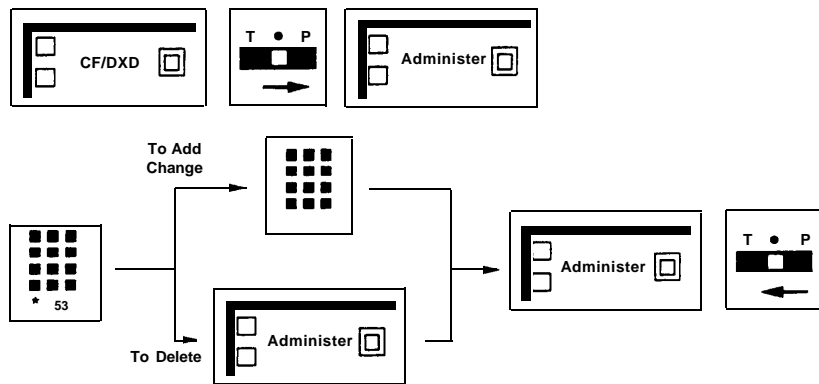

**From Outside the System** To enter or change the CF destination number from outside the system while the system is in CF, DXD, or RLA mode, follow this procedure.

**NOTE:** This procedure is available on the MERLIN Plus CF/RLA card, so that you can refer to it when you're changing the CF destination while off-site.

- 1 Dial the telephone number for one of the lines in the CF incoming line group.  
*When the call is answered, you hear the CF voice message.*
- 2 During the voice message, dial \*##.  
*The system goes into RLA mode, and the VSP asks you to enter your password.*

**NOTE:** If a voice prompt is not administered, the CF destination number cannot be changed from outside the system.
- 3 At the voice prompt, enter your password.  
*The VSP asks you to enter a line number.*
- 4 At the voice prompt, dial 00.  
*The VSP asks you to enter the new call forward number followed by a pound (#).*

- 5 Dial the new CF telephone number plus a pound (#).  
*The VSP repeats the new number and asks you to either confirm it by dialing a \* or deny it by dialing 00.*
- 6 Dial \* to confirm, or dial 00 to return to step 5, above, and try again.  
*After receiving the confirmation signal, the VSP repeats the new number once more and identifies it as the new call forward number*
- 7 Hang up.

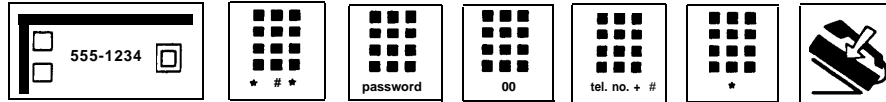

## PROGRAMMING

A button with a red light next to it is required for the CF feature.

To program a CF/DXD button on a voice terminal:

- 1 Label the button **CF/DXD**.
- 2 Slide the T/P switch to *P*.  
*The voice terminal rings every 5 seconds to remind you that you're programming and that you can't place or receive calls.*
- 3 Touch the button you want to program.
- 4 Dial \*83.
- 5 Slide the T/P switch to the center position.

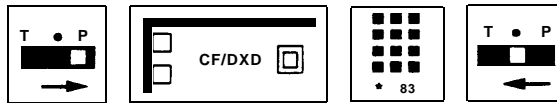

## HOW TO USE

### Using the CF/DXD Button

Touching the CF/DXD button repeatedly cycles the system through DXD, CF, and normal modes. The red and green lights next to the CF/DXD button will help you recognize which mode the system is in.

*Green and red light off = Normal mode  
Only green light on = DXD mode  
Only red light on = CF mode  
Red light flashing = Problem with CF*

If the red light next to the CF/DXD button is flashing, notify the system administrator who should refer to Section 7, "Troubleshooting."

To return to CF mode after an error has been corrected:

- 1 Touch **CF/DXD** three times.  
*The first time puts the system in normal mode; the second touch of the button puts the system in DXD mode; the third touch puts the system in CF mode.*



---

## Call Forwarding/Remote Line Access Disconnect Timer

**DESCRIPTION** The Call Forwarding/Remote Line Access Disconnect Timer is used in conjunction with the Call Forwarding and Remote Line Access features in MERLIN Plus systems for which the Central Office (CO) lines do not provide a forward disconnect signal. The timer disconnects calls made using Call Forwarding and/or Remote Line Access after these calls reach a call duration threshold that is set for the system. This threshold may be set between 1 and 99 minutes.

**CONSIDERATIONS** The timer will disconnect a Call Forwarding or Remote Line Access call at the administered interval, even if a conversation is in progress.

This feature should only be used if your CO lines *do not* provide a forward disconnect signal (also known as a “held call disconnect signal”) of 450 msec or 50 msec.

**ADMINISTRATION** If your responsibilities do not include system administration, skip this section, To administer the Customer Administrable Timer:

- 1 Enter administration mode by sliding the T/P switch to *P* and touching **Administer**.
- 2 Dial \*68.
- 3 Dial the desired three-digit timer value. You must dial **3** digits:  
For example, to set the timer value to 1 minute, you must dial *001*, a value of 10 minutes would be dialed *010*, and a value of 120 minutes would be dialed *120*.
- 4 Touch **Administer**.  
*The console beeps twice.*
- 5 Leave administration mode by sliding the T/P switch to the center position.

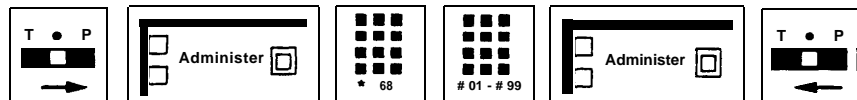

**PROGRAMMING** None

**HOW TO USE** None

---

## Call Pickup

### DESCRIPTION

If you want to pick up an intercom or outside call that is ringing at another voice terminal, use the Call Pickup feature.

You can use this feature in three different ways:

- **Option A** —You can use a dial code and dial the intercom number of the ringing voice terminal.
- **Option B** —You can program a Call Pickup button and dial the intercom number of the ringing voice terminal.
- **Option C** —You can program a One-Touch Call Pickup button for a specific voice terminal in your business so that when the person is away, you can answer that person's calls with one touch. You can program a Call Pickup button for each voice terminal for which you need to answer calls.

### CONSIDERATIONS

If the line on which the call is coming in appears on a button on your voice terminal, you do not need to use the Call Pickup feature to answer the call. You can just touch the line button on which the call is ringing and then touch **Speakerphone** or lift your handset.

If you want someone in the office, such as a guard, to answer calls that come in after hours, program a Call Pickup button for calls that come in at the administrator/attendant console. Since the attendant console has all the lines of your MERLIN Plus system, the person answering calls after hours can pickup all calls by touching the Call Pickup button whenever the attendant console rings. If the person is in another part of the building, the attendant can connect his or her console and an extra alert device to a Supplemental Alert Adapter (see "Supplemental Alert Adapter" under "Accessory Equipment"), so that each time a call comes in, an extra alert device goes on.

### ADMINISTRATION

None

## PROGRAMMING

You do not need to program Option A.

To program Option B:

- 1 Label the button **Call Pickup**.
- 2 Slide the T/P switch to *P*.  
*The voice terminal rings every 5 seconds to remind you that you are programming and that you cannot place or receive calls.*
- 3 Touch the button you want to program.
- 4 Dial \*85.
- 5 Slide the T/P switch to the center position.

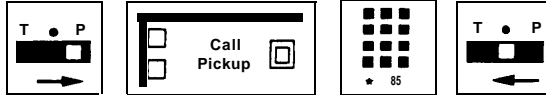

To program Option C:

- 1 Label the button **Call Pickup** plus an intercom number.
- 2 Slide the T/P switch to *P*.  
*The voice terminal rings every 5 seconds to remind you that you are programming and that you cannot place or receive calls.*
- 3 Touch the button you want to program.
- 4 Dial \*85 plus an intercom number.
- 5 Slide the T/P switch to the center position.

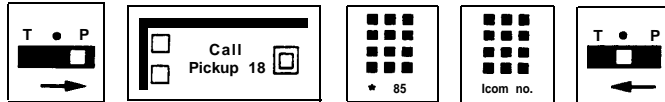

## HOW TO USE

You can use a programmed button or a dial code to pick up an intercom or outside call at any other voice terminal in the system.

To pickup a call ringing at any other voice terminal using Option A:

- 1 Touch **Speakerphone** or lift your handset.
- 2 Dial #3.
- 3 Dial the intercom number of the voice terminal where the call is ringing.

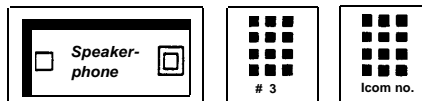



---

To pickup a call ringing at any other voice terminal using Option B:

- 1 Touch **Speakerphone** or lift your handset.
- 2 Touch the Call Pickup button you programmed above.
- 3 Touch the Auto Intercom button or dial the intercom number of the voice terminal at which the call is ringing.

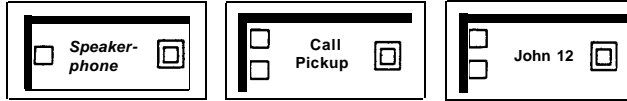

To pickup ringing calls at a specific voice terminal using Option C:

- 1 Touch **Speakerphone** or lift your handset.
- 2 Touch the One-Touch Call Pickup button you have programmed for the voice terminal.

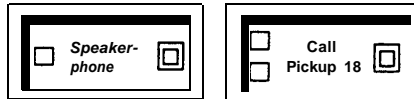

# Call Report

**NOTE:** This feature is used with a MERLIN Plus system data collector and an AT&T 475/476 or 572/573 printer or its equivalent.

## DESCRIPTION

The Call Report feature, often called Station Message Detail Recording (SMDR), enables a business to keep records of incoming and outgoing calls. The information in a printed call report gives details about outgoing and incoming calls: the date and time of each call, its duration, the line and voice terminal on which the call was made or received, and the dialed numbers of the outgoing call. Call reports are printed automatically as calls go out or come in. This information helps a business build records of its telephone traffic patterns and identify abuses in voice terminal privileges.

If an account code is entered when the call is made, the call report prints that information for you. Account codes are helpful in billing customers and different departments of the company for telephone calls that should be charged to them. (See "Account Number Entry.") The data collector and the printer can also print a System Feature Report, a list of the features that have been administered to the system (see "System Feature Report"). Figure 5-1 shows a printout that contains several typical Call Reports. Each line beginning with "C" represents an individual Call Report.

**FIGURE 5-1 A Printout of Typical Call Reports.**

DATE	TIME	CALLED NUMBER	DURATION	LN	STN	ACCOUNT
C 08 21 86	11:01	9090334	00:01:13	8	11	32145677
C 08 21 86	11:05	7879096565	00:06:24	6	15	
C 08 21 86	13:15	110869685679714?	00:13:06	4	11	
C 08 21 86	14:05	4697896	00:09:00	3	12	63354324
C 08 22 86	09:43	IN	00:02:16	4	11	
C 08 22 86	10:12	8889914321	00:12:18	7	14	
C 08 22 86	11:15	IN	00:17:09	3	12	
C 08 22 86	14:25	110869685679714?	00:08:15	4	11	
C 08 23 86	11:15	4697896	00:19:11	3	12	63354324
C 08 24 86	08:10	#67	00:12:14	5	18	

**Notes:**

- 1 Column headings (DATE, TIME, etc.) do *not* appear on Call Report printouts
- 2 An IN in the Called Number column indicates an incoming call
- 3 A ? at the end of a number in the Called Number column indicates that the number called had more than the 15 reported digits.

---

As you can see from the reports in Figure 5-1, the system prints the number of each outgoing call. If there's a telephone number you'd like to keep private—say, a number containing a long distance access code—you can give that number a System Speed Dial code and mark it for privacy when you enter it during system administration. Then the system will print the System Speed Dial code instead of the telephone number on Call Reports, as the last Call Report in Figure 5-1 shows. See “System Speed Dial” later in this section.

## CONSIDERATIONS

The Call Report feature can only be invoked at the administrator/attendant console.

When the system administrator administers the system for the Call Report feature, he or she can set certain options for the feature.

- The administrator should set the initial time and date, so that these details appear correctly on the call report.
- The system is set to have the data collector and the printer connected to voice terminal jack 19 for the Call Report feature. However, the administrator can administer the printer and connect it to any other voice terminal jack in the system, except jack 10.

**NOTE:** If you are using the same printer and data collector for both the System Feature Report and the Call Report features and change the voice terminal jack assignment, you must administer the new jack assignment for *both* features. You *cannot* use the same jack that you used for ASA but ASA can share the same jack assigned to BB by using the adapter provided with the data collector. ASA and BB jack assignments can be changed if necessary.

- The administrator can select the type of calls that appear on the call report. The system is factory-set to have no calls reported. However, the administrator can set the system for reporting outgoing *and* incoming calls, or for reporting *only* outgoing calls.
- The system is set to record outgoing calls that last at least 1 minute. However, the system administrator can change that setting for a longer (up to 9 minutes) or shorter (as little as 10 seconds) minimum duration.
- The administrator can also specify which System Speed Dial codes are printed on call reports, and which ones will be private.

The entries on a call report are preceded by a “C.”

## ADMINISTRATION

If your responsibilities do not include system administration, skip this information.

Before you administer the Call Reports options for your system, refer to the System Configuration Form that you have filled out.

To administer the various Call Reports options for your system:

### The Date and the Time

To set today's date:

- 1 Enter administration mode by sliding the T/P switch to *P* and touching **Administer**.
- 2 Dial \*80.
- 3 Dial two digits for the month (01 through 12).
- 4 Dial two digits for the day (01 through 31).
- 5 Dial two digits for the year (00 through 99).

For example, if the date is March 24, 1988, dial \*80032488.

- 6 Touch **Administer**.  
*The console beeps twice.*
- 7 Leave administration mode by sliding the T/P switch to the center position.

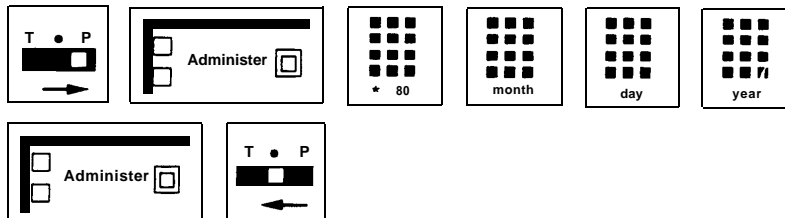

To set the current time:

- 1 Enter administration mode by sliding the T/P switch to *P* and touching **Administer**.
- 2 Dial \*81.
- 3 Dial two digits for the hour (00 through 23).
- 4 Dial two digits for the minute (00 through 59).

For example, if the time is 2:16 A.M., dial \*810216; if the time is 2:16 P.M., dial \*81 14 16.

- 5 Touch **Administer**.  
*The console beeps twice.*
- 6 Leave administration mode by sliding the T/P switch to the center position.

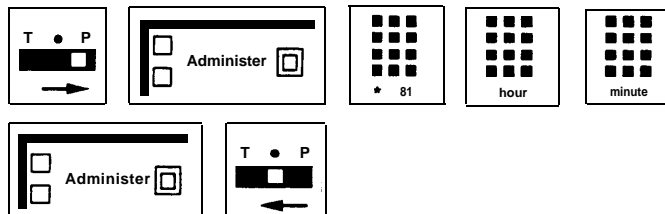

## Control Unit Jack Assignment for the Call Report Feature

To specify the voice terminal jack to which the data collector and the printer will be connected:

**NOTE:** The system is factory-set for jack 19.

- 1 Enter administration mode by sliding the T/P switch to *P* and touching **Administer**.
- 2 Dial \*82.  
*The green light goes on next to the Auto Intercom button that corresponds with the jack to which the data collector and the printer are currently assigned.*
- 3 Touch the Auto Intercom button or dial the intercom number of the jack to which the data collector and printer are currently assigned.  
*The green light goes off next to the Auto Intercom button that corresponds with the jack to which the data collector and printer are currently assigned.*  
  
Touch the Auto Intercom button or dial the intercom number of the jack to which the data collector and the printer will be connected.  
*The green light next to the button goes on.*
- 4 Touch **Administer**.  
*The console beeps twice.*
- 5 Leave administration mode by sliding the T/P switch to the center position.

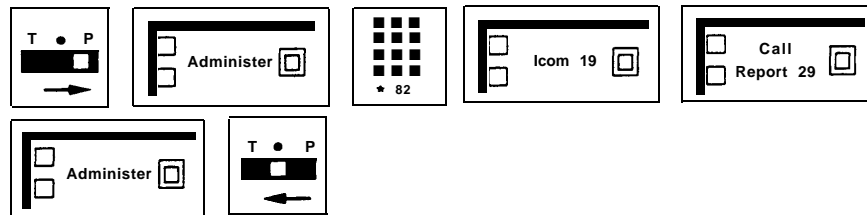

## Minimum Call Duration

To specify a minimum call duration other than 1 minute for call reporting:

- 1 Enter administration mode by sliding the T/P switch to *P* and touching **Administer**.
- 2 Dial \*83.
- 3 Dial one digit from 0 to 9 for the number of minutes.  
  
For example, to specify a minimum duration of 10 seconds, dial \*830. To specify a minimum duration of 9 minutes, dial \*839.
- 4 Touch **Administer**.  
*The console beeps twice.*
- 5 Leave administration mode by sliding the T/P switch to the center position.

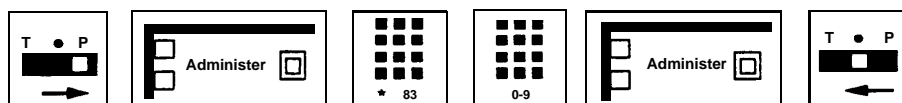

---

### Type of Documented Calls

To specify the type of calls that will be documented (the system is set to have no calls reported):

- 1 Enter administration mode by sliding the T/P switch to *P* and touching **Administer**.
- 2 Dial \*84.
- 3 Dial a number code 0 through 2 to specify the kind of calls to be reported (the system is factory-set so that no calls are reported):
  - > If you do not want any calls reported, dial 0.
  - > If you want only outgoing calls reported, dial 1.
  - > If you want outgoing *and* incoming calls reported, dial 2.
- 4 Touch **Administer**.  
*The console beeps twice.*
- 5 Leave administration mode by sliding the T/P switch to the center position.

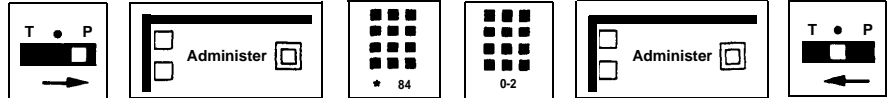

**PROGRAMMING**

None

**HOW TO USE**

None

---

## Call Restriction

### DESCRIPTION

When the system is first installed, people can use their voice terminals to place intercom, local, and toll calls. However, the system administrator can assign either of two types of call restrictions for selected voice terminals:

- **Outward Call Restriction** restricts voice terminals so that only intercom calls can be placed.
- **Toll Call Restriction** restricts voice terminals so that only intercom and local calls can be placed.

### CONSIDERATIONS

Even if a voice terminal has Outward Call Restriction, the person can bridge onto calls in progress, answer incoming calls, and place and receive intercom calls.

If the outward call restrictions are too limiting, the administrator can designate a list of numbers that individuals may call beyond the established restrictions. (See “Allowed Lists.”)

If the administrator decides to store a System Speed Dial code with Restriction Override, all voice terminals in the system can use the code as a type of password that allows the person to access the outside number, regardless of toll or outward call restrictions previously placed on the voice terminal. (See “System Speed Dial.”)

If there are two or more voice terminals in the system that will have the same restrictions, the administrator can use the Copy feature to copy these restrictions from one voice terminal to another. (See “Copy.”)

When administering call restrictions, the system administrator can use the Automatic Call Restriction Reset feature to ensure the integrity of the assigned restrictions. (See “Automatic Call Restriction Reset” in this section.)

### ADMINISTRATION

If your responsibilities do not include system administration, skip this information.

To administer call restrictions to a voice terminal:

- 1 Enter administration mode by sliding the T/P switch to *P* and touching **Administer**.
- 2 Touch the Auto Intercom button or dial the intercom number of the voice terminal you want to restrict.
- 3 Touch **Restrict** until the green light beside it shows the kind of call restriction you want the voice terminal to have.

*Steady green light on = Unrestricted (all calls permitted)*

*Flashing green light = Toll restricted (local and intercom calls only)*

*Green light off = Outward restricted (intercom calls only)*

- 4 Touch **Administer**.

*The console beeps twice.*

- 
- 5 Repeat steps 2 through 4 for each voice terminal you want to restrict.
  - 6 Leave administration mode by sliding the T/P switch to the center position.

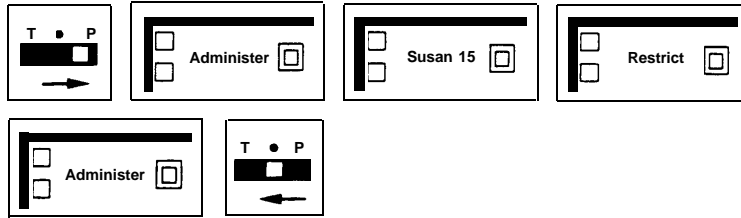

**PROGRAMMING**

None

**HOW TO USE**

Ask your system administrator what call restrictions, if any, he or she has assigned to your voice terminal.



---

## Centralized Programming

### DESCRIPTION

The Centralized Programming feature allows the system administrator the convenience of programming features onto individual voice terminals directly from the administrator/attendant console. In this way there is no need to go to each voice terminal to do the programming. This feature is useful when the administrator is assigning Ringing Options for incoming calls.

### CONSIDERATIONS

The system administrator must be certain that the appropriate feature buttons on the voice terminals are accurately labeled.

The voice terminal being programmed must be idle. If the voice terminal is busy or in program mode, the administrator hears a beep at the administrator/attendant console, indicating that he or she cannot use this feature until the voice terminal is idle again.

This feature *cannot* be used to program station 10.

The system administrator can use the Program Mode Lock feature to prevent people within the system from changing programming assignments on their voice terminals. (See “Program Mode Lock.”)

### ADMINISTRATION

If your responsibilities do not include system administration, skip this information.

To program a feature onto a voice terminal from the administrator/attendant console:

- 1 Enter administration mode by sliding the T/P switch to *P* and touching **Administer**.
- 2 Touch the Auto Intercom button or dial the intercom number for the voice terminal you want to program.
- 3 Touch **Conference**.  
*Green lights go on next to the line buttons of lines already assigned to the voice terminal.*
- 4 Follow the same steps to program the feature that you would follow if you were at the voice terminal.
- 5 When you are finished programming the features for that voice terminal, touch **Conference** again.
- 6 Leave administration mode by sliding the T/P switch to the center position.

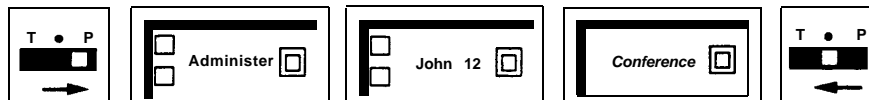

---

**PROGRAMMING**

None

**HOW TO USE**

None

---

## Conference

### DESCRIPTION

When you want people *outside* the MERLIN Plus system to join a call in progress, you can use the Conference feature. You can set up a conference call that includes up to two people from outside the MERLIN Plus system, up to two people within the system, and yourself, a total of five people.

### CONSIDERATIONS

People connected to the MERLIN Plus system can bridge onto an outside line that is active on the conference call unless one of the participants has activated the Privacy feature. However, when the maximum configuration of three people within the system and two from outside is reached, attempts to add more people will be denied.

Use the Drop button followed by touching the appropriate line button when you want to selectively disconnect one outside line at a time from a conference call. (See “Drop.”) If you press the switchhook, you may end the conference call.

You cannot use the Conference feature for outside lines on a voice terminal with Button-Free Line Operation.

If you attempt to add to a conference call a voice terminal that is busy on another call, you will hear busy tones, and the call is automatically dropped in 15 seconds. If the voice terminal does not answer, you can drop the call by touching **Drop** without disconnecting the person who is already part of the conference.

### ADMINISTRATION

None

### PROGRAMMING

None

### HOW TO USE

To setup a conference call when one outside line is already on the call:

- 1 Touch **Conference**.
- 2 Touch a free line button.
- 3 Dial the outside number of the person you want to add to the conference call.

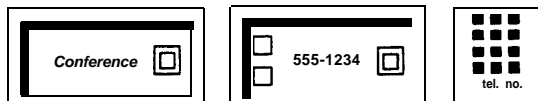

If you don't want the person already connected to listen while you connect the second person to the call:

- 1 Touch **Hold**.
- 2 Touch a free line button.
- 3 Dial the outside number of the second person you want to include in the conference.

- 
- 4 Announce the conference call through your speaker or handset.
  - 5 Touch **Conference**.
  - 6 Touch the line button for the line that you put on hold.

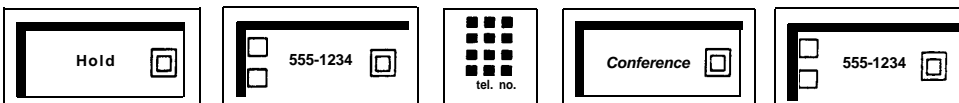

To rejoin the call:

- 1 Touch a line button associated with the call.

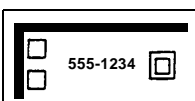

To disconnect one participant from the call:

- 1 Touch **Drop**.
- 2 Touch the button of the line you want to disconnect.

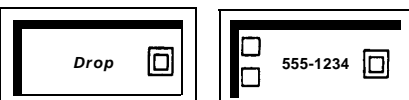

To add someone inside the system to the conference call:

- 1 Dial the person's intercom number to request that he or she pick up the line that the conference call is on. (See "Intercom.")

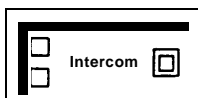

---

# Copy

## DESCRIPTION

If there are two or more voice terminals that require identical feature assignments, the system administrator can use the Copy feature to copy the line and programmable feature assignments from one voice terminal onto another.

## CONSIDERATIONS

When the administrator uses the Copy feature, the MERLIN Plus system copies the line assignments from one voice terminal to the other. Feature assignments are always overwritten by lines.

Several other features are also copied during the Copy process: Ringing Options, Voice Announcement Enable/Disable, Automatic Line Selection, Personalized Ringing, Button-Free feature, and Call Restrictions except for Allowed Lists.

The “System Answer” button programmed for the System Answer feature *cannot* be copied. If attempted, the corresponding button on the voice terminal you are copying to will be blank.

If you have a 5-button voice terminal, you *cannot* copy any lines or feature onto a larger voice terminal, or vice versa.

Except for the 5-button voice terminal, the administrator can copy the lines and features from any small voice terminal onto a larger voice terminal. If you are the system administrator, you might want to copy the button assignments from a BIS-10 onto a BIS-22 voice terminal for example. You can also copy from a large voice terminal to a smaller voice terminal. However, if you copy lines or features from a large voice terminal onto a smaller voice terminal, such as from a BIS-34 to a BIS-22, the system copies only those lines and/or features for which there are corresponding buttons on the smaller voice terminal. For example, in copying the lines and features from a BIS-34 voice terminal onto a BIS-22 voice terminal, the system copies only those lines and/or features assigned to the three left columns of buttons (the first 22 buttons) of the BIS-34 voice terminal. The rightmost column of buttons on the BIS-34 voice terminal will *not* be copied onto the smaller voice terminal.

Be sure to label the buttons on the voice terminal to which lines or features have been copied.

If any voice terminal in the system is active on a call, you must wait until it is idle before you can use Copy.

## ADMINISTRATION

If your responsibilities do not include system administration, skip this information.

To copy line and feature assignments from one voice terminal to another:

- 1 Enter administration mode by sliding the T/P switch to *P* and touching **Administer**.
- 2 Touch the Auto Intercom button or dial the intercom number of the voice terminal *to* which you want to copy line assignments.
- 3 Touch **Copy**.

- 4 Touch the Auto Intercom button or dial the intercom number of the voice terminal *from* which you are copying line assignments.
- 5 Touch **Administer**.  
*The console beeps twice.*
- 6 Leave administration mode by sliding the T/P switch to the center position.
- 7 Be sure to label the new line assignments on the voice terminal *to* which you did the copying.

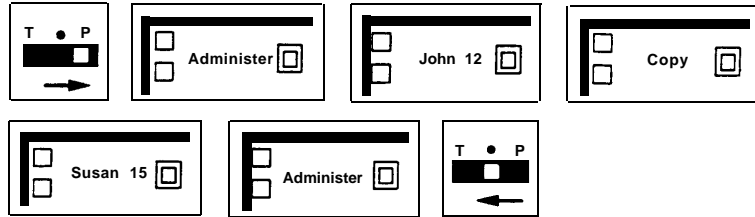

**PROGRAMMING**

None

**HOW TO USE**

None

---

# Customized Line Assignment

## DESCRIPTION

The system administrator can assign lines to any voice terminal in any order, or choose not to assign particular lines to a voice terminal. The administrator can use Customized Line Assignment if he or she wants to assign lines or groups of lines to selected voice terminals with similar requirements for placing and receiving calls. For example, this might include people within a particular department who need the same line assignments as each other, but different from line assignments of people in other departments. The administrator can also assign personal lines so that no one else in the system has access to them. (See “Personal Lines.”)

## CONSIDERATIONS

If a person in a system with Customized Line Assignments does not have a particular line assigned to his or her voice terminal, he or she can pick up a ringing call on that line by using the Call Pickup feature. (See “Call Pickup.”)

If two or more voice terminals in the system will have the same line assignments, the administrator can use the Copy feature to copy the line assignments from one voice terminal to another. (See “Copy.”)

A line jack with nothing plugged into it is called a nonequipped line appearance, or “ghost line.” To eliminate ghost lines, the administrator must specify how many lines the system contains by using the administration procedure below.

## ADMINISTRATION

If your responsibilities do not include system administration, skip this information.

### Specifying the Number of Lines in Your System

When the administrator first sets up the system, he or she must specify the number of lines in the system.

- 1 Enter administration mode by sliding the T/P switch to *P* and touching **Administer**.
- 2 Dial \*4.
- 3 Dial a number (1 through 8) that corresponds with the number of lines in your MERLIN Plus system.

For example, if the system contains six lines, the administrator dials \*4 and then 6 or \*46.

- 4 Touch **Administer**.  
*The console beeps twice.*
- 5 Leave administration mode by sliding the T/P switch to the center position.

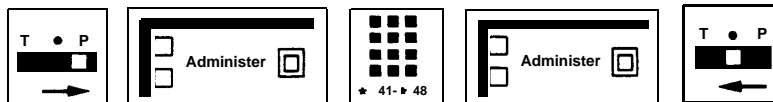

---

### Assigning Lines to Voice Terminals

Before you assign lines to voice terminals in your system, refer to the Line Assignments Form that you have filled out.

To assign lines to a voice terminal:

- 1 Enter administration mode by sliding the T/P switch to *P* and touching **Administer**.
- 2 Touch the Auto Intercom button or dial the intercom number for the voice terminal that you are administering.  
*A green light goes on next to the Auto Intercom button. Green lights also go on next to the buttons of any lines already assigned to the voice terminal.*
- 3 Touch all of the line buttons that have a light next to them.  
*The green light next to each line button goes off.*
- 4 Touch all the line buttons again, this time in the order that you want them to appear on the voice terminal. If you want to reserve a button(s) for feature programming, touch that button(s) last.  
*Green lights go on next to the line buttons you touch.*
- 5 Touch **Administer**.  
*The console beeps twice.*
- 6 If you reserved a button(s) for feature programming:
  - > Touch the button(s) that you want to be used for feature programming again.  
*Green light goes off next to the button you touch.*
- 7 Leave administration mode by sliding the T/P switch to the center position.

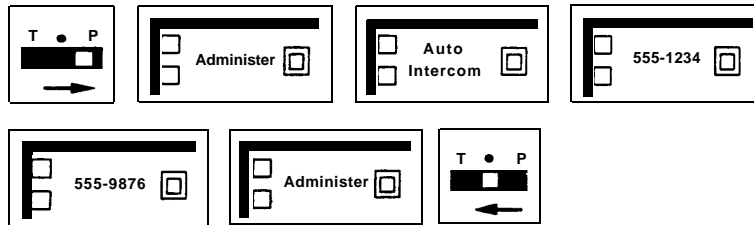

### PROGRAMMING

None

### HOW TO USE

The system administrator assigns lines to buttons for the whole system and for individual voice terminals. Be sure that the lines that you have access to are labeled on your voice terminal.



---

## Direct Extension Dialing (DXD)

**NOTE:** Direct Extension Dialing (DXD) is an ASA feature and therefore requires assignment of an ASA jack. If the ASA jack assignment has not yet been made, refer to “Automatic System Access” in this section before attempting to administer this feature.

### DESCRIPTION

When you put the system in DXD mode, the control unit acts like an automated attendant. Incoming calls on designated lines are connected to the Voice Synthesis Processor (VSP) for the following message prompt:

*“Please dial desired extension number.”*

When the caller dials the extension number (the 2-digit intercom number), the control unit transfers the call to that extension and the caller hears the following message:

*“Please hold.”*

You can also modify the voice message, so that callers first hear the number they’ve reached, followed by the request for the extension number:

*“You have reached [number]. Please dial desired extension number.”*

### CONSIDERATIONS

Direct Extension Dialing requires the following:

- A programmed button (with green and red lights) labeled **CF/DXD**

You use the CF/DXD button to activate either Call Forwarding or Direct Extension Dialing. To put the system in either of these modes, or in normal mode, you touch the CF/DXD button. The green and red lights show you what mode you’re in.

- > If the system is in normal mode touch the button *once* to put the system in DXD mode.

*Green and red lights off = Normal mode*

*Only green light on = DXD mode*

*Green light flashing = Problem with DXD;*

*call your system administrator*

*Only red light on = CF mode*

- > Touch the button *three times* to put the system back into normal mode (both the green and red lights are off).

- A synthesized voice message

This message is automatically supplied by the VSP in the control unit.

The administrator can modify the message to add the telephone number that the callers have contacted.

- 
- That one jack on the control unit be dedicated to the ASA features

At startup, jack number 18 is automatically designated as the ASA jack. An Auto Access cord that you plug into this jack is connected to the memory module which houses the VSP. If you want to change this jack assignment, follow the simple administration procedure discussed under “Automatic System Access” earlier in this section.

- Its own incoming line group.

The feature’s operation includes only calls coming in on lines assigned to the DXD incoming line group. Calls coming in on lines not in the DXD incoming line group are not answered by the DXD feature. At startup, no lines are assigned to the DXD incoming line group. There’s a simple procedure (discussed under “Administration”) for changing the makeup of the DXD incoming line group.

CF and DXD are mutually exclusive modes: the system cannot be in both modes at the same time.

Direct Extension Dialing cannot be used with the MERLIN Attendant.

There can be more than one CF/DXD button in the system, but there can be only one CF/DXD button on a voice terminal. If two or more users have a CF/DXD button programmed on their voice terminals, each of them can turn the features on and off. For example, if one of these users activates the Direct Extension Dialing feature, the green light goes on next to the CF/DXD buttons on all the voice terminals that have a button for the feature. When the person deactivates the feature by touching the CF/DXD button, the light goes off next to the button at all the voice terminals that have programmed the CF/DXD features.

You should consider having a Transfer Return Interval if you plan to use DXD. (See “Transfer Return Interval.”) Depending on the incoming call traffic, you may also want to designate an alternate attendant position to handle all returning ASA calls, (See “Alternate Attendant.”)

When a caller responds to the voice prompt by entering an intercom number, the control unit uses the system’s transfer feature to transfer the call to the voice terminal with that intercom number. If the call goes unanswered at the destination voice terminal and there is an administered Transfer Return Interval, the call is transferred to the administrator/attendant or the alternate attendant console when the interval expires.

If the system is administered for *no* return of transferred calls, the call continues to ring at the destination voice terminal until the caller hangs up.

If a compatible audio-source is available, Music-On-Hold is recommended for DXD, so that the caller can hear music while waiting. See “Music-On-Hold” under “Accessory Equipment” later in this section.

If the system is in both DXD and Remote Line Access modes and the lines overlap, DXD takes precedence.

## ADMINISTRATION

If your responsibilities do not include system administration, skip this information.

### DXD Line Groups

At startup, *none* of the system's outside lines are assigned to each ASA line group. You need to assign which lines you want to designate for DXD.

- 1 Enter administration mode by sliding the T/P switch to *P* and touching **Administer**.
- 2 Dial \*58 for a DXD incoming line group.
- 3 Touch the line buttons until the green lights show the makeup you want for the line group.

*Green light on = line is assigned to the group*  
*Green light off = line is not assigned to the group*

- 4 Touch **Administer**.  
*The console beeps twice.*
- 5 Leave administration mode by sliding the T/P switch to the center position.

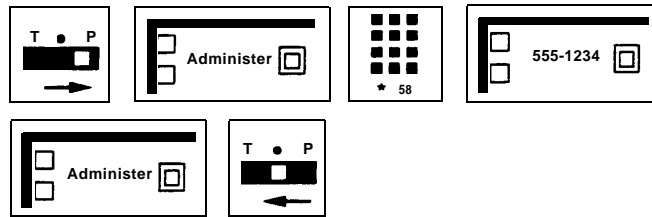

### Number of Rings

To change the number of rings (the default is two rings) before the DXD call is answered:

- 1 Slide the T/P switch to *P* and touch **Administer**.
- 2 Dial \*761 plus the number of rings (between 0 and 9) before call is picked up.

**NOTE:** If the number of rings is set to 0, the voice terminal will not ring, and the calls will be answered immediately.

- 3 Touch **Administer**.  
*The console beeps twice.*
- 4 Leave administration mode by sliding the T/P switch to the center position.

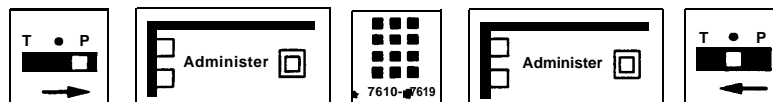

---

You can modify this message to include the following statement:

*“You have reached nnn...”*

where *nnn...* is the telephone number of one of your outside lines. The number can be up to 16 digits, including \* or #. You can modify the message for all lines in an incoming line group, or you can modify the message for some and leave others unmodified. To modify the DXD message for one or more lines in your incoming line groups, do the following:

- 1 Enter administration mode by sliding the T/P switch to *P* and touching **Administer**.
- 2 Dial \*50.
- 3 Touch the line button for the line on which you want the modified message.  
*The green light goes on.*
- 4 Dial the telephone number you want to include in the message.

**NOTE:** For special phone numbers, such as an 800 number, you may prefer to have the recorded voice say “Eight hundred” followed by the number, instead of “Eight, zero, zero.” In this case, you would touch **Hold** to enter a pause after the toll prefix, then again after the 800 area code, and again after the exchange. For example, 1-800-555-1212 would be entered as follows:

1 **Hold** 800 **Hold** 555 **Hold** 1212

- 5 Repeat for other lines.
- 6 Touch **Administer**.  
*The console beeps twice.*
- 7 Leave administration mode by sliding the T/P switch to the center position.

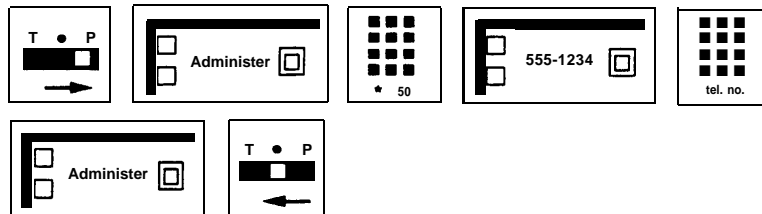

---

## PROGRAMMING

A button with a red and green light next to it is required for the DXD features.

To program a CF/DXD button on a voice terminal:

1 Label the button **CF/DXD**.

2 Slide the T/P switch to *P*.

*The voice terminal rings every 5 seconds to remind you that you're programming and that you can't place or receive calls.*

3 Touch the button you want to program.

4 Dial \*83.

5 Slide the T/P switch to the center position.

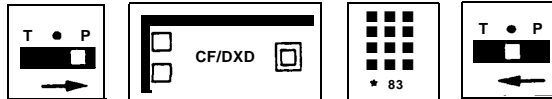

## HOW TO USE

### Using the CF/DXD Button

Touching the CF/DXD button repeatedly cycles the system through DXD, CF, and normal modes. The red and green lights next to the CF/DXD button will help you recognize which mode the system is in.

*Green and red light off = Normal mode*

*Only green light on = DXD mode*

*Only red light on = CF mode*

---

## Disallowed List

### DESCRIPTION

Most businesses find it inappropriate for their employees to make billable calls to numbers such as those beginning with the “976” exchange or the “900” area code, for services such as, comedy, weather, sports, lottery, and chatlines. The Disallowed List feature enables you to deny access to up to 20 area codes, exchanges, and entire numbers, even on unrestricted lines.

If a voice terminal has been assigned a disallowed number, any attempt to dial that number will not go through. As soon as the dialed digits match any complete disallowed number, dialing is blocked. The only exception to this is if a System Speed Dial number with Restriction override matches a number on the Disallowed List, the number will go through. (see “System Speed Dial” for more details.)

### CONSIDERATIONS

The Disallowed List can contain 20 numbers up to 16 digits each. This allows you to deny access to virtually any number combination, including area code/exchange, and foreign numbers. You can enter “wild card” digits (which are pauses in the administration procedure) by touching the Hold button. The pauses can be used to represent any area code or combination you require. For example, to prevent calls to the “976” exchange in any state, the disallowed number would be entered as 1 **Hold Hold Hold** 976 or 0 **Hold Hold Hold** 976.

You cannot dial a number on an Allowed List if it matches a number on the Disallowed List. For example, if 976-3535 is on the Allowed List, but the 976 exchange is on the Disallowed List, the number will not go through.

### ADMINISTRATION

If your responsibilities do not include system administration, skip this information.

As you administer a Disallowed List to your system, refer to the Disallowed List Form you completed in Section 2.

To setup a Disallowed List:

- 1 Slide the T/P switch to *P* and touch **Administer**.
- 2 Dial \*09 followed by the Disallowed List code (01 to 20).
- 3 Dial the disallowed number (up to 16 digits). If the number includes wild card digits, touch **Hold** once for each wild card digit.
- 4 Touch **Administer**.  
*The console beeps twice.*
- 5 Leave administration mode by sliding the T/P switch to the center position.

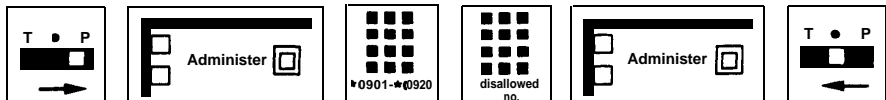

To assign Disallowed List to voice terminals:

- 1 Slide the T/P switch to *P* and touch **Administer**.
- 2 Dial \*0900.
- 3 Touch the Auto Intercom button or dial the appropriate code from the table below for the voice terminal you want to assign the Disallowed List. If you want to prevent all voice terminals in the system from dialing the number, touch **Conference**. To remove all voice terminals from a disallowed number assignment, touch **Drop**.

*Green light on = Disallowed List assigned.  
Green light off = Disallowed List not assigned.*

<b>If the intercom number is:</b>	<b>Dial this code:</b>	<b>If the intercom number is:</b>	<b>Dial this code:</b>
Intercom 10	#22	Intercom 20	#03
Intercom 11	#21	Intercom 21	#04
Intercom 12	#20	Intercom 22	#05
Intercom 13	#19	Intercom 23	#06
Intercom 14	#18	Intercom 24	#07
Intercom 15	#17	Intercom 25	#08
Intercom 16	#16	Intercom 26	#09
Intercom 17	#15	Intercom 27	#10
Intercom 18	#14	Intercom 28	#11
Intercom 19	#13	Intercom 29	#12

- 4 Touch **Administer**.  
*The console beeps twice.*
- 5 Leave administration mode by sliding the T/P switch to the center position.

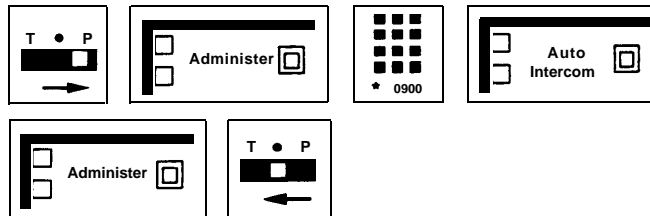

---

To remove a number from a Disallowed List:

- 1 Slide the T/P switch to *P* and touch **Administer**.
- 2 Dial \*09 followed by the Disallowed List code (01-20) that you want to remove.
- 3 Touch **Administer**.
- 4 Leave administration mode by sliding the T/P switch to the center position.

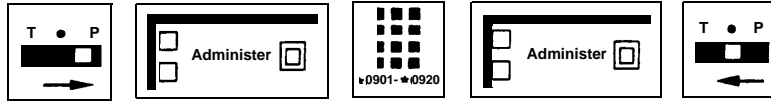

**PROGRAMMING**

None

**HOW TO USE**

None



# Display Unit

## DESCRIPTION

Some 34-Button speakerphone voice terminals, namely, the BIS-34D and the 34-Button (SP-34D) voice terminal with display, are equipped with a display unit. You can also purchase one separately and add it later to a 34-Button (SP-34) voice terminal. To order the Display Unit, call the AT&T National Sales Parts Center's tollfree number, 1-800-222-PART, and ask for order number 105400030 (for black BIS-34 voice terminals).

The display provides information that helps you handle calls and program your voice terminal more easily. For example, when you dial a number or touch an Auto Intercom button, or when you receive an intercom call or a returned transfer call, the number associated with the call appears on the display screen. When you are programming a button, the display unit can help you check if the button has a feature already programmed onto it. If you have not yet programmed a feature on the button, the word "blank" appears on the display screen.

**FIGURE 5-2 Operating Display Unit Timekeeping Features.**

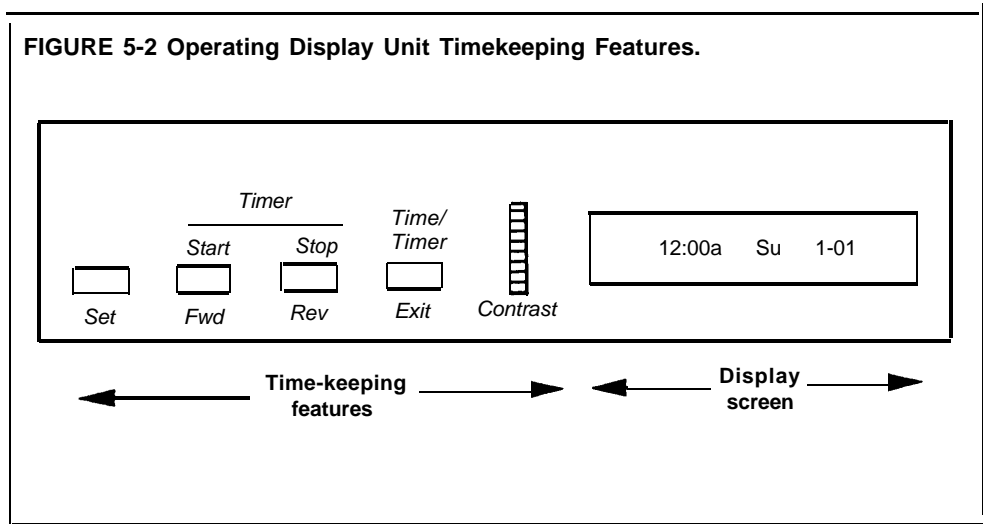

## CONSIDERATIONS

You can also use the display unit for providing an alarm, timing calls that you place or receive, and displaying the time, day, and the date. See Figure 5-2.

To adjust the clarity of the display screen characters, turn the contrast thumbwheel until the numbers and letters are clear.

Only the numbers for incoming intercom calls are displayed on the screen; the display unit does not show the identification of incoming calls from outside the system.

When the display is idle, the screen shows the time, day, and date.

The information appears on the screen for a maximum of 10 seconds. If you disconnect a call or touch another display option button, such as the Time/Timer button, before the 10 seconds are over, the display is replaced with the time/date display.

Dial the numbers and characters of your calls slowly so that the display unit can place them correctly on the screen.

---

**ADMINISTRATION**

None

**PROGRAMMING**

None

**HOW TO USE**

To use the four features associated with the display unit, follow the instructions on the next few pages.

**Received Call ID**

When you receive an intercom call, the 2-digit intercom number of the person calling you appears on the screen, as shown below.

23 -On Intercom

When you transfer a call to another voice terminal and the call is unanswered, the call returns to your voice terminal. The 2-digit intercom number of the voice terminal from which the call is returning appears on the screen.

Trans Return -18

**Program Mode**

When you begin programming, the display tells you that you are in the program mode and the intercom number of your voice terminal you are programming.

Program Mode 16

If you touch a button that has already been programmed, the display identifies the name of the feature on that button. The example below shows that the Last Number Redial feature has been programmed on the button you have touched.

Last Number

If the button has not been programmed, the message below appears on your display screen.

Blank

---

If you touch a preassigned, or nonprogrammable button, such as **Conference** or **Hold**, the following message appears on the display screen:

Not Programmable

or

Error

**NOTE:** You *can* use nonprogrammable buttons, such as **Hold** or **Recall** to enter a special character, such as a pause or a stop, into a dialing sequence.

### Number Dialed

When you dial outside, intercom, or account numbers, or touch a button that contain numbers, such as an Outside Auto Dial, Auto Intercom, Last Number Redial, or Saved Number Redial button, the digits associated with that button are printed on the display screen.

5551234

The combined display screens in the Display Number Dialed feature can contain up to 16 digits. (It does *not* set the time and date for the Call Report and System Feature Report features.)

### Time-Keeping Features

The time-keeping features of the display unit allow you to set an alarm, clock, calendar, and timer.

#### • Setting the Clock and Calendar

Clock/calendar display screen

12:01a Su 1-01 

Alarm on indicator

◀ Clock ▶    ◀ Calendar ▶

To set the time, day, and date on the display screen:

- a Press **Set** until the item you want to change flashes.
- b Press **Fwd** or **Rev** to advance or reverse the time, day or date.
- c When you are finished, press **Exit**.

---

- **Setting the Alarm**

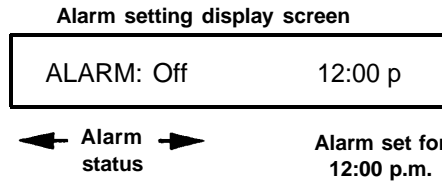

To set the alarm (for example, when you want a reminder that you have a meeting in five minutes):

- a Press **Set** until the item you want to change flashes.
- b Press **Fwd** or **Rev** to advance or reverse the time until the display shows the time you want the alarm to sound.
- c When you are finished, press **Exit**.

- **Operating the Timer**

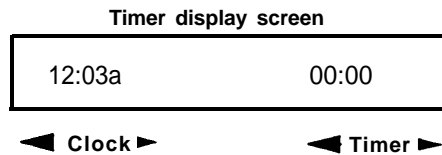

To operate the timer for calls you need to time:

- a Press **Time/Timer** (to display timer).
- b Press **Timer Start** to turn the timer to 00:00 and start it.
- c When you are finished using the timer, press **Timer Stop**.

When you want to return to the Clock/Calendar display, which shows the time, day, and date:

- Press **Time/Timer**.

When you want to return to the call handling display:

- Press **Time/Timer**.

---

## Do Not Disturb (DND)

### DESCRIPTION

When you are busy and do not want to receive calls, you can touch the Do Not Disturb button, if you have programmed one onto your voice terminal. When you receive outside calls, the green light next to the line button flashes, but your voice terminal does not ring.

Calls transferred to you return to the sender, and intercom calls get a busy signal.

When you activate the Do Not Disturb at your voice terminal, the green light goes on next to your Auto Intercom button at other people's voice terminals.

Calls you transfer will return to you if they are unanswered.

### CONSIDERATIONS

None

### ADMINISTRATION

None

### PROGRAMMING

The Do Not Disturb feature requires a button with lights.

To program a Do Not Disturb button for your voice terminal:

- 1 Label the button **Do Not Disturb**.
- 2 Slide the T/P switch to *P*.  
*The voice terminal rings every 5 seconds to remind you that you are programming and that you cannot place or receive calls.*
- 3 Touch the button you want to program.
- 4 Dial \*71.
- 5 Slide the T/P switch to the center position.

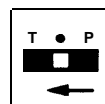
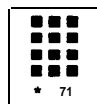
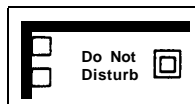
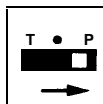

---

## HOW TO USE

To prevent calls from ringing at your voice terminal:

**1 Touch Do Not Disturb.**

*The green light next to the button goes on.*

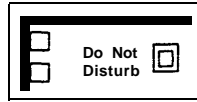

This feature remains active until you:

**1 Touch Do Not Disturb again.**

*The green light next to the button goes off.*

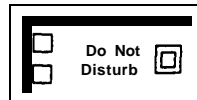

---

# Drop

## DESCRIPTION

If you get a busy signal or no answer as you setup a conference call, or if you want to disconnect one outside line at a time from a conference call, use the Drop feature For more information about using this feature, see “Conference.”

## CONSIDERATIONS

If you press the switchhook, you may disconnect everyone on the conference call.

In order for a person within the MERLIN Plus system to be disconnected from the conference, he or she must hang up.

## ADMINISTRATION

None

## PROGRAMMING

None

## HOW TO USE

To disconnect one outside line at a time from a conference call:

- 1 Touch **Drop**.
- 2 Touch the button of the line you want to disconnect.

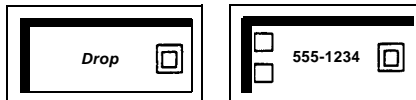

---

## Group Listening

**DESCRIPTION** If you want other people in your office to hear a call, you can turn on your voice terminal speaker. Everyone can then hear the voice of the other person on the call without that person being aware that the call is on a speaker.

**CONSIDERATIONS** This feature is not available on the BIS model voice terminals.  
Your speaker may make a squealing noise when the handset comes close to it. To prevent this noise, touch **Speaker** when you have completed a call and are ready to hang up your handset. Another way to reduce the squealing sound is to turn down the volume control on your voice terminal.

**ADMINISTRATION** None

**PROGRAMMING** None

**HOW TO USE** To allow others to hear a call:  
1 Without hanging up, touch **Speaker** and continue your conversation.





---

## Group Page

### DESCRIPTION

The system administrator can set up Group Page groups so anyone in the system can use the Group Page feature to page up to 20 people at a time directly through the voice terminal speakers.

You can have up to three paging groups. The Page-All group consists of all voice terminals in the system; groups 1 and 2 can have up to 20 voice terminals in each group.

### CONSIDERATIONS

If necessary, one voice terminal can be assigned to more than one paging group.

You can program buttons for the groups you want to page. Or, you can save available feature buttons for other uses and use a dial code for this feature.

If someone in the Group Page group picks up the handset during a Group Page announcement, he or she is connected to the person making the announcement, and the page announcement is terminated.

When someone in the MERLIN Plus system has activated the Voice Announcement Disable feature for his or her voice terminal, he or she cannot hear a Group Page announcement.

### ADMINISTRATION

If your responsibilities do not include system administration, skip this information.

When the system is first set up, the system has the following Group Page groups:

- Group 1 = voice terminals 10 through 19
- Group 2 = voice terminals 20 through 29
- Page-All = voice terminals 10 through 29

If these group assignments are not satisfactory for the system, the administrator can add or delete voice terminals from the individual groups.

The Page-All group, the paging group containing all the voice terminals in the system, *cannot* be administered.

Before you begin to administer Group Page groups, refer to “Paging Groups” on your “System Configuration Form.” Then use one of the following procedures to add or remove a voice terminal from a paging group:

To administer the Group Page feature, follow this procedure:

- 1 Enter administration mode by sliding the T/P switch to *P* and touching **Administer**.

- 2 Dial \*71 for group 1 or \*72 for group 2.

*A green light goes on next to the Auto Intercom button, if you have one, of any voice terminal already assigned to that paging group.*

3 Perform the appropriate procedure:

- > Touch the appropriate Auto Intercom button(s) until the green light beside it shows the paging group assignment you prefer.

*Green light on = voice terminal is assigned to the group*  
*Green light off = voice terminal is not assigned to the group*

- > If you do not have an Auto Intercom button for the voice terminal you want to add or remove from the paging group, dial a code from the chart below that corresponds with the voice terminal.

If the intercom number is:	Dial this code:	If the intercom number is:	Dial this code:
Intercom 10	#22	Intercom 20	#03
Intercom 11	#21	Intercom 21	#04
Intercom 12	#20	Intercom 22	#05
Intercom 13	#19	Intercom 23	#06
Intercom 14	#18	Intercom 24	#07
Intercom 15	#17	Intercom 25	#08
Intercom 16	#16	Intercom 26	#09
Intercom 17	#15	Intercom 27	#10
Intercom 18	#14	Intercom 28	#11
Intercom 19	#13	Intercom 29	#12

4 Touch **Administer**.

*The console beeps twice.*

5 Follow steps 2 through 4 for each paging group you want to administer.

6 Leave administration mode by sliding the T/P switch to the center position.

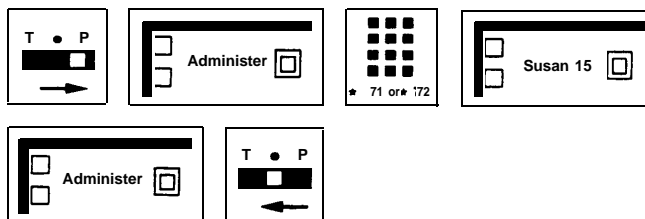

If you want to clear all entries from group 1 or from group 2:

- 1 Enter administration mode by sliding the T/P switch to *P* and touching **Administer**.
- 2 Dial \*71 for group 1 or \*72 for group 2.
- 3 Touch **Drop**.

**4 Touch Administer.**

*The console beeps twice.*

**5 Leave administration mode by sliding the T/P switch to the center position.**

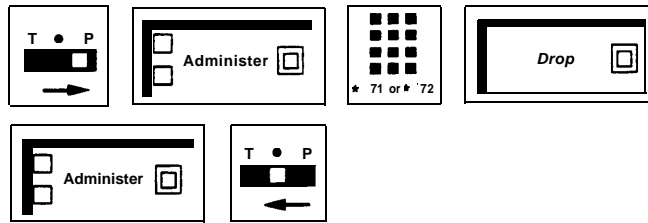

**PROGRAMMING**

To program a Group Page button for your voice terminal:

**1 Label the button Group Page plus a group number.**

**2 Slide the T/P switch to P.**

*The voice terminal rings every 5 seconds to remind you that you are programming and that you cannot place or receive calls.*

**3 Touch the button you want to program.**

**4 Dial \*91 plus a Group Page code:**

70 = Page-All (all voice terminals in the system)

71 = group 1

72 = group 2

**5 Slide the T/P switch to the center position.**

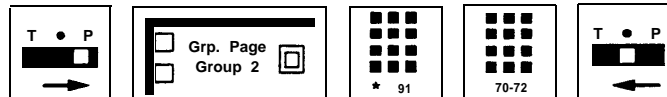

**HOW TO USE**

You can use a programmed button or a dial code to access this feature.

To use a Group Page button to make an announcement through a group of voice terminal speakers:

**1 Touch the Group Page button for the group you want to page.**

**2 When you hear a beep, lift your handset and make the announcement.**

**NOTE:** If you don't lift your handset to make the announcement and another BIS terminal is nearby, you may hear a loud squeal from your voice terminal.

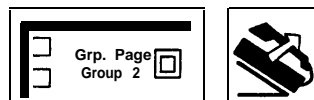

---

To page a group using a dial code:

- 1 Touch **Intercom**.
- 2 Touch **Speakerphone** or lift your handset.
- 3 Dial the code for the group you want to page:
  - 70 = Page-All (all voice terminals in the system)
  - 71 = group 1
  - 72 = group 2
- 4 When you hear a beep, begin speaking.

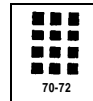

---

## Hands-Free Answer on Intercom (HFAI)

### DESCRIPTION

If you are using a voice terminal that has a Hands-Free Answer on Intercom (HFAI) button on it, without lifting your handset, you can touch the HFAI or HFAI/Mic button when you want to answer intercom calls hands free. You will hear the other person's voice through your voice terminal speaker.

### CONSIDERATIONS

The HFAI feature can only be used for intercom calls, not outside calls. It is not for use with group paging calls. When you turn on the HFAI feature, the green light next to the button goes on. For optimal use of the HFAI feature and speakerphone voice terminals, follow these guidelines:

- Place the voice terminal in an area with low background noise.  
Room acoustics and background noise may affect the proper operation of your voice terminal's speakerphone. High background noise is caused by loud voices and loud electronic devices (radios, typewrite, etc.).
- Keep the area near the microphone free of books and papers.
- Let one person talk at a time. When both parties speak at the same time, transmission can be broken.
- Always face your terminal when talking.
- Place your voice terminal at least six inches away from the edge of the desk or table upon which it rests.  
**NOTE:** If you are having difficulty hearing the other person, increase the speaker's volume level. (Refer to CIB 3078, "Adjusting the Volume Control Switch on Your Voice Terminal" for further information.)
- Certain conditions may cause difficulty with the speakerphone to persist. If raising the volume level on the speaker does not help, (see **NOTE** above), lift the handset to continue the conversation.

If you use the Voice Announcement Disable feature on a voice terminal with HFAI, you deactivate the HFAI feature.

### ADMINISTRATION

None

### PROGRAMMING

None

---

## HOW TO USE

If you have a HFAI button on your voice terminal and you want your intercom calls answered automatically:

**1 Touch HFAI or touch HFAI/Mic.**

*The green light flashes on BIS-10 and 10-Button HFAI models when active on a call and remains steady on all other BIS models.*

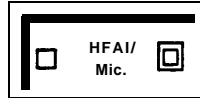

---

# Hold

## DESCRIPTION

When you need to put someone on hold, use the Hold feature.

## CONSIDERATIONS

Before placing an intercom call on hold that has been answered using the HFAI feature, lift the handset or the call will be disconnected.

When you leave a call on hold for more than a minute, your voice terminal rings at one minute intervals to remind you the call is still on hold.

You can program an Exclusive Hold button so that no other voice terminal can pick up a call you've put on hold. For more information about the Exclusive Hold feature, see the entry for "Hold-Exclusive" in this section.

If a caller placed on hold hangs up, the system will automatically drop the line. If the light continues to flash after a caller has hung up, the Hold Disconnect Interval may be too long (450 milliseconds) for the local telephone company to detect. See "Hold Disconnect Interval" for information to correct this problem.

## ADMINISTRATION

None

## PROGRAMMING

None

## HOW TO USE

To place a call on hold:

- 1 If the call was answered using the HFAI feature, lift the handset.
- 2 Touch **Hold**.



When you put a call on hold, the green light next to the call's line button *flashes rapidly*. If *someone else* puts a call on hold from another voice terminal, the green light *flashes slowly* next to the call's line button on your voice terminal.

To take a call off hold:

- 1 Touch the call's line button.  
*The green light becomes steady.*

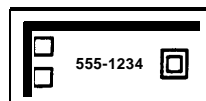

---

## Hold Disconnect Interval

### DESCRIPTION

Telephone company central offices use either a “short” (50 millisecond) or a “long” (450 millisecond) disconnect interval. Because most switching systems use long interval, your MERLIN Plus system is factory-set for a long interval. If your telephone company uses a short interval, or if your MERLIN Plus system has been reprogrammed, the disconnect interval for your system may cause problems with held calls.

### CONSIDERATIONS

If your system has either of the following problems, the system administrator must change the Hold Disconnect Interval:

- If a caller waiting on hold is disconnected, the disconnect interval setting of your MERLIN Plus system is shorter than the setting at your local telephone company’s central office.
- If a caller waiting on hold hangs up, but the light next to that line continues to flash as if the call was still on hold, the disconnect interval setting of your MERLIN Plus system is longer than the setting at your local telephone company’s central office.

You can perform a quick test to see if you need to change the interval from 450 milliseconds to 50 milliseconds. Make an outside call to someone who would be willing to help you for a few minutes. Ask them to hang up the phone ten seconds after you put them on hold. When they’re ready, put the call on hold. If the call is not dropped within a few minutes, the Hold Disconnect Interval needs to be administered to 50 milliseconds.

### ADMINISTRATION

If your responsibilities do not include system administration, skip this information.

To change the disconnect interval of your MERLIN Plus system to match the central office disconnect interval:

- 1 Enter administration mode by sliding the T/P switch to *P* and touching **Administer**.
- 2 Dial the 3-character code \*69.
- 3 Touch each line button to change its disconnect interval. Each touch of the button gives you one of the following codes:

*Steady green light on = line has long disconnect interval*  
*Green light off = line has short disconnect interval*



---

4 Touch **Administer**.

5 Leave administration mode by sliding the T/P switch to the center position.

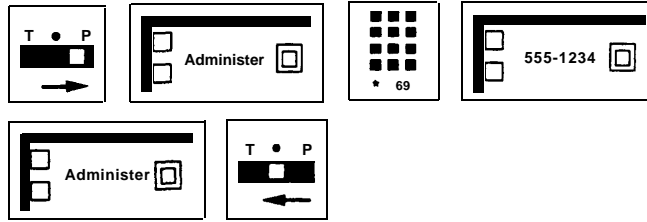

**PROGRAMMING**

None

**HOW TO USE**

None

---

## Hold-Exclusive

### DESCRIPTION

By programming the Exclusive Hold feature onto a button, you can put an outside caller on Exclusive Hold, which means that no one else at another voice terminal in the system can pick up the held call.

### CONSIDERATIONS

This feature must be programmed on a button with a green light.

To place a call on normal hold, after it's been placed on Exclusive Hold, or vice versa, you must reconnect with the caller before touching the hold button.

When you leave a call on Exclusive Hold for more than one minute, your voice terminal rings at one minute intervals to remind you that the call is on hold.

### ADMINISTRATION

None

### PROGRAMMING

You need a button with a green light to program an Exclusive Hold button:

- 1 Label the button "Exclusive Hold."
- 2 Slide the T/P switch to *P*.  
*The voice terminal rings every five seconds to remind you that you are programming and you cannot place or receive calls.*
- 3 Touch **Exclusive Hold**.
- 4 Dial \*77.
- 5 Slide the T/P switch to the center position.



### HOW TO USE

To put an outside call on hold so no one else in the system can pickup the call:

- 1 Touch **Exclusive Hold**.  
*The green light next to the line button of the held call flashes rapidly to remind you that the call is on hold.*
- 2 If a call has been on Exclusive Hold for more than a minute, your voice terminal will ring once every minute to remind you that the call is waiting.

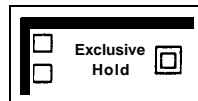

---

To pick up the call that you have put on Exclusive Hold.

- 1 Touch the line button of the held call.

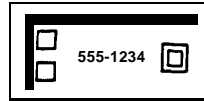

To place a call on normal hold after it's been placed on Exclusive Hold:

- 1 Touch the line button of the held call.
- 2 Touch **Hold**.

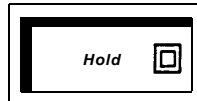
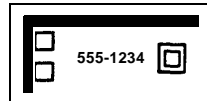

---

## Hold Retrieve

### DESCRIPTION

If you do not have a line button for a call that you have received or that has been transferred to you, you can still put it on hold using the Hold button. However, to retrieve the call, you must use a dial code or program a Retrieve Call button.

### CONSIDERATIONS

To use this feature, you can either program a button or use a dial code.

This feature is especially useful for 5-Button voice terminals that may not have line buttons for every incoming or transferred call.

If your system administrator has set your voice terminal for Button-Free Line Operation, you should have a Hold Retrieve button on your voice terminal, so that you can put calls on hold and retrieve them later. (See “Button-Free Line Operation.”)

### ADMINISTRATION

None

### PROGRAMMING

To program a Hold Retrieve button for your voice terminal:

- 1 Label the button **Retrieve Call**.
- 2 Slide the T/P switch to *P*.  
*The voice terminal rings every 5 seconds to remind you that you are programming and that you cannot place or receive calls.*
- 3 Touch the button you want to program.
- 4 Dial \*95\*.
- 5 Slide the T/P switch to the center position.

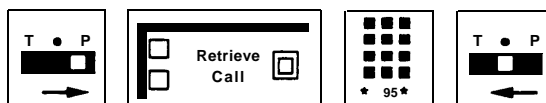

### HOW TO USE

You can use a programmed button or a dial code to access this feature.

To put a call on hold:

- 1 Touch **Hold**.

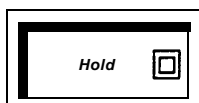

---

You can use a programmed button or a dial code for the Hold Retrieve feature.  
To use a Retrieve Call button to retrieve a held call:

- 1 Touch **Retrieve Call**.

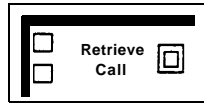

To use a dial code to retrieve a held call:

- 1 Dial **#\***.

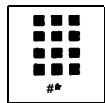

---

## Intercom

### DESCRIPTION

Each voice terminal connected to the MERLIN Plus system has a unique 2-digit intercom number. You can dial intercom numbers to place calls to people connected to the system.

### CONSIDERATIONS

In the MERLIN Plus system, you place an intercom call with a voice announcement. Your co-worker hears your voice through the voice terminal speaker, and can either touch **Speakerphone** or lift the handset to respond to you.

However, if the person you are calling has activated the Voice Announcement Disable feature, your intercom call rings rather than beeps at the person's voice terminal and you cannot give your voice announcement. (See "Voice Announcement Enable/Disable.")

If you program an Auto Intercom button for the intercom number you want to call, you can dial the number with one touch. (See "Auto Intercom.")

You cannot announce an intercom call to a person active on the voice terminal's speaker.

### ADMINISTRATION

None

### PROGRAMMING

None

### HOW TO USE

To place an intercom call with a voice announcement:

- 1 Touch **Intercom**.
- 2 Touch **Speakerphone** or lift your handset.
- 3 Dial the 2-digit intercom number for the voice terminal you want to call.
- 4 When you hear a beep, begin speaking.

*or*

If you hear ringing, wait for the person to answer.

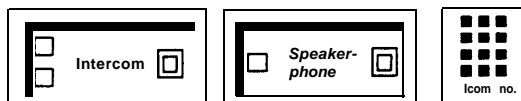

---

## Intercom Preference

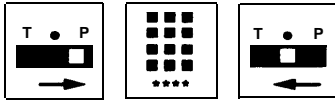
<b>DESCRIPTION</b>	Intercom Preference provides an intercom line immediately upon touching <b>Speakerphone</b> or lifting the handset.
<b>CONSIDERATIONS</b>	<p>If you are at a voice terminal that either has Intercom Preference or has no outside lines assigned to it, you will be connected to an intercom line when you touch <b>Speakerphone</b> or lift your handset.</p> <p><b>NOTE:</b> This feature does not remove access to outside lines from the voice terminal; outside lines can only be removed by the attendant at the attendant console during administration. If you want to <i>restrict</i> access to outside lines for a voice terminal located in a lobby or public area, you would have to administer this restriction. However, to provide the convenience of an intercom line immediately upon pickup, use Intercom Preference.</p>
<b>ADMINISTRATION</b>	None
<b>PROGRAMMING</b>	<p>To program Intercom Preference:</p> <ol style="list-style-type: none"><li>1 Slide the T/P switch to <i>P</i>.</li><li>2 Dial ****.</li><li>3 Slide the T/P switch to the center position.</li></ol> 
<b>HOW TO USE</b>	If the voice terminal you are using has been programmed for Intercom Preference, you will be connected to an intercom line when you either touch <b>Speakerphone</b> or lift your handset.

---

## Last Number Dial

### DESCRIPTION

With a Last Number Dial button, you can redial with one touch the number you dialed most recently. Each time you want this feature to redial a number, you must touch the programmed Last Number Dial button. You do not need to do anything to save this number.

### CONSIDERATIONS

You may also use the Busy Buster feature to redial the number you dialed most recently. The Busy Buster feature automatically redials the number you most recently dialed up to ten times at 60-second intervals. If someone answers the call within this time, your voice terminal alerts you. To use this feature, the system administrator must have assigned the feature to a voice terminal jack on the control unit. See “Busy Buster” earlier in this section for more information.

On BIS-10 and BIS-22 model voice terminals, the Personal Speed Dial code #24 is pre-programmed as the default for Last Number Dial. (See “Personal Speed Dial,” later in this section.)

The Last Number Dial can contain up to 16 digits.

The Last Number Dial feature saves manually dialed numbers and numbers dialed with an Outside Auto Dial button.

If you make frequent calls to a few numbers, it may be more convenient for you to use the Saved Number Dial feature to help you redial numbers correctly. (See “Saved Number Dial.”)

### ADMINISTRATION

None

### PROGRAMMING

To program a button on your voice terminal for the Last Number Dial feature:

- 1 Label the button **Last Number**.
- 2 Slide the T/P switch to *P*.  
*The voice terminal rings every 5 seconds to remind you that you are programming and that you cannot place or receive calls.*
- 3 Touch the button you want to program.
- 4 Dial \*73 (you do not need to dial an outside number).
- 5 Slide the T/P switch to the center position.

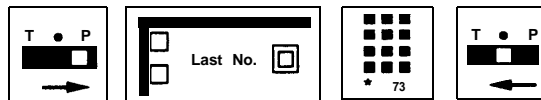



---

## HOW TO USE

You can use a programmed button or a dial code to access this feature.

If you are using the Last Number Dial feature, YOU can follow this procedure to have the system redial the last number you dialed:

- 1 Without touching **Speakerphone** or lifting your handset, touch **Last Number**, or dial #24 if you haven't reprogrammed this as a personal speed dial code.

*Your voice terminal speaker goes on, and you hear dialing.*

- 2 When you hear the other person answer, begin talking or lift your handset and begin talking.

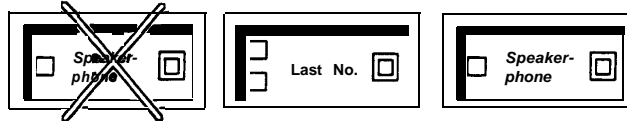

If the line is busy, or if no one answers:

- 1 Touch **Speakerphone** or hang up the handset to cancel the call.

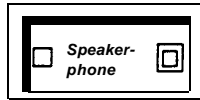

If later you want the system to redial the number, touch **Last Number**, or dial #24 again.

# Lights

## DESCRIPTION

The lights next to the line buttons on your MERLIN Plus system voice terminal give you immediate status of any of your lines. There is also a light next to the Message button, and, on most voice terminals, there is a light next to the Speakerphone button.

The lights next to the feature buttons on your voice terminal indicate the on/off status of the feature programmed on that button.

Lights	Line Status
Red light steady	This is either the line you are now using or the line you will get when you touch <b>Speakerphone</b> or lift your handset.
Green light steady	This line is busy or the feature is activated.
Green light flashing	This is the line on which a call is coming in.
Green light flashing rapidly	This is the line of a call <i>you</i> have put on hold.
Green light flashing slowly	This is the line of a call <i>someone else</i> has put on hold from another voice terminal.
Alternating flashing red and green lights on a line you are using	Someone in the system has bridged onto your call.
Green light on next to the Message button	This means that the attendant has a message waiting for you.
Green light on next to the Speakerphone button	This means that the voice terminal speaker is on. Without lifting the handset, you can begin dialing, or you can hear a conversation through the speaker.
Green light on next to the HFAI/Mic button on a BIS-10 or 10-Button HFAI voice terminal or next to the HFAI button on any other BIS or HFAI voice terminal	You can answer and speak to others on intercom calls without lifting your handset.
Green light on next to the Speakerphone and Microphone buttons on any BIS voice terminal	You can answer and speak to others on all calls without lifting your handset.
Green light on next to the Call Forwarding/Direct Extension Dialing (CF/DXD) button	The system is in DXD mode.
Red light on next to the CF/DXD button	The system is in CF mode
Green light on next to the Remote Line Access (RLA) button	The system is in RLA mode
Green light on next to the System Answer (SA) button.	The system is in SA mode.

---

**CONSIDERATIONS**            None

**ADMINISTRATION**            None

**PROGRAMMING**            None

**HOW TO USE**            None

---

## Line Request

### DESCRIPTION

If any or all the lines that appear on your voice terminal are busy, you can still request the use of one of these intercom or outside lines. When the line becomes available, the system alerts you.

### CONSIDERATIONS

If two or more people request the same line, the system places them in a queue according to the sequence in which the people requested the line. When the line is free, the system checks the queue, and the first person who requested the line is alerted.

If the line is not used within 10 seconds after the voice terminal has received the alert, the next voice terminal in the queue is alerted. This process is repeated until the queue is empty.

If the voice terminal is idle, the red light goes on next to the line that was requested. If the voice terminal is busy, the red light does not go on next to that line.

The Line Request feature does not reserve a line. Anyone in the MERLIN Plus system who has the line appearance can use the line when it is free.

### ADMINISTRATION

None

### PROGRAMMING

None

### HOW TO USE

To request an intercom or outside line that is presently busy:

- 1 Touch the intercom or outside line button of the line you want to use.  
*The red light goes on next to the line button you requested.*
- 2 The MERLIN Plus system signals you with a beep when the line becomes free.

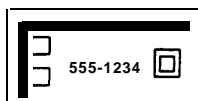

---

## Line Select

**DESCRIPTION** You may need to make an outside call at a time when you also need to leave your primary line open for incoming calls. If your voice terminal has more than one outside line, you can select a line other than your primary line for an outside call.

**CONSIDERATIONS** None

**ADMINISTRATION** None

**PROGRAMMING** None

**HOW TO USE** To select a specific outside line:

- 1 Touch the button for the specific outside line you want to use.  
*The red light goes on beside the line you select.*
- 2 Touch **Speakerphone** or lift your handset and dial.

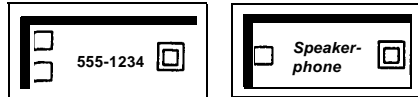

---

## Loudspeaker Paging

**NOTE:** This feature is used with an optional loudspeaker paging system and is compatible with paging systems with talkback. Refer to “Loudspeaker Paging System” under “Accessories” at the end of this section for more information.

### DESCRIPTION

If you have a Loudspeaker Paging System connected to the MERLIN Plus system, you can page people, make announcements, and provide background music (if available) throughout the building.

You have two options:

- 1 You can connect the loudspeaker paging system to the Page Jack on the front of the control unit.
- 2 You can connect the loudspeaker paging system to a CO (outside) line jack on a line module and administer that jack as a paging port.

### CONSIDERATIONS

Refer to “Loudspeaker Paging System” under “Accessories” at the end of this section.

### ADMINISTRATION

Refer to “Loudspeaker Paging System” under “Accessories” at the end of this section.

### PROGRAMMING

If your loudspeaker paging system is connected to the page jack on the control unit, you can program a loudspeaker paging button to use instead of a dial code whenever you want to page someone.

A button with lights is recommended for the Loudspeaker Page feature:

- 1 Label the button **Loudspeaker Page**.

- 2 Slide the T/P switch to *P*.

*The voice terminal rings every 5 seconds to remind you that you are programming and that you cannot place or receive calls.*

- 3 Touch **Loudspeaker Page**.

- 4 Dial \*91.

- 5 Dial 6.

- 6 Slide the T/P switch to the center position.

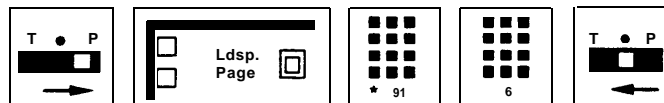

---

## HOW TO USE

If your loudspeaker paging system is connected to a CO line, follow this procedure:

- 1 Touch the loudspeaker page's line button.
- 2 Follow the instructions provided with your loudspeaker page system.

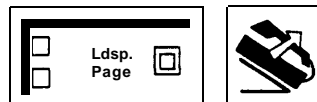

If your loudspeaker paging system is connected to the page jack on the control unit, you can use a programmed button or a dial code to access the Loudspeaker Page feature.

To use a Loudspeaker Page button:

- 1 Touch **Loudspeaker Page**.
- 2 When you hear the beep, lift your handset and make your announcement.

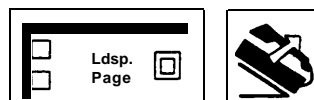

To use this feature by dialing a code:

- 1 Touch **Intercom**.
- 2 Lift your handset.
- 3 Dial 6.
- 4 When you hear a beep, make your announcement.

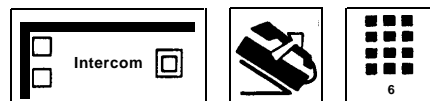

When you hang up, the loudspeaker turns off automatically.

---

# Manual Signaling

## DESCRIPTION

You can use a Manual Signaling button to generate a beep at a co-worker's voice terminal. Most often, this feature is used by a boss who wants to buzz his or her secretary. Assign a Manual Signaling button to each person you want to signal.

## CONSIDERATIONS

You can signal someone with a Manual Signaling button while you have an outside call in progress.

The beep sounds at your co-worker's voice terminal even if it is busy.

If you program this feature on a button with lights, the green light next to the button goes on when your co-worker uses his or her voice terminal or uses the Do Not Disturb feature.

You *cannot* have both a Manual Signaling button *and* an Auto Intercom button for the same person. If you try to program both, you deactivate the feature that you programmed earlier. You can use either feature to place an intercom call. (See "Auto Intercom.")

## ADMINISTRATION

None

## PROGRAMMING

To program a Manual Signaling button for your voice terminal:

- 1 Label the button **Signal** plus a name.
- 2 Slide the T/P switch to *P*.  
*The voice terminal rings every 5 seconds to remind you that you are programming and that you cannot place or receive calls.*
- 3 Touch the button you want to program.
- 4 Dial \*6 plus an intercom number.
- 5 Slide the T/P switch to the center position.

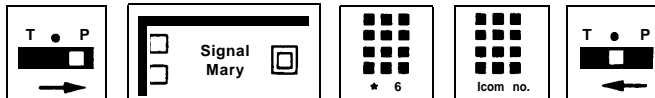



---

## HOW TO USE

To signal a co-worker:

- 1 Without lifting your handset, touch a Manual Signaling button.  
*The signal is heard as long as you continue to touch the button.*

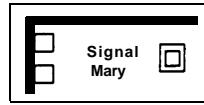

To place an intercom call using a Manual Signaling button:

- 1 Touch **Intercom**.
- 2 Touch **Speakerphone**.
- 3 Touch the Manual Signaling button for the person you want to call.
- 4 If you hear a beep, start talking (or lift your handset to speak). If you hear ringing, the voice signaling path is busy and the voice terminal is being alerted with the intercom ring.

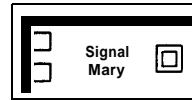
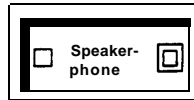
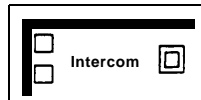

---

# Message

**DESCRIPTION** When the light next to the Message button is on, your MERLIN Plus system attendant has a message for you.

**CONSIDERATIONS** Your Message light can only be turned on from the administrator/attendant console.

If the attendant is using a BIS-22 and the system has more than 10 voice terminals, refer to “Send Message” for directions on sending a message to voice terminals in the system.

5-button voice terminals do not have a Message button.

**ADMINISTRATION** None

**PROGRAMMING** None

**HOW TO USE** The system attendant can touch **Message** to turn on the light next to the Message button at a person’s voice terminal.

- 1 At the administrator/attendant console, touch **Send Message**.
- 2 Touch the Auto Intercom button for the person’s voice terminal.

*The red light next to the Auto Intercom button goes on, indicating the person’s light is lit.*

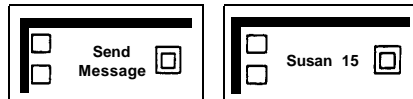

A person can turn off the Message light on his or her voice terminal. The system attendant can also turn off the light at a voice terminal by repeating the two steps above.

---

## Monitor-on-Hold

**DESCRIPTION** This feature is only for use with voice terminals that have a speaker button but *not* a speakerphone button. When someone puts your call on hold, you can turn on your voice terminal's built-in speaker, hang up, and continue working while you wait for the person to return to the call.

**CONSIDERATIONS** None

**ADMINISTRATION** None

**PROGRAMMING** None

**HOW TO USE** To turn on your speaker until you are taken off hold:

- 1 When you have been put on hold, touch **Speaker**.
- 2 Hang up.
- 3 When you hear the person return to the call, lift your handset and continue the call.  
*The speaker automatically turns off.*



---

## Night Service

### DESCRIPTION

When the person who usually answers calls leaves for the day, you can make answering calls after hours easy for night shift personnel and security guards by providing Night Service for your office. You can implement Night Service one of three ways:

- Provide the person with a voice terminal that has all the lines, or have the person monitor the attendant console and answer calls there. Be sure that all lines on which calls come in after hours are set for immediate ring. If the lines are not normally set for this ringing option, the person can activate the Ring Override feature that he or she has programmed for the voice terminal. (See “Ring Override.”)
- The backup person can also answer calls that come in after hours by programming a Call Pickup button so that he or she can pickup calls ringing at the administrator/attendant console. Since the attendant console has all the lines of your MERLIN Plus system, the person answering calls after hours can pick up calls at his or her voice terminal by touching the Call Pickup button when the attendant console rings. (See “Call Pickup.”) If the person is in another part of the building, the attendant can connect his or her console and an extra alert device to a Supplemental Alert Adapter (see “Supplemental Alert Adapter” under “Accessory Equipment”), so that each time a call comes in, an extra alert device sounds.
- You can also choose to administer and activate the Call Forwarding feature for after-hours use (see “Call Forwarding” in this section). When the system is in Call Forwarding mode, you can administer incoming calls on designated lines so that they are connected to a Voice Synthesis Processor (VSP) in the control unit. The VSP message informs the caller that the call will be forwarded. While the caller is listening to the message, the control unit calls the telephone number to which calls are being forwarded and uses the system’s Conference feature to connect the incoming call to the outgoing call.

### CONSIDERATIONS

Call Forwarding can be used in conjunction with a MERLIN Attendant for enhanced Night Service coverage. When used with the MERLIN Attendant, however, Call Forwarding functions somewhat differently. See the *MERLIN Plus MERLIN Attendant User’s Guide* for more information on this feature.

### ADMINISTRATION

The system administrator must decide who will answer calls that come in after hours and how those calls will be answered.

### PROGRAMMING

For programming procedures for Call Pickup, Ring Override, and Call Forwarding features, see the individual entries for these features in this section.

---

**HOW TO USE**

For further information on the attendant console, see Section 4, “Using the Attendant Console.” If you need help in using the Call Pickup, the Ring Override, or the Call Forwarding features, see the entries “Call Pickup,” “Ring Override,” or “Call Forwarding” in this section.

---

# One-Touch Dialing

## DESCRIPTION

In the MERLIN Plus system, there are six features that allow you to dial or redial a telephone number with the touch of a button.

- **Outside Auto Dial** — Dial an outside number by touching a button. An Outside Auto Dial button can hold a maximum of 16 digits.
- **Auto Intercom** — Dial an intercom number with one touch whenever you want to call someone connected to your MERLIN Plus system.
- **System Speed Dial** — If your system administrator has assigned a System Speed Dial code (#60 through #89 or #900 through #999) to a frequently dialed telephone number or account number, you can program the speed dial code onto an available voice terminal button. Then when you want to dial the telephone number or enter the account number on a call report, just touch the System Speed Dial button for that number.
- **Last Number Dial** — If you have programmed a Last Number button for your voice terminal, you can redial with one-touch the most recent number that you dialed. Each time you want this feature to redial a number, you must touch the programmed Last Number Dial button. You do not need to do anything to save this number.
- **Busy Buster** — This feature automatically redials the number you dialed most recently up to ten times at 60-second intervals. If someone answers the call within this time, your voice terminal alerts you. To use this feature, the system administrator must have assigned the feature to a voice terminal jack.
- **Saved Number Dial** — If you have Saved Number buttons on your voice terminal, you can save numbers for later redialing. When you are ready to redial each of the telephone numbers, merely touch the Saved Number button on which you have saved that number.

## CONSIDERATIONS

In order to use any one of these six One-Touch Dialing features, you must program it onto an available button on your voice terminal.

The system administrator can use the Program Mode Lock feature to prevent programming from individual voice terminals. If this feature is enabled for your voice terminal, you will not be able to program these buttons.

## ADMINISTRATION

None

## PROGRAMMING

If you want to use any of the six One-Touch Dialing features, you must program them onto your voice terminal. For programming procedures for each of the features, see their separate entries in this section.

## HOW TO USE

When you want to use one of the six One-Touch Dialing features, merely touch the appropriate button.

---

## On-Hook Dialing

**DESCRIPTION** Instead of using your handset to listen while you place a call, you may want to use your voice terminal's built-in speaker.

**CONSIDERATIONS** When instructions in this guide tell you to lift your handset before dialing, you may choose to leave your handset on-hook and use the speaker instead.

If you have a Speakerphone button, you can use it when you dial a call, so you can speak with people hands-free. See the "Hands-Free Answer on Intercom" feature in this section for more information on speakerphone guidelines.

**ADMINISTRATION** None

**PROGRAMMING** None

**HOW TO USE** To use the speaker while you place a call:

- 1 Without lifting your handset, touch **Speakerphone or Speaker**.
- 2 Dial the number.
- 3 When you hear the other person answer, begin your conversation.



If the line is busy, or if you get no answer:

- 1 Touch **Speakerphone or Speaker** to cancel the call.

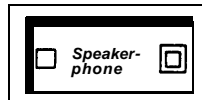

---

## Outside Auto Dial

### DESCRIPTION

You can use Outside Auto Dial to dial frequently used numbers and codes with one touch. These numbers and codes can include telephone numbers, and PBX, Centrex, or Custom Calling feature codes. You can include up to 16 numbers and special characters in an Outside Auto Dial sequence.

### CONSIDERATIONS

Any time instructions tell you to dial an outside number, you can touch an Outside Auto Dial button instead if you have one programmed for the number you want to dial.

**IMPORTANT:** If you want to program an outside auto dial button for an emergency number such as the police or fire department, the FCC requires that you test the button to be sure you programmed it properly only during off-peak hours.

You may need to program a pause, stop, or switchhook flash into an Outside Auto Dial sequence, or you may need to switch from rotary to Touch-Tone signals in the middle of a programmed dialing sequence. To do so, you must enter one or more of the following special characters when you program the sequence. (For more information about using special characters in a dialing sequence, see “Special Characters in Dialing Sequences.”)

- To program a pause, touch **Hold**.
- To program a stop, touch **Drop**.
- To program a switchhook flash at the beginning of a number, touch **Recall** and then touch **Hold**.
- To program Touch-Tone Enable, touch **Transfer**.

Your MERLIN Plus system may work behind a PBX or a Centrex system or you may want to use Custom Calling features. If so, use the PBX, Centrex, or Customer Calling features exactly as their instructions describe. However, there are two important exceptions:

- Any PBX, Centrex, or Custom Calling feature code that begins with a “#” must be preceded by another “#” in order to operate in the MERLIN Plus system. For example, if PBX, Centrex, or Custom Calling instructions tell you to dial #1234, you must dial ##1234 in order to use the feature.

**NOTE:** If you will be doing this frequently, you may want to program ##on a button.

- When PBX, Centrex, or Custom Calling instructions tell you to include a switchhook flash, you must touch **Recall** instead. If you touch the switchhook, you’ll disconnect the call.

### ADMINISTRATION

None



## PROGRAMMING

To program an Outside Auto Dial button for your voice terminal:

- 1 Label the button with a name and/or a number.
- 2 Slide the T/P switch to *P*.  
*The voice terminal rings every 5 seconds to remind you that you are programming and that you cannot place or receive calls.*
- 3 Touch the button you want to program.
- 4 Dial \*90 plus a telephone number or a PBX or Centrex code (if you need to include a special character in the dialing sequence, use the directions above).
- 5 Slide the T/P switch to the center position.

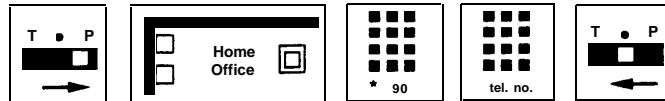

## HOW TO USE

To dial an outside number with one touch:

- 1 Without touching **Speakerphone** or lifting your handset, touch the Outside Auto Dial button for the number you want to dial.  
*Your voice terminal speaker goes on, and you hear dialing.*
- 2 If you programmed the special character STOP in a dialing sequence, after you hear the second dial tone, touch the Outside Auto Dial button again to continue the dialing.
- 3 When you hear the other person answer, start speaking or lift your handset then start speaking.

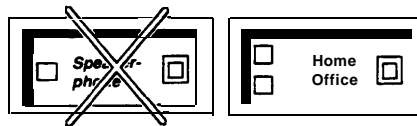

If the line is busy or if no one answers:

- 1 Touch **Speakerphone** or hang up to cancel the call.

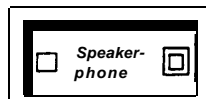

---

## Personal Lines

### DESCRIPTION

When the system administrator assigns lines to voice terminals, he or she can select lines that will serve as personal lines for individuals in the business, such as the president of the company. No one else has these lines on his or her voice terminal. Calls that come in on these personal lines will not ring at other voice terminals or at the attendant's console.

### CONSIDERATIONS

A secretary can cover calls that come in on his or her boss' personal line by having the line assigned to his or her own voice terminal and programming the line for immediate ring. A secretary can screen calls that come in on the personal line by programming the line on the boss' voice terminal to delayed ring or no ring and programming the line at his or her own voice terminal for immediate ring. (See "Ringing Options.")

### ADMINISTRATION

If your responsibilities do not include system administration, skip this information.

To assign a personal line to a voice terminal:

- 1 Enter administration mode by sliding the T/P switch to *P* and touching **Administer**.
- 2 Touch the Auto Intercom button or dial the intercom number for the voice terminal to which you want to assign a personal line.  
*A green light goes on next to the Auto Intercom button. Green lights also go on next to the buttons of any lines already assigned to the voice terminal.*
- 3 To add the personal line, touch the line button associated with that line until the green light next to it goes on.  
**NOTE:** If another voice terminal in your system has that line, you must remove it from that voice terminal by dialing the intercom number for that voice terminal and touching the line button that corresponds with that line so that green light next to it goes off.
- 4 Touch **Administer**.  
*The console beeps twice.*
- 5 Leave administration mode by sliding the T/P switch to the center position.

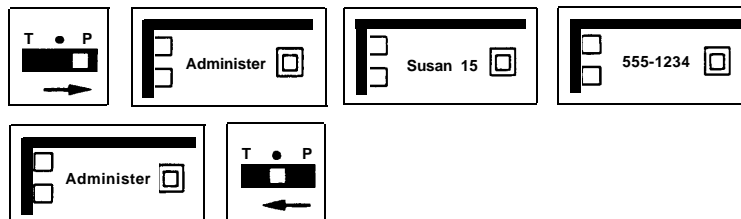

---

**PROGRAMMING**

None

**HOW TO USE**

You can begin speaking when a call comes in on your personal line. If you want your personal line to be the first line in your Automatic Line Selection sequence, tell your system administrator when he or she administers that feature for your voice terminal. (See “Automatic Line Selection.”)

---

## Personal Speed Dial

### DESCRIPTION

If you don't have many available buttons on which to program Outside Auto Dial, you can use the programming instructions below to assign a 3-character Personal Speed Dial code (from #01 through #24 for BIS-10 models and from #01 through #12 for BIS-22 models) to telephone numbers, PBX, Centrex, or Custom Calling feature codes you frequently dial.

You can assign a Personal Speed Dial code to a sequence containing up to 16 numbers and special characters.

### CONSIDERATIONS

Personal Speed Dial uses a dialing code. You do not place these codes on a voice terminal button.

### ADMINISTRATION

None

### PROGRAMMING

This feature is *not* associated with a voice terminal button.

#### Programming a Pause, Stop, or Switchhook Flash

You may need to program a pause, stop, or switchhook flash into a Personal Speed Dial sequence, or you may need to switch from rotary to Touch-Tone signals in the middle of a programmed dialing sequence. To do so, you must enter one or more of the following special characters when you program the sequence. (For more information about using special characters in a dialing sequence, see "Special Characters in Dialing Sequences.")

- To program a pause, touch **Hold**.
- To program a stop, touch **Drop**.
- To program a switchhook flash at the beginning of a number, touch **Recall** and then touch **Hold**.
- To program Touch-Tone Enable into a dialing sequence, touch **Transfer**.

---

### From a BIS-10 Voice Terminal

If you are using a BIS-10 voice terminal, use the following procedure to program a Personal Speed Dial sequence:

- 1 Slide the T/P switch to *P*.  
*The voice terminal rings every 5 seconds to remind you that you are programming and that you cannot place or receive calls.*
- 2 Dial a Personal Speed Dial code (#01 through #24).  
**NOTE:** Personal Speed Dial code #23 is preprogrammed for Saved Number Dial and #24 is preprogrammed for Last Number Dial. You can assign these Custom Calling features to different Personal Speed Dial codes, using a slightly modified procedure. Here's how to program Last Number Dial or Saved Number Dial onto Personal Speed Dial code #01:
  - a Slide the T/P switch to *P*.
  - b Dial #01.
  - c Dial \*90.
  - d Dial #01 again.
  - e Dial \*73 for Last Number Dial or \*74 for Saved Number Dial.
  - f Slide the T/P switch to the center position.
- 3 Dial \*90 plus a telephone number or a PBX, Centrex, or Custom Calling feature code. Follow the instructions above if you need to include a special character in the dialing sequence.
- 4 Slide the T/P switch to the center position.

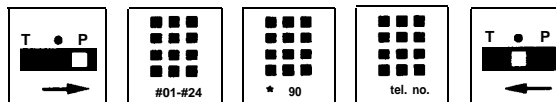

### From a BIS-22 Voice Terminal

If you are using a BIS-22 voice terminal, use the following procedure to program a Personal Speed Dial sequence:

- 1 Slide the T/P switch to *P*.  
*The voice terminal rings every 5 seconds to remind you that you are programming and that you cannot place or receive calls.*
- 2 Dial a Personal Speed Dial code (#01 through #12).
- 3 Dial \*90 plus a telephone number or a PBX, Centrex, or Custom Calling feature code. Follow the instructions above if you need to include a special character in the dialing sequence.
- 4 Slide the T/P switch to the center position.

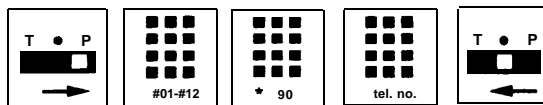

---

## HOW TO USE

### From a BIS-10 Voice Terminal

To place a call using a Personal Speed Dial code:

- 1 Touch **Speakerphone** or lift the handset.
- 2 Dial a Personal Speed Dial code (#01 through #24).
- 3 If you programmed the special character STOP in a personal speed dial sequence, after you hear the second dial tone, dial the Personal Speed Dial code again to continue the dialing.
- 4 If the line is busy, touch **Speakerphone** or hang up to cancel the call.

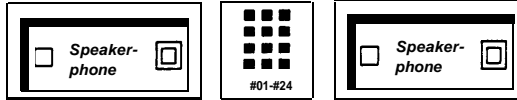

### From a BIS-22 Voice Terminal

To place a call using a Personal Speed Dial code:

- 1 Touch **Speakerphone** or lift the handset.
- 2 Dial a Personal Speed Dial code (#01 through #12).
- 3 If you programmed the special character STOP in a personal speed dial sequence, after you hear the second dial tone dial the Personal Speed Dial code again to continue the dialing.
- 4 If the line is busy, touch **Speakerphone** or hang up to cancel the call.

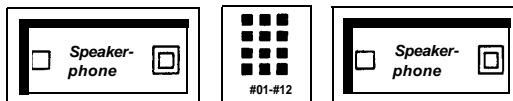

---

## Personalized Ringing

**DESCRIPTION** To make it easy for the right person to pick up calls in a group office, people in this type of office may want to program their voice terminals with a ringing pattern that is easier for each person to identify. There are eight different ringing patterns available.

**CONSIDERATIONS** Once you have programmed your Personalized Ringing selection, calls that ring at your voice terminal have this ringing pattern. However, note that only the second part of the transferring (one short and one long ring) has your Personalized Ringing pattern.

**ADMINISTRATION** None

**PROGRAMMING** To choose a ringing pattern that you like:

- 1 Slide the T/P switch to *P*.  
*You hear the ringing sound your voice terminal makes.*
- 2 Touch **Speakerphone** or **Speaker**.  
*You hear another ringing pattern.*
- 3 Touch **Speakerphone** or **Speaker** repeatedly until you hear a ringing pattern you like.
- 4 Slide the T/P switch to the center position.

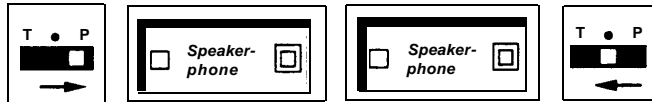

**HOW TO USE** After you have programmed your Personalized Ringing preference, you don't need to do anything else to use the feature. When a call rings at your voice terminal, you will hear the ringing pattern that you have chosen.

---

## Privacy

**DESCRIPTION** If you share an outside line with other people, you may choose to program a Privacy button that allows you to control when others may join or monitor your telephone conversations.

**CONSIDERATIONS** None

**ADMINISTRATION** None

**PROGRAMMING** The Privacy feature requires a button with lights. To program a Privacy button for your voice terminal:

- 1 Label the button **Privacy**.
- 2 Slide the T/P switch to *P*.  
*The voice terminal rings every 5 seconds to remind you that you are programming and that you cannot place or receive calls.*
- 3 Touch the button you want to program.
- 4 Dial \*72.
- 5 Slide the T/P switch to the center position.

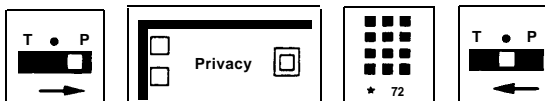

**HOW TO USE** To suspend the Privacy feature:

- 1 Touch **Privacy**.  
*The green light next to the button goes off.*

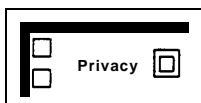

To activate the Privacy feature:

- 1 If the green light next to **Privacy** is off, touch the button.  
*The green light next to the button goes on.*

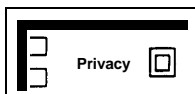



---

## Privacy (on Lines A and E)

**DESCRIPTION** The system administrator can administer the Privacy feature for Line A and/or Line E so that no one in the system can bridge onto or monitor these lines while a device plugged into the Aux jack is off-hook on Line A or Line E. (See "Auxiliary Lines.")

**CONSIDERATIONS** This feature is used for a modem, facsimile machine, or other equipment connected to the line through an auxiliary (AUX) jack on the control unit. This Privacy must be administered and therefore is a different feature than the Privacy feature that people can program for their voice terminals.

**ADMINISTRATION** If your responsibilities do not include system administration, skip this information.

- 1 Enter administration mode by sliding the T/P switch to *P* and touching **Administer**.
- 2 Dial \*57.  
*The green light goes on next to those lines that cannot be bridged or monitored.*
- 3 If you want to change the Privacy setting of either Line A or Line E, touch the line button until the green light next to it shows the setting you want:

*Green light on = the line is private  
Green light off = the line can be monitored*

- 4 Touch **Administer**.  
*The console beeps twice.*
- 5 Leave administration mode by sliding the T/P switch to the center position.

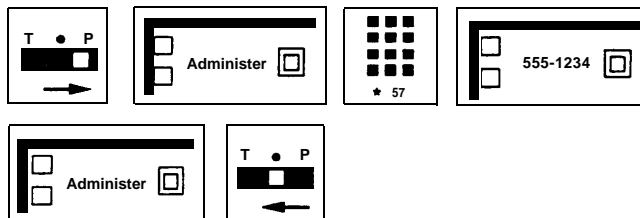

**PROGRAMMING** None

**HOW TO USE** None

---

# Program

## DESCRIPTION

By using the Test/Program switch and following the instructions listed below, you can program features that you have selected for your voice terminal onto available buttons.

## CONSIDERATIONS

There are several programmable features that you can use with either a button or a dial code. Therefore, if you have a limited number of available feature buttons on your BIS-10 or BIS-22 voice terminal, you may choose to use a dial code rather than program any of those features onto your voice terminal.

If you make a mistake when programming a button, simply touch the button again and redial the programming code and all required numbers.

The system administrator can use the Program Mode Lock feature to prevent people within the system from changing programming assignments on their voice terminals. (See “Program Mode Lock.”)

## ADMINISTRATION

The system administrator can program features onto individual voice terminals by using the Centralized Programming feature. (See “Centralized Programming.”)

## PROGRAMMING

Individual feature programming codes are provided in programming instructions in the reference description for each programmable feature and in Section 6, “Quick Reference Guides.”

## HOW TO USE

To program a feature onto your voice terminal:

- 1 Type or print on the button label strips all the names of the features you want to program. Then insert the labels into the appropriate slots on your voice terminal.
- 2 Slide the T/P (Test/Program) switch on the left side of the voice terminal to the P (Program) position.  
*The green lights next to the buttons begin flashing.  
The voice terminal rings every 5 seconds to remind you that you are programming and that you cannot place or receive calls.*
- 3 Consult the programming instructions in the specific feature’s entry in this section or use the codes listed in the “Quick Reference Guides” at the end of this section to determine the feature’s programming code. (You can also refer to the *MERLIN Plus System User’s Guide* for programming codes.)

- 
- 4 Touch the first button you want to program.
  - 5 Dial the required programming code and any other numbers required.
  - 6 Touch the second button you want to program and dial the required programming code and numbers. Continue to follow this procedure for all other buttons you want to program.
  - 7 Slide the T/P switch to the center position.



---

## Program Mode Lock

### DESCRIPTION

The system administrator may choose to disable (or “lock”) the programming function at an individual voice terminal so that the person at the voice terminal cannot change the programmed assignments. When a voice terminal’s T/P switch is locked, programming for that voice terminal can be done only at the administrator/attendant console. This feature can be administered for an individual voice terminal or for all voice terminals in the system, except the administrator/attendant console.

### CONSIDERATIONS

To program features onto a voice terminal, the administrator can use the Centralized Programming or the Copy feature.

The T/P switch allows a person to test the voice terminal lights and ringing of the voice terminal and program features on the voice terminal. When the system administrator has locked the programming function at a particular voice terminal, the person at the voice terminal can still slide the T/P switch to both the Test and the Program positions and can use the Test option only. However, the person cannot change any programmed features at the voice terminal.

When your MERLIN Plus system comes from the factory, programming can be done by the user at his or her own voice terminal (each voice terminal’s T/P switch is unlocked).

The administrator/attendant console connected to jack 10 cannot be locked out of program mode.

### ADMINISTRATION

If your responsibilities do not include system administration, skip this information.

To lock or unlock the programming function on an individual voice terminal:

- 1 Enter administration mode by sliding the T/P switch to *P* and touching **Administer**.
- 2 Dial \*89.

**3 Perform one of the following procedures:**

- > Touch the Auto Intercom button of the voice terminal that you are administering.

*Green light on = the voice terminal is locked.  
Green light off = programming can be done from the voice terminal.*

- > If You don't have an Auto Intercom button for the voice terminal, then use the corresponding dial code from the chart below:

If the intercom number is:	Dial this code:	If the intercom number is:	Dial this code:
Intercom 10	#22	Intercom 20	#03
Intercom 11	#21	Intercom 21	#04
Intercom 12	#20	Intercom 22	#05
Intercom 13	#19	Intercom 23	#06
Intercom 14	#18	intercom 24	#07
Intercom 15	#17	Intercom 25	#08
Intercom 16	#16	Intercom 26	#09
Intercom 17	#15	Intercom 27	#10
Intercom 18	#14	Intercom 28	#11
Intercom 19	#13	Intercom 29	#12

**4 Touch **Administer**.**

*The console beeps twice.*

**5 Leave administration mode by sliding the T/P switch to the center position.**

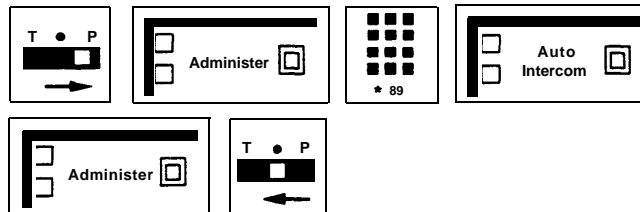

If you want to lock the programming function on all the voice terminals in your system (except the administrator/attendant console connected to jack 10):

**1 Enter administration mode by sliding the T/P switch to *P* and touching **Administer**.**

**2 Dial \*89.**

**3 Perform one of the following procedures according to whether you want to lock or unlock the programming function at all the voice terminals in your system:**

- > Touch **Conference** to lock every voice terminal in your system.

*A green light goes on next to the Auto Intercom button corresponding to the appropriate voice terminals. The voice terminals are locked; they cannot enter programming mode.*

- > Touch **Drop** to unlock all voice terminals in your system.

*A green light goes off next to the Auto Intercom button corresponding to the appropriate voice terminals. The voice terminals are unlocked; they can enter programming mode when necessary.*

---

**4 Touch *Administer*.**

*The console beeps twice.*

**5 Leave administration mode by sliding the T/P switch to the center position.**

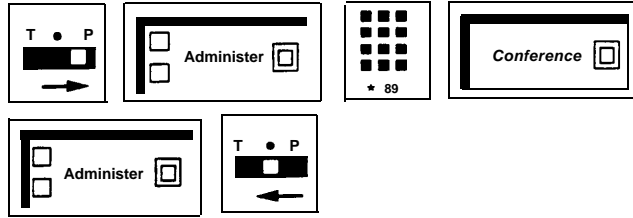

**PROGRAMMING**

None

**HOW TO USE**

Check with your system administrator to see if you can program features at your voice terminal or if programming can be done only at the administrator/attendant console.

---

# Recall

## DESCRIPTION

If you are on a PBX or Centrex system, you can use the Recall feature when directions tell you to include a switchhook flash.

## CONSIDERATIONS

By touching the Recall button, you will get one of the following:

- A new dial tone.
- Access to Custom-calling services.

If you have PBX, Centrex, or Custom Calling features, you must touch **Recall** any time instructions call for a switchhook flash. By touching the Recall button, you automatically place a specially timed pause onto the line. If you press the switchhook instead, you disconnect your call.

## ADMINISTRATION

None

## PROGRAMMING

None

## HOW TO USE

To use Recall as a switchhook flash:

- 1 Touch **Recall**.

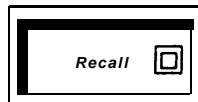

---

## Remote Line Access (RLA)

**NOTE:** Remote Line Access (RLA) is an ASA feature and therefore, requires the assignment of the ASA jack. If the ASA jack assignment has not yet been made, refer to “Automatic System Access” in this section before attempting to administer this feature.

### DESCRIPTION

When the system is in RLA mode, you can call in from outside (for example, from your home phone) and use a password to gain access to one of the system’s outside lines. You can also use RLA to change the telephone number to which calls are being forwarded during CF operation. (For more information, see “Call Forwarding” earlier in this section.) In RLA mode, the Voice Synthesis Processor (VSP) prompts callers through the procedures for entering a password and gaining access to an outside line.

### CONSIDERATIONS

RLA operation requires the following:

- At least one programmed button with red and green lights
- An incoming line group

When you use an RLA button to activate RLA, the system will treat as RLA calls only those calls that come in on lines specifically assigned to the RLA incoming line group. At startup, none of the outside lines are included in the RLA line group. There are simple administration procedures for changing the makeup of the RLA line group.

**NOTE:** If the system is in both CF/DXD and RLA modes and the lines overlap, CF/DXD takes precedence.

- Passwords

To gain access to one of the system’s outside lines during RLA operation, a caller must enter a valid 5-digit password when prompted to do so by the voice message. The administration procedure that follows is for assigning passwords. The first two digits of a password must be an intercom number in the system. The remaining three digits can be any three digits. Once the caller has gained access to the system, the caller’s identity is verified against the password, including the intercom number, and any restrictions that apply to the caller’s voice terminal apply to the current call.

- A synthesized voice message

For RLA operation, the voice message is a series of voice prompts automatically supplied by the VSP in the control unit. You cannot modify or turn off the voice prompts for RLA.

- Either RLA or CF/DXD buttons must be activated

To call in from a remote location, the MERLIN Plus system must be set to RLA or CF/DXD mode. Therefore, if you plan to use RLA during business off hours (weekends, evenings) be sure either the RLA or CF/DXD button is on before the office is closed.



- Call Forwarding should be used only at night if your system has one or more MERLIN Attendants, and you do not have dedicated lines for Call Forwarding. To use Call Forwarding at night with the MERLIN Attendant, activate this feature before leaving the office at the end of the business day, and deactivate it as soon as your business day begins.
- The Call Forwarding/Remote Line Access Disconnect Timer should be used in conjunction with CF if your Central Office (CO) does not provide a “forward disconnect” signal to your MERLIN Plus system. (See “Call Forwarding/Remote Line Access Disconnect Timer” in this section.)

An outward restricted user can only dial numbers that are present in an allowed list.

## ADMINISTRATION

If your responsibilities do not include system administration, skip this information.

### RLA Line Groups

At startup, *none* of the system’s outside lines are assigned to the RLA line group. To use this feature, you will need to assign line group(s) as follows:

- 1 Enter administration mode by sliding the T/P switch to *P* and touching **Administer**.
- 2 Dial \*54 for the incoming line group.

The green lights go on next to the buttons for the lines currently assigned to the list.

*Green light on = line is assigned to the group*  
*Green light off = line is not assigned to the group*

- 3 Touch line buttons until the green lights show the makeup you want for the line group.
- 4 Touch **Administer**.  
*The console beeps twice.*
- 5 Leave administration mode by sliding the T/P switch to the center position.

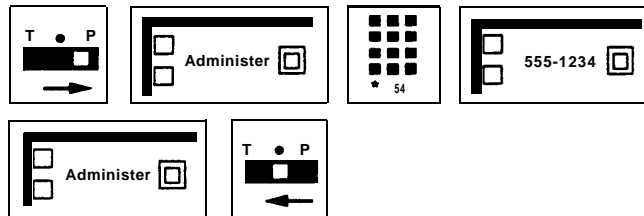

## Passwords

You and others in your business must enter a password to use RLA. The password is 5-digits and must be entered in order to gain access to an outside line using RLA *or* to change the current call forward number from a remote location. The first two numbers in the password are the caller's intercom number.

To create or invalidate a password, follow this procedure:

- 1 Enter administration mode by sliding the T/P switch to *P* and touching **Administer**.
- 2 Dial \*56.
- 3 To create a password for a particular intercom number, dial a MERLIN Plus system intercom number plus any three digits (except 000).  
*The console beeps twice.*
- 4 To invalidate any password beginning with a particular intercom number, dial the intercom number plus 000. Repeat the procedure for more passwords.  
*The console beeps twice.*
- 5 Touch **Administer**.  
*The console beeps twice.*
- 6 Leave administration mode by sliding the T/P switch to the center position.

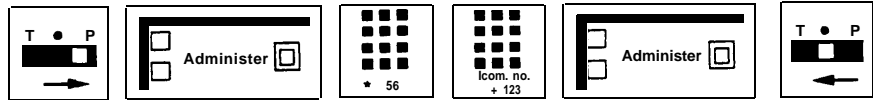

## Number of Rings

To change the number of rings (the default is two rings) before the RLA call is answered:

- 1 Slide the T/P switch to *P* and touch **Administer**.
- 2 Dial \*763 plus the number of rings (between 0 and 9) before the RLA feature picks up the call.  
**NOTE:** If the number of rings is set to 0, the voice terminal will not ring, and the calls will be immediately answered.
- 3 Touch **Administer**.  
*The console beeps twice.*
- 4 Leave administration mode by sliding the T/P switch to the center position.

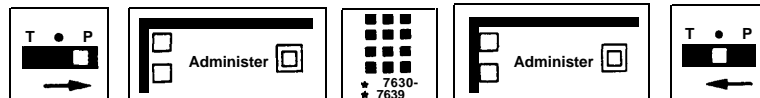

## PROGRAMMING

A button with a green light next to it is recommended for the RLA feature.

To program an RLA button on a voice terminal:

- 1 Label the button **RLA**.
- 2 Slide the T/P switch to *P*.  
*The voice terminal rings every 5 seconds to remind you that you're programming and can't receive or place calls.*
- 3 Touch the button you want to program.
- 4 Dial \*84.
- 5 Slide the T/P switch to the center position.



## HOW TO USE

### Using the RLA Button

Touching the RLA button toggles the system back and forth between the normal mode and the RLA mode. You can tell which mode you are in by the status of the green light next to the RLA button.

*Green light on = RLA mode*  
*Green light off = Normal mode*  
*Green light flashing = Problem with RLA*

If the green light next to the RLA button is flashing, notify the system administrator who should refer to Section 7, "Troubleshooting," to correct the problem.

### Gaining Access to a Line using RLA

If the system is in RLA mode, you can gain access to an outside line from a remote location by following this procedure:

**NOTE:** If you will be using this feature, ask your system administrator for the handy MERLIN Plus CF/RLA Card that provides instructions for RLA.

- 1 Dial the telephone number of a line in the RLA incoming line group.
- 2 When the call is answered, the VSP begins prompting you through the procedure in which the following information is called for:
  - NOTE:** The system verifies each response, such as the correct password or unrestricted lines or telephone numbers. If the response is incorrect or not allowed, the system requests the caller to respond again.
  - Enter the 5-digit password (the first two digits are a valid intercom number).
  - Enter the line number of the outside line you want to make your call on.
  - Enter the telephone number you want to reach plus a #.

- 
- 3 When you have finished responding to the voice prompts, you will hear normal call-progress tones (ringing, busy signal, fast busy signal, etc.).
  - 4 Complete your call as usual.

If the system is in either CF or DXD mode, you can gain access to a line in the RLA outgoing line group from a remote location by following this procedure.

- 1 Depending on the mode the system is in, dial the telephone number for a line in either the CF or the DXD incoming line group.  
*When the call is answered, the VSP gives the appropriate message.*
- 2 During the voice message, dial \*#\*.  
*The VSP begins prompting you through the RLA procedure*
- 3 Respond appropriately to the voice prompts until you hear normal call-progress tones (ringing, busy signal, fast busy signal, etc.).
- 4 Complete your call as usual.

---

# Ring Override

**DESCRIPTION** Sometimes you may want all of your calls to ring immediately, even if you have programmed the lines on your voice terminal to ring after a delay or not at all. (See “Ringing Options.”) For instance, you may need to cover calls for someone who shares one of your lines. You can use a Ring Override button to temporarily override the ringing option you have established.

**CONSIDERATIONS** None

**ADMINISTRATION** None

**PROGRAMMING** A button with lights is recommended but not required.  
To program a Ring Override button for your voice terminal:

- 1 Label the button **Ring Override**.
- 2 Slide the T/P switch to *P*.  
*The voice terminal rings every 5 seconds to remind you that you are programming and that you cannot place or receive calls.*
- 3 Touch the button you want to program.
- 4 Dial \*78.
- 5 Slide the T/P switch to the center position.

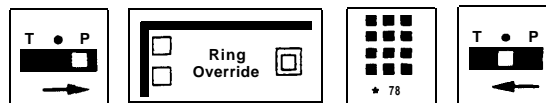

**HOW TO USE** To have all your calls ring immediately at your voice terminal:

- 1 Touch **Ring Override**.  
*If you have programmed this feature on a button with lights, the green light goes on.*

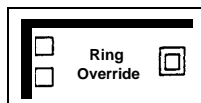

To return to your programmed line ringing:

- 1 Touch **Ring Override** again.  
*The green light goes off.*

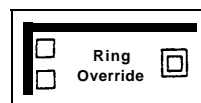

---

## Ringling Line Preference

<b>DESCRIPTION</b>	When you receive an outside call, the MERLIN Plus system automatically connects you to the ringing line.
<b>CONSIDERATIONS</b>	If you want to place an outside call while one of the lines on your voice terminal is ringing or in use, touch the line button of the line you want to use. When you touch <b>Speakerphone</b> or lift the handset, the MERLIN Plus system connects you to the line you have selected.
<b>ADMINISTRATION</b>	None
<b>PROGRAMMING</b>	None
<b>HOW TO USE</b>	When you receive an outside call: <b>1</b> Touch <b>Speakerphone</b> or lift your handset. <i>The MERLIN Plus system connects you to the ringing line.</i>

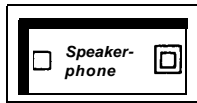

---

## Ringling Options

### DESCRIPTION

You can designate incoming calls to ring immediately at your voice terminal, ring at a second voice terminal if they are not answered at the first one after two rings (delayed ring), or not ring at all. When your system is installed, the lines at each voice terminal ring immediately when a call comes in on them. However, you can change this so that people in your office can answer calls at their desk for someone who is away or you can program phones in public places not to ring.

### CONSIDERATIONS

The following tips are useful for deciding how and when voice terminals in your MERLIN Plus system should ring.

**Immediate Ring:** People responsible for answering incoming calls, such as the system attendant, should have the lines on their voice terminals programmed for immediate ring. You can also use this option for private lines that don't need to be screened or for people who answer their own calls.

**Delayed Ring:** You can provide backup coverage on a shared line by having that line ring at a second voice terminal only after it has rung a few times somewhere else. Then, when calls come in for a person who is away from his or her desk, that person's calls will ring at a second voice terminal, the voice terminal belonging to a backup person. Delayed ring is often useful for a secretary who can pick up calls for someone on a personal line.

**No Ring:** People who do not normally answer incoming calls should have their lines programmed for no ring. You may also prefer to program telephones in public places, such as lobbies or conference rooms, not to ring. A line programmed for no ring *does not* ring on outside calls, but does ring for transferred and intercom calls. Even though the phones don't ring, they still can pickup lines that appear on the voice terminal.

**NOTE:** Lines that appear on all telephones in your MERLIN Plus system must be administered for No Ring at any telephone that has an answering machine.

If one answering machine is to be used to take messages for all telephones in your system, then all telephones should be administered for immediate ring.

If you decide that you want a line that you have programmed for delayed ring or no ring to temporarily ring immediately, program the Ring Override feature. (See "Ring Override.")

### ADMINISTRATION

None

---

## PROGRAMMING

To program the line ringing option you prefer:

- 1 Slide the T/P switch to *P*.
- 2 Touch the line button for which you want to program immediate, delayed, or no ringing.
- 3 Dial one of these codes for the type of ringing you want the line to have:
  - > Dial \*35 for no ring.  
*The red light next to the line button goes off.*
  - > Dial \*36 for delayed ring.  
*The red light next to the line button flashes.*
  - > Dial \*37 for immediate ring.  
*The red light next to the line button goes on steady.*
- 4 Repeat steps 2 and 3 for each line button you want to program.
- 5 When you are finished programming, slide the T/P switch to the center position.

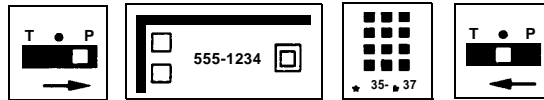

## HOW TO USE

Even if you program the lines on your voice terminal not to ring, you can tell if a call comes in for you because the 'green light next to the line button still flashes. To answer the call:

- 1 Touch the line button next to the flashing green light.
- 2 Touch **Speakerphone** or lift your handset.

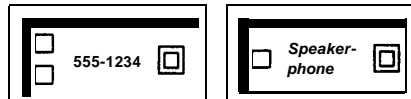



---

## Saved Number Dial

### DESCRIPTION

If you have programmed a Saved Number Dial button, you can use the button to save an important number for one-touch dialing at a later time. If the number you call is busy or no one answers, or if you need to call the person back, you can save that number by touching **Saved Number** before you hang up. Later, when you touch **Saved Number** again, your voice terminal automatically redials the number you have saved.

### CONSIDERATIONS

You can program more than one Saved Number Dial button for your voice terminal, so that, if necessary, you can save different calls during the day. Be sure to write on a separate sheet of paper the identity of each person called and/or telephone number for each Saved Number button.

You may prefer to use a dial code rather than program a button in order to use the Saved Number Dial feature.

A Saved Number Dial button saves both manually dialed numbers and numbers dialed with an Outside Auto Dial button, and numbers saved on a Last Number Dial button.

### ADMINISTRATION

None

### PROGRAMMING

To program a Saved Number Dial button for your voice terminal:

1 Label the button **Saved Number**.

2 Slide the T/P switch to *P*.

*The voice terminal rings every 5 seconds to remind you that you are programming and that you cannot place or receive calls.*

3 Touch the button you want to program.

4 Dial \*74 (you do not need to dial an outside number).

5 Slide the T/P switch to the center position.

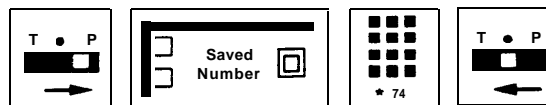

---

## HOW TO USE

You can use a programmed button or a dial code to access this feature.

To save a number for redialing:

- 1 Before you touch **Speakerphone** or hang up your handset from a call in progress, touch **Saved Number** or dial #23, if you haven't already programmed this personal speed dial code.
- 2 Touch **Speakerphone** or hang up your handset.

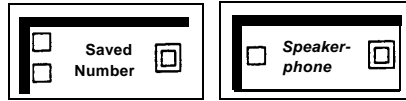

The MERLIN Plus system saves this number until you repeat this procedure to save another number.

To redial this number later:

- 1 Without touching **Speakerphone** or lifting your handset, repeat the first step you used to save the number. So if you touched **Saved Number**, touch it again or if you dialed #23, dial it again.  
*Your voice terminal speaker goes on, and you hear dialing.*
- 2 When you hear the other person answer, touch **Speakerphone** or lift your handset and begin talking.

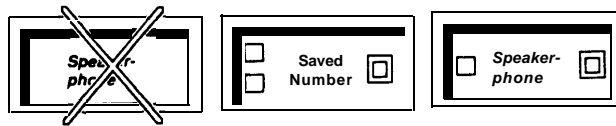

If the line is busy, or if no one answers:

- 1 Touch **Speakerphone**, or hang up to cancel the call.

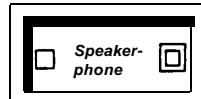

---

## Send Message

- DESCRIPTION** The system attendant can turn on the Message light at the voice terminals of people in the MERLIN Plus system in order to alert them that they have a message. (See “Message.”)
- CONSIDERATIONS** The Message light at voice terminals in the system can only be turned on at the attendant/administrator voice terminal. The alternate attendant position *cannot* turn on the message light.
- If your administrator/attendant console is a BIS-22 with more than ten voice terminals on the system, the attendant can still use the Send Message feature by following the directions below. However, he or she will not know if the light is already on at the voice terminal.
- If you’ve programmed Personal Speed Dial numbers, such as LND or SND, onto Auto Intercom buttons, then you *cannot* use those buttons with the Send Message feature.
- 5-Button voice terminals do not have a Message button.

**ADMINISTRATION** None

**PROGRAMMING** None

- HOW TO USE**
- From a BIS-34 Console**
- If you are using a BIS-34 console, use the following procedure to turn on the message light at a voice terminal:
- 1 At the administrator/attendant voice terminal, touch **Send Message**.
  - 2 Touch the Auto Intercom button for the person’s voice terminal.  
*The red light next to the Auto Intercom button goes on, indicating the person’s Message light is on.*
- NOTE:** To turn off the light, repeat the steps.

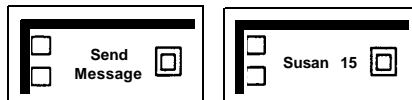

**From a BIS-22 Console**

If you are using a BIS-22 console, use one of the following procedures to turn on the message light at a voice terminal:

- 1 At the administrator/attendant console, touch **Send Message**.
- 2 Follow one of these procedures:
  - > Touch an Auto Intercom button that the attendant has programmed for the person.
  - > Dial a 3-character code corresponding to the Send Message button code on the following chart.

**NOTE:** To turn off the light, repeat the steps used to turn it on.

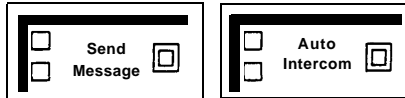

**From a BIS-10 Console**

If you are using a BIS-10 console, use the following procedure to turn on the message light at a voice terminal:

- 1 At the administrator/attendant console, touch **Send Message**.
- 2 Dial a 3-character code corresponding to the Send Message dial code on the following chart.

If the intercom number is:	Dial this Send Message dial code:	If the intercom number is:	Dial this Send Message dial code:
Intercom 10	#22	Intercom 20	#03
Intercom 11	#21	Intercom 21	#04
Intercom 12	#20	Intercom 22	#05
Intercom 13	#19	Intercom 23	#06
Intercom 14	#18	Intercom 24	#07
Intercom 15	#17	Intercom 25	#08
Intercom 16	#16	Intercom 26	#09
Intercom 17	#15	Intercom 27	#10
Intercom 18	#14	Intercom 28	#11
Intercom 19	#13	Intercom 29	#12

For example, the attendant may want to turn on the Message light at Intercom 21, but does not have an Auto Intercom button for that person. The attendant refers to the chart above and finds that the Send Message dial code is #04. Then from a BIS-22 console the attendant touches **Send Message** and dials #04 to light the message light.

**NOTE:** To turn off a message light at a voice terminal, repeat the steps above.

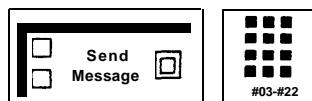

---

# Speaker

## DESCRIPTION

If your voice terminal does *not* have a speakerphone button, you can use your voice terminal speaker when you have dialed a call or been put on hold to monitor a line without lifting your handset. You can also allow others in your office to hear a conversation while you have a call in progress. There are three main ways to use your speaker:

- **On-Hook Dialing** —Without lifting your handset, turn on the voice terminal speaker and dial an outside or intercom number. (You can also use the one-touch dialing features for this purpose. See “One-Touch Dialing.”)
- **Monitor-on-Hold** —If someone puts you on hold, you can turn on your voice terminal speaker, hang up, and continue working until the person returns to the call.
- **Group Listening** —By turning on your voice terminal speaker during a telephone conversation, you can allow others in your office to hear a call. This feature is *not* available on the BIS models.

## CONSIDERATIONS

When you touch an Outside Auto Dial button or an Auto Intercom button, your voice terminal speaker automatically goes on and you hear dialing.

When you use the Group Listening feature, your speaker may make a squealing noise when the handset comes close to it. To prevent this, touch **Speaker** when you have completed a call and are ready to hang up your handset. Another way to reduce the squealing sound is to turn down the volume control on your voice terminal. This feature is not available on the BIS-10, BIS-22, BIS-22D, BIS-34, or BIS-34D.

## ADMINISTRATION

None

## PROGRAMMING

None

## HOW TO USE

To use On-Hook Dialing:

- 1 Without lifting your handset, touch **Speaker**.
- 2 Dial the number.
- 3 When you hear the other person answer, lift your handset to speak.



---

If the line is busy, or if you get no answer:

- 1 Touch **Speaker** to cancel the call.



To use Monitor-on-Hold:

- 1 When you have been put on hold, touch **Speaker**.
- 2 Hang up.
- 3 When you hear the other person return to the call, lift your handset and continue the call.



To use Group Listening:

- 1 Without hanging up, touch **Speaker**, and continue your conversation.

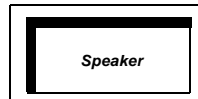

---

## Special Characters in Dialing Sequences

### DESCRIPTION

You may need to program a pause, stop, or switchhook flash into an Outside Auto Dial, a Personal Speed Dial, a Disallowed List, or a System Speed Dial sequence, or YOU may need to switch from rotary to Touchstone signals in the middle of a programmed dialing sequence. To do so, you must enter one or more special characters when you program the sequence.

### CONSIDERATIONS

The switchhook flash can be used only at the beginning of a programmed dialing sequence. Your MERLIN Plus system may work behind a PBX or a Centrex system, or you may use Custom Calling features. If so, use the PBX, Centrex, or Custom Calling features exactly as their instructions describe. However, there are two important exceptions:

- Any PBX, Centrex, or Custom Calling feature code that begins with a “#” must be preceded by another “#” in order to operate in the MERLIN Plus system. For example, if PBX, Centrex, or Custom Calling instructions tell you to dial #1234, you must actually dial ##1234. For your convenience, you may want to program a ## button, if you need to follow this procedure frequently.
- When PBX, Centrex, or Custom Calling instructions tell you to include a switchhook flash, you must touch **Recall** instead. If you touch the switchhook, you’ll disconnect the call.

### ADMINISTRATION

None

### PROGRAMMING

Use the following procedures to enter special characters into a dialing sequence.

#### Pause

Program a pause (1.5 seconds) into a dialing sequence. For example, you may need a pause between an access code, such as a 9, and an outside telephone number in an Outside Auto Dial sequence.

- 1 Dial the access code, such as a 9.
- 2 Touch **Hold** (Pause).
- 3 Dial the outside telephone number.

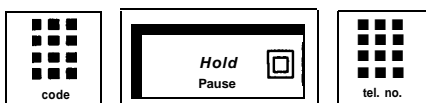

---

### Stop

Program a stop into a dialing sequence to wait for a second dial tone. For example, you may need to program a stop between a local telephone number and an alternate long distance authorization code.

- 1 Dial the local telephone number (seven digits).
- 2 Touch **Drop** (Stop).
- 3 Dial the authorization code (five or six digits).

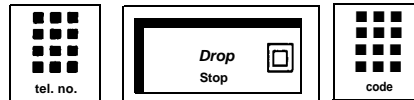

### Switchhook Flash

Program a switchhook flash at the beginning of a dialing sequence. For example, you may need to program a button with a PBX, Centrex, or Custom Calling feature code that calls for a switchhook flash.

- 1 Touch **Recall**.
- 2 Touch **Hold** (Pause).
- 3 Dial the PBX or Centrex dial code sequence that gives you access to the feature you want to program.

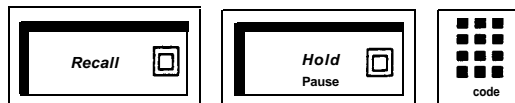

### Touch-Tone Enable

Program Touch-Tone Enable into a dialing sequence on a line with rotary signal. For example, you may need to use a credit card authorization service.

- 1 Touch **Transfer**.
- 2 Dial the credit card authorization code.



## HOW TO USE

If your MERLIN Plus system works behind a PBX or a Centrex system, or you are using the Custom Calling features, follow these directions:

- 1 When PBX, Centrex, or Custom Calling feature instructions tell you to dial a "#," dial a second "#." For example, if the instructions tell you to dial #4567, you must actually dial ##4567 in order to use the feature with the MERLIN Plus system.

If your PBX, Centrex, or Custom Calling feature instructions tell you to use a stop, touch **Drop** instead and for a switchhook flash, touch **Recall** instead.



---

## System Answer (SA)

### DESCRIPTION

**NOTE:** System Answer is an ASA feature and therefore requires the assignment of the ASA jack. If the ASA jack assignment has not yet been made, refer to “Automatic System Access” in this section before attempting to administer this feature.

When a call comes in, you can set the System Answer (SA) feature to automatically answer the call and place it on hold, or provide a brief message before placing the call on hold. If a compatible audio-source (tape player, radio, or stereo) is plugged into the Music-On-Hold jack (see “Music-On-Hold” under “Accessory Equipment” in this section), you have the option of playing a pre-recorded message about your business (hours of operation, special promotions, numbers to call, etc.), or allowing callers to hear music once the call is placed on hold. To answer the held call, touch the line button.

### CONSIDERATIONS

This feature can be activated only at the position assigned to the attendant. This will be intercom 10 unless an Alternate Attendant position has been assigned. System Answer must be deactivated (green light off) whenever you reassign the attendant position.

This feature can also be activated while a call is ringing. That call will be answered immediately and subsequent calls will automatically be answered after the administered number of rings. When the system is first set up, up to eight lines can be answered by SA and the caller will hear two rings before the SA message.

When administering an alternate attendant position, this feature must be turned off.

This feature *cannot* be copied using the Copy administration procedure. If copying is attempted, the receiving voice terminal will have an empty button in the corresponding position.

**NOTE:** If the system has System Answer active along with either the CF/DXD or RLA features and the assigned incoming line groups overlap, the CF/DXD or RLA features will take precedence.

System Answer feature must be deactivated when assigning the line groups.

If an Alternate Attendant is assigned after the System Answer line groups are assigned, the line groups remain the same, even if the line does not appear at the Alternate Attendant position. However, the line cannot be answered at the Alternate Attendant position if it does not appear there. Also if a call is ringing on a line that does not appear on the console defined as the attendant, touching SA will not answer the call.

System Answer cannot be used in conjunction with a MERLIN Attendant. (See the *MERLIN Plus MERLIN Attendant User's Guide*.)

## ADMINISTRATION

Follow the administration procedure under “Automatic System Access” in this section, for ASA jack assignments. If your responsibilities do not include administration, skip this information.

### SA Line Groups

To add lines that can be answered by SA:

- 1 Enter administration mode by sliding T/P to *P* and touching **Administer**.
- 2 Dial \*75.
- 3 Touch the incoming line button that you are adding to or removing from the feature.

*Green light on = line can be answered by SA*  
*Green light off = line cannot be answered by SA*

- 4 Touch **Administer**.

*The console beeps twice.*

- 5 Leave administration mode by sliding the T/P switch to the center position.

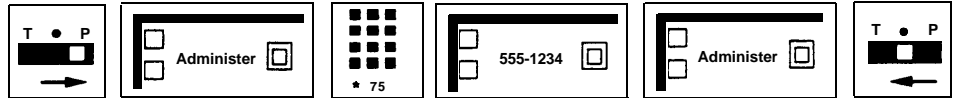

### Number of Rings

To change the number of rings (the default is two rings) before SA answers a call:

- 1 Slide the T/P switch to *P* and touch **Administer**.
- 2 Dial \*764 plus the number of rings (between 0 and 9) before the SA feature picks up the call.

**NOTE:** If the number of rings is set to 0, the voice terminal will not ring, and the calls will be immediately answered by SA.

- 3 Touch **Administer**.

*The console beeps twice.*

- 4 Leave administration mode by sliding the T/P switch to the center position.

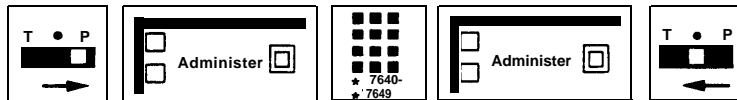

### Voice Message

To select a message to be played to the caller for lines answered by SA:

- 1 Enter administration mode by sliding T/P to *P* and touching **Administer**.
- 2 Dial \*77 followed by the option desired. (Message 2 is the default):

- 0 = No voice message; call is immediately placed on hold
- 1 = Message says, "Please hold."
- 2 = Message says, "Please hold, your call will be handled momentarily."

**NOTE:** If a line number is administered using \*50, this message precedes message 1 and 2: "You have reached . . ." where . . . is a number entered by the system administrator in "Call Forwarding."

- 3 Touch **Administer**.  
*The console beeps twice.*
- 4 Leave administration mode by sliding the T/P switch to the center position.

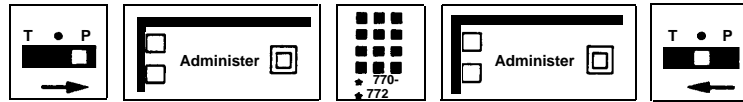

### PROGRAMMING

To program a System Answer button on a voice terminal:

**NOTE:** Only the attendant or the alternate attendant can have a System Answer button. The voice terminal does not have to be at Intercom #10.

- 1 Label the button "System Answer."
- 2 Slide the T/P switch to *P*.  
*The voice terminal rings every 5 seconds to remind you that you are programming and that you cannot place or receive calls.*
- 3 Touch **System Answer**.
- 4 Dial the time-digit code \*58.
- 5 Slide the T/P switch to the center position.

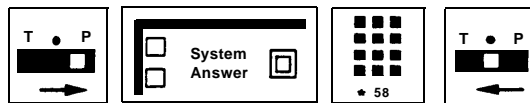

---

## HOW TO USE

To activate the System Answer feature:

### 1 Touch **System Answer**.

*Green light on = SA on*

*Green light off = SA off*

*Green light flashing = Problem with SA*

If the green SA light is flashing, report the problem to the system administrator who should refer to Section 7, "Troubleshooting," to correct the problem.

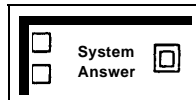

---

## System Feature Report (SFR)

**NOTE:** This feature is used with a MERLIN Plus system data collector and an AT&T 475/476 or 572/573 printer or equivalent.

### DESCRIPTION

If the system administrator needs to verify the features administered to the system or needs a written copy of the lines and features on each voice terminal, he or she can use the data collector and the printer to print a System Feature Report. This report lists both systemwide features and programmed features and lines on individual voice terminals.

The system features that can be printed on the System Feature Report are:

- Disallowed List assignments for each voice terminal.
- Allowed List assignments for each voice terminal
- Transfer Return Interval
- Call Report settings, such as the minimum call duration of a call for which the Call Report feature will print information
- System Speed Dial numbers
- Automatic System Access (ASA) administration

The voice terminal features that can be printed on the System Feature Report are:

- The intercom number of the voice terminal
- The voice terminal model type
- Optional accessories used with the voice terminal
- Voice Announcement Enable/Disable
- Automatic Line Selection sequences
- The lines and features assigned to all buttons on the voice terminal

Figure 5-3 shows a printout of a typical SFR.

### CONSIDERATIONS

The System Feature Report feature can be accessed only from the administrator/attendant console.

If the system administrator wants to have the date and time on the System Feature Report, the administrator can set these options on the control unit when he or she administers the date and time for the Call Report feature. (See "Call Report.")

The system administrator can connect the data collector and the printer to any voice terminal jack in the system, except jack 10. However, if the printer and data collector have already been assigned to a voice terminal jack for the Call Report feature, usually jack 19, it is best to use the same jack assignment for the System Feature Report.

**FIGURE 5-3 A printout of a typical System Feature Report.**

```

A          SYSTEM ADMINISTRATION OPTI ONE      Data: 04.01.89   Time: 05:55:45
A
A  MISCELLANEOUS FEATURES:
A
A  1. MUSIC-ON-HOLD VOLUME IS:                MEDI UM (*14)
A
A  2. BACKGROUND MUSIC VOLUME IS:            MEDI UM (*13)
A
A  3. TRANSFER RETURN (*2): 4 rings
A
A  4. LONG DISTANCE DIALING: TOLL PREFIX: (*38)
A
A  5. DIAL SIGNAL: TOUCH TONE (*38)
A
A  6. CALL REPORT MINIMUM CALL DURATION (*83): 1 MINUTES 10 SECONDS
A
A  7. TYPE OF CALLS REPORTED (*84): NO CALL REPORT (0)
A
A
A  AUTO SYSTEM ACCESS (ASA) FEATURES:
A
A  1. CALL FORWARD ANNOUNCEMENT MESSAGE OPTION IS (*30): ON
A
A  2. CALL FORWARD TELEPHONE NUMBER IS (*53): 12125551000
A
A  3. REMOTE LINE ACCESS PASSWORDS ARE (*56):
A  10388 11999 12000 13000 14000 15000 16000 17000 18000 19000
A  20000 21000 22000 23000 24000 25000 26000 27000 28000 29000
A
A  ALLOWED LIST (*01 - *08):
A  [X=in list. . =not in list]
A  [List Entries are printed for each list following the station list]
A
A          ICOM NUMBER:
A  LIST   10 15 20 25
A  1 : X..X XXXXX XXXX. .XXX
A      976          212976
A
A
A

```

**NOTE:** If you are using the same printer and data collector for both features and change the voice terminal jack assignment, you must administer the new jack assignment for *both* features.

You cannot use the same jack that you used for ASA but you can use the same jack that you used for BB, by using the 450F adapter and cord supplied with the data collector. If necessary, you can change the jack assignments for BB and ASA.

The report for each voice terminal shows all voice terminals as having 34-buttons. This allows flexibility for upgrading and changing voice terminals.

## ADMINISTRATION

If your responsibilities do not include system administration, skip this information.

To set the date and the time, to assign a voice terminal jack for the System Feature Report, and to print or to cancel a report, use the following procedures.

### The Date and the Time

(If you have already set the date and time for the Call Report feature, you don't have to do it again.)

To set today's date:

- 1 Enter administration mode by sliding the T/P switch to *P* and touching **Administer**.
- 2 Dial \*80.
- 3 Dial two digits for the month (01 through 12).
- 4 Dial two digits for the day (01 through 31).
- 5 Dial two digits for the year (00 through 99).

For example, if the date is May 16, 1986, dial \*80 05 16 86.

- 6 Touch **Administer**.  
*The console beeps twice.*
- 7 Leave administration mode by sliding the T/P switch to the center position.

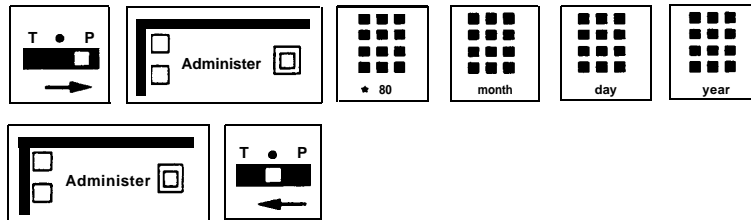

To set the current time:

- 1 Enter administration mode by sliding the T/P switch to *P* and touching **Administer**.
- 2 Dial \*81.
- 3 Dial two digits for the hour (00 through 23).
- 4 Dial two digits for the minute (00 through 59).

For example, if the time is 3:25 A.M., dial \*81 03 25; if the time is 3:25 P.M., dial \*81 15 25.

- 5 Touch **Administer**.  
*The console beeps twice.*
- 6 Leave administration mode by sliding the T/P switch to the center position.

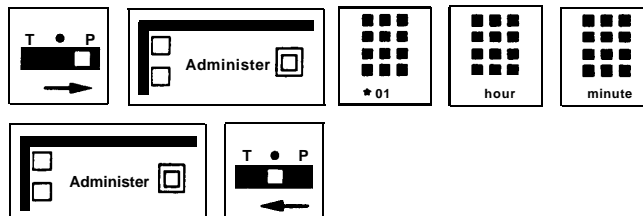

### Control Unit Jack Assignment for the System Feature Report

To assign a voice terminal jack on the control unit for the System Feature Report:

**NOTE:** The system is factory-set to have the data collector and printer connected to voice terminal jack 19 for the System Feature Report feature.

- 1 Enter administration mode by sliding the T/P switch to *P* and touching **Administer**.
- 2 Dial \*85.
- 3 Touch the Auto Intercom button or dial the intercom number of the jack to which the data collector and the printer will be connected for the Call Report feature.

*The green light next to the current jack assignment goes off; the green light next to the Auto intercom button for the jack to which the data collector and the printer will be connected goes on.*

- 4 Touch **Administer**.  
*The console beeps twice.*
- 5 Leave administration mode by sliding the T/P switch to the center position.

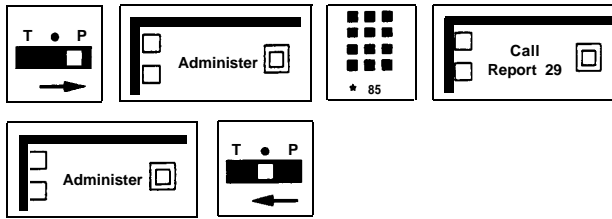

### Complete System Report

To print out a system administration report and a report for every voice terminal in your system:

- 1 Enter administration mode by sliding the T/P switch to *P* and touching **Administer**.
- 2 Dial \*60.  
*The printer prints the reports as it receives the data from the system.*
- 3 Touch **Administer**.  
*The console beeps twice.*
- 4 Leave administration mode by sliding the T/P switch to the center position.

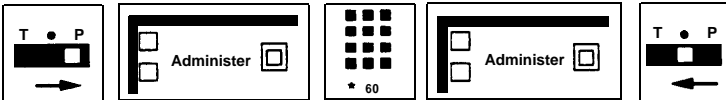



---

### System Administration Report

To print out a system administration report only:

- 1 Enter administration mode by sliding the T/P switch to *P* and touching **Administer**.
- 2 Dial \*61.  
*The printer prints the report as it receives data from the system.*
- 3 Touch **Administer**.  
*The console beeps twice.*
- 4 Leave administration mode by sliding the T/P switch to the center position.

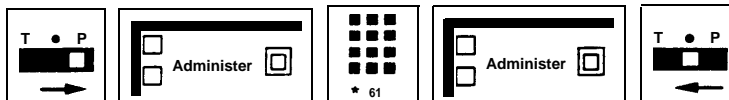

### Individual Voice Terminal Reports

To print out individual reports on one or more voice terminals:

- 1 Enter administration mode by sliding the T/P switch to *P* and touching **Administer**.
- 2 Dial \*62.
- 3 Touch the Auto Intercom button(s) or dial the intercom number(s) of the voice terminal(s) for which you want a report.  
*The printer prints the report as it receives data from the system.*
- 4 Touch **Administer**.  
*The console beeps twice.*
- 5 Leave administration mode by sliding the T/P switch to the center position.

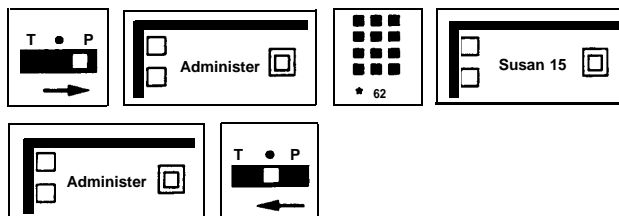

---

### Printout Cancellation

To cancel a printout in progress and to delete all waiting report requests:

- 1 Enter administration mode by sliding the T/P switch to *P* and touching **Administer**.
- 2 Dial \*63.  
*The printer stops printing.*
- 3 Touch **Administer**.  
*The console beeps twice.*
- 4 Leave administration mode by sliding the T/P switch to the center position.

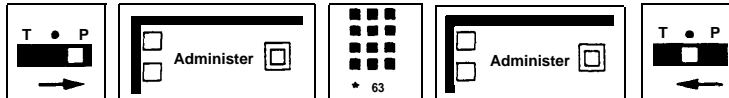

**PROGRAMMING**

None

**HOW TO USE**

None

---

## System Reset

**WARNING:** This feature is intended for service personnel only.

### DESCRIPTION

When the service person or the administrator uses System Reset, the entire MERLIN Plus system is set to the initial feature assignments, and consequently erases any system administration, such as System Speed Dial numbers or call restrictions. It is useful when making radical changes to the system or starting administration over again.

### CONSIDERATIONS

When the the service person on the administrator resets the system, all programming done for any voice terminal in the MERLIN Plus system is erased. If the administrator has administered customized line assignments for any voice terminal, these are erased also, and the line configuration is returned to square operation. All administered features are erased.

### ADMINISTRATION

System Reset requires readministering your system and reprogramming *all* voice terminals.

To reset your system to the initial feature assignments:

- 1 Enter administration mode by sliding the T/P switch to *P* and touching **Administer**.
- 2 Dial \*99198.  
*The console beeps twice.*

**NOTE:** If the console beeps only once or not at all, the reset didn't work, probably because someone was using the system when you dialed the System Reset code. Wait until no one is using the system, and try the reset again.

- 3 Go to the control unit and turn off the power for ten seconds, then turn it back on.  
*The red lights go on, and the green lights flash.  
The console rings every 5 seconds.*
- 4 Touch **Administer**.  
*The console beeps twice.*
- 5 Leave administration mode by sliding the T/P switch to the center position.

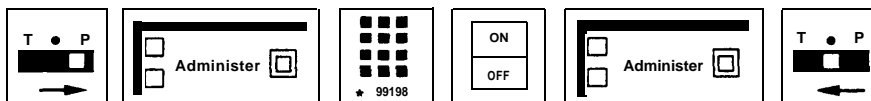

---

**PROGRAMMING**

None

**HOW TO USE**

This feature is recommended for service personnel only.

---

## System Speed Dial

### DESCRIPTION

The administrator can store System Speed Dial codes for telephone numbers, such as a warehouse number or a branch office number, and account numbers that people in the office frequently use. People can then dial the number simply by dialing the proper Speed Dial code. Your MERLIN Plus system can store up to 130 System Speed Dial numbers. System Speed Dial is particularly useful when the administrator wants to give users access to a specific number, for instance, an authorization code for an alternate long-distance service, but does not want to divulge the number.

For more information about assigning a System Speed Dial code to account numbers that the administrator wants to appear on call reports, see “Account Number Entry.”

### CONSIDERATIONS

You can program a System Speed Dial code for an area code and an exchange. Then when you want to dial a telephone number that begins with this area code and exchange, you can dial the Speed Dial code or touch the button programmed for the Speed Dial code, and then dial the remainder of the telephone number or use another Speed Dial code. The MERLIN Plus system can hold a maximum of 130 System Speed Dial codes of up to 16 digits each.

**IMPORTANT:** If you want to program a System Speed Dial code for an emergency number such as police or fire departments, the FCC requires that you test that the number was programmed correctly only during off-peak hours.

The system administrator can assign System Speed Dial codes to telephone numbers with or without Restriction Override.

- If the administrator decides to store a System Speed Dial code with Restriction Override, all voice terminals in the system can use the code as a type of password that allows the person to access the outside number, regardless of Disallowed List, toll or outward call restrictions previously placed on the voice terminal.
- The administrator may decide to store a System Speed Dial code without Restriction Override so that the Disallowed List, and all toll or outward restrictions placed on voice terminals continue to apply.

For System Speed Dial codes assigned to telephone numbers, the administrator can specify which Speed Dial codes will be printed on call reports (see “Call Report”), which codes will be displayed on display sets, and which ones will be private.

---

It is sometimes necessary to include a pause, stop, or switchhook flash, or to switch from rotary to Touch-Tone signals within a dialing sequence. To do so, the administrator must enter one or more of the following special characters into the dialing sequence. However, if you do use the special characters in the dialing sequence, you cannot use **Recall** to retry the number for you.

- To program a pause, touch **Hold**.
- To program a stop, touch **Drop**.
- To program Touch-Tone Enable, touch **Transfer**.
- To program a switchhook flash at the beginning of a dialing sequence, touch **Recall** and then touch **Hold**.

**NOTE:** If the first digit of a System Speed Dial number is the special character **Recall**, follow it by a pause (also a special character) when programming the dial sequence. If you need to use **Recall** in other than the first digit of the dialing sequence of a System Speed Dial number, you *cannot* use the Speed Dial feature.

(For more information about using special characters in a dialing sequence, including PBX, Centrex, and Custom Calling features, see “Special Characters.”)

If a number to which the administrator assigns a System Speed Dial code contains a “#” character, the character must be entered twice (For example, 9##123). A single “#” character ends administration of the current Speed Dial code.

When the administrator has dialed the maximum 16 characters for a System Speed Dial code, the system beeps twice to confirm the entry and to remind the administrator that he or she cannot dial any more characters. If the administrator dials less than 16 characters, the system does not beep.

The administrator should give a copy of the System Speed Dial code assignments to each person who will be using these codes.

People can dial the codes or program a button for specific Speed Dial codes.

## ADMINISTRATION

If your responsibilities do not include system administration, skip this information.

Before you administer the System Speed Dial feature, refer to the System Speed Dial Form that you have filled out.

To assign System Speed Dial codes to frequently dialed telephone numbers:

- 1 Enter administration mode by sliding the T/P switch to *P* and touching **Administer**.
- 2 Dial the code (#60 through #89 or #900 through #999) that you are assigning to the telephone number.

- 3 Dial one of the following codes:
  - > Dial \*90 to assign the Speed Dial code (without Restriction Override).  
For example, if you want the Speed Dial number to have the same restrictions as the actual telephone number, that is, call or toll restrictions still apply with this number, dial the System Speed Dial code (such as #67 or #936),\*90, and then the telephone number.
  - > Dial \*92 to assign the Speed Dial code with Restriction Override.  
For example, if you want to assign a System Speed Dial code to a telephone number that *anyone in the system* can dial, regardless of any previously placed restrictions, dial the System Speed Dial code (such as #67 or #936), \*92, and then the telephone number.
- 4 Dial the telephone number. (If you want the number to be private so that only the dial code appears on Call Reports and on display voice terminals, insert a \* before the telephone number. However, private numbers *do* appear on System Feature Reports.)  
  
For example, for a private number with Restriction Override, dial a System Speed Dial code (such as #67 or #936), \*92, and a telephone number with a \* before it, such as \*1-617-555-1234.
- 5 Touch **Administer**.  
*The console beeps twice.*
- 6 Repeat the last four steps for each telephone number to which you are assigning a System Speed Dial code.
- 7 Leave administration mode by sliding the T/P switch to the center position.

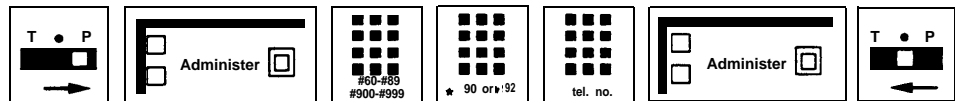

## PROGRAMMING

To program a button for a System Speed Dial code assigned to a telephone number:

- 1 Label the button with a name and/or a number.
- 2 Slide the T/P switch to *P*.  
*The voice terminal rings every 5 seconds to remind you that you are programming and that you cannot place or receive calls.*
- 3 Touch the button you want to program.
- 4 Dial \*95 plus a System Speed Dial code number from 60 through 89 and 900 through 999 that your administrator can give you.
- 5 Slide the T/P switch to the center position.

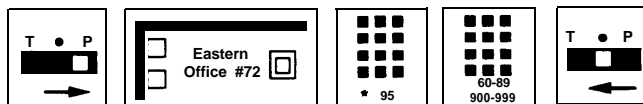

---

## HOW TO USE

In order to use the System Speed Dial feature, you can use a Speed Dial code or touch a programmed button.

To place a call by dialing a System Speed Dial code:

- 1 Touch **Speakerphone** or lift your handset.
- 2 Dial a System Speed Dial code (#60 through #89 or #900 through #999).

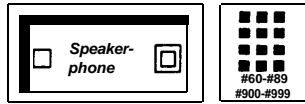

To place a call using a button programmed for a specific System Speed Dial code:

- 1 Touch **Speakerphone** or lift your handset,
- 2 Touch the System Speed Dial button for the particular code.
- 3 If the special character STOP is included in a system speed dial number, after you hear the second dial tone, dial the System Speed Dial code again to continue the dialing.

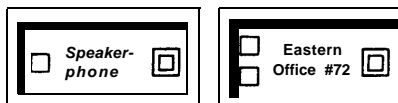



---

## Test

**DESCRIPTION** When you need to test the lights and the ringing on your voice terminal, or if you need to verify that your voice terminal has been installed correctly, you can use the Test/Program (T/P) switch on the left side of your voice terminal.

**CONSIDERATIONS** If your system administrator has administered the Program Mode Lock feature for your voice terminal, you cannot use the T/P switch for changing programmed features at the voice terminal. However, you can still use the T/P switch for testing voice terminal lights and ringing.

**ADMINISTRATION** None

**PROGRAMMING** None

**HOW TO USE** To test the lights and ringing on your voice terminal:

- 1 Slide the T/P switch to *T*. On some voice terminal models you must hold the switch in that position until you are finished testing your voice terminal.

*The red and green lights next to your voice terminal buttons flash alternately, and your voice terminal rings.*

- 2 Slide the T/P switch to the center position.

If your voice terminal does not respond when you slide the Test/Program switch to *T*, check Section 7, “Troubleshooting the System,” for possible causes and recommended action.

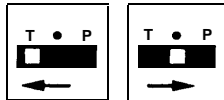

---

## Toll Prefix Setting

**DESCRIPTION** In most telephone systems people must dial a toll prefix (a 1 or a 0) before they dial an area code and telephone number. When the MERLIN Plus system is installed, it is set for dialing a toll prefix. If people in your system don't need to dial a toll prefix, the system administrator must set the system for dialing the area code only.

**CONSIDERATIONS** None

**ADMINISTRATION** If your responsibilities do not include system administration, skip this information. To administer the system so people can dial an area code and telephone number *without* a toll prefix:

- 1 Enter administration mode by sliding the T/P switch to *P* and touching **Administer**.
- 2 Dial \*37.
- 3 Touch **Administer**.  
*The console beeps twice.*
- 4 Leave administration mode by sliding the T/P switch to the center position.

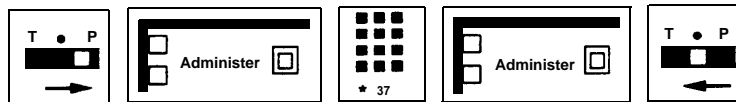

To change the system setting so that people must dial a toll prefix before an area code and a telephone number:

- 1 Enter administration mode by sliding the T/P switch to *P* and touching **Administer**.
- 2 Dial \*36.
- 3 Touch **Administer**.  
*The console beeps twice.*
- 4 Leave administration mode by sliding the T/P switch to the center position.

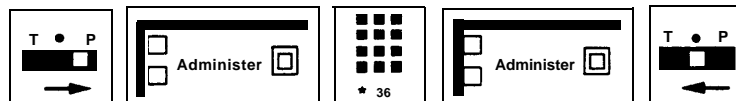

**PROGRAMMING** None

**HOW TO USE** Ask your administrator whether you need to dial a toll prefix (a 1 or a 0) before you dial an area code and a telephone number.

---

## Tones

### DESCRIPTION

Your MERLIN Plus system and your voice terminal provide the following tones to inform you of the progress of a call you are placing or are about to place. There are also tones that let you know you are in administration or programming mode and a tone to tell you that your voice terminal is working satisfactorily.

<b>Feedback</b>	<b>Sound</b>	<b>Meaning of the Feedback</b>
Dial tone	Steady tone	You can begin dialing when you are ready.
Busy tone	A slow pulsed tone	The line is busy.
Voice signal tone	A beep	You can announce the call through the other person's voice terminal speaker.
Dialing feedback	For Touch-Tone lines a series of tones For rotary lines a series of rotary pulses	You have dialed another digit of the telephone number.
Ringing tone	A ringing sound	The call is ringing at the other person's phone.
Testing feedback	A steady ringing sound	Your MERLIN Plus system has been installed correctly.

<b>Feedback</b>	<b>Sound</b>	<b>Meaning of the Feedback</b>
Programming reminder	Your voice terminal rings every 5 seconds to remind you that you can't place or receive calls.	You are in programming mode and cannot place or receive calls.
Error/Deny tone	One beep	You have made an error in administration and should try the step again.
Confirmation tone	Two beeps	The administration feature has been entered into the system.
Hold Reminder	One beep every minute	You have a call on hold.

The MERLIN Plus system also provides you with the following ringing sounds or voice announcements so that you know immediately what kind of call you are receiving.

<b>If you hear this type of ring or announcement</b>	<b>You are receiving this kind of call</b>
One short and one long ring	Transferred Call
A beep followed by a voice announcement through your voice terminal speaker	Intercom Call with Voice Announcement
A beep followed by a voice announcement through your voice terminal before you receive a transferred call	Transferred Call with Voice Announcement
A beep	Manual Signaling
One long beep	Ringing Intercom Call
One long ring	Outside Call

**CONSIDERATIONS**

You can program your voice terminal with a ringing pattern that is different from the ringing sound of nearby voice terminals. See “Personalized Ringing.”

**ADMINISTRATION**

None

**PROGRAMMING**

None

**HOW TO USE**

By listening to the tones that the system or your voice terminal gives you, you can use your MERLIN Plus system more efficiently.

---

## Touch-Tone Enable

**NOTE:** This feature is for rotary lines only.

### DESCRIPTION

If you have telephone lines that carry rotary signals, use the Touch-Tone Enable feature to switch to Touch-Tone signals midway through a dialing sequence. This lets you take advantage of bank-by-phone, credit card authorization, computer access, and alternate long distance services.

### CONSIDERATIONS

When you hang up your handset after using this feature on a call, your system returns to rotary signals.

### ADMINISTRATION

None

### PROGRAMMING

To program a Touch-Tone Enable button for your voice terminal:

- 1 Label the button **Touch-Tone Enable**.
- 2 Slide the T/P switch to *P*.  
*The voice terminal rings every 5 seconds to remind you that you are programming and that you cannot place or receive calls.*
- 3 Touch the button you want to program.
- 4 Dial \*76.
- 5 Slide the T/P switch to the center position.

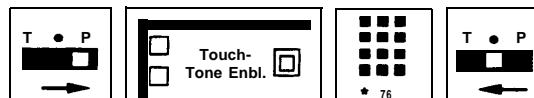

### HOW TO USE

To switch from rotary pulse to Touch-Tone signals as you dial a number:

- 1 Touch **Speakerphone** or lift your handset.
- 2 Dial the first part of the number.
- 3 Touch **Touch-Tone Enable**.
- 4 Dial the remaining numbers.



---

## Touch-Tone or Rotary Setting

### DESCRIPTION

When the MERLIN Plus system is installed, it is set to generate Touch-Tone signals. If any of the system's lines are rotary, the administrator must reset the system to rotary dialing by entering a code at the administrator/attendant console.

### CONSIDERATIONS

If your system has any rotary lines, you should select the rotary setting for the system then program a Touch-Tone Enable button which can be activated when you are using your Touch-Tone lines. (See "Touch-Tone Enable".)

### ADMINISTRATION

If your responsibilities do not include system administration, skip this information.

To set your system for rotary dialing:

- 1 Enter administration mode by sliding the T/P switch to *P* and touching **Administer**.
- 2 Dial \*39.
- 3 Touch **Administer**.  
*The console beeps twice.*
- 4 Leave administration mode by sliding the T/P switch to the center position.

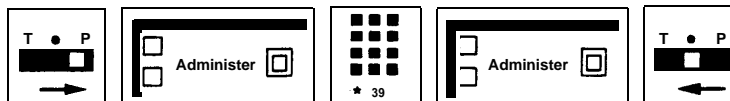

If you need to reset the system for Touch-Tone dialing:

- 1 Enter administration mode by sliding the T/P switch to *P* and touching **Administer**.
- 2 Dial \*38.
- 3 Touch **Administer**.  
*The console beeps twice.*
- 4 Leave administration mode by sliding the T/P switch to the center position.

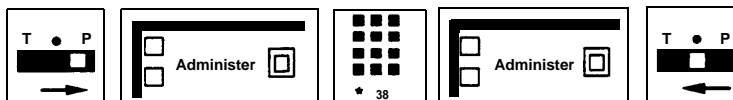

### PROGRAMMING

None

### HOW TO USE

If you have telephone lines that carry rotary signals, you can switch to Touch-Tone signals midway through a dialing sequence by using the Touch-Tone Enable feature. (See "Touch-Tone Enable".)

---

## Transfer

### DESCRIPTION

You can use your voice terminal Transfer button to transfer outside calls to someone else in your MERLIN Plus system.

There are three ways to transfer calls:

- **Option A—Simple Transfer** You can ask the person to whom you are transferring the call if he or she wants to accept the call.
- **Option B—One-Touch Transfer** If you have an Auto Intercom button for the person to whom you want to transfer a call, you can transfer a call with one touch.
- **Option C—Direct Transfer** You can transfer a call directly by dialing the intercom number.

### CONSIDERATIONS

If no one answers the transferred call, the call returns to the sender after a specified number of rings set by the system administrator. The administrator may also choose to set the system not to return calls. (See “Transfer Return Interval.”)

If the person to whom you are transferring the call has activated the Voice Announcement Disable feature or if the person is using the intercom line at his or her voice terminal, you cannot announce the call.

You *cannot* transfer a conference call.

Option A, Simple Transfer, can be used only when the person receiving the transferred call has the line button on his or her voice terminal.

### ADMINISTRATION

None

### PROGRAMMING

If you want to program an Auto Intercom button for a voice terminal to which you often transfer calls, see “Auto Intercom.”

### HOW TO USE

To screen a call using Option A, Simple Transfer:

- 1 Touch **Hold**.
- 2 Touch **Intercom** and dial the intercom number of the person to whom you are transferring the call.

*or*

Touch the person’s Auto Intercom button.

3 Announce the call and ask if it will reaccepted.

*No?*

- a Touch the held call's line button.
- b Advise the caller.
- c Hang up.

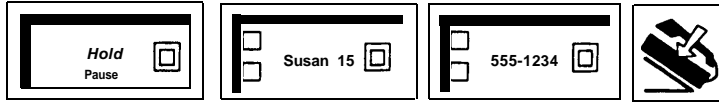

*Yes?*

- a Advise the person to touch the appropriate line button.
- b Hang Up.



To transfer a call using Option B, One-Touch Transfer:

- 1 With the call in progress, touch the Auto Intercom button of the person to whom you want to transfer the call.
- 2 When you hear a beep, you can announce the call, if appropriate.
- 3 Hang up:

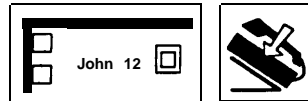

To transfer a call using Option C, Direct Transfer:

- 1 Touch **Transfer**.
- 2 Dial the intercom number of the person to whom you are transferring the call.
- 3 Hang up.

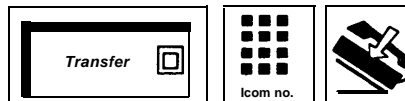



---

# Transfer Return Interval

## DESCRIPTION

When someone in the MERLIN Plus system transfers a call and it is not answered, the call returns to the sender. When the system is first installed, it is set to return calls after four rings. The system administrator can change that setting so that calls ring as many as nine times before they return to the person who has transferred it. The administrator may also choose to set the system not to return transferred calls at all.

## CONSIDERATIONS

If you are using the Direct Extension Dialing (DXD) feature with your MERLIN Plus system, you may want to consider setting a Transfer Return Interval. For more information, see “Direct Extension Dialing” in this section.

## ADMINISTRATION

If your responsibilities do not include system administration, skip this information.

To administer the Transfer Return Interval for your system:

- 1 Enter administration mode by sliding the T/P switch to *P* and touching **Administer**.
- 2 Dial \*2 plus the number of rings (up to nine) you want before a call returns. For example:

- \*20 programs the system not to return transferred calls
- \*21 programs the system to transfer calls after one ring.
- \*29 programs the system to transfer calls after nine rings.

**NOTE:** If anyone in your MERLIN Plus system will be using an answering machine for back-up coverage of calls to their telephones, set the Transfer Return Interval to six or more rings.

- 3 Touch **Administer:**  
*The console beeps twice.*
- 4 Leave administration mode by sliding the T/P switch to the center position.

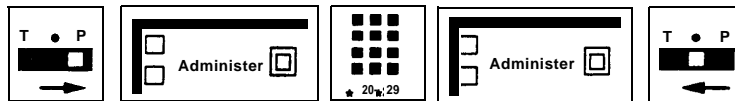

## PROGRAMMING

None

## HOW TO USE

Ask your system administrator what Transfer Return Interval is set for your system.

---

## Voice Announcement Enable/Disable

**DESCRIPTION** Ordinarily, people can use the MERLIN Plus system intercom feature to announce calls through your voice terminal speaker. However, if you do not want a voice announcement to interrupt your work, you can use the Voice Announcement Disable feature to have intercom calls ring at your voice terminal instead.

**CONSIDERATIONS** If someone in the MERLIN plus system has the Voice Announcement Disable feature programmed for his or her voice terminal, he or she cannot hear a Group Page announcement.

If you use the Voice Announcement Disable feature on a voice terminal with HFAI, you deactivate the HFAI feature. However, the Voice Announcement Disable feature does not affect voice terminals with connected hands-free units and with the Auto Answer-All feature activated.

You must program Voice Announcement Disable on your telephone if you want an answering machine to answer your intercom calls when you are not available.

**ADMINISTRATION** None

**PROGRAMMING** To program the voice announcement option you prefer for your voice terminal:

- 1 Slide the T/P switch to *P*.  
*The voice terminal rings every 5 seconds to remind you that you are programming and that you cannot place or receive calls.*
- 2 Touch **Intercom**.
- 3 Dial one of the following codes to indicate that you want voice announcements allowed or prevented at your voice terminal:
  - > If you want voice announcements allowed, dial \*38.  
*The green light next to the Intercom button goes on.*
  - > If you want voice announcements prevented, dial \*39.  
*The green light next to the Intercom button goes off.*
- 4 Slide the T/P switch to the center position.



**HOW TO USE** None

---

## Voice Terminal Templates

### DESCRIPTION

During administration, it may be useful to use the four voice terminal templates already designed for typical business uses, rather than program each voice terminal individually. The four templates are:

- **The Clear Template:** This template is used for erasing previous voice terminal features so that new features can be assigned. This template does *not* remove line assignments.
- **The Dialer Template:** This template is for personnel who do not require special features, and who aren't likely to make toll calls.
- **The Feature Template:** This template is designed for personnel, such as managers and owners, who need unrestricted phone use along with several additional features offered by the MERLIN Plus system.
- **The Receptionist/Secretary Template:** This template is intended for receptionists, secretaries, and backup call handlers, including the system attendant.

### CONSIDERATIONS

Both the Receptionist/Secretary template and the Features template require a 22-button or larger voice terminal.

Features, such as Voice Announcement Enable/Disable and Personalized Ring, previously administered to a voice terminal still apply even though they do not appear on the templates.

Unless Program Mode Lock is on, an individual can choose to reprogram different features over the features provided on the template.

### ADMINISTRATION

To administer one of the four templates onto a voice terminal:

- 1 Enter administration mode by sliding the T/P switch to *P* and touching **Administer**.
- 2 Dial \*10 followed by the option number of the template:

- 1 = Clear template*
- 2 = Dialer template*
- 3 = Feature template*
- 4 = Receptionist/Secretary template*

- 
- 3 Touch the Auto Intercom button or dial the intercom number of the target voice terminal.

*The console beeps twice after each voice terminal is administered a template.*

**NOTE:** Label the target voice terminal with the lines and features provided by the assigned template.

- 4 Touch **Administer**.

*The console beeps twice.*

- 5 Continue to administer the templates to voice terminals, or leave administration mode.

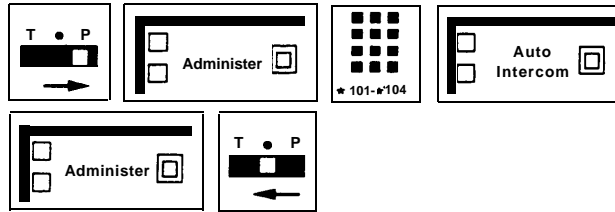

**PROGRAMMING**

None

**HOW TO USE**

Refer to Section 3 “Administration” under “Voice Terminal Templates” for further information.

# Quick Reference Guide to MERLIN Plus Features

The table below lists the preassigned and programmable features available from your MERLIN Plus system voice terminal. Those features that can also be accessed by using a dial code are identified with a “ †.” Each feature is listed by function, followed by a brief description. For more information, read the individual feature descriptions in this section.

Feature Name	Description	Preassigned or Programmable	Programming Code
<b>PLACING CALLS</b>			
Line Request	Request the use of a busy line	Preassigned	
Line Select	Select a line other than the line the system automatically selects for you	Preassigned	
Touch-Tone Enable	Change from rotary to Touch-Tone signals during a dialing sequence	Programmable	Dial *76
<b>ANSWERING CALLS</b>			
Auto Answer-All	Have optional equipment such as a modem, answering machine, or facsimile machine turn on when a call comes in	Programmable	Dial *75
Recall	Disconnect a call without hanging up	Preassigned	
Ringing Line Preference	Lift the handset and instantly be connected to the ringing line	Preassigned	
Voice Terminal and System Tones	Know by the ring, or by an announcement, the kind of call that is coming in	Preassigned	
<b>CALL HANDLING</b>			
Call Pickup	Pick up a ringing call at another voice terminal	Programmable†	Dial *85 (or dial *85 + an intercom number)
Conference	Have a telephone conference with several people at one time	Preassigned	
Drop	Disconnect a person from a conference call	Preassigned	
Hands-Free Answer on Intercom (HFAI)	Answer intercom calls without lifting handset (on voice terminal with an HFAI button)	Preassigned	
Hold Retrieve	Return to a call on hold (for people with button-he operation)	Programmable†	Dial *95*
Transfer	Transfer a call to another voice terminal	Preassigned	
Exclusive Hold	Place a call on hold so that it can only be picked up by the same voice terminal. Requires a button with lights.	Programmable	Dial *77

† You can also access this feature by using a dial code

Feature Name	Description	Preassigned or Programmable	Programming Code
<b>CALL-HANDLING REPORTS</b>			
Account Number Entry	Enter an account number on a Call Report (SMDR) by dialing the number or a System Speed Dial code	Programmable	Dial *82
Account Number Entry with one touch	Enter an account number on a Call Report	Programmable	Dial *88 + an account number (up to 16 digits) or Dial *95 + a System Speed Dial code (60 through 89 or 900 through 999)
<b>QUICK DIALING</b>			
Auto Intercom	Dial an intercom number with one touch A button with lights is recommended	Programmable	Dial *91 + an intercom number
Last Number Dial	Dial with one touch the number that you last dialed	Programmable†	Dial *73
Outside Auto Dial	Dial an outside number with one touch	Programmable	Dial *90 + an outside telephone number, PBX, Centrex, or Custom Calling feature code (up to 16 digits)
Personal Speed Dial	Dial a number quickly by dialing a code (Does not require a button)	Programmable	Dial a Personal Speed Dial code (BIS-10: #01 through #24, BIS-22: #01 -#12) + one of the following codes: *90 + an outside number, or a PBX, Centrex, or Custom Calling feature code, or *88 + an account number
Busy Buster	Automatically redial the most recently dialed number up to ten times at 60-second intervals	Programmable	Dial *31
Saved Number Dial	Save a number and dial it later	Programmable†	Dial *74
System Speed Dial	Dial a number quickly by dialing an administered code	Programmable	Dial *95 + a System Speed Dial code (60-89 and 900-999)

Feature Name	Description	Preassigned or Programmable	Programming Code
<b>PAGING</b>			
Group Page	Page a group of people through their voice terminal speakers	Programmable†	Dial *91 + one of the following codes: 70 for all voice terminals 71 for Group 1 72 for Group 2
Loudspeaker Page	Page someone through a loudspeaker system connected to the page jack on the Memory Module	Programmable†	Dial *91 +6
<b>PRIVACY</b>			
Do Not Disturb	Prevent calls from ringing while you are busy Requires a button with lights	Programmable	Dial *71
Privacy	Prevent others from accidentally joining your calls Requires a button with lights	Programmable	Dial *72
<b>LINE OPTIONS</b>			
Automatic Line Selection	Choose the order of the lines you will get when you pick up the handset	Programmable	Dial **, then touch the line buttons in the preferred ringing order
<b>RINGING OPTIONS</b>			
Ring Override	Have a line ring immediately even though it is programmed to ring after a delay or not at all Requires a button with lights	Programmable	Dial *78
Personalized Ringing	Choose a ringing sound you like for your voice terminal	Programmable	No programming code necessary; for programming information, see Section 5, "Reference"
Ringing Options	Have lines ring immediately, ring after a delay, or not ring at all	Programmable	Dial *35 for no ring Dial *36 for delayed ring Dial *37 for immediate ring
Voice Announcement Disable	Have intercom calls ring at your voice terminal	Programmable	Dial *38 to enable voice announcements Dial *39 to disable voice announcements

Feature Name	Description	Preassigned or Programmable	Programming Code
<b>INTEROFFICE COMMUNICATION</b>			
Manual Signaling	Signal someone within your MERLIN Plus system	Programmable	Dial *6 + an intercom number
Message	Know when the attendant has taken a message for you	Preassigned	The attendant touches <b>Send Message</b> + an intercom number
Send Message	Turn on the message light at someone else's voice terminal (attendant console only)	Preassigned	Touch <b>Send Message</b> + an intercom number
<b>AUTOMATIC SYSTEM ACCESS</b>			
Call Forwarding/Direct Extension Dialing	Have your calls forwarded when you are at a different location	Programmable	Dial *83
Remote Line Access	Gain access to a company line even though you are at another location	Programmable	Dial *84
System Answer	Have your calls answered automatically and placed on hold	Programmable	Dial *58



# Quick Reference Guide to Using the ASA Features

Procedure	Do This
Using the CF/DXD Button	<p>Repeatedly touch the CF/DXD button until the red and green light next to the button show the ASA mode you want the system to be in.</p> <p><i>Red and green light off = the system is in the normal mode (calls coming into the system are handled normally)</i>  <i>Green light on = the system is in DXD mode</i>  <i>Red light on = the system is in CF mode</i></p>
Using the RLA button	<p>Touch the RLA button until the lights show the ASA mode you want the system to be in.</p> <p><i>Green light on = the system is in the RLA mode</i>  <i>Green light off = the system is in normal mode</i></p>
Gaining access to a line in the RLA outgoing line group from a remote location (with the system in the RLA mode)	<ol style="list-style-type: none"> <li><b>1</b> With the system in RLA mode (the green light next to the RLA button is on), dial the telephone number of a line in the RLA incoming line group. <i>When the call is answered, the Voice Synthesis Processor (VSP) begins prompting you through the procedure.</i></li> <li><b>2</b> Respond appropriately to the VSP prompts until you hear normal call-progress tones, such as ringing or the busy signal.</li> <li><b>3</b> Complete your call.</li> </ol>
Gaining access to an RLA line group from a remote location (with the system in the CF or DXD mode)	<ol style="list-style-type: none"> <li><b>1</b> Depending on whether the system is in the CF or DXD mode, dial the telephone number of a line in either the CF or DXD incoming line group. <i>When the call is answered, the VSP gives the appropriate message.</i></li> <li><b>2</b> As soon as the message ends, immediately dial the 3-character code, *#*. <i>The VSP begins prompting you through the RLA procedure.</i></li> <li><b>3</b> Respond appropriately to the VSP prompts until you hear normal call-progress, such as ringing or a busy signal.</li> <li><b>4</b> Complete your call.</li> </ol>
Using the SA button	<p>Touch the SA button on either the attendant console or the alternate attendant console.</p> <p><i>Green light on = SA is on</i>  <i>Green light off = SA is off</i></p>

# Quick Reference Guide to Programming Codes

Programming Codes	Other Numbers/Buttons	Feature
*6	an intercom number	Manual Signaling
*31		Busy Buster
*35		Ringling Options, no ring
*36		Ringling Options, delayed ring
*37		Ringling Options, immediate ring
*38		Voice Announcement Enable
*39		Voice Announcement Disable
*58		System Answer
*70		Auto Answer Intercom
*71		Do Not Disturb
*72		Privacy
*73		Last Number Dial
*74		Saved Number Dial
*75		Auto Answer-All
*76		Touch-Tone Enable
*77		Exclusive Hold
*78		Ring Override
*82		Account Number Entry
*83		Call Forwarding/Direct Extension Dialing
*84		Remote Line Access
*85	an intercom number	Call Pickup Call Pickup with One Touch
*88	an account number	Account Number Entry with One Touch
*90	a telephone number	Outside Auto Dial
*91	an intercom number 70 = All voice terminals 71 = Group 1 72 = Group 2 6	Auto Intercom Group Page  Loudspeaker Page
*95	a 2 or 3-character System Speed Dial code (60-89, 900-999)	System Speed Dial (programmed on a button)
*95*		Hold Retrieve

Section 6: Accessory Equipment

---

# Accessory Equipment

---

Once you have set up your MERLIN Plus system, you may decide to purchase additional hardware such as a headset that the system attendant can use for easier call-handling or a basic telephone that is connected to the MERLIN Plus system and can be used off-premises. The information included in this section will help you decide what optional equipment you want to add to your system and how to use these accessories.

The information in the entry for each accessory is divided into six parts:

- **Description**

The description of the accessory tells what it does and its advantages for the user.

- **Drawings and Diagrams**

Drawings of the accessory and its parts are included for each piece of equipment, along with any applicable diagrams showing how the equipment is connected to other MERLIN Plus system accessories.

- **Considerations**

Considerations include any qualifications the user should know about the hardware, ways in which the equipment can or cannot be used, and other hardware or features it can or cannot be used with.

- **Administration**

If applicable, administration procedures are given for setting options at the administrator/attendant console so that people in the MERLIN Plus system can use the accessory equipment.

- **Programming**

If applicable, programming procedures are given for customizing the voice terminal so that people in the MERLIN Plus system can use the accessory equipment.

- **How to Use**

If applicable, procedures describe how to use the equipment or voice terminal.

---

## Answering Machines

### DESCRIPTION

Answering machines can be used as back-up “voice mailboxes” with any telephone in your MERLIN Plus system. MERLIN Plus is compatible with many of the most widely used answering machines, including AT&T models 1321 and 1323. Consult the user manual supplied with your answering machine for specific information on installing your answering machine and using its features.

### CONSIDERATIONS

Answering machine operation requires the following considerations:

- A General Purpose Adapter (GPA) is required to connect an answering machine to a MERLIN Plus system telephone. (See the section on General Purpose Adapters in this manual and your GPA Customer Instruction Booklet for installation instructions.) The GPA connects to the “Other” jack on the telephone set. The five-button telephone set does not provide an “Other” jack, and therefore will not support an answering machine. If the “Other” jack is already in use for another purpose (e.g., a modem), an answering machine cannot also be used.
- A station with an answering machine must have an “Auto Answer” button programmed. When the Auto Answer feature is activated (green LED is lit), calls that ring at the station will also ring at the answering machine. When the feature is not active, calls will not ring at the answering machine.
- Your MERLIN Plus telephone can only handle one call at a time. If you are talking on the telephone and a second call comes through, there will be a single, abbreviated ring and the associated line button will flash, but the answering machine will not pick up that call. You may put the first caller on hold while you answer the second call, or you may allow the second call to be returned to the receptionist, MERLIN Attendant or transferring party.
- Most answering machine features are available to work with MERLIN Plus, but the following features may not operate in exactly the same manner:

#### — Call Screening

Most answering machines have a “call screening” feature that allows you to listen over a speaker when a caller is leaving a message. This feature operates slightly differently when your answering machine is connected to a telephone in the MERLIN Plus system. The General Purpose Adapter (GPA) that serves as the interface between the MERLIN Plus system and the answering machine masks the signal used by the answering machine to sense when the receiver has been lifted. If you lift the receiver of your MERLIN Plus telephone to answer a “screened” call while your answering machine is still active, you will be able to talk to the caller, but the answering machine will continue to record the conversation. If you cannot stop the answering machine by pressing the “Stop” button, you should warn the caller that the call is being recorded.

---

### — Toll Saver

Most answering machines allow you to determine whether or not you have messages by dialing your telephone number from an outside telephone and counting the number of rings. The answering machine will take longer (usually four rings) to answer the first call than to answer subsequent calls (usually two rings). This feature works with MERLIN Plus even though you may not be able to hear the ring under all conditions. If you call on personal lines that bypass the MERLIN Attendant and the receptionist, you *will* hear the ring. If your call is transferred to your telephone by the MERLIN Attendant, the receptionist, or another telephone, you will be on hold until your answering machine answers, and you *will not* hear the ring. Even if you are on hold and cannot hear the ring, you can use the fact that one ring cycle takes 6 seconds to determine the number of rings. For example, if your answering machine answers toll saver calls after four rings, 15 to 21 seconds (2-1/2 to 3-1/2 ring cycles) is longer than the answering machine will take to answer if you have messages, yet shorter than it will take to answer if there are no messages. (If your answering machine uses a different number of rings for the toll saver feature, adjust the time accordingly.)

## ADMINISTRATION

The MERLIN Plus system normally has every line appearing on, and ringing at, all telephones. A maximum of one telephone with an answering machine should ring for each line. If a line rings on more than one telephone that has an answering machine, more than one answering machine may answer the call.

Calls that come in on common lines should be handled by a receptionist or the MERLIN Attendant, and transferred to the individual telephone requested by the caller.

MERLIN Plus returns calls to the receptionist, the MERLIN Attendant or the caller's telephone if no answer is received within the number of rings specified by the Transfer Return Interval. The Transfer Return Interval must be set to be longer than any answering machine on the system will need to answer a call. In most cases, it is sufficient to administer the Transfer Return Interval to six rings.

## PROGRAMMING

MERLIN Plus normally provides voice announcement for intercom calls. This feature will not activate answering machines. If intercom calls are to be answered by machine, the the Voice Announcement feature must be disabled so that intercom calls will ring. See "Voice Announcement Enable/Disable" in Section 5.

## HOW TO USE

To use an answering machine for back-up call handling on your MERLIN Plus telephone, activate the Auto Answer feature when you leave the office and deactivate the feature when you return to the office.

---

## Basic Telephones

### DESCRIPTION

Basic Touch-Tone telephones can provide regular phone service and can use many of the features of your communication system using dial codes and switchhook flashes. The table below shows the telephones that are compatible with the MERLIN Plus system and the possible connections:

Compatible Telephones	Connect To
Industry standard rotary	AUX port BTMI
Industry standard Touch-Tone	AUX port BTMI GPA
Touch-Tone with MC/RCL (3178-SYS)	AUX port BTMI GPA
Speakerphone 420 (3102-420)	AUX port BTMI GPA

**NOTE:** Touch-Tone with MC/RCL (3178-SYS) models do not have a message waiting indicator.

### CONSIDERATIONS

You can also use accessories with your MERLIN Plus system that work similarly to basic telephones. These accessories include auto-dial modems, facsimile machines, credit phones, answering telephones, manual dial modems, auto dialers, and answering machines. The following devices support these accessories.

- **Basic Telephone and Modem Interface (BTMI)** —The BTMI is intended for on-premises telephones and accessories. You can connect to your MERLIN Plus system such accessories as auto-dial modems, facsimile machines, credit phones, and answering telephones. You do not need to use a MERLIN Plus system voice terminal with these accessories.
- **General Purpose Adapter (GPA)** —The GPA is intended for accessory equipment that you can connect to your MERLIN Plus system voice terminal such as manual dial modems, auto dialers, answering machines, and cordless telephones.
- **Auxiliary Jack (AUX jack)** —The AUX jack on the MERLIN Plus system control unit is primarily intended to let you share Line A and/or E with the MERLIN Plus system. You can connect such devices as data devices, a facsimile machine, or an answering machine to the AUX jack.

Once you have assigned lines to a basic telephone, be sure to provide the person using the telephone with a list of the codes for the lines he or she has access to.

---

Basic telephones are able to receive ringing intercom calls, but *not* intercom calls with voice announcement. Therefore, you must program the Voice Announcement Disable feature for the telephone.

In order to program Voice Announcement Disable, Ringing Options, or an Automatic Line Selection sequence for the basic telephone, the system administrator can use the Centralized Programming feature on the administrator/attendant console.

## ADMINISTRATION

If your responsibilities do not include system administration, skip this information.

### 1 Assign lines to the basic telephone:

- a Enter administration mode by sliding the T/P switch to *P* and touching **Administer**.
- b Dial the intercom number or touch the Auto Intercom button for the basic telephone that you are administering.  
*A green light comes on next to the Auto Intercom button. Green lights also come on next to the buttons of any lines already assigned to the telephone.*
- c Touch each line button so that the green light next to it shows the line assignment you prefer.

*Green light on = the line is assigned to the telephone  
Green light off = the line is not assigned to the telephone*

### 2 To restrict the type of calls that the basic telephone can place:

- a Touch **Restrict** until the green light next to it shows the code for the call restrictions you want the telephone to have:

*Steady green light = Unrestricted (all calls permitted)  
Flashing green light = Toll restricted (local and intercom calls)  
Green light off = Outward restricted (intercom calls)*

- b When you are finished administering the basic telephone, touch **Administer**.  
*The console beeps twice.*
  - c Leave administration mode by sliding the T/P switch to the center position.
- ### 3 Then connect a MERLIN Plus system voice terminal directly to the control unit voice terminal jack to which you plan to connect the BTMI. (You can also program the basic telephone by using the Centralized Programming feature on the administration/attendant console. For more information on this feature, see “Centralized Programming.”)
- ### 4 Program this substitute telephone for Voice Announcement Disable:
- a Slide the T/P switch to *P*.
  - b Touch the Intercom button until the green light next to it goes off.



- 5 If you want to change the order in which the system selects available lines for this telephone, assign an Automatic Line Selection sequence.
  - a While in programming mode, dial \*\*.
  - b Touch the line buttons in the order you want them to be selected.
  - c When you are finished programming the basic telephone, slide the T/P switch to the center position.
- 6 If you want the basic telephone not to ring on specified lines, use the Ringing Options feature. While in programming mode, touch the line for which you want to program a ringing option:
  - a If you don't want the phone to ring, dial \*35.
  - b If you want the phone to ring immediately when a call comes in, dial \*37.
- 7 Disconnect the substitute voice terminal and connect the BTMI to the same voice terminal jack. Then connect the basic telephone to the BTMI.

**PROGRAMMING**

None

**HOW TO USE**

A person using a basic telephone must dial the codes shown in Figure 6-1 to access the lines the system administrator assigns to the intercom number for the telephone.

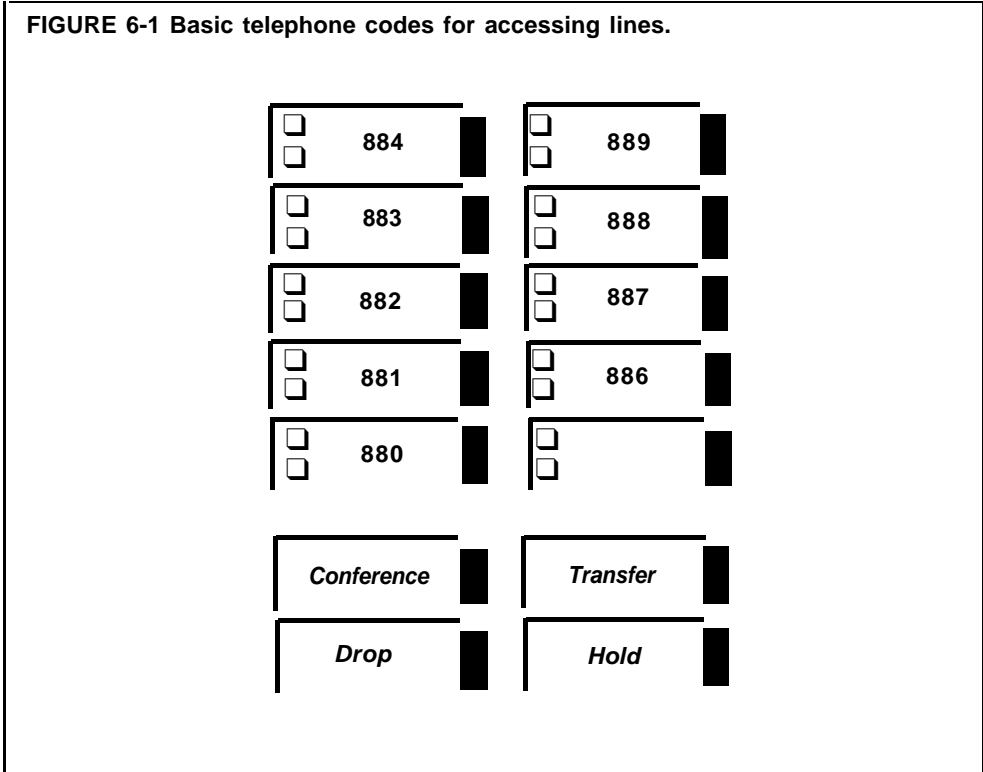

# Basic Telephone and Modem Interface 2

## DESCRIPTION

The Basic Telephone and Modem Interface 2 (BTMI 2) allows you to connect most types of telephone and data devices to your MERLIN Plus system, including auto-dial modems, facsimile machines, credit phones, and the MERLIN Attendant. See Figures 6-2 and 6-3.

FIGURE 6-2 The Basic Telephone and Modem Interface 2.

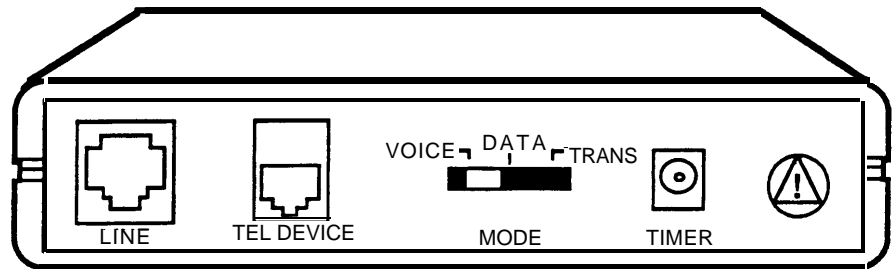
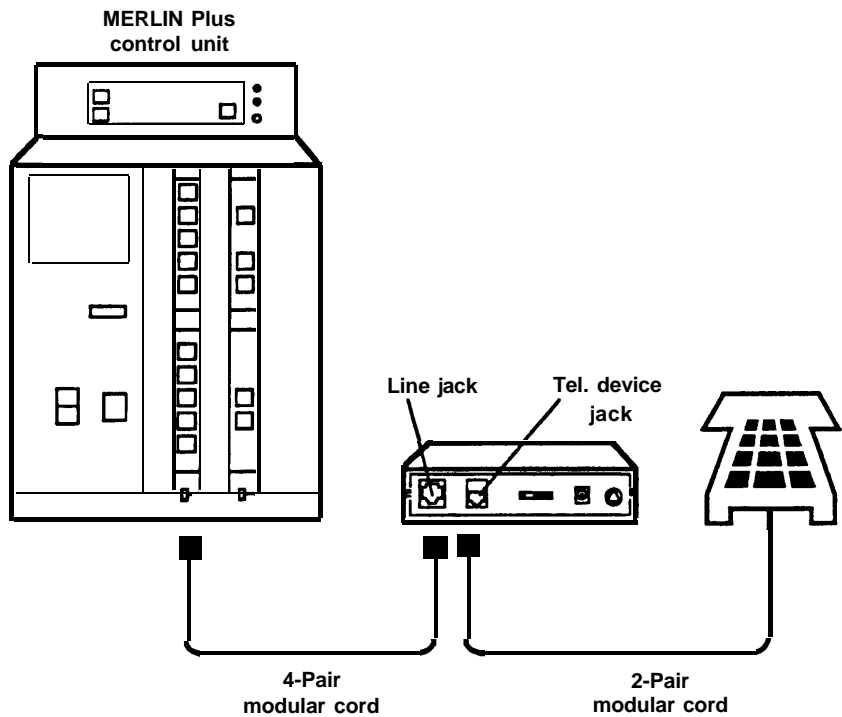

FIGURE 6-3 A basic telephone connected to a BTMI 2.



---

**CONSIDERATIONS**

The BTMI 2 works with Touch-Tone and rotary telephones.

**ADMINISTRATION**

None

**PROGRAMMING**

If you do not want the basic telephone to ring on every line, you can specify which lines ring when a call comes in using Ringing Options and programming the lines for immediate or no ring. See “Ringing Options” in this section.

You can also specify the order of lines for the phone by programming an Automatic Line Selection sequence. Be sure to program Automatic Line Selection only for those lines to be used by the basic telephone. See “Automatic Line Selection” in this section.

Basic telephones are able to receive ringing intercom calls, but *not* intercom calls with voice announcement. Therefore, you must program the Voice Announcement Disable feature for the telephone. See “Voice Announcement Disable” in this section.

In order to program Voice Announcement Disable, Ringing Options, or an Automatic Line Selection sequence for the basic telephone, you can use either the Centralized Programming feature on the administrator/attendant console or program a substitute MERLIN Plus system voice terminal plugged into the voice terminal jack designated for the BTMI 2. See “Centralized Programming” in this section.

For more information on assigning lines and features for a basic telephone, see “Basic Telephones.”

**HOW TO USE**

See the “User’s Guide for Off-Premises and Basic Telephones,” included with the BTMI 2, for instructions on how to operate a telephone connected to a BTMI 2.

A person using a basic, telephone must dial 3-character codes to access the lines the system administrator assigns to the intercom number for the telephone. For a list of these codes, see “Basic Telephones.”

# Data Collector and Printer

## DESCRIPTION

The MERLIN Plus system Data Collector uses information from the Call Report and System Feature Report features and transmits the material from the MERLIN Plus system to a printer or to a PC with a standard RS232-C, 1200 baud, serial interface. You can connect the data collector to an available voice terminal jack on the control unit.

FIGURE 6-4 A data collector connected to the MERLIN Plus system control unit and printer.

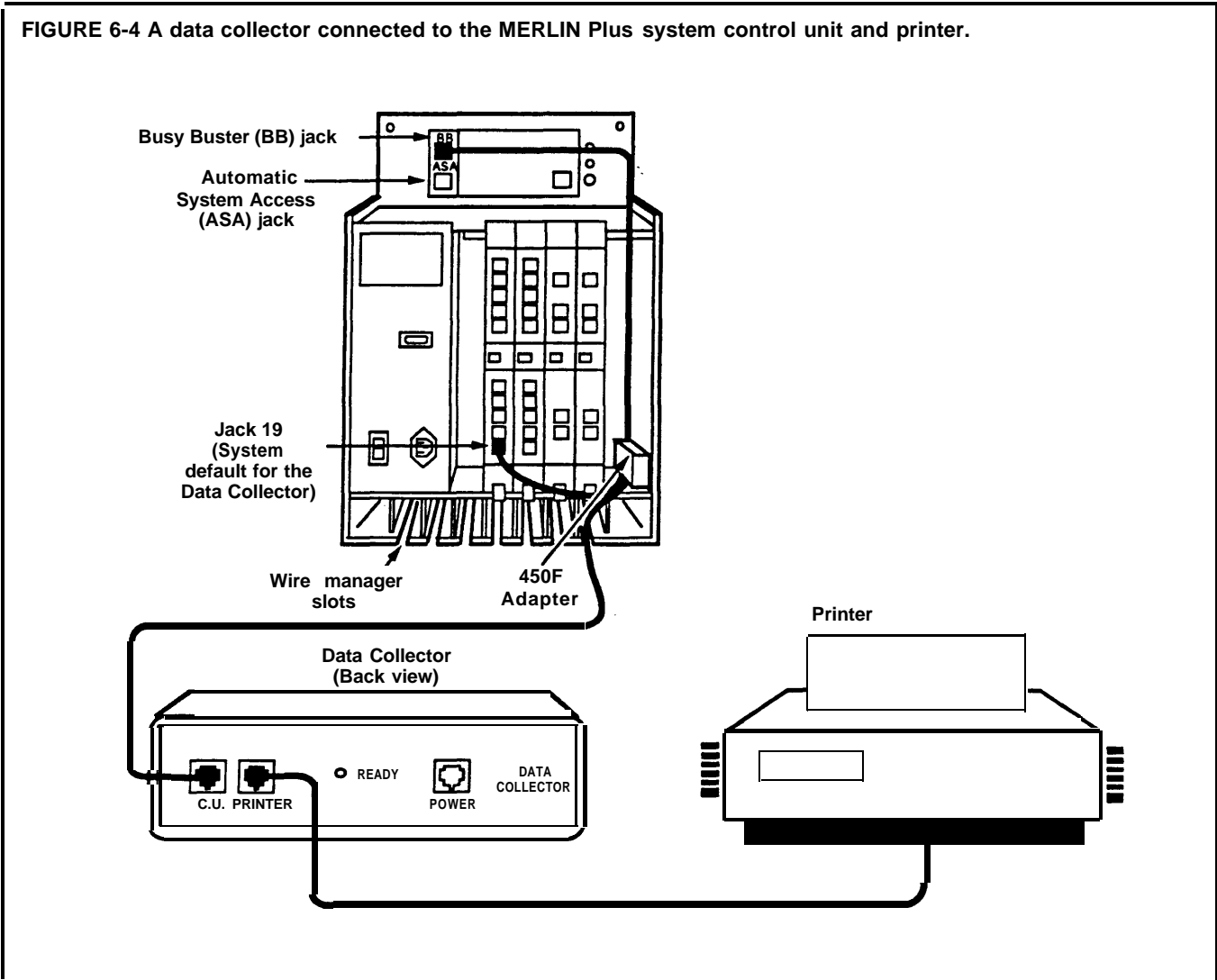

---

**CONSIDERATIONS**

An AT&T 475/476 or 572/573 printer or its equivalent is recommended to work with the MERLIN Plus system data collector.

The MERLIN Plus system is set to have the data collector and the printer connected to voice terminal jack 19, but the administrator can connect the data collector and the printer to any other voice terminal jack in the system, except jack 10. See Figure 6-4.

**NOTE:** If you are using the same printer and data collector for both the System Feature Report and the Call Report features and change the voice terminal jack assignment, you must administer the new jack assignment for *both* features.

The data collector can hold up to one full page of printout, 60 lines of 80 characters each. The collector disregards any material over the one page limit.

For proper operation of the printer with the MERLIN Plus system data collector, the printer options must be set correctly. The options and the method of selecting them varies with different printers. Consult the Customer Information Bulletin (CIB) that is provided with the data collector for the correct option settings for your AT&T 475/476 or 572/573 printer.

**ADMINISTRATION**

Refer to the CIB and System Feature Report for Administration procedures.

**PROGRAMMING**

None

**HOW TO USE**

None

# Doorphone Controller

## DESCRIPTION

A Doorphone Controller (DAC-1Z) can be connected to your MERLIN Plus system to allow employees to answer calls made from a business entrance. The controller is connected directly to a CO line port on the MERLIN PLUS control unit. Callers using the doorphone can press a button at the building entrance to ring a telephone in your MERLIN Plus system. An auxiliary alert device (such as a doorbell, chime, or tone generator) can be connected to the Doorphone Controller so that it will ring when the doorphone button is pushed.

An optional electric strikeplate release can be obtained for door operation to permit the caller to unlock the door by entering a preset code on the doorphone keypad. The electric strikeplate can also provide an alarm that sounds when the door is opened by unauthorized means or is not closed within a certain amount of time.

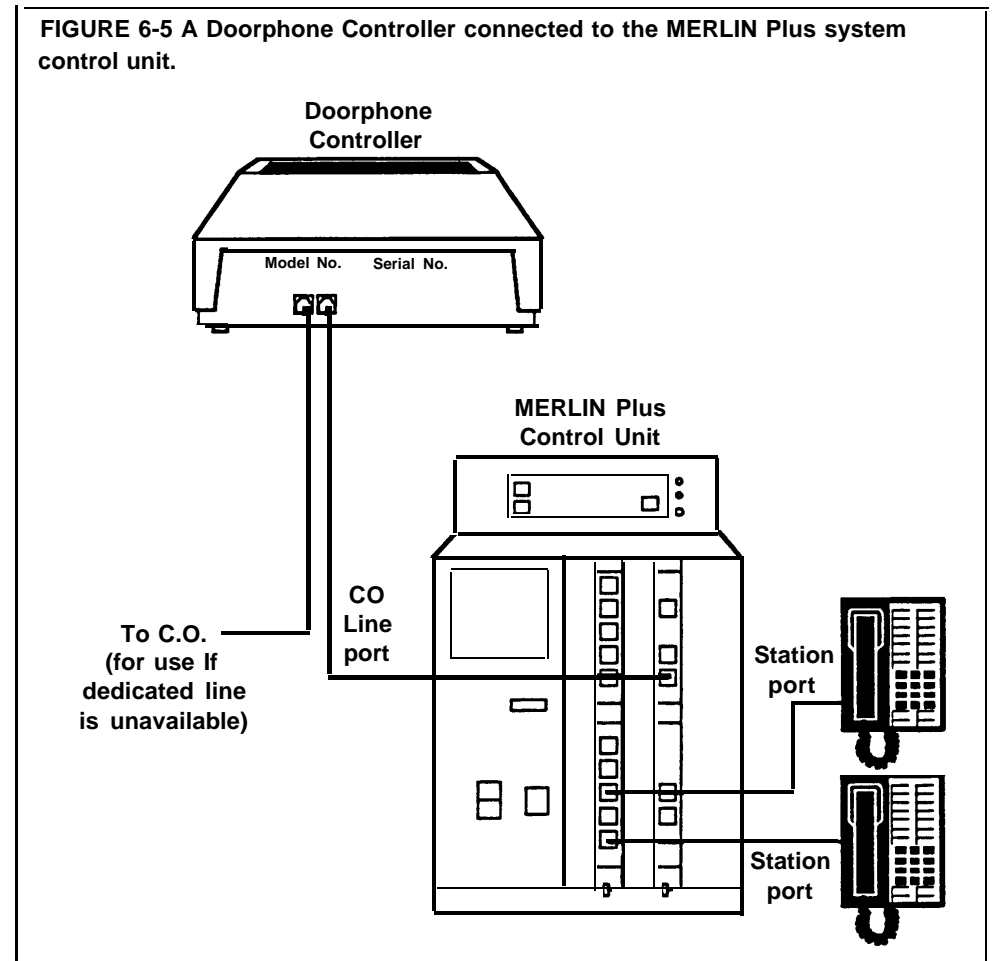

---

**CONSIDERATIONS**

You must have a licensed locksmith install any locks or electric strikeplates used for doorphone operation.

Although the Doorphone Controller can be configured to connect to either a Central Office (CO) port or a station port, it is recommended that only the CO port connection be used. The CO port to which the Door Phone Controller is connected can be dedicated to the Door Phone Controller, or shared by a CO line and the Door Phone Controller.

**ADMINISTRATION**

The CO port to which the Doorphone Controller is connected must be administered to appear on all telephones that are to answer the door. If the Doorphone Controller shares the port with a CO line, that line must appear on all telephones that are to access the CO line, as well as on any telephones that are to answer the door. (See “Customized Line Assignment.”)

**PROGRAMMING**

Refer to the *MERLIN™ Doorphone Owner’s Manual* for programming information.

**HOW TO USE****Dedicated Line**

- When the doorbell rings, pickup your telephone. You will be able to talk to whomever is calling from the door. You can also open the door by dialing the door open code or activating a switch. You disconnect by hanging up the phone.

**Shared Line Port**

- When the Doorphone Controller shares a port with a CO line, the Doorphone Controller may be set so that when you pickup the telephone, you are connected to either the doorphone or an outside line first. If the phone is set to connect to the outside line first, you must flash the switchhook (or press Recall) to connect to the door. If the phone is set to connect to the doorphone first, you must dial 9 to access an outside line. In either case, the door may be opened by dialing the door open code. The connection to the Doorphone Controller is ended by hanging up the phone.

---

## General Purpose Adapter (GPA)

### DESCRIPTION

With the General Purpose Adapter (GPA) you can connect to your voice terminal's Touch-Tone (*not* rotary) equipment such as manual dial modems, auto dialers, answering machines, and telephone extensions (including cordless telephones). See Figure 6-5.

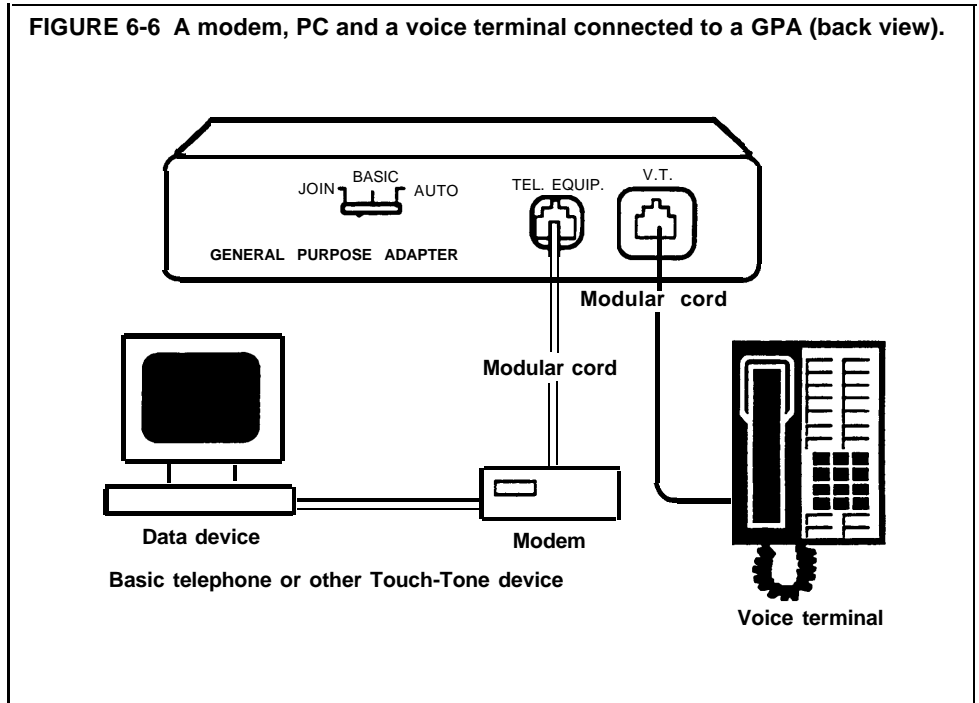

### CONSIDERATIONS

If you set the GPA to the Auto (automatic setting), you must program an Auto Answer-All button for your voice terminal: (See "Auto-Answer-All.")

### ADMINISTRATION

None

### PROGRAMMING

None



---

## HOW TO USE

You can select the switch position, labeled Join, Basic, or Auto on the adapter, required for operating the telephone or data equipment. When you have made the appropriate selection for your needs, slide the three-position option switch to the selected mode of operation. For the Joined Call Operation option, see the information that comes with the GPA.

### **Originating a Call**

- Use the Basic Operation switch position if you only originate calls with your telephone or data device. You may also answer incoming calls using your telephone or data device. However, incoming calls ring only at your voice terminal, not at the telephone or data device.

### **Using an Automatic Answering Device**

- Use the Automatic Operation switch position for using automatic answering devices. Before operating these devices, program an Auto Answer-All feature button so you can set the devices to go on automatically when you receive ringing calls.

---

## Headset and Headset Adapter

### DESCRIPTION

A Headset connected to your voice terminal by way of the Headset Adapter allows you to handle calls more easily. See Figure 6-6.

**FIGURE 6-7 A headset connected to the headset adapter.**

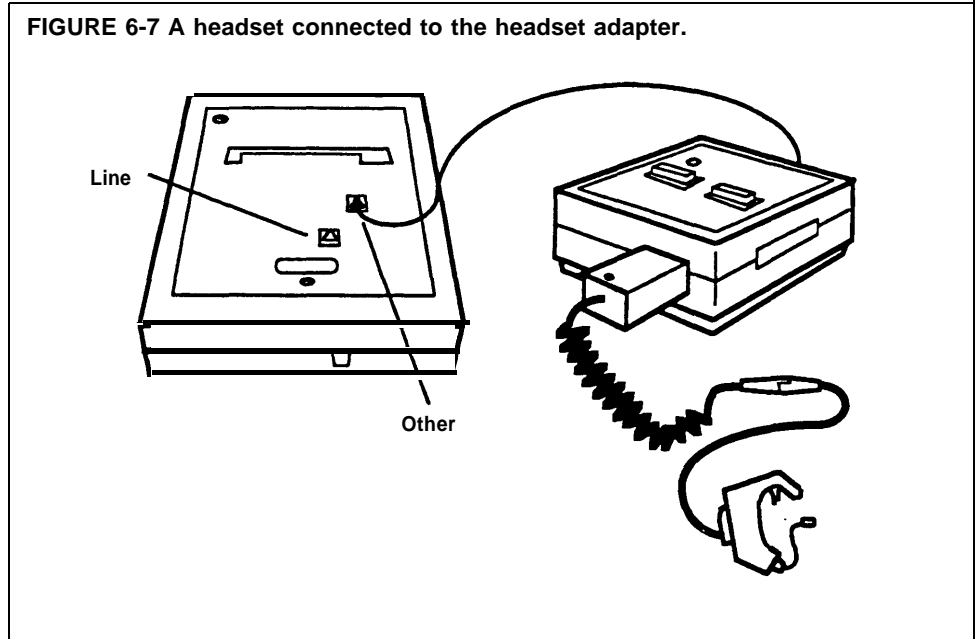

### CONSIDERATIONS

A headset cannot be used with a 5-button or a 10-button HFAI voice terminal.

The cord on the headset is plugged into the headset adapter, and the voice terminal and the adapter are connected by way of a modular cord which comes with the adapter. The headset adapter plugs into the jack labeled "Other."

### ADMINISTRATION

None

### PROGRAMMING

None

### HOW TO USE

To place a call using your headset:

- 1 Touch **On/Quiet** on the headset adapter.  
*The green light next to the button goes on.*
- 2 Dial the outside number.

To answer a call:

- 1 Touch **On/Quiet** on the headset adapter.

---

To mute the microphone:

- 1 Hold down **On/Quiet** on the headset adapter.

To hang Up:

- 1 Touch **Off** on the headset adapter.  
*The green light next to **On/Quiet** goes off.*

# Loudspeaker Paging System

## DESCRIPTION

If you have a compatible loudspeaker paging system, you can connect it to the MERLIN Plus system either through the page jack on the control unit or through a CO (outside) line jack on a line module as shown in Figures 6-7 and 6-8. You can then page people, make announcements, and provide background music (if available) throughout the building.

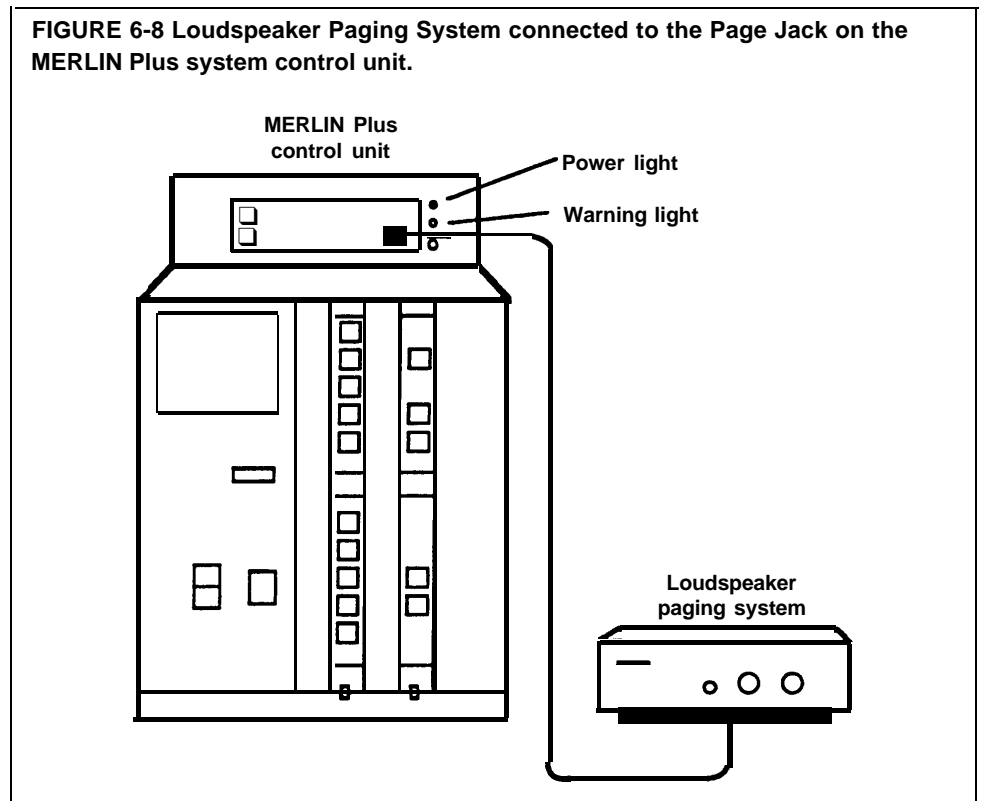

**FIGURE 6-9 Loudspeaker Paging System connected to a CO Line on a Line Module.**

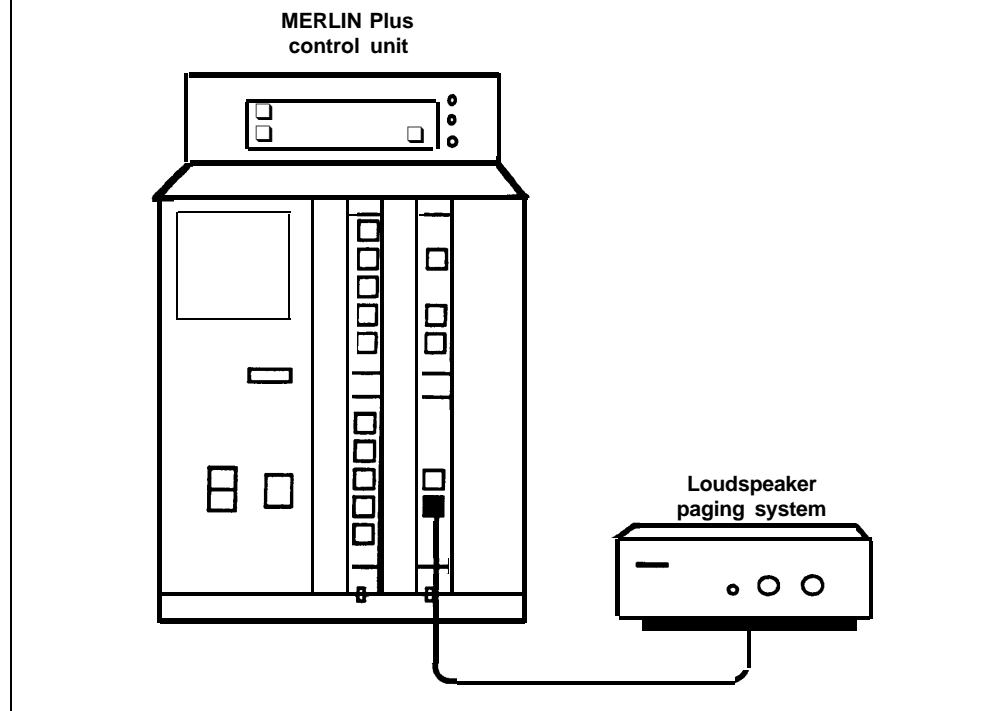

**CONSIDERATIONS**

Considerations for the Page Jack connection:

The loudness of the loudspeaker paging system is controlled by the loudspeaker paging system only.

To control the loudness of the background music throughout the building, or to turn off the background music, the system administrator can dial a code at the administrator/attendant console for the preferred volume. Background music volume can also be controlled at the music source. The following are the jack pin-out specifications for the loudspeaker paging system. Pin numbers from left to right ( 1 through 8) are:

- 4,5 for voice
- 3,6 for contact closure
- 1,2,7,8 are unused

---

Considerations for CO line connection:

If the paging unit is connected to a CO port but is administered as a paging port, it is treated differently than a CO line, and has the following restrictions:

- An auxiliary jack *cannot* be used as a paging port.
- Conferencing to this paging port or adding this port to a conference call is prohibited.
- Transferring of the paging port is prohibited.
- Bridging onto the paging port is prohibited.
- No Call Reports can be generated for this line.
- No Call Restrictions apply, therefore, even outward restricted voice terminals could use this line for toll calls.
- The volume is controlled by the loudspeaker paging system only.
- Unlike the page jack connection, the CO connection provides no signal to alert you when the loudspeaker paging system has been activated.

If you want to save available feature buttons for other features, use the dial code instead of programming a Loudspeaker Page button.

## ADMINISTRATION

If your responsibilities do not include system administration, skip this information.

Administration for the Page Jack connection:

To set the volume of background music, or to turn the music off, dial one of the following codes:

- 1 Enter administration mode by sliding the T/P switch to *P* and touching **Administer**.
- 2 Dial one of the following codes to set the volume you prefer
  - > Dial \*16 to turn off the background music.
  - > Dial \*17 to set the volume to low.
  - > Dial \*18 to set the volume to medium.
  - > Dial \*19 to set the volume to high.
- 3 Touch **Administer**.  
*The console beeps twice.*
- 4 Leave administration mode by sliding the T/P switch to the center position.

---

Administration procedures for CO line connection:

- 1 Slide the T/P switch to *P* and touch **Administer**.
- 2 Dial \*91
- 3 Touch the button for the line you want to be the paging port.

*Green light on = line added to paging port*

*Green light off = line removed from paging port*

- 4 Touch **Administer**.  
*The console beeps twice.*
- 5 Leave administration mode by sliding the T/P switch to the center position.

## PROGRAMMING

Refer to “Loudspeaker Page” earlier in this section.

## HOW TO USE

### ***Using the Loudspeaker Paging System connected to the Page Jack:***

To use the Loudspeaker Page button:

- 1 Touch **Loudspeaker Page**.
- 2 When you hear the beep, lift your handset and make your announcement.

To use this feature dialing a code:

- 1 Touch **Intercom**.
- 2 Lift your handset.
- 3 Dial 6.
- 4 When you hear the beep, make your announcement.

The loudspeaker will turn off automatically when you hang up.

### ***Using the Loudspeaker Paging System connected to a CO line:***

- 1 Touch the loudspeaker page’s line button.
- 2 Follow the instructions provided with your loudspeaker page system.
- 3 If your loudspeaker page system provides a warning tone (beep), wait for the tone before making your announcement.

---

## Music-on-Hold (MOH) and Background Music

### DESCRIPTION

When you have Music-on-Hold, you can provide background music for callers whom you have placed on hold.

The Music-on-Hold (MOH) Jack is an RCA-type phonograph jack, into which you can plug an audio system. It is on the front of the control unit behind the top cover under the red warning and the green power lights as seen in Figure 6-9.

**NOTE:** Users of equipment that rebroadcasts copyrighted music or other material may be required to obtain a copyright license from a third party such as ASCAP or BMI.

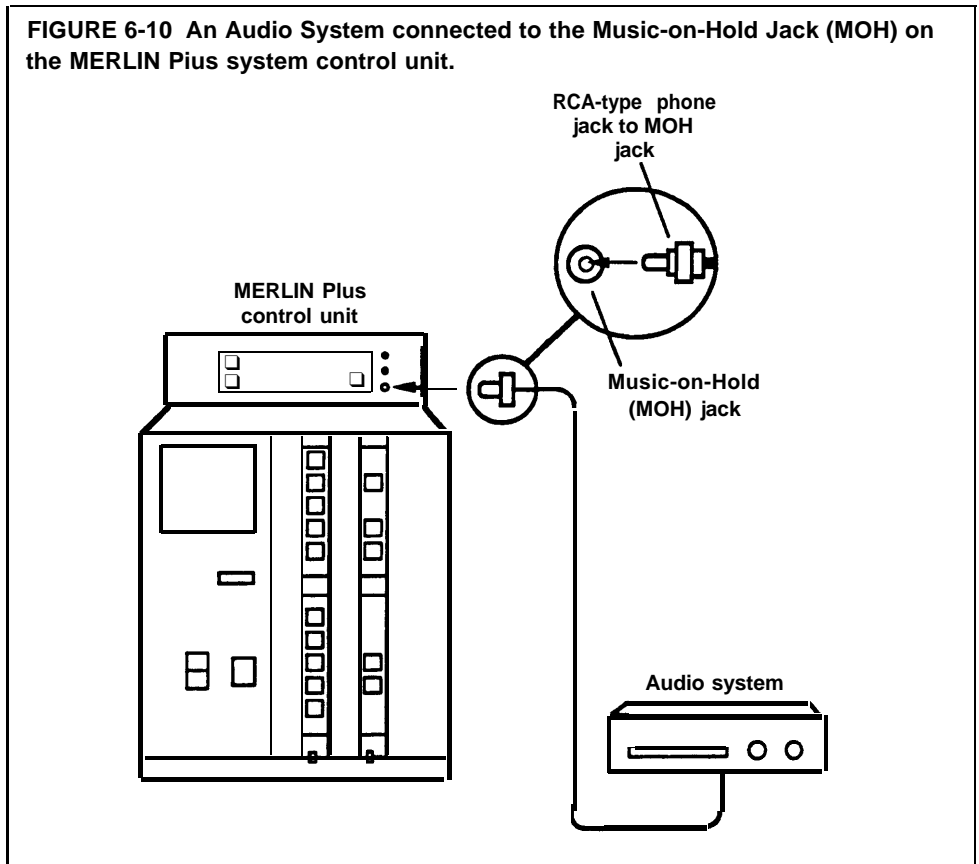

### CONSIDERATIONS

To control the loudness of the Music-on-Hold and the background music for the building, the system administrator can dial a code at the administrator/attendant voice terminal for the preferred volume. The administrator can also turn off the Music-on-Hold and background music by entering a code at the administrator/attendant console.

The system is factory-set for medium music volume. The music volume can also be controlled at the music source.

The Music-on-Hold feature is designed to accept 8-ohm impedance input, matching the output of a variety of audio sources.



---

You should use the Music-on-Hold feature with DXD so that callers can hear music when they are placed on hold. See “Direct Extension Dialing” in this section.

You can also use the Music-on-Hold feature with System Answer, so that callers hear a special prerecorded message or music while they are waiting.

## ADMINISTRATION

If your responsibilities do not include system administration, skip this information.

From the administrator/attendant console, you can set the volume for Music-on-Hold or turn it off by dialing one of the four settings listed below:

- 1 Enter administration mode by sliding the T/P switch to *P* and touching **Administer**.
- 2 Dial one of the following codes to set the volume you prefer.
  - > Dial \*12 to turn off Music-on-Hold.
  - > Dial \*13 to set the volume to low.
  - > Dial \*14 to set the volume to medium.
  - > Dial \*15 to set the volume to high.
- 3 Touch **Administer**.  
*The console beeps twice.*
- 4 Leave administration mode by sliding the T/P switch to the center position.

If you want to set the volume on the background music for the building or turn the music off, dial one of the following codes:

- 1 Enter administration mode by sliding the T/P switch to *P* and touching **Administer**.
- 2 Dial one of the following codes to set the volume you prefer:
  - > Dial \*16 to turn off the background music.
  - > Dial \*17 to set the volume to low.
  - > Dial \*18 to set the volume to medium.
  - > Dial \*19 to set the volume to high.
- 3 Touch **Administer**.  
*The console beeps twice.*
- 4 Leave administration mode by sliding the T/P switch to the center position.

## PROGRAMMING

None

## HOW TO USE

Operate your audio system according to the directions that came with the equipment.

## Supplemental Alert Adapter (SAA)

### DESCRIPTION

You can connect Extra Alert Devices, such as a bell, horn, strobe, or chime, to your system so that people working in noisy or remote areas of a building can be alerted when a call rings. See Figure 6-10. When you activate the Supplemental Alert Adapter (SAA) and a voice terminal rings, the adapter automatically activates the connected extra alert device, which gives a visual or audible signal that a call has come in.

FIGURE 6-11 An extra alert bell and a voice terminal connected to the SAA (back view).

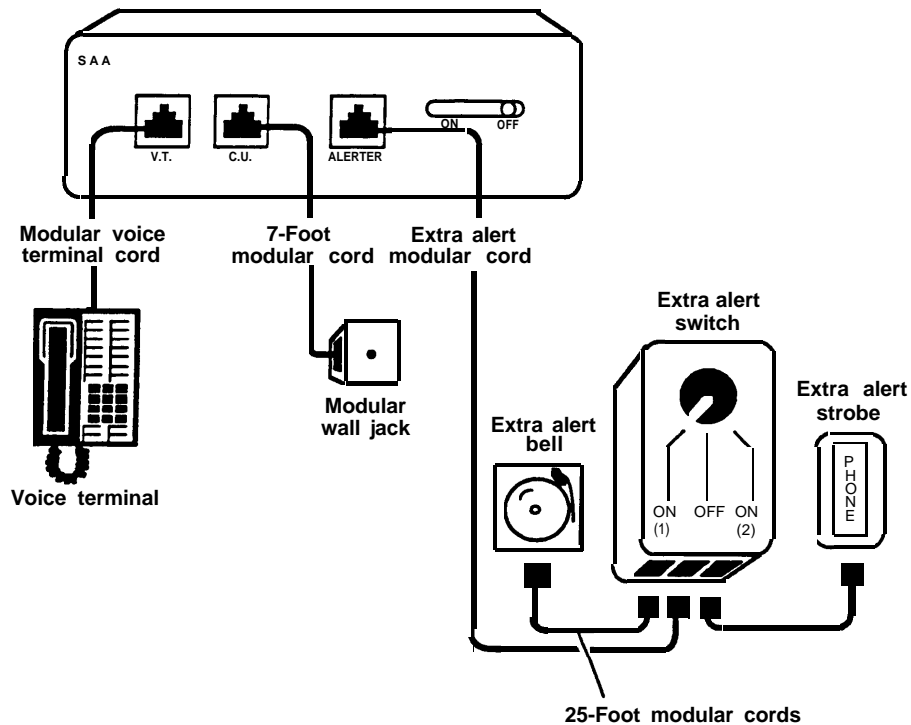

### CONSIDERATIONS

An Extra Alert Switch allows you to turn an extra alert device on and off and alternately select between two different connected alerting devices, such as a strobe during business hours and a bell off-hours. You may also alternate between two extra alert devices installed in different locations.

In addition, an extra alert switch allows you to use two extra alert devices simultaneously. However, you may need a voice terminal power supply when you have more than one extra alert device connect to the SAA. The extra alert switch is compatible with MERLIN Plus extra alert devices (-48 V).

If you want the SAA to automatically turn on the extra alert devices connected to the extra alert switch, plug the extra alert switch into the Alerter jack of the SAA.

---

If you want to use extra-alerting devices simultaneously, you need to plug the modular cord for each device into a Line Bridging Adapter which you can connect to either position (1) or position (2) on the bottom of the extra alert switch.

For more information, contact your equipment dealer.

**ADMINISTRATION**                      None

**PROGRAMMING**                        None

**HOW TO USE**                            To setup your SAA:

- 1 Unplug the appropriate voice terminal from its modular wall jack, and plug it into the jack labeled V.T. on your SAA.
- 2 Plug one end of the modular cord into the jack labeled C.U. on the SAA and the other end into the voice terminal's modular wall jack.
- 3 Plug the modular cord from the extra alert device into the jack labeled Alerter on the SAA.

To have the extra alert device turn on when a call rings at the appropriate voice terminal, turn the SAA to the *On* position.

If you want to use more than one extra alert device *alternately*:

- 1 Turn the extra alert switch's knob to the appropriate On position labeled (1) or (2). For example, if you connect a bell to position (1) and a strobe to position (2), turn the control switch to position (1) to operate the bell and to position (2) to operate the strobe.

If you want to use more than one extra alert device *simultaneously*:

- 1 Turn the extra alert switch knob to the appropriate On position labeled (1) or (2). For example, if you connect a bell *and* a strobe to a line bridging adapter and the adapter to position (1) on the SAA, turn the control switch to this position.

# Section 7: Troubleshooting the System

---

# Troubleshooting Procedures

---

As with any piece of equipment, there are times when some parts of your MERLIN Plus Communication System may not be working properly. Rather than call someone immediately, you can often determine the cause of the problem yourself. Simply follow the step-by-step procedures outlined in this section. Then, with the problem identified, you can either correct the problem yourself or know from the tables who can help you correct it. If you're having trouble with your MERLIN Plus system, locate the symptom on the next few pages and perform the recommended action to isolate and correct the problem. The symptoms are listed on the contents page of this section.

If you are unable to identify a problem, perform the System Test found on the last page of this section before calling your equipment supplier for assistance.

**SYMPTOM: CAN'T PLACE OUTSIDE CALLS.**

**Possible Cause 1:** Faulty accessory connected to voice terminal.

Do This	If	Then
Disconnect the accessory from the malfunctioning voice terminal.	The trouble no longer occurs	Do not reconnect the faulty accessory. Contact your equipment supplier to replace it.
	The trouble still occurs	Reconnect accessory and go to Possible Cause 2.

**Possible Cause 2:** System incorrectly set to Touch-Tone or rotary (pulse) service.

Do This	If	Then
Check the instructions in Section 3, "Administering the System," to determine whether your system is set for Touch-Tone or rotary (pulse) service.	The system is set to Touch-Tone and you have rotary (pulse) service	Set the system to rotary (pulse). Doing so may not solve this particular problem, but will allow you to move on to Possible Cause 3.
	The system is set to rotary and you have Touch-Tone service	Set the system to Touch-Tone.
	The system is set correctly	Go to Possible Cause 3.

(continued)

**Possible Cause 3:** Call Restriction feature activated on malfunctioning voice terminal.

Do This	If	Then
Refer to Section 5, "Reference," to learn how to administer the call Restriction feature.	The feature is activated on the malfunctioning voice terminals	Deactivate the feature following the instructions in Section 5, "Reference."
	Feature is not activated	Go to Possible Cause 4.

**Possible Cause 4:** Outside Auto Dial, Saved Number Redial or Last Number Redial are programmed or used incorrectly.

Do This	If	Then
See Section 5, "Reference" to make sure these features are programmed correctly and the <i>MERLIN Plus System User's Guide</i> to be sure the features are being used correctly.	Any of these features are programmed incorrectly	Program each feature correctly and determine whether this action solves the problem.
	Each feature is programmed correctly and the trouble still occurs	Go to Possible Cause 5.

**Possible Cause 5:** Faulty MERLIN system components.

Do This	If	Then
Try to place an outside call and an intercom call from several voice terminals.	The trouble appears only on intercom calls or the trouble appears only on one voice terminal	The trouble is caused by a component in your system. Go to the troubleshooting procedure for the symptom, "Trouble with voice terminal lights, speaker, and ringing."
	The trouble appears only on outside calls from all voice terminals, or the trouble appears on only some voice terminals	Go to Possible Cause 6.

(continued)

---

**Possible Cause 6:** Faulty telephone company wiring.

<b>Do This</b>	<b>If</b>	<b>Then</b>
At the control unit location, find the network interface associated with the outside line from which you cannot make a call. Unplug the line cord from the network interface and, in its place, plug in a basic Touch-Tone or rotary telephone. (Do <i>not</i> use a MERLIN system voice terminal.) Try to place an outside call from the telephone.	The trouble appears on the basic telephone and the network interface uses a line adapter	Go to Possible Cause 7.
	The trouble appears on the basic telephone, and the network interface does <i>not</i> have a line adapter	Your outside line is faulty. Report the trouble to your local telephone company representative.

**Possible Cause 7:** Faulty network interface line adapter.

<b>Do This</b>	<b>If</b>	<b>Then</b>
Replace the network interface line adapter with another one. Plug the basic telephone into each of the jacks, and try to place an outside call.	The trouble still appears on the basic telephone	Your outside lines are faulty. Report the trouble to your local telephone company representative.
	The trouble does <i>not</i> appear on the basic telephone	The old line adapter is faulty. Replace it with a new line adapter.

**SYMPTOM: A VOICE  
TERMINAL DOESN'T RING.**

**Possible Cause 1:** Volume control is set too low.

<b>Do This</b>	<b>If</b>	<b>Then</b>
Slide the volume control to a high setting.	The voice terminal still doesn't ring	Go to Possible Cause 2.

**Possible Cause 2:** Voice terminal is administered not to ring.

<b>Do This</b>	<b>If</b>	<b>Then</b>
Refer to Section 3, "Administering the System," to learn how to administer ringing options.	The voice terminal is programmed <i>not</i> to ring	Change the ringing option by following the instructions in Section 3, "Administering the System."
	The voice terminal is programmed to ring	Go to Possible Cause 3.

**Possible Cause 3:** Do Not Disturb feature is activated.

<b>Do This</b>	<b>If</b>	<b>Then</b>
Refer to Section 5, "Reference," to see if the Do Not Disturb feature is activated.	The feature is activated	Deactivate the feature following the instructions in Section 5, "Reference," or see the "DO Not Disturb" entry in the <i>MERLIN Plus System User's Guide</i> .
	The feature is not activated	Refer to the troubleshooting procedure for the symptom, "Trouble with voice terminal lights, speakers, and ringing."



**SYMPTOM: TROUBLE WITH VOICE TERMINAL LIGHTS, SPEAKER, AND RINGING.**

**Possible Cause 1:** Cable connection, power supply, or voice terminal.

Do This	If	Then
Slide the T/P switch on the side of the voice terminal to the <i>T</i> position and hold it there.	All the red and green lights flash alternately and a tone sounds continually	The voice terminal is working properly. Go to Possible Cause 3.
	Some red and green lights flash continually and/or a tone sounds at irregular intervals	The trouble is caused by either the voice terminal or the cable connection. Go to Possible Cause 2.
	None of the lights turn on and a tone sounds continually or irregularly	The trouble is either the control unit, the voice terminal, or the cable connection. Go to Possible Cause 2.
	The lights are dim	The trouble is a faulty control unit or power supply. Contact your equipment supplier for assistance.
	The speaker is locked on	The voice terminal T/P switch is set to <i>P</i> with Program Mode Lock active. Deactivate Program Mode Lock then set the T/P switch to the center position.

**Possible Cause 2:** Faulty voice terminal.

Do This	If	Then
Unplug the modular voice terminal cord from the malfunctioning voice terminal. Plug the cord into a working voice terminal. Slide its T/P switch to the <i>T</i> position and hold it there.	The same trouble appears on the working voice terminal	The trouble is either in the control unit or the cables. Plug the malfunctioning voice terminal into its original jack and go to Possible Cause 3.
	The trouble does <i>not</i> appear on the working voice terminal	The malfunctioning voice terminal is faulty. Contact your equipment supplier for assistance.

(continued)

**Possible Cause 3:** Cable connections.

Do This	If	Then
<p><b>Step 1.</b> Go to the control unit and locate the intercom jack for the malfunctioning voice terminal and an intercom jack for a working voice terminal. Unplug both from the control unit and replug each into the other's jack. See if the trouble now occurs on the working voice terminal.</p>	The trouble occurs on the previously working voice terminal	The problem is caused by your control unit. Call your equipment supplier for assistance.
	The trouble no longer occurs on the working voice terminal	The trouble is caused by a cable (there may be more than one) in the wiring run to the malfunctioning voice terminal. However, check the previous two causes for this symptom first. If the problem persists, go on to Step 2 of this cause.
<p><b>Step 2.</b> Test each cable in the wiring run to the malfunctioning voice terminal by following this procedure:</p> <p><b>a.</b> Connect the wiring run to a functioning voice terminal.</p> <p><b>b.</b> Replace the first cable in the wiring run with one known to be working.</p>	The trouble still occurs	Check the connection; if the connections are correct and secure, remove the second cable in the wiring run and replace it with another cable that is known to work properly. If the problem still occurs, replace the third cable in the run and so on until all the cable in the run has been replaced. If the problem still persists, call your local equipment supplier for assistance.
	The trouble no longer occurs	The cable was the source of the problem; discard the malfunctioning cable.

**SYMPTOM: A VOICE TERMINAL RINGS CONSTANTLY.**

**Possible Cause:** Voice terminal T/P switch isn't in the center position.

Do This	If	Then
Check T/P switch position.	It is set at either <i>T</i> or <i>P</i>	Slide it to the center position
	The T/P switch is in the center position	Your voice terminal is faulty. Unplug it from the modular jack and try another voice terminal in its place.

**SYMPTOM:  
A VOICE TERMINAL  
SPONTANEOUSLY  
PLACES CALLS.**

**Possible Cause:** Voice terminal is connected to the port that is administered for Busy Buster (BB).

Do This	If	Then
Check the control unit to see if the voice terminal is plugged into jack 18 (BB default) or the administered BB port.	Move the voice terminal to another port	The voice terminal should no longer spontaneously place calls.
	You need that jack for the voice terminal	Administer BB to a different jack.

**SYMPTOM: ALL VOICE  
TERMINAL LIGHTS ARE  
OUT WITH NO DIAL TONE.**

**Possible Cause 1:** Control unit is not receiving power.

Do This	If	Then
Set the control unit power switch to <i>Off</i> and then back to <i>On</i> . Doing so resets the control unit.	The green power light on the control unit is on and the trouble remains	Call your equipment supplier for assistance.
	The green power light is on and the trouble is gone	The problem was corrected when you reset the control unit.
	The green power light is off	Go to Possible Cause 2.
	The red warning light on the control unit is on	Go to Possible Cause 4.

**Possible Cause 2:** Switch-controlled power outlet.

Do This	If	Then
Make sure the control unit is not plugged into an outlet controlled by a wall switch.	The control unit is not plugged into a switch-controlled outlet	Go to Possible Cause 3.
	If the control unit is plugged into a switch-controlled outlet, turn on the switch	See if you can plug the control unit into an outlet that is not controlled by a switch.

(continued)

**Possible Cause 3:** Faulty power outlet.

Do This	If	Then
Test the outlet by plugging in an appliance such as a lamp or a radio.	The appliance doesn't work	The outlet is faulty.
	The appliance works	Go to Possible Cause 4.

**Possible Cause 4:** A module is loose.

Do This	If	Then
<p>Set the control unit power switch to <i>Off</i>.</p> <p><b>NOTE:</b> You will damage the modules if you don't turn the power off.</p> <p>Remove the top cover and then remove and replace each module, making sure each is securely seated in its slot. Replace the top cover and fasten its screw. Set the power switch back to <i>On</i>.</p>	All modules are secure and the red warning light goes off	You've solved the problem.
	All modules are secure and the red warning light remains on	Contact your equipment supplier. When calling your supplier, identify your system as the MERLIN Plus R2 system.

**SYMPTOM: PROBLEM WITH CALLS ON HOLD.**

**Possible Cause 1:** Call was inadvertently placed on exclusive hold.

Do This	If	Then
At the voice terminal that put the call on hold, touch the button of the held call.	The trouble no longer appears.	The call was placed on Exclusive Hold.
	The trouble still appears.	<p>Have another system voice terminal pick up the held call.</p> <p>Your voice terminal is faulty, contact your equipment supplier.</p>

**Possible Cause 2:** The Hold Disconnect Interval setting is different than the local telephone company's central office.

<b>Do This</b>	<b>If</b>	<b>Then</b>
Refer to "Hold Disconnect Interval" in Section 5, "Reference" for instructions to change the setting to 450 milliseconds (long) or 50 milliseconds (short) for each incoming line.	The Hold Disconnect Interval is set to 450 milliseconds (long) and callers are no longer disconnected when placed on hold	You've solved the problem.
	The Hold Disconnect Interval is set to 50 milliseconds (short) and the light indicating a held call no longer flashes after the caller hangs up	You've solved the problem.
	The light continues to flash after a caller has hung up	Contact your equipment supplier for assistance.

**SYMPTOM:  
UNSUCCESSFUL  
ATTEMPTS TO USE BUSY  
BUSTER.**

**Possible Cause 1:** Busy Buster is not connected to the port that is administered for it.

<b>Do This</b>	<b>If</b>	<b>Then</b>
Check the location of the BB cord and compare its jack number with the jack number that was administered for BB.	The cord is plugged into a jack other than the one administered for BB	Move the BB cord to the administered jack or administer the jack assignment to the current cord location.

**Possible Cause 2:** Returning Busy Buster call is not picked up quickly.

<b>Do This</b>	<b>If</b>	<b>Then</b>
Answer returning Busy Buster calls promptly when the voice terminal alerts you, so that the other party doesn't get confused by the silence and hang up	You are interrupted by other calls while waiting for a Busy Buster call	Activate the Do Not Disturb feature so that only transfer return calls, which include Busy Buster calls, will ring at your voice terminal.

**Possible Cause 3:** The Busy Buster number is in the same local exchange as the number you're calling from.

<b>Do This</b>	<b>If</b>	<b>Then</b>
Place the call again.	The number is busy.	Activate Busy Buster again.

**SYMPTOM: PROGRAMMED  
VOICE TERMINAL  
FEATURE DOESN'T WORK.**

**Possible Cause 1:** Feature is programmed or is being used incorrectly.

Do This	If	Then
<p><b>Step 1.</b> Review the programming instructions in Section 5, "Reference," to make sure the feature is programmed correctly, and the user instructions for the feature in the <i>MERLIN Plus System User's Guide</i> to make sure it is being used correctly.</p>	<p>The feature is programmed correctly and the feature still doesn't work</p>	<p>Try the feature again. If the problem persists, go to Possible Cause 2.</p>
<p><b>Step 2.</b> Turn on the Call Forwarding or Remote Line Access feature</p>	<p>The feature still doesn't work</p>	<p>Go to Step 3.</p>
<p><b>Step 3.</b> Assign a CF destination number</p>	<p>The feature still doesn't work</p>	<p>Go to Step 4.</p>
<p><b>Step 4.</b> Assign lines to the incoming line group list and/or the outgoing line group list</p>	<p>The feature still doesn't work</p>	<p>Go to Step 5.</p>
<p><b>Step 5.</b> Remove the extra lines from either the incoming or outgoing line group list</p>	<p>The feature still doesn't work</p>	<p>Go to Step 6.</p>
<p><b>Step 6.</b> Use the procedure, listed under "Custom Line Assignments" to remove "ghost lines" created by lines that do not have equipment connected to them</p>	<p>The feature still doesn't work</p>	<p>Go to Step 7.</p>
<p><b>Step 7.</b> Unplug the voice terminal from the designated Automatic System Access (ASA) jack and plug the ASA cord into the jack instead</p>	<p>The feature still doesn't work</p>	<p>Go to Possible Cause 2.</p>

(continued)

**Possible Cause 2:** Control unit or voice terminal may be defective.

Do This	If	Then
<b>Step 1.</b> Program the feature on a second voice terminal and try to use the feature.	The feature works correctly	The trouble is either the voice terminal on which the feature did not work or the control unit. To determine which, go to Step 2.
	The feature still doesn't work	The problem is in the control unit. Contact your equipment supplier for assistance.
<b>Step 2.</b> Replace the first voice terminal with a voice terminal known to be working correct] y.	The trouble remains	The problem is in the control unit. Contact your equipment supplier for assistance.
	The trouble no longer occurs	The first voice terminal is defective. Replace it.

**SYMPTOM: VOICE TERMINAL LIGHTS FLASH WHEN AN AUTOMATIC SYSTEM ACCESS FEATURE IS ACTIVATED.**

**Possible Cause 1:** No lines are assigned to the ASA incoming or outgoing line group.

Do This	If	Then
Refer to Section 5, "Reference" for instructions for administering incoming or outgoing lines for the ASA feature you want.	The feature works	Press the feature button twice to stop the flashing light.
	The feature still doesn't work	Go to Possible Cause 2.

**Possible Cause 2:** Only one line is assigned to the incoming and outgoing group and it's the same line for both.

Do This	If	Then
Incoming and outgoing lines cannot be the same line. See Section 5 "Reference" for instructions for administering two separate lines.	The feature works	Press the feature button twice to stop the flashing light.
	The feature still doesn't work	Go to Possible Cause 3.

(continued)

---

**Possible Cause 3:** A voice terminal is plugged into the ASA jack.

<b>Do This</b>	<b>If</b>	<b>Then</b>
Move the voice terminal or administer a new jack assignment for the ASA features.	The feature works	Press the feature button twice to stop the flashing light.
	The feature still doesn't work.	Go to Possible Cause 4.

**Possible Cause 4:** The ASA jack isn't administered.

<b>Do This</b>	<b>If</b>	<b>Then</b>
Refer to Section 5, "Reference" for instructions for administering the ASA jack.	The feature works	Press the feature button twice to stop the flashing light.
	The feature still doesn't work	Contact your equipment supplier.



# System Test

---

If you are experiencing a problem other than those described in the previous tests, try the following procedure before calling your equipment supplier.

**SYMPTOM: SYSTEM NOT WORKING; TROUBLE NOT DESCRIBED IN ABOVE PROCEDURES.**

**Possible Cause 1:** The control unit may need to be reset.

Do This	If	Then
Remove the front cover (see the <i>MERLIN Plus Release 2 Installation Manual</i> ). Set the control unit power switch to <i>Off</i> and then back to <i>On</i> . Replace the front cover.	The trouble remains	Go to Possible Cause 2.

**Possible Cause 2:** A module may be loose.

**WARNING:** Failure to comply with the following instructions may result in a risk of shock or damage to the equipment.

Do This	If	Then
Remove the front and top cover (see the <i>MERLIN Plus Release 2 Installation Manual</i> ). Set the control unit power switch to <i>Off</i> . Unplug all line cords and pull out each module and reinsert it so that it is securely seated in its slot. Replace the top cover and fasten its screw. Reconnect the line cords. Set the power switch to <i>On</i> . Replace the front cover.	The trouble remains	Contact your equipment supplier for assistance. When calling your supplier, identify your system as MERLIN Plus R2 system.

### ***In the Event of a Power Failure***

- The system administrator does *not* need to readminister the system after each power failure.
- The memory module has a four-day battery backup.
- The batteries are five-year life batteries and are *not* customer replaceable. Contact your equipment supplier when the system requires a replacement battery.

### ***In the Event of a Liquid Spill or Leak onto the Control Unit***

- 1 Turn off and unplug the control unit.
- 2 Contact an AT&T service technician immediately.

Insert your *MERLIN Plus Release 2 Installation Manual*  
here for future reference.

# Index

---

- 10-Button,
  - Hands-Free Answer on Intercom voice terminal, 1-7, 5-78
  - description of, 1-9
  - with headset, 6-15
  - voice terminal, 1-7
  - description of, 1-9
- 34-Button Deluxe voice terminal, 1-7
  - description of, 1-10
- 34-Button (SP-34),
  - description of, 1-10
  - with speakerphone, 1-7
- 34-Button (SP-34D),
  - description of, 1-10
  - with speakerphone and display, 1-7
- 34-Button voice terminal, 1-7
  - description of, 1-10
- 5-Button voice terminal, 1-7
  - description of, 1-9
  - with Button-Free line operation, 5-28
  - with copy, 5-54
  - with headset, 6-15
  - with send message, 5-132
- A**
- abbreviated ringing, 5-2
- accessory equipment, 6-1 — 6-24
- accessory, faulty, 7-1
- account numbers, assigning System Speed Dial codes to, 2-23, 3-41
- account number entry, 5-3 — 5-5, 5-167, 5-171
  - assign System Speed Dial codes to, 3-50
  - button, description of, 5-3
  - maximum number of characters available, 5-3
  - with Call Report, 5-43
  - with One Touch, 5-171
  - with System Speed Dial, 5-150
- adapter,
  - See* General Purpose Adapter, 6-14
- administering the system,
  - description of, 2-1
  - with customized line assignments, 5-56
- administration, 3-2 — 3-9
  - definition of, 3-1
  - initial, 3-1
  - ongoing, 3-1
- administration mode,
  - entering, 3-8
  - procedure, 3-37
  - leaving, 3-9
- administrator/attendant console, 2-1, 3-2
  - with centralized programming, 5-50
  - with System Feature Report, 5-142
- alerter jack, 6-23
- Allowed List Form, 5-6
- allowed lists, 2-18, 2-19, 2-20 — 2-21, 5-6 — 5-8
  - add an entry, 3-39, 3-48
  - add to a voice terminal, 3-48
  - administering, 3-33
  - assign to a voice terminal, 3-39, 5-8
  - assigning, 2-21
  - capacity, 3-33
  - clearing all entries, 5-7
  - creating, 2-21
  - entry form, 2-31
  - kinds of entries on, 5-6
  - maximum number of entries on, 5-6
  - naming, 2-21
  - number of, 3-33, 5-6
  - remove an entry, 3-39
  - remove from a voice terminal, 3-48
  - removing an entry, 5-7
  - setting up, 5-6
  - using with dial codes, 3-6
- Alternate Attendant, 5-9 — 5-10
- Alternate Attendant console,
  - See* attendant console, 4-9
- answering machine, 5-11, 6-2
  - See also* Auto Answer-All, 5-166
  - with Auto Answer-All, 5-12
  - with auxiliary lines, 5-22
  - with General Purpose Adapter, 6-13
- area code only,
  - administration of, 3-11
  - on System Configuration Form, 2-2
  - setting the system for, 3-49
  - dialing, 3-37
- ASA features, administering jack assignment, 3-14
- ASA jack with Direct Extension Dialing, 5-59
- assign Button-Free line operation, 2-14
- assign codes,
  - to account numbers, 3-36
  - to telephone numbers, 3-36
- assign privacy to line A or E, 3-49
- assigning lines, 3-48
  - to a voice terminal, 5-57
  - to buttons, order of, 3-25
  - to the system, 3-24
- attendant, assign an alternate to handle ASA calls, 3-45
- attendant console,
  - alternate, using, 4-9
  - Auto Intercom buttons, 4-6
  - BIS-22 voice terminal used for, 4-1
  - BIS-34 voice terminal used for, 4-1
  - BIS-34D voice terminal used for, 4-1
  - description of, 4-1 — 4-3
  - ringing options, 4-8
  - speakerphone tips, 4-10
  - using, 4-1 — 4-10
  - Group Page, 4-6, 4-7
  - Night Service, 4-8
  - send message, 4-7
  - headset, 4-9
- auto access cord, 5-21
  - with Direct Extension Dialing, 5-59
- Auto Answer intercom, 5-13 — 5-14, 5-171
- Auto Answer-All, 5-11 — 5-12, 5-166, 5-171
  - turns on answering machine, 5-166
  - turns on facsimile machine, 5-166
  - turns on modem, 5-166
  - with General Purpose Adapter, 6-13, 6-14
- Auto Intercom, 5-15 — 5-16, 5-97, 5-103, 5-167, 5-171
  - using, 4-6
  - with Speaker, 5-134
- Auto Intercom button,
  - and manual signaling button, 5-97
  - with transfer, 5-160
  - need for, 4-1
- Automatic Call Restriction Reset, 5-17

---

Automatic Line Selection, 5-18 — 5-19, 5-88, 5-168  
sequence, 2-14, 3-25  
with Button-Free line operation, 5-28  
with basic telephone, 6-6  
with copy, 5-54  
Automatic System Access, 5-20, 5-21, 5-142  
Call Forwarding, 5-91, 5-101  
Direct Extension Dialing, 5-91  
on System Configuration Form, 2-6  
Remote Line Access, 5-91  
System Answer, 5-91  
using with dial codes, 3-6  
auxiliary jack, 5-22, 6-4  
auxiliary lines, 5-22 — 5-23  
using basic telephones, 5-22  
using facsimile machines, 5-22  
using modems, 5-22  
with Privacy (on lines A and E), 5-114

**B**

Background Music, 3-13, 5-95, 6-19, 6-21 — 6-22  
set volume, 3-13, 3-48, 3-42, 6-22  
turn off, 3-48  
basic administration 3-10 — 3-23  
basic telephone, 6-4 — 6-6, 6-8  
and Modem Interface, 6-4  
and Modem Interface 2, 6-7 — 6-8  
with auxiliary lines, 5-22  
BIS speakerphone, using, 4-10  
BIS voice terminal, 5-15  
BIS-10 voice terminal, 1-7  
description of, 1-8  
limited use as attendant console, 4-1  
not recommended as console, 3-7  
BIS-22 voice terminal, 1-7  
labels for, 3-8  
as administrator/attendant console, 3-5  
as attendant console, 4-1, 4-3  
administration restrictions, 3-3  
administration with, 3-3  
description of, 1-8  
using with Send Message, 5-132  
with Message, 5-99  
BIS-22D voice terminal with display, description of, 1-8  
BIS-34 voice terminal, 1-7, 3-3  
labels for, 3-8  
with Night Service, 4-8, 5-101  
description of, 1-8, 1-9  
as attendant console, 3-4, 4-1, 4-2  
with display, 1-7, 3-3, 5-66  
bridging, 5-24  
Busy Buster, 5-25 — 5-27, 5-89, 5-103, 5-167, 5-171  
administering jack assignment, 3-15  
designating a voice terminal jack for, 3-44  
jack, 5-25  
set control unit jack for, 3-48  
unable to use, 7-9  
jack 19 reserved for, 2-6  
busy tone, 5-156  
button functions change for administration, 3-3  
button label sheets for-the administrator/attendant console, 3-7  
Button-Free feature, with copy, 5-54

Button-Free line operation, 2-14, 3-38, 5-28, 5-30  
cannot be bridged, 5-24, 5-28  
cannot use conference with, 5-28  
reassigning lines, 3-48  
setting immediate ring on a line, 3-48  
setting no ring on a line, 3-48  
with conference, 5-52  
with hold retrieve, 5-85

## C

Call Forwarding, 5-31 — 5-38  
*See also* CF/DXD.  
after-hours use, 4-8  
Call Forwarding/Remote Line Access Disconnect Timer, 5-39  
Call Pickup, 5-40 — 5-42, 5-101, 5-166, 5-171  
button, 4-8, 5-101  
using a Call Pickup button, 5-40  
using a dial code for, 5-40  
using a One-Touch Call Pickup button, 5-40  
with customized line assignments, 5-56  
with One Touch, 5-171  
Call Report, 2-23 — 2-24, 3-12, 5-43 — 5-47, 5-167, 6-9  
account number entry, 5-43  
administering jack assignment, 3-15  
control unit jack assignment, 5-46  
designating jack, 3-43  
general method of entering an account number, 5-3  
maximum number of characters available for  
account number entry, 5-3  
minimum call duration, 3-12, 5-46  
not printing a number, 3-41  
printout of, 5-43  
quick method of entering an account number, 5-3  
report call duration, 5-44  
report outgoing and incoming calls, 5-44  
report outgoing calls only, 5-44  
set control unit jack, 3-50  
set minimum call duration, 3-43, 3-50  
set type of calls printed, 3-50  
setting calls reported option, 3-43  
setting date, 3-42, 3-50, 5-45  
setting time, 3-42, 3-50, 5-45  
settings on System Feature Report, 5-142  
System Speed Dial codes with, 5-44  
type of calls documented, 5-47  
voice terminal jack 19 reserved for, 2-7  
with account number entry, 5-3 — 5-5  
with System Speed Dial, 5-152  
call restriction, 3-39, 5-6, 5-48 — 5-49, 7-2  
automatic reset, 5-17  
outward call restriction, 5-48  
reset, 5-48  
toll call restriction, 5-48  
and Allowed Lists Forms, 5-8  
assigning to voice terminals, 3-33  
Call Restriction Assignment Form, 2-31 — 2-33

---

Call Restriction Forms, 2-1, 2-18 — 2-22  
call restriction,  
  use of, 2-18  
  with copy, 5-54  
calls, handling at attendant console, 4-4 — 4-10  
calls on hold, problem with, 7-8  
calls, transferring, 4-4 — 4-6  
cancel the call, with speaker, 5-135  
central office, 2-5  
centralized programming, 3-44, 5-50 — 5-51, 5-115, 6-5  
  for Program Mode Lock, 5-117  
  using administrator/attendant console, 5-50  
Centrex, 5-136  
  with recall, 5-120  
CF/DXD Button, using, 5-170  
CF/RLA Disconnect Timer interval, to set, 3-46, 3-49  
clear template, 5-164  
  description of, 3-19  
  example, 3-19  
conference, 5-52 — 5-53, 5-166  
confirmation tone, 3-9, 5-156  
control unit, 3-2  
  function of, 1-7  
  jack assignment for the System Feature Report, 5-145  
copy, 5-54 — 5-55  
  call restrictions, 3-40  
  for Program Mode Lock, 5-117  
  from large to small voice terminal, 5-54  
  line assignments, 3-40  
  programmed features, 3-40  
  with 5-button voice terminal, 5-54  
  with customized line assignments, 5-56  
cordless telephone, 5-11  
  with General Purpose Adapter, 6-13  
custom calling,  
  features, 5-136  
  services, 5-120  
customized line assignment, 2-11, 3-25 — 3-32, 5-56 — 5-57

**D**

Data Collector, 5-46, 5-142, 6-9 — 6-10  
  capacity, 6-10  
  jack assigned to, 3-43  
  needed for printer, 2-7  
  with Call Report, 5-43  
date, setting for System Feature Report, 5-144  
delayed ring, 5-107  
  *See* ringing options, 5-128  
dial code, 3-6, 5-115  
  chart, 3-6, 3-7, 5-64, 5-75, 5-118  
  with send message, 5-133  
dial tone, 5-156  
dialer template, 5-164  
  description of, 3-20  
  example, 3-20  
dialing feedback,  
  rotary lines, 5-156  
  Touch-Tone lines, 5-156  
dictation machines, with auxiliary lines, 5-22  
Direct Extension Dialing, 5-58 — 5-62

Disallowed List, 2-18, 5-63, 5-65  
  assign to voice terminals, 3-33  
  Entry Form, 2-31  
  using with dial codes, 3-6  
disconnect a line from a conference call. *See* Drop, 5-52  
display unit, 5-66 — 5-69  
Do Not Disturb, 4-6, 5-15, 5-70 — 5-71, 5-97, 5-168, 5-171, 7-4  
drop, 5-72, 5-137, 5-166  
drop button, using with conference, 5-52  
drop,  
  in Personal Speed Dial, 5-109  
  using with conference, 5-52  
  with Outside Auto Dial, 5-105  
  with System Speed Dial, 5-151

## E

emergency numbers, 2-20  
error signal, 3-9  
error/deny tone, 5-156  
Exclusive Hold, 5-171, 7-8  
  *See* Hold-Exclusive, 5-80, 5-83  
extra alert device, 4-8, 6-23 — 6-24  
extra alert switch, 6-23

## F

facsimile machine, 5-11, 5-114, 6-4, 6-7  
  *See also* Auto Answer-All, 5-166  
  with Auto Answer-All, 5-12  
  with auxiliary lines, 5-22  
feature template, 5-164  
  description of, 3-21  
  example, 3-21  
Form,  
  Allowed Lists Entry, 2-31  
  Call Restrictions Assignment, 2-33  
  Disallowed List Entry, 2-31  
  Line Assignments, 2-1, 2-9 — 2-14, 2-29  
  System Configuration, 2-1, 2-27  
  description of, 2-2 — 2-8  
  System Speed Dial, 2-1, 2-35, 2-23 — 2-24  
  Call Restrictions, 2-1, 2-18 — 2-22

## G

General Purpose Adapter, 5-11, 6-4, 6-13 — 6-14  
ghost lines, 3-10, 5-56  
group listening, 5-73, 5-134  
  with speaker, 5-134, 5-135  
Group Page, 2-8, 5-74 — 5-77, 5-168, 5-171  
  assign voice terminals to, 3-50  
  using, 4-6 — 4-7  
  with dial codes, 3-6

## H

Hands-Free Answer on Intercom, 5-78 — 5-79, 5-166  
with Auto Answer-Intercom, 5-13  
headset, 6-1, 6-15 — 6-16  
using, 4-9  
headset adapter, 4-9, 6-15 — 6-16  
HFAI  
button light, 5-91  
using, 5-14  
voice terminal, 5-15  
HFAI/Mic button light, 5-91  
Hold, 5-80, 5-136  
in Personal Speed Dial, 5-109  
with Outside Auto Dial, 5-105  
with System Speed Dial, 5-151  
Hold Disconnect Interval, 5-81 — 5-82  
administering, 3-14  
Hold Retrieve, 5-85 — 5-86, 5-166, 5-171  
Hold-Exclusive, 5-83 — 5-84

## I

immediate ring, 5-101, 5-107  
*See* Ringing Options, 5-128  
individual Voice Terminal Reports, printout, 5-146  
intercom, 5-87  
numbers, 2-5  
numbers 11 through 29, 2-7  
button, location of, 3-25  
call with Voice Announcement, 5-87, 5-157  
preference, 5-88  
ringing, 5-87  
Intercom 10, 2-5  
attendant's location, 2-5  
system administration point, 2-5

## J

Jack,  
10, reserved for attendant console, 4-1  
19, 5-21  
designating for Call Report, 3-43

## L

Last Number Dial, 5-89 — 5-90, 5-103, 5-167, 5-171  
with Saved Number Dial, 5-130  
Last Number Redial, 7-2  
lights, 5-91 — 5-92  
line A, make private, 3-38  
line assignments, 3-24, 3-32  
customized, 3-38  
for ASA Features, 2-14  
for voice terminals, 2-9  
Line Assignments Form, 2-1, 2-9, 2-14, 2-29  
Line Bridging Adapter, 6-24  
line,  
buttons, with customized line assignments, 3-24  
E, make private, 3-38  
operation, button-free, 3-38  
line request, 5-93, 5-166

line ringing options, 2-14  
immediate ring, 2-14  
no ring, 2-14  
line select, 5-94, 5-166  
lines A and E,  
assigning privacy to, 3-49  
auxiliary jack bridged to, 5-22  
local exchange codes, 2-20  
local telephone company, source of outside lines, 2-4  
long distance,  
area codes, 2-20  
dialing, 3-11  
on System Configuration Form, 2-2  
loudspeaker page, 5-95, 5-96, 5-168, 6-17, 6-20

## M

manual signaling, 5-15, 5-97 — 5-98, 5-157, 5-169, 5-171  
button, with Auto Intercom, 5-15  
MERLIN Plus system features, 5-165  
message, 5-99, 5-169  
button light, 5-91  
message light, 4-1, 4-7, 5-99  
used with send message, 5-132, 5-169  
Microphone button light, 5-91  
minimum call duration, setting, 3-43  
modem, 5-11, 5-114, 6-4, 6-7  
*See also* Auto Answer-All, 5-166  
with Auto Answer-All, 5-12  
and computers, with auxiliary lines, 5-22  
with General Purpose Adapter, 6-13  
Monitor-on-Hold, 5-100, 5-134  
with Speaker, 5-134, 5-135  
Music-on-Hold 3-13, 6-21, 6-22  
jack, 6-21  
setting volume, 3-13, 3-42, 3-48, 6-21  
turn off, 3-48

## N

network interface, 7-3  
Night Service, 4-8, 5-101 — 5-102  
no ring, 5-107  
*See* ringing options, 5-128

## O

One-Touch Call Pickup.  
*See* Call Pickup, 5-42  
One-Touch dialing, 5-103  
Auto Intercom, 5-103  
Busy Buster, 5-103  
Last Number Dial, 5-103  
Outside Auto Dial, 5-103  
Saved Number Dial, 5-103  
System Speed Dial, 5-103  
One-Touch Transfer, 4-4  
on-hook dialing, 5-104, 5-134  
with speaker, 5-134  
original line assignments, 2-9, 2-13, 3-24  
keeping, 3-24  
on 10-button voice terminals, 2-9  
on 22-button voice terminals, 2-9  
on 34-button voice terminals, 2-9  
outgoing calls, controlling, 2-18

---

Outside Auto Dial, 5-103, 5-105 — 5-106, 5-167, 5-171, 7-2  
button, 5-105  
with Saved Number Dial, 5-130  
maximum number of characters, 5-105  
with speaker, 5-134  
with special characters, 5-136  
outside call, 5-157  
can't place, 7-1 — 7-3  
line request, 5-93  
line select, 5-94  
outside line jacks, description of, 2-4  
outside telephone lines, 2-4  
appear on buttons, 2-9  
number of administered, 3-10  
Outward Call Restriction, 5-6, 5-48  
assigning, 3-34

## P

Page-All group, 2-8, 3-17  
paging group, 2-8  
assigning, 3-41  
removing, 3-41  
administration of, 3-17  
paging group 1, 2-8  
administration of, 3-17  
paging group 2, 2-8  
administration of, 3-17  
paging jack, 5-95  
pin-out specifications, 6-18  
password.  
See System Speed Dial Codes, 5-6  
creation of, 5-123  
using with RLA mode, 5-121  
System Speed Dial Codes, 2-20  
pause, 5-136  
in Personal Speed Dial, 5-109  
in System Speed Dial Codes, 2-23  
with Outside Auto Dial, 5-105  
with System Speed Dial, 5-151  
PBX, 5-136  
with recall, 5-120  
personal lines, 5-56, 5-107 — 5-108  
Personal Speed Dial, 5-109 — 5-111, 5-167  
code, 5-3  
maximum number of characters, 5-109  
description of, 5-3  
with special characters, 5-136  
personalized ringing, 5-112, 5-157, 5-168  
with copy, 5-54  
planning forms, need for, 3-2  
planning the system, 2-1 — 2-24  
printer, 5-46, 5-142, 6-9 — 6-10  
jack assigned to, 3-43  
needed for reports, 2-7  
with Call Report, 5-43  
printout cancellation for System Feature Report, 5-147  
privacy, 5-113, 5-168, 5-171  
on lines A and E, 5-114  
private,  
line A, 3-38  
line E, 3-38

program, definition of, 3-1  
Program Mode Lock, 3-23, 5-117 — 5-119, 5-154  
programmable feature button above transfer button, 3-25  
programming erased. *See* system reset, 5-148  
programming the voice terminal, 5-115 — 5-116

## Q

Quick Reference Guide,  
Administration Codes, 3-48, 6-24  
ASA Features, 5-170  
Programming Codes, 5-171  
System Administration, 3-37 — 3-47  
suggested use, 3-1  
Voice Terminal Features, 5-166

## R

recall, 5-120, 5-137, 5-166  
in Personal Speed Dial, 5-109  
in System Speed Dial Codes, 2-23  
with Outside Auto Dial, 5-105  
with System Speed Dial, 5-151  
Receptionist/Secretary Tempdate, 5-164  
description of, 3-22  
example, 3-22  
reference, 6-24  
Remote Line Access, 5-121 — 5-125  
See also RLA, 5-121  
reset the system, 3-47, 3-51  
for Touch-Tone dialing, 5-159  
restriction override, 2-19, 3-36, 3-51, 5-6, 5-150  
assigning System Speed Dial Code with, 3-41  
marking on System Speed Dial Forms, 2-24  
retrieve,  
See Hold Retrieve, 5-85  
ring override, 4-8, 5-101, 5-126, 5-168, 5-171  
button, 5-126  
ringing,  
intercom call, 5-157  
line preference, 5-127  
options, 4-8, 5-107, 5-128 — 5-129, 5-168, 5-171, 6-5  
delayed ring, 4-8, 5-128  
immediate ring, 4-8, 5-128  
no ring, 4-8, 5-128  
with auxiliary lines, 5-22  
with basic telephone, 6-6  
with copy, 5-54  
ringing tone, 5-156  
rings, designate the number of before a call will be answered  
by ASA features, 3-46  
RLA Button, using, 5-170  
rotary dialing, 3-37  
setting the system for, 3-49  
system incorrectly set to, 7-1  
rotary signals, 5-136  
administration of, 3-10  
need to administrate, 2-2  
with Personal Speed Dial, 5-109  
with Touch-Tone Enable, 5-158  
rotary telephones with BTMI 2, 6-8

- 
- S**
- Saved Number Dial, 5-89, 5-103, 5-130 — 5-131, 5-167, 5-171
    - button, 5-130
  - Saved Number Redial, 7-2
  - Screen calls, 4-5 — 4-6, 5-107
  - Send Message, 4-7, 5-99, 5-132 — 5-133, 5-169
    - dial code chart, 5-133
    - dial code, using, 4-7
  - serial interface for data collector, 6-9
  - setting date.
    - See* Call Report, 5-45
  - setting time.
    - See* Call Report, 5-45
  - setting volume for background music, 6-22
  - SMDR.
    - See* Call Report, 2-23, 5-3
  - speaker, 5-73, 5-134, 5-135
    - with Monitor-on-Hold, 5-100
    - with On-Hook Dialing, 5-104
    - on voice terminals, 2-7
  - speakerphone button light, 5-91
  - special characters in dialing sequences, 5-105, 5-109, 5-136, 5-137
    - Drop, 5-137
    - Hold, 5-136
    - Pause, 5-136
    - Recall, 5-137
    - stop, 5-137
  - Switchhook flash, 5-137
  - Touch-Tone Enable, 5-137
  - Transfer, 5-137
    - with System Speed Dial, 5-151
  - speed dial.
    - See* System Speed Dial, 5-3
  - speed dial codes, 2-18
  - Station Message Detail Recording.
    - See* Call Report, 5-43
  - Stop character, with Busy Buster, 5-25
  - stop, 5-136
    - in Personal Speed Dial, 5-109
    - in System Speed Dial Codes, 2-23
    - with Outside Auto Dial, 5-105
    - with System Speed Dial, 5-151
  - Supplemental Alert Adapter, 4-8, 5-101, 6-23, 6-24
  - switchhook flash, 5-136, 6-4
    - in Personal Speed Dial, 5-109
    - in System Speed Dial Codes, 2-23
    - with Outside Auto Dial, 5-105
    - with Recall, 5-120
    - with System Speed Dial, 5-151
    - with Conference, 5-52, 5-72
  - System Administration Report, printout, 5-146
  - System Administrator, 1-4
  - System Answer, 5-138, 5-141
    - activating, 4-9
    - with copy, 5-54
  - System Answer Button,
    - using, 5-170
  - system components, description of, 3-2
  - System Configuration Form, 2-1, 2-27
    - description of, 2-2 — 2-8
    - use for basic administration, 3-10
    - using reformation from, 2-9
  - System Feature Report, 5-142, 5-147, 6-9
    - abort and cancel, 3-43
    - administering jack assignment, 3-16
    - administrator/attendant console with, 5-142
    - Call Report settings on, 5-142
    - cancel a report in progress, 3-49
    - cancel all report requests, 3-49
    - control unit jack assignment for, 5-145
    - individual phone reports, 3-43
    - individual voice terminal reports, 3-49
    - system and individual voice terminal reports, 3-49
    - whole system reports, 3-49
    - printout, 3-43
    - printout cancellation, 5-147
    - set control unit jack, 3-50
    - setting date, 5-144
    - setting time, 5-144
    - system administration report, 3-43
  - System Speed Dial numbers on, 5-142
  - Transfer Return Interval on, 5-142
    - using with dial codes, 3-6
  - voice terminal Allowed List assignments on, 5-142
  - voice terminal jack 19 reserved for, 2-7
  - system, planning the, 2-1 — 2-24
  - system processing flowchart, 2-22
  - system reset, 5-148 — 5-149
  - system,
    - setting for area code only, 3-49
    - setting for rotary dialing, 3-49
    - setting for toll prefix, 3-49
    - setting for Touch-Tone dialing, 3-49
  - System Speed Dial, 5-103, 5-150 — 5-153, 5-167, 5-171
    - account number entry, 5-150
    - code, 5-3, 5-4, 5-150
      - assigned to telephone numbers, 3-36
      - assigning, 2-23, 3-41
      - assigning to account numbers for account number entry, 3-50
      - assigning to outside telephone numbers, 3-50
      - assigning to private outside telephone numbers, 3-50
      - assigning with Restriction Override to outside telephone numbers, 3-51
      - assigning with Restriction Override to private outside telephone numbers, 3-51
      - maximum number of digits, 5-150
      - printed on Call Report, 5-44
      - with Restriction Override, 2-20, 5-6
      - with account number entry, 5-5
    - description of, 5-3
    - numbers on System Feature Report, 5-142
    - option, administering, 3-36
    - with account number entry, 5-3 — 5-5
    - with Call Report, 5-44
    - with Restriction Override, 5-150, 5-152
    - with special characters, 5-136
  - System Speed Dial Form, 2-1, 2-23 — 2-24, 2-35, 3-36, 5-4
  - system test, 7-1
    - troubleshooting procedure, 7-13
  - systemwide options, 3-33



## T

- telecommunication devices for the deaf, with auxiliary lines, 5-22
- telephone number,
  - privacy with Call Report, 5-44
  - to forward calls to, change, 3-46
  - to forward calls to, enter, 3-46
- assigning System Speed Dial codes to, 2-23
- telephones.
  - See* voice terminals, 5-1
- testing the voice terminal, 5-154
- Test/Program switch, 5-115, 5-154
  - explanation of, 3-3
  - locked, 5-117
- time, setting for System Feature Report, 5-144
- Toll Call Restriction, 5-6, 5-48
  - assigning, 3-34
- toll prefix,
  - on System Configuration Form, 2-2
  - setting, 3-49, 5-155
  - system factory set for, 3-11
  - dialing, 3-37
- tones, 5-156, 5-157
- Touch-Tone dialing, 3-37
  - setting the system for, 3-49, 5-159
- Touch-Tone Enable, 5-158, 5-166, 5-171
  - in Personal Speed Dial, 5-109
  - in System Speed Dial Codes, 2-23
  - with Outside Auto Dial, 5-105
  - with System Speed Dial, 5-151
- Touch-Tone equipment with General Purpose Adapter, 6-13
- Touch-Tone lines, 1-3
- Touch-Tone or rotary setting, 5-159
- Touch-Tone service, system incorrectly set to, 7-1
- Touch-Tone signals, 5-136
  - system set for, 2-2
  - signals with Personal Speed Dial, 5-109
- Touch-Tone telephones with BTMI 2, 6-8
- Touch-Tones, system factory set for, 3-10
- T/P switch, 7-5, 7-6
  - to enter administration mode, 3-8
- transfer, 5-137, 5-160, 5-161, 5-166
  - button, 5-160
  - in Personal Speed Dial, 5-109
  - with Outside Auto Dial, 5-105
  - with System Speed Dial, 5-151
- Transfer Return Interval, 3-11, 5-160, 5-162
  - administration of, 3-11
  - on System Configuration Form, 2-3
  - on System Feature Report, 5-142
  - setting, 3-41
  - with Direct Extension Dialing, 5-59
- transferred call, 4-4 — 4-6, 5-157
  - with voice announcement, 5-157
- troubleshooting procedures, 7-1, 7-12

## V

- voice announcement, 5-15
  - Disable, 4-5, 5-15, 5-160, 5-168, 5-171, 6-5
    - and transferred calls, 4-4
    - on HFAI voice terminal, 5-163
    - with basic telephone, 6-5
    - with Group Page, 5-74
    - with hands-free units, 5-163
  - Enable, 5-171
  - Enable/Disable, 5-87, 5-163
    - with copy, 5-54
  - voice signal tone, 5-156
- Voice Synthesis Processor, 4-8, 5-21, 5-101
  - with Direct Extension Dialing, 5-58
- voice terminal,
  - Allowed List assignments on System Feature Report, 5-142
  - assigning lines to, 5-57
  - definition of, 2-5
  - doesn't ring, 7-4
  - jack, 2-5
  - jack 19 for Busy Buster, 2-6
  - jack assignments, administering, 3-14
  - lights,
    - are out with no dial tone (begin), 7-8
    - flash when an ASA feature is activated, 7-11
    - trouble with, 7-5, 7-6
  - programmed feature doesn't work, 7-10
  - ringing, trouble with, 7-5 — 7-6
  - rings constantly, 7-6
  - speaker,
    - trouble with, 7-5 — 7-6
    - with group listening, 5-73
  - spontaneously places calls, 7-7
  - templates, 3-18 — 3-22, 5-164 — 5-165
  - tones, 5-166
    - description of, 1-7, 1-11, 5-1
    - outward call restricted, 2-20
  - restricted, 2-18
  - toll restricted, 2-19
  - unrestricted, 2-19
  - setting for Music-on-Hold, 6-21