

# ESI Communications Servers

ESI-1000 • ESI-600 • ESI-200 • ESI-100 • ESI-50

---

## Hardware Installation Manual

0450-1049  
Rev. U

Copyright © 2013 ESI (Estech Systems, Inc.).

*IVX* is a registered trademark of Estech Systems, Inc. *Ethernet* is a registered trademark of Xerox Corporation. *Motorola* and *ColdFire* are registered trademarks of Motorola, Inc. *Rayovac* is a registered trademark of Rayovac Corporation. *Act!* is a registered trademark of Symantec Corporation. *Goldmine* is a trademark of Goldmine Software Corporation. *Microsoft*, *Windows*, *NT* and *Outlook* are registered trademarks of Microsoft Corporation. *Panasonic* and *DBS* are registered trademarks of Matsushita Electric Corporation of America. *Novell* and *Netware* are registered trademarks of Novell, Inc. *Smart Jack* is a trademark of Westell Technologies, Inc. Information contained herein is subject to change without notice. Certain features described herein may not be available at initial release. ESI products are protected by various U.S. Patents, granted and pending. Visit ESI on the Web at [www.esi-estech.com](http://www.esi-estech.com).



*We Make It Easy To Communicate*

# Contents

<b>Overview.....</b>	<b>A.1</b>	<b>Hardware installation: ESI-50.....</b>	<b>H.1</b>
Cabinet components.....	A.1	Site location.....	H.1
Base Cabinet.....	A.1	Opening the Base Cabinet.....	H.2
Expansion Cabinets.....	A.2	Mounting the Base Cabinet.....	H.2
Main board.....	A.2	Expansion Cabinet installation.....	H.3
Backplane.....	A.2	Port card installation.....	H.3
Memory Module.....	A.3	Memory Module installation or replacement.....	H.5
Power supply.....	A.3	LED functions.....	H.6
Port card options.....	A.4	ESI Presence Management installation.....	H.7
NSP.....	A.7	ESI Cellular Management installation.....	H.7
		Installation of card(s) for ESI Mobile Messaging and SIP trunking.....	H.8
		Installation of Memory Module for CS-ASC.....	H.9
<b>Phones.....</b>	<b>B.1</b>	<b>External connections.....</b>	<b>I.1</b>
Digital phone models.....	B.1	Grounding instructions.....	I.1
IP phone models.....	B.2	Power.....	I.1
ESI Cordless Handsets.....	B.3	MOH port.....	I.3
Expansion Consoles.....	B.4	Maintenance/SMDR serial port.....	I.3
Phone overlays.....	B.4	External paging device connection.....	I.4
VIP Softphone.....	B.4	Amphenol cable connections.....	I.4
		CO line connection.....	I.5
<b>Licensing.....</b>	<b>C.1</b>	Station connection.....	I.7
		60-Key Expansion Console connection.....	I.8
<b>System capacities.....</b>	<b>D.1</b>	60-Key Second Expansion Console connection.....	I.9
		Installing ESI's Cordless Handsets.....	I.10
<b>Cautions and regulatory information.....</b>	<b>E.1</b>	Port card connections.....	I.13
Cautions.....	E.1	Cabinet worksheets.....	I.23
Regulatory information.....	E.2	<b>Ordering and installing PRI circuits.....</b>	<b>J.1</b>
		PRI configuration description.....	J.1
<b>Hardware installation: ESI-1000, ESI-600, ESI-200 ....</b>	<b>F.1</b>	<b>Index</b>	
Site location.....	F.1		
Mounting the cabinet(s).....	F.1		
Expansion Cabinet installation.....	F.2		
Port card installation.....	F.2		
About replacing port cards.....	F.4		
Memory Module installation or replacement.....	F.5		
Removing the Memory Module from the main board.....	F.8		
Mirrored Memory Module.....	F.9		
LED functions.....	F.15		
ESI Presence Management installation.....	F.16		
ESI Cellular Management installation.....	F.16		
Installation of card(s) for ESI Mobile Messaging and SIP trunking.....	F.17		
Installation of Memory Module for CS-ASC.....	F.18		
<b>Hardware installation: ESI-100 .....</b>	<b>G.1</b>		
Site location.....	G.1		
Opening the Base Cabinet.....	G.2		
Mounting the Base Cabinet.....	G.2		
Expansion Cabinet installation.....	G.3		
Port card installation.....	G.3		
Memory Module installation or replacement.....	G.5		
LED functions.....	G.6		
ESI Presence Management installation.....	G.7		
ESI Cellular Management installation.....	G.7		
Installation of card(s) for ESI Mobile Messaging and SIP trunking.....	G.8		
Installation of Memory Module for CS-ASC.....	G.10		

**Important:** For information concerning the **programming** of an **ESI Communications Server** (the **ESI-1000, ESI-600, ESI-200, ESI-100, or ESI-50**), see the *ESI Communications Servers Programming Manual* (ESI document # 0450-1050).

Statements in this document about ESI Communications Servers as a group **do NOT** pertain to the ESI-50L, which must be upgraded to ESI-50 status to provide a number of usual ESI Communications Server features (particularly those related to automatic call distribution, IP capabilities, and use of PRI). For information concerning hardware installation of the the ESI-50L, please see the *ESI-50L Hardware Installation Manual* (ESI document # 0450-1159).

The 48-Key Feature Phone has a dedicated **PROGRAM** key. If using a 48-Key Feature Phone, (a.) press **PROGRAM** wherever the instructions tell you to press **PROG/HELP** to access programming. and (b.) press **HELP** wherever the instructions tell you to press **PROG/HELP** to access the Verbal User's Guide.

# Overview

## Cabinet components

### *ESI-1000, ESI-600, and ESI-200*

Cabinet components<sup>1</sup> for the ESI-1000, ESI-600, and ESI-200 consist of:

- **Base Cabinet**
  - Main board
  - Backplane
  - Memory Module
  - Seven port card slots
  - External wall-mounted power supply
- **Expansion Cabinet (optional)**
  - Backplane
  - Seven port card slots
  - Expansion cable
  - Expansion Card
  - External wall-mounted power supply

### *ESI-100*

The ESI-100's cabinet components<sup>1</sup> consist of:

- **Base Cabinet**
  - Main board
  - Memory Module
  - Two port card slots
  - External wall-mounted power supply
- **Expansion Cabinet (optional)**
  - Two port card slots

### *ESI-50*

The ESI-50's cabinet components<sup>1</sup> consist of:

- **Base Cabinet**
  - Main board with built-in 482 and SL-IVC 12 port cards
  - Memory Module
  - One port card slot
  - External wall-mounted power supply
- **Expansion Cabinet (optional)**
  - Two port card slots

## Base Cabinet

The ESI Communications Server **Base Cabinet** is designed for easy installation and component access. Regardless of model, each ESI Communications Server Base Cabinet houses the main board, Memory Module, Network Services Processor (NSP), one multi-purpose serial port, and an MOH connector.

### *ESI-1000, ESI-600, and ESI-200*

The Base Cabinet for the ESI-1000, ESI-600, and ESI-200, which measures 19" W × 10.5" H × 10.5" D, also houses the Mirrored Memory Module (M3)<sup>2</sup> and seven port card slots (see "Port card options," page A.4).

### *ESI-100*

The Base Cabinet for the ESI-100, which measures 8.5" W × 11" H × 3" D, also houses two port card slots (see "Port card options," page A.4).

### *ESI-50*

The Base Cabinet for the ESI-50, which measures 8.5" W × 11" H × 3" D, has a main board with built-in 482 and IVC 12 port cards. it also houses an additional port card slot (see "Port card options," page A.4).

<sup>1</sup> Memory Modules and port cards are packaged separately and are mounted in each system's cabinet during installation.

<sup>2</sup> The M3 **interface** is standard on the ESI-1000, optional on the ESI-600 and hard drive-equipped ESI-200. Each requires an optional second Memory Module.

## Expansion Cabinets

Each ESI Communications Server can be **expanded** to increase the number of port cards. The ESI-1000 and ESI-600 each accept the same Expansion Cabinet, while the ESI-200, ESI-100, and ESI-50 have their own unique Expansion Cabinets.

System	Maximum Expansion Cabinets	Maximum port cards per Expansion Cabinet	Total system capacity (port cards)
ESI-1000	5	7	42
ESI-600	3	7	28
ESI-200	1	7	14
ESI-100	1	2	4
ESI-50	1	2	3 (plus a built-in 482 and IVC 12)

## Main board

The main board combines leading-edge hardware components — including a Motorola® ColdFire® processor and DSP structure — along with proprietary operating system software. The board provides: system control of the Memory Module and port cards; a standard RS-232C DB9 serial port; a built-in modem for remote access; an external paging-device interface; MOH interface; an NSP, which provides remote access via TCP/IP and supports certain optional ESI PC software applications; and (except on the ESI-100 and ESI-50) a mount for the Mirrored Memory Module.<sup>1</sup>

## Backplane

On the ESI-1000, ESI-600, and ESI-200, each cabinet (Base or Expansion) is equipped with a backplane that supports up to seven port cards.

---

<sup>1</sup> The M3 **interface** is standard on the ESI-1000, optional on the ESI-600 and hard drive-equipped ESI-200. Each requires an optional second Memory Module.

## Memory Module

The **Memory Module** — a hard disk drive or CompactFlash® with **proprietary formatting** — contains all system programming and configuration data, and pre-loaded voice prompts. The Memory Module provides voice storage at 64 kilobits per second — the industry’s highest-quality sampling rate. Here are the capacities by system model:

Memory Module type	ESI-1000	ESI-600	ESI-200	ESI-100	ESI-50
CompactFlash	n/a	n/a	140-hr.	140-hr.	15-hr. and 60-hr.
Hard-disk drive	1,200-hr.	1,200-hr.	600-hr.	n/a	n/a

### Optional Mirrored Memory Module (M3)

**Note:** Not available on the ESI-200 with CompactFlash, ESI-100, or ESI-50.

Using RAID-1 hard drive technology, the optional Mirrored Memory Module (M3) maintains system operation on a separate disk drive in the event of a hard drive failure. M3 is required when redundancy of system programming, speed-dial entries, and voice mail messages and prompts is desired.

**Note:** M3 use on the ESI-200 requires that both Memory Modules be the 600-hour (hard-disk drive) model.

## Power supply

All power supplies are included at purchase.

- **ESI-1000, ESI-600, or ESI-200** — Uses a 7.5-amp, 24 VAC power supply on the Base Cabinet and each Expansion Cabinet.
- **ESI-100** — Uses a 5-amp, 24 VAC power supply.
- **ESI-50** — Uses a 3-amp, 24 VAC power supply.

### Optional rack-mount Power Distribution Shelf

The optional **Power Distribution Shelf** can be mounted in a standard 19-inch rack. Each Power Distribution Shelf, which can hold up to four power supplies, includes a six-outlet power strip with on/off switch and 15’ power cord.

## Port card options

ESI Communications Servers support a wide range of port cards. Any **E2** port card can be used on any ESI Communications Server with the use of an additional E2 Port Card “Hot Swap” Adapter (except on the ESI-100).<sup>1</sup> The **CS** port cards (used with the ESI-1000, ESI-600, and ESI-200) are full-size cards with built-in “hot-swap” capability, along with a special “ejector-handle” mechanism that makes them literally a snap to install or uninstall. The following port cards are supported:

Port card	Ports				System maximums (port cards)				
	COs	Stations <sup>2</sup>	Analog stations	Esi-Link channels	ESI-1000	ESI-600	ESI-200	ESI-100	ESI-50
CS-684	6	8 digital	4		42	28	14		
CS-612	6	12 digital			42	28	14		
CS-6ALC	6				42	28	14		
CS-A12			12		32	15	4		
CS-D12		12 digital			42	28	14		
CS-DLC12	24 (T1) or 23B +1D (PRI)	12 digital			10	6	3		
CS-DLC	24 (T1) or 23B +1D (PRI)				10	6	3		
CS-IVC 24R		24 IP			34	17	8		
CS-IVC 24EL				24	4	2	1		
CS-IVC 12R12EL		12 IP		12	4	2	1		
E2-684	6	8 digital	4		42	28	14	4	
E2-612	6	12 digital			42	28	14	4	
ESI-6ALC	6				42	28	14	4	
E2-A4 <sup>3</sup>			4		32	15	4	2	
E2-A12			12		32	15	4	2	
E2-D12		12 digital			42	28	14	4	
E2-DLC12	24 (T1) or 23B +1D (PRI)	12 digital			10	6	3	1	
ESI-DLC	24 (T1) or 23B +1D (PRI)				10	6	3	1	
IVC 24R <sup>4</sup>		24 IP			34	17	8	3	
IVC 24EL				24	4	2	1	1	
IVC 12R12EL		12 IP		12	4	2	1	1	
SL-DLC82	23B +1D (PRI)	8 digital	2						1
482	4	8 digital	2						4 <sup>5</sup>
SL-IVC 12		12 local IP or 8 remote IP		8					1 <sup>6</sup>
CS-SIP24	24				10	6	3	1	1
CS-SIP8	8				10	6	3	1	1
CS-ASC					20	14	7	1	1

The cards are described beginning on the next page.

**Warning:** Any port card shipped prior to March 16, 2007, **will NOT** boot on the second cabinet of an ESI-200. However, these cards **can** be updated. For details and the update procedure, see *Technical Update 264*, available from [www.esi-estech.com](http://www.esi-estech.com).

<sup>1</sup> See “Hot-swap operations,” page A.7.

<sup>2</sup> For each IVC, the quantity of IP stations is a combination of locally and remotely installed IP phones.

<sup>3</sup> Not supported on the ESI-50 (or ESI-50L).

<sup>4</sup> Previously called *IVCR24*.

<sup>5</sup> One of the four 482 cards is built-in (ESI-50 only).

<sup>6</sup> Built into the main board (ESI-50 only); see also “Port card descriptions,” page A.5.

**Port card descriptions**

- **CS-684, E2-684** — Connects up to six analog loop-start CO lines, eight ESI digital phones, and four analog station ports. The CO line ports support standard CO and Centrex loop-start lines (but not ground-start CO lines). The analog ports provide a standard 24-volt, two-wire connection to fax machines, courtesy phones, modems, etc. Only one device can be connected to each analog station port. This card uses 12 station ports and six CO ports.
- **CS-612, E2-612** — Provides circuits to connect up to six analog loop-start CO lines and 12 ESI digital phones. Ground-start CO lines are not supported. This card uses 12 station ports and six CO ports.
- **CS-6ALC, ESI-6ALC** — Similar to the CS-612 and E2-612, but connects only up to six analog loop-start CO lines (and no stations).
- **E2-A4<sup>1</sup>** — Connects up to four analog devices (only), such as fax machines and cordless phones. This card uses four station ports and no CO ports. Each port provides a standard 24-volt, two-wire phone connection. Only one analog device can be connected to each port.
- **CS-A12, E2-A12** — Connects up to 12 analog devices (only), such as fax machines and cordless phones. This card uses 12 station ports and no CO ports. Each port provides a standard 24-volt, two-wire phone connection. Only one analog device can be connected to each port.
- **CS-D12, E2-D12** — Connects up to 12 ESI digital phones (only). This card uses 12 station ports and no CO ports.
- **CS-DLC12, E2-DLC12 (Digital Line Card)** — Provides **either** a T1 interface supporting 24 DS0 channels and 12 digital stations **or** an ISDN PRI interface supporting 23 B (bearer) channels, one D (datalink) channel, and 12 digital stations.

A jumper on this card must be plugged onto pins 7 and 8 of J3 to enable ISDN PRI functions. Any (or all) of the available channels of the T1/PRI span (24 on T1, 23 on PRI) can be assigned, and the card supports loop-start, ground-start, E&M and DNIS/DID trunk types with immediate, wink-start or dial-tone-start signaling. This card is equipped with a built-in CSU that can be connected directly to a network interface unit, SmartJack, or ISDN PRI. Up to 12 ESI digital phones can be connected to the card. All 24 CO ports are allocated (regardless of whether they are assigned or used).

- **CS-DLC, ESI-DLC** — Similar to the CS-DLC12 and E2-DLC12, but supports only a T1 or PRI circuit (and no phones).
- **CS-IVC, IVC (Intelligent VoIP Card)** — Supports standards-compliant IP telephony service and features, including VoIP to the desktop and Esi-Link. It features highly configurable DSP technology that manages the flow of traffic among the port cards and converts IP packets into PCM (pulse-code modulation) traffic for transmission over the PSTN. The physical connection is a 10/100Base-T, RJ-45 Ethernet<sup>®</sup> interface that allows the system to connect to an IP-based local area network (LAN).

The IVC is offered in three versions:

- **IVC 24R** — Provides 24 IP stations (local or remote).<sup>2</sup>
- **IVC 24EL** — Provides 24 channels for Esi-Link.
- **IVC 12R12EL** — Provides 12 IP stations (local or remote) and 12 Esi-Link channels; does **not** support SIP phones.

Each ESI Communications Server model has a specific maximum of each type of IVC (see the table on page A.4). The system automatically designates the first IVC station card (lowest-numbered slot) as the **primary** IVC — which acts as the “master” that, when an IP Phone first comes on line, identifies the IVC station card to which the ESI IP phone connects (IVC Esi-Link cards are excluded from this operation). Licensing is required to support each ESI IP phone or SIP phone. The following table shows the maximum number of ESI IP phones and Esi-Link channels for each system.

Maximums	ESI-1000	ESI-600	ESI-200	ESI-100
IP stations	816	408	192	72
Esi-Link channels	96	48	24	24 <sup>3</sup>

(Continued)

<sup>1</sup> Not supported on the ESI-50 (or ESI-50L).  
<sup>2</sup> SIP phones are supported on only the IVC 24R.  
<sup>3</sup> With (E2) IVC 24EL.

- **SL-DLC82** — (ESI-50 only.) Provides an ISDN PRI interface supporting 23 B (bearer) channels, one D (datalink) channel, eight digital stations, and two analog devices.  
 A jumper on this card must be plugged onto pins 7 and 8 of J3 to enable ISDN PRI functions. Any (or all) of the 23 available channels of the PRI span can be assigned, and the card supports loop-start, ground-start, E&M and DNIS/DID trunk types with immediate, wink-start or dial-tone-start signaling. This card is equipped with a built-in CSU that can be connected directly to a network interface unit, SmartJack, or ISDN PRI. Up to eight ESI digital phones and up to two analog phones can be connected to the card. All 24 CO ports are allocated (regardless of whether they are assigned or used).
- **482** — (ESI-50 [and ESI-50L] only.<sup>1</sup>) Provides circuits to connect up to four loop-start CO lines, eight ESI digital phones, and two analog station ports. The CO line ports support standard CO and Centrex loop-start lines; ground-start CO lines are not supported. Only one analog device can be connected to each analog station port. This card uses 10 station ports and four CO ports when installed.

**Notes:** The main board comes in a four-line, eight-digital station, two-analog port configuration. You can add three 482 port cards on an ESI-50. Therefore, the system can have the following configurations.

- **4 × 8 × 2:** Base Cabinet (main board only)
- **8 × 16 × 4:** Base Cabinet with one additional 482 port card.
- **12 × 24 × 6:** Base Cabinet with one additional 482 port card and an Expansion Cabinet with one 482 port card.
- **16 × 32 × 8:** Base Cabinet with one additional 482 port card and an Expansion Cabinet with two 482 port cards.

The maximum ESI-50 configuration — if an SL-DLC82 is used in slot 2 and the built-in IVC (see next item) uses all 12 local IP channels — is 35 x 44 x 8.

- **SL-IVC 12** — (ESI-50 only.) The ESI-50's **built-in** SL-IVC 12 can support up to 12 IP channels, which support up to 12 local IP stations, or up to eight remote IP channels. Local IP, remote IP, and Esi-Link channels can be used in various combinations, which are activated in blocks of four for local IP, singles for remote IP, and blocks of four for Esi-Link. Here is an example of some possible IVC 12 channel combinations:
  - Eight all Esi-Link.
  - 12 all local IP.
  - Eight Esi-Link, four local IP.
  - Four Esi-Link, four local IP, four remote IP.

**Important:** The SL-IVC 12 is part of the ESI-50 main board; it is **not** available as an add-on port card.

- **CS-SIP24** — Provides 24 SIP trunk ports and supports ESI Mobile Messaging delivery of .WAV files to e-mail addresses.
- **CS-SIP8** — Provides eight SIP trunk ports and supports ESI Mobile Messaging delivery of .WAV files to e-mail addresses.
- **CS-ASC** (*Application Services Card*) — Supports ESI Mobile Messaging delivery of .WAV files to e-mail addresses. Also supports the storage of video recordings, audio recordings, SMDR records, and fob events.

<sup>1</sup> The 482 card also is used by ESI's C-Plus and IVX S-Class (Generations I–II) systems.



## Hot-swap operations

“CS” port cards — full-sized cards for use on only the ESI-1000, ESI-600, and ESI-200 — have built-in **hot-swap** capability, allowing you to replace them while the system is powered-up.

For hot-swap capability, an “E2” port card must be mounted onto a “**Hot Swap**” **Port Card Adapter** (ESI part #5000-0462) prior to being installed on the ESI-1000, ESI-600, or ESI-200. **However**, installing a **new** port card requires power-cycling the system to allow it to recognize the new card.

**The following rules apply to hot-swap operations on ESI Communications Servers:**

- The ESI-100 and ESI-50 **do not** support hot-swapping; this capability is available on only the ESI-1000, ESI-600, and ESI-200.
- When you replace a port card with a new one, the system will detect the port card type.
- If the new port card’s type is **different** than that of the original port card, the newly installed port card **won’t** come on-line.
- If the new port card’s type is the **same** as that of the original port card, the system will automatically upload software to the new port card. This upload process can take from four minutes to one hour, depending on the type of port card and how busy the system is at the time.

For details, refer to the procedure in “About replacing port cards,” page F.4.

## NSP

Built into the main board, the **NSP (Network Services Processor)** serves as a bridge between an Ethernet-based network and the ESI Communications Server. Using TCP/IP, the NSP communicates directly with specific PC applications for maintenance of, and integration with, the ESI system. The NSP manages optional features such as *VIP* and phone control via TAPI PC applications; it also provides access to not only maintenance and administration (through use of *ESI System Programmer* software) but also an Installer-selectable SMDR interface.

The NSP hardware interface consists of a dedicated Ethernet port. Its external RJ-45 jack provides a 10/100Base-T connection to the LAN. The NSP consumes no call-processing ports.

**Note:** The ESI-50 provides one Ethernet port for access to the NSP and built-in IVC12.

# Phones

## Digital phone models

An ESI Communications Server supports several different models of **ESI digital phones**, each of which connects to the cabinet via standard two-wire twisted pair.

### Current models

- **ESI 60** (digital version) — Three-line, 56-character display with adjustable backlighting; full-duplex, high-definition speakerphone; headset jack; 48 programmable feature keys; supports *VIP* and the 60-Key Expansion Consoles.
- **ESI 40** (digital version) — Three-line, 56-character display with adjustable backlighting; speakerphone; headset jack; 16 programmable feature keys; supports *VIP* and the 60-Key Expansion Consoles.
- **ESi 30D** (digital) — Two-line, 32-character backlit display; speakerphone; 12 programmable feature keys.
- **48-Key Digital Feature Phone** — Three-line, 56-character display; speakerphone; headset jack<sup>1</sup>; 30 programmable feature keys; supports *VIP* and the 60-Key Expansion Consoles.

**Note:** Not all modular headsets will work on the 48-Key Feature Phone's headset jack. ESI has tested and can recommend the following headset models:

**Manufacturer:** Plantronics

- P51-U10P sound tube microphone
- P51N-U10P noise-cancelling microphone
- P251-U10P sound tube microphone
- P251N-U10P noise-cancelling microphone

**Manufacturer:** GN Netcom

- GN2120 NCD 01 "over-the-head"
- GN2127 NCD 01 "on-the-ear"

Note that GN Netcom models also are available in a "-02" configuration, which wires differently and **won't** work with ESI phones. Therefore, when ordering GN Netcom headsets for use with ESI phones, **be sure to specify the "-01" configuration.**

- **Cordless Handset II** — DECT 6.0 technology (including use of optional Repeater to extend range); two-line, 32-character display; speakerphone; eight programmable feature keys.

### Legacy models

- **24-Key Digital Feature Phone** — Two-line, 32-character display; speakerphone; 12 programmable feature keys.
- **12-Key Digital Feature Phone** — One-line, 16-character display; nine programmable feature keys.
- [Original] **Cordless Handset** — Two sizes; two-line, 32-character display; four programmable feature keys.

**Note:** When a desktop phone is in the highest upright position, use the wall-mount hook located under the handset to secure the handset when you're not using the phone.

<sup>1</sup> Headset jack only on 48-Key Feature Phones (Digital, Digital TAPI, [local] IP, or Remote IP) manufactured after March, 2004.

## IP phone models

**Note:** For information concerning Cordless Handset models, see “ESI Cordless Handsets” (page B.3).

### Current models

- **ESI 60** (IP versions) — 10/100 or Gigabit Ethernet. Three-line, 56-character display (adjustable backlit display available); speakerphone; headset jack; 48 programmable feature keys; supports *VIP* and the 60-Key Expansion Consoles.
- **ESI 40** (IP version) — 10/100 Ethernet. Three-line, 56-character display (adjustable backlit display available); speakerphone; headset jack; 16 programmable feature keys; supports *VIP* and the 60-Key Expansion Consoles.
- **48-Key IP Feature Phone II** — Three-line, 56-character display; speakerphone; headset jack; 30 programmable feature keys; supports *VIP* and the 60-Key Expansion Consoles.
- **Remote IP Cordless Handset II** and **Local IP Cordless Handset II**.

### Legacy models

- **Remote IP** [original] **Cordless Handset** and **Local IP** [original] **Cordless Handset**.

### Features and support for standards

An ESI desktop IP phone looks and works like a regular digital phone as described on page B.1, but connects from within the local premises via an IP local area network (LAN) rather than twisted-pair cabling. If used on-premises, an ESI IP phone derives its operating power directly over the LAN from Power over Ethernet (PoE). If used remotely, an ESI desktop IP phone connects to the cabinet from a remote location via an IP network (either a WAN or the public Internet). Each ESI desktop IP phone derives its power from an individual Power over Ethernet (PoE) adapter. An ESI desktop IP phone supports the following features and standards:

- IEEE 802.3af Power over Ethernet (PoE).
- Power via PoE.
- Can be configured for either local or remote (off-site) operation.
- Uses a G.711 codec in its “local” mode of operation and a G.726 codec in its “remote” mode. In G.711 mode, the transfer rate is 206 Kbps; in G.726 mode, the transfer rate is 90 Kbps.
- Can use DHCP<sup>1</sup> to obtain an IP address:
  - In “local” operation, DHCP can be enabled or disabled<sup>2</sup> for the ESI desktop IP phones on each IVC. Alternatively, a “static” IP address may be assigned by the Installer (in Function 31; see the *ESI Communications Servers Programming Manual*, ESI document #0450-1050).
  - In “remote” operation, an ESI desktop IP phone automatically uses DHCP to obtain an IP address and default gateway.

(Continued)

<sup>1</sup> Dynamic Host Configuration Protocol, an IP standard described in RFC 2131 (<http://www.ietf.org/rfc/rfc2131.txt>).

<sup>2</sup> Default setting for DHCP is **disabled**.

- Complies with IEEE 802.1q and 802.1p (VLAN) Layer 2 switching and prioritization.
- Complies with differentiated services (DiffServ; RFC 2475) Layer 3 Quality of Service (QoS) implementations.

**Notes:** If connecting an ESI desktop IP phone to a Power over Ethernet source, the PoE cable **must** be connected to the jack labeled **NETWORK** on the base of the phone. The jack labeled **PC** **does NOT** support or provide Power over Ethernet.

ESI has tested each ESI desktop IP phone with several Power over Ethernet sources. For a current list of tested devices, consult the ESI Knowledge Base at <http://support.esiresellers.com>.

**Important:** None of the IP phones listed in this section will work with ESI's legacy IP E-Class or IVX<sup>®</sup> systems. Similarly, previous IP Feature Phone models (including the Remote IP Feature Phone) **don't** work with ESI Communications Servers but, instead, are intended for use with only IP E-Class and appropriate, IP-enabled IVX systems.

## ESI Cordless Handsets

ESI Communications Servers also support ESI's digital, Local IP, and Remote IP **Cordless Handsets** — both the **Cordless Handset II** and the **original ESI Cordless Handset** models.

### *Cordless Handset II*

The ESI Cordless Handset II includes seven familiar fixed feature keys, eight programmable feature keys, a speakerphone, and a headset jack. The Base Station for the ESI Digital Cordless Handset II uses a standard line cord and is line-powered; and the Base Station for each ESI IP Cordless Handset II (Local IP or Remote IP) uses Ethernet cabling, and receives (and requires) Power over Ethernet (PoE). The ESI Remote IP Cordless Handset II base station also includes a jack into which the user can plug an analog CO line. This gives the home-based teleworker the convenience of using both home and business lines with the ESI Remote IP Cordless Handset II. Each ESI Cordless Handset II model employs advanced DECT 6.0 technology which, as compared to the original ESI Cordless Handsets, allows more secure communications and — through the use of one or more optional ESI Cordless Handset II Repeaters — greater range.

### *Original Cordless Handsets*

The original ESI Cordless Handsets come in two sizes — small and large — and each includes four familiar fixed feature keys, four programmable feature keys, and a headset jack. The Base Station for each ESI digital Cordless Handset uses a standard line cord and is line-powered; and the Base Station for each ESI IP Cordless Handset uses Ethernet cabling and receives (and requires) Power over Ethernet (PoE). The ESI Remote IP Cordless Handset base station also includes a jack into which the user can plug an analog CO line. This gives the home-based teleworker the convenience of using both home and business lines with the ESI Remote IP Cordless Handset.

**Important:** Each ESI IP phone draws up to 7.25 watts<sup>1</sup> at 48 volts DC; therefore, each advertises itself to a Power over Ethernet switch as a Class 3 device per the 802.3af standard. Most PoE switches adhering to this standard will provide up to 12.5 watts for each Class 3 device.

<sup>1</sup> An ESI desktop IP phone's power consumption takes into account an optional 60-Key Expansion Console.

## Expansion Consoles

The **60-Key Expansion Console** gives a designated user 60 additional programmable feature keys. It is supported by the ESI 60 (digital or IP models), ESI 40 (digital or IP models), and 48-Key Feature Phone (digital or IP models). The Expansion Console is connected to its host ESI phone via a special cable (provided) and **doesn't** require a separate station port of its own. Additionally, it may be connected to a **60-Key Second Expansion Console** via a special cable (provided with the 60-Key Second Expansion Console) so that one phone can have a total of 120 programmable feature keys in addition to its own complement of such keys.

Each ESI Communications Server has a maximum number of stations that can have one or two Expansion Consoles (60-Key and 60-Key Second) installed in a **fully configured** system:

Maximum Expansion Consoles				
ESI-1000	ESI-600	ESI-200	ESI-100	ESI-50
128	80	32	8	8

**Note:** Regardless of ESI Communications Server model, a Base Cabinet can support a maximum of eight Expansion Consoles, and each Expansion **Cabinet** can support a maximum of 24 Expansion Consoles.

## Phone overlays

Each ESI phone comes with one overlay for the programmable feature keys. To order additional overlays, visit the DESI™ Web site, [www.desi.com](http://www.desi.com). While there, you may also want to download the free *Windows*-based software, *DESI Lite*, which allows you to print on the overlays. For assistance with DESI products, contact DESI (the DESI Web site contains contact information).

**Tip:** Remember that *ESI System Programmer* software, available from [www.esi-estech.com](http://www.esi-estech.com), also lets you print on the overlays as well as perform many other programming tasks.

## VIP Softphone

**VIP Softphone** integrates the features of *VIP Professional* and an ESI desktop IP phone into a PC-based, full-audio phone. With the appropriate license, *VIP Softphone* can be configured for use locally or remotely. This product requires a third-party USB headset.

**Note:** For details, see the *VIP Product Overview* (ESI document #0450-0608) and the *VIP Setup and User's Guide* (ESI document # 0450-0513).

# Licensing

There are various types of **licenses** needed to activate certain features and functionality. The following ESI Communications Server-supported features, products, and capabilities require license activation:

- Any of the following, the operation of each of which requires a **UIP** (*universal IP*) license:
  - An ESI local IP station.
  - An ESI remote IP station.
  - An ESI local IP Cordless Handset.
  - An ESI remote IP Cordless Handset.
  - An Esi-Link channel.
  - A SIP trunk.
  - *VIP Softphone* (requires purchase of the *VIP Softphone* application)
- *VIP*.
- *VIP Professional*.
- *VIP PC Attendant Console*.
- *VIP ACD Supervisor*.
- *VIP ACD Agent*.
- ESI Mobile Messaging.
- ESI Media Management — Two license types:
  - Audio recordings.
  - Video recordings.
- *ESI Video Viewer*.
- A third-party SIP station.

**Note:** Each reference to a *VIP* software application, *above*, applies to both the standalone (*SE*) and *Outlook*-integrated versions of the application.

## License activation

To have licenses activated by ESI Technical Support:

1. Licenses must already have been ordered from ESI.
2. The ESI Communications Server must have **either**:
  - A CO line connected to it (analog, PRI, or T1);  
**or**
  - The NSP, which is connected to a LAN with a public IP address, “port-forwarded”<sup>1</sup> to it.
3. You’ll need the following to provide to the ESI representative:
  - The ESI sales order number.
  - The customer (site) name.
  - The phone number of the CO line or the public IP address of the NSP.
  - The quantity of *VIP Professional* and *VIP ACD Agent* licenses.<sup>2</sup>

## IP Phone licenses

Before an IVC will connect to an IP phone<sup>3</sup>, the phone will require an available IVC port and the activation within the system of a UIP license. When an IP phone is programmed in the system (Function 31), this consumes a license.

A new compatible ESI IP Phone, when connected to a LAN with an ESI Communications Server connected to it, can be configured in setup mode. However, if a new extension number is assigned to the phone and there are no local IP Phone licenses available, the phone will display *LICENSE EXCEEDED* (but play no prompt).

**Important:** The ESI-50 also requires purchase of IP/Esi-Link feature activation. For more information about this fee, contact your ESI sales representative at **800 374-0422**.

<sup>1</sup> For more information about the NSP, refer to *NSP Installation Made Simple* (ESI #0450-0669).  
<sup>2</sup> *VIP ACD Agent* uses the same license part numbers as *VIP Professional*, allowing mixing and matching as the customer may require; e.g., 100 such licenses could be used for 60 *VIP Professional* installations and 40 *VIP ACD Agent* installations. For licensing information for *VIP PC Attendant Console* and *VIP ACD Supervisor*, refer to their respective *Product Overviews* (ESI document #0450-0914 for *VIP PC Attendant Console* and #0450-0988 for *VIP ACD*). *VIP Softphone* is sold as a single license (part #5000-0434), which provides one user with *VIP Professional* features and *Softphone*-specific capabilities. The *VIP Softphone* license is selected at the time of purchase for local or remote operation.  
<sup>3</sup> An ESI 60 (IP model), ESI 40 (IP model), 48-Key IP Feature Phone II, IP Cordless Handset (Local or Remote), *VIP Softphone*, or SIP phone.

# System capacities

**Important:** Each ESI Presence Management RFID Reader (digital model) uses one digital station. The same is true for each ESI Cellular Management Access Device.

## Stations and trunks

The specifications shown below reflect maximum capacities and configurations. **Not all of the station and trunk maximums can be reached simultaneously.**

**Example:** The ESI-100 can't achieve 72 IP stations **and** 48 digital stations **and** 28 analog stations **and** 42 trunks **and** 24 Esi-Link stations **at the same time**, because the system's four-port-card limit makes such a configuration impossible. The maximum configuration for this system is 108 ports, which could be achieved by one DLC12 card (24 T1 trunks, 12 digital stations), two IVC 24Rs (48 IP stations), and one IVC EL24 (24 Esi-Link channels).

Dialing plans (-digits) ▶	ESI-1000		ESI-600		ESI-200		ESI-100		ESI-50	
	Four	Three	Four	Three	Four	Three	Four	Three	Four	Three
Max. port cards	42	14	28	14	14	14	5	5	4 <sup>1</sup>	4 <sup>1</sup>
Max. port configuration <sup>2</sup>	1,128	276	624	276	300	276	108	108	87	87
– Max. stations	816	168	408	168	192	168	84	84	52	52
– Max. IP stations	816	168	408	168	192	168	72	72	12	12
– Max. digital stations	504	168	336	168	168	168	48	48	32	32
– Max. analog stations	384	56	188	56	56	56	28	28	8	8
Max. CO lines	240	84	168	84	84	84	42	42	35	35
Max. DLCs (T1/PRI)	10	3	6	3	3	3	1	1	1 <sup>3</sup>	1 <sup>3</sup>
Max. IVCs	34	7	17	7	8	7	3	3	1 <sup>4</sup>	1 <sup>4</sup>
Max. Esi-Link port cards (up to 24 Esi-Link channels <sup>5</sup> per card)	4	4	2	2	1	1	1	1	1	1
Max. SIP trunk cards	10	3	6	3	3	3	1	1	1	1
Max. SIP trunks	240	72	144	72	72	72	24	24	24	24

## Dedicated ports

Dialing plans (-digits) ▶	ESI-1000		ESI-600		ESI-200		ESI-100		ESI-50	
	Four	Three	Four	Three	Four	Three	Four	Three	Four	Three
Voice mail/auto attendant ports	128	128	32	32	8, 16, or 24	8, 16, or 24	4 or 8	4 or 8	2, 4, or 6	2, 4, or 6
Conference ports (max. of 16 members per conference)	64	64	64	64	24	24	16	16	16	16
NSP <sup>6</sup>	1	1	1	1	1	1	1	1	1	1
Overhead paging ports <sup>7</sup>	1	1	1	1	1	1	1	1	1	1
Serial/SMDR ports	1	1	1	1	1	1	1	1	1	1

## Voice mail capacities

Dialing plans (-digits) ▶	ESI-1000		ESI-600		ESI-200		ESI-100		ESI-50	
	Four	Three	Four	Three	Four	Three	Four	Three	Four	Three
Voice mail storage (hours)	1,200	1,200	1,200	1,200	70, 140, or 600	70, 140, or 600	70 or 140	70 or 140	15 or 30	15 or 30
Broadcast mailbox (one to all extensions)	Yes	Yes	Yes	Yes	Yes	Yes	Yes	Yes	Yes	Yes
Cascade notification mailboxes	40	10	20	10	10	10	10	10	10	10
Group mailboxes/max. members	64/200	32/200	32/64	32/64	16/64	16/64	16/32	16/32	16/32	16/32
Guest/info mailboxes	1,000	190	1,000	190	1,000	190	1,000	190	1,000	190
Maximum station mailboxes	816	168	408	168	192	168	84	84	52	52
Q & A mailboxes	20	10	20	10	10	10	10	10	10	10

<sup>1</sup> Includes built-in 482 port card.  
<sup>2</sup> Includes Esi-Link channels.  
<sup>3</sup> ESI-50 supports only PRI.  
<sup>4</sup> IVC 12 is built into the ESI-50 main board; supports up to 12 local IP or up to eight remote IP channels.  
<sup>5</sup> Esi-Link channels are allocated to "reserved" ports; i.e. Esi-Link channels do not reduce CO or station capacity.  
<sup>6</sup> Network Services Processor.  
<sup>7</sup> **On the ESI-200:** A non-IVC card must be installed in slot 1 or 2. **On the ESI-100:** An IVC can't be installed in slot 1.

## Departments

Dialing plans (-digits) ▶	ESI-1000		ESI-600		ESI-200		ESI-100		ESI-50	
	Four	Three	Four	Three	Four	Three	Four	Three	Four	Three
Max. departments	128	20	64	20	20	20	10	10	10	10
Department types: Ring-all, ACD, UCD, in-order, pick-up, attendant	Yes	Yes	Yes	Yes	Yes	Yes	Yes	Yes	Yes	Yes
Max. members, non-ring-all depts.	64	64	64	64	48	48	32	32	32	32
Max members, ring-all depts.	48	48	48	48	48	48	32	32	32	32

## Shared-office tenanting

Dialing plans (-digits) ▶	ESI-1000		ESI-600		ESI-200		ESI-100		ESI-50	
	Four	Three	Four	Three	Four	Three	Four	Three	Four	Three
Tenants	8	8	8	8	4	4	2	2	2	2

## CO line groups

Dialing plans (-digits) ▶	ESI-1000		ESI-600		ESI-200		ESI-100		ESI-50	
	Four	Three	Four	Three	Four	Three	Four	Three	Four	Three
Line groups 9, 8, 71–76	Yes	Yes	Yes	Yes	Yes	Yes	Yes	Yes	Yes	Yes
Max. members, CO ring assignment list	48	48	48	48	48	48	32	32	32	32

## Translation tables

Dialing plans (-digits) ▶	ESI-1000		ESI-600		ESI-200		ESI-100		ESI-50	
	Four	Three	Four	Three	Four	Three	Four	Three	Four	Three
Pilot numbers (non-SIP <sup>1</sup> )	80	80	40	40	20	20	10	10	10	10
Pilot numbers (using SIP <sup>2</sup> )	100	100	100	100	100	100	100	100	100	100
Max. DID entries	1,200	1,200	600	600	300	300	300	300	300	300

## System speed-dial numbers

Dialing plans (-digits) ▶	ESI-1000		ESI-600		ESI-200		ESI-100		ESI-50	
	Four	Three	Four	Three	Four	Three	Four	Three	Four	Three
System speed-dial numbers	1,000	100	1,000	100	1,000	100	1,000	100	100	100

## Maximum installations of VIP applications<sup>3</sup>

Dialing plans (-digits) ▶	ESI-1000		ESI-600		ESI-200		ESI-100		ESI-50	
	Four	Three	Four	Three	Four	Three	Four	Three	Four	Three
Installations, VIP PC Attendant Console	16	16	8	8	4	4	2	2	2	2
Installations, VIP auto-recording	32	32	16	16	8	8	4	4	4	4
Installations, VIP ACD Supervisor	16	16	8	8	4	4	2	2	2	2

<sup>1</sup> Prior to June 15, 2009.

<sup>2</sup> With release of system software on or after June 15, 2009.

<sup>3</sup> Standalone (SE) or Outlook-integrated versions.



## ESI Presence Management features

Dialing plans (-digits) ▶	ESI-1000		ESI-600		ESI-200		ESI-100		ESI-50	
	Four	Three	Four	Three	Four	Three	Four	Three	Four	Three
RFID Reader access door records	50,000	50,000	10,000	10,000	10,000	10,000	10,000	10,000	10,000	10,000
RFID Reader entries in Fn. 372 <sup>1</sup>	64	64	32	32	32	32	16	16	16	16
Max. RFID tags ("electronic keys")	2,000	2,000	500	500	500	500	500	500	500	500

## ESI Cellular Management features

Dialing plans (-digits) ▶	ESI-1000		ESI-600		ESI-200		ESI-100		ESI-50	
	Four	Three	Four	Three	Four	Three	Four	Three	Four	Three
Support for ESI Cellular Mgmt.	Yes	Yes	Yes	Yes	Yes	Yes	Yes	Yes	Yes	Yes

## ESI Mobile Messaging features

Dialing plans (-digits) ▶	ESI-1000		ESI-600		ESI-200		ESI-100		ESI-50	
	Four	Three	Four	Three	Four	Three	Four	Three	Four	Three
Maximum stations	816	816	408	408	168	168	84	84	52	52
Maximum guest mailboxes	250	250	250	250	100	100	50	50	50	50

## ESI Video Viewer and ESI Video Adapters

Dialing plans (-digits) ▶	ESI-1000		ESI-600		ESI-200		ESI-100		ESI-50	
	Four	Three	Four	Three	Four	Three	Four	Three	Four	Three
ESI Video Adapters	32	32	24	24	16	16	14	12	12	12
RFID Readers per ESI Video Adapter	1	1	1	1	1	1	1	1	1	1
User exts./depts. per ESI Video Adapter	64	64	64	64	48	48	32	32	32	32
ESI Video Viewer users, Advanced	30	30	20	20	15	15	10	10	5	5
ESI Video Viewer users, Basic	Unlimited									

## ESI Media Management features

Dialing plans (-digits) ▶	ESI-1000		ESI-600		ESI-200		ESI-100		ESI-50	
	Four	Three	Four	Three	Four	Three	Four	Three	Four	Three
Video recordings	48	48	36	36	24	24	12	12	12	12
Audio recordings	384	384	192	192	64	64	32	32	32	32
SMDR events	Yes	Yes	Yes	Yes	Yes	Yes	Yes	Yes	Yes	Yes
Fob activity	Yes	Yes	Yes	Yes	Yes	Yes	Yes	Yes	Yes	Yes
ESI Media Manager users	30	30	20	20	15	15	10	10	5	5
ASCs per system	20	20	14	14	7	7	1	1	1	1

**Note:** For SMDR events or fob activity, maximum stored events per each system is 20,000.

<sup>1</sup> See the *ESI Communications Servers Programming Manual* (ESI document #0450-1050) or the *ESI Presence Management Installation Manual* (ESI document #0450-0792).

# Cautions and regulatory information

## Cautions

**Important:** This information complies with the requirements of Underwriters' Laboratories (UL) and UL Standards 1950, 60950, and 60950-1, as applicable.

When using this telephone equipment, always exercise basic safety precautions in order to minimize the risk of fire, electric shock or injury to persons. **Before proceeding, please read the following:**

- **Do not** use liquids or aerosols to clean any system equipment; rather, use a cloth that is only **slightly** damp.
- An ESI Communications Server contains **no** components that are serviceable by either non-Resellers or non-manufacturer technicians. **All service must be referred to the Reseller for further handling.**
- **Do not** install the cabinet in areas with extreme heat or improper ventilation.
- Install the cabinet **only** in "low-traffic" or "non-public" areas.
- To reduce the risk of fire, use **only** 24 AWG or larger telecom wire.

### **Power supply**

Heed all warnings and instructions in documentation or marked on the cabinet or peripheral equipment.

### **Fuse**

Contact the factory **before** attempting to replace the fuse. The fuse is located on the main board in the Base Cabinet, and (for the ESI-1000, ESI-600, and ESI-200) on the backplane in the Expansion Cabinet.

### **Battery (located on the main board)**

**Caution:** There is a danger of explosion if the onboard lithium battery is incorrectly replaced. Replace only with Ray-O-Vac BR1225 (or equivalent). Dispose of used batteries according to the battery manufacturer's instructions."

**Notice:** This product is intended to be supplied by a Listed Direct Plug-In Power Unit marked 'Class 2' and provided with electrical ratings."

## Regulatory information

### *United States of America*

#### Registration

The CO line telephone numbers, FCC registration number, and ringer equivalence number (REN) of this equipment must be provided to the telephone company before installation. (See below for FCC registration number and ringer equivalence number.)

#### FCC Part 15

This equipment has been tested and found to comply with the limits for a Class A digital device, pursuant to Part 15 of the FCC Rules. These limits are designed to provide reasonable protection against harmful interference when the equipment is operated in a commercial environment. This equipment generates, uses and can radiate radio frequency energy and — if not installed and used in accordance with the instruction manual — may cause harmful interference to radio communications (in which case, the user will be required to correct the interference at his/her own expense).

#### FCC Part 68

This equipment complies with Part 68 of the FCC Rules. On the bottom of this equipment is a label that contains, among other information, the FCC Registration Number and Ringer Equivalence Number (REN) for this equipment. You must, upon request, provide this information to your telephone company.

The REN is helpful to determine the quantity of devices you may connect to your telephone line and still have all of those devices ring when your telephone number is called. In most, but not all, areas, the sum of the RENs of all devices connected to one line should not exceed five (5.0). To be certain of the number of devices you may connect to your line, as determined by the REN, you should contact your local telephone company to determine the maximum REN for your calling area.

If your telephone equipment causes harm to the telephone network, the telephone company may discontinue your service temporarily. If possible, the telephone company will notify you in advance but, if advance notice is not practical, you will be notified as soon as possible. You will be informed of your right to file a complaint with the FCC.

Your telephone company may make changes to its facilities, equipment, operations or procedures that could affect the proper functioning of your equipment. If so, you will be notified in advance, to give you an opportunity to maintain uninterrupted telephone service.

If you experience trouble with this telephone equipment, the telephone company may ask that you disconnect this equipment from the network until the problem has been corrected or until you are sure that the equipment is not malfunctioning.

This equipment may not be used on coin service provided by the telephone company. Connection to party lines is subject to state tariffs.

**Installation:** The device is equipped with a USOC connector.

**Registration Number:** 1T1MF08B33727.

**Ringer equivalence number (REN):** 0.8

#### Hearing-aid compatibility

This equipment, utilizing telephone station equipment manufactured by ESI, meets all FCC requirements for hearing-aid compatibility.

# Hardware installation: ESI-1000, ESI-600, ESI-200

## Site location

As with most electronic equipment, the environmental considerations for this site need to observe good common sense. Provide a dry, clean, and accessible area.

Locate space in the telephone equipment room, which will provide easy connection to the termination blocks and 110 VAC power. **The location should be no further than 1,000 feet from the farthest station.**

Ambient room temperature must be 40°–80° (F.), and relative humidity no higher than 90%.

**Notes:** Do not place the equipment or run station cabling near high voltage electrical equipment or electrical lines susceptible to high voltage surges from air conditioner compressors, etc.

Do not mount the equipment in a place that receives direct sunlight.

## Mounting the cabinet(s)

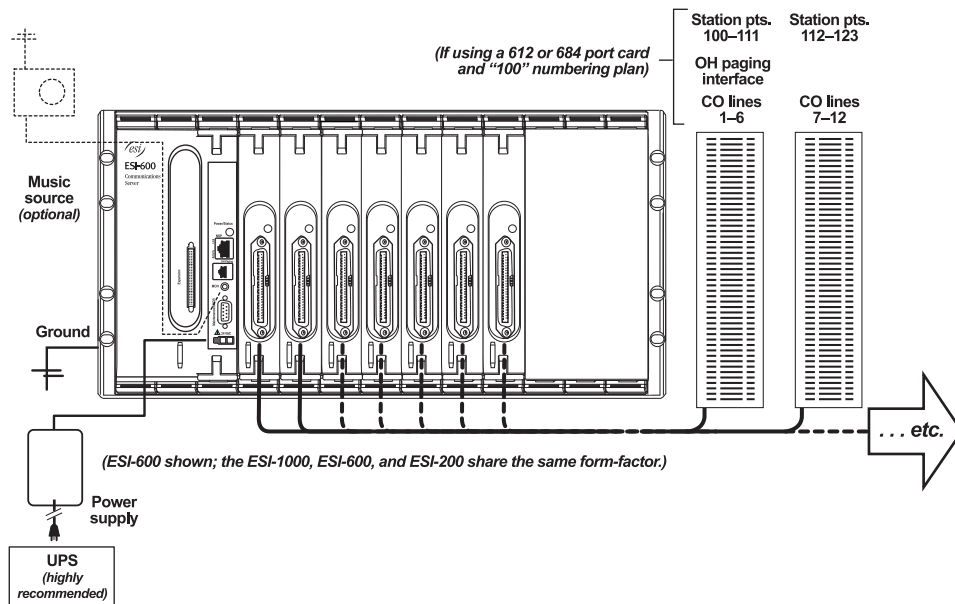
If **wall-mounted**, the system and supporting components should be mounted to a half-inch (or thicker) plywood backboard. To wall-mount a Base Cabinet or Expansion Cabinet, use the five tabs located at the rear of the cabinet. The center tab has an enlarged hole and slot, to allow you to fix the screw on the wall **before** hanging the cabinet onto the screw. Once you've done so, fasten the other screws into the four remaining holes to finish securing the cabinet onto the wall.

To **rack-mount** a Base Cabinet or Expansion Cabinet, use the forward-facing screw holes on the sides of the cabinet. Only two screws are needed per side (in fact, on most server racks, you can't use all four screws on each side).

Allow room for installation of the Expansion Cabinet either now or in the future; the Expansion Cabinet must be installed directly below the Base Cabinet. Allow about two inches of clearance between the units, for cabling.

Attach the power transformer to the wall or rack, allowing sufficient length in both cords to reach the power connector on the front side of the cabinet and to reach a UPS or a dedicated 110 VAC outlet.

### ESI-1000, ESI-600, or ESI-200 typical installation



## Expansion Cabinet installation

To expand the system, you must add the Expansion Cabinet.

1. Use the expansion cable (supplied with the Expansion Cabinet) to connect the **Input** jack of the Expansion Cabinet to the **Expansion** jack of the Base Cabinet.
2. **ESI-1000 and ESI-600 only:** Add additional Expansion Cabinets by using the expansion cable to connect the **Input** jack of the next Expansion Cabinet to the **Expansion** jack of the previous cabinet.
3. Connect the ground of all units to the system ground. (See also “Grounding instructions,” page I.1)
4. Connect both power supplies to the standard power strip and then connect to the UPS.

**Important:** Always apply power to **all cabinets simultaneously** by using the power strip’s switch.

**Do not** apply power until **all** hardware connections have been made.

## Port card installation

### “CS” port cards

“CS” port cards should be inserted from left to right, without skipping any slots. (If there are any empty slots between port cards, any cards to the right of the empty slot won’t be operational.)

**Important:** Although all “CS” cards are hot-swappable<sup>1</sup>, **ALWAYS power down the entire system (ALL cabinets) BEFORE adding a new port card or permanently removing an existing port card.** Also, be sure to observe all proper procedures regarding the prevention of electrostatic discharge (ESD) when performing the following procedures; otherwise, circuit boards may suffer damage.

1. On the desired slot in the cabinet, press the **release buttons** on the top and bottom to release the **blank faceplate** (**Fig. 1**).
2. Slide the port card into the card guides at the top and bottom of the cabinet. Then, **gently** push the port card into the cabinet (**Fig. 2**).
3. When you feel some resistance, apply a little more pressure until you feel the port card’s edge connectors “click” into the connector on the backplane. At this point, the port card’s faceplate should be in contact with the front of the cabinet.
4. Press the port card’s **ejector handles** into the locking position (**Fig. 2**), so that they click into place behind the release buttons.

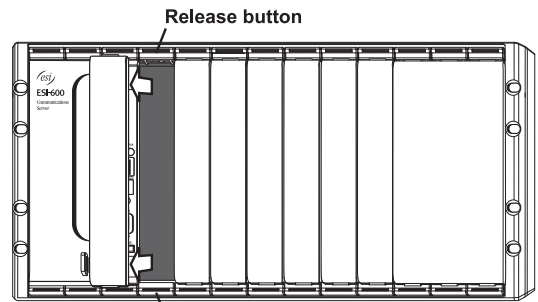


Fig. 1

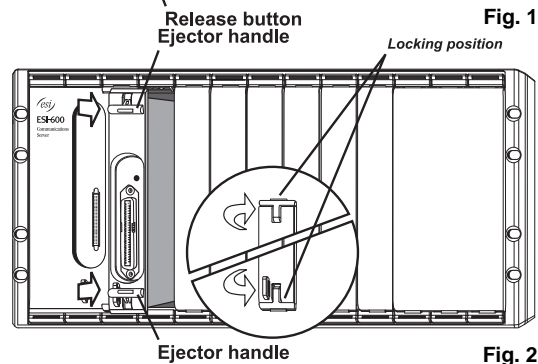


Fig. 2

5. If you have no more cards to install at this time, power-up and program the system.

<sup>1</sup> If using an “E2” port card in the ESI-200, ESI-600, or ESI-1000, you must also use a **Hot-Swap Adapter** (ESI part #5000-0462) for hot-swap operations.

## “E2” port cards

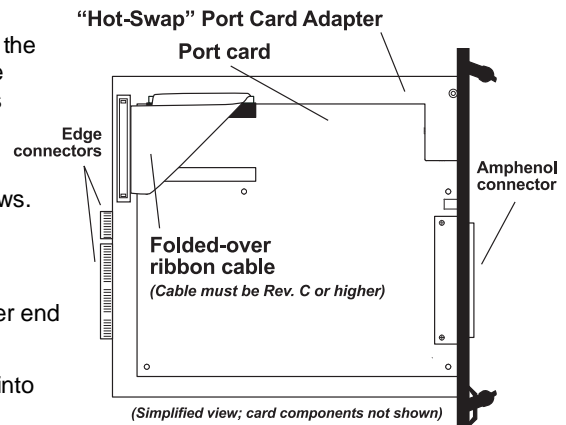
Each “E2” port card must be mounted onto a **“Hot Swap” Port Card Adapter** (ESI part # **5000-0462**)<sup>1</sup> prior to being installed on the ESI Communication Server. Using “Hot Swap” Port Card Adapters allows you to “hot-swap” port cards — *i.e.*, replace them while the system is powered-up. **However**, installing a **new** port card requires power-cycling the system to allow it to recognize the new card.

**Important:** While they are physically similar to the Port Card Adapters for the IVX X-Class system, “Hot-Swap” Port Card Adapters are for use with **only** ESI Communications Servers. Similarly, you should use **only** “Hot-Swap” Port Card Adapters on ESI Communications Servers.

Wear a grounding strap and avoid unnecessary movement while handling the circuit boards and Port Card Adapters.

To install the port card on the Port Card Adapter:

1. Place the port card’s Amphenol connector through the opening of the Port Card Adapter’s faceplate, while simultaneously aligning the port card’s screw holes with the Port Card Adapter’s standoffs.
2. Screw the port card to the Port Card Adapter, using the five provided Phillips-head machine screws.
3. Plug one end of the gray flat ribbon cable into the Port Card Adapter connector.
4. **Fold** the gray flat cable as shown, and plug its other end into the port card connector.
5. Install the assembled port card/Port Card Adapter into the Base Cabinet, following the instructions under “CS port cards,” page F.2.



<sup>1</sup> If you’re installing an “E2” port card on an ESI-600 with a **metal** faceplate, you’ll need the “Hot Swap” Port Card Adapter with a **metal** faceplate (ESI part # **5000-0385**).

## About replacing port cards

**Important:** The main board, expansion board, and expansion cable **cannot** be removed or replaced under power. **The entire system must be powered-down** when you install, remove, or replace **any** of these components.

### Notes regarding hot-swapping:

When you replace a port card with a new one, the system will detect the port card type.

If the new port card's type is **different** than that of the original port card, the newly installed port card **won't** come on-line.

If the new port card's type is the **same** as that of the original port card, the system will automatically upload software to the new port card. This upload process can take from four minutes to one hour, depending on the type of port card and how busy the system is at the time.

Hot-swap is **not** supported during system boot.

If you're hot-swapping identical cards between two slots, the upload process can take more than twice as long as when you hot-swap one card at a time.

A port card that's removed and inserted can't be removed and inserted again within five minutes.

When replacing port cards, you **must** observe the following rules and limitations:

1. The replacement port card **must** be **identical** to the port card being removed (*i.e.*: an E2-612 must be replaced with an E2-612; an ESI-DLC must be replaced with an ESI-DLC; *etc.*) — with the following exception: because each "E2" card is **functionally** identical to its corresponding "CS" version, you could (for example) remove an E2-684 and replace with a CS-684.
2. **BEFORE** you remove the port card:
  - The port card must be completely **idle**.
  - You **must remove** the cable from the front of the card (25-pair amphenol or Ethernet cable).
3. When removing the port card, follow the instructions under "Port card installation," beginning on page F.2.
4. Before inserting a replacement port card into a slot, **wait** at least 15 seconds after removing the previous port card.
5. When inserting a port card, don't re-connect the cable to the front connector until the inserted card is on-line.

## Memory Module installation or replacement

**Important:** Always **power-down** the system (**all cabinets**) **before** adding or replacing the Memory Module. Also, be sure to observe all proper procedures regarding the prevention of electrostatic discharge (ESD) when performing the following procedures; otherwise, circuit boards may suffer damage.

### *First, remove the main board from the system . . .*

1. In the Base Cabinet, disconnect all cables (such as power, MOH, and LAN cables) from the front panel of the main board faceplate.
2. Press the **release buttons** (Fig. MM-1) on the top and bottom of the faceplate to release the **ejector handles**.
3. Pull on the **ejector handles** (Fig. MM-1) to pull the main board from the cabinet.

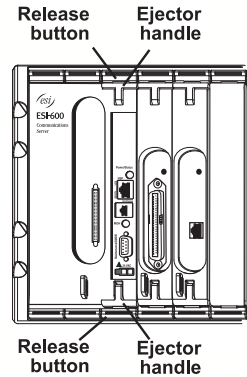


Fig. MM-1

### *Next, install the Memory Module . . .*

**Note:** The Memory Module installation procedure varies, depending on whether the Memory Module is a hard drive or a CompactFlash®. (An ESI-1000 or ESI-600 Memory Module is always a hard drive.)

### Procedure for two hard-drive Memory Modules (ESI-1000)

**Note:** The installation of these drives enables M3 operation on the ESI-1000; **no other** hardware is required, due to the ESI-1000's built-in M3 interface. (See "Mirrored Memory Module (M3)," page F.9.)

1. Place the mirrored (**secondary**) hard drive on the work surface with the printed circuit board up and the connector facing you (Fig. MM-2). Place a nylon spacer (washer) over each of the threaded mounting holes.
2. Place the right side of the drive mounting plate over the hard drive, aligning the holes in the plate with the threaded holes on the hard drive.

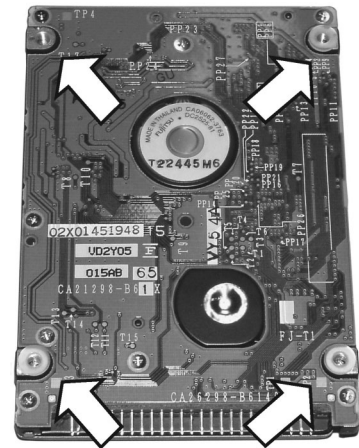


Fig. MM-2

(Continued)



3. Screw two of the standoffs through the drive mounting plate into the top-right and bottom-right threaded holes with the spacers. Screw two of the screws that came with the hard drive into the remaining holes (**Fig. MM-3**).

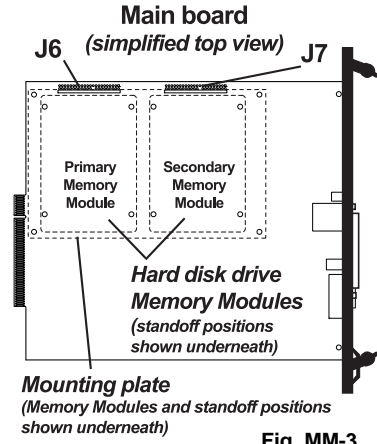


Fig. MM-3

4. Using the **primary** hard drive, repeat steps 1–2.

5. Screw the remaining standoffs through the drive mounting plate into the top-left and bottom-left threaded holes with the spacers. When you're done, the hard drive subassembly should look like **Fig. MM-4**.

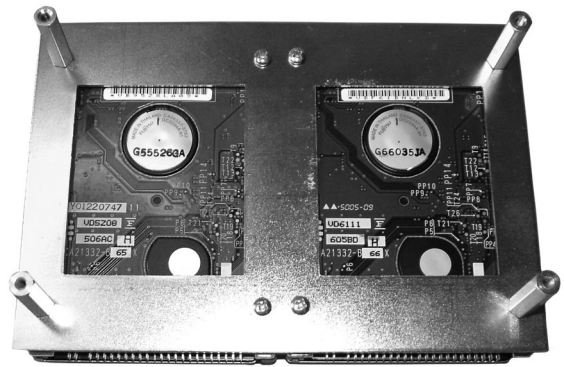


Fig. MM-4

6. Use the remaining screws to attach the assembly to the main board through the main board's four holes to the standoffs. Be sure to align the hard drive pins so that they're next to the hard drive connectors on the main board.

7. Connect the two hard drive cables — the primary drive should be connected to **J6** and the secondary drive should be connected to **J7**. Be sure to tuck the excess ribbon cable between the main board and hard drives. The full assembly should look like **Fig. MM-5**.



Fig. MM-5

**Procedure for a hard-drive Memory Module (ESI-600 • ESI-200)**

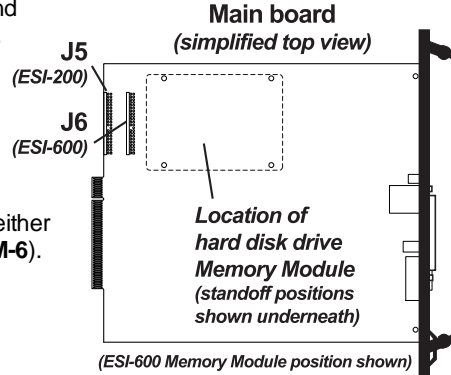
1. Install onto the new Memory Module the standoffs provided with it.

**Important:** Be careful **not** to **over-tighten** the standoffs.

2. Position the Memory Module over the four screwholes and install the four screws provided with the Memory Module.

**Important:** Be careful **not** to **over-tighten** the screws into the Memory Module standoffs.

3. Connect the cable provided with the Memory Module to either **J5** (ESI-200) or **J6** (ESI-600) on the main board (**Fig. MM-6**). Verify that the cable is fully seated at both ends. **Fold excess cable back over the top of the Memory Module.**



**Fig. MM-6**

**Procedure for a CompactFlash Memory Module (ESI-200 only)**

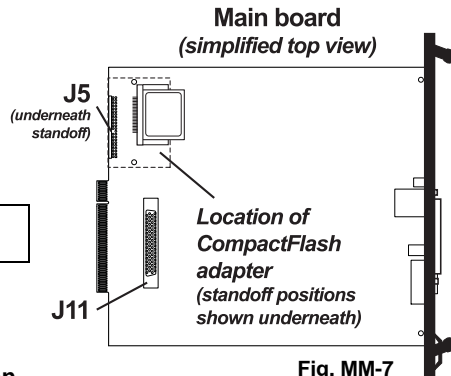
1. Attach the two standoffs to the main board by using two of the four provided screws. Locate the two holes closest to **J5** on the main board (**Fig. MM-7**); then, place the two screws through the holes from the bottom and loosely attach the standoffs to the screws.

2. Use the two remaining screws to install the **CompactFlash adapter** onto the two standoffs.

**Important:** Be careful **not** to **over-tighten** the standoffs.

3. Connect the cable provided with the CompactFlash Memory Module to **J5** on the main board (**Fig. MM-7**). Verify that the cable is fully seated at both ends. **Fold excess cable back into the open space between the main board and the CompactFlash adapter.**

4. Slide the CompactFlash Memory Module into the adapter.



**Fig. MM-7**

**Finally, reinstall the main board in the system . . .**

1. Slide the main board into the **card guides** at the top and bottom of the cabinet, and push the main board gently into the cabinet.
2. When you feel some resistance, apply a little more pressure until you feel the main board “click” into the connector on the backplane. At this point, the faceplate should be in contact with the front of the cabinet.
3. Push the ejector handles into their locking position, so that they click into place behind the release buttons.
4. Reconnect to the faceplate’s front panel the cables you removed in step 1 under “First, remove the main board from the system . . .” (page F.5).
5. Power-up the system.

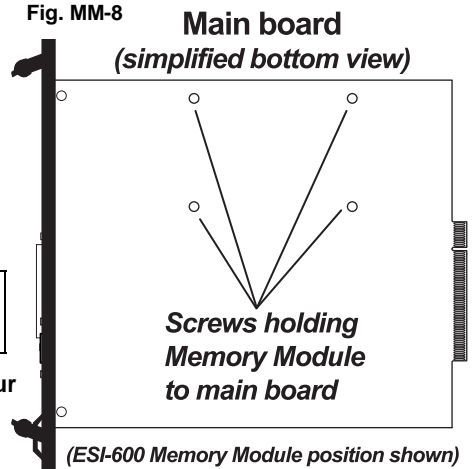
**Important:** Remember that, if you have **multiple** cabinets in the system, you **must** power-up **all** of them at the **same time**.

## Removing the Memory Module from the main board

1. Follow steps 1–3 under “First, remove the main board from the system . . .” (page F.5).
2. Remove the Memory Module cable connected to either **J5** (ESI-200) or **J6** (ESI-1000/ESI-600) at the **rear** of the main board (**Figs. MM-6** and **MM-7**, page F.7).

**Note:** On the ESI-1000, be sure also to remove the cable for the **secondary** Memory Module from **J7**.

3. From the **back** of the main board (**Fig. MM-8**), remove the **four** Philips screws securing the Memory Module standoffs. Remove the Memory Module **with the standoffs attached**.
4. Remove the four standoffs from the Memory Module.
5. Follow the steps under “Next, install the Memory Module . . .” (page F.5) and “Finally, reinstall the main board in the system . . .” (this page) to (a.) install a replacement Memory Module onto the main board and then (b.) reinstall the main board in (and power-up) the system.



## Mirrored Memory Module

**Note:** For full instructions on installing the M3, see its *Installation Guide* (ESI #0450-0912).

The **Mirrored Memory Module (M3)** ensures reliability and survivability of compatible ESI Communications Servers. Using RAID<sup>1</sup>-1 hard-disk drive technology, mirrored hard drives are intended to maintain system operation on one disk drive in the event a hard drive fails. No system programming is required for the M3 to function.

**Note:** The ESI-1000 has all M3 components built-in, so the installation on the ESI-1000 of the hard-drive Memory Modules (see "Procedure for two hard-drive Memory Modules (ESI-1000)," page F.5) enables M3 operation on that system. M3 components are optional for the ESI-600 and ESI-200, and must be installed onto the ESI Communications Server main board.

The M3 is a printed circuit assembly that supports two identically configured hard drives, mounted on standoffs. It also has LED indicators, an audible alarm, alarm reset button, and an IDE cable connector for connection to the main board.

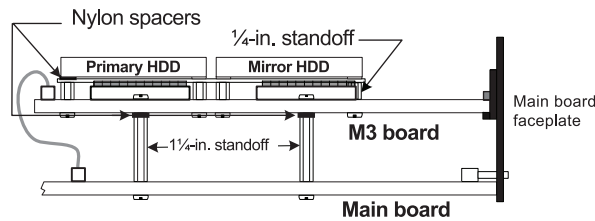
For the mirroring operation to function properly on the ESI Communications Server, each hard drive must be formatted and prepared by ESI.

### Installing the M3 (ESI-600 • ESI-200)

The M3 kit consists of an M3 printed circuit board, hard drive mounting plate, faceplate, four (4) 1/4-inch standoffs, 12 nylon spacers (washers), eight (8) screws, and an IDE cable for connection to the main board. Refer to **Fig. M3-1**, below, to identify and locate where these components will be installed.

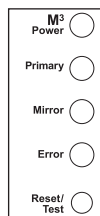
**Memory Modules (hard drives, or HDDs) are obtained separately.** Note that each hard drive must be an ESI-formatted drive for the mirroring operation to function properly.

The M3 board itself includes LED indicators, cable connectors, an audible alarm, and alarm reset button.

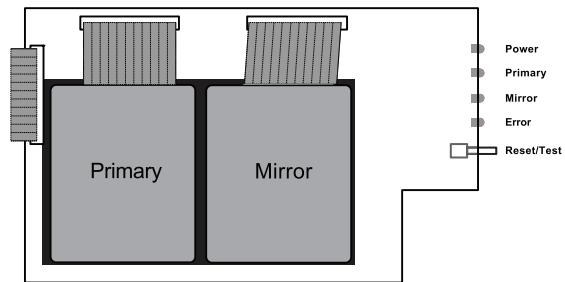


**Fig. M3-1:** Mounting locations of M3 hardware

**Important:** If the M3 is being installed on a system that already has an existing Memory Module (hard disk drive), the existing Memory Module **must be installed** in the M3 as the **primary HDD** (see **Fig. M3-3**). If it is not, then the drive synchronization will not operate correctly, and the system will have to be initialized and reprogrammed.



**Fig. M3-2:** M3 faceplate



**Fig. M3-3:** Hard-disk drive positions on M3

<sup>1</sup> Stands for *redundant array of independent drives*.

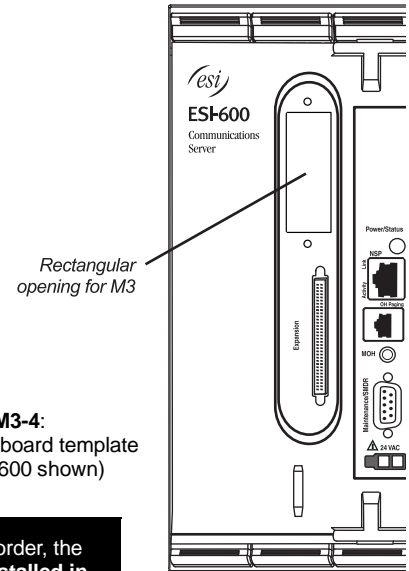
### What you'll need

Here's what you'll need to install the M3:

- ¼-inch nut driver.
- #1 Phillips screwdriver.
- A well-lit, clean and static-free<sup>1</sup> work area.

... along with these specific additional items:

ESI Communications Server	Additional items required for installing the M3
ESI-600	<ul style="list-style-type: none"> <li>• ESI-600 main board</li> <li>• A second ESI-600 Memory Module</li> </ul>
ESI-200	<ul style="list-style-type: none"> <li>• ESI-200 main board</li> <li>• A second ESI-200 Memory Module</li> </ul>



**Fig. M3-4:** Main board template (ESI-600 shown)

**Important:** To successfully install the M3, you must follow, in the correct order, the steps listed beginning below. **If the main board is already installed in the system, you'll need to power down the system and remove the main board** as explained in "Memory Module installation or replacement" (beginning on page F.5).

### M3 installation: Prepare the main board

1. If there is a hard drive already mounted on the main board, follow the instructions in the Memory Module installation instructions (beginning on page F.5). **Set aside the four screws and three of the ¼-inch standoffs**; you'll be using them later to secure the hard drive to the M3 mounting plate.
2. Unscrew the two screws holding the cover over the rectangular opening on the main board faceplate. **Set aside the two screws**; you'll be using them later to secure the M3 faceplate to the main board faceplate.
3. Unplug the expansion cable from the main board (there is no need to remove the expansion cable connector from the faceplate).
4. Set aside the main board.

(Continued)

<sup>1</sup> ESI strongly recommends that an approved ESD wrist strap be worn when working with electronic equipment.

### M3 installation: Prepare the M3 board

There are two sets of mounting holes on the M3 board. One set is for mounting the M3 on the ESI-200 main board (referenced by the **gray** arrows marked “X” in Fig. M3-5); and the other set aligns with the holes on the ESI-600 main board (the **white** arrows marked “ES” in Fig. M3-5).

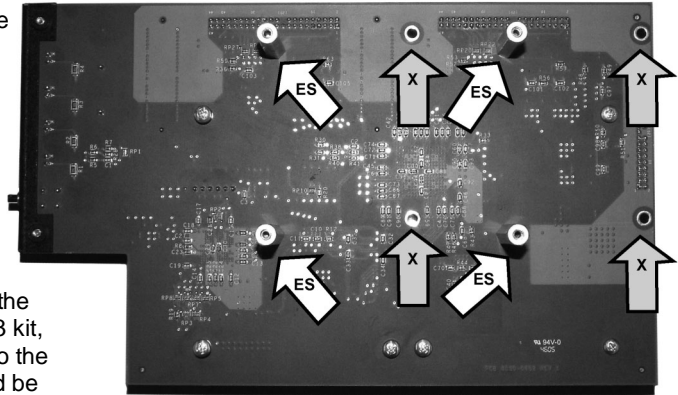


Fig. M3-5: Mount standoffs to M3 board

1. Locate the four mounting holes on the M3 board.
2. Using four of the screws and four of the nylon washers that came with the M3 kit, install the four 1¼-inch standoffs onto the M3 board. The nylon washers should be placed between the M3 board and the standoffs. The standoffs should be mounted on the side of the M3 board **without** the cable connectors. Refer to Fig. M3-5.
3. Set aside the M3 board.

### M3 installation: Assemble the hard drives to the mounting plate

For this assembly, you'll be using six of the ¼-inch standoffs, and one of the screws, included with the hard drives.

1. Place the mirrored (secondary) hard drive on the work surface with the printed circuit board up and the connector facing you (as shown in Fig. M3-6, right). Place a nylon spacer (washer) over each of the threaded mounting holes.
2. Place the right side of drive mounting plate over the hard drive, aligning the holes in the plate with the threaded holes on the hard drive (see Fig. M3-7, below).
3. Screw three of the ¼-inch standoffs through the drive mounting plate into the top-left, top-right, and bottom-right threaded holes with the spacers. Screw one of the screws that came with the hard drive into the remaining hole (see Fig. M3-7, below).

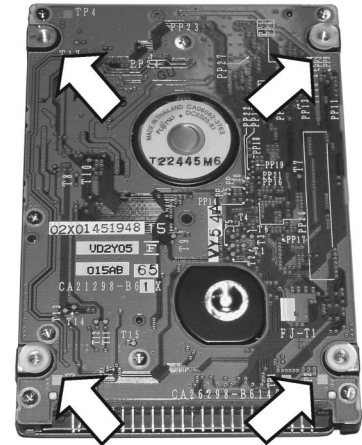


Fig. M3-6: Place nylon spacers on HDD screw-holes

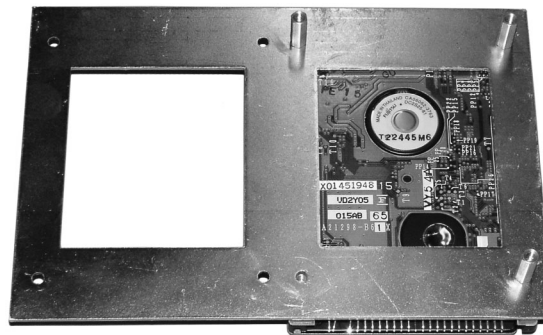
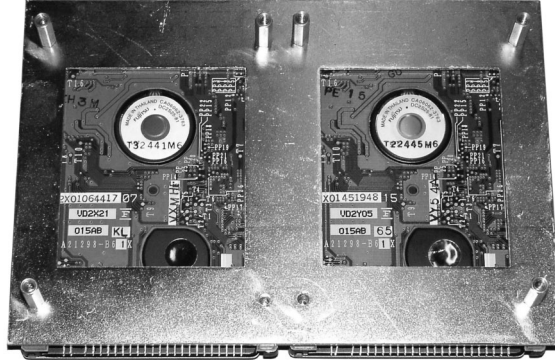


Fig. M3-7: Attach the hard drive mounting plate

(Continued)

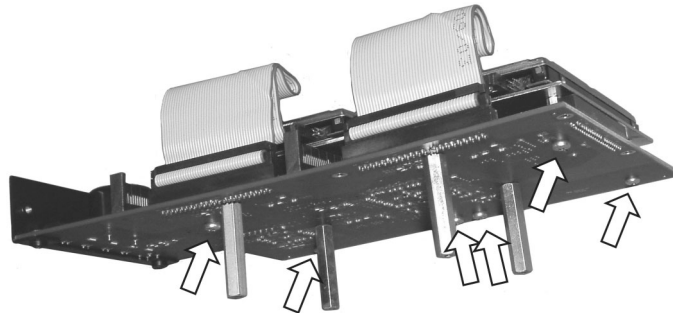
4. Using the primary hard drive, repeat steps 1 and 2 (under “Assemble the hard drives to the mounting plate,” page F.11).
5. Screw the remaining ¼-inch standoffs through the drive mounting plate into the top-left, top-right, and bottom-**left**-threaded holes with the spacers. When done, the hard drive subassembly should look like **Fig. M3-8**, below.



**Fig. M3-8:** Completed hard drive subassembly

**M3 assembly: Attach the hard drive subassembly to the M3 board**

1. Align the threaded holes at the end of the standoffs of the hard drive subassembly to the six holes on the M3 board. The connectors on the hard drives should be facing towards the connectors on the M3 board (see **Fig. M3-3**, page F.9).
2. Using the remaining screws<sup>1</sup> that came with the hard drives, attach the hard drive subassembly to the M3 board. See **Fig. M-9**, below, for the locations of the screws. Note that you’ll be using only six screws.



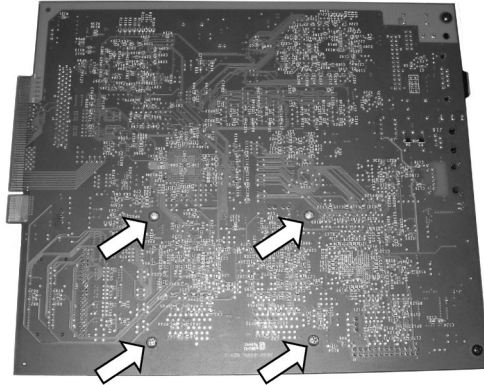
**Fig. M3-9:** Mount hard drive subassembly on M3

(Continued)

<sup>1</sup> If you’re using a drive that was already installed, use the screws you removed in step 1 of “M3 installation: Prepare the main board” (page F.10).

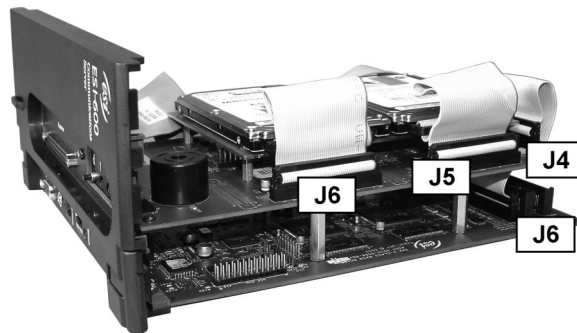
**M3 assembly: Attach the M3 assembly to the main board**

1. Align the threaded holes at the end of the four standoffs of the M3 subassembly to the four hard drive mounting holes on the main board.
2. Using the remaining four screws from the M3 kit, attach the M3 assembly to the main board. Make sure that the M3 faceplate is aligned with the opening on the main board faceplate. See **Fig. M3-10**, below, for the mounting screw locations.



**Fig. M3-10:** Location of M3 mounting screws (ESI-600 main board shown, without faceplate)

3. Screw the M3 faceplate to the main board faceplate, using the screws you removed in step 2 of “M3 assembly: Prepare the main board” (page F.10).
4. Connect the hard drive cables from each drive to the respective connectors on the M3 board (J5 and J6). To prevent the hard drive cables from interfering with inserting the main board, fold the cables in toward the hard drives (see **Fig. M3-11**, below).
5. Connect the M3 (connector J4) to the main board hard drive connector (J6) by using the IDE cable that came with the M3 kit.
6. Plug back in the expansion cable you removed in step 2 of “M3 assembly: Prepare the main board” (page F.10).
7. Confirm that the installation matches the picture in **Fig. M3-11**, below. If it does, you’re done, and you can install the main board back into the system.



**Fig. M3-11:** Completed M3 installation (ESI-600 main board and faceplate shown)

**Note:** The photo in **Fig. M3-11** is intended only as a representation. Your M3 installation will look somewhat different, depending on the ESI Communications Server.



### Mirroring operation

On system power-up — e.g., at initial installation or whenever a drive is replaced — the M3 will first verify that each drive is an ESI-formatted drive. If so, it then will transfer all data from the primary drive to the mirroring drive. This process can take anywhere from a few minutes to one hour, depending on system activity, amount of voice message storage, and configuration. System operation **won't** be affected during the data transfer, because this transfer will occur only when call-processing is making no disk drive access requests.

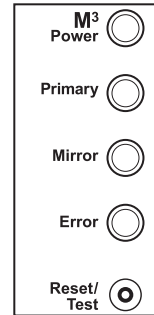
If a primary drive is replaced, data will be copied in the same fashion from the mirror drive to the new primary drive. Again, **the replacement drive must be a new, unprogrammed ESI drive**. If it's not, the system may copy all data in the wrong direction — i.e., from the new (mostly empty) primary drive to the mirror drive! Therefore, ESI recommends that the **mirror** drive be **moved** to the **primary** drive mounting position and the **new** drive be mounted on the **mirror** drive mounting position.

**Note:** Once a hard drive has been copied, if it is removed and installed on a different system, the system will automatically **initialize** the drive, erasing all data and voice messages.

### Panel indicators and controls

The M3 panel indicators and **Reset/Test** button are used primarily for alarm and error indication and troubleshooting. If the M3 is installed properly and the ESI Communications Server is powered-on, the M3's **Power** LED will always be lit. The following table describes other M3 indications:

"Primary" LED	"Mirror" LED	"Error" LED	Alarm beep	What it means
Flicker, steady on, or off	Flicker or off	Off	Off	Normal operation
Fast blink or steady on	Flicker or steady on	On	Off	Restoring data to primary or mirror drive
Slow blink	Flicker or off	On	On	Primary drive failure or non-ESI drive installed
Flicker or off	Slow blink	On	On	Mirror drive failure or non-ESI drive installed



The **Reset/Test** button is used to mute the audible alarm if a failure or error occurs. Additionally, during normal operation, you may test the M3 panel indicators by pressing and holding **Reset/Test** for more than one second. This will turn on all of the M3's LEDs and sound the audible alarm until you release the **Reset/Test** button.

## LED functions

The unit's various LEDs are designed to provide visual feedback as follows:

### **Power LED**

The **Power LED** is located on the right side of the main board's faceplate, and is illuminated when power is being applied to the system. This LED blinks periodically to indicate that the main processor is operational.

### **Port LEDs**

The **Port LEDs** are located above their respective connectors on each installed port card. Each LED is illuminated when any port on its associated port card is in use.

**Note:** Disconnecting a connector when its respective LED is lit will disconnect any of its ports that are in use.

Upon power-up, approximately five minutes are required for the system to configure. The **Power** and **Port LEDs** will blink three times to indicate that the power-up sequence has been completed.

**Note:** When a DLC's LED is . . .

- . . . blinking, the T1/PRI circuit is out of service.
- . . . not lit at all, the T1/PRI circuit is in service but is idle.
- . . . lit solidly, the T1/PRI circuit and/or a station on the card are in use.

### **Memory Transfer LED**

This LED is located inside the cabinet under the Memory Module, at the back of the main board. It serves as a diagnostic aid by flashing as data is transferred to and from the Memory Module.

## ESI Presence Management installation

For information on installing ESI Presence Management, see its *Installation Manual* (ESI # 0450-0792).

## ESI Cellular Management installation

### Hardware

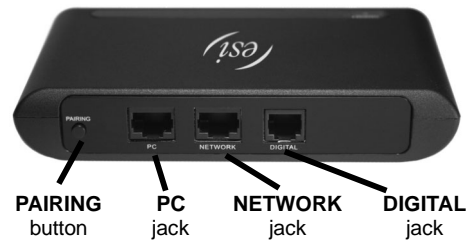
The ESI Cellular Management Access Device (see graphic, *below*) is housed in a small, ergonomic plastic case, which connects to a digital phone port. Although the Access Device is intended for desktop placement near the host ESI phone, it can be attached to any surface by using the included Velcro® strips.

The ESI Cellular Management Access Device is powered by the digital port. Each ESI Cellular Management Access Device requires a single digital port. Only the number of available station ports limits the number of ESI Cellular Management devices that can be connected to the system.



HANDSET LED

Front panel.



PAIRING button PC jack NETWORK jack DIGITAL jack

Back panel.

### HANDSET LED

A single blue **HANDSET** LED on the front panel of the ESI Cellular Management Access Device displays the status of a Bluetooth-enabled cell phone as related to the ESI phone:

- **Off** — Unpaired with a cellular phone.
- **Blinking slowly** — Not connected (Auto-Connect disabled).
- **Blinking moderately** — Searching for cell phone (not connected).
- **Blinking rapidly** — In pairing mode.
- **On** — Cell phone is paired and connected.

### PAIRING button

The **PAIRING** button, on the rear of the Access Device, is used to initiate the pairing of a Bluetooth-enabled handset and/or headset with ESI Cellular Management.

### Jacks

The Access Device's **DIGITAL** jack is an RJ-11 jack for connecting the Access Device to an ESI digital port. Power is provided via the included 12-ft. line cord connection to an ESI digital port card.

The **PC** and **NETWORK** jacks are reserved for possible future use.

For information on installing ESI Cellular Management, see its *Installation Guide* (ESI # 0450-1155).

## Installation of card(s) for ESI Mobile Messaging and SIP trunking

The following instructions cover installation of the **CS-SIP24**, **CS-SIP8**, and **CS-ASC**.

**Important:** Each card is for ESI Communications Servers **only** (except ESI-50L) and requires a Hot-Swap Port Card Adapter (five-pack, ESI # 5000-0462) if used on an ESI-1000, ESI-600, or ESI-200.

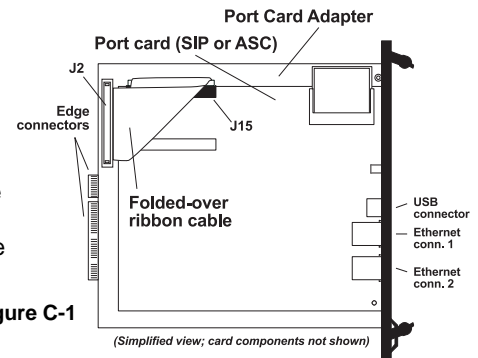
Before installing, verify that the system is running the appropriate system software. If it isn't, download the correct version from the ESI Resellers' Web site and install it on the system.

**ALWAYS power-down the entire system (all Cabinets) BEFORE adding or replacing any hardware.** Also, be sure to observe all proper procedures regarding the prevention of electrostatic discharge (ESD) when performing the following procedures; otherwise, circuit boards may suffer damage.

Whenever you change the port card configuration, you **must** create a **backup file** for the new configuration to be able to perform the Restore function later.

### Installing the card on the Port Card Adapter

1. Attach the new card to the assembled **Port Card Adapter**, using the five screws provided with the new card.
2. Install the port card cable (provided with the new card) into the **shrouded connector** on the new card. **Fold the cable** as shown (**Fig. C-1**), and install the other end of the cable into the shrouded connector on the top edge of the new card.

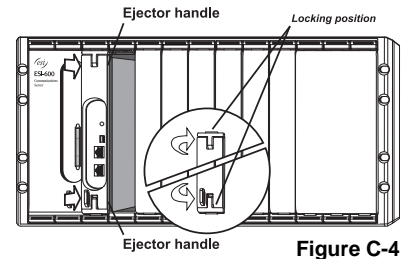
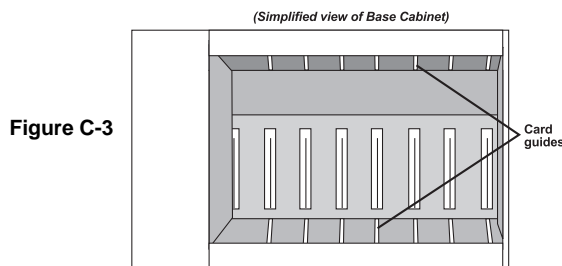
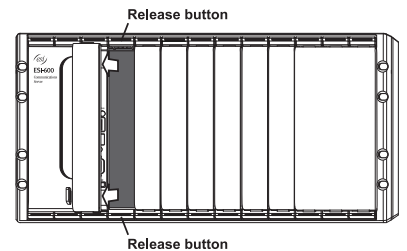


### Installing the card in the system

**Important:** Remember to power down the entire system (**all cabinets**) **before** either adding or removing port cards.

**Note:** Although **Figs. C-2** and **C-4** show only an ESI-600, the procedure is similar for other applicable ESI Communications Servers.

1. On the appropriate cabinet, remove the blank plate covering the slot in which you'll install the new card/Port Card Adapter, by using the **release buttons** at the top and bottom of the plate (**Fig. C-2**).
2. Slide the card/Port Card Adapter into the **card guides** (**Fig. C-3**) at the top and bottom of the cabinet. Then, **gently** push the card/Adapter into the cabinet.



3. When you feel some resistance, apply a little more pressure until you feel the Port Card Adapter's edge connectors "click" into the connector on the backplane. At this point, the card/Adapter's faceplate should be in contact with the front of the cabinet.
4. Secure the card/Adapter to the cabinet by pressing the Port Card Adapter's **ejector handles** into the locking position (**Fig. C-4**), so that they click into place behind the release buttons.
5. If you have no more cards to install at this time, power-up and program the system.

### Use of Ethernet connectors

- **CS-SIP24** or **CS-SIP8** — Both Ethernet® connectors must be connected to the private local area network (LAN).
- **ASC** — Only Ethernet Connector #1 must be connected to the private LAN.

For information on programming ESI Mobile Messaging, see its *Installation Guide* (ESI # 0450-1231).

For information on installing SIP trunking, see the *ESI SIP Trunking Installation Guide* (ESI # 0450-1227).

## Installation of Memory Module for CS-ASC

**Important:** The CS-ASC (Applications Services Card) is for ESI Communications Servers **only (except ESI-50L)** and requires a Hot-Swap Port Card Adapter (five-pack, ESI # 5000-0462) if used on an ESI-1000, ESI-600, or ESI-200.

Before installing, verify that the system is running the appropriate system software. If it isn't, download the correct version from the ESI Resellers' Web site and install it on the system.

**ALWAYS power-down the entire system (all Cabinets) BEFORE adding or replacing any hardware.** Also, be sure to observe all proper procedures regarding the prevention of electrostatic discharge (ESD) when performing the following procedures; otherwise, circuit boards may suffer damage.

Whenever you change the port card configuration, you **must** create a **backup file** for the new configuration to be able to perform the Restore function later.

Installing the ASC Memory Module (hard drive) does **not** replace the CompactFlash® (which is preinstalled).

### What you'll need

Here's what you'll need to install the ASC Memory Module (hard drive):

- ¼-inch nut driver
- #1 Phillips screwdriver
- A clean, well-lit, and static-free work area

### Procedure

After removing the new card from the box, install the Memory Module as follows:

1. Screw into the Memory Module the four ¼-inch standoffs that came with the ASC Memory Module kit.
2. Align:
  - a. the threaded holes at the end of the hard drive subassembly's standoffs
  - ... to ...
  - b. the four holes on the ASC (**Fig. H-1**).
3. Using the four remaining screws that came with the Memory Module, attach the Memory Module to the ASC.
4. Connect the Memory Module's hard drive cable (**Fig. H-2**) to the appropriate connector (**U12**) on the ASC.

**Note:** To prevent the cable from interfering with insertion of the main board, fold the cable in toward the Memory Module as shown in **Fig. H-2**.

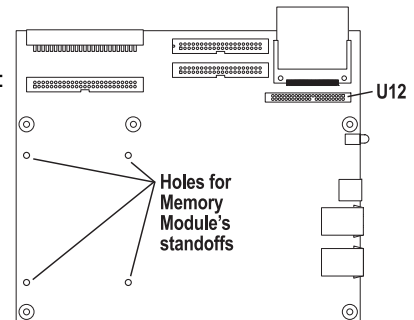


Figure H-1

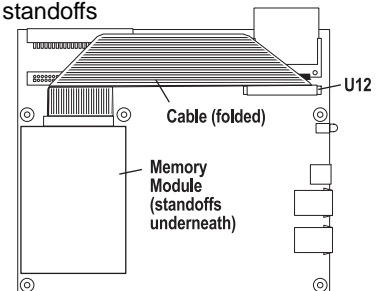


Figure H-2

# Hardware installation: ESI-100

## Site location

As with most electronic equipment, the environmental considerations for this site need to observe good common sense. Provide a dry, clean, and accessible area.

Locate space in the telephone equipment room, which will provide easy connection to the 66 blocks and 110 VAC power. **The location should be no further than 1,000 feet from the farthest station.**

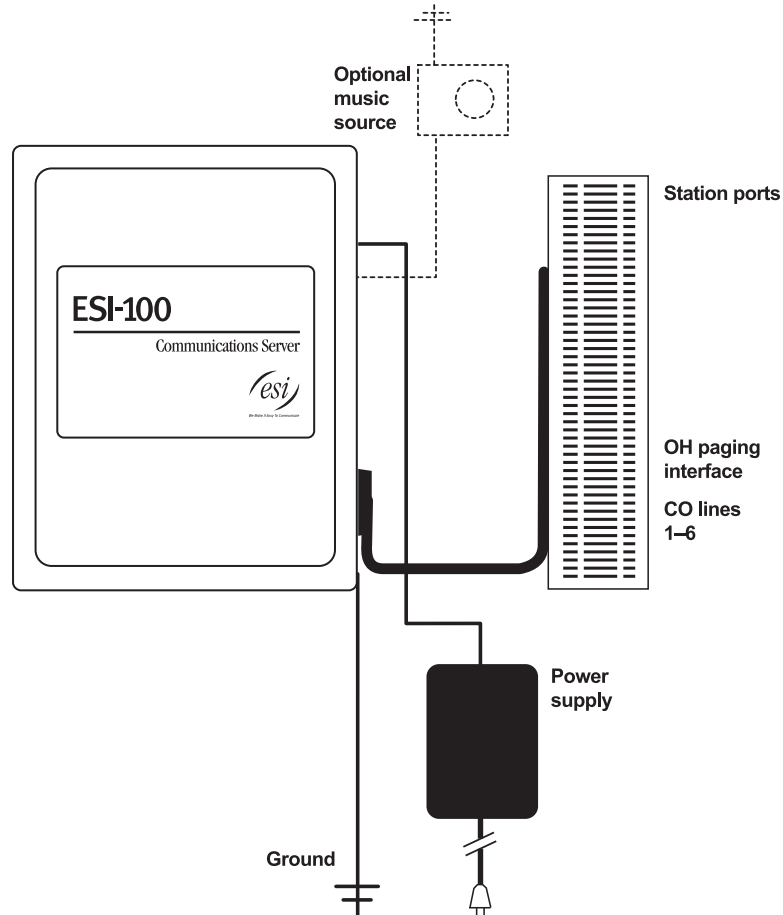
Ambient room temperature must be 40°–80° (F.), and relative humidity no higher than 90%.

**Notes:** Do not place the equipment or run station cabling near high voltage electrical equipment or electrical lines susceptible to high voltage surges from air conditioner compressors, etc.

Do not mount the equipment in a place that receives direct sunlight.

The system and supporting components should be mounted to a half-inch (or thicker) plywood backboard. Here is the layout of a typical Base Cabinet installation.

## ESI-100 Base Cabinet typical installation

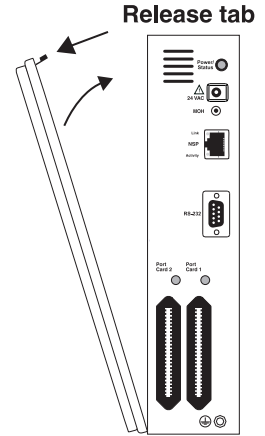


## Opening the Base Cabinet

The lid on the Base Cabinet is held in place by two tabs that rest in slots in the bottom of the case, and a release tab that snaps into an opening in the top-center of the cabinet and is secured by a retaining screw.

To remove the lid:

1. Remove the retaining screw and depress the release tab at the top of the cabinet.
2. Rock the lid back from the top.
3. Lift and pull the lid free from the slots in the bottom of the cabinet.

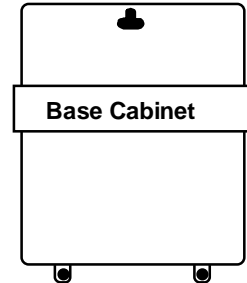


## Mounting the Base Cabinet

To mount the ESI-100 Base Cabinet, use the three provided #8 Phillips screws. Note the position of the three mounting holes in the cabinet. Allow room for installation of the Expansion Cabinet (see page G.3) either now or, if required, in the future.

1. Screw in the top screw to the backboard (at least half-inch thick plywood) leaving about one-eighth-inch clearance between the screw head and the plywood.
2. Hang the unit using the keyhole at the top of the case.
3. Level the unit and install the bottom two screws.

Attach the power transformer to the wall, allowing sufficient length in both cords to reach the power connector on the upper right side of the cabinet and to reach a UPS or a dedicated 110 VAC outlet.



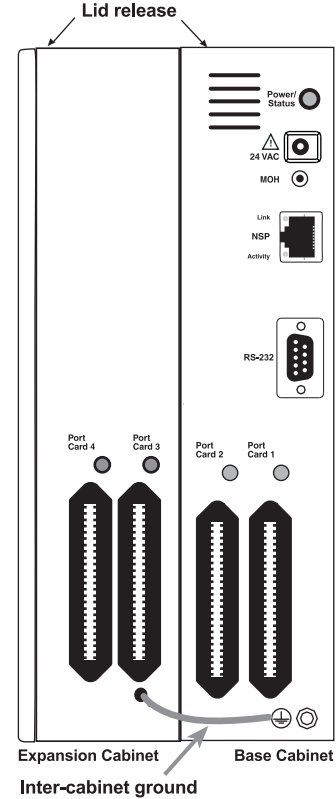
## Expansion Cabinet installation

The Expansion Cabinet allows the ESI-100's capacity to grow by up to two additional port cards. The cards are connected via ribbon cables, through the opening in the back of the Expansion Cabinet, to the Base Cabinet.

**Note:** You can add only one Expansion Cabinet to an ESI-100.

To install an Expansion Cabinet:

1. Wear a grounding strap and avoid unnecessary movement while handling the circuit boards.
2. Unplug the power to the ESI-100 system.
3. Remove the Base Cabinet lid by pressing the release tab at the top of the cabinet and rock back the lid from the bottom of the cabinet.
4. Install the Expansion Cabinet on the front of the Base Cabinet in place of the Base Cabinet's lid.
5. Lock the Expansion Cabinet to the Base Cabinet by snapping the top in place and reinstalling the retaining screw.
6. Connect the grounding strap from the Expansion Cabinet's grounding lug (located on the bottom of the cabinet) to the Base Cabinet's grounding lug. (See also "Grounding instructions," page I.1).
7. Through the large opening in the back of the Expansion Cabinet, connect the ribbon cable(s) from the port card(s) to the card directly below.
8. Re-install the original lid from the Base Cabinet on the face of the Expansion Cabinet.



## Port card installation

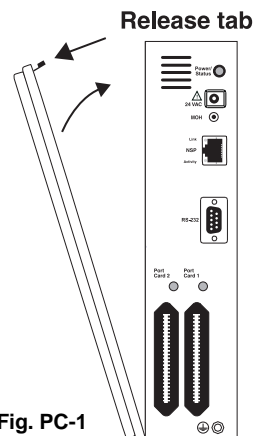
Adding or replacing port cards will require the system to be taken out of service (the ESI-100 doesn't support "hot-swapping" of its port cards).

**Notes:** The ESI-100 can use **only** E2 port cards (see "Port card options," beginning on page A.4).  
**ALWAYS power down the system BEFORE adding or replacing any hardware.** Also, be sure to observe all proper procedures regarding the prevention of electrostatic discharge (ESD) when performing the following procedures; otherwise, circuit boards may suffer damage.  
 Whenever you change the port card configuration, you **must** create a **backup file** for the new configuration to be able to perform the Restore function later.

After removing the E2 port card from the box, install it as follows:

1. Unplug the power supply to the system.
2. Remove the locking screw (at the top of the cabinet, securing the cover), and then remove the top cover by pressing down the locking tab and pulling the top cover forward (**Fig. PC-1**).

**Note:** Port cards are added to an existing Base Cabinet in a "piggyback" fashion — *i.e.*, port card 2 (J1) plugs into port card 1 (J2), port card 3 (J1) plugs into port card 2 (J2), *etc.*



(Continued)

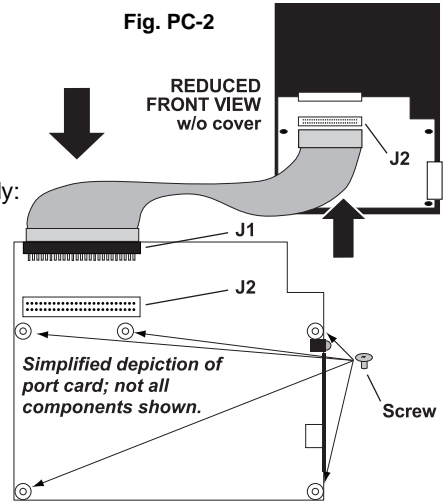


3. A cable is attached to **Connector J1** of the E2 port card. Connect the cable's other end to **Connector J2** of the cabinet's existing port card.

4. Secure the E2 port card to the cabinet (**Fig. PC-2**). If it's going into the **top** slot, use five screws. If it's going into the **bottom** slot, use five standoffs appropriately:

- **7/16-in. standoffs** — Between the Base Cabinet and the first card.
- **3/4-in. standoffs** — Between the first and second card in the Base Cabinet.
- **1-in. standoffs** — Between port cards in the Expansion Cabinet.

Use the screws that ship with the E2 port card to secure the card to the standoffs. (You may have leftover screws.) **DON'T** overtighten the standoffs; it will strip the plastic bosses.

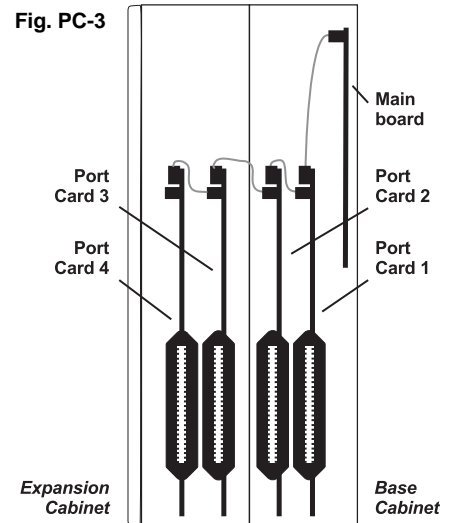


5. Put the top cover back on the cabinet, and then replace the locking screw to secure the cover on the cabinet. (In other words, perform the reverse of Step 2.)

6. To remove the E2 port card, follow steps 2–5 in reverse order.

**Fig. PC-3** (right) shows the configuration of a fully loaded ESI-100.

**Note:** For adding an ASC as the fifth card, see page G.8.



## Memory Module installation or replacement

**Note:** The Memory Module has a **proprietary** formatting scheme — **do not** attempt to install a non-ESI drive. Contact ESI for a replacement Memory Module, if needed.

Adding or replacing the Memory Module will require that the ESI-100 be taken out of service.

**All of the ESI-100's configuration data and customer recordings are stored in the Memory Module.**

Replacing it, therefore, requires re-programming and re-recording, unless you have previously performed a backup using *ESI System Programmer* software. (Prompts stay intact, however.)

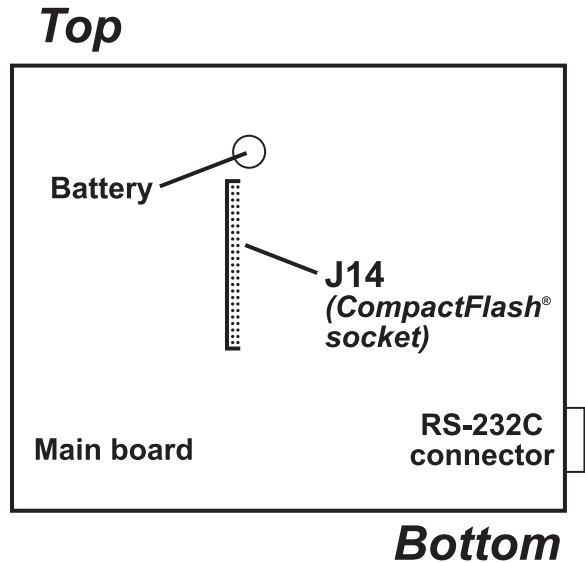
**Note:** Be sure to observe all proper procedures regarding the prevention of electrostatic discharge (ESD) when performing the following procedures; otherwise, circuit boards may suffer damage.

### Install the CompactFlash Memory Module

1. Open the lid of the cabinet (you must remove the screw on the top that secures the lid).
2. Power down the system.
3. Plug the Memory Module into the **J14** connector on the main board (see diagram, *right*).
4. Secure the lid to the KSU.

### Remove the CompactFlash Memory Module (if replacing)

1. Open the lid of the cabinet (you must remove the screw on the top that secures the lid).
2. Power down the system.
3. Remove the Memory Module from the **J14** connector on the main board (see diagram, *right*).
4. To install the Memory Module, follow the steps in "Install the CompactFlash Memory Module," *above*.



## LED functions

The unit's various LEDs are designed to provide visual feedback as follows:

### **Power LED**

The **Power** LED is located on the right side of the Base Cabinet, and is illuminated when power is being applied to the system. This LED blinks periodically to indicate that the main processor is operational.

### **Port LEDs**

The **Port** LEDs are located above their respective connectors on each installed port card. Each LED is illuminated when any port on its associated port card is in use.

**Note:** Disconnecting a connector when its respective LED is lit will disconnect any of its ports that are in use.

Upon power-up, approximately five minutes are required for the system to configure. The **Power** and **Port** LEDs will blink three times to indicate that the power-up sequence has been completed.

**Note:** When a DLC's LED is . . .

- . . . blinking, the T1/PRI circuit is out of service.
- . . . not lit at all, the T1/PRI circuit is in service but is idle.
- . . . lit solidly, the T1/PRI circuit and/or a station on the card are in use.

## ESI Presence Management installation

For information on installing ESI Presence Management, see its *Installation Manual* (ESI # 0450-0792).

## ESI Cellular Management installation

### Hardware

The ESI Cellular Management Access Device (see graphic, *below*) is housed in a small, ergonomic plastic case, which connects to a digital phone port. Although the Access Device is intended for desktop placement near the host ESI phone<sup>1</sup>, it can be attached to any surface by using the included Velcro® strips.

The ESI Cellular Management Access Device is powered by the digital port.

Each ESI Cellular Management Access Device requires a single digital port. Only the number of available station ports limits the number of ESI Cellular Management devices that can be connected to the system.



### HANDSET LED

A single blue **HANDSET** LED on the front panel of the ESI Cellular Management Access Device displays the status of a Bluetooth-enabled cell phone as related to the ESI phone:

- **Off** — Unpaired with a cellular phone.
- **Blinking slowly** — Not connected (Auto-Connect disabled).
- **Blinking moderately** — Searching for cell phone (not connected).
- **Blinking rapidly** — In pairing mode.
- **On** — Cell phone is paired and connected.

### PAIRING button

The **PAIRING** button, on the rear of the Access Device, is used to initiate the pairing of a Bluetooth-enabled handset and/or headset with ESI Cellular Management.

### Jacks

The Access Device's **DIGITAL** jack is an RJ-11 jack for connecting the Access Device to an ESI digital port. Power is provided via the included 12-ft. line cord connection to an ESI digital port card.

The **PC** and **NETWORK** jacks are reserved for possible future use.

For information on installing ESI Cellular Management, see its *Installation Guide* (ESI # 0450-1155).

<sup>1</sup> While it is possible to **program** ESI Cellular Management from an ESI 30D, the **use** of certain ESI Cellular Management features is possible only through the soft keys under the display of an ESI 60, ESI 40, or 48-Key Feature Phone.

<sup>2</sup> Reserved for possible future use.

## Installation of card(s) for ESI Mobile Messaging and SIP trunking

The following instructions cover installation of the **CS-SIP24**, **CS-SIP8**, and **CS-ASC** on an ESI-100 or ESI-50.

**Important:** Each card is for ESI Communications Servers **only** (except ESI-50L) and requires a Hot-Swap Port Card Adapter (five-pack, ESI # 5000-0462) if used on an ESI-1000, ESI-600, or ESI-200.

Before installing, verify that the system is running the appropriate system software. If it isn't, download the correct version from the ESI Resellers' Web site and install it on the system.

**ALWAYS power-down the entire system (all Cabinets) BEFORE adding or replacing any hardware.** Also, be sure to observe all proper procedures regarding the prevention of electrostatic discharge (ESD) when performing the following procedures; otherwise, circuit boards may suffer damage.

Whenever you change the port card configuration, you **must** create a **backup file** for the new configuration to be able to perform the Restore function later.

**On the ESI-100 ONLY, if installing a CS-ASC as the fifth card, see "Fifth-card installation of CS-ASC (ESI-100 only)," page G.9.**

After removing the new card from the box, install it as follows:

1. Remove the locking screw (at the top of the cabinet, securing the cover), and then remove the top cover by pressing down the locking tab and pulling the top cover forward (**Fig. C-1**).

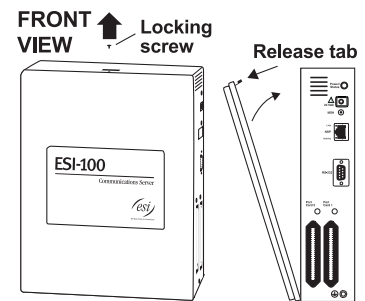


Figure C-1 (ESI-100 shown)

On each system, port cards are added in a "piggyback" fashion — *i.e.*, port card 2 plugs into port card 1, port card 3 plugs into port card 2, *etc.* (Neither the CS-SIP24 nor the CS-SIP8 nor the ASC may be in slot 1 on an ESI-100, and the ESI-50 main board contains a fixed 482 card.) Use the following table and **Fig. C-2** (*below*) to determine which connectors to use in each case:

System	Connecting SIP/ASC to . . .	Use these respective connectors . . .
ESI-100	Main board	n/a (not permitted)
ESI-100	Another port card other than a CS-SIP24, CS-SIP8, or CS-ASC	J15 to J2
ESI-100	Another CS-SIP24, CS-SIP8, or CS-ASC	J15 to J16
ESI-50	Main board	J18 to J16
ESI-50	A 482 card ( <i>i.e.</i> , <b>not</b> the one built into the ESI-50 main board)	J18 to J6
ESI-50	A DLC82 card	J18 to J9
ESI-50	Another CS-SIP24, CS-SIP8, or CS-ASC	J18 to J17

2. A cable is attached to the correct connector of the new card. Connect the cable's other end to the correct connector of the cabinet's existing port card.

3. Secure the card to the cabinet (**Fig. C-2**).

If it's going into the **top** slot, use five screws.

If it's going into the **bottom** slot, use five standoffs appropriately:

- **7/16-in. standoffs** — Between the ESI-100 Base Cabinet and the first card.
- **3/4-in. standoffs** — Between the first and second card in the ESI-100 Base Cabinet.
- **1-in. standoffs** — Between port cards in **either** the ESI-100 Expansion Cabinet **or** the ESI-50.

Use the screws that ship with the card to secure the new card to the standoffs. (You may have leftover screws.) **DON'T** overtighten the standoffs; it will strip the plastic bosses.

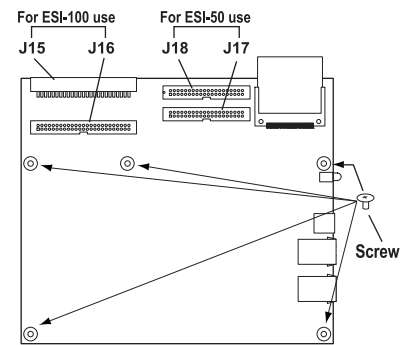
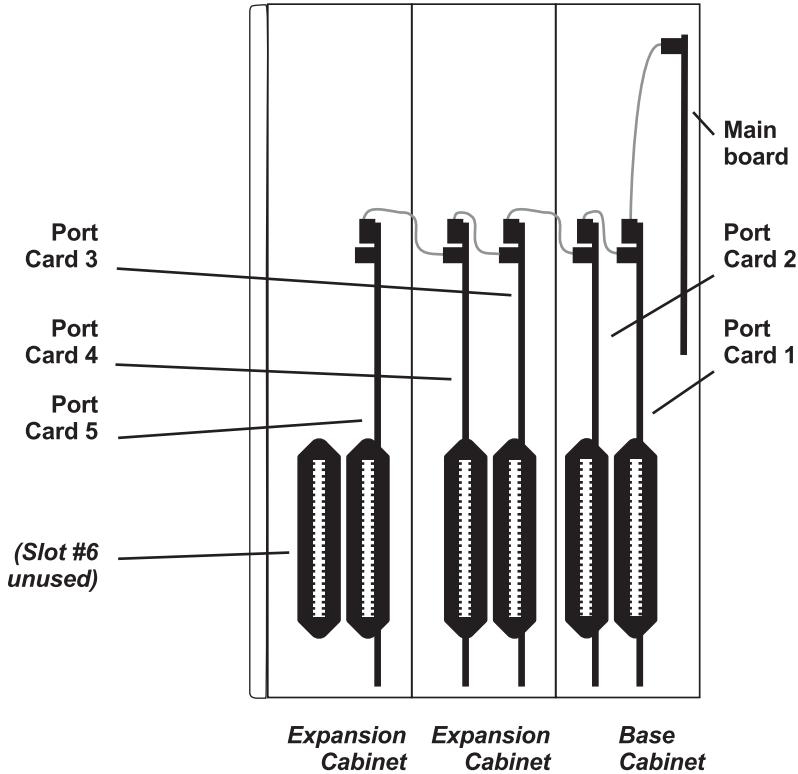


Figure C-2

4. Put the top cover back on the cabinet, and then replace the locking screw to secure the cover on the cabinet. (In other words, perform the reverse of Step 1.)
5. To remove the new card, follow steps 1–4 in reverse order.

### Fifth-card installation of CS-ASC (ESI-100 only)

To install a CS-ASC as the **fifth** card in an ESI-100 (requires system software 12.5.41.0 or higher), attach a **second** Expansion Cabinet to the Expansion Cabinet that you attached to the Base Cabinet, and install the ASC in the second Expansion Cabinet as **Port Card 5**, as shown in the graphic *below*. Note that the left-most slot in the second Expansion Cabinet, shown here as **Slot #6**, is unused.



### Use of Ethernet connectors

- **CS-SIP24** or **CS-SIP8** — Both Ethernet® connectors must be connected to the private local area network (LAN).
- **ASC** — Only Ethernet Connector #1 must be connected to the private LAN.

For information on programming ESI Mobile Messaging, see its *Installation Guide* (ESI # 0450-1231).

For information on installing SIP trunking, see the *ESI SIP Trunking Installation Guide* (ESI # 0450-1227).

## Installation of Memory Module for CS-ASC

**Important:** The CS-ASC (Applications Services Card) is for ESI Communications Servers **only (except ESI-50L)** and requires a Hot-Swap Port Card Adapter (five-pack, ESI # 5000-0462) if used on an ESI-1000, ESI-600, or ESI-200.

Before installing, verify that the system is running the appropriate system software. If it isn't, download the correct version from the ESI Resellers' Web site and install it on the system.

**ALWAYS power-down the entire system (all Cabinets) BEFORE adding or replacing any hardware.** Also, be sure to observe all proper procedures regarding the prevention of electrostatic discharge (ESD) when performing the following procedures; otherwise, circuit boards may suffer damage.

Whenever you change the port card configuration, you **must** create a **backup file** for the new configuration to be able to perform the Restore function later.

Installing the ASC Memory Module (hard drive) does **not** replace the CompactFlash<sup>®</sup> (which is preinstalled).

### What you'll need

Here's what you'll need to install the ASC Memory Module (hard drive):

- ¼-inch nut driver
- #1 Phillips screwdriver
- A clean, well-lit, and static-free work area

### Procedure

After removing the new card from the box, install the Memory Module as follows:

1. Screw into the Memory Module the four ¼-inch standoffs that came with the ASC Memory Module kit.
2. Align:
  - a. the threaded holes at the end of the hard drive subassembly's standoffs  
 . . . to . . .
  - b. the four holes on the ASC (**Fig. H-1**).
3. Using the four remaining screws that came with the Memory Module, attach the Memory Module to the ASC.
4. Connect the Memory Module's hard drive cable (**Fig. H-2**) to the appropriate connector (**U12**) on the ASC.

**Note:** To prevent the cable from interfering with insertion of the main board, fold the cable in toward the Memory Module as shown in **Fig. H-2**.

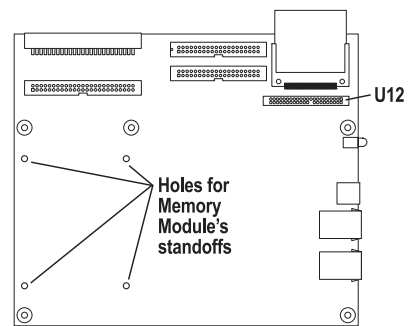


Figure H-1

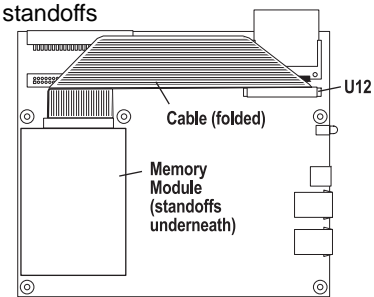


Figure H-2

# Hardware installation: ESI-50

## Site location

As with most electronic equipment, the environmental considerations for this site need to observe good common sense. Provide a dry, clean, and accessible area.

Locate space in the telephone equipment room, which will provide easy connection to the 66 blocks and 110 VAC power. **The location should be no further than 1,000 feet from the farthest station.**

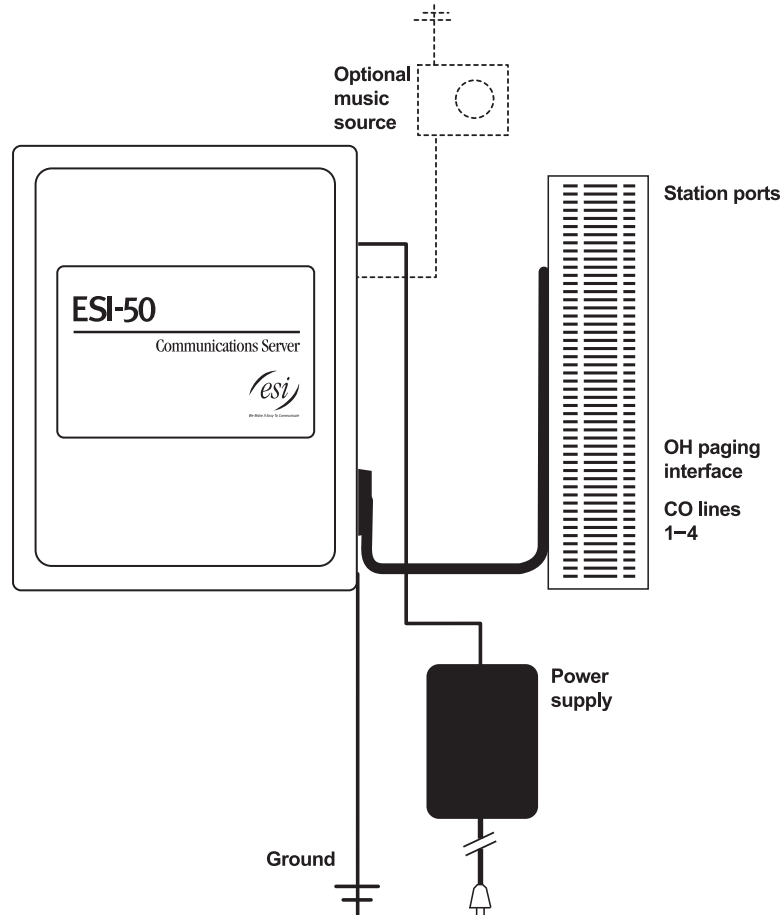
Ambient room temperature must be 40°–80° (F.), and relative humidity no higher than 90%.

**Notes:** Do not place the equipment or run station cabling near high voltage electrical equipment or electrical lines susceptible to high voltage surges from air conditioner compressors, etc.

Do not mount the equipment in a place that receives direct sunlight.

The system and supporting components should be mounted to a half-inch (or thicker) plywood backboard. Here is the layout of a typical Base Cabinet installation.

## ESI-50 Base Cabinet typical installation



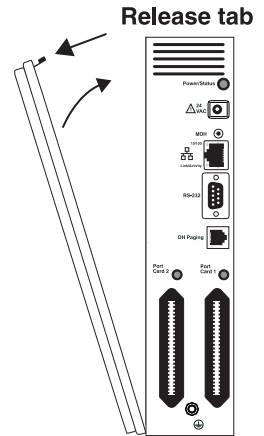


## Opening the Base Cabinet

The lid on the Base Cabinet is held in place by two tabs that rest in slots in the bottom of the case, and a release tab that snaps into an opening in the top-center of the cabinet and is secured by a retaining screw.

To remove the lid:

1. Remove the retaining screw and depress the release tab at the top of the cabinet.
2. Rock the lid back from the top.
3. Lift and pull the lid free from the slots in the bottom of the cabinet.

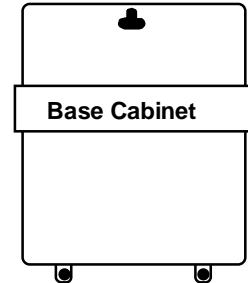


## Mounting the Base Cabinet

To mount the ESI-50 Base Cabinet, use the three provided #8 Phillips screws. Note the position of the three mounting holes in the cabinet. Allow room for installation of the Expansion Cabinet (see page G.3) either now or, if required, in the future.

1. Screw in the top screw to the backboard (at least half-inch thick plywood) leaving about one-eighth-inch clearance between the screw head and the plywood.
2. Hang the unit using the keyhole at the top of the case.
3. Level the unit and install the bottom two screws.

Attach the power transformer to the wall, allowing sufficient length in both cords to reach the power connector on the upper right side of the cabinet and to reach a UPS or a dedicated 110 VAC outlet.



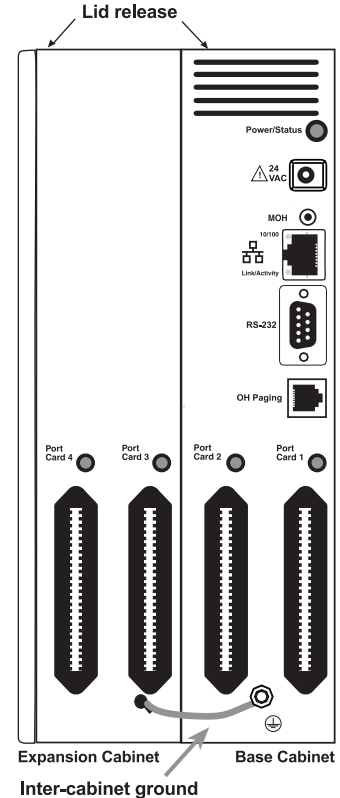
## Expansion Cabinet installation

The Expansion Cabinet allows the ESI-50's capacity to grow by up to two additional port cards. The cards are connected via ribbon cables, through the opening in the back of the Expansion Cabinet, to the Base Cabinet.

**Note:** You can add only one Expansion Cabinet to an ESI-50.

To install an Expansion Cabinet:

1. Wear a grounding strap and avoid unnecessary movement while handling the circuit boards.
2. Unplug the power to the ESI-50 system.
3. Remove the Base Cabinet lid by pressing the release tab at the top of the cabinet and rock back the lid from the bottom of the cabinet.
4. Install the Expansion Cabinet on the front of the Base Cabinet in place of the Base Cabinet's lid.
5. Lock the Expansion Cabinet to the Base Cabinet by snapping the top in place and reinstalling the retaining screw.
6. Connect the grounding strap from the Expansion Cabinet's grounding lug (located on the bottom of the cabinet) to the Base Cabinet's grounding lug. (See also "Grounding instructions," page I.1).
7. Through the large opening in the back of the Expansion Cabinet, connect the ribbon cable(s) from the port card(s) to the card directly below.
8. Re-install the original lid from the Base Cabinet on the face of the Expansion Cabinet.



## Port card installation

Adding or replacing port cards will require the system to be taken out of service (the ESI-50 doesn't support "hot-swapping" of its port cards).

These instructions cover all port cards supported by the ESI-50: the **482** card (used on all ESI-50 models); and the **DLC82** card, **CS-SIP24** card, **CS-SIP8** card, and **CS-ASC** (not compatible with the ESI-50L<sup>1</sup>). Each card has cable connectors in the same location, but the connectors have different names depending on the card type:

- On the **482** card, the connectors are **J5** and **J6**, respectively.
- On the **DLC82** card, the connectors are **J8** and **J9**, respectively.
- On the **CS-SIP24** card, **CS-SIP8** card and **CS-ASC**, the connectors are **J17** and **J18**, respectively.

Therefore, for brevity's sake, these instructions and their diagram describe the connectors as **J5/J8/J17** and **J6/J9/J18**.

**Important:** The ESI-50 can use **only** these port cards: 482, DLC82, CS-SIP24, CS-SIP8, and CS-ASC (see "Port card options," beginning on page A.4).

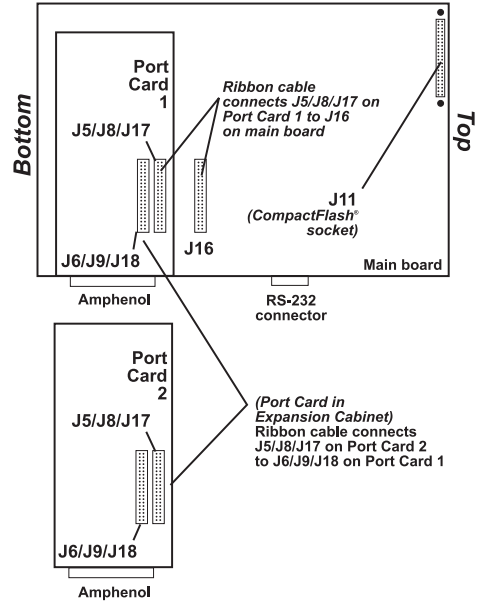
**ALWAYS power down the system BEFORE adding or replacing any hardware.** Also, be sure to observe all proper procedures regarding the prevention of electrostatic discharge (ESD) when performing the following procedures; otherwise, circuit boards may suffer damage.

The DLC82 can be installed in **ONLY** slot 2.

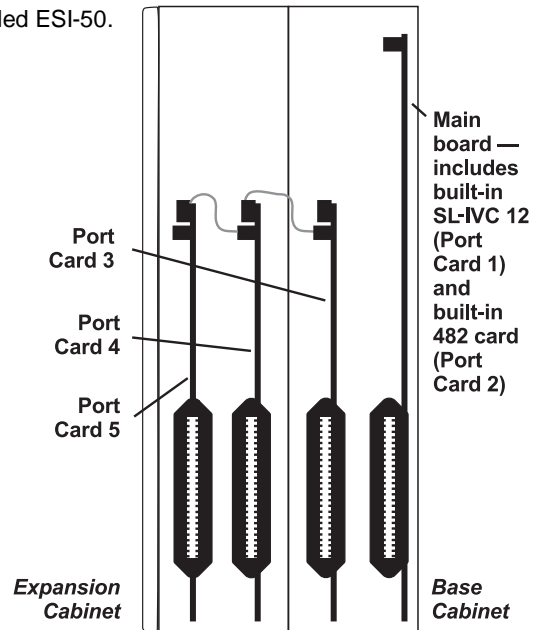
Whenever you change the port card configuration, you **must** create a **backup file** for the new configuration to be able to perform the Restore function later.

<sup>1</sup> If installing the ESI-50L, consult the *ESI-50L Hardware Installation Manual* (0450-1159).

1. Remove the locking screw at the top of the Base Cabinet, securing the cover, and remove the top cover by pressing down the locking tab and pulling the top cover forward.
2. Connect the first port card by inserting the ribbon cable from **J5/J8/J17** on the port card to **J16** on the main board.
3. Secure the port card with the five screws that came with the port card to the standoffs that came with the Base Cabinet.
4. If you're installing a second port card, secure the second port card to the Expansion Cabinet, using the screws provided with the port card.
5. Connect the second port card by inserting the ribbon cable from **J5/J8/J17** on the port card to **J6/J9/J18** on the first port card (located in the Base Cabinet).
6. Attach the Expansion Cabinet to the Base Cabinet, and secure with the locking screw at the top of the Base Cabinet.
7. Secure the lid to the KSU and/or Expansion Cabinet.
8. Reverse the steps to remove the port card. **Remember to power down the system before replacing parts.**



The diagram at *right* shows the configuration of a fully loaded ESI-50.



## Memory Module installation or replacement

**Note:** The Memory Module has a **proprietary** formatting scheme — **do not** attempt to install a non-ESI drive. Contact ESI for a replacement Memory Module, if needed.

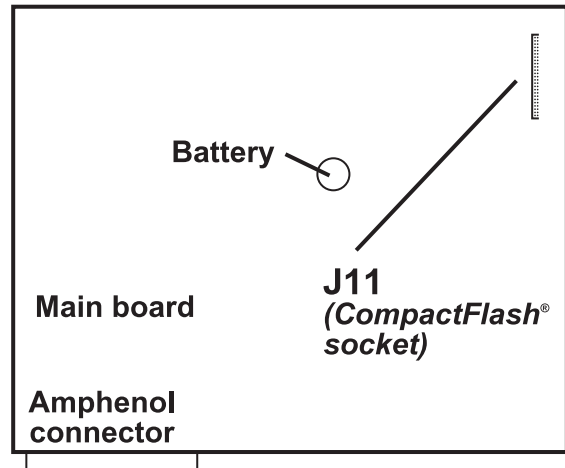
Adding or replacing the Memory Module will require that the ESI-50 be taken out of service.

**All of the ESI-50's configuration data and customer recordings are stored in the Memory Module.** Replacing it, therefore, requires re-programming and re-recording, unless you have previously performed a backup using *ESI System Programmer* software. (Prompts stay intact, however.)

**Note:** Be sure to observe all proper procedures regarding the prevention of electrostatic discharge (ESD) when performing the following procedures; otherwise, circuit boards may suffer damage.

### Install the CompactFlash Memory Module

1. Open the lid of the cabinet (you must remove the screw on the top that secures the lid).
2. Power down the system.
3. Plug the Memory Module into the **J11** connector on the main board (see diagram, *right*).
4. Secure the lid to the KSU.



### Remove the CompactFlash Memory Module (if replacing)

1. Open the lid of the cabinet (you must remove the screw on the top that secures the lid).
2. Power down the system.
3. Remove the Memory Module from the **J11** connector on the main board (see diagram, *above*).
4. To install the Memory Module, follow the steps in "Install the CompactFlash Memory Module," *above*.

## LED functions

The unit's various LEDs are designed to provide visual feedback as follows:

### **Power LED**

The **Power LED** is located on the right side of the Base Cabinet, and is illuminated when power is being applied to the system. This LED blinks periodically to indicate that the main processor is operational.

### **Port LEDs**

The **Port LEDs** are located above their respective connectors on each installed port card. Each LED is illuminated when any port on its associated port card is in use.

**Note:** Disconnecting a connector when its respective LED is lit will disconnect any of its ports that are in use.

Upon power-up, approximately five minutes are required for the system to configure. The **Power** and **Port LEDs** will blink three times to indicate that the power-up sequence has been completed.

**Note:** When the LED on a DLC<sup>1</sup> is . . .

- . . . blinking, the T1/PRI circuit is out of service.
- . . . not lit at all, the T1/PRI circuit is in service but is idle.
- . . . lit solidly, the T1/PRI circuit and/or a station on the card are in use.

---

<sup>1</sup> The DLC82 for the ESI-50 supports only PRI (not T1). DLCs for other ESI Communications Servers support both T1 and PRI. Please note also that the DLC82 is for **only** the ESI-50 and **not** the ESI-50L.

## ESI Presence Management installation

For information on installing ESI Presence Management, see its *Installation Manual* (ESI # 0450-0792).

## ESI Cellular Management installation

### Hardware

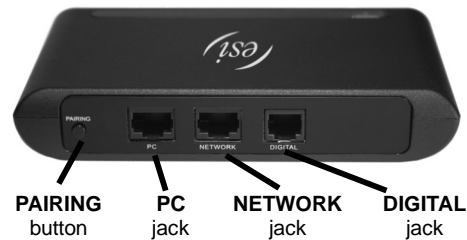
The ESI Cellular Management Access Device (see graphic, *below*) is housed in a small, ergonomic plastic case, which connects to a digital phone port. Although the Access Device is intended for desktop placement near the host ESI phone, it can be attached to any surface by using the included Velcro® strips.

The ESI Cellular Management Access Device is powered by the digital port. Each ESI Cellular Management Access Device requires a single digital port. Only the number of available station ports limits the number of ESI Cellular Management devices that can be connected to the system.



HANDSET LED

Front panel.



PAIRING button PC jack NETWORK jack DIGITAL jack

Back panel.

### HANDSET LED

A single blue **HANDSET** LED on the front panel of the ESI Cellular Management Access Device displays the status of a Bluetooth-enabled cell phone as related to the ESI phone:

- **Off** — Unpaired with a cellular phone.
- **Blinking slowly** — Not connected (Auto-Connect disabled).
- **Blinking moderately** — Searching for cell phone (not connected).
- **Blinking rapidly** — In pairing mode.
- **On** — Cell phone is paired and connected.

### PAIRING button

The **PAIRING** button, on the rear of the Access Device, is used to initiate the pairing of a Bluetooth-enabled handset and/or headset with ESI Cellular Management.

### Jacks

The Access Device's **DIGITAL** jack is an RJ-11 jack for connecting the Access Device to an ESI digital port. Power is provided via the included 12-ft. line cord connection to an ESI digital port card.

The **PC** and **NETWORK** jacks are reserved for possible future use.

For information on installing ESI Cellular Management, see its *Installation Guide* (ESI # 0450-1155).

## Installation of card(s) for ESI Mobile Messaging and SIP trunking

The following instructions cover installation of the **CS-SIP24**, **CS-SIP8**, and **CS-ASC** on an ESI-100 or ESI-50.

**Important:** Each card is for ESI Communications Servers **only** (except ESI-50L) and requires a Hot-Swap Port Card Adapter (five-pack, ESI # 5000-0462) if used on an ESI-1000, ESI-600, or ESI-200.

Before installing, verify that the system is running the appropriate system software. If it isn't, download the correct version from the ESI Resellers' Web site and install it on the system.

**ALWAYS power-down the entire system (all Cabinets) BEFORE adding or replacing any hardware.** Also, be sure to observe all proper procedures regarding the prevention of electrostatic discharge (ESD) when performing the following procedures; otherwise, circuit boards may suffer damage.

Whenever you change the port card configuration, you **must** create a **backup file** for the new configuration to be able to perform the Restore function later.

After removing the new card from the box, install it as follows:

1. Remove the locking screw (at the top of the cabinet, securing the cover), and then remove the top cover by pressing down the locking tab and pulling the top cover forward (**Fig. C-1**).

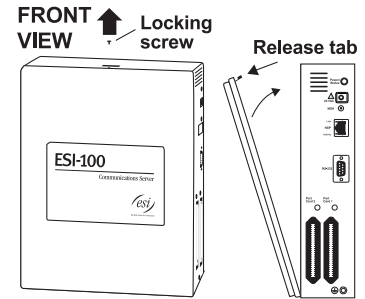


Figure C-1 (ESI-100 shown)

On each system, port cards are added in a “piggyback” fashion — *i.e.*, port card 2 plugs into port card 1, port card 3 plugs into port card 2, *etc.* (Neither the CS-SIP24 nor the CS-SIP8 nor the ASC may be in slot 1 on an ESI-100, and the ESI-50 main board contains a fixed 482 card.) Use the following table and **Fig. C-2** (*below*) to determine which connectors to use in each case:

System	Connecting SIP/ASC to . . .	Use these respective connectors . . .
ESI-100	Main board	n/a (not permitted)
ESI-100	Another port card other than a CS-SIP24, CS-SIP8, or CS-ASC	J15 to J2
ESI-100	Another CS-SIP24, CS-SIP8, or CS-ASC	J15 to J16
ESI-50	Main board	J18 to J16
ESI-50	A 482 card ( <i>i.e.</i> , <b>not</b> the one built into the ESI-50 main board)	J18 to J6
ESI-50	A DLC82 card	J18 to J9
ESI-50	Another CS-SIP24, CS-SIP8, or CS-ASC	J18 to J17

2. A cable is attached to the correct connector of the new card. Connect the cable's other end to the correct connector of the cabinet's existing port card.
3. Secure the card to the cabinet (**Fig. C-2**).  
If it's going into the **top** slot, use five screws.  
If it's going into the **bottom** slot, use five standoffs appropriately:

- **7/16-in. standoffs** — Between the ESI-100 Base Cabinet and the first card.
- **3/4-in. standoffs** — Between the first and second card in the ESI-100 Base Cabinet.
- **1-in. standoffs** — Between port cards in **either** the ESI-100 Expansion Cabinet **or** the ESI-50.

Use the screws that ship with the card to secure the new card to the standoffs. (You may have leftover screws.) **DON'T** overtighten the standoffs; it will strip the plastic bosses.

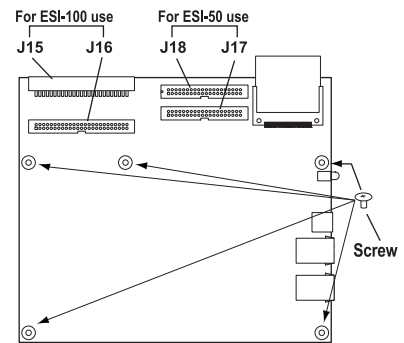


Figure C-2

4. Put the top cover back on the cabinet, and then replace the locking screw to secure the cover on the cabinet. (In other words, perform the reverse of Step 1.)
5. To remove the new card, follow steps 1–4 in reverse order.

### Use of Ethernet connectors

- **CS-SIP24** or **CS-SIP8** — Both Ethernet® connectors must be connected to the private local area network (LAN).
- **ASC** — Only Ethernet Connector #1 must be connected to the private LAN.

For information on programming ESI Mobile Messaging, see its *Installation Guide* (ESI # 0450-1231).

For information on installing SIP trunking, see the *ESI SIP Trunking Installation Guide* (ESI # 0450-1227).

## Installation of Memory Module for CS-ASC

**Important:** The CS-ASC (Applications Services Card) is for ESI Communications Servers **only (except ESI-50L)** and requires a Hot-Swap Port Card Adapter (five-pack, ESI # 5000-0462) if used on an ESI-1000, ESI-600, or ESI-200.

Before installing, verify that the system is running the appropriate system software. If it isn't, download the correct version from the ESI Resellers' Web site and install it on the system.

**ALWAYS power-down the entire system (all Cabinets) BEFORE adding or replacing any hardware.** Also, be sure to observe all proper procedures regarding the prevention of electrostatic discharge (ESD) when performing the following procedures; otherwise, circuit boards may suffer damage.

Whenever you change the port card configuration, you **must** create a **backup file** for the new configuration to be able to perform the Restore function later.

Installing the ASC Memory Module (hard drive) does **not** replace the CompactFlash® (which is preinstalled).

### What you'll need

Here's what you'll need to install the ASC Memory Module (hard drive):

- ¼-inch nut driver
- #1 Phillips screwdriver
- A clean, well-lit, and static-free work area

### Procedure

After removing the new card from the box, install the Memory Module as follows:

1. Screw into the Memory Module the four ¼-inch standoffs that came with the ASC Memory Module kit.
2. Align:
  - a. the threaded holes at the end of the hard drive subassembly's standoffs
  - ... to ...
  - b. the four holes on the ASC (**Fig. H-1**).
3. Using the four remaining screws that came with the Memory Module, attach the Memory Module to the ASC.
4. Connect the Memory Module's hard drive cable (**Fig. H-2**) to the appropriate connector (**U12**) on the ASC.

**Note:** To prevent the cable from interfering with insertion of the main board, fold the cable in toward the Memory Module as shown in **Fig. H-2**.

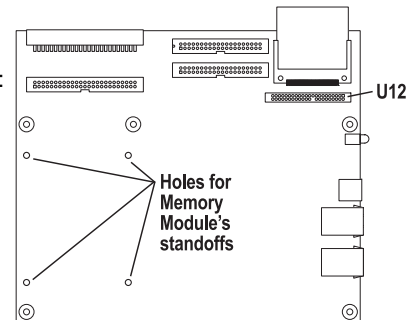


Figure H-1

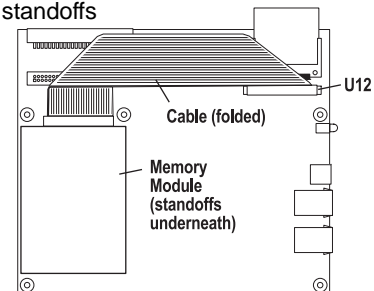


Figure H-2



# External connections

## Grounding instructions

System grounding (supplemental ground) is as follows:

- The conductor wires can be no smaller than the ungrounded branch-circuit supply conductors (usually 16-gauge or higher).
- Acceptable wire: bare **or** covered with green (or green-and-yellow-striped) jacket.
- Conductors (and power receptacles) shall connect to earth ground at the service equipment (usually a cold water pipe or copper ground rod).
- The supplemental ground must: be used regardless of power cord ground, be connected to the ground lug on the bottom of the cabinet, and retain ground connection when the power supply module is unplugged.
- Connect the grounding lugs of all units to system ground

**Note:** ESI Communications Server lines are protected against a 10 KV surge **only** if the earth ground procedures described above are followed.

## Power

Each cabinet requires a 110 VAC outlet (if possible, a dedicated outlet). Use **only** the Class-2 power supply module provided. A clean, isolated power source in conjunction with a UPS is **STRONGLY** recommended.

The following table shows the power consumption of each ESI Communications Server when fully loaded:

System	Cabinets (Base and Expansion) in fully loaded system	Power consumption (in watts)
<b>ESI-1000</b>	6	1,080
<b>ESI-600</b>	4	720
<b>ESI-200</b>	2	360
<b>ESI-100</b>	3	125
<b>ESI-50</b>	2	72

If AC power is interrupted, the system will drop all connections. When power is restored, the system will resume normal operation in approximately five minutes, having retained its full programming and clock setting.

## UPS

For system protection and to maintain uninterrupted operation, an uninterruptible power supply is **STRONGLY** recommended. Here are the recommended UPS ratings for each system:

System	Recommended UPS minimum rating PER INSTALLED CABINET (in VA)
<b>ESI-1000</b>	230
<b>ESI-600</b>	230
<b>ESI-200</b>	230
<b>ESI-100</b>	125
<b>ESI-50</b>	125

Refer to the particular UPS unit's specifications to determine expected backup duration during a power outage.

**Note:** The remaining information under "UPS" comes from *Technical Update #216*.

Most people have heard about UPSs, but seem to think that there is just one kind of device that goes by that name. In fact, there are several different major designs in use by today's major UPS manufacturers. These makers share much of the blame for confusing UPSs' end users by, far too often, lumping different designs under the "UPS" name.

(Continued)

UPSs can first be broken down into **system types**:

- **Stand-by** — A very simple design that affects power only when either a lag/brownout occurs below, or a spike/surge occurs above, a certain threshold. When either occurs, the unit trips — *i.e.*, goes into battery mode. This "cleans" the voltage and helps to keep any load safe. Industry average "trip" times are 2–8 ms. No other filtration of AC power is performed.
- **Line interactive** — Constantly monitors inbound voltages, and uses special circuitry to boost low voltages and clamp high voltages without having to use the batteries. Indeed, the batteries are used only if the input voltage drops below acceptable levels (typically about 12% below normal), goes out completely or rises to dangerous levels (typically about 14% above normal) at which components will be damaged if line voltage is not removed. Industry average transfer time is 1–3 ms. (If voltage stays within its normal window, this unit continues to pass voltage, unaltered, from the wall.)
- **On-line** (or *full on-line*) — Constantly filters the power and performs a function known as double conversion (AC to DC to AC). This assures that the load — in this case, phone equipment — will receive not only uninterrupted, true sine wave output but also the cleanest, steadiest power possible throughout any foreseeable power disruptions or voltage irregularities. According to industry specs, it is not unusual for these types of units to be able to regulate utility power, even when it drops to 27% below or rises to 33% above normal, all without using their batteries.

From this point, UPSs can be further broken down by inverter types, which determine output. These are:

- **Square wave.**
- **Modified sine wave** (or *quasi sine wave*).
- **Sine wave.**

Most devices with wall-mounted chargers, such as cordless drills or screwdrivers, can behave erratically — sometimes not allowing the charge circuit to engage at all — when operating with modified sine or square wave inverters. Small wall-based transformer-style power supplies, similar to those ESI phone systems use, can experience overheating problems with modified sine or square wave outputs, which occur while some UPSs are operating in battery mode. This overheating could eventually cause damage to the power supplies; and, in time, the damage could cause a spike through the phone system — seriously damaging some of the static-sensitive components inside the casing.

While the **true** sine wave UPS output power curve smoothly increases to its peak, then smoothly decreases (allowing connected loads and equipment to operate the same as they would from utility supplied wall power), the **modified** sine wave and square wave UPS output power curve will shoot straight up, level off at peak voltage and then drop straight down. Additionally troublesome is that the modified sine wave sits at zero voltage for a short period during the transition to or from batteries — which is the main difference between it and the square wave output of some UPS. Please note that this short interval during which the modified sine wave UPS sits at zero voltage can directly affect the transfer time of the UPS and could, theoretically, be enough to cause the phone equipment to reset or even "freeze."

Though it is hard to predict exactly when different ESI systems will have problems with modified sine wave or square waveform UPSs (meaning during a power failure event or the recovery from one), it's fair to assume that a problem will eventually arise from the use of such UPSs. **Therefore, ESI recommends that only true sine wave output UPSs provide backup power to our phone systems and equipment.**

## MOH port

The MOH (messages-, or music-, on-hold) connector — located on the main board faceplate (ESI-1000, ESI-600, and ESI-200) or the Base Cabinet's right side (ESI-100) — is a standard 1/8" monophonic mini-jack, used for loading custom MOH recordings or for playing live music-on-hold from an external source such as a CD player.

## Maintenance/SMDR serial port

The **Maintenance/SMDR** port is a standard DB9 female serial connector, located on the main board faceplate (ESI-1000, ESI-600, and ESI-200) or the Base Cabinet's right side (ESI-100 and ESI-50). Use a standard shielded serial cable, DB9-to-DB9, for printer-to-computer; this is usually male-to-female.

**Note:** The maximum distance from the cabinet is 100 ft.

The output from the Maintenance/SMDR port is, 8 data bits, 1 stop bit, and no parity. The pinout is:

Data Transmit	Pin 2
Receive	Pin 3
Ground	Pin 5

To program this port, use Function 18 as described in the *ESI Communications Servers Programming Manual* (ESI #0450-1050).

**Range:** Programmable for 300, 1,200, 2,400, 4,800, 9,600, 19,200, 38,400, 57,600, or 115,200 bps.

**Default:** 38.4K.

### Maintenance

Connect a PC (such as a laptop) to the port to perform on-line programming and diagnostics. Also, the system sends reports to this port.

### SMDR

The ESI Communications Server continuously outputs real-time SMDR call records to the port.

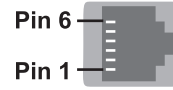
**Note:** The system will buffer up to a specific limit of SMDR records (60,000 on the ESI-1000, or 1,000 on other ESI Communications Servers) in non-volatile memory when the **Maintenance/ SMDR** serial port is in use for programming or uploading (such as during use of *ESI System Programmer*). If the buffer becomes full, the system will discard the oldest records.

For more information about the Maintenance/SMDR port, see "SMDR" in the *ESI Communications Servers Programming Manual* (ESI #0450-1050).

## External paging device connection

### ESI-1000 and ESI-600, and ESI-50

On either of these systems, a dry-contact overhead-paging device can be connected through the RJ-11 **OH Paging** connector, which is located on the front of the main board faceplate just below the NSP's Ethernet connector. Although this is a six-pin connector, only two pairs are needed between the paging device and the connector:



- To pin-out the connector for **normally open** operation, connect the **audio** wires to **pins 3 and 4** and the **control** pair to **pins 1 and 2**.
- To pin-out the connector for **normally closed** operation, connect the **audio** wires to **pins 3 and 4** and the **control** pair to **pins 5 and 6**.

### ESI-200 and ESI-100

A dry contact overhead-paging device can be connected to the system through the first port card's 66 block.<sup>1</sup> The overhead paging port is fixed (located on the main board) as code 599 for programming purposes and user access. (See "Worksheet" wiring charts, page I.23.)

### Audio connection

The audio pair is connected to the 66 block at terminal 33 and 34. The pair's impedance is 600 ohms.

**Note:** The port doesn't support talk-back paging (which requires a CO port), nor does it support CO ring through the port.

### Dry-contact control

The manner in which the dry-contact pair is punched down on the 66 block sets the pair as normally open (sending a page to the port will close the contacts) or normally closed (sending a page to the port will open the contacts).

Connect the dry-contact pair of the device to the ESI Communications Server as follows:

- Terminals 35 and **36** to provide normally **open** operation;  
or
- Terminals 36 and **38** to provide normally **closed** operation.

The port can be used with zone paging units.

**Note:** ESI doesn't recommend the use of paging contacts for door-unlocking mechanisms.

### Programming

To access the overhead paging port, assign feature code **5 9 9** to a programmable feature key.

## Amphenol cable connections

Connect a standard 66 or 110 block to each digital port card by using a male 50-pin amphenol cable to each port card female connector located on the cabinet. On the ESI-100 or ESI-50, the connector closest to the wall is the first card; on other ESI Communications Servers, the connector in the leftmost slot is the first card.

<sup>1</sup> If an IVC is installed in slot 1 on the ESI-1000, ESI-600, or ESI-200, the audio connection and dry-contact control connect via the second port card. (On an ESI-200, a non-IVC card must be in slot 1 or 2. On an ESI-100, a non-IVC card must be in slot 1. On an ESI-50, an IVC is built-in and considered to be port card 2.)

## CO line connection

**Note:** For greatest simplicity, this section mentions each port card **without** the use of an “ESI,” “E2-,” or “CS-” prefix, as cards otherwise are **functionally** identical — e.g., we refer to an E2-684 or CS-684 as just a “684.”

### Local loop

An ESI Communication Server’s advanced CO line circuitry provides for open loop detection and the system’s built-in Caller ID interface. Loop start lines are connected via the last 6 pairs on each 66 block on the 612 and 684 cards.

**Note:** Observe correct order of connection to preserve proper rotary hunting of the CO lines.

### T1/PRI

For T1 or PRI applications (**only** PRI on the ESI-50; it doesn’t support T1), an ESI Communications Server can use a compatible digital line card (DLC)<sup>1</sup>:

- **ESI-1000, ESI-600, ESI-200, ESI-100** — DLC and DLC12, each for either T1 or PRI.
- **ESI-50** — DLC82 for only PRI.

Depending on how you configure it, each supports either (a.) a single T1 circuit at 24 DS0 channels or (b.) a PRI circuit supporting 23 “B” (bearer) channels and one “D” (data link) channel. The DLC12 and DLC82 each also support 12 digital stations. The T1 or PRI line is connected via the last two pairs of the industry-standard 50-pin amphenol cable connector on the front of the DLC.

Each ESI Communications Server has a different maximum number of system-wide DLCs (see “Port card options,” page A.4). Partial T1 or PRI applications are supported through line programming.

Each DLC has built-in CSU functionality. The integrated CSU can be enabled or disabled via system programming<sup>2</sup>. The following functionality is provided: line, payload, DTE and none (normal operation) loopback modes with the ability to respond back controlled via system programming; alarm conditions, and both ANSI T1.403 and TR 54016 performance messages for ESF only.

**Important:** On the ESI-50, the DLC82 may be installed in **only** slot 2.

If you’re installing more than one T1 or PRI, the DLC in the lowest number slot will synchronize (“slave”) the system with the public network. The system will synchronize to only one clock source. Therefore, ESI **strongly** recommends that the first DLC in the system be connected to the T1 or PRI that’s connected either to the local CO or the nationwide long-distance provider, either of which typically will provide very-high-accuracy clocking (Strata 3). The DLC doesn’t provide master or sub-master clocking for private-network T1 spans.

(Continued)

<sup>1</sup> You may wish to review “Port card options,” page A.4.

<sup>2</sup> See the explanation of Function 2124 in the *ESI Communications Servers Programming Manual* (ESI #0450-1050).

When working with a T1 line<sup>1</sup>, the DLC or DLC12 supports these trunk types:

- **Loop start**
- **Ground start**
- **E&M** (including **E&M–DID/DNIS/ANI**) — When an E&M trunk is selected, the choices for **outgoing** signaling type are immediate start, wink start and dial tone start; and the **incoming** signaling type choices are immediate start and wink start. The E&M trunk can be set for 2-way traffic, inbound traffic only or outbound traffic only.

The **DID and DNIS/ANI translation table** allows the translation of DID/DNIS digits to an ID, mailbox, extension or department. See below for the number of entries that can be programmed in the table:

System	Maximum DID entries
<b>ESI-1000</b>	1,200
<b>ESI-600</b>	600
<b>ESI-200</b>	300
<b>ESI-100</b>	300
<b>ESI-50</b>	300

There is also an entry for exceptions in the table. This allows reroutes of any DID/DNIS calls that aren't programmed or detected to an ID, mailbox, extension or department and defaults to the operator.

The card supports the following framing format and line coding:

- **ESF/B8ZS** (default)
- **SF(D4)/AMI**
- **ESF/AMI**
- **SF/B8ZS**

Line compensation (or line build-out) is provided as necessary between the CSU or Smart Jack™ and the ESI Communications Server. There won't be any support for pulse dialing; all incoming dialing will default to DTMF digits.

When working with a PRI line, the DLC (*i.e.*, the DLC, DLC12, or DLC82) supports these switch protocols:

- **National-NI2** (default)
- **Nortel-DMS100**
- **AT&T/Lucent-5ESS**
- **Siemens-EWSD**

DID for the PRI is an enable/disable field. When DID is enabled, the PRI pilot table becomes active and works in combination with the DID tables.

### SIP trunks

For SIP trunking applications, an ESI Communications Server must use a compatible SIP24 or SIP8 card. Each ESI Communications Server has a different maximum number of system-wide SIP24s or SIP8s (see "Port card options," page A.4). Partial SIP applications are supported through line programming.

Supported SIP trunks are:

- **Broadvox ND**
- **Broadvox NS**

---

<sup>1</sup> Not supported by the ESI-50.

## Station connection

Except on the 482 card (ESI-50 only<sup>1</sup>), the first 12 pairs on each Amphenol are station ports:

Port card	Digital stations	Analog ports	ESI Communications Servers supporting
612	12		ESI-1000, ESI-600, ESI-200, ESI-100
D12	12		ESI-1000, ESI-600, ESI-200, ESI-100
DLC12	12		ESI-1000, ESI-600, ESI-200, ESI-100
684	8	4	ESI-1000, ESI-600, ESI-200, ESI-100
A12		12	ESI-1000, ESI-600, ESI-200, ESI-100
A4		4	ESI-1000, ESI-600, ESI-200, ESI-100
482	8	4	ESI-50 <sup>1</sup>
DLC82	8	2	ESI-50

All stations are connected using a single pair. Each port position is pre-numbered and fixed as indicated in the 66 block wiring diagram shown for each port card type.

**Note:** The station runs can be up to 1,000 ft.

### Digital stations

Digital stations for the ESI Communications Server include:

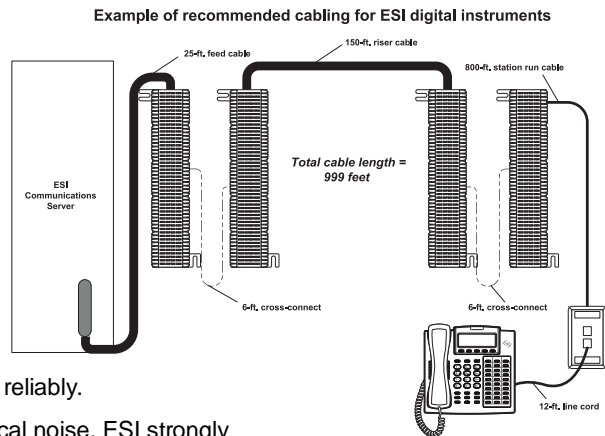
- ESI desktop phones
- ESI Digital Cordless Handset (II and original)
- ESI Presence Management RFID Readers<sup>2</sup>
- ESI Cellular Management Access Devices<sup>3</sup>

The digital station wiring is not polarity-sensitive. Only one phone can be connected per digital port. The station line voltage is 33 VDC.

For proper operation, the combined length of feed cables, backbone cabling, cross-connect, and station cable must not exceed 1000 feet (304 meters) for digital stations. Station line cord length should not exceed 12 feet (note that this is the length of the line cord provided with each ESI desktop phone).

Each digital station can have no more than two cross-connects or splices in the cable distribution. Cable construction, termination blocks, and modular jacks must meet **at minimum** Category 3 cabling requirements. Additional splices or terminations will further reduce the maximum cable length at which the digital station will operate reliably.

Because of potential interference caused by electrical noise, ESI strongly recommends against distribution of digital stations with analog stations, T1 circuits, PRI circuits, or other circuits in the same cable binder or station run.



### Analog ports

The analog ports do not require that tip-and-ring polarity be observed. The analog ports can be used for 2500-type sets or for devices such as fax machines, modems, etc., that can be connected via a normal tip-and-ring pair. Each analog port will support only a single analog device. (For total analog port capacity on each ESI Communications Server, see "System capacities," page D.1.)

All analog ports provide Type I Caller ID information (Caller ID with call waiting is not supported).

<sup>1</sup> The 482 card is supported also by the ESI-50L, the ESI C-Plus, and IVX S-Class (Generation I-II) systems.

<sup>2</sup> For information on installing ESI Presence Management, see its *Installation Manual* (ESI # 0450-0792).

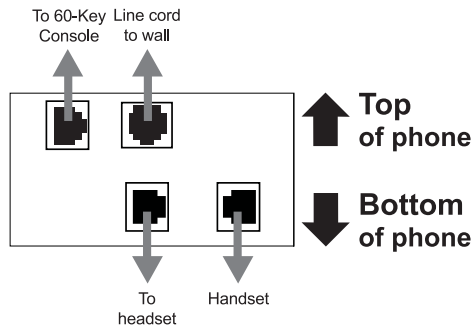
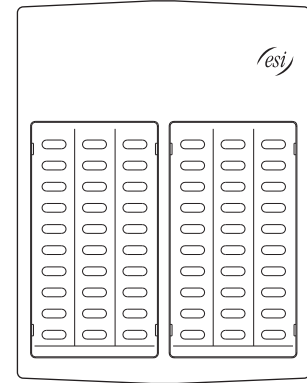
<sup>3</sup> For information on installing ESI Cellular Management, see its *Installation Guide* (ESI # 0450-1155).

## 60-Key Expansion Console connection

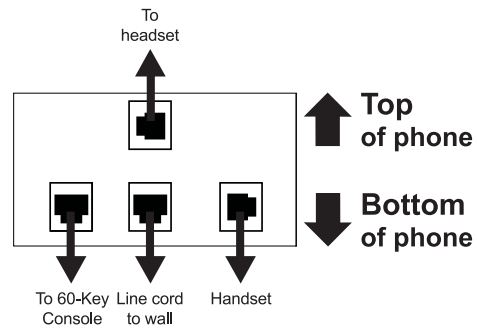
**Notes:** The 60-Key Expansion Console can be connected to an ESI 60, ESI 40, or 48-Key Feature Phone.

If connecting both a 60-Key Expansion Console and a 60-Key Second Expansion Console to an ESI phone, see "60-Key Second Expansion Console connection," page I.9.

1. The 60-Key Expansion Console (*right*) includes an **expansion cable**. Connect one end of the expansion cable to the appropriate connector on the bottom of the ESI phone (*below*). Then, connect the other end of the expansion cable to the 60-Key Expansion Console.
2. To keep cabling out of the way, thread the expansion cable into the slots on the bottom of the phone and 60-Key Expansion Console.
3. Program the keys on the 60-Key Expansion Console using the same procedure as with the ESI phone (press **PROG/HELP 2**).
4. If necessary, remove the clear **plastic** overlay from the keys on the Expansion Console.
5. For the customer's convenience, label the **paper** overlay to show how the keys are programmed (we suggest you use *ESI System Programmer* for this).
6. Install the labeled **paper** overlay on the 60-Key Expansion Console.
7. Install the clear **plastic** overlay **over** the paper overlay, to protect it.
8. Use the provided Velcro<sup>®</sup> tape to attach the left side of the 60-Key Expansion Console to the right side of the ESI phone.



Connectors on bottom of  
ESI 60 or ESI 40



Connectors on bottom of  
48-Key Feature Phone

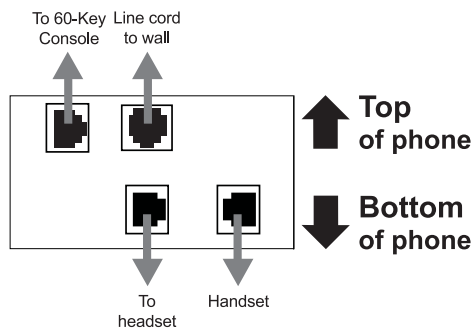
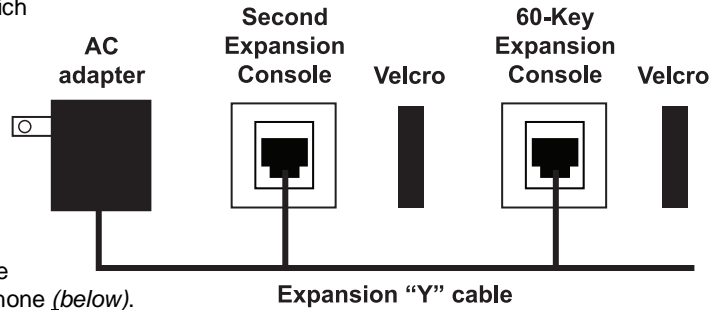


## 60-Key Second Expansion Console connection

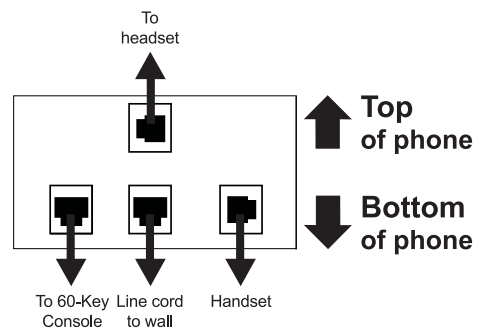
**Notes:** If connecting only one Expansion Console to an ESI phone, see “60-Key Expansion Console connection,” page I.8.

The 60-Key Second Expansion Console connects to the 60-Key Expansion Console and **cannot** connect directly to any ESI phone to which you can connect a 60-Key Expansion Console.

1. The Second Expansion Console (which is physically identical to a 60-Key Expansion Console) includes an **expansion “Y” cable (right)**. Lay out the cable across the back of the equipment so that the AC adapter is on left and the end of the cable is on the right.
2. Connect the **right** end of the expansion “Y” cable to the appropriate connector on the bottom of the ESI phone (*below*).
3. Then, connect the expansion “Y” cable’s **middle** plug to the 60-Key Expansion Console, the **left** plug to the Second Expansion Console, and the **AC adapter** to an appropriate 110 VAC outlet to provide power to the Second Expansion Console (*above*).
4. To keep cabling out of the way, thread the expansion “Y” cable into the slots on the bottom of the phone and the two Expansion Consoles.
5. Program the keys on the two Expansion Consoles using the same procedure as with the ESI phone (press **PROG/HELP 2**).
6. If necessary, remove the clear **plastic** overlay from the keys on the two 60-Key Expansion Consoles.
7. For the customer’s convenience, label the **paper** overlay to show how the keys are programmed (we suggest you use the *ESI System Programmer* PC software application for this).
8. Install the labeled **paper** overlays on the two 60-Key Expansion Consoles.
9. Install the clear **plastic** overlays **over** the paper overlays, to protect them.
10. Use the provided Velcro<sup>®</sup> tape to attach the left side of the 60-Key Expansion Console to the right side of the ESI phone, and the right side of the 60-Key Expansion Console to the left side of the Second Expansion Console).



Connectors on bottom of ESI 60 or ESI 40



Connectors on bottom of 48-Key Feature Phone

<sup>1</sup> This diagram shows the backs of the Expansion Consoles.

## Installing ESI's Cordless Handsets

**Note:** Except where noted, this section applies to both the ESI Cordless Handset II and original ESI Cordless Handset models.

Each ESI Cordless Handset comes with:

- A **charger/cradle** to charge the Handset.
- An **AC adapter** for use with only the charger.
- A **base station** to provide a digital interface between the ESI phone system and ESI Cordless Handset. This base station needs **no AC** power: if the Cordless Handset is **digital**, the base station is **line-powered**; if the Cordless Handset is **IP**, the base station uses **Power over Ethernet (PoE)**.
- **Wall-mount(s)**, a **belt clip**, and a **Quick Reference Guide**.

Each ESI Cordless Handset is keyed to only one base station and takes up one port (digital or IP) on a port card.

### Base station installation

Due to each site's unique characteristics, the range and distance information we'll provide herein is only approximate.

Characteristics that **positively** affect performance:

- The base station should be installed so it has a clear line-of-sight with the Cordless Handset.
- The base station antenna should always be pointed in its uppermost vertical position.

Characteristics that **negatively** affect performance:

- Large amounts of metal shelving (such as in manufacturing or warehouse areas).
- Close proximity to (within one mile of) a radio tower.
- Concrete walls that divide spaces where Cordless Handsets are used (assuming the base stations are in one location).

**Don't** install the base station:

- Close to a wall with metal studs.
- On a metal wall.
- Next to a device that emits RFI or EMI<sup>1</sup> — *e.g.*, a television, radio, computer, computer printer, fluorescent light fixture, or fax machine.
- Next to any other 900 MHz device — *e.g.*, a hand-held inventory control device.
- In a ceiling that has foil-backed insulation.
- Behind doors that typically are closed, tinted windows, one-way glass, or other areas that limit or cut off transmission to the Cordless Handset.

Base stations must be installed at least 10 feet apart, regardless of whether the base station is for the small-model or large-model Cordless Handset. **Don't** install more than six base stations in one area (such as a network room). Choose a location at least 30 feet away if more than six base stations are needed in a building.

(Continued)

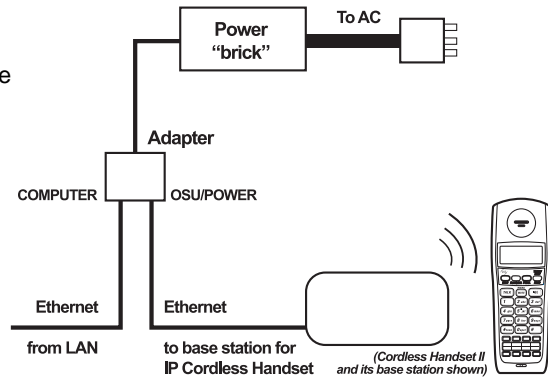
---

<sup>1</sup> RFI is radio frequency interference. EMI is electromagnetic interference.

A **Digital** Cordless Handset base station requires only a line cord to the phone system; AC power **isn't** needed because the base station receives power from the phone system via the line cord.

An **IP** Cordless Handset base station receives PoE. If PoE isn't already being supplied, you'll need to install the separately purchased **PoE adapter** (sold in five-packs as ESI part # 5000-0437). The diagram at *right* shows the necessary connections.

**Note:** If the PoE equipment plugs into AC outlets and a power failure occurs, all IP Cordless Handsets on the system will be unable to originate or receive phone calls. Therefore, **either:** **(a.)** use an appropriately sized uninterruptible power supply (UPS) to power **all** the IP equipment (base station, PoE adapter, router, *etc.*) involved in making phone calls **or** **(b.)** have a traditional POTS ("plain old telephone service") phone available for originating and receiving analog CO calls.



Once the base stations are installed and the Cordless Handsets charged:

- **Cordless Handset II** — The Cordless Handset II will auto-seek an available channel.
- **Original Cordless Handset** — Change each Handset's channel by pressing its **CH** key. **Each Handset should have its own channel.** There are 30 available channels on the small Cordless Handset and 10 on the large Cordless Handset.

**Note:** Feedback may result if the Cordless Handset is within three inches of an ESI desktop phone.

### ESI Cordless Handset II Repeater

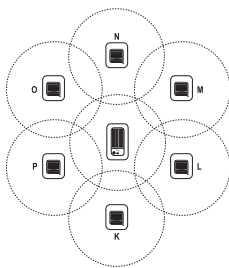
The optional **ESI Cordless Handset II Repeater** extends the coverage area of the ESI Cordless Handset II in all directions, including up and down.

If Repeaters are installed so their coverage area overlaps that of the base station, the base station can hand off calls to the Repeaters as the user moves from one coverage area to another. When it's connected to a Repeater, the ESI Cordless Handset II operates exactly as it does when connected to its base station, and the handoff from the base station to the Repeater occurs seamlessly without disturbing the end user, even during an active call.

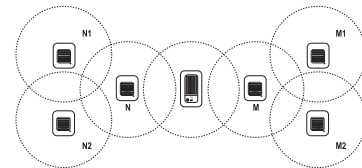
Each ESI Cordless Handset II base station supports up to **six** repeaters, regardless of configuration.

- Each Repeater supports up to two direct connections to other Repeaters.
- No Repeater can be more than three connections — **or hops** — from the base station.

All Repeaters, regardless of configuration, must be registered to the base station.



Repeaters that are registered directly to a base station (*left*), do **not** require use of the optional **Repeater Configurator Kit**. These Repeaters can be installed using automatic configuration. However, Repeaters registered to the base station **through** another Repeater (one example shown, *right*) **do** require use of the Repeater Configurator Kit.



For detailed information on installing Repeaters, refer to the *ESI Cordless Handset II Repeater Installation Manual* (ESI # 0450-1248).

### Repeater installation notes

To achieve optimum operation from your ESI Cordless Handset II Repeater:

- Place the Repeater **at least six feet** off the ground so it has a clear line-of-sight.
- Make sure the Repeater has good reception from the base station (or Repeater to which it is daisy-chained).
- Make sure the Repeater location is close to a standard 120 VAC power outlet.
- Never install electrical cords across traffic areas where they can cause a tripping hazard (additionally, such cords, if damaged, may create fire or electrical hazards).
- Allow **at least 35 feet** between Repeaters.  
If you install Repeaters across multiple floors, be sure to allow **35 feet vertically**, too.
- Install the Repeater away from sources of electrical interference. Examples include audio systems, office equipment, and microwave ovens.
- Install the Repeater away from heat sources and direct sunlight.
- Install the Repeater away from items that can interfere with radio signals. Examples include metal doors, thick walls, niches, and cupboards.

### In case of trouble

If you have followed the guidelines described herein and still encounter problems with ESI Cordless Handsets, please call ESI Technical Support at **800 491-3609** or e-mail to [techsupp@esi-estech.com](mailto:techsupp@esi-estech.com). When contacting ESI Technical Support, be sure to have as much of the following site and usage information as possible:

- Square footage of the building.
- Layout of building/offices, and locations of base stations and repeaters. This can be a hand-drawn diagram with locations of base stations (you can fax it to ESI at **972 422-9705**; be sure to indicate that it goes to Technical Support). The objective is to give the ESI technician an idea of the site's layout.
- Number of Cordless Handsets, whether they are Cordless Handsets II or original Cordless Handsets, and how many are of each type (digital, Local IP, or Remote IP).
- How the troublesome Cordless Handset is being used. For example, is it used by a supervisor who travels the entire area of the building many times per day, or by an administrative assistant to go a short distance from an office to a copy room?
- Where the problem occurs — *e.g.*, if a Cordless Handset cuts in and out when used in a certain area of the building.

### ESI Cordless Handset specifications

	ESI Cordless Handset II	Original ESI Cordless Handsets	
		Small Handset	Large Handset
<b>Fully charged battery time</b>	Approx. 16. hrs.	Approx. 7 hrs.	Approx. 10 hrs.
<b>Recharge time</b>	5–8 hrs. <sup>1</sup>	Approx. 5 hrs.	Approx. 5 hrs.
<b>Standby time</b>	Approx. 7 days	Approx. 5 days	Approx. 4 days
<b>Approximate range<sup>2</sup></b>	Without Repeater: 175 ft. With Repeater: 320 ft.	200 ft.	400 ft.
<b>Weight (including battery)</b>	5.4 ozs.	5.2 oz.	8.8 oz.
<b>Size, W × D × H (in.)</b>	2.25 × 1.25 × 6.5	2 × 1.25 × 5.5 w/o antenna	2.2 × 1.67 × 8.67 w/ antenna

### Accessories

ESI sells separately a headset for both ESI Cordless Handset models, and this is the **only** headset ESI supports for use with the ESI Cordless Handset. For more information on accessories for ESI Cordless Handsets, refer to your appropriate *Price Schedule*, the *ESI Cordless Handset II Product Overview* (ESI # 0450-1228), or the *ESI Cordless Handset Product Overview* (ESI # 0450-0840).

<sup>1</sup> If charged while in the handset. A battery pack placed in the charger's extra-battery compartment requires 15–19 hours to recharge.

<sup>2</sup> Interference may result if cordless base stations are installed within 10 feet of each other. Ranges are approximate, and are dependent on each site's unique characteristics. Feedback may result if the Cordless Handset is within three inches of the ESI desktop phone.

## Port card connections

### *E2-A12 port card • CS-A12 port card*

Term	Wire color	Signal	RJ11	Port
1	White-Blue	Tip	Green	Analog
2	Blue-White	Ring	Red	
3	White-Orange	Tip	Green	Analog
4	Orange-White	Ring	Red	
5	White-Green	Tip	Green	Analog
6	Green-White	Ring	Red	
7	White-Brown	Tip	Green	Analog
8	Brown-White	Ring	Red	
9	White-Slate	Tip	Green	Analog
10	Slate-White	Ring	Red	
11	Red-Blue	Tip	Green	Analog
12	Blue-Red	Ring	Red	
13	Red-Orange	Tip	Green	Analog
14	Orange-Red	Ring	Red	
15	Red-Green	Tip	Green	Analog
16	Green-Red	Ring	Red	
17	Red-Brown	Tip	Green	Analog
18	Brown-Red	Ring	Red	
19	Red-Slate	Tip	Green	Analog
20	Slate-Red	Ring	Red	
21	Black-Blue	Tip	Green	Analog
22	Blue-Black	Ring	Red	
23	Black-Orange	Tip	Green	Analog
24	Orange-Black	Ring	Red	
25	Black-Green			
26	Green-Black			
27	Black-Brown			
28	Brown-Black			
29	Black-Slate			
30	Slate-Black			
31	Yellow-Blue			
32	Blue-Yellow			
33	Yellow-Orange			
34	Orange-Yellow			
35	Yellow-Green			
36	Green-Yellow			
37	Yellow-Brown			
38	Brown-Yellow			
39	Yellow-Slate			
40	Slate-Yellow			
41	Violet-Blue			
42	Blue-Violet			
43	Violet-Orange			
44	Orange-Violet			
45	Violet-Green			
46	Green-Violet			
47	Violet-Brown			
48	Brown-Violet			
49	Violet-Slate			
50	Slate-Violet			

**E2-A4 port card**

Term	Wire color	Signal	RJ11	Port
1	White-Blue	Tip	Green	Analog
2	Blue-White	Ring	Red	
3	White-Orange	Tip	Green	Analog
4	Orange-White	Ring	Red	
5	White-Green	Tip	Green	Analog
6	Green-White	Ring	Red	
7	White-Brown	Tip	Green	Analog
8	Brown-White	Ring	Red	
9	White-Slate			
10	Slate-White			
11	Red-Blue			
12	Blue-Red			
13	Red-Orange			
14	Orange-Red			
15	Red-Green			
16	Green-Red			
17	Red-Brown			
18	Brown-Red			
19	Red-Slate			
20	Slate-Red			
21	Black-Blue			
22	Blue-Black			
23	Black-Orange			
24	Orange-Black			
25	Black-Green			
26	Green-Black			
27	Black-Brown			
28	Brown-Black			
29	Black-Slate			
30	Slate-Black			
31	Yellow-Blue			
32	Blue-Yellow			
33	Yellow-Orange			
34	Orange-Yellow			
35	Yellow-Green			
36	Green-Yellow			
37	Yellow-Brown			
38	Brown-Yellow			
39	Yellow-Slate			
40	Slate-Yellow			
41	Violet-Blue			
42	Blue-Violet			
43	Violet-Orange			
44	Orange-Violet			
45	Violet-Green			
46	Green-Violet			
47	Violet-Brown			
48	Brown-Violet			
49	Violet-Slate			
50	Slate-Violet			

**E2-D12 port card • CS-D12 port card**

Term	Wire color	Signal	RJ11	Port
1	White-Blue	Data+	Green	Digital
2	Blue-White	Data-	Red	
3	White-Orange	Data+	Green	Digital
4	Orange-White	Data-	Red	
5	White-Green	Data+	Green	Digital
6	Green-White	Data-	Red	
7	White-Brown	Data+	Green	Digital
8	Brown-White	Data-	Red	
9	White-Slate	Data+	Green	Digital
10	Slate-White	Data-	Red	
11	Red-Blue	Data+	Green	Digital
12	Blue-Red	Data-	Red	
13	Red-Orange	Data+	Green	Digital
14	Orange-Red	Data-	Red	
15	Red-Green	Data+	Green	Digital
16	Green-Red	Data-	Red	
17	Red-Brown	Data+	Green	Digital
18	Brown-Red	Data-	Red	
19	Red-Slate	Data+	Green	Digital
20	Slate-Red	Data-	Red	
21	Black-Blue	Data+	Green	Digital
22	Blue-Black	Data-	Red	
23	Black-Orange	Data+	Green	Digital
24	Orange-Black	Data-	Red	
25	Black-Green			
26	Green-Black			
27	Black-Brown			
28	Brown-Black			
29	Black-Slate			
30	Slate-Black			
31	Yellow-Blue			
32	Blue-Yellow			
33	Yellow-Orange			
34	Orange-Yellow			
35	Yellow-Green			
36	Green-Yellow			
37	Yellow-Brown			
38	Brown-Yellow			
39	Yellow-Slate			
40	Slate-Yellow			
41	Violet-Blue			
42	Blue-Violet			
43	Violet-Orange			
44	Orange-Violet			
45	Violet-Green			
46	Green-Violet			
47	Violet-Brown			
48	Brown-Violet			
49	Violet-Slate			
50	Slate-Violet			

**E2-612 port card • CS-612 port card**

Term	Wire color	Signal	RJ11	Port
1	White-Blue	Data+	Green	Digital
2	Blue-White	Data-	Red	
3	White-Orange	Data+	Green	Digital
4	Orange-White	Data-	Red	
5	White-Green	Data+	Green	Digital
6	Green-White	Data-	Red	
7	White-Brown	Data+	Green	Digital
8	Brown-White	Data-	Red	
9	White-Slate	Data+	Green	Digital
10	Slate-White	Data-	Red	
11	Red-Blue	Data+	Green	Digital
12	Blue-Red	Data-	Red	
13	Red-Orange	Data+	Green	Digital
14	Orange-Red	Data-	Red	
15	Red-Green	Data+	Green	Digital
16	Green-Red	Data-	Red	
17	Red-Brown	Data+	Green	Digital
18	Brown-Red	Data-	Red	
19	Red-Slate	Data+	Green	Digital
20	Slate-Red	Data-	Red	
21	Black-Blue	Data+	Green	Digital
22	Blue-Black	Data-	Red	
23	Black-Orange	Data+	Green	Digital
24	Orange-Black	Data-	Red	
25	Black-Green			
26	Green-Black			
27	Black-Brown			
28	Brown-Black			
29	Black-Slate			
30	Slate-Black			
31	Yellow-Blue			
32	Blue-Yellow			
33	Yellow-Orange			
34	Orange-Yellow			
35	Yellow-Green			
36	Green-Yellow			
37	Yellow-Brown			
38	Brown-Yellow			
39	Yellow-Slate	Tip	Green	CO
40	Slate-Yellow	Ring	Red	
41	Violet-Blue	Tip	Green	CO
42	Blue-Violet	Ring	Red	
43	Violet-Orange	Tip	Green	CO
44	Orange-Violet	Ring	Red	
45	Violet-Green	Tip	Green	CO
46	Green-Violet	Ring	Red	
47	Violet-Brown	Tip	Green	CO
48	Brown-Violet	Ring	Red	
49	Violet-Slate	Tip	Green	CO
50	Slate-Violet	Ring	Red	



**ESI-6ALC port card • CS-6ALC port card**

Term	Wire color	Signal	RJ11	Port
1	White-Blue			
2	Blue-White			
3	White-Orange			
4	Orange-White			
5	White-Green			
6	Green-White			
7	White-Brown			
8	Brown-White			
9	White-Slate			
10	Slate-White			
11	Red-Blue			
12	Blue-Red			
13	Red-Orange			
14	Orange-Red			
15	Red-Green			
16	Green-Red			
17	Red-Brown			
18	Brown-Red			
19	Red-Slate			
20	Slate-Red			
21	Black-Blue			
22	Blue-Black			
23	Black-Orange			
24	Orange-Black			
25	Black-Green			
26	Green-Black			
27	Black-Brown			
28	Brown-Black			
29	Black-Slate			
30	Slate-Black			
31	Yellow-Blue			
32	Blue-Yellow			
33	Yellow-Orange			
34	Orange-Yellow			
35	Yellow-Green			
36	Green-Yellow			
37	Yellow-Brown			
38	Brown-Yellow			
39	Yellow-Slate	Tip	Green	CO
40	Slate-Yellow	Ring	Red	
41	Violet-Blue	Tip	Green	CO
42	Blue-Violet	Ring	Red	
43	Violet-Orange	Tip	Green	CO
44	Orange-Violet	Ring	Red	
45	Violet-Green	Tip	Green	CO
46	Green-Violet	Ring	Red	
47	Violet-Brown	Tip	Green	CO
48	Brown-Violet	Ring	Red	
49	Violet-Slate	Tip	Green	CO
50	Slate-Violet	Ring	Red	

**E2-684 port card • CS-684 port card**

Term	Wire color	Signal	RJ11	Port
1	White-Blue	Data+	Green	Digital
2	Blue-White	Data-	Red	
3	White-Orange	Data+	Green	Digital
4	Orange-White	Data-	Red	
5	White-Green	Data+	Green	Digital
6	Green-White	Data-	Red	
7	White-Brown	Data+	Green	Digital
8	Brown-White	Data-	Red	
9	White-Slate	Data+	Green	Digital
10	Slate-White	Data-	Red	
11	Red-Blue	Data+	Green	Digital
12	Blue-Red	Data-	Red	
13	Red-Orange	Data+	Green	Digital
14	Orange-Red	Data-	Red	
15	Red-Green	Data+	Green	Digital
16	Green-Red	Data-	Red	
17	Red-Brown	Tip	Green	Analog
18	Brown-Red	Ring	Red	
19	Red-Slate	Tip	Green	Analog
20	Slate-Red	Ring	Red	
21	Black-Blue	Tip	Green	Analog
22	Blue-Black	Ring	Red	
23	Black-Orange	Tip	Green	Analog
24	Orange-Black	Ring	Red	
25	Black-Green			
26	Green-Black			
27	Black-Brown			
28	Brown-Black			
29	Black-Slate			
30	Slate-Black			
31	Yellow-Blue			
32	Blue-Yellow			
33	Yellow-Orange			
34	Orange-Yellow			
35	Yellow-Green			
36	Green-Yellow			
37	Yellow-Brown			
38	Brown-Yellow			
39	Yellow-Slate	Tip	Green	CO
40	Slate-Yellow	Ring	Red	
41	Violet-Blue	Tip	Green	CO
42	Blue-Violet	Ring	Red	
43	Violet-Orange	Tip	Green	CO
44	Orange-Violet	Ring	Red	
45	Violet-Green	Tip	Green	CO
46	Green-Violet	Ring	Red	
47	Violet-Brown	Tip	Green	CO
48	Brown-Violet	Ring	Red	
49	Violet-Slate	Tip	Green	CO
50	Slate-Violet	Ring	Red	

**E2-DLC12 port card • CS-DLC12 port card**

(to 66 Block)

Term	Wire color	Signal	RJ11	Port
1	White-Blue	Data+	Green	Digital
2	Blue-White	Data-	Red	
3	White-Orange	Data+	Green	Digital
4	Orange-White	Data-	Red	
5	White-Green	Data+	Green	Digital
6	Green-White	Data-	Red	
7	White-Brown	Data+	Green	Digital
8	Brown-White	Data-	Red	
9	White-Slate	Data+	Green	Digital
10	Slate-White	Data-	Red	
11	Red-Blue	Data+	Green	Digital
12	Blue-Red	Data-	Red	
13	Red-Orange	Data+	Green	Digital
14	Orange-Red	Data-	Red	
15	Red-Green	Data+	Green	Digital
16	Green-Red	Data-	Red	
17	Red-Brown	Data+	Green	Digital
18	Brown-Red	Data-	Red	
19	Red-Slate	Data+	Green	Digital
20	Slate-Red	Data-	Red	
21	Black-Blue	Data+	Green	Digital
22	Blue-Black	Data-	Red	
23	Black-Orange	Data+	Green	Digital
24	Orange-Black	Data-	Red	
25	Black-Green			
26	Green-Black			
27	Black-Brown			
28	Brown-Black			
29	Black-Slate			
30	Slate-Black			
31	Yellow-Blue			
32	Blue-Yellow			
33	Yellow-Orange			
34	Orange-Yellow			
35	Yellow-Green			
36	Green-Yellow			
37	Yellow-Brown			
38	Brown-Yellow			
39	Yellow-Slate			
40	Slate-Yellow			
41	Violet-Blue			
42	Blue-Violet			
43	Violet-Orange			
44	Orange-Violet			
45	Violet-Green			
46	Green-Violet	<b>Signal</b>	<b>Cable pair<sup>1</sup></b>	<b>RJ48 pinout</b>
47	Violet-Brown	Transmit T	White-Orange	1
48	Brown-Violet	Transmit R	Orange-White	2
49	Violet-Slate	Receive T	White-Blue	5
50	Slate-Violet	Receive R	Blue-White	4

<sup>1</sup> RJ48 labeled as EIA/TIA 568B (AT&T 258A). If RJ48 is labeled as EIA/TIA 568A, connect the violet-brown pair to the white-green pair at the jack.

**ESI-DLC port card • CS-DLC port card**

(to 66 Block)

Term	Wire color			
1	White-Blue			
2	Blue-White			
3	White-Orange			
4	Orange-White			
5	White-Green			
6	Green-White			
7	White-Brown			
8	Brown-White			
9	White-Slate			
10	Slate-White			
11	Red-Blue			
12	Blue-Red			
13	Red-Orange			
14	Orange-Red			
15	Red-Green			
16	Green-Red			
17	Red-Brown			
18	Brown-Red			
19	Red-Slate			
20	Slate-Red			
21	Black-Blue			
22	Blue-Black			
23	Black-Orange			
24	Orange-Black			
25	Black-Green			
26	Green-Black			
27	Black-Brown			
28	Brown-Black			
29	Black-Slate			
30	Slate-Black			
31	Yellow-Blue			
32	Blue-Yellow			
33	Yellow-Orange			
34	Orange-Yellow			
35	Yellow-Green			
36	Green-Yellow			
37	Yellow-Brown			
38	Brown-Yellow			
39	Yellow-Slate			
40	Slate-Yellow			
41	Violet-Blue			
42	Blue-Violet			
43	Violet-Orange			
44	Orange-Violet			
45	Violet-Green			
46	Green-Violet			
		Signal	Cable pair <sup>1</sup>	RJ48 pinout
47	Violet-Brown	Transmit T	White-Orange	1
48	Brown-Violet	Transmit R	Orange-White	2
49	Violet-Slate	Receive T	White-Blue	5
50	Slate-Violet	Receive R	Blue-White	4

<sup>1</sup> RJ48 labeled as EIA/TIA 568B (AT&T 258A). If RJ48 is labeled as EIA/TIA 568A, connect the violet-brown pair to the white-green pair at the jack.

**SL-DLC82 port card (for use ONLY in slot 2 on ESI-50)**

(to 66 Block)

Term	Wire color	Signal	RJ11	Port	
1	White-Blue	Data+	Green	Digital	
2	Blue-White	Data-	Red		
3	White-Orange	Data+	Green	Digital	
4	Orange-White	Data-	Red		
5	White-Green	Data+	Green	Digital	
6	Green-White	Data-	Red		
7	White-Brown	Data+	Green	Digital	
8	Brown-White	Data-	Red		
9	White-Slate	Data+	Green	Digital	
10	Slate-White	Data-	Red		
11	Red-Blue	Data+	Green	Digital	
12	Blue-Red	Data-	Red		
13	Red-Orange	Data+	Green	Digital	
14	Orange-Red	Data-	Red		
15	Red-Green	Data+	Green	Digital	
16	Green-Red	Data-	Red		
17	Red-Brown				
18	Brown-Red				
19	Red-Slate				
20	Slate-Red				
21	Black-Blue				
22	Blue-Black				
23	Black-Orange				
24	Orange-Black				
25	Black-Green	Data+	Green		Analog
26	Green-Black	Data-	Red		
27	Black-Brown	Data+	Green	Analog	
28	Brown-Black	Data-	Red		
29	Black-Slate				
30	Slate-Black				
31	Yellow-Blue				
32	Blue-Yellow				
33	Yellow-Orange				
34	Orange-Yellow				
35	Yellow-Green				
36	Green-Yellow				
37	Yellow-Brown				
38	Brown-Yellow				
39	Yellow-Slate				
40	Slate-Yellow				
41	Violet-Blue				
42	Blue-Violet				
43	Violet-Orange				
44	Orange-Violet				
45	Violet-Green				
46	Green-Violet	<b>Signal</b>	<b>Cable pair<sup>1</sup></b>	<b>RJ48 pinout</b>	
47	Violet-Brown	Transmit T	White-Orange	1	
48	Brown-Violet	Transmit R	Orange-White	2	
49	Violet-Slate	Receive T	White-Blue	5	
50	Slate-Violet	Receive R	Blue-White	4	

<sup>1</sup> RJ48 labeled as EIA/TIA 568B (AT&T 258A). If RJ48 is labeled as EIA/TIA 568A, connect the violet-brown pair to the white-green pair at the jack.

**482 port card (for use ONLY on ESI-50)**

Term	Wire color	Signal	RJ11	Port
1	White-Blue	Data+	Green	Digital
2	Blue-White	Data-	Red	
3	White-Orange	Data+	Green	Digital
4	Orange-White	Data-	Red	
5	White-Green	Data+	Green	Digital
6	Green-White	Data-	Red	
7	White-Brown	Data+	Green	Digital
8	Brown-White	Data-	Red	
9	White-Slate	Data+	Green	Digital
10	Slate-White	Data-	Red	
11	Red-Blue	Data+	Green	Digital
12	Blue-Red	Data-	Red	
13	Red-Orange	Data+	Green	Digital
14	Orange-Red	Data-	Red	
15	Red-Green	Data+	Green	Digital
16	Green-Red	Data-	Red	
17	Red-Brown			
18	Brown-Red			
19	Red-Slate			
20	Slate-Red			
21	Black-Blue			
22	Blue-Black			
23	Black-Orange			
24	Orange-Black			
25	Black-Green	Tip	Green	Analog
26	Green-Black	Ring	Red	
27	Black-Brown	Tip	Green	Analog
28	Brown-Black	Ring	Red	
29	Black-Slate			
30	Slate-Black			
31	Yellow-Blue			
32	Blue-Yellow			
33	Yellow-Orange			
34	Orange-Yellow			
35	Yellow-Green			
36	Green-Yellow			
37	Yellow-Brown			
38	Brown-Yellow			
39	Yellow-Slate	Tip	Green	CO
40	Slate-Yellow	Ring	Red	
41	Violet-Blue	Tip	Green	CO
42	Blue-Violet	Ring	Red	
43	Violet-Orange	Tip	Green	CO
44	Orange-Violet	Ring	Red	
45	Violet-Green	Tip	Green	CO
46	Green-Violet	Ring	Red	
47	Violet-Brown			
48	Brown-Violet			
49	Violet-Slate			
50	Slate-Violet			

## Cabinet worksheets

### ESI-50 • Base and Expansion Cabinets

Term.	Wire color	Signal	RJ11	Base Cabinet		Expansion Cabinet	
				Pt. Crd. 1	Pt. Crd. 2	Pt. Crd. 3	Pt. Crd. 4
			Card type →	[Main board]	482/DLC82 <sup>1</sup>	482	482
1	White-Blue	Data+	Green	Dig/Ana	Dig/Ana	Dig/Ana	Dig/Ana
2	Blue-White	Data-	Red	100	110	120	130
3	White-Orange	Data+	Green	Dig/Ana	Dig/Ana	Dig/Ana	Dig/Ana
4	Orange-White	Data-	Red	101	111	121	131
5	White-Green	Data+	Green	Dig/Ana	Dig/Ana	Dig/Ana	Dig/Ana
6	Green-White	Data-	Red	102	112	122	132
7	White-Brown	Data+	Green	Dig/Ana	Dig/Ana	Dig/Ana	Dig/Ana
8	Brown-White	Data-	Red	103	113	123	133
9	White-Slate	Data+	Green	Dig/Ana	Dig/Ana	Dig/Ana	Dig/Ana
10	Slate-White	Data-	Red	104	114	124	134
11	Red-Blue	Data+	Green	Dig/Ana	Dig/Ana	Dig/Ana	Dig/Ana
12	Blue-Red	Data-	Red	105	115	125	135
13	Red-Orange	Data+	Green	Dig/Ana	Dig/Ana	Dig/Ana	Dig/Ana
14	Orange-Red	Data-	Red	106	116	126	136
15	Red-Green	Data+	Green	Dig/Ana	Dig/Ana	Dig/Ana	Dig/Ana
16	Green-Red	Data-	Red	107	117	127	137
17	Red-Brown						
18	Brown-Red						
19	Red-Slate						
20	Slate-Red						
21	Black-Blue						
22	Blue-Black						
23	Black-Orange						
24	Orange-Black						
25	Black-Green	Data+/Tip	Green	Ana	Ana	Ana	Ana
26	Green-Black	Data-/Ring	Red	108	118	128	138
27	Black-Brown	Data+/Tip	Green	Ana	Ana	Ana	Ana
28	Brown-Black	Data-/Ring	Red	109	119	129	139
29	Black-Slate						
30	Slate-Black						
31	Yellow-Blue						
32	Blue-Yellow						
33	Yellow-Orange						
34	Orange-Yellow						
35	Yellow-Green						
36	Green-Yellow						
37	Yellow-Brown						
38	Brown-Yellow						
39	Yellow-Slate	Tip	Green	CO <sup>*</sup>	CO <sup>*</sup>	CO <sup>*</sup>	CO <sup>*</sup>
40	Slate-Yellow	Ring	Red				
41	Violet-Blue	Tip	Green	CO <sup>*</sup>	CO <sup>*</sup>	CO <sup>*</sup>	CO <sup>*</sup>
42	Blue-Violet	Ring	Red				
43	Violet-Orange	Tip	Green	CO <sup>*</sup>	CO <sup>*</sup>	CO <sup>*</sup>	CO <sup>*</sup>
44	Orange-Violet	Ring	Red				
45	Violet-Green	Tip	Green	CO <sup>*</sup>	CO <sup>*</sup>	CO <sup>*</sup>	CO <sup>*</sup>
46	Green-Violet	Ring	Red				
47	Violet-Brown	Tip	Green		CO*/PRI <sup>1</sup> TX		
48	Brown-Violet	Ring	Red				
49	Violet-Slate	Tip	Green		CO*/PRI <sup>1</sup> RX		
50	Slate-Violet	Ring	Red				

**Note:** Extension numbers shown are valid **only** if "100" flexible numbering template is in use.

<sup>1</sup> DLC82 can be installed in **only** slot 2.  
CO lines' numerical designations vary, depending on whether there is a DLC installed.

**ESI-100 • Base and Expansion Cabinets**

Term.	Wire color	Signal	RJ11	Base Cabinet		Expansion Cabinet(s)			Slot 6 (Unused)
				Pt. Crd. 1	Pt. Crd. 2	Pt. Crd. 3	Pt. Crd. 4	Pt. Crd. 5	
<b>Card type →</b>									
1	White-Blue	Data+	Green	Dig/Ana	Dig/Ana	Dig/Ana	Dig/Ana	(For CS-ASC only)	
2	Blue-White	Data-	Red	100	112	124	136		
3	White-Orange	Data+	Green	Dig/Ana	Dig/Ana	Dig/Ana	Dig/Ana		
4	Orange-White	Data-	Red	101	113	125	137		
5	White-Green	Data+	Green	Dig/Ana	Dig/Ana	Dig/Ana	Dig/Ana		
6	Green-White	Data-	Red	102	114	126	138		
7	White-Brown	Data+	Green	Dig/Ana	Dig/Ana	Dig/Ana	Dig/Ana		
8	Brown-White	Data-	Red	103	115	127	139		
9	White-Slate	Data+	Green	Dig/Ana	Dig/Ana	Dig/Ana	Dig/Ana		
10	Slate-White	Data-	Red	104	116	128	140		
11	Red-Blue	Data+	Green	Dig/Ana	Dig/Ana	Dig/Ana	Dig/Ana		
12	Blue-Red	Data-	Red	105	117	129	141		
13	Red-Orange	Data+	Green	Dig/Ana	Dig/Ana	Dig/Ana	Dig/Ana		
14	Orange-Red	Data-	Red	106	118	130	142		
15	Red-Green	Data+	Green	Dig/Ana	Dig/Ana	Dig/Ana	Dig/Ana		
16	Green-Red	Data-	Red	107	119	131	143		
17	Red-Brown	Data+/Tip	Green	Dig/Ana	Dig/Ana	Dig/Ana	Dig/Ana		
18	Brown-Red	Data-/Ring	Red	108	120	132	144		
19	Red-Slate	Data+/Tip	Green	Dig/Ana	Dig/Ana	Dig/Ana	Dig/Ana		
20	Slate-Red	Data-/Ring	Red	109	121	133	145		
21	Black-Blue	Data+/Tip	Green	Dig/Ana	Dig/Ana	Dig/Ana	Dig/Ana		
22	Blue-Black	Data-/Ring	Red	110	122	134	146		
23	Black-Orange	Data+/Tip	Green	Dig/Ana	Dig/Ana	Dig/Ana	Dig/Ana		
24	Orange-Black	Data-/Ring	Red	111	123	135	147		
25	Black-Green								
26	Green-Black								
27	Black-Brown								
28	Brown-Black								
29	Black-Slate								
30	Slate-Black								
31	Yellow-Blue								
32	Blue-Yellow								
33	Yellow-Orange	OH Page Audio A						Paging controls on second port card are active <b>only</b> if IVC is installed in slot 1.	
34	Orange-Yellow	OH Page Audio B							
35	Yellow-Green	OH Page Relay Normally Open							
36	Green-Yellow	Relay Common							
37	Yellow-Brown								
38	Brown-Yellow	Relay Normally Closed							
39	Yellow-Slate	Tip	Green	CO*	CO*	CO*	CO*		
40	Slate-Yellow	Ring	Red						
41	Violet-Blue	Tip	Green	CO*	CO*	CO*	CO*		
42	Blue-Violet	Ring	Red						
43	Violet-Orange	Tip	Green	CO*	CO*	CO*	CO*		
44	Orange-Violet	Ring	Red						
45	Violet-Green	Tip	Green	CO*	CO*	CO*	CO*		
46	Green-Violet	Ring	Red						
47	Violet-Brown	Tip	Green	CO*/T1/PRI	CO*/T1/PRI	CO*/T1/PRI	CO*/T1/PRI		
48	Brown-Violet	Ring	Red	TX	TX	TX	TX		
49	Violet-Slate	Tip	Green	CO*/T1/PRI	CO*/T1/PRI	CO*/T1/PRI	CO*/T1/PRI		
50	Slate-Violet	Ring	Red	RX	RX	RX	RX		

**Note:** Extension numbers shown are valid **only** if "100" flexible numbering template is in use.

\* CO lines' numerical designations vary, depending on whether there is a DLC installed.



**ESI-200 • Base Cabinet**

Term.	Wire color	Signal	RJ11	Pt. Crd. 1	Pt. Crd. 2	Pt. Crd. 3	Pt. Crd. 4	Pt. Crd. 5	Pt. Crd. 6	Pt. Crd. 7			
Card type →													
1	White-Blue	Data+	Green	Dig/Ana 100	Dig/Ana 112	Dig/Ana 124	Dig/Ana 136	Dig/Ana 148	Dig/Ana 160	Dig/Ana 172			
2	Blue-White	Data-	Red										
3	White-Orange	Data+	Green	Dig/Ana 101	Dig/Ana 113	Dig/Ana 125	Dig/Ana 137	Dig/Ana 149	Dig/Ana 161	Dig/Ana 173			
4	Orange-White	Data-	Red										
5	White-Green	Data+	Green	Dig/Ana 102	Dig/Ana 114	Dig/Ana 126	Dig/Ana 138	Dig/Ana 150	Dig/Ana 162	Dig/Ana 174			
6	Green-White	Data-	Red										
7	White-Brown	Data+	Green	Dig/Ana 103	Dig/Ana 115	Dig/Ana 127	Dig/Ana 139	Dig/Ana 151	Dig/Ana 163	Dig/Ana 175			
8	Brown-White	Data-	Red										
9	White-Slate	Data+	Green	Dig/Ana 104	Dig/Ana 116	Dig/Ana 128	Dig/Ana 140	Dig/Ana 152	Dig/Ana 164	Dig/Ana 176			
10	Slate-White	Data-	Red										
11	Red-Blue	Data+	Green	Dig/Ana 105	Dig/Ana 117	Dig/Ana 129	Dig/Ana 141	Dig/Ana 153	Dig/Ana 165	Dig/Ana 177			
12	Blue-Red	Data-	Red										
13	Red-Orange	Data+	Green	Dig/Ana 106	Dig/Ana 118	Dig/Ana 130	Dig/Ana 142	Dig/Ana 154	Dig/Ana 166	Dig/Ana 178			
14	Orange-Red	Data-	Red										
15	Red-Green	Data+	Green	Dig/Ana 107	Dig/Ana 119	Dig/Ana 131	Dig/Ana 143	Dig/Ana 155	Dig/Ana 167	Dig/Ana 179			
16	Green-Red	Data-	Red										
17	Red-Brown	Data+/Tip	Green	Dig/Ana 108	Dig/Ana 120	Dig/Ana 132	Dig/Ana 144	Dig/Ana 156	Dig/Ana 168	Dig/Ana 180			
18	Brown-Red	Data-/Ring	Red										
19	Red-Slate	Data+/Tip	Green	Dig/Ana 109	Dig/Ana 121	Dig/Ana 133	Dig/Ana 145	Dig/Ana 157	Dig/Ana 169	Dig/Ana 181			
20	Slate-Red	Data-/Ring	Red										
21	Black-Blue	Data+/Tip	Green	Dig/Ana 110	Dig/Ana 122	Dig/Ana 134	Dig/Ana 146	Dig/Ana 158	Dig/Ana 170	Dig/Ana 182			
22	Blue-Black	Data-/Ring	Red										
23	Black-Orange	Data+/Tip	Green	Dig/Ana 111	Dig/Ana 123	Dig/Ana 135	Dig/Ana 147	Dig/Ana 159	Dig/Ana 171	Dig/Ana 183			
24	Orange-Black	Data-/Ring	Red										
25	Black-Green	Paging controls on second port card are active <b>only</b> if IVC is installed in slot 1.											
26	Green-Black												
27	Black-Brown												
28	Brown-Black												
29	Black-Slate												
30	Slate-Black												
31	Yellow-Blue												
32	Blue-Yellow												
33	Yellow-Orange										OH Page Audio A		
34	Orange-Yellow										OH Page Audio B		
35	Yellow-Green	OH Page Relay Normally Open											
36	Green-Yellow	Relay Common											
37	Yellow-Brown	Relay Normally Closed											
38	Brown-Yellow												
39	Yellow-Slate	Tip	Green	CO*	CO*	CO*	CO*	CO*	CO*	CO*			
40	Slate-Yellow	Ring	Red										
41	Violet-Blue	Tip	Green	CO*	CO*	CO*	CO*	CO*	CO*	CO*			
42	Blue-Violet	Ring	Red										
43	Violet-Orange	Tip	Green	CO*	CO*	CO*	CO*	CO*	CO*	CO*			
44	Orange-Violet	Ring	Red										
45	Violet-Green	Tip	Green	CO*	CO*	CO*	CO*	CO*	CO*	CO*			
46	Green-Violet	Ring	Red										
47	Violet-Brown	Tip	Green	CO*/T1/PRI TX	CO*/T1/PRI TX	CO*/T1/PRI TX	CO*/T1/PRI TX	CO*/T1/PRI TX	CO*/T1/PRI TX	CO*/T1/PRI TX			
48	Brown-Violet	Ring	Red										
49	Violet-Slate	Tip	Green	CO*/T1/PRI RX	CO*/T1/PRI RX	CO*/T1/PRI RX	CO*/T1/PRI RX	CO*/T1/PRI RX	CO*/T1/PRI RX	CO*/T1/PRI RX			
50	Slate-Violet	Ring	Red										

**Note:** Extension numbers shown are valid **only** if "100" flexible numbering template is in use.

\* CO lines' numerical designations vary, depending on whether there is a DLC installed.

**ESI-1000, ESI-600 • Base Cabinet**

Term.	Wire color	Signal	RJ11	Pt. Crd. 1	Pt. Crd. 2	Pt. Crd. 3	Pt. Crd. 4	Pt. Crd. 5	Pt. Crd. 6	Pt. Crd. 7
Card type →										
1	White-Blue	Data+	Green	Dig/Ana	Dig/Ana	Dig/Ana	Dig/Ana	Dig/Ana	Dig/Ana	Dig/Ana
2	Blue-White	Data-	Red	100	112	124	136	148	160	172
3	White-Orange	Data+	Green	Dig/Ana	Dig/Ana	Dig/Ana	Dig/Ana	Dig/Ana	Dig/Ana	Dig/Ana
4	Orange-White	Data-	Red	101	113	125	137	149	161	173
5	White-Green	Data+	Green	Dig/Ana	Dig/Ana	Dig/Ana	Dig/Ana	Dig/Ana	Dig/Ana	Dig/Ana
6	Green-White	Data-	Red	102	114	126	138	150	162	174
7	White-Brown	Data+	Green	Dig/Ana	Dig/Ana	Dig/Ana	Dig/Ana	Dig/Ana	Dig/Ana	Dig/Ana
8	Brown-White	Data-	Red	103	115	127	139	151	163	175
9	White-Slate	Data+	Green	Dig/Ana	Dig/Ana	Dig/Ana	Dig/Ana	Dig/Ana	Dig/Ana	Dig/Ana
10	Slate-White	Data-	Red	104	116	128	140	152	164	176
11	Red-Blue	Data+	Green	Dig/Ana	Dig/Ana	Dig/Ana	Dig/Ana	Dig/Ana	Dig/Ana	Dig/Ana
12	Blue-Red	Data-	Red	105	117	129	141	153	165	177
13	Red-Orange	Data+	Green	Dig/Ana	Dig/Ana	Dig/Ana	Dig/Ana	Dig/Ana	Dig/Ana	Dig/Ana
14	Orange-Red	Data-	Red	106	118	130	142	154	166	178
15	Red-Green	Data+	Green	Dig/Ana	Dig/Ana	Dig/Ana	Dig/Ana	Dig/Ana	Dig/Ana	Dig/Ana
16	Green-Red	Data-	Red	107	119	131	143	155	167	179
17	Red-Brown	Data+/Tip	Green	Dig/Ana	Dig/Ana	Dig/Ana	Dig/Ana	Dig/Ana	Dig/Ana	Dig/Ana
18	Brown-Red	Data-/Ring	Red	108	120	132	144	156	168	180
19	Red-Slate	Data+/Tip	Green	Dig/Ana	Dig/Ana	Dig/Ana	Dig/Ana	Dig/Ana	Dig/Ana	Dig/Ana
20	Slate-Red	Data-/Ring	Red	109	121	133	145	157	169	181
21	Black-Blue	Data+/Tip	Green	Dig/Ana	Dig/Ana	Dig/Ana	Dig/Ana	Dig/Ana	Dig/Ana	Dig/Ana
22	Blue-Black	Data-/Ring	Red	110	122	134	146	158	170	182
23	Black-Orange	Data+/Tip	Green	Dig/Ana	Dig/Ana	Dig/Ana	Dig/Ana	Dig/Ana	Dig/Ana	Dig/Ana
24	Orange-Black	Data-/Ring	Red	111	123	135	147	159	171	183
25	Black-Green									
26	Green-Black									
27	Black-Brown									
28	Brown-Black									
29	Black-Slate									
30	Slate-Black									
31	Yellow-Blue									
32	Blue-Yellow									
33	Yellow-Orange									
34	Orange-Yellow									
35	Yellow-Green									
36	Green-Yellow									
37	Yellow-Brown									
38	Brown-Yellow									
39	Yellow-Slate	Tip	Green	CO*	CO*	CO*	CO*	CO*	CO*	CO*
40	Slate-Yellow	Ring	Red							
41	Violet-Blue	Tip	Green	CO*	CO*	CO*	CO*	CO*	CO*	CO*
42	Blue-Violet	Ring	Red							
43	Violet-Orange	Tip	Green	CO*	CO*	CO*	CO*	CO*	CO*	CO*
44	Orange-Violet	Ring	Red							
45	Violet-Green	Tip	Green	CO*	CO*	CO*	CO*	CO*	CO*	CO*
46	Green-Violet	Ring	Red							
47	Violet-Brown	Tip	Green	CO*/T1/PRI	CO*/T1/PRI	CO*/T1/PRI	CO*/T1/PRI	CO*/T1/PRI	CO*/T1/PRI	CO*/T1/PRI
48	Brown-Violet	Ring	Red	TX	TX	TX	TX	TX	TX	TX
49	Violet-Slate	Tip	Green	CO*/T1/PRI	CO*/T1/PRI	CO*/T1/PRI	CO*/T1/PRI	CO*/T1/PRI	CO*/T1/PRI	CO*/T1/PRI
50	Slate-Violet	Ring	Red	RX	RX	RX	RX	RX	RX	RX

**Note:** Extension numbers shown are valid **only** if "100" flexible numbering template is in use.

\* CO lines' numerical designations vary, depending on whether there is a DLC installed.

**ESI-1000, ESI-600, ESI-200 • Expansion Cabinet**

Term.	Wire color	Signal	RJ11	Pt. Crd. 1	Pt. Crd. 2	Pt. Crd. 3	Pt. Crd. 4	Pt. Crd. 5	Pt. Crd. 6	Pt. Crd. 7
<b>Card type →</b>										
1	White-Blue	Data+	Green	Dig/Ana	Dig/Ana	Dig/Ana	Dig/Ana	Dig/Ana	Dig/Ana	Dig/Ana
2	Blue-White	Data-	Red	184	196	208	220	232	244	256
3	White-Orange	Data+	Green	Dig/Ana	Dig/Ana	Dig/Ana	Dig/Ana	Dig/Ana	Dig/Ana	Dig/Ana
4	Orange-White	Data-	Red	185	197	209	221	233	245	257
5	White-Green	Data+	Green	Dig/Ana	Dig/Ana	Dig/Ana	Dig/Ana	Dig/Ana	Dig/Ana	Dig/Ana
6	Green-White	Data-	Red	186	198	210	222	234	246	258
7	White-Brown	Data+	Green	Dig/Ana	Dig/Ana	Dig/Ana	Dig/Ana	Dig/Ana	Dig/Ana	Dig/Ana
8	Brown-White	Data-	Red	187	199	211	223	235	247	259
9	White-Slate	Data+	Green	Dig/Ana	Dig/Ana	Dig/Ana	Dig/Ana	Dig/Ana	Dig/Ana	Dig/Ana
10	Slate-White	Data-	Red	188	200	212	224	236	248	260
11	Red-Blue	Data+	Green	Dig/Ana	Dig/Ana	Dig/Ana	Dig/Ana	Dig/Ana	Dig/Ana	Dig/Ana
12	Blue-Red	Data-	Red	189	201	213	225	237	249	261
13	Red-Orange	Data+	Green	Dig/Ana	Dig/Ana	Dig/Ana	Dig/Ana	Dig/Ana	Dig/Ana	Dig/Ana
14	Orange-Red	Data-	Red	190	202	214	226	238	250	262
15	Red-Green	Data+	Green	Dig/Ana	Dig/Ana	Dig/Ana	Dig/Ana	Dig/Ana	Dig/Ana	Dig/Ana
16	Green-Red	Data-	Red	191	203	215	227	239	251	263
17	Red-Brown	Data+/Tip	Green	Dig/Ana	Dig/Ana	Dig/Ana	Dig/Ana	Dig/Ana	Dig/Ana	Dig/Ana
18	Brown-Red	Data-/Ring	Red	192	204	216	228	240	252	264
19	Red-Slate	Data+/Tip	Green	Dig/Ana	Dig/Ana	Dig/Ana	Dig/Ana	Dig/Ana	Dig/Ana	Dig/Ana
20	Slate-Red	Data-/Ring	Red	193	205	217	229	241	253	265
21	Black-Blue	Data+/Tip	Green	Dig/Ana	Dig/Ana	Dig/Ana	Dig/Ana	Dig/Ana	Dig/Ana	Dig/Ana
22	Blue-Black	Data-/Ring	Red	194	206	218	230	242	254	266
23	Black-Orange	Data+/Tip	Green	Dig/Ana	Dig/Ana	Dig/Ana	Dig/Ana	Dig/Ana	Dig/Ana	Dig/Ana
24	Orange-Black	Data-/Ring	Red	195	207	219	231	243	255	267
25	Black-Green									
26	Green-Black									
27	Black-Brown									
28	Brown-Black									
29	Black-Slate									
30	Slate-Black									
31	Yellow-Blue									
32	Blue-Yellow									
33	Yellow-Orange									
34	Orange-Yellow									
35	Yellow-Green									
36	Green-Yellow									
37	Yellow-Brown									
38	Brown-Yellow									
39	Yellow-Slate	Tip	Green	CO*	CO*	CO*	CO*	CO*	CO*	CO*
40	Slate-Yellow	Ring	Red							
41	Violet-Blue	Tip	Green	CO*	CO*	CO*	CO*	CO*	CO*	CO*
42	Blue-Violet	Ring	Red							
43	Violet-Orange	Tip	Green	CO*	CO*	CO*	CO*	CO*	CO*	CO*
44	Orange-Violet	Ring	Red							
45	Violet-Green	Tip	Green	CO*	CO*	CO*	CO*	CO*	CO*	CO*
46	Green-Violet	Ring	Red							
47	Violet-Brown	Tip	Green	CO*/T1/PRI TX	CO*/T1/PRI TX	CO*/T1/PRI TX	CO*/T1/PRI TX	CO*/T1/PRI TX	CO*/T1/PRI TX	CO*/T1/PRI TX
48	Brown-Violet	Ring	Red							
49	Violet-Slate	Tip	Green	CO*/T1/PRI RX	CO*/T1/PRI RX	CO*/T1/PRI RX	CO*/T1/PRI RX	CO*/T1/PRI RX	CO*/T1/PRI RX	CO*/T1/PRI RX
50	Slate-Violet	Ring	Red							

**Note:** Extension numbers shown are valid **only** if "100" flexible numbering template is in use.

\* CO lines' numerical designations vary, depending on whether there is a DLC installed.

# Ordering and installing PRI circuits

This section addresses considerations to make when ordering and installing ISDN PRI circuits on PRI-ready ESI Communications Servers [except ESI-50L].

When ordering and provisioning such circuits, you must correctly define certain parameters in order for the PRI to function correctly. This section is a template for a PRI order form you can use to order PRI circuits that — if provisioned according to the order form — will be fully compatible with PRI-ready ESI systems.

## PRI configuration description

- **Agent company** — Name of the company that’s ordering the PRI on behalf of the customer.
- **Contact** — The individual who’s placing the PRI order.
- **Address** — Address of the agent company.
- **Customer name** — The name of the end user’s company.
- **Circuit ID** — The circuit number (or sequence of characters and numbers) that the service provider uses to identify the PRI circuit. This is used to identify the PRI circuit when troubleshooting or reporting trouble.
- **Support phone number** — The service provider’s customer service phone number.
- **PRI line protocol** — The ISDN protocol offered by the service provider. ESI strongly recommends using the **NI-2** (*National ISDN-2*) protocol.
- **Framing and line encoding** — You **must** use **ESF** (*extended super frame*) framing and **B8ZS** (*binary eight-zero substitution*) encoding.
- **Pilot/DID numbers** — When you order a PRI line, you can separate its 23 channels into one or more “hunt” groups, each of which has its own main, or *pilot*, number. A PRI can also support DID (direct inward dialing) numbers, which typically are assigned to individual extensions or departments. For example, an ESI-100 can support up to 10 pilot numbers and up to 300 DID numbers. When you program a pilot number in a PRI-compatible ESI system (by using Installer Function 255), you must enter the maximum number of PRI channels (one to 23) that can be used for the pilot number hunt group. For example:

Pilot number	Name	Chs.	Day ring 1	Day ring 3	Day ring 5	Day ring 9
2145554378	ABC SYSTEMS	10	Dept. 290			
2145552390	ABC SYS SVC	9	Dept. 291			
2145555678	ABC SYS INTL	4	X100, X101	X100, X101 X102	Dept. 290	

Total pilot number channels: 23

**Important:** The total number of PRI pilot number channels assigned cannot exceed 23; otherwise, intermittent problems may result.

- **Glare resolution** — Must be **normal** (also called *standard*); *i.e.*, cannot be yielding. Glare is the condition wherein an outgoing call and an incoming call attempt to seize the same circuit at the same time. On loop-start analog lines, this usually causes the two callers to be connected, because loop-start lines do not manage glare resolution. However, PRI trunks utilize a standard glare resolution protocol, which must be set up correctly on both the service provider’s switch and the ESI system. Part of glare resolution defines what the CO would do with a call if glare is detected; and the ESI system will block an outgoing call if, indeed, glare is detected. This frees up the channel so that the service provider’s incoming call rings through. Because of this, the service provider’s switch must be programmed for **normal** glare resolution.
- **Incoming hunt** — Must be **ascending**. Another portion of glare resolution requires specifying to the CO in which direction incoming calls should hunt. To minimize glare, ESI systems perform either an *ascending* incoming hunt (from channel 1 to channel 23) or a *descending* outgoing hunt (from channel 23 to channel 1). When ordering the PRI, you must make the service provider aware of this requirement.
- **ISDN bearer capabilities** — This is the supported PRI feature set. Currently, ESI systems support **only** 56K voice (*CSV*). This feature set also supports fax and modem transmissions.

(Continued)

- **Service termination** — ESI recommends that the PRI circuit be terminated on an eight-pin RJ-68 (*i.e.*, “Smart Jack”). If an RJ-68 isn’t available, you may use an eight-pin RJ-48 jack. If you use an external CSU (channel service unit), be sure to turn **off** the CSU in the ESI system.

**Important:** ESI recommends that, when you connect a cable between the T1/PRI and a CSU or Smart Jack, you use Category 5 (or better) twisted-pair cable with a length of at least six feet.

- **Span type** — Use **DSX-1** when the cable length to a repeater is less than 655 feet (“short-haul”). [A CSU, multiplexer, or Smart Jack is considered a repeater.] Use DS-1 for longer distances to a repeater. (See next item, “Line build-out.”)
- **Line build-out (LBO)** — Settings to compensate for distance to nearest repeater. ESI systems support both “short-haul” and “long-haul” (attenuation settings up to -22.5 dB). Although ESI systems can support both types of LBO, “short-haul” settings are typically used.

*[See next page for sample of order form template. On the ESI Web site, you can download a PDF version — listed as **Technical Update #176**, from which this section is derived — that can be filled out on a PC using Adobe Reader.]*

PRI Order Configuration Information		Date of order	
Agent company			
Contact		Phone	
Address			
Customer name			
Cust. contact		Phone	
Address			
Circuit ID			
Support phone			
ISDN PRI line protocol	<input type="radio"/> National ISDN-2 (NI-2) <input type="radio"/> Nortel DMS 100/250 custom <input type="radio"/> Lucent/AT&T 5ESS Custom <input type="radio"/> Siemens EWSD custom		
Framing mode	<input checked="" type="checkbox"/> D4 ESF (req'd)	Line encoding	<input checked="" type="checkbox"/> B8ZS (req'd)
One- or two-way service	<input type="radio"/> One-way — Ability to only receive calls (i.e., incoming only) <input type="radio"/> Two-way — Ability to receive or generate calls (both ways)		
Pilot or DID numbers		Max. channels	
		Max. channels	
		Max. channels	
		Max. channels	
		Max. channels	
		Max. channels	
		Max. channels	
	<b>TOTAL pilot number channels (CANNOT exceed 23)</b>		
Glare resolution	<input checked="" type="checkbox"/> Normal (CPE yields) (req'd)	Incoming hunt	<input checked="" type="checkbox"/> Ascending (req'd)
ISDN bearer capabilities	<input checked="" type="checkbox"/> 56k voice (CSV) (req'd)	Service termination	<input type="radio"/> Smart Jack (RJ-68) <input type="radio"/> RJ-48C
Span type	<input type="radio"/> Short-haul (DSX-1) <input type="radio"/> Long-haul (DS-1)		
Line build-out (LBO)	<b>Short-haul LBO line length</b> <input type="radio"/> 0–133 feet <input type="radio"/> 134–266 feet <input type="radio"/> 267–399 feet <input type="radio"/> 400–533 feet <input type="radio"/> 534–655 feet	<b>Long-haul LBO attenuation levels</b> <input type="radio"/> 0.0 dB <input type="radio"/> -7.5 dB <input type="radio"/> -15.0 dB	

# Index

- 60-Key Expansion Console, B.4, I.8, I.9
- 60-Key Second Expansion Console, B.4, I.8, I.9
- Access Device, F.16, G.7, H.7
- Analog ports, I.7
- Auto-Connect, F.16, G.7, H.7
- Battery. *See* Cautions
- Cabinets
  - Expansion, F.2
- Cautions, E.1
  - Battery, E.1
  - Fuse, E.1
  - Power supply, E.1
- CO lines
  - Capacities. *See* System capacities
  - Connecting, I.5
- Console, B.4, I.8, I.9
- ESI Cordless Handsets. *See* Phones
- ESI Presence Management, D.1
- Expansion Cabinet, F.2
- Expansion Console, B.4, I.8, I.9
- Fuse. *See* Cautions
- Grounding, F.2, I.1, I.3
- Hardware installation, E.2–F.18
- LED functions, F.15, G.6, H.6
- Main board, A.2
- Memory Module, A.3
  - Installation or replacement, F.5–F.8, G.5, H.5
- Mirrored Memory Module (M3), A.3
  - Installation, F.9–F.13
- MOH, I.3
- NSP (Network Services Processor), A.7
- Overlays, B.4
- Paging, I.4
- Phones
  - Digital phones, B.1
  - ESI Cordless Handsets, B.3
  - IP phones, B.2
  - VIP Softphone*, B.4
- Port cards
  - Capacities, A.4
  - Charts, I.13–I.20
  - Installation, G.3–G.4, G.3–G.4
  - Installation, F.2
  - Port card adapter, F.3
- Power, I.1
  - Power Distribution Shelf, A.3
  - Power supply. *See* Cautions
  - Transformers, wall-mount, A.3
- PRI, I.5
- Regulatory information (U.S. and Canada), E.2
- Ringer equivalence number (REN), E.2
- Serial ports, I.3
- Site location, F.1
- SMDR, I.3
- System capacities, D.1
- T1, I.5
- UPS (uninterruptible power supply), I.1
- VIP Softphone*. *See* Phones