



DX-80 Technical Manual

Volume I

Installation & Maintenance

Copyright © 2003 Comdial Corporation

All rights reserved. Unauthorized use of this document is prohibited.

Comdial Corporation
106 Cattleman Road, Sarasota, FL 34232
(941) 554-5000 or (800) 266-3425

-Notice-

Comdial reserves the right to make any changes and improvements in the product described in this document at any time and without prior notice.

DX-80, PC-DBA, and DET are trademarks of Comdial Corporation. All other product names are trademarks of their respective owners.

First Edition
October, 2003

TABLE OF CONTENTS

Introduction

Chapter 1. Overview

1.1 System Technology	11
1.2 Configuration	13
1.2.1 KSU1 Components	13
1.2.2 KSU2 Components	13
1.2.3 Voice Processing Modules	14
1.2.4 Configuration Table	15
1.3 Key Service Unit	15
1.4 Power Supply	16
1.5 CPM (Central Processor Module)	17
1.6 408M (KSU1 Component)	18
1.7 408E (KSU II Component)	20
1.8 APM4 (Analog Port Module - 4 Circuits)	21
1.9 DPM8 (Digital Port Module - 8 Circuits)	23
1.10 COM4 (Central Office Module - 4 Circuits)	24
1.11 MDM (Modem Module)	25
1.12 AAM (Automated Attendant Module)	26
1.13 DET (Digital Executive Telephone)	26
1.14 DSS (Direct Station Selection) Console	28
1.15 Specifications	29
1.15.1 Current draw	29
1.15.2 System criteria and capacity	30
1.15.3 Electrical data	33
1.15.4 Environmental Data	33
1.15.5 Unit (Component) Detail	34
1.15.6 Wiring Data	35
1.15.7 Signaling (Central Office-PSTN) Data	35
1.15.8 Regulatory Data	36
1.15.9 Signaling (internal) Data	36

1.15.10 MTBF (Mean-Time Between Failure) Data38

Chapter 2. Installing the DX-80

2.1 Installation Overview 39

2.2 Site Planning 40

2.3 Tools and Supplies 41

2.4 Preparing the Main Distribution Frame 42

 2.4.1 Assembling the MDF42

 2.4.2 KSU Components and Installation42

 2.4.3 Mounting the KSU43

2.5 KSU Wiring 44

 2.5.1 MDF44

 2.5.2 No MDF45

2.6 Typical MDF Installation 46

2.7 KSU Components 47

 2.7.1 KSU1 408M and KSU2 408E47

 2.7.2 Replacing a 408M or 408E48

 2.7.3 KSU Assembly – Add-on Modules48

 2.7.4 Adding a DPM849

2.8 Adding an APM4 50

2.9 Adding a COM4 53

2.10 Adding an MDM 55

2.11 Adding an AAM 56

2.12 Adding a KSU2 Second Cabinet 58

2.13 Adding a Music Source 60

 2.13.1 selecting internal music tune for music channel MC160

 2.13.2 installing external music source to MC1/MC2/both61

2.14 Adding an External Pager 62

 2.14.1 External Pager Installation Procedure62

2.15 Adding Loud Bell Control or Gate Control 63

 2.15.1 Loud Ringing Bell Installation Procedure63

2.16 Connecting a Serial Cable for PC-DBA 64

2.17 Connecting a Serial Cable for SMDR 66

2.18 Power-up Initialization (Cold Start)	67
---	----

Chapter 3. Maintenance and Trouble Shooting

3.1 System Maintenance	71
3.2 Technical Problem Solving	71
3.3 Maintenance Utilities	76
3.3.1 Loading PC-DBA software	77
3.4 Entering into PC-DBA Maintenance	77
3.5 Communicating with the System	78
3.5.1 Cable	78
3.5.2 Optional System Modem	78
3.5.3 Pass-Through Communications with Corporate Office DX	79
3.5.4 PC-DBA Control Menu	79
3.5.4.1 F1 - Help	79
3.5.4.2 F2 - A-Save	79
3.5.4.3 F2 - U-Save	79
3.5.4.4 F3 - Receive	79
3.5.4.5 F4 - Send	79
3.5.4.6 F5 - Connect	80
3.5.4.7 F6 - Disconnect	81
3.5.4.8 F7 - Print	81
3.5.4.9 F8 - Initialize	81
3.5.4.10 F9 - Mdm	82
3.5.4.11 F10-RS232C	82
3.5.5 Establishing a Modem Connection	82
3.6 Maintenance Utilities	83
3.6.1 Configuration	84
3.6.2 Diagnostics	87
3.6.3 Status	91
3.6.4 SW/HW Revision	93
3.6.5 Event	94
3.6.6 Logon Data	95
3.6.7 Remote Control	96
3.6.8 Software Warm Start	97
3.6.9 Software Cold Start	97
3.6.10 Block Control	97
3.6.11 I/O Memory Mapping	98

Chapter 4. Troubleshooting Installation Issues

4.1 Corrupted Database on Initial System Setup 99

4.2 Adding Hardware to an Existing System (Making Sure the DX 80
Recognizes It) 100

4.3 Voice Mail Doesn't Work (No Legal Member) 100

4.4 Invalid Entries Calling a Busy Station; Issues with Multiple Mailbox Greetings 102

4.5 Ensuring Optimum Call Handling Performance 103

4.6 Ringing a Group Of Phones Before Routing the Call to Auto-Attendant 104

 4.6.1 Inskin Voice Mail105

 4.6.2 External Voice Mail: Debut-Small Office Lite106

4.7 Using Multiple Lines and Assigning Different Auto-Attendant Greetings
for Each Line 106

4.8 Setting Up Message Delivery to a Cell Phone 111

4.9 Using Prime CO Instead of Intercom with Modem or Fax 112

4.10 Digits Passed Inband to the Voice Mail in an
Overflow 1 Condition 114

4.11 Digits Passed Inband to the Voice Mail in an Overflow 2 Condition 115

4.12 Digits Passed Inband to the Voice Mail in a Re-Route Condition 116

Index

REVISION HISTORY

Version	Changes	Date
01	Initial version	October-31-2003

This Page Intentionally Left Blank

Introduction

This manual describes how to install the DX-80 system and to maintain it after you have installed it.

This manual is intended to provide:

- basic knowledge of the components of the DX-80 hardware and software
- step-by-step procedures for installing the DX-80 hardware.
- suggested maintenance procedures for keeping the DX-80 system operating smoothly.

Audience Description

This manual is intended for persons who:

- plan for, install, and program hardware and software in support of telecommunications switching systems, using the Comdial DX-80 switch and analog and digital phones.
- maintain and update such phone systems on a day-to-day basis.
- support their onsite client base.

This manual assumes:

- knowledge of the telephony industry, in particular small PBX switches and telephones.
- familiarity with personal computer hardware and software, including modems, and the MicroSoft DOS operating environment (applicable to using PC-DBA only).

You should:

- read this manual in normal reading sequence before starting this programming task.
- refer to this manual as necessary while performing programming, servicing, and upgrading tasks.

Related Publications

This manual refers you to related publications, when appropriate, for additional information.

- *DX-80 Technical Manual, Volume 2, Programming*, part number GCA60-001.

Conventions Used in this Manual

Many of the procedures require you to enter settings or to choose from a list of variables. To signify when you are to act upon an item, parameter, button, etc., we italicize the name of the item being acted upon. For example, the following sentences instruct you to press a specific key on your keyboard.

- Press *Enter*.
- Press *Esc*.
- Press *Page Up* or *Page Down*.
- Press and hold the *Shift* and *Ctrl* keys simultaneously.

In contrast, the following sentence instructs you to type in a required response; notice the word “Enter” when used in this way is not italicized because you are not pushing a specific key name.

- Enter the value you want to use for this feature.

Similarly, when you select a menu option, we italicize the name of the menu item because you are required to take the action of choosing it, even though the item may not appear in italics on the system menu or display.

- Use the arrow keys to highlight *Programming* and press *Enter*.

At other times in the manual, we discuss prompts that the system displays to you. In these cases, we enclose the exact wording of the prompt in quotation marks to signify that the system is, in essence, speaking to you.

- The system prompts, “Enter your password now.”

If the system is actually playing a recording aloud, we enclose the exact wording of the prompt in quotation marks and italics to signify that the system is in actually speaking to you.

- The system says, “*You have no more new messages.*”

Italics and quotes are also of course used in their normal contexts, that is, for emphasis and to identify what words are spoken.

- This is called a *hot transfer*, that is, the system transfers the call without ringing the extension.

There are times when this manual will instruct you to enter a number from within a range of numbers. In this instance, we use the “~” character to indicate the range. For example, *05-01-1~3-001~100* tells you to enter:

- 05
- 01
- a 1, 2, or 3,
- a three-digit number that falls in the 001 to 100 range.

1. OVERVIEW

The Comdial DX-80 is a fully digital hybrid key telephone system. The DX-80 uses “loop start” central office (telephone company) line interfaces, and a mix of analog and digital extension ports to provide office communications and connectivity to the Public Switched Telephone Network (PSTN). The DX-80 delivers a vast array of office productivity features and telephone use enhancing features, including Caller Identification (requires telephone company subscription), in the standard package. Unlike most systems that support Caller ID, the DX-80 supports Caller ID to DX-80 proprietary digital extensions and to third-party, Caller ID capable analog devices (cordless telephones, etc.)

Although most features are standard, the DX-80 provides for several optional features to further enhance office communications. Built-in voice processing integration packages include:

- Automated Attendant,
- Four port, Flash-based Voice Mail/Auto Attendant (expandable to 8 ports), and
- Four port, Hard drive-based Voice Mail/Auto Attendant (expandable to 8 ports).

The DX-80 platform allows you to use these voice processing platforms without losing valuable system port resources.

The DX-80 is comprised of an application configured, expandable Key Service Unit (KSU) platform. There is one fully-featured Digital Executive Telephone (DET) that delivers access to all system functions. The system architecture provides an expandable interface for digital port growth and analog port growth. The basic configuration supports both device types. (Analog ports might be used for plain old telephones, fax machines, modems, etc.) The DX-80 is designed to meet the telecommunications needs of small-to-medium business offices.

1.1 System Technology

The DX-80 incorporates state-of-the-art digital technology for voice switching and call processing, using Pulse Code Modulation and Time Division Multiplexing (PCM/TDM). The DX-80 is a non-blocking switch, with no loss or degradation of voice signals. The system is stored-program control and uses a 16-bit, 20 MHz main microprocessor and peripheral devices (extensions and CO lines) in a distributed processing configuration. Memory consists of 640K bytes of ROM (Read Only Memory) and 384K bytes of RAM (Random Access Memory). The RAM is lithium battery protected.

The following table shows the available DX-80 equipment.

Device Name	Part #	Characteristics
KSU1	7201	8 digital extension ports. 4 analog device ports. 4 CID-ready CO line ports. 2 music source inputs, can be assigned as desired to CO lines for hold music/ messages. 1 power failure port (CO line 1). 1 control contact (LBC, Gate, External Page Control). 1 external paging equipment interface. 2 serial ports. PC-DBA programming. SMDR (Station Message Detailed Recording).
OPTIONAL EQUIPMENT		
KSU2	7202	Used to expand the system capacity beyond KSU1 limits. 8 digital extension ports 4 CO line ports 1 power failure port (CO line circuit 1).
DPM8	7220	Digital Port Module - 8 circuit. Installs into KSU1 or KSU2.
APM4	7230	Analog Port Module - 4 circuit. Installs into KSU1 or KSU2.
COM4	7210	CO line Module - 4 circuit with one power failure port on first CO line circuit. Installs into KSU1 or KSU2.
MDM	7249	Modem Module, for use with off-site programming. Installs into KSU1 only.
AAM	7240	Automated Attendant Module. 4 port, one menu for routing. 10 announcements for various caller greetings. Installs into KSU1 only.
CO DX FLASH	7271C	Flash-based, 4-port Voice Mail (Corporate Office DX) with Auto Attendant. 1.5 hours storage and 100 mailboxes.
CO DX HD	7270C	Hard Drive-based, 4-port Voice Mail (Corporate Office DX) with Auto Attendant and on-board modem. 100 hours storage and 100 mailboxes.
	7272	4 port expansion to 7271C or 7270C.

The maximum system configuration is 16 CO lines, 56 extensions (48 digital and 8 analog) and 8 voice processing channels.

1.2 Configuration

The Comdial DX-80 platform is comprised of one full-featured key telephone model and two modular KSUs (Key Service Units). Several modules are available for enhanced system applications and configuration expandability.

1.2.1 KSU1 COMPONENTS

The CPM (Central Processor Module) is installed inside of KSU1 to the 408M ribbon cable J4 (also labeled “To CPM”). The CPM contains:

- Two serial ports,
- Two music ports,
- One control contact (external paging/LBC/gate control),
- One external page equipment interface connection, and
- Socket connectors for the KSU2 (labeled “2nd Cabinet”), MDM, and VP modules (AAM, 7271C, and 7270C).

The standard 408M (part of 7201) contains:

- 4 CO line ports,
- 1 power failure transfer port for the first CO line circuit,
- 8 digital ports,
- a ribbon cable (J1, also labeled “COM4”) for connection to the COM4 module (PN 7210) in KSU1, and
- ribbon cable sockets (J2 and J3, also labeled “To DPM8/APM4”) for connection of DPM8 (PN 7220) or APM4 (PN 7230) modules.

The standard APM4 (part of 7201) contains four analog device ports (installed on ribbon cable J5, also labeled “APM4”).

1.2.2 KSU2 COMPONENTS

The standard 408E contains:

- 4 CO line ports
- 1 power failure transfer port for the first CO line circuit
- 8 digital ports
- a ribbon cable (J1, also labeled “COM4”) for connection to the COM4 module (PN 7210),
- ribbon cable sockets (J2 and J3, also labeled “To DPM8/APM4”) for connection of DPM8 (PN 7220) or APM4 (PN 7230) modules, and
- a shielded cable (J4) for connection to CPM socket JP2 (also labeled “2nd Cabinet”) in KSU1.

1.2.3 VOICE PROCESSING MODULES

The DX-80 provides several voice processing (or voice mail) options. The optional voice processors that you can add to the DX-80 are fixed system resources that do not require peripheral device ports (analog or digital). This significant advantage means that the DX-80 VP options can be added to any DX-80 configuration without “port loss” thus eliminating the ill effects of reducing the overall capacity of the system when the voice processor is connected. Because the DX-80 doesn’t use conventional peripheral ports to interface the VPs, we refer to the VP connectivity in terms of “channels.”

- **AAM (Automated Attendant Module):** The AAM provides four channels for automated attendant operation only. The AAM is then capable of handling four calls simultaneously. Callers answered by the AAM are greeted by one of four greetings associated with the DX-80 mode of operation (Day / Evening / Alternate / Temporary). Various other announcements are also included for caller processing, refer to the *DX-80 Technical Manual, Volume II, Programming* for further details.
- **7271C (Flash-based, four port VM with Automated Attendant):** The 7271 provides four channels for automated attendant and voice mail operation. The 7271 is equipped to support up to 100 voice mailboxes and 3.2 hours of message storage (including the various greeting announcements).
- **7270C (Hard Drive-based, four port VM with Automated Attendant):** The 7270C provides four channels for automated attendant and voice mail operation. The 7270C is equipped to support up to 2000 voice mailboxes and 150 hours of message storage (including the various greeting announcements).
- **7272 (Four port expansion card):** The 7272 is added to the 7271C or 7270C to increase the total message storage time to 4.5 hours.

All of these voice processors are connected to the DX-80 CPM via specific interface sockets.

Note: For details on installing the 7271C and 7270C refer to the Corporate Office DX Installation Instructions, IMI72-005.

1.2.4 CONFIGURATION TABLE

Equipment Installed				CO Lines	Digital Ports	Analog Ports
COM4	DPM8	APM4				
KSU1 (one APM4 included standard)				4	8	4
		1		4	16	4
		2		4	24	4
	1			8	8	4
	1	1		8	16	4
	1	2		8	24	4
	1	1	1	8	16	8
KSU2 adds to KSU1 configuration (KSU2 does not come with an APM4)				4	8	
		1		4	16	
		2		4	24	
	1			8	8	
	1	1		8	16	
	1	2		8	24	
	1	2	1	8	24	4
	1	1	2	8	16	8
Maximum configuration using 100% of digital port capacity				16	48	8
Maximum configuration using 100% of analog port capacity				16	32	16

1.3 Key Service Unit

The DX-80 Key Service Unit (KSU) is a modular flat-pack design. Two KSU's (KSU1 and KSU2) may be equipped to achieve the total system capacity of 16 CO lines, 56 extensions (48 digital and 8 analog) and 8 Voice Processing channels. KSU1 is factory equipped with one 408M, one APM4 and the CPM. KSU2 is factory equipped with one 408E.

Each KSU is a self-contained cabinet with internal power supply. The power supply AC transformer voltage switch can be set for either 117vac or 230vac operation. (It is factory set for 117vac operation.) The KSU is designed to be mounted on the wall and is shipped with a wall mounting template. The compact KSU weighs less than 20 pounds and is UL Listed.

Figure 1-1 DX-80 Key Service Unit (KSU)

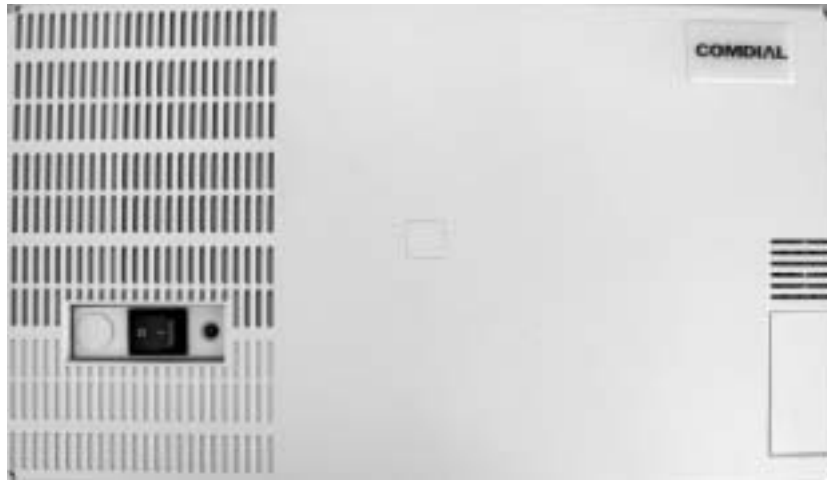

You can remove or reposition three panels installed over various KSU openings to accommodate exterior connection requirements. You can remove one panel to route a serial cable through the KSU outer housing for connection of ancillary SMDR equipment. You can remove another panel to route a serial (NULL Modem) cable through the KSU outer housing for direct connection of a PC for on-site PC-DBA programming. You can remove or reposition the remaining KSU panel to accommodate cables entering through the outer housing for connecting station/extension cables or to the MDF.

From the exterior, with covers in place, the KSU1 and KSU2 look identical. However, KSU1 contains the CPM (system call processing).

1.4 Power Supply

The power supply circuitry of the DX-80 incorporates a linear design AC transformer with a choice of input voltage. The voltage selector switch is shipped set for 117vac applications; you can also set this switch for 230vac applications. Since the power supply is linear in design, the output voltage varies between 21.6vdc and 32vdc depending on load and stability of the input voltage. The output voltage is delivered to the 408M (in KSU1, 408E in KSU2) for voltage regulation. All system operation and logic voltages are produced at the 408M/E.

Figure 1-2 Power Supply

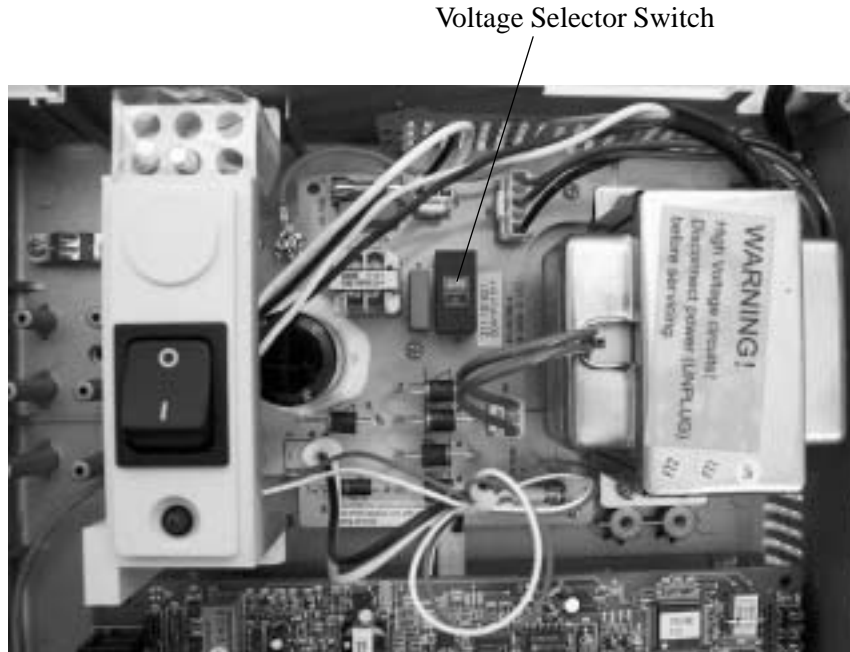

Two fuses are equipped on the power supply board, one for AC input over-voltage protection and one for DC output over-current protection. A main power switch is accessible when the KSU cover is in place. In the event battery backup operation is desired the KSU power cord can be connected to an external (ancillary) UPS (Uninterrupted Power Supply). It is your responsibility to match the battery requirements/UPS requirement to the specific needs of the equipment owner.

To determine the battery requirement needs and UPS requirement, see Section 1.15, *Specifications* to find the current draw and necessary Amp/Hour back up support that the battery/UPS must supply.

1.5 CPM (Central Processor Module)

The CPM module is equipped standard in KSU1. This board contains all circuitry required to control the fully equipped DX-80. The system uses the CPM to perform all digital voice switching and call processing data switching.

The CPM has one ribbon cable connector for connection to the KSU1 408M and five (5) connector sockets for connection of the system built-in modem, voice processor, and second cabinet (KSU2). Since the CPM comes installed inside of KSU1 the CPM ribbon cable is already in place and connected to the KSU1-408M J5 socket. Assuming the orientation of the KSU1 cabinet is installed on the wall; the two horizontal connector sockets in the upper right corner of the CPM are for the MDM (Modem Module). The connector socket labeled “2nd Cabinet” is for connection to the KSU2-408E if that expansion is required. The remaining two connector sockets on the CPM, one at the left side, the other at the right side are for the voice processor solution. *Note: The voice processor solution can be any of three possible choices: AAM, 7271C, or 7270C.*

The CPM also provides the following standard connectors:

- Music Channel 1 - On Hold/Background Music Interface,
- Music Channel 2 - On Hold/Background Music Interface,
- Control Contact (Loud Bell / Door / External Page Control),
- External Paging Equipment Interface,
- RMP Serial Port - for onsite PC-DBA system database programming, and
- SMDR Serial Port - for connection to ancillary SMDR/Call Accounting equipment.

The CPM has two option strap jumpers one for database start-up (J11) and one for music channel one source (internal/external) selection (JP30).

- **J11 Cold Start/Normal**—J11 is used to force load database default factory settings. This jumper will normally never require operation after the initial power up sequence is completed. However should the need arise to return the site database to the factory settings this jumper is used to perform a cold start.
- **JP30 Internal/External**—JP30 is used to select the Music Channel 1 source. The DX-80 provides a synthesized music source for music on hold, in applications where no music source is available. The synthesized tune is repeated. JP30 is in the “External” position when it ships from the factory.

1.6 408M (KSU1 Component)

The 408M is the large circuit board that is packaged inside of KSU1. The 408M provides interface for up to four loop-start CO lines and 8 digital extension ports. Additionally the 408M regulates the 24 volt DC power from the source to produce all required logic voltages and operations voltages. There is also a Power Failure Port located on the 408M that is connected to the first CO line circuit. Whenever power fails, this port becomes active with dial tone from the CO line connected to the first CO line port.

Figure 1-3 KSU1 shown with cover – CPM and APM4 removed (408M exposed)

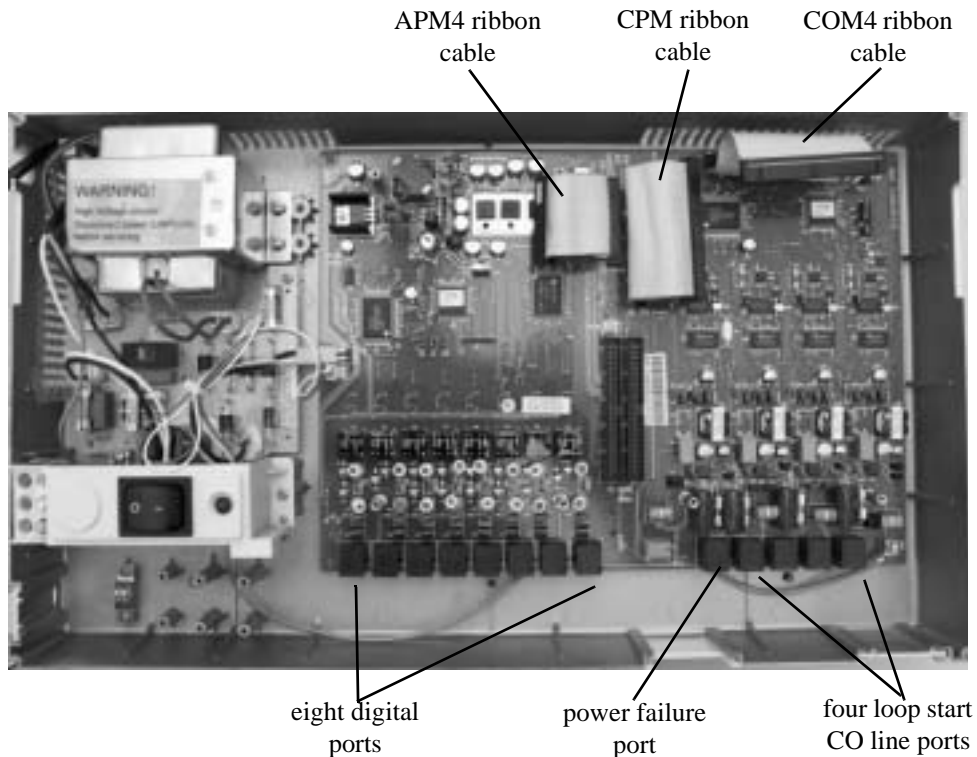

The 408M is equipped with a heartbeat LED that indicates processing activity on the PCB. (The 408M peripheral processor is operating when the heartbeat LED is flashing.) The KSU1 operation LED (located next to the power switch) is tied to the 408M heartbeat LED. Therefore, when the LED next to the power switch is flashing, the 408M is active.

The KSU1-408M has three ribbon cables:

- located at the upper right and oriented in a horizontal position, the J1 cable is used to interface a COM4 if required to expand the system CO line capacity.
- located at the upper center and oriented in a vertical position, the J4 cable is used to interface the DX-80 CPM.
- located at the upper center and oriented in a vertical position, the J5 cable connects to the standard APM4 installed in KSU1.

Each CO line circuit incorporates over-voltage protection, ring detector, loop detector, loop/pulse-dial relay, current sink circuit, coupling/isolation transformer (impedance 600:600), hybrid circuit, CODEC & filter, polarity guard circuit and Radio Frequency noise filter.

The fourth CO line port is equipped with CNG Fax Tone Detection circuitry. When programmed as a “FAX” line, this circuit will automatically engage the FAX Tone detector. If FAX tone is detected, the system routes the call to the analog port designated as the destination for fax calls.

Each digital port (connects to Digital Executive Telephones and DSS Consoles) is comprised of a proprietary octal ASIC (Application Specific Integrated Circuit) transceiver. There are three data channels in operation at each digital port via the octal transceiver. One channel is used for call processing control of digital terminal functions/operations and two channels are used for the digital voice channel requirements.

Each digital station interface is protected against circuit wiring shorts by an over-current protection Polyswitch. The digital station circuit requires only one cable pair to operate and is not polarity sensitive.

Physical connection of digital extensions, power failure telephones, and CO lines to the 408M module is made through convenient RJ-11 connectors along the bottom edge of the module.

1.7 408E (KSU II Component)

The 408E is very similar to the 408M; however, it is unique to KSU2. The 408E provides interface for up to 4 loop-start CO lines and 8 digital extension ports. In addition, the 408E regulates the 24-volt DC power from the source to produce all required logic voltages and operations voltages. There is also a Power Failure Port located on the 408E that is associated to the first CO line circuit. Whenever power fails this port becomes active with dial tone from the CO line connected to the first CO line port.

Figure 1-4 KSU2

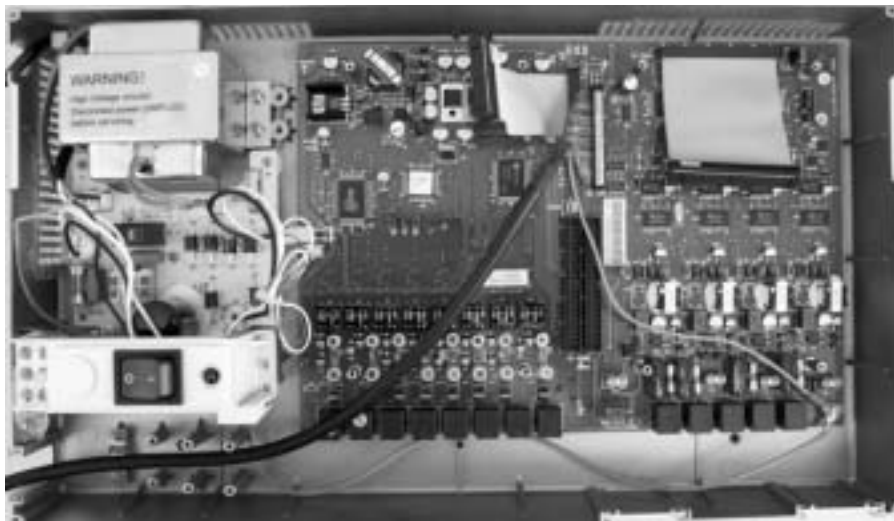

The 408E is equipped with a heartbeat LED that indicates processing activity on the PCB; the 408E peripheral processor is operating when the heartbeat LED is flashing. The KSU2 operation LED (located next to the power switch) is tied to the 408E heartbeat LED, therefore, when the LED next to the power switch is flashing, the 408E is active.

The KSU2-408E connections are almost identical to those on the 408M (KSU1); the exception is the long shielded cable used to connect KSU2 to the CPM inside of KSU1. *Note: There is no standard APM4 installed inside of KSU2.*

Each CO line circuit incorporates over-voltage protection, ring detector, loop detector, loop/pulse-dial relay, current sink circuit, coupling/isolation transformer (impedance 600:600), hybrid circuit, CODEC & filter, polarity guard circuit and Radio Frequency noise filter.

The fourth CO line port is equipped with CNG Fax Tone Detection circuitry. When programmed as a "FAX" line, this circuit automatically engages the FAX tone detector. If FAX tone is detected, the system routes the call to the analog port designated as the destination for fax calls.

Each digital port (connects to Digital Executive Telephones and DSS Consoles) is comprised of a proprietary octal ASIC (Application Specific Integrated Circuit) transceiver. There are three data channels in operation at each extension port via the octal transceiver: one channel is used for call processing control of digital terminal functions/operations and two channels are used for the digital voice channel requirements.

Each digital station interface is protected against circuit wiring shorts by an over-current protection Polyswitch. The digital station circuit requires only one cable pair to operate and is not polarity sensitive.

Physical connection of digital extension terminals, power failure telephones, and CO lines to the 408M module is made through convenient RJ-11 connectors along the bottom edge of the module.

1.8 APM4 (Analog Port Module - 4 Circuits)

The APM4 provides four separate analog device ports. This allows the DX-80 to support auxiliary office equipment such as fax machines, PC/FAX modems, and analog telephones (single line telephones). The APM4 generates -30VDC and 20-25Hz, 50V square wave ringing for operation.

Figure 1-5 APM4 (Analog Port Module - 4 Circuits)



The APM4 is equipped with a heartbeat LED that indicates processing activity on the PCB; the APM4 peripheral processor is operating when the heartbeat LED is flashing.

The APM4 provides DTMF receivers for each analog port. Ancillary analog devices connected to APM4 analog ports must generate DTMF signaling.



All connections are via RJ-11 connectors along the bottom edge of the module. KSU1 is delivered with one APM4 installed on ribbon connector J5 as standard equipment.

APM4's may be installed on 408M/E-J5 (standard in KSU1:408M-J5), 408M/E-J2, or 408M/E-J3.

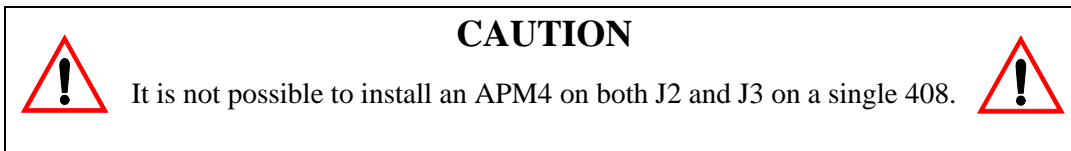

When an APM4 is installed via J2 or J3, it takes the place of DPM8 modules that might be installed in those locations. Therefore APM4 modules installed using J2 or J3 will reduce the total number of Digital Port Modules (DPM8) possible.

1.9 DPM8 (Digital Port Module - 8 Circuits)

The DPM8 module expands the DX-80 system capacity of digital ports DET (Digital Executive Telephones) and DSS consoles. Each digital port is comprised of a proprietary octal ASIC transceiver. There are three data channels in operation at each digital port via the octal transceiver. One channel is used for call processing control of digital terminal functions/operations and two channels are used for the digital voice channel requirements. The DPM8 is controlled directly from the 408M/E; therefore, there is no heartbeat LED located on the DPM8.

Figure 1-6 DPM8 (Digital Port Module - 8 Port)

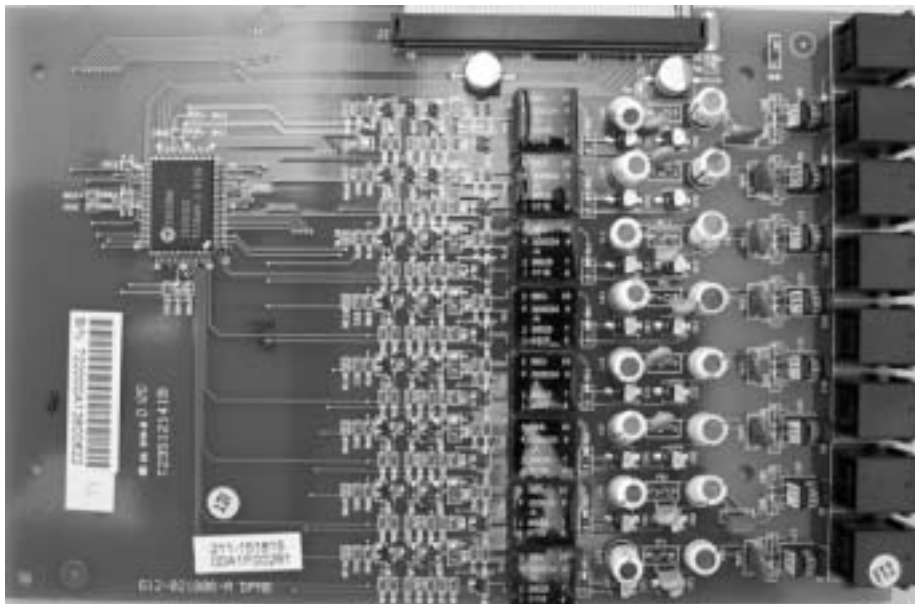

Each digital station interface is protected against circuit wiring shorts by an over-current protection Polyswitch. The digital station circuit requires only one cable pair to operate and is not polarity sensitive.

Physical connection of digital port terminals (DET and DSS) to the DPM8 module is made through convenient RJ-11 connectors along the bottom edge of the module.

1.10 COM4 (Central Office Module - 4 Circuits)

The COM4 module is installed in the dedicated position via J1 of the 408M/E. The COM4 interfaces four loop-start CO lines. Since one COM4 may be installed in KSU1 and one COM4 may be installed in KSU2, you can expand the DX-80 system CO line capacity to support up to 16 CO lines.

Figure 1-7 COM4 (Central Office Module - 4 Port)

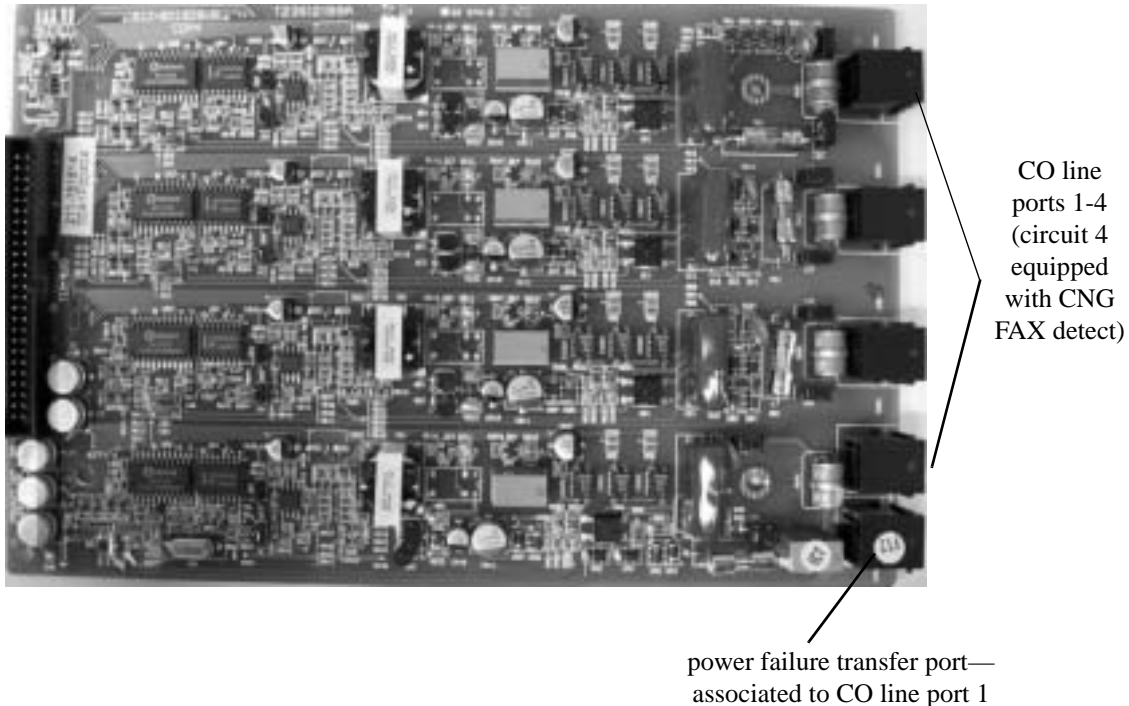

The COM4 module is shipped with four mounting stand-offs used to install the board into the KSU1 or KSU2. Five RJ11 jacks are provided along the bottom edge of the COM4 module for connection of one power failure telephone and the four CO lines.

CO lines are terminated at the site by the telephone company at a point of interface called the Demarcation (Demarc). When ordering CO lines for the site, request termination on RJ11 type jacks. Doing so allows you to easily extend the CO lines to the COM4 RJ11 connector (one CO line per jack and connector).

Each CO line circuit incorporates over-voltage protection, ring detector, loop detector, loop/pulse-dial relay, current sink circuit, coupling/isolation transformer (impedance 600:600), hybrid circuit, CODEC & filter, polarity guard circuit, and Radio Frequency noise filter.

The fourth CO line port is equipped with CNG Fax Tone Detection circuitry. When programmed as a “FAX” line, this circuit will automatically engage the FAX tone detector. If FAX tone is detected, the system routes the call to the analog port designated as the destination for fax calls.

1.11 MDM (Modem Module)

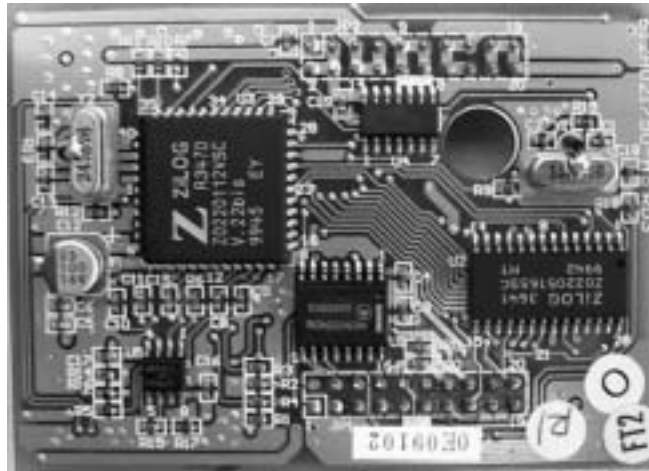

The 7249 Modem Module is a self-contained integrated modem unit that is installed at JP5 and JP6 in the upper right corner of the CPM. The integrated MDM allows you to access the system programming and remote maintenance utilities from an off-site location (password verification is required).

Figure 1-8 MDM (Modem Module)



When the MDM is installed, you can program the system remotely using PC-DBA. **Note:** *PC-DBA is included in the utilities CD DXUIILCD shipped with every new system. Or, you can obtain PC-DBA free of charge at the Comdial Web site, www.comdial.com.*

You can service the system, using PC-DBA and a modem in your PC, to place a call to the site where the DX-80 is installed. **Note:** *If one of the voice processing systems are installed, routing to the modem extension is automated. Otherwise, the person who answers this data call must transfer the call to extension 199. Once the modems have established the data connection, you can begin servicing the switch.*

	CAUTION	
<p>The MDM default extension number is 199. This number can be changed and therefore may be different for some DX-80 systems.</p>		

1.12 AAM (Automated Attendant Module)

The Automated Attendant Module is a self contained integrated module that enables automatic answering of selected CO lines and a single-level menu for greeting callers and routing them to DX-80 system destinations. The AAM can handle all call traffic or act as a backup to the primary answering system attendant.

Figure 1-9 AAM (Automated Attendant Module)

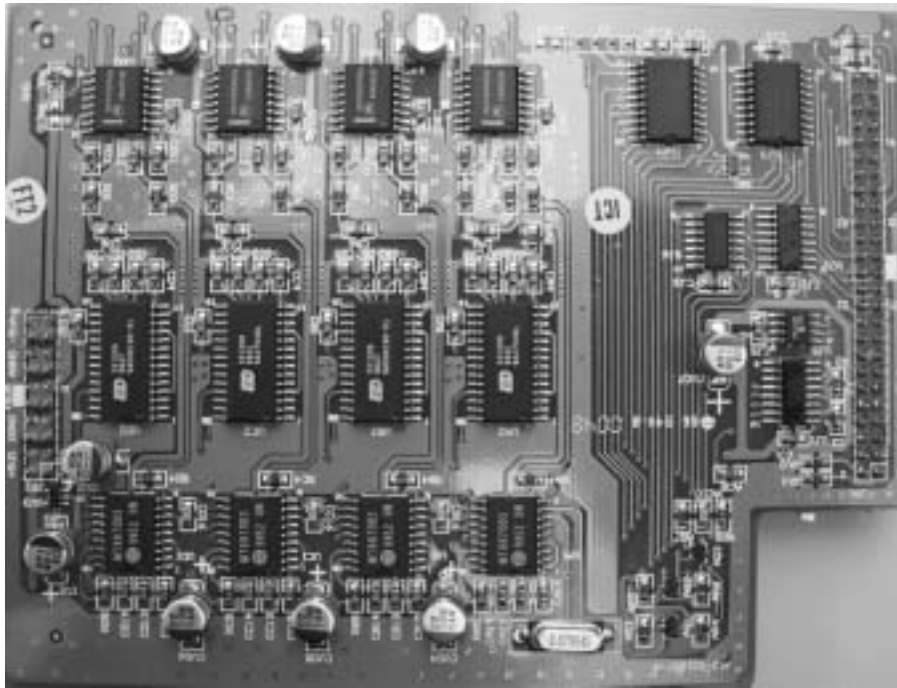

The AAM is installed at JP3 and JP4 of the CPM (centered above the board).

The AAM provides 10 announcements for the various modes of system/action operation: Day Greeting, Alt Greeting, Night Greeting, Waiting Message, Invalid Message, Busy Message, No Answer Message, Goodbye Message, Inquiry Message, and Temporary Message.

1.13 DET (Digital Executive Telephone)

The DX-80 has one model digital telephone called the Digital Executive Telephone. The DET provides:

- a half-duplex speakerphone for hands-free conversations,
- a two-row by sixteen column (32-character), dot-matrix, supertwist, Liquid Crystal Display (LCD), and
- three interactive buttons to enhance system feature operation.

The supertwist LCD eliminates the need for contrast adjustment, and enhances clarity of displayed data using an angled viewing position. Since the DX-80 includes Caller ID (CID) as a standard feature, the LCD also provides every designated ringing extension with CID data for incoming CO line calls. *Note: CID requires a subscription from the servicing telephone company.*

The display also provides a visual reference to call progress and call duration, as well as time and date information. The display enables the user to send and receive visual advisory and callback messages. Users may select from six pre-programmed messages (i.e., “IN A MEETING,” “OUT OF OFFICE”), or they may create a custom message. Callers from other DETs to an extension with a message active will receive the visual advisory message on their LCD display.

Each digital speakerphone has 30 programmable Feature Buttons to aid the user by providing direct access to system features and resources. There are also three interactive buttons and 8 fixed function buttons. *Note: The volume button bar represents two operations: volume up and volume down.*

Each DET is equipped standard with a 2.5 millimeter headset jack. Users can toggle their speakerphone operation in and out of a special “headset mode”. This mode allows the user to easily activate the headset jack via the ON/OFF button as an alternative to using the speakerphone. Thus, headset mode is easily enabled or disabled so that users can quickly select between use of the headset or speakerphone operations. *Note: The DET must be idle to change this setting.*

Each speakerphone is also equipped with a status lamp to aid in user operations. The lamp is dual color (red / green) and indicates various modes of operation, such as messages/voice messages waiting, incoming calls - distinctive for CO and intercom, in-use indication for speakerphone mode, headset mode, etc.

Figure 1-10 DET (Digital Extension Telephone)



1.14 DSS (Direct Station Selection) Console

The DSS console is a digitally interfaced component of the DX-80. It connects to the system via any available digital port (408M/E or DPM8 digital port). The DSS is equipped with 60 programmable buttons. Twelve of these buttons are intended for features code storage only and do not have LED indications associated with them. Forty eight buttons are equipped with dual color (red / green) LEDs and may be assigned any system feature code or directory number; these buttons may be assigned for either system features operations or CO line access operations.

You can mount the DSS console in one of two positions: lower profile desk position and wall mounted position. DSS consoles are programmed to operate with an associated speakerphone. You can assign up to four DSS consoles per speakerphone. The maximum number of DSS consoles supported by the DX-80 is 12. Each equipped DSS console requires one digital port, therefore the total number (system capacity) of speakerphones possible is reduced by one for each DSS console installed.

Figure 1-11 Direct Station Selection Console



1.15 Specifications

1.15.1 CURRENT DRAW

Use this chart to calculate the Amphour requirements of the DX-80 system based upon its configuration. This information is typically used to apply UPS battery requirements.

Component	Current Draw (Amps) @ 117 VAC	Quantity	Extended Total Amps
KSU1 (7201)	0.18A	1	0.18A
KSU2 (7202)	0.17A	1 max.	
COM4 (7210)	0.02A	2 max.	
DPM8 (7220)	0.01A	4 max.	
APM4 (7230)	0.08A	3 max.	
MDM (7249)	0.01A	1 max.	
AAM (7240)	0.01A	1 max.	
7271C	0.02A	1 max.	
7270C	0.01A	1 max.	
DET (7260-00)	0.016A	48 max.	
DSS (7266-00)	0.016A	12 max.	
Station wire: per DET, DSS, and IST	0.02A every 100 ft. of 24AWG	?	
Multiply the unit times the quantity installed in the subject application (site) and add the right column for the total current draw (Amps) @ 117VAC for this site.			

1.15.2 SYSTEM CRITERIA AND CAPACITY

Time slots	PCM - 32 time slots x 4 Highways (128 voice channels) TDM 64 Time Slots (data processing)
Customer database memory protection	300 hours via on-board lithium battery (no charging required)
Ports: CO/PBX/Centrex Lines Digital Stations Standard Single Line Telephones	16 48 16 <i>Note: 32 total possible digital extensions in this configuration.</i>
DTMF Receivers:	One dedicated per single line telephone port
DTMF Senders:	Unlimited. (DTMF signal generation is derived from the core system tone resource. Tone combinations are available as needed.)
Tone Detectors: (used to monitor call progress tones; Busy Tone, Ring-back Tone, etc.)	2 (shared for advanced call processing system features; DISA, ECF, ABR. etc.)
Contacts	1 LBC can be programmed as associated to a CO line or dialed by an extension to actuate the contact
Conference circuits	8 - 4 party conference circuits
DISA circuits	Any number of CO lines may be programmed for DISA operation. (AAM required for operation.)
System Attendants	1 Attendant + 1 alternate per tenant group
Tenant Groups	3
UCD/Hunt Groups: Members per group: Group Types: Hunting Method:	24 24 UCD or Voice Announce Linear, All Ring or Distributed

Voice Mail Groups	1 per Tenant (uses 1 UCD Group per VM system)
Members (ports)	24
Integration Method	Digital (ICD Voice) and In-band (for other)
VM message waiting	#96 + station number to turn VM button LED on. ##96 + station number to turn VM button LED off
VM control codes	Disconnect Digits: 8 digits max. Subscriber Calling via Intercom: 4 digits max. Transfers to VM : 4 digits max. Busy Forward: 4 digits max. No Answer Forward: 4 digits max. Direct Call Forward: 4 digits max. CO Line Recall: 4 digits max. CO Line Ringing: 4 digits max. UCD Overflow: 4 digits max. Record Digits for Voice Recorder function: 4 max. Delete Digits: 4 digits max. Suffix for transferred calls: 2 max.
CO line loop current sensing	Interrupt programmable from 50ms to 2500ms.
Paging	8 Internal Page Extension Groups 1 External Page Port 1 Internal All Call 1 System (Internal/External) All Call
Speed Dialing	1000 total bins, dynamically allocated. 200 bins at default allocated for system-wide use. 20 bins at default allocated for extension use (extensions 101-148 only) (50 possible per extension) 16 digits maximum per bin.
Last Number Redial	16 digits per station
Save Number Redial	16 digits per station
User Saved Number (Memo Pad)	20 digits per station
Callback request per station	1
Camp On by a busy station	1
Stations Camped on to a station	1
Stations Camped on to a busy line	1
Message - Executive Notification	6 preprogrammed 1 personal per station

Overview

Message - Executive Preprogrammed	6 preprogrammed 1 personal per station
Message Waiting	40 simultaneous maximum per system (does not affect VM message indications)
Name in Display	1 per station, 7 characters max.
Class Of Service (COS)	8 (0-7) per Day, 8 (0-7) per Night
Toll Restriction To/From Tables	100 Tables per tenant, 10 digits per entry, Day and Evening COS assignable per entry per CO Line and Extension.
Forced Verified Account Codes	600 codes, 2-8 digits max., each assigned a COS
Unverified Account Codes	8 digits max.
Call Pick Up Groups	8 extension groups
Station Lock Password	4-8 digits per extension
CDB Programming Password	8 alphanumeric characters (“_____” eight spaces at default); default password when programming via DET ”#####” (eight astericks)
System Reminder Alarm	8 time settings per tenant group
Station Alarm	1 per station repeating or one time
Ring Schemes	8
Distinctive Ring Tones	8 per station
External Call Forward	via extension call forward settings

1.15.3 ELECTRICAL DATA

Electrical Specifications	
AC Power source	Dedicated 117/230vac \pm 15%, 47-63Hz single phase
Power consumption	1.5A maximum @ 120vac (180 watts)
Power Supply fuse	
AC input:	2A 250v
DC output:	1A 125v
Idle Channel Noise	-74 dB
Cross Talk Attenuation	75 dB (@ 1kHz)
Ringing Sensitivity	40v RMS 25 Hz
Ringer Equivalence Number	1.5
CO Line Signaling	DTMF amplitude (-5 dB,-7 dB) +- 2 dB, @ approx. 2 Vpp Pulse Dialing ratio 60/40 @ 10 PPS
Music source / Background Music	0 dBm at 600 ohm input impedance 1/8th inch phono jack
Contact rating (Option Module LBC)	1A @ 30VDC 0.5A @ 90VAC 30Hz 1/8th inch phono jack
External Page Port	0 dBm at 600 ohms 1/8th inch phono jack

1.15.4 ENVIRONMENTAL DATA

Environmental Specifications	
Operating Temperature	0° to 35° C, 32° to 95° F
Recommended Operating	70° to 78° F
Storage Temperature	32° to 104° F
Operating Relative Humidity	5% to 90% (non-condensing)
Heat Dissipation (BTU)	300

1.15.5 UNIT (COMPONENT) DETAIL

Unit Specifications					
Part Number	Description	Dimensions:			Weight
7201/7202	KSU1/KSU2	L	460 mm	18.4 in.	4.0Kg
		W	270 mm	10.8 in.	
		H	105 mm	4.2 in.	
7200	CPM Central Processor Module	L	210 mm	8.25 in.	0.4Kg
		W	138 mm	4.5 in.	
		H	18 mm	¾ in.	
7248	408M Standard 4 CO Line x 8 Digital Extension Module	L	210 mm	8.25 in.	0.4Kg
		W	138 mm	4.5 in.	
		H	18 mm	¾ in.	
7210	COM4 Central Office Module – 4 Port	L	210 mm	8.25 in.	0.3Kg
		W	138 mm	4.5 in.	
		H	18 mm	¾ in.	
7220	DPM8 Digital Port Module – 8 Port.	L	210 mm	8.25 in.	0.4Kg
		W	138 mm	4.5 in.	
		H	18 mm	¾ in.	
7230	APM4 Analog Port Module – 4 Port.	L	210 mm	8.25 in.	1.2Kg
		W	138 mm	4.5 in.	
		H	21 mm	7/8 in.	
7240	AAM Automated Attendant Module	L	210 mm	8.25 in.	1.7Kg
		W	138 mm	4.5 in.	
		H	21 mm	7/8 in.	
7271C	CO DX FLASH	L	210 mm	8.25 in.	0.5Kg
		W	138 mm	4.5 in.	
		H	21 mm	7/8 in.	
7270	CO DX HD	L	210 mm	8.25 in.	0.3Kg
		W	138 mm	4.5 in.	
		H	21 mm	7/8 in.	
7249	MDM Modem Module	L	234 mm	9.36 in.	0.3Kg
		W	188 mm	7.52 in.	
		H	64.5 mm	2.58 in.	
7260-00	DET – BK Digital Executive Telephone – Black (LCD Speakerphone)	L	230 mm	9 in.	1.7Kg
		W	182 mm	7.25 in.	
		H	140 mm	5.5 in.	

Unit Specifications					
7266-00	DSS Console – Black	L	241 mm	9.5 in.	1.7Kg
		W	202 mm	8 in.	
		H	93 mm	3.75 in.	

1.15.6 WIRING DATA

Maximum Cable Length	
DET (distance measures in linear feet of cable from KSU to DET)	26 AWG - 255m (850 ft.)
	24 AWG - 425m (1416 ft.)
	22 AWG - 700m (1983 ft.)
Standard Single Line Telephone (distance measures in linear feet of cable from KSU to IST)	26 AWG - 195m (650 ft.)
	24 AWG - 340m (1133 ft.)
	22 AWG - 476m (1586 ft.)

1.15.7 SIGNALING (CENTRAL OFFICE-PSTN) DATA

Dialing Specifications	
DTMF Dialing Mode	
Frequency deviation:	± 1%
Rise time:	3ms
Duration of DTMF signal:	programmable 50-150ms (70ms default)
Inter-digit time:	programmable 50-150ms (70ms default)
VM Port DTMF duration:	programmable 60-150ms (120ms default)
VM Port Inter-digit time:	programmable 60-150ms (120ms default)
Pulse Dialing Mode	
Pulse dial rate:	10 pulses per second
Pulse Make/Break ratio:	60/40

1.15.8 REGULATORY DATA

FCC Registration Numbers	
For systems configured for key system operation (each CO line appears on its own dedicated button).	D6XTAI-40144-KF-T
For systems configured for hybrid operation (CO lines may be accessed by dial codes and Pool/Loop buttons).	D6XTAI-40145-MF-T

1.15.9 SIGNALING (INTERNAL) DATA

Audible Signals		
Signal	Frequency	Cadence
CO Line Ringing:		
Scheme 0	N/A	300ms On, 400ms Off, 300ms On, 4 seconds Off
Scheme 1	N/A	
Scheme 2	N/A	1 second On, 3 seconds Off
Scheme 3		1 second On, 3 seconds Off
Scheme 4		follows ring cadence of Ring Scheme selected
Scheme 5		follows ring cadence of Ring Scheme selected
Scheme 6		follows ring cadence of Ring Scheme selected
Scheme 7	-SLT bell-	follows ring cadence of Ring Scheme selected
Distinctive 1		follows ring cadence of Ring Scheme selected
Distinctive 2		
Distinctive 3		
Distinctive 4		
SLT		

Audible Signals		
Intercom Ringing:		
Scheme 0	N/A	1 second On, 3 seconds Off
Scheme 1	N/A	1 second On, 3 seconds Off
Scheme 2	N/A	300ms On, 400ms Off, 300ms On, 4 seconds Off
Scheme 3		follows ring cadence of Ring Scheme selected
Scheme 4		follows ring cadence of Ring Scheme selected
Scheme 5		follows ring cadence of Ring Scheme selected
Scheme 6		follows ring cadence of Ring Scheme selected
Scheme 7	-SLT bell-	follows ring cadence of Ring Scheme selected
Distinctive 1		follows ring cadence of Ring Scheme selected
Distinctive 2		
Distinctive 3		
Distinctive 4		
SLT		
Message Wait Callback		follows ring cadence of Ring Scheme selected

1.15.10 MTBF (MEAN-TIME BETWEEN FAILURE) DATA

Mean-Time Between Failure Analysis System Components	
Cabinet Assembly	86.0
Power Supply Unit	170.0
CPM	2915.7
408M	11407.3
DPM8	3560.8
COM4	6146.5
APM4	6860.2
MDM	761.0
AAM	2337.3
<p>Method:</p> <p>Use the figures above for each unit installed (or to be installed) and calculate the total for this system configuration.</p> <p>Use the total from step 1 in place of the variable "x" in the formula at the right to calculate MTBF for this system configuration.</p>	$(1^3)x(109) = \text{MTBF hours}$



2. INSTALLING THE DX-80

Proper installation of the Comdial DX-80 is essential to assure optimum system operation. You must follow these procedures to reduce system problems resulting from improper installation and to reduce the potential of experiencing problems while bringing the DX-80 on-line.

2.1 Installation Overview

The following steps provide an overview of the installation process. Details on each of these steps are contained in the following sections of this chapter. Be sure to read the detailed instructions before installing the DX-80.

1. Plan the installation, including the KSU1 or KSU1 and KSU2 and Main Distribution Frame (MDF) location, station locations, cable runs, and optional equipment.
2. Assemble the correct tools and supplies: UTP telephony grade cable/wiring, miscellaneous telephony hardware, 66 blocks, modular wall jacks, etc.)
3. Run the wiring for speakerphones, DSS consoles and analog devices (FAX machines, modems, etc.) from the MDF to each location. Wiring topology is referred to as “star-wiring” configuration; no cable should loop from one telephone location to another.
4. Run cable/wiring to any optional equipment, such as external paging equipment, loud bell signaling devices, music sources, etc.
5. Mount the MDF backboard and attach the terminal blocks on the backboard. Use a dedicated MDF with 66 block wiring field to promote full serviceability of the system and connections using proven techniques. If you route extension cables into the KSU, you have to terminate one cable pair into standard crimping modular connectors for each cable.



	CAUTION	
<p>Although you can route the extension cable/wiring directly into the DX-80 KSU1/KSU2 housing and connect directly to the appropriate interface module (408M, DPM8, APM4, COM4, CPM), Comdial does not recommend this method since it makes it difficult to service the system.</p>		

6. Mount the KSUs on the MDF backboard, using the mounting template provided.
7. Ground the KSU1 (and KSU2 if applicable) to a known “good” earth ground.
8. Install optional expansion modules (COM4, DPM8, APM4) inside the KSU as required.
9. Install optional features modules (AAM, 7270C, 7271C, or MDM) inside the KSU as required.
10. Install the telephone instruments and any optional telephone equipment, such as headsets or single line telephones.

2.2 Site Planning



The first step in site planning is establishing suitable environmental conditions for the system.

1. Place KSU1, and KSU2 if applicable, within 5 feet (1.5 meters) of an isolated, dedicated, 105-125VAC, 57-63Hz, 15A, single-phase commercial power source.

	WARNING	
<p>This must be an isolated, dedicated AC circuit for proper operation. Run all three wires (power, neutral, and ground) separately from the outlet to the breaker panel, without being bonded to any other wire or circuit. Do not plug any other equipment into this outlet. To maintain the protection provided by the isolated, dedicated circuit, the length of the AC power cord limits the distance between the KSU and the outlet. Do not use an extension cord.</p>		



Note: To protect the system from lightning damage or other AC power line disturbances, install a surge protector.

2. Select the KSU location to minimize cable run length. Terminal equipment connected to the system must not exceed specified limits (see Section 1.15, *Specifications*).
3. The KSU location should not be exposed to direct sunlight, high humidity, heat, dust, or strong magnetic fields (such as those generated by heavy motors, copy machines and some kitchen appliances).

	CAUTION	
<p>The DX-80 system must be installed in a climate controlled environment. This equipment cannot function in environments above 95 degrees Fahrenheit ambient temperature.</p>		



4. The MDF should consist of a 3/4-inch plywood backboard large enough to mount all hardware and equipment allowing all components ample space for adequate ventilation and servicing. Allow additional room for external apparatus, if used.
5. For cooling purposes, ample air space (at least four inches on the top, bottom, left and right sides) must be provided for the KSU.
6. SMDR/SMDA output devices must be placed within 50 feet (15 meters) of the KSU (limited by RS-232C standard wiring practices).

The equipment should be located in a climate-controlled room adhering to the environmental specifications listed in Section 1.15.4, *Environmental Data*.

	CAUTION	
<p>When installing the KSU and station instruments, allow a sufficient margin for error in case of air conditioning failure, routine maintenance, plant shutdown, etc. As a general rule, if conditions are suitable for office personnel, they are also suitable for KSU and terminal equipment operation. A properly controlled environment will help to extend the operating life of the equipment.</p>		

The following statements are from **UL 1459**, a product safety specification governing telephone equipment:

- Never install telephone wiring during a lightning storm.
- Never install telephone jacks in wet locations unless the jack is specifically designed for wet locations.
- Never touch non-insulated telephone wires or terminals unless the telephone line has been disconnected at the network's interface.
- Use caution when installing or modifying telephone lines.

	CAUTION	
<p>Per Underwriters Laboratories regulation 1950, TNV wiring to outside plant leads (e.g. central office trunk wiring) must be 26 AWG gauge minimum.</p>		

2.3 Tools and Supplies

Assemble the correct supplies and tools to install the Comdial DX-80.

- Use UTP (Unshielded, Twisted-Pair) three or four pair (recommended) cable to run from the MDF to all extension terminals (DETs, DSS consoles, and analog devices). DETs only need one twisted pair to operate. Additional pairs are always recommended to allow for future potential uses.
- Six conductor modular jack assemblies for all station instruments (recommended).
- Standard punch-down terminal blocks (66M1-50 type) as required.
- Four or six conductor crimping modular plug assemblies for each port interface.
- AC voltage surge/spike protector.
- Standard telephone hand tools and mounting hardware for the KSU(s), MDF backboard, punch-down terminal block(s), modular jack assemblies for CO lines, etc.

2.4 Preparing the Main Distribution Frame

The MDF is the point at which the KSU, terminal equipment, CO lines, and miscellaneous equipment connect to one another. It is extremely important that you make the connections carefully and accurately.

2.4.1 ASSEMBLING THE MDF

Follow these steps to assemble the MDF.

1. Mount a sufficiently sized, 3/4-inch plywood backboard at the proper location to use as the MDF termination and equipment mounting board.
2. Plan the layout of all required MDF components allowing for expansion. This may include: KSU1, KSU2, 66M1-50 termination blocks, cable fastening hardware, and miscellaneous third-party communications equipment (paging equipment, etc.).
3. Locate the Telco-provided CO/Centrex lines at the DEMARC (Demarcation) and extend them to the MDF location.
4. Locate a suitable, known-good earth ground preferably within 10 feet of the MDF and route a **#10AWG grounding wiring** from the point of grounding to the MDF for connection to the KSU.
5. Install all telephone cabling and route to the MDF location for termination.
6. Mount all equipment and termination hardware as required to interconnect terminal devices and KSU modules.

2.4.2 KSU COMPONENTS AND INSTALLATION

The KSUs are shipped in their own protective master carton and contain the following components:

KSU1

- one mounting template
- standard 408M (module) equipped with eight digital extension ports, four CO line ports, and one CO line PFT (Power Failure Transfer) port
- standard CPM
- standard APM4
- system installation, maintenance, and programming manuals and system installation quick reference guide.

KSU2



- one mounting template
- standard expansion cabinet 408E (module) equipped with 8 digital extension ports, four CO line ports, and one CO line PFT port.

Open the cartons and verify that all items are complete and undamaged. Remove all packing material and store for future use in the event that return shipment is required.

2.4.3 MOUNTING THE KSU

Follow these instructions to mount the KSU.

1. Select a suitable location for the KSU1 considering that the expansion (KSU2) may be installed at the same time or sometime in the future. KSU1 and KSU2 may be mounted such that they are side-by-side or mounted one above the other.
2. Using the mounting template as a guide, mark the two mounting screws locations on the MDF backboard.
3. Pre-drill two screw holes and install the two, pan-head No. 10 screws (supplied) into the backboard with a regular screwdriver. The screw heads should protrude about 1/4-inch from the backboard plywood surface.
4. Lift the KSU over the two screws, allowing the screws to extend into the KSU slotted mounting holes. As the KSU is allowed to rest in place on the mounting screws it will slip over the screw shanks until the top of the slot is reached. Properly installed, the KSU power transformer (where the KSU AC power cord is located) is positioned in the upper left corner. The power switch and power/heartbeat LED are positioned at the left side of the KSU toward the bottom.



	CAUTION	
<p>It is very important that you mount the KSU correctly to allow proper power supply heat dissipation. KSU1 and KSU2 must be wall mounted only.</p>		

5. Ground the KSU. Extend the earth ground #10 wire into the KSU opening at the lower left corner of the KSU. Terminate the grounding wire onto the ground lug provided there.



ground lug



2.5 KSU Wiring

WARNING	
	
<p>System power must be OFF before you plug in the station cable or while servicing port connections at the punch-down block (66M1-50). Although each port is over-current protected, unnecessary shorting should be avoided.</p>	

The 408M/E, APM4, COM4, and DPM8 are equipped with RJ-11 modular jacks for each of the inter-faced ports. This connection scheme allows for two methods of installation. The first method (traditional “MDF”) is recommended whenever possible to allow for maximum serviceability.

2.5.1 MDF

Whenever you extend the various ports of the DX-80 to the MDF, you must extend modular-ended cables from the KSU module port to the MDF connection block. You have many choices when completing these connections; it is left to your discretion to use the most suitable industry-standard wiring practice for the particular installation.

CAUTION	
	
<p>Use a quality crimping tool to fasten the modular connector to the cable pair when using field-crimped modular connectors. Use of an inferior crimping tool can lead to bad connections.</p>	

Many third-party vendor products are available to aid in this installation procedure. The following examples are readily available at communications equipment / accessories supply houses. Although this example denotes product of The Siemon Company®, you are urged to investigate the various products available and make decisions for use based on your own assessment. Comdial is not responsible for the performance of any product provided by a third-party (outside) vendor.

The examples in the following chart are 25 pair (UTP), USOC, 24 AWG cables pre-fitted with modular connectors on one end of the cable, and a male or female AMP® type connectors on the other end for termination on a specially equipped, 66-block with mating AMP® type connector.

The Siemon Company® Hydra Cable Assemblies		
Product Number	Length (feet)	Wiring Scheme - End 1
HYD-F-24U1-03	3	25-Pair, Female
HYD-F-24U1-07	7	25-Pair, Female
HYD-F-24U1-10	10	25-Pair, Female
HYD-M-24U1-03	3	25-Pair, Male
HYD-M-24U1-07	7	25-Pair, Male
HYD-M-24U1-10	10	25-Pair, Male

When you are finished with the KSU wiring, you can individually isolate each port of the DX-80 system for independent maintenance needs. Terminate the wiring in place onto a 66M1-50 – connector block. Extend ports from this connector block to station cables using standard jumper wire.

2.5.2 NO MDF

Since the Comdial DX-80 is equipped with RJ-11 interfaces for all port connections, it is possible to route station cables into the KSU directly without use of 66M1-50 connector blocks. Using quality modular connectors and crimping tool, connect each terminal cable directly to the port required. Comdial does not recommend this method of installation, although it is initially convenient and less expensive, due to the inherent lack of serviceability.

Regardless of the method used, route the station / MDF cables out of the KSU through the opening at the lower left of the KSU housing. A cable restraint clamp is provided which you can use to secure cables exiting the KSU.



cable restraint clamp

2.6 Typical MDF Installation

The following example install illustrates a two-cabinet installation using the MDF installation method.

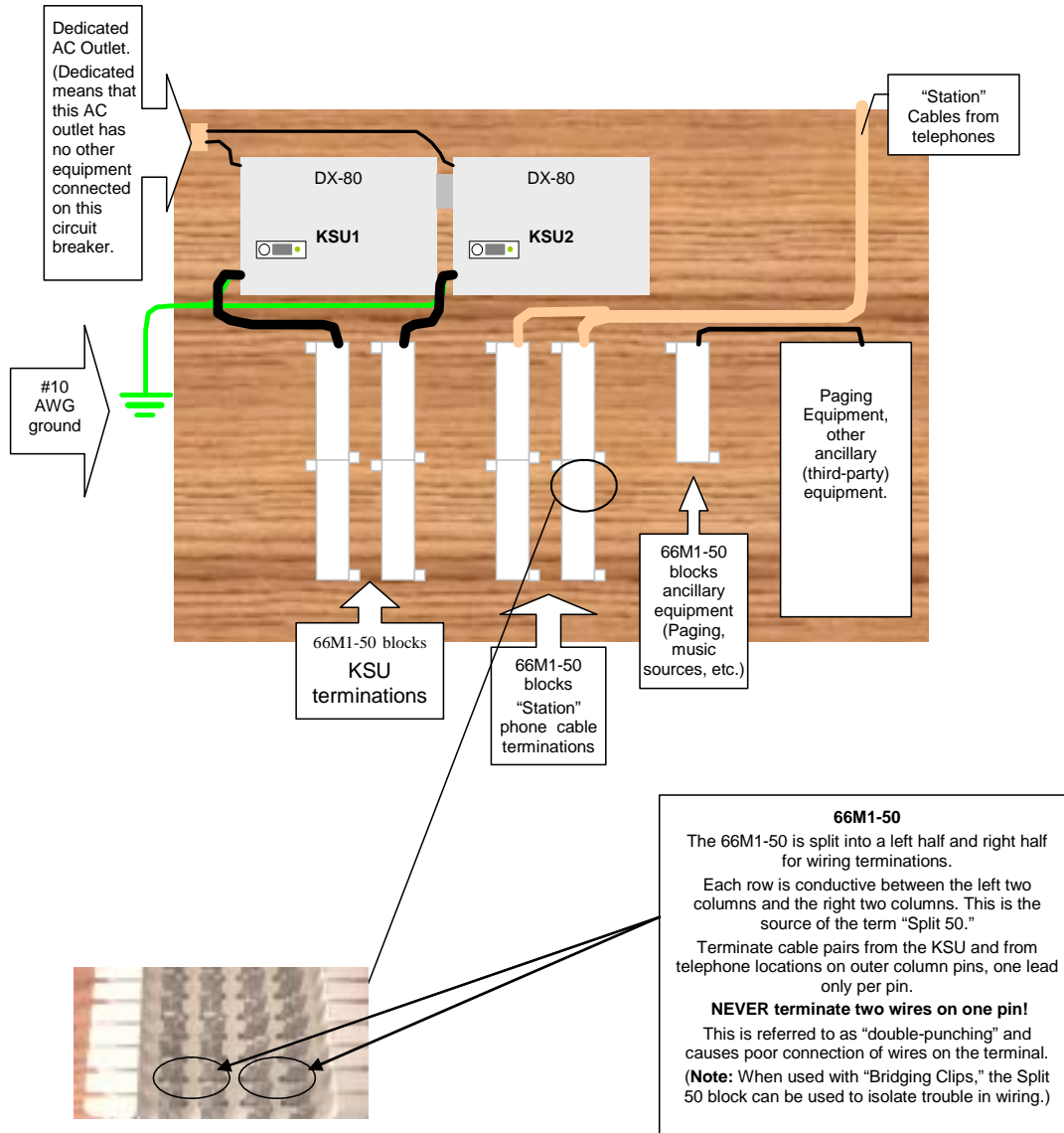

2.7 KSU Components

2.7.1 KSU1 408M AND KSU2 408E

The 408M module is installed at the factory into KSU1. Although this module has the same port configuration as the 408E, they are not interchangeable. Each 408M and 408E is equipped with four CO line ports, one power failure port, and eight digital extension Ports. See the following diagram to locate the various ports provided on the 408M/E.

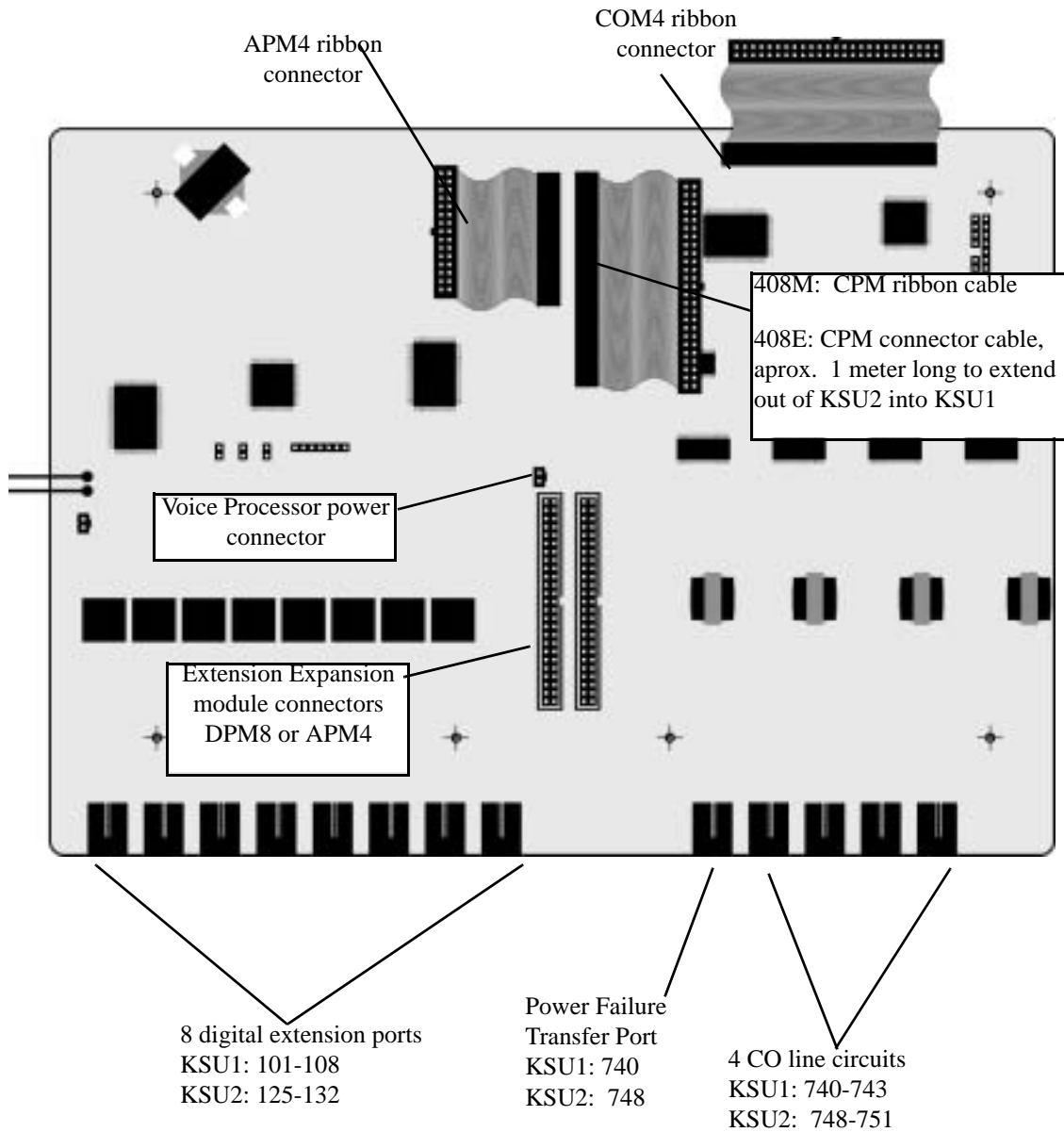

The 408M/E is also the interface point for the various add-on modules of the DX-80 system. All peripheral modules connect to the DX-80 via the 408M/E. See the following diagram for a reference to the various interface connectors.





2.7.2 REPLACING A 408M OR 408E

Occasionally, when instructed to do so by a Comdial technical support representative, you may have to remove a 408M or 408E and replace it in the field. To do so, use the following the steps.

1. Be sure that the entire system is turned off.
2. Remove the KSU cover (four screws at each corner).
3. Connect a static discharge wrist strap to a suitable earth ground. Be sure that the strap is touching bare skin.

	WARNING	
<p>Circuit boards are susceptible to damage caused by electrostatic discharge. You must keep this in mind as you handle the circuit boards. Refer to Comdial publication IMI01-005, <i>Handling of Electrostatically Sensitive Components</i>, for details.</p>		

4. Remove all circuit modules from the KSU cabinet. All modules are fastened in place using standoff hardware, therefore, be sure to reconstruct these stand off placements when you re-install the various modules. *Note: APM4 modules must be installed using 2.5 cm stand offs. These specific length standoffs are steel color for easy identification.*
5. Install the replacement 408M/E using the brass (1.5cm) standoffs removed from the original.
6. Install all other remaining modules in the order that they were removed, connecting them to the appropriate 408M/E connector.
7. Reconnect CO line and station cabling connections as required.

	CAUTION	
<p>The FCC requires that wiring of CO lines into a KSU be separated from wiring of station apparatus into a KSU. Therefore you must use separate cables for wiring stations and CO lines.</p>		

8. Replace the KSU cover and secure with cover screws.
9. Restore KSU power when all wiring is complete.

2.7.3 KSU ASSEMBLY – ADD-ON MODULES

Whenever you expand the DX-80 system, you install a module into one of the KSU cabinets. Modules are connected to the various connectors on the 408M/E. Modules are mounted using standoff posts. Two standoff post sizes are used in the DX-80. The APM4 modules must be installed using the nickel color 2.5 cm standoffs. All other modules use brass color 1.5 cm standoffs. Proper use of standoff is imperative to assure proper system operation.

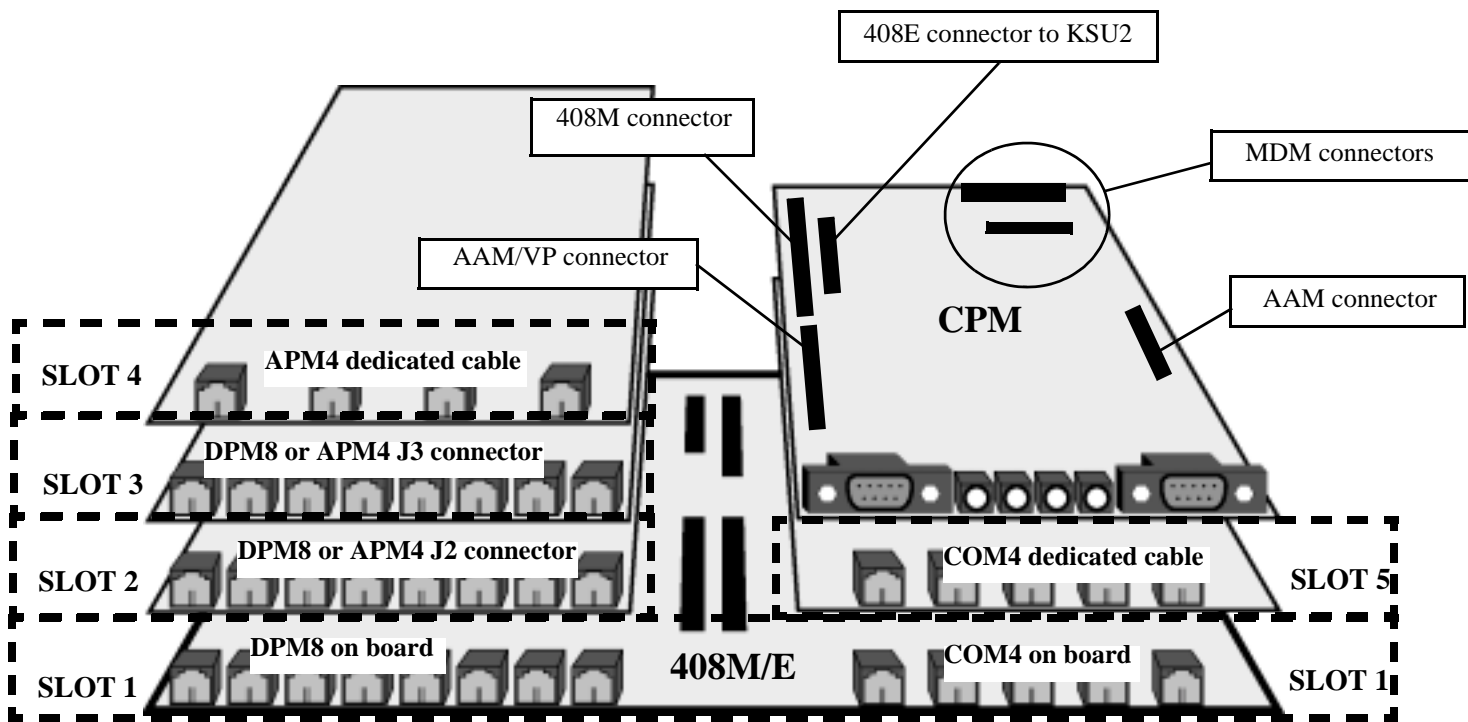

2.7.4 ADDING A DPM8

You can add two DPM8 modules to each KSU of the DX-80 system. These modules expand the DX-80 system capacity to a maximum of 24 digital ports in each KSU, for a total of 48 total digital ports.



To install a DPM8, connection to the 408M/E via the Extension Expansion module connectors J2 and J3. These connectors have the logical system address of SLOT 2 and SLOT 3 in both cabinet 1 (KSU1-408M) and cabinet 2 (KSU2-408E). *Note: You can connect both APM4 and DPM8 modules to the system via these two connectors.* Install the DPM8 using four 1.5 cm brass color standoffs included with the DPM8 module.

DPM8 Extension Number Matrix Per Installed Location		
KSU Connector Used	Extension Numbers in KSU1	Extension Numbers in KSU2
J2 Extension Expansion	109,110,111,112, 113,114,115,116	133,134,135,136, 137,138,139,140
J3 Extension Expansion	117,118,119,120, 121,122,123,124	141,142,143,144, 145,146,147,148

To install the DPM8 perform the following steps.

1. Be sure that the entire system is turned off.
2. Remove the KSU cover (four screws at each corner).



3. Connect a static discharge wrist strap to a suitable earth ground. Be sure that the strap is touching bare skin.

	WARNING	
<p>Circuit boards are susceptible to damage caused by electrostatic discharge. You must keep this in mind as you handle the circuit boards. Refer to Comdial publication IMI01-005, <i>Handling of Electrostatically Sensitive Components</i>, for details.</p>		

4. Remove the DPM8 module from the packaging and locate the four brass-color standoffs packaged with the module.
5. Position the DPM8 over the left-hand side of the 408M/E and any other extension modules already installed.

When installing DPM8 modules, Comdial recommends that you install them closest to the 408M/E. That is, if an APM4 module is installed move it outward (toward cabinet cover) and install the add-on DPM8 first, then re-install the APM4. In the KSU extension modules are always installed on the left-hand side.

6. Use the four brass-color standoffs supplied with the DPM8 to secure the DPM8 in position.
7. Connect the DPM8 ribbon cable to the 408M Extension Expansion Module Connector closest to the DPM8. Press firmly (but not forcefully) on the connector to secure a good connection.
8. Make connections to the eight digital ports as required.

	CAUTION	
<p>The FCC requires that wiring of CO lines into a KSU be separated from wiring of station apparatus into a KSU. Therefore you must use separate cables for wiring stations and CO lines.</p>		

9. Replace the KSU cover and secure with cover screws.
10. Restore KSU power.

2.8 Adding an APM4

You can add one APM4 to KSU1 and two APM4's to the KSU2. These modules expand the DX-80 system capacity to a maximum of eight analog ports in each KSU (16 total analog ports when used in both KSU1 & KSU2).

When adding an APM4 to KSU1, connect to the 408M via an available Extension Expansion module connector (either "J2" or "J3" but not both). These connectors have the logical system address of SLOT 2 and SLOT 3 in both cabinet 1 (KSU1-408M) and cabinet 2 (KSU2-408E). APM4's are installed using four 2.5 cm nickel-color standoffs.

When adding APM4 modules to KSU2, you can install one on either of the Extension Expansion module connectors, and one on the dedicated APM4 module connector. This connector has the logical system address of SLOT 4 in both cabinet 1 (KSU1-408M) and cabinet 2 (KSU2-408E).

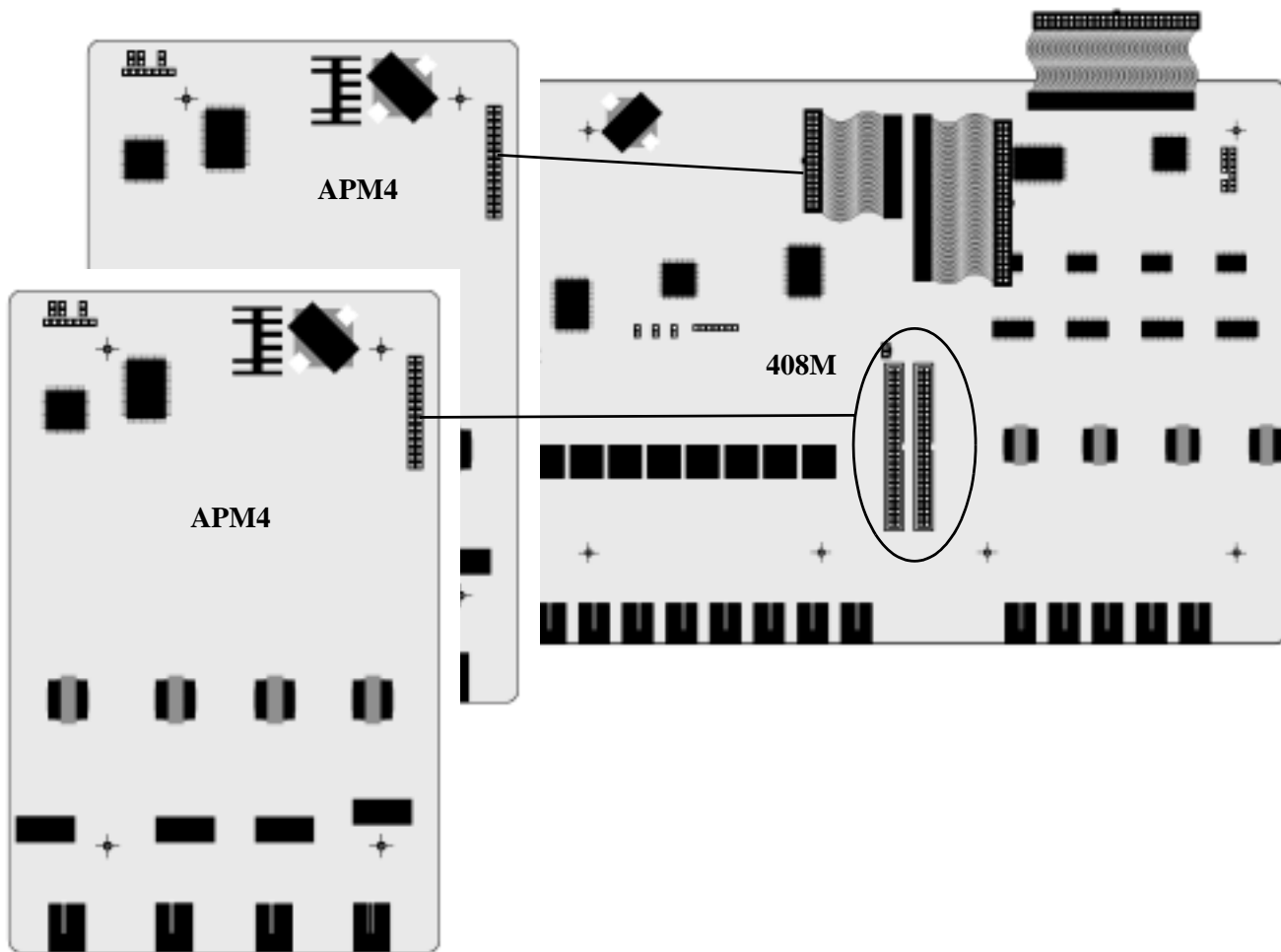



Extension Number Matrix Per Installed Location			
KSU Connector used	Extension numbers in KSU1	Extension Numbers in KSU2	Notes
APM4 Connector (SLOT 4)	149,150,151,152	153,154,155,156	KSU1 analog ports are standard
J2 Extension Expansion (SLOT 2)	109,110,111,112	133,134,135,136	Since the profile of the APM4 module is higher than the other modules, only one Extension Expansion connector can be used for APM4 modules.
J3 Extension Expansion (SLOT 3)	117,118,119,120	141,142,143,144	



To install the APM4 perform the following steps.

1. Be sure that the entire system is turned off.
2. Remove the KSU cover (four screws at each corner).

3. Connect a static discharge wrist strap to a suitable earth ground. Be sure that the strap is touching bare skin.

	WARNING	
<p>Circuit boards are susceptible to damage caused by electrostatic discharge. You must keep this in mind as you handle the circuit boards. Refer to Comdial publication IMI01-005, <i>Handling of Electrostatically Sensitive Components</i>, for details.</p>		

4. Remove the APM4 module from the packaging and locate the four nickel-color standoffs packaged with the module.
5. Position the APM4 over the left-hand side of the 408M/E and any other extension modules already installed. **Note:** *In the KSU, extension modules are always installed on the left-hand side.*
6. Use the four nickel-color standoffs supplied with the APM4 to secure the APM4 in position.
7. Connect the APM4 ribbon cable to the 408M/E Extension Expansion Module Connector closest to the APM4. Or in KSU2, connect the dedicated APM4 ribbon cable from the 408E to the APM4 module (and discard the packaged ribbon cable). Press firmly (but not forcefully) on the connector to secure a good connection.
8. Make cable/wiring connections to the 4 analog ports as required.

	CAUTION	
<p>The FCC requires that wiring of CO lines into a KSU be separated from wiring of station apparatus into a KSU. Therefore you must use separate cables for wiring stations and CO lines.</p>		

9. Replace the KSU cover and secure with cover screws.
10. Restore KSU power.

2.9 Adding a COM4

You can add one COM4 to KSU1 and one COM4 to the KSU2. These modules expand the DX-80 system CO line interface capacity to a maximum of eight CO line ports in each KSU (16 total CO line ports when used in KSU 1 & 2).

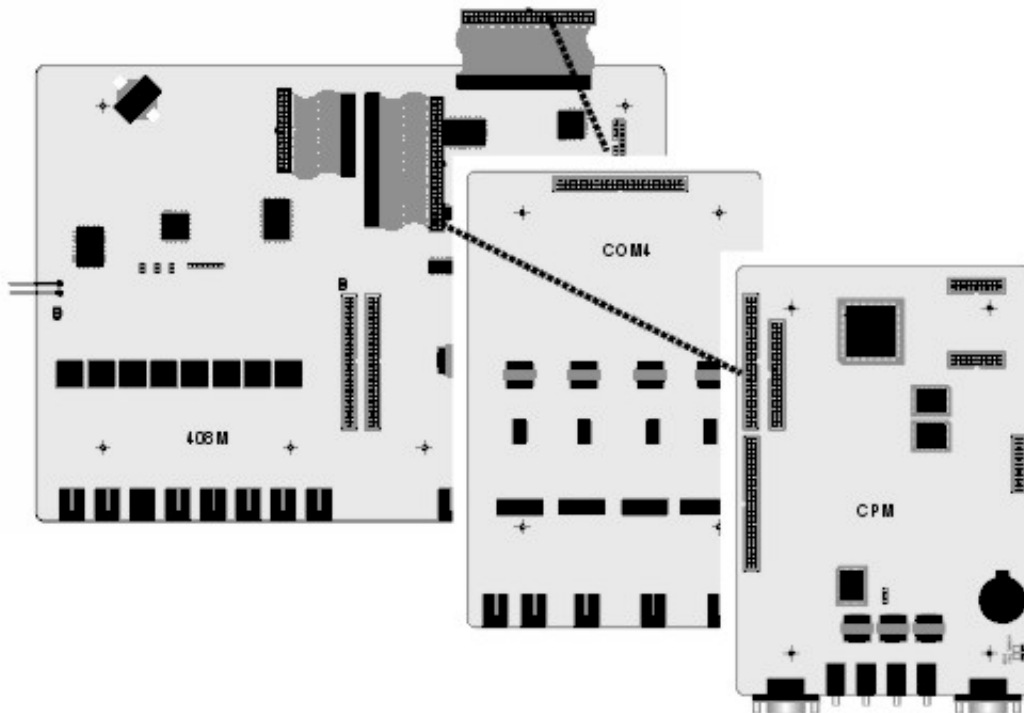

When adding a COM4 to either KSU, connect to the 408M/E via the COM4 module ribbon cable. This ribbon cable has the logical system address of SLOT 5 in both cabinet 1 (KSU1-408M) and cabinet 2 (KSU2-408E). COM4 modules are installed using four 1.5 cm brass-color standoffs. Always install the COM4 module beneath the CPM module (in KSU1) by first removing the CPM, installing the COM4, and then re-installing the CPM. This is required whenever you install the In-Skin Voice Processor.





CO Line Directory Number Matrix Per Installed Location			
408M in KSU1 SLOT 1	COM4 in KSU1 SLOT 5	408E in KSU2 SLOT 1	COM4 in KSU2 SLOT 5
740,741,742,743	744,745,746,747	748,749,750,751	752,753,754,755

To install the COM4 perform the following steps.

1. Be sure that the entire system is turned off.
2. Remove the KSU cover (four screws at each corner).
3. Connect a static discharge wrist strap to a suitable earth ground. Be sure that the strap is touching bare skin.

	WARNING	
<p>Circuit boards are susceptible to damage caused by electrostatic discharge. You must keep this in mind as you handle the circuit boards. Refer to Comdial publication IMI01-005, <i>Handling of Electrostatically Sensitive Components</i>, for details.</p>		

4. Comdial recommends installing the COM4 closest to the 408M/E. This means you must temporarily remove the CPM and then reposition the CPM above the COM4 once you have installed the COM4 (in KSU1). For KSU2 installation skip step 5 and proceed with step 6.
5. Remove the installed CPM by removing the four brass standoffs used to secure the board, retaining these standoffs for later use. Remove the ribbon cable that connects the CPM to the 408M then set it aside.
6. Remove the COM4 module from the packaging and locate the four brass-color standoffs packaged with the module.
7. Position the COM4 over the 408M/E (right-hand side) where you just removed the CPM (KSU1).
8. Use the four brass-color standoffs supplied with the COM4 to secure the COM4 in position.
9. Connect the COM4 ribbon cable from the 408M/E to the COM4 connector. Press firmly (but not forcefully) on the connector to secure a good connection. For KSU2 installation, skip step 10 and proceed to step 11.
10. Reposition the CPM over the installed COM4 and secure using the four brass-color standoffs removed in step 4.
11. Make cable/wiring connections to the 4 CO line ports as required.

	CAUTION	
<p>The FCC requires that wiring of CO lines into a KSU be separated from wiring of station apparatus into a KSU. Therefore you must use separate cables for wiring stations and CO lines.</p>		

12. Replace the KSU cover and secure with cover screws.
13. Restore KSU power.

2.10 Adding an MDM



You can add one MDM to KSU1. The MDM allows you to remotely access to the DX-80 database programming and maintenance functions using PC-DBA. **Note:** *The MDM does not provide access to the DX-80 In-Skin Voice Mail/AA.*

At default the MDM directory number is 199. To establish a connection to the MDM remotely, call into the system where the MDM is installed from the remote site using PC-DBA. Ask to be transferred to extension 199. When you hear the modem tone, initiate any required keystrokes to link the modems. Then proceed with usual PC-DBA connection routines. **Note:** *If you are using In-skin voicemail or AA a manual transfer is not necessary.*

Install the MDM onto designated connectors located on the CPM.

To install the MDM perform the following steps.

1. Be sure that the entire system (KSU 1&2) is turned off.
2. Remove the KSU cover (four screws at each corner).
3. Connect a static discharge wrist strap to a suitable earth ground. Be sure that the strap is touching bare skin.

WARNING	
	Circuit boards are susceptible to damage caused by electrostatic discharge. You must keep this in mind as you handle the circuit boards. Refer to Comdial publication IMI01-005, <i>Handling of Electrostatically Sensitive Components</i> , for details.
	

4. Locate the CPM at the right-hand side of KSU1, above the 408M (and COM4 if installed).
5. Position the MDM over the CPM-MDM connectors as illustrated in the following diagram.

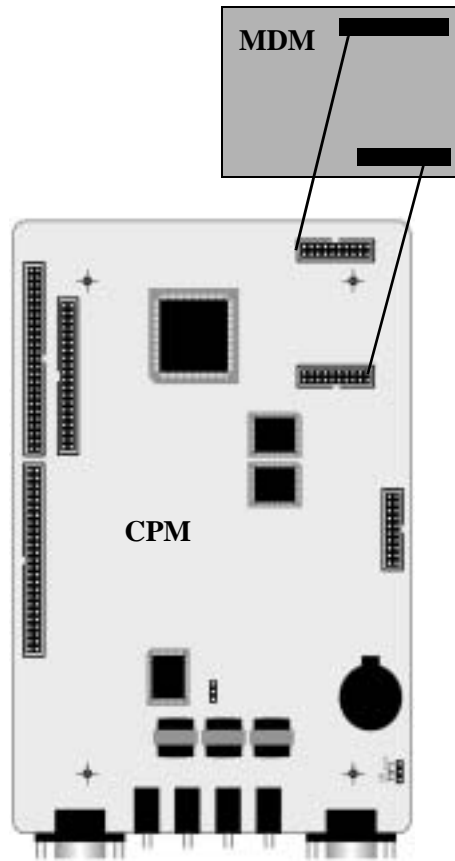

6. Press firmly (but not forcefully) on the MDM to secure a good connection into the CPM-MDM connectors.
7. Replace the KSU cover and secure with cover screws.
8. Restore KSU power.

2.11 Adding an AAM

You can add one AAM to the KSU1. The AA Module adds automated attendant functionality to the DX-80 system with 10 integrated announcements. **The AAM does not provide voice mail functions.**

For details on how to program the AAM and its announcements, refer to the *DX-80 Technical Manual, Volume II, Programming*.

Install the AAM onto designated connectors located on the CPM.

To install the AAM perform the following steps.

1. Be sure that the entire system is turned off.
2. Remove the KSU cover (four screws at each corner).
3. Connect a static discharge wrist strap to a suitable earth ground. Be sure that the strap is touching bare skin.

WARNING

⚠ Circuit boards are susceptible to damage caused by electrostatic discharge. You must keep this in mind as you handle the circuit boards. Refer to Comdial publication IMI01-005, *Handling of Electrostatically Sensitive Components*, for details. ⚠

4. Locate the CPM at the right-hand side of KSU1 above the 408M (and COM4 if installed).
5. Position the AAM over the CPM-AAM connectors as illustrated in the following diagram.

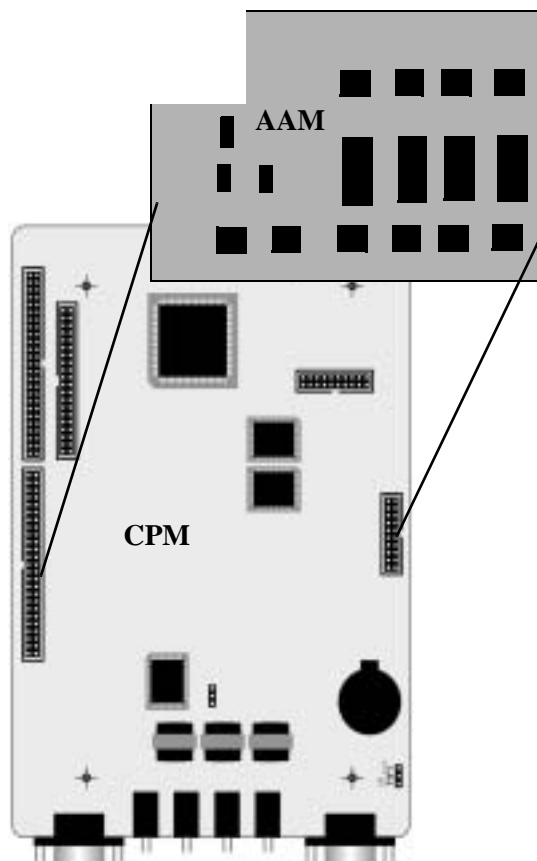

6. Press firmly (but not forcefully) on the AAM to secure a good connection into the CPM-AAM connectors.
7. Replace KSU cover and secure with cover screws.
8. Restore KSU power.

2.12 Adding a KSU2 Second Cabinet



You can add one KSU2 to a KSU1. The KSU2 adds:

- eight digital DX-80 extension ports
- four CO line ports
- one Power Failure Transfer port
- Extension Expansion connectors for two additional DPM8s or one APM4
- Ribbon cable for one APM4
- Ribbon cable for one COM4

Connect the KSU2 to the KSU1 via a designated connector located on the CPM inside the KSU1.

To install the KSU2 perform the following steps.



1. Be sure that the entire system is turned off.
2. Remove the KSU cover (four screws at each corner) on both KSU1 and KSU2.
3. Connect a static discharge wrist strap to a suitable earth ground. Be sure that the strap is touching bare skin.

	WARNING	
<p>Circuit boards are susceptible to damage caused by electrostatic discharge. You must keep this in mind as you handle the circuit boards. Refer to Comdial publication IMI01-005, <i>Handling of Electrostatically Sensitive Components</i>, for details.</p>		

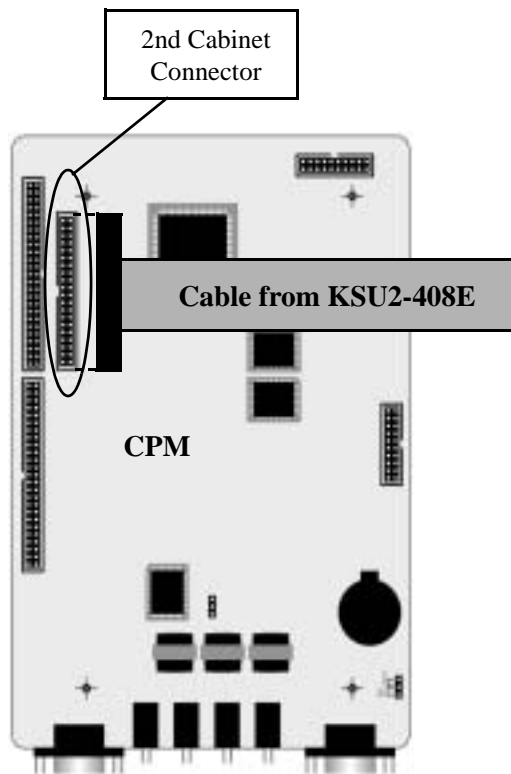
4. Locate the long cable attached to the 408E of KSU2, and route it out of the KSU2 cabinet into the KSU1 cabinet so you can connect it to the CPM.
5. Locate the CPM at the right-hand side of KSU1 above the 408M (and COM4 if installed).
6. Position the KSU2 connection cable over the CPM-“2nd Cabinet Connector” as illustrated in the following diagram.



7. Press firmly (but not forcefully) on the KSU2-Cable connector to secure a good connection into the CPM-2nd Cabinet Connector.
8. Replace the KSU cover and secure with cover screws.
9. Restore KSU power by powering both KSU cabinets at the same time. Operate both cabinet power switches to the "ON" position simultaneously.

	WARNING	
You must turn on both cabinets at the same time. Failure to do so can result in damage to the KSU1 and potentially the KSU2.		

2.13 Adding a Music Source

You can connect two sources of music to the CPM for use with the Music On Hold and Background Music features.

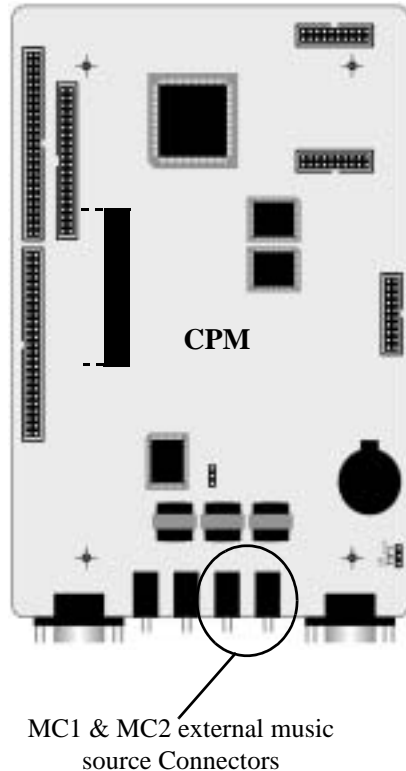



A third option is to use an internal musical tune or tone can be used for callers on hold. If you use this option is used, the MC1 connector is not used.

2.13.1 SELECTING INTERNAL MUSIC TUNE FOR MUSIC CHANNEL MC1

1. Remove the KSU cover (four screws at each corner) of KSU1.
2. Connect a static discharge wrist strap to a suitable earth ground. Be sure that the strap is touching bare skin.



WARNING

 Circuit boards are susceptible to damage caused by electrostatic discharge. You must keep this in mind as you handle the circuit boards. Refer to Comdial publication IMI01-005, *Handling of Electrostatically Sensitive Components*, for details. 

3. Locate the CPM and “MUSIC” option strap.
4. Move the “MUSIC” option strap (JP30) from the “EXT” (factory position) to the “INT” position.

2.13.2 INSTALLING EXTERNAL MUSIC SOURCE TO MC1/MC2/BOTH

1. Remove the KSU cover (four screws at each corner) of KSU1.
2. Connect a static discharge wrist strap to a suitable earth ground. Be sure that the strap is touching bare skin.

	WARNING	
<p>Circuit boards are susceptible to damage caused by electrostatic discharge. You must keep this in mind as you handle the circuit boards. Refer to Comdial publication IMI01-005, <i>Handling of Electrostatically Sensitive Components</i>, for details.</p>		

3. Locate the CPM and the “MUSIC” option strap.
4. Make sure that the “MUSIC” option strap is in the “EXT” position. (Required for external source to operate on MC1.)
5. Locate CPM the “MC1” and “MC2” connector jacks on the CPM.
6. Using an eighth-inch mini plug, connect the output of the external music source to the appropriate MC1 or 2 connector. (At default MC1 is used for Music On Hold.) This is easily accomplished using a prefabricated mini-plug to mini-plug cable available at Radio Shack.



7. Adjust the music volume level at the external music source. When adjusting the music for Music On Hold, place a call into the system on one of the CO Lines. Place this call on hold so that the external music source is heard by the calling party (you). Adjust the volume level of the external music source until a desirable level is reached. (Background Music is then adjusted at the telephone using the instrument volume control.)

2.14 Adding an External Pager

One port is provided at the CPM of the DX-80 system for use with external paging system apparatus. When DX-80 users dial the external pager code (“777” at default) or dial the Tenant Group All Page code (“400” at default), voice announcements can be made over the external paging equipment.

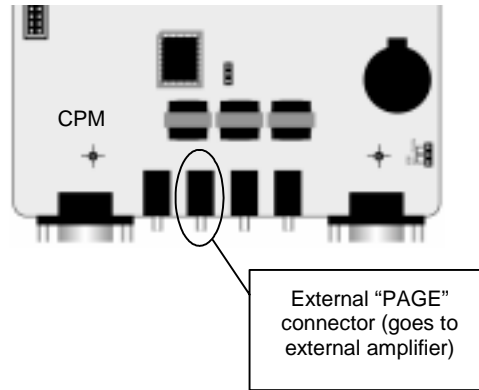

The DX-80 External Page port does not provide any amplification. Interface at the amplifier should be matched to approximately 600 ohms for the best performance.

2.14.1 EXTERNAL PAGER INSTALLATION PROCEDURE

1. Remove the KSU cover (four screws at each corner) of KSU1.
2. Connect a static discharge wrist strap to a suitable earth ground. Be sure that the strap is touching bare skin.

WARNING

⚠ Circuit boards are susceptible to damage caused by electrostatic discharge. You must keep this in mind as you handle the circuit boards. Refer to Comdial publication IMI01-005, *Handling of Electrostatically Sensitive Components*, for details. ⚠

3. Locate the CPM and “PAGE” connector jack on the CPM.
4. Using an eighth-inch mini plug, connect the DX-80 Page port to the external amplifier input.
5. Adjust the voice volume level at the external paging amplifier. When adjusting the volume level, dial access to the External Pager port at any DX-80 telephone (“777”). Then adjust the volume control associated to the amplifier input selected for this purpose.

2.15 Adding Loud Bell Control or Gate Control

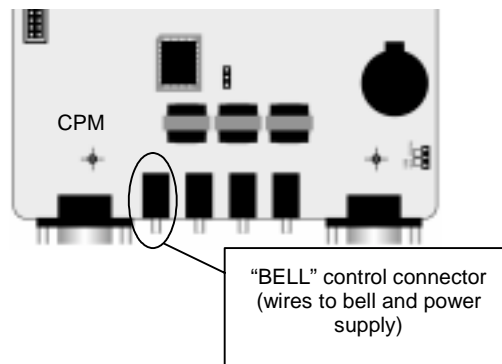



One “dry-connection” is provided at the CPM of the DX-80 system for use with external ringing devices or door opening apparatus. The DX-80 can be programmed to activate the dry contact whenever certain CO lines ring or whenever the LBC code is dialed to actuate a door opener.

2.15.1 LOUD RINGING BELL INSTALLATION PROCEDURE

1. Remove the KSU cover (four screws at each corner) of KSU1.
2. Connect a static discharge wrist strap to a suitable earth ground. Be sure that the strap is touching bare skin.

WARNING

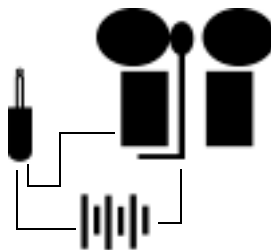

 Circuit boards are susceptible to damage caused by electrostatic discharge. You must keep this in mind as you handle the circuit boards. Refer to Comdial publication IMI01-005, *Handling of Electrostatically Sensitive Components*, for details.
 

3. Locate the CPM and “BELL” connector jack on the CPM.
4. Using an eighth-inch mini plug, wire the DX-80 BELL contact in series with an external 24vdc power supply and 24vdc bell or ringing device. **Important: Use only 24v or less voltage supply and Direct Current (dc).**
5. Program LBC operation for CO line ringing according to CO line group assignments. See the *DX-80 Technical Manual, Volume II, Programming* for details on programming.



To control a gate or door:

1. Remove the KSU cover (four screws at each corner) of KSU1.
2. Connect a static discharge wrist strap to a suitable earth ground. Be sure that the strap is touching bare skin.

WARNING	
	Circuit boards are susceptible to damage caused by electrostatic discharge. You must keep this in mind as you handle the circuit boards. Refer to Comdial publication IMI01-005, <i>Handling of Electrostatically Sensitive Components</i> , for details.
	

3. Locate the CPM and “BELL” connector jack on the CPM.

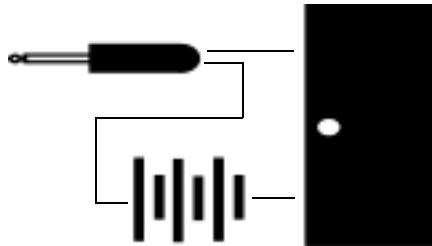

4. Using an eighth-inch mini plug, wire the DX-80 BELL contact in series with an external 24vdc power supply and 24vdc door opening device. **Important: Use only 24v or less voltage supply and Direct Current (dc).**
5. Program LBC operation for External Page operation. Door/Gate operation is accomplished by dialing the External Page code (this code can be programmed onto an available Flexible Feature Button). For details on programming, refer to the *DX-80 Technical Manual, Volume II, Programming*.

2.16 Connecting a Serial Cable for PC-DBA

You can connect PC-DBA to the to DX-80 system to set up the programable features and system operations. This connection is rarely permanent and is typically performed only during routine systems database updates and changes by a qualified technician. Connection of the PC to the DX-80 is accomplished through the serial data port on the CPM labeled “PCDBA.” Connection is simplified by means of a straight-through, 9-pin, female to male, serial cable. (Use Radio Shack model 26-117B for good results.)

Connection to the PC is made via an available 9-pin serial port connector that is designated as COM1 or COM2 in the PC configuration.

Once the cable is linked between the PC and the DX-80 CPM PCDBA port, you can use PC-DBA to program the DX-80 system and to back up your customer’s database.

Follow these steps to connect a serial cable for PC-DBA:

1. Remove the KSU cover (four screws at each corner) of KSU1.
2. Connect a static discharge wrist strap to a suitable earth ground. Be sure that the strap is touching bare skin.

WARNING

⚠ Circuit boards are susceptible to damage caused by electrostatic discharge. You must keep this in mind as you handle the circuit boards. Refer to Comdial publication IMI01-005, *Handling of Electrostatically Sensitive Components*, for details. ⚠

3. Locate the CPM and "PCDBA" serial port on the CPM.

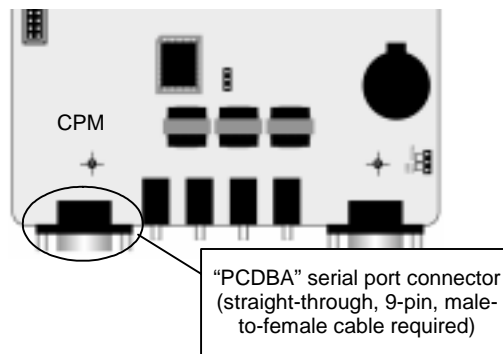

4. Connect the male end of the 9-pin serial cable into this PCDBA port.
5. Connect the other end (female) of the 9-pin serial cable to the PC serial port to be used with PC-DBA.
6. For information on how to program the DX-80 using PC-DBA, refer to the *DX-80 Technical Manual, Volume II, Programming*.

2.17 Connecting a Serial Cable for SMDR

SMDR (Station Message Detail Recording) can be output from the DX-80 system for use with serial printers of collection in call accounting devices. Connection of the SMDR device to the DX-80 is accomplished through the serial data port on the CPM labeled “SMDR.” Connection to serial printers may require customization of the serial cable used to make the connection.

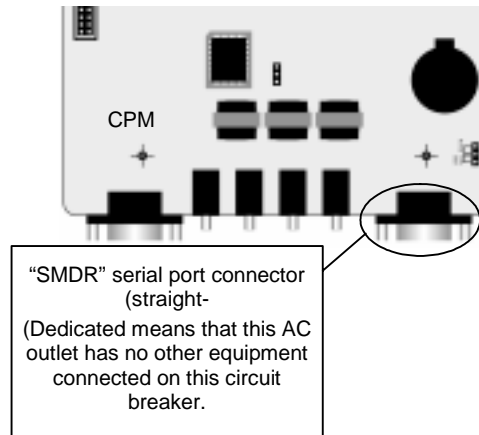

Whenever a call accounting system (third-party device) is deployed, connection is often no more complicated than using a straight-through, 9-pin, female to male, serial cable. (Use Radio Shack model 26-117B for good results.)



Connection to the PC/call accounting system is made via an available 9-pin serial port connector that is designated as COM1 or COM2 in the PC configuration.

Once the cable is linked between the collection device and the DX-80 CPM-SMDR port, the collection device must be programmed for compatible link protocol (baud rate). At default the SMDR port baud rate is set at 9600 bps.

SMDR 9-pin Serial Cable Pin Designations								
1	2	3	4	5	6	7	8	9
DCD	RXD	TXD	DTR	GND	DSR	RTS	CTS	RI

Follow these steps to connect a serial cable for SMDR:

1. Remove the KSU cover (four screws at each corner) of KSU1.
2. Connect a static discharge wrist strap to a suitable earth ground. Be sure that the strap is touching bare skin.

	WARNING	
<p>Circuit boards are susceptible to damage caused by electrostatic discharge. You must keep this in mind as you handle the circuit boards. Refer to Comdial publication IMI01-005, <i>Handling of Electrostatically Sensitive Components</i>, for details.</p>		

3. Locate the CPM and “SMDR” serial port on the CPM.
4. Connect the male end of the 9-pin serial cable into this SMDR port.
5. Connect the other end (female) of the 9-pin serial cable to the PC/collection device serial port.
6. Replace the KSU cover.



2.18 Power-up Initialization (Cold Start)

Proper operation of the DX-80 system requires that the system be initialized at the time of start up. **The installation of the DX-80 is complete only when this critical operation is performed.** Occasionally it may be required to perform this initialization process after the original installation, but this is rare.

Initialization causes the operational customer database to be established and organized for system operation and future updating. At the time this procedure is complete the default database contents are loaded into operational memory. The system is ready to run on this database configuration. Customized changes may be made to this database according to the allowable program settings for the various features. *Note: If you are performing a cold start on a system with an existing customized database, be sure to back up that database prior to beginning the cold start procedure. The cold start procedure forces the default database into the DX-80 switch, overwriting any existing database residing on that switch. For more details on backing up databases, see the DX-80 Technical Manual, Volume II, Programming.*

To initialize the DX-80, perform the following steps.

1. If you have previously plugged in the power cords and/or turned on the power supplies, turn OFF the power supply to the DX-80 KSUs and un-plug the DX-80 AC power cords on KSU1 and KSU2.
2. Remove the KSU cover (four screws at each corner) of KSU1 and KSU2 (if adding optional modules).
3. Connect a static discharge wrist strap to a suitable earth ground. Be sure that the strap is touching bare skin.

	WARNING	
<p>Circuit boards are susceptible to damage caused by electrostatic discharge. You must keep this in mind as you handle the circuit boards. Refer to Comdial publication IMI01-005, <i>Handling of Electrostatically Sensitive Components</i>, for details.</p>		

4. Locate the CPM and “NORMAL/COLD START” option strap on the CPM (J11).

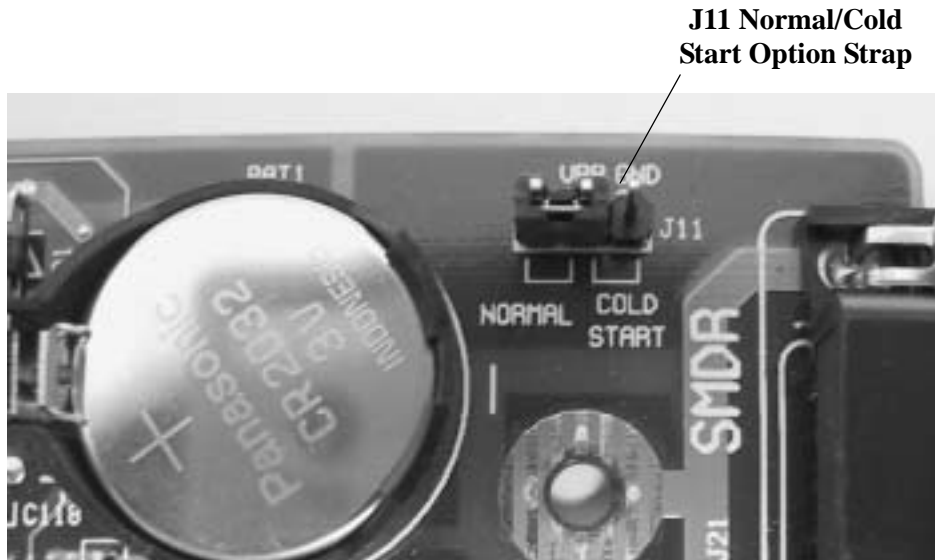

5. Move this strap to the “COLD START” position and allow it to remain in this position for 5 seconds. **Note:** New systems are shipped with this strap in the “COLD START” position, so if you are installing a new system you can skip this step.

CAUTION

⚠ This procedure overwrites all customized customer programming. If you want to maintain customized programming, be sure to back up the custom database prior to performing the cold start. For more details, refer to the *DX-80 Technical Manual, Volume II, Programming.* ⚠



6. Move the strap to the “NORMAL” position.

CAUTION

⚠ Comdial ships the DX-80 with the option strap in the COLD START position to preserve the battery while the system is in transit. However, you **MUST** move this strap to NORMAL for the DX-80 to begin normal operation. The system specifically monitors the position of this strap and shuts down operation if it remains in the COLD START position. ⚠

7. Install all optional expansion modules (COM4, DPM8, APM4) inside the KSU as required.

8. Plug the AC power cords into a dedicated, non-switching UPS.

	WARNING	
Only a qualified telephony technician should perform this procedure since hazardous voltages are present inside the KSU cabinets.		
DO NOT TOUCH exposed terminals or fuse connections at or around the power supply and fuse area while the system is powered and the KSU cabinet cover is removed!		

9. Turn on the power supply to the DX-80 KSUs by simultaneously moving the ON/OFF switch to the ON position on KSU1 and KSU2 (if two cabinets are installed)
10. Observe the LED on the CPM (at the left side of the module). The LED should begin to flash.
11. The LED located at the ON/OFF button of the KSU follows the operation of the LED on the 408M. Both of these LEDs indicate the operation of the peripheral processors on the 408M, and should be flashing in unison.
12. The LED on the APM4 will also begin to flash indicating that its peripheral processor is running.
13. As the main CPU comes on-line it will detect the Cold Start status of a specially blocked memory address. Once this is detected, the system forces default data into operational memory.
Note: This procedure overwrites all customized customer programming.
While the system is detecting and force-loading data, it flashes the CPM LED at various fast rates, and then stabilizes the LED again at a consistent rhythmic rate. When the LED reaches this consistent rate, the system has finished initiation and is operational. The default data is loaded and ready, and the telephones should be functional. In this status, all CO lines will ring at extension 101, all extensions may take and place calls, and all systems features are operational per their default configuration.
14. You can now begin customizing the database to meet your customer's specific site needs. For details, refer to the *DX-80 Technical Manual, Volume II, Programming*.

This Page Intentionally Left Blank

3. MAINTENANCE AND TROUBLE SHOOTING

3.1 System Maintenance

Maintaining the Comdial DX-80 digital telephone system is a combination of customer database changes, facilities and apparatus moves, adds and changes. These requirements are accomplished by practicing the techniques, illustrations and step-by-step instructions listed in the previous sections of this manual.

When properly installed, the Comdial DX-80 is relatively maintenance-free. From time to time the digital telephone instruments may become dirty or dusty and require cleaning. We suggest the use of a clean, dry cotton (or other soft, absorbent) cloth to wipe the instrument clean. The use of chemicals to clean the telephone plastics is NOT recommended since some chemicals can cause permanent damage to the telephone finish. If deep soiling conditions exist, many specialized telephone cleaning solutions will provide satisfactory results. When trying any cleaner for the first time, apply the cleaner to a small sample area on the underside of the instrument. If the expected results are achieved, proceed with cleaning the remainder of the telephone.

3.2 Technical Problem Solving

The system trouble shooting procedures are a logical approach to fault identification, analysis, and correction. The DX-80 may generate symptoms of problems that actually occur outside of the office environment. Problems such as system restarts (from temporary AC power interruption), fading (from the long distance carrier), or dropped calls (caused by internal users randomly pressing holding CO line buttons) all are common situations that are not the result of a system component or software failure.

This section attempts to provide you with some quick, and reliable, tools to diagnose service-related problem reports. For installation-related problems, see Section 4, *Troubleshooting Installation Issues*.

Symptom(s)	Diagnostic Aid	Cause(s)	Action
No system operation. No LED or LCD operation Digital Executive Telephones. No dial tone at IST's.	CPU Heartbeat LED Dark	No AC input	1. Check commercial AC outlet. 2. Verify that both ends of AC cord are plugged in.
		Power Switch	Switch the KSU AC power switch to the "ON" position.
		AC Fuse	Switch KSU power to the OFF position and remove cover (four screws). Locate the system power supply in the upper left corner of the KSU interior and inspect the AC fuse for continuity (DVM required).
		DC Fuse	Switch KSU power to the OFF position and remove cover (four screws). Locate the system power supply in the upper left corner of the KSU interior and inspect the DC fuse for continuity (DVM required).

Symptom(s) (Continued)	Diagnostic Aid	Cause(s)	Action
No system operation.	CPU Heartbeat LED Dark or Lit steady	Memory strap in "Cold Start" position	If the memory strap is in the "Cold Start" position, initialize the system as described in Section 2.18, <i>Power-up Initialization (Cold Start)</i> .
		Power Switch	Switch the KSU AC power switch on the "ON" position.
		AC Fuse	Switch KSU power to the <i>OFF</i> position and remove cover (four screws). Locate the system power supply in the upper left corner of the KSU interior and inspect the AC fuse for continuity (DVM required).
		DC Fuse	Switch KSU power to the <i>OFF</i> position and remove cover (four screws). Locate the system power supply in the upper left corner of the KSU interior and inspect the AC fuse for continuity (DVM required).
		SPI Buss Error	Switch KSU power to the <i>OFF</i> position and remove cover (four screws). Then check for the following: <ol style="list-style-type: none"> 1. Locate each expansion module and verify the ribbon cable connection is accurate and secure. 2. Check for improper aligning of module connectors. 3. Detach all station cabling and retest. 4. Check all socketed IC's for good "seated" connections. 5. Unplug one module at a time and retest until failed component is found. 6. Perform Initialization and Power Up sequence. <i>Note: this is an emergency action since the unique customer database will be erased and the system will reboot with default database programming.</i> 7. If this does not clear the trouble, replace KSU1 and initialize it as described in Section 2.18, <i>Power-up Initialization (Cold Start)</i>.

Symptom(s) (Continued)	Diagnostic Aid	Cause(s)	Action
Telephone/ Terminal apparatus dead	CPU Heartbeat LED flashing and 408M/ 408E/DPM8 module Heartbeat flashing but one or more digital telephones are not functioning.	Shorted station cabling.	At the KSU, power the system down and remove the power cord from the AC outlet. Remove the KSU cover (four screws). Disconnect all station wiring on the affected 408M, 408E, or DPM8 and connect one known-good DET directly to one of the interface ports. Replace the KSU cover and retest with this phone. If this telephone works OK, follow the above procedures to test each interface port. If any port is found bad replace the module. If no port is found bad, replace the wiring/cabling.
		Bad Telephone	If the above test yields all working ports and no cabling errors, test each connected telephone one at a time until the bad telephone is discovered. Replace the telephone.
<p><i>Note: Digital telephones use only one twisted cable pair for power, data control and voice communications. There are no fuses for station interface protection. Instead, a current sensing Polly-switch limits excessive current going to each terminal connection. If a station cable pair is shorted or a telephone's DC power supply is damaged, the Polly-switch will temporarily open to protect the KSU Module circuitry.</i></p>			
Digital telephone erratic operation: - Erratic LED/LCD operation - Faint data noise in the background during conversations	Digital Volt/ Ohm Meter	Cable distance is too long for gauge of wire/ cable used.	If a digital telephone is not receiving clear 2B+D signaling from the KSU, test as follows: 1. With station cable cross-connect (jumper) wire removed and telephone unplugged, place a short circuit across the inside wiring cable pair at the user end (jack) of the cable. 2. With a DVM, measure the short circuit resistance one way. The short-circuited cable pair ohm reading should not exceed ____ ohms.
		Non-standard telephone cable being used.	Each digital telephone should operate on one dedicated, unshielded, twisted pair cable to avoid data noise and interference between adjacent cable pairs.
		Multiple digital extensions being fed from one common cable or on the same cable pair.	

Symptom(s) (Continued)	Diagnostic Aid	Cause(s)	Action
Other party cannot hear you (handset).	Another digital telephone	Component failure	Lift handset, dial another digital extension. Confirm connection of audio. Audio one way only... Replace handset and repeat. If problem persists... Replace handset cord and repeat test. If the problem persists... Replace the telephone instrument.
Cannot hear other connected party	Another digital telephone	Component failure	Lift handset, intercom dial tone should be heard over the handset. If not... Hang up (put the handset in the cradle), then press the ON/OFF button. If dial tone is heard over the loudspeaker... ...Replace handset and repeat the first test. If there is still no dial tone heard through the handset... ...Replace the handset cord and retest. Still no dial tone heard... replace the telephone. If dial tone is not heard over the loudspeaker (ON/OFF button test)... replace the telephone.
<i>Note: The above test requires you to set the feature "Auto Select" for intercom operation ("ICM").</i>			
Other party can't hear you while using the speakerphone.	Another digital telephone	Connection / component failure	Press the ON/OFF button and listen for dial tone over the loudspeaker. Call a known good extension. (The called extension should use the handset for this test.) Verify two-way connection. If the called extension cannot hear your voice, verify that MUTE is not enabled (status lamp flashing red). Lift the handset and verify two-way connection using handset. If verified as a speakerphone problem, replace the telephone.

Symptom(s) (Continued)	Diagnostic Aid	Cause(s)	Action
No sound heard over loudspeaker in speakerphone mode.	Another digital telephone	Connection / component failure	<p>Press the ON/OFF button and listen for dial tone over the loudspeaker.</p> <p>Call a known good extension. (The called extension should use the handset for this test.)</p> <p>Verify two-way connection. If you cannot hear the called extension, verify that MUTE is not enabled at the called extension (Status Lamp flashing red).</p> <p>Lift the handset and verify two-way connection using handset. If verified as a speakerphone problem, replace the telephone.</p>
Static and / or noise can be heard during a conversation.	Process of elimination. Industry standard technician testing tools (lineman's test set, etc.)	Another extension	While on intercom call is the static heard only when connected to one particular extension? Examine that extension.
		Station cabling/MDF wiring	If static exists on all calls, check station cabling/wiring and all MDF connections, correct any problems.
		Extension apparatus	If noise persists, change-out swappable components (handset, handset cord). If noise continues try a known good extension connected to this station cable.
		Telco problem	<p>If static/noise is heard on CO lines only, determine if other extensions also hear the noise/static.</p> <p>If so, are several CO lines affected or only a few.</p> <p>Disconnect CO line at interface point and connect Lineman's test set to the same point of connection <i>ahead</i> of the system. If noise/static persists, contact the local servicing telephone company and request repair.</p> <p>If noise/static can be isolated to the DX-80 equipment, verify which CO line ports are affected (which CO ports seem to have noise/static), replace interface modules as required.</p>

Symptom(s) (Continued)	Diagnostic Aid	Cause(s)	Action
Programming lost or changed.	Digital Executive Telephone display.	Intended programming change.	Check with system administrator for incidental changes made.
		PC-DBA programming changes Send All operation.	When using PC-DBA to make customer database changes you must take special precaution not to overwrite existing data with residual PC-DBA working directory values. When using PC-DBA to update any database, it is highly recommended to perform the function <i>Receive All</i> prior to making any specific database changes to assure that the working directory database matches the database in use at the customer site.
		Bad Memory battery	If power fluctuations occur and the memory battery backup battery is low or bad, the customer database is susceptible to being defaulted (factory settings loaded) whenever a power interruption occurs. If this occurs change the standard (photo-cell type) lithium battery.

3.3 Maintenance Utilities

The DX-80 includes a versatile maintenance utility that you access through PC-DBA. A technician with PC skills can easily use the maintenance function to obtain various data and information about the DX-80 and all connected components.

The DX-80 system allows you to administer system database parameters via an IBM® Compatible, Personal Computer. The use of a PC has distinct advantages over programming the system via the digital telephone, including: specific database archiving (via save function), remote programming, out-board programming (program the system template into the PC memory then send it to the DX-80 when ready). The PC program that interfaces with the DX-80 system is PC-DBA (PC-Database Administration). *Note: PC-DBA is a DOS-based programming utility.*

PC-DBA requires the following resources in the PC environment:

- PC running DOS (PC-DBA can be run in a DOS Window but performance can be impacted by other Windows® modules. We do not warranty or guarantee any level of performance in the Windows environment.)
- 640k minimum RAM
- 386 minimum microprocessor
- 2 megabytes minimum space on the hard disk

CAUTION

PC-DBA is included in the utilities CD DXUILCD shipped with every new system. Or, you can obtain PC-DBA free of charge at the Comdial Web site, www.comdial.com/ccc. Use of this DX-80 utility requires a well-rounded understanding of the PC environment and the DOS file structure. The manufacturer and/or supplier of PC-DBA cannot support users who are unfamiliar with these basic requirements. If any of these issues concern you, please consult with a qualified technician who is well-versed in PC operation.

**3.3.1 LOADING PC-DBA SOFTWARE**

When PC-DBA is retrieved from Comdial's web site, it is downloaded in a self-extracting executable file. Take the following actions to install the software on your PC.

1. Locate the file retrieved from the download site. The executable's file name will be in the form 'DX80_PCDDBA_A3310160322136', where DX80_PCDDBA is the file name, and A33 is the version number.
2. Run this executable file to start the Install Shield Wizard. Follow the on-screen instructions. When the installation is complete, an icon is placed on your Desktop. Click on this icon to launch PC-DBA.

3.4 Entering into PC-DBA Maintenance

1. Enter PC-DBA by typing *DX80* at the DOS prompt in the PC-DBA working directory, then press *Enter*. If you are launching the program from a Windows environment, double-click on the PC-DBA icon on your Desktop. The system displays the title page.

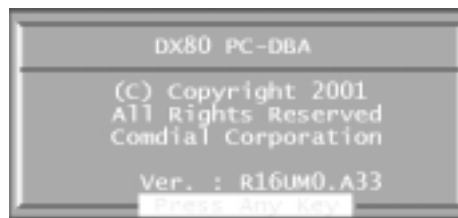

2. Press any key. The system displays the Main screen with the cursor positioned on "PC-DBA".

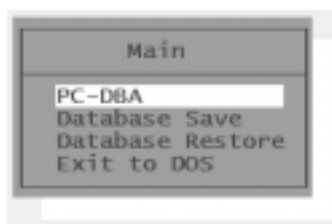

3. Press the *Enter* key to enter PC-DBA. The system displays the PC-DBA menu.

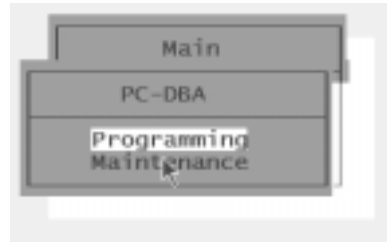

4. Use the arrow keys to select *Maintenance* and then press *Enter*. The system displays the Maintenance screen.

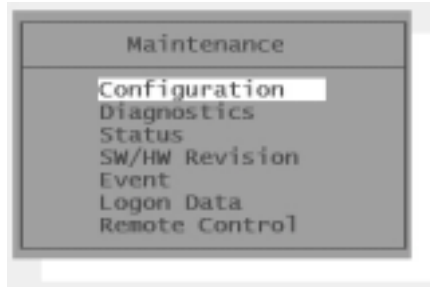

3.5 Communicating with the System

All operations in *PC-DBA – Maintenance* require you to connect to the DX-80 switch. You can do this in three ways:

- a direct connection to the KSU1 – CPM – PC-DBA port,
- using the optional system modem (PN 7249), or
- using the built-in modem of the in-skin voicemail module with pass-through communications enabled.

Once you establish a data communications link, you can connect to the system by pressing the F5 key *Connect*. This *connect* operation links PC-DBA to the DX-80 processor for data exchange.

3.5.1 CABLE

Connect to the DX-80 system on site via the PC serial port (COM port). Use a straight-through, 9-pin to 9-pin, Male/Female cable from the PC serial port to the DX-80 CPM – PC-DBA port. Once you make this connection, you can connect to the DX-80 system processor for the various Maintenance operations.

3.5.2 OPTIONAL SYSTEM MODEM

This connection method can be used while off-site. For more details on modem use with the DX-80, see Section 3.5.4.10, *F9 - Mdm*. For instructions on connecting to the switch using a modem, see Section 3.5.5, *Establishing a Modem Connection*.

3.5.3 PASS-THROUGH COMMUNICATIONS WITH CORPORATE OFFICE DX

Pass-through Communications is a feature associated with the Corporate Office DX 7270C hard drive voice mail board. This feature allows you to communicate with the DX-80 or the in-skin voice mail system through a single modem number. There are specific setup procedures required to activate this feature. Refer to Comdial publication IMI72-005 for further information.

3.5.4 PC-DBA CONTROL MENU

At the bottom of the PC-DBA screen, special control functions of PC-DBA are shown. The following line/bar can be found at the bottom of the display:

```
F1-Help F2-U-Save F3-RCV F4-SND F5-Cnt F6-Disc F7-Prn F8-Init F9-Mdm F10-RS232C
```

Use the associated “F” (Function) keys on the PC keyboard to access the various operations. The functions and their specific operation are detailed in the following sections.

3.5.4.1 F1 - Help

Press F1 to view the help menu of PC-DBA. There are two help screens. Use the *Page Down* key to move to the second screen.

3.5.4.2 F2 - A-Save

This function key is used to save the database to the PC automatically. For details on using this function key, refer to the *DX-80 Technical Manual: Volume II, Programming*.

3.5.4.3 F2 - U-Save

This function key is used to save the database to the PC manually. For details on using this function key, refer to the *DX-80 Technical Manual: Volume II, Programming*.

3.5.4.4 F3 - Receive

This function key is used to receive the database from the system. For details on using this function key, refer to the *DX-80 Technical Manual: Volume II, Programming*.

3.5.4.5 F4 - Send

This function key is used to send the database to the system. For details on using this function key, refer to the *DX-80 Technical Manual: Volume II, Programming*.

3.5.4.6 F5 - Connect

This function key is used to send a connection request to the system for linking the PC to the DX-80 system.

1. Press the F5 function key and you will see the following *Connect* prompt if the PC is communicating with the DX-80.

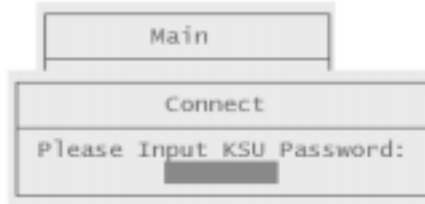

2. Using your keyboard, type in the password. (At default this password is “_____” (Eight spaces —press the space bar eight times). If you enter the wrong password, or have a poor connection, the following error screen will appear.

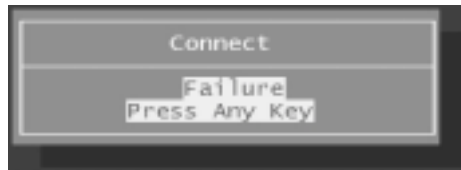

3. If successful, confirmation is given via the following screen:

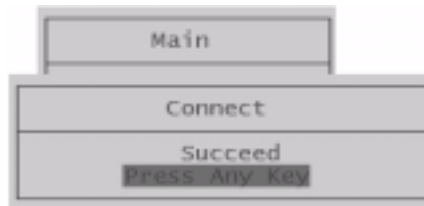

4. Press any key to return to the PC-DBA Maintenance screens.

5. When the DX-80 and the PC are communicating, notice that *[Cnt]* is displayed in the upper left corner of the PC-DBA screen, indicating a successful connection.

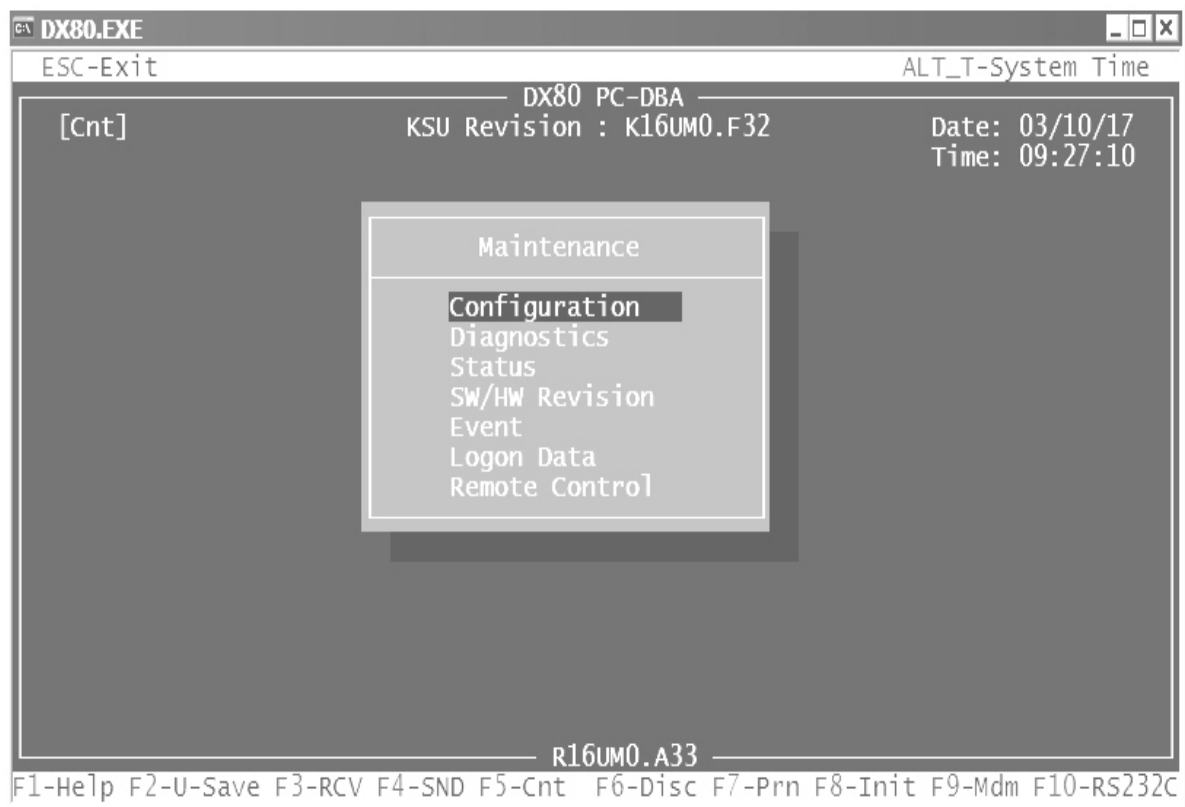

3.5.4.7 F6 - Disconnect

When a link is established between the DX-80 and PC-DBA, this link must also be broken when maintenance operations are complete. This breakdown of the connection will occur automatically if the connection path (cable or modem connection) is interrupted, or when you exit PC-DBA while the link is active.

To force a disconnect between the DX-80 processor and PC-DBA, press the *F6* function key. This procedure usually completes within a few seconds.

3.5.4.8 F7 - Print

Pressing the *F7* function key will print the currently displayed screen to the PC's parallel printer port. Other, third-party utility programs are available to capture the output of the PC LPT (parallel) port to a file. These utilities can be very helpful for trouble shooting analysis.

3.5.4.9 F8 - Initialize

This function key is used to initialize the database and return all settings to the factory default values. For details on using this function key, refer to the *DX-80 Technical Manual: Volume II, Programming*.

3.5.4.10 F9 - Mdm

Remote connection to the DX-80 system is possible via modem. The optional modem may be purchased allowing remote administration of the DX-80 system database and maintenance operations. The default directory number of the modem is 199. Some working knowledge of modem operation and connection is useful.

3.5.4.11 F10-RS232C

This function key is used to setup the PC COM port. To successfully setup the PC COM port you must know how the PC hardware is configured. In this utility you must select the COM Port number (PC-DBA supports COM 1 or 2 only) and the baud rate that will be used for the connection. At default PC-DBA is setup to use COM Port 1 at 9600 bps. (9600 bps matches the default baud rate set for the DX-80 CPM – PC-DBA Port.)

While using a modem connection, it is best to set the COM port baud rate at 2400 bps since this is the speed of the DX-80 optional modem; setting this speed can expedite the modem negotiation process since compression link choices will not be attempted.

3.5.5 ESTABLISHING A MODEM CONNECTION

If the system is not equipped with an automated attendant or a voice mail in auto attendant mode, make sure the attendant is aware that a modem connection will be taking place. Use of the automated attendant can greatly assist the modem connection process since you can enter the modem extension remotely.

1. Press *F9-Mdm*. The following modem control screen is shown:



2. Use the arrow keys to select *Connect*, then press *Enter*. The following modem control string is displayed:

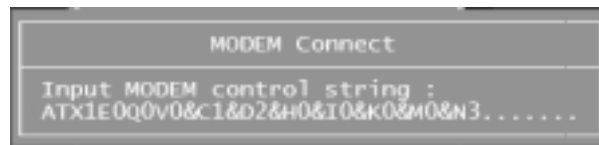

3. If your modem requires some different control string, input that string now. Then press *Enter*. If nothing happens, it is likely that the modem is not being addressed by PC-DBA. Use *F10-RS232C* to select the COM (serial port) that is connected to the PC modem. Then repeat these steps from *F9-Mdm* above.

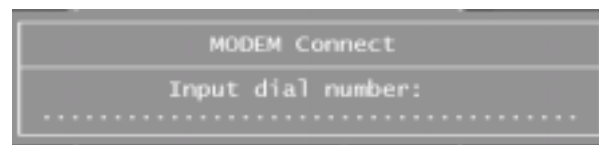

4. Enter the telephone number at the site location. Then press *Enter*.

Note: If modem connection at this site requires a human to transfer the modem call to the DX-80 modem (ext 199), you must have a standard telephone connected to the same circuit as the modem so that you can verbally request the answering person to transfer the call.

Dialing begins and then the modems negotiate connection. If the negotiation is successful the system displays [Mdm] in the upper left portion of the screen.

Once a modem connection has been accomplished, you can perform an F5-Connect. F5-Connect is required to link PC-DBA to the DX-80 CPM processor.

3.6 Maintenance Utilities

Once the F5-Cnt operation is successfully completed and the system has established a link between PC-DBA and the DX-80 processor, you can use the maintenance utilities.

1. The PC-DBA Maintenance screen appears as follows. Notice that the system indicates a successful connection to the DX-80 processor by displaying [Cnt] in upper left corner.



Also, for reference and diagnosis, the system displays the current software version of the connected DX-80 system and PC-DBA—note *KSU Revision: K16UM0.F32* in the upper part of the screen (DX-80 software version) and *R16UM0.A33* in the lower part of the screen (PC-DBA version).

2. Use the arrow keys to select the appropriate maintenance utility and then press *Enter*. Each utility is described in Section 3.6.1, *Configuration* through Section 3.6.11, *I/O Memory Mapping*.

3.6.1 CONFIGURATION

1. When you select *Configuration*, the DX-80 processor sends the current hardware configuration to PC-DBA for viewing. For each board viewed, the board type is displayed so that the hardware can be readily identified.

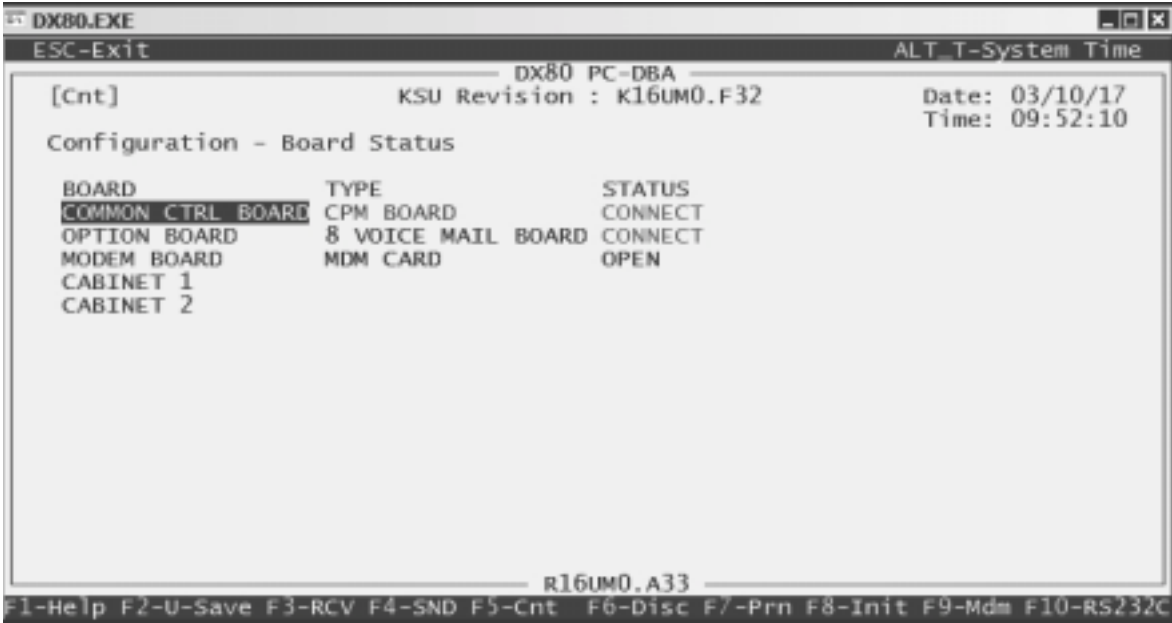

The Option board can be any of the following board types.

AAM	Automated Attendant Module
8 VOICE MAIL BOARD	7271C Flash Voice Mail (with Automated Attendant), or 7270C Hard Drive Voice Mail (with Automated Attendant)

Board status can be any of the following.

Fail/Failed	This board is reporting some failure as a result of the last diagnostic test. Also, this can indicate that CO lines are not connected to a CO port or that Loop Current is no longer present on the CO lines connected.
Open	The board position is Open (not occupied, and likely never occupied).
Connect	This board is reporting connected (installed and normal) status.
Disconnect	This board has been installed and is now removed.
Block/Unblocked	This board/port is Blocked/Unblocked as part of a Maintenance service function.

- To view a board (installed PCB) in detail, use the arrow keys to select the board and then press *Enter*.

The following display shows the detail of the CPM board.

```

DX80.EXE
ESC-Exit                                ALT_T-System Time
----- DX80 PC-DBA -----
[Cnt]                                KSU Revision : K16UM0.F32           Date: 03/10/17
                                         Time: 09:53:53

Configuration :
Board Type : CPM BOARD
RS232-1 :CONNECT
RS232-2 :DISCONNECT

                                         R16UM0.A33
F1-Help F2-U-Save F3-RCV F4-SND F5-Cnt F6-Disc F7-Prn F8-Init F9-Mdm F10-RS232C

```

To view a Cabinet 1 or 2 board, use the arrow keys to select the appropriate cabinet and then press *Enter*. The following is a display of Cabinet 1.

```

DX80.EXE
ESC-Exit                                ALT_T-System Time
----- DX80 PC-DBA -----
[Cnt]                                KSU Revision : K16UM0.F32           Date: 03/10/17
                                         Time: 09:55:30

Configuration - Board Status           Cabinet 1

BOARD 1                               TYPE          STATUS
BOARD 2                               408 BOARD    CONNECT
BOARD 3                               OPEN         OPEN
BOARD 4                               OPEN         OPEN
BOARD 4                               APM4         CONNECT
BOARD 5                               COM4         CONNECT

                                         R16UM0.A33
F1-Help F2-U-Save F3-RCV F4-SND F5-Cnt F6-Disc F7-Prn F8-Init F9-Mdm F10-RS232C

```

- To view a board in this cabinet in detail, use the arrow keys to select the appropriate board and then press *Enter*.

The following display shows the 408 board of Cabinet 1.

```
DX80.EXE
ESC-Exit
ALT_T-System Time
DX80 PC-DBA
[Cnt] KSU Revision : K16UM0.F32 Date: 03/10/17
Time: 09:57:04
Configuration :
Board Type : 408 BOARD Cabinet 1
TRK POS TYPE STATUS
1/01/01 CO FAIL
1/01/02 CO FAIL
1/01/03 CO FAIL
1/01/04 CO FAIL
EXT POS TYPE STATUS
1/01/01 NO CONNECTION OPEN
1/01/02 NO CONNECTION OPEN
1/01/03 NO CONNECTION OPEN
1/01/04 NO CONNECTION OPEN
1/01/05 NO CONNECTION OPEN
1/01/06 NO CONNECTION OPEN
1/01/07 NO CONNECTION OPEN
1/01/08 NO CONNECTION OPEN
R16UM0.A33
F1-Help F2-U-Save F3-RCV F4-SND F5-Cnt F6-Disc F7-Prn F8-Init F9-Mdm F10-RS232C
```

The following display shows the COM4 Board of Cabinet 1.

```
DX80.EXE
ESC-Exit
ALT_T-System Time
DX80 PC-DBA
[Cnt] KSU Revision : K16UM0.F32 Date: 03/10/17
Time: 09:58:28
Configuration :
Board Type : COM4 BOARD Cabinet 1
TRK POS TYPE STATUS
1/05/01 CO OPEN
1/05/02 CO OPEN
1/05/03 CO OPEN
1/05/04 CO OPEN
R16UM0.A33
F1-Help F2-U-Save F3-RCV F4-SND F5-Cnt F6-Disc F7-Prn F8-Init F9-Mdm F10-RS232C
```

3.6.2 DIAGNOSTICS

The Diagnostics function can be invoked to force a diagnostic test operation. The system performs this test automatically at the time it boots up (initial installation) and whenever programmed to do so. By default, the factory settings for the system Self-Test Time is set to “NULL” (never performed). (For programming details, refer to the *DX-80 Technical Manual, Volume II, Programming.*)

The Diagnostic Self-Test can be invoked automatically via programming settings or manually.

When the Diagnostic Self-Test is invoked, the DX-80 performs a list of software and hardware checks to assure proper operation of the hardware installed.

Diagnostic Test activity has the lowest priority in CPU processing tasks, therefore, the time required to complete this testing operation could vary from one test to the next. When an automatic test or manual test of the entire system is invoked, the testing time can take approximately 30 minutes.

Manual diagnostics testing can be invoked for the entire system or for one module or module port. To do a manual test, perform the following steps.

1. From the Diagnostics menu, select Self Test. The system displays the Self Test menu.

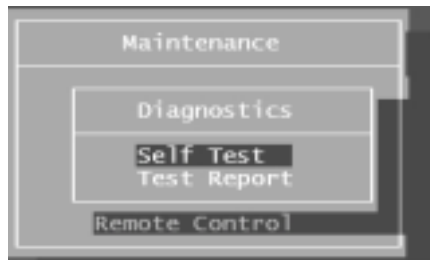

You can select Wait For the Result or Do Not Wait.

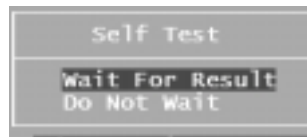

When invoking the test for the entire system, Comdial recommends that you not wait for the results since this will take several minutes and will force PC-DBA to wait for the diagnostic report; while waiting, it is not possible to perform any other PC-DBA functions.

2. If you select *Test Report* on the Diagnostics menu, the DX-80 displays the last diagnostics test report invoked.

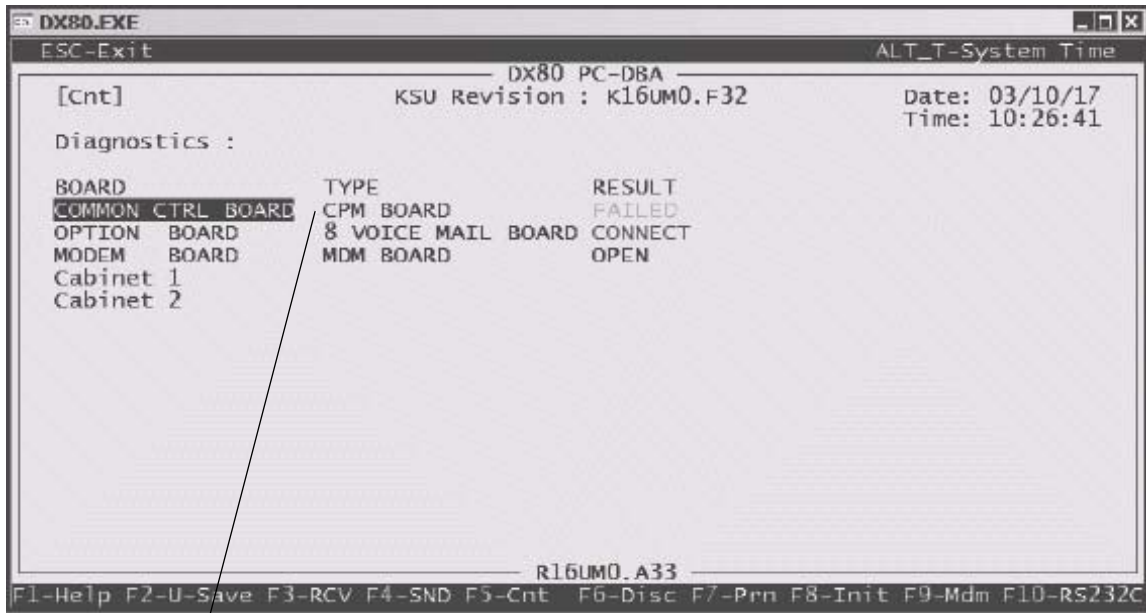

In this example, the CPM board is reporting a failure. The next screen will further define this failure.

Also notice that the Voice Mail board is showing a result of *CONNECT*. Since the Voice Mail board is an independent system, only *Connect* or *Disconnect* is reported.

3. Move the cursor to any board/cabinet and press *Enter* to get details of that board or cabinet.

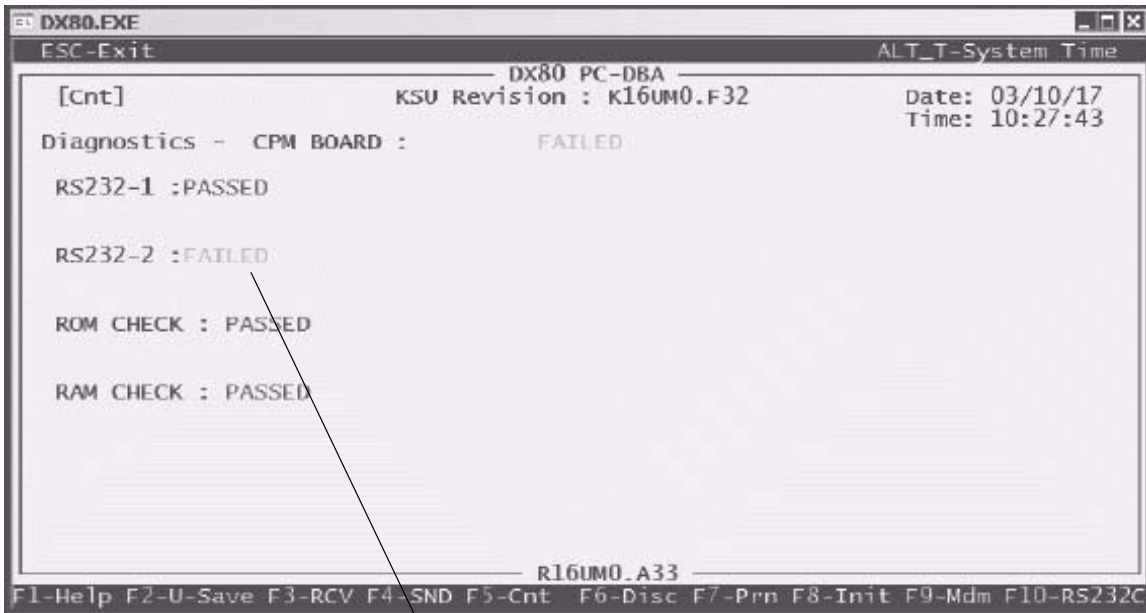

As seen in the previous example, the CPM failed the diagnostic test. By selecting the CPM board, the system shows you that the failure is associated with the second RS232 port. This is a typical indication that there is nothing connected to the port.

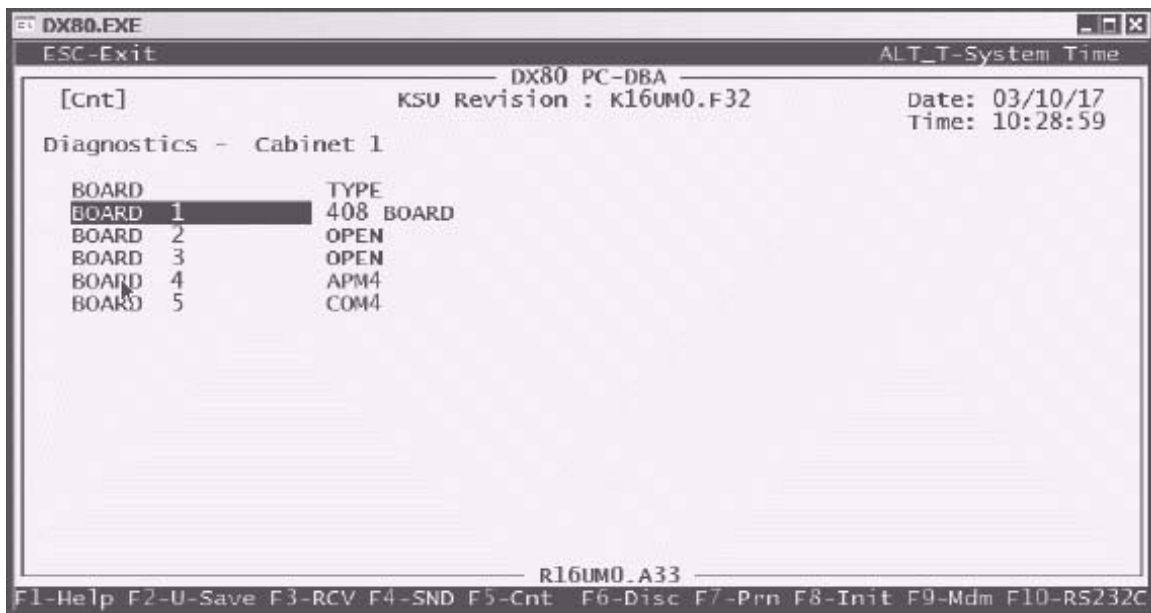

In this example, Cabinet 1 was selected. Use the arrow keys to position the highlight bar to any board and press *Enter* to get the details for that board.

Maintenance and Trouble Shooting

The following screen shows the results of the 408 Board diagnostics.

408 Board Selected

No loop current detected (CO lines not connected)

```
DX80.EXE
ESC-Exit
DX80 PC-DBA
KSU Revision : K16UM0.F32
Date: 03/10/17
Time: 10:30:13
ALT_T-System Time

[Cnt]
Diagnostics - 408 BOARD :

TRK POS  DIR#  LOOP  DISC
1/01/1   740   OPEN  OPEN
1/01/2   741   OPEN  OPEN
1/01/3   742   OPEN  OPEN
1/01/4   743   OPEN  OPEN

EXT POS  DIR#  TYPE          RESULT
1/01/1   201   EXEC. DISPLAY OPEN
1/01/2   202   EXEC. DISPLAY OPEN
1/01/3   203   NO CONNECTION OPEN
1/01/4   204   NO CONNECTION OPEN
1/01/5   205   NO CONNECTION OPEN
1/01/6   206   NO CONNECTION OPEN
1/01/7   207   NO CONNECTION OPEN
1/01/8   208   NO CONNECTION OPEN

R16UM0.A33
F1-Help F2-U-Save F3-RCV F4-SND F5-Cnt F6-Disc F7-Pnn F8-Init F9-Mdm F10-RS232C
```

Stations not yet connected,
Other possible codes:
- Passed =operation OK
- Failed = data comm error

The following screen shows the results of the COM4 board diagnostics.

No loop current detected

Other possible codes:
 - Passed = Loop OK
 - In = Incoming Call
 - Out = Outgoing Call
 - Failed = Loop Fail
 - Open = Not Equipped

TRK POS	DIR#	LOOP	DISC
1/05/1	744	OPEN	OPEN
1/05/2	745	OPEN	OPEN
1/05/3	746	OPEN	OPEN
1/05/4	747	OPEN	OPEN

ESC-Exit
 DX80 PC-DBA
 KSU Revision : K16UM0.F32
 Date: 03/10/17
 Time: 10:31:20
 Diagnostics - COM4 BOARD :
 R16UM0.A33
 F1-Help F2-U-Save F3-RCV F4-SND F5-Cnt F6-Disc F7-Prn F8-Init F9-Mdm F10-RS232C

- To exit the report screens, press the *ESC* key. When prompted Exit This Feature?, select *Yes*.

3.6.3 STATUS

You can use the Status function to view a specific DX-80 system resource status.

- Move the cursor to the system resource to view, and press *Enter*.

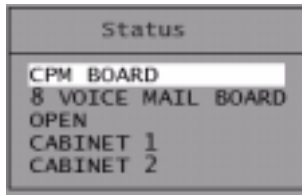

- On the Status - OPTION BOARD screen the connect status can be either IDLE (ready for call) or BUSY (port in use).

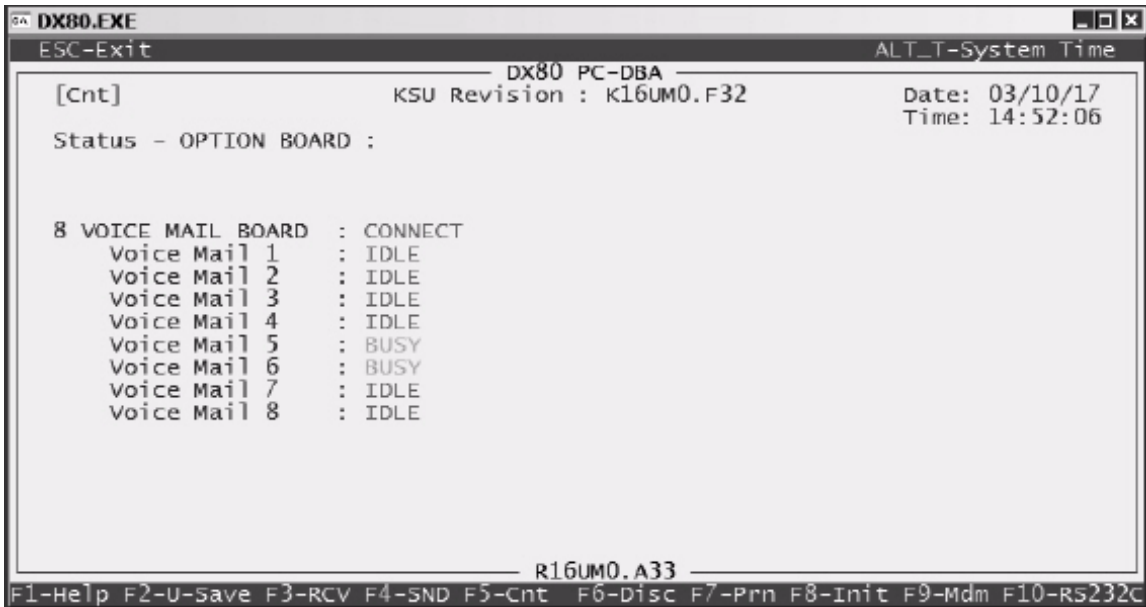

- Select Cabinet 1 to report the status of the modules associated with this cabinet.

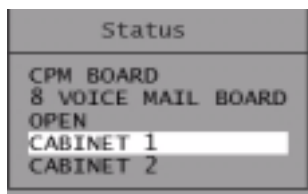

```

DX80.EXE
ESC-Exit ALT_T-System Time
DX80 PC-DBA
[Cnt] KSU Revision : K16UM0.F32 Date: 03/10/17
Time: 14:58:49
Status - 408 BOARD :
TRK POS DIR# STATUS
1/01/1 740 FAIL
1/01/2 741 FAIL
1/01/3 742 FAIL
1/01/4 743 FAIL

EXT POS DIR# TYPE STATUS
1/01/1 101 NO CONNECTION OPEN
1/01/2 102 NO CONNECTION OPEN
1/01/3 103 NO CONNECTION OPEN
1/01/4 104 NO CONNECTION OPEN
1/01/5 105 NO CONNECTION OPEN
1/01/6 106 NO CONNECTION OPEN
1/01/7 107 NO CONNECTION OPEN
1/01/8 108 NO CONNECTION OPEN

R16UM0.A33
F1-Help F2-U-Save F3-RCV F4-SND F5-Cnt F6-Disc F7-Prn F8-Init F9-Mdm F10-RS232C

```

Status can be:

- Idle = equipped and ready
- Fail = equipped, but errors present. (no loop current. Extension lost data communications.
- Open = no hardware recognized.
- Busy = in use

3.6.4 SW/HW REVISION

You can use the SW/HW Revision to view the current version of software installed in the DX-80. The Hardware Revision (HW Revision) is a label only field that allows the user of PC-DBA to record the revision of hardware installed at the site. This information is stored in the Database Save operation of PC-DBA.

```

DX80.EXE
ESC-Exit ALT_T-System Time
DX80 PC-DBA
[Cnt] KSU Revision : K16UM0.F32 Date: 03/10/17
Time: 15:03:19
Maintenance - SW/HW Revision :

BOARD POS SW Revision HW Revision
CPM BOARD K16UM0.F32 NULL
8VM CARD POMVM0.F01 NULL
MDM CARD NULL NULL
DPM BOARD 1/01 PEHUM0.F12 NULL
OPEN 1/02 NULL NULL
OPEN 1/03 NULL NULL
APM4 BOARD 1/04 PEHUM0.F12 NULL
OPEN 2/01 NULL NULL
OPEN 2/02 NULL NULL
OPEN 2/03 NULL NULL
OPEN 2/04 NULL NULL
COM BOARD 1/1&5 PEHUM0.F12 NULL
OPEN 2/1&5 NULL NULL

R16UM0.A33
F1-Help F2-U-Save F3-RCV F4-SND F5-Cnt F6-Disc F7-Prn F8-Init F9-Mdm F10-RS232C

```

3.6.5 EVENT

You can invoke event tracking to record actions the system processes, for the purposes of debugging the system. This operation is rarely required and usually used following a request by the customer service department to do so. The output data is presented to the SMDR serial port. **Note:** *The data must be collected in a dedicated collection PC using special Event Tracking software, or a terminal emulation software that writes to a text file, for later deciphering at customer service.*

Event tracking can be started and stopped by a specified system operation, or set to continue until manually discontinued.

1. To start event tracking select *Event Invoking*, and select one of the available system operations that will cause event data output to begin. (Do not select “Pseudo” to begin event tracking. This operation is a non-occurring event intended for use with “End Event” when the event output should not end by a system operation.)

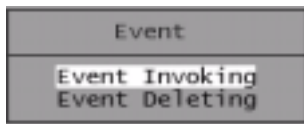

2. Select *Event Invoking* to define the action that will start the tracking procedure.

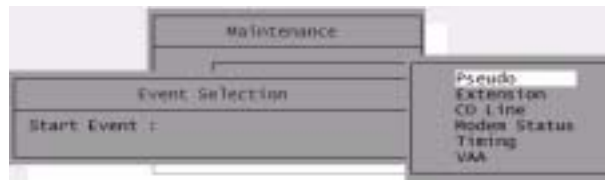

3. Use the arrow keys to highlight the type of event to use for starting the tracking procedure.

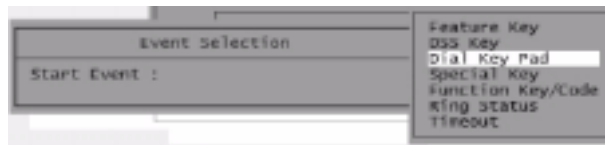

In this example, we have chosen to start the event with an entry from the dial key pad.

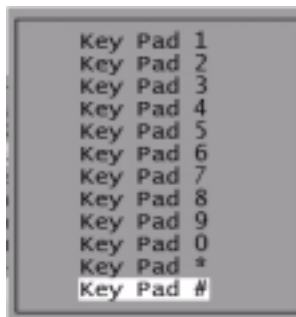

4. Select the dial key pad digit that will start the procedure.

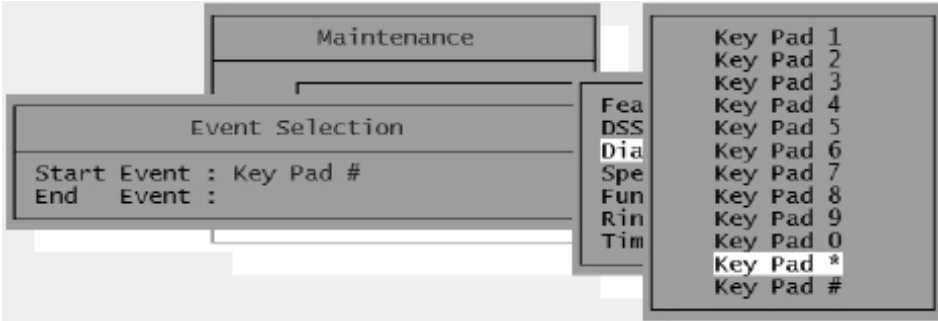

5. Select the action that will end the event tracking.

3.6.6 LOGON DATA

Logon Data is used to view the date and time that the PC-DBA session began.

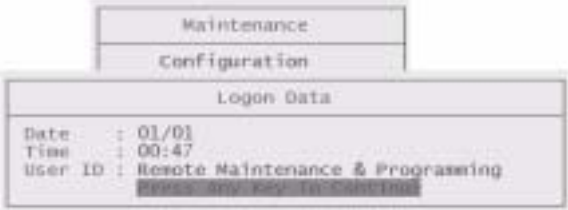

3.6.7 REMOTE CONTROL

Remote Control allows the PC-DBA user to invoked system critical operations. This operation allows the user to:

- Restart the system.
- Restart the system and re-load default data (Master Clear).
- View and alter system memory contents (for the purposes of diagnostics).
- Block system resources for the purposes of maintenance operations.

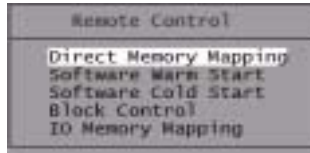

CAUTION

! The Engineering Maintenance Tools should only be used by trained personnel. Attempts to access these tools without knowledge of their use, can cause call processing and system malfunctions or resets. All risks are assumed by the user. !

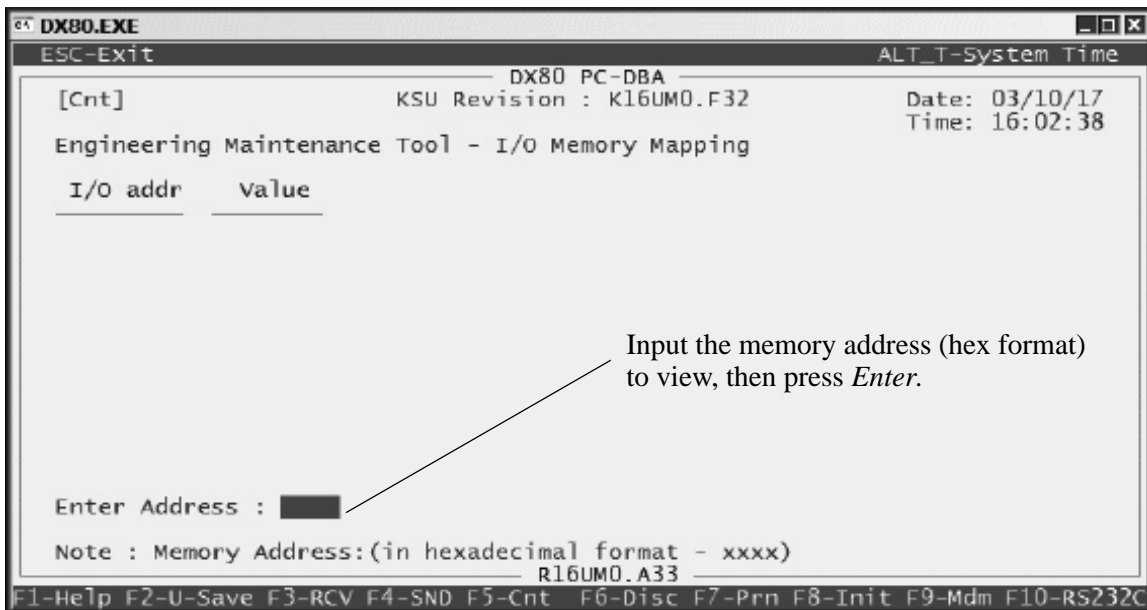

3.6.8 SOFTWARE WARM START

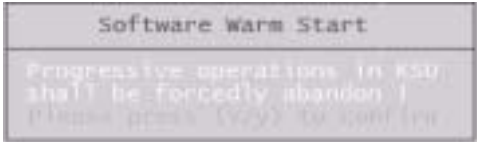

Use Software Warm Start to cause the system to restart operations. This operation requires confirmation since all calls in progress will be disconnected.



3.6.9 SOFTWARE COLD START

Use Software COLD Start to cause the system to restart operations and reload default customer database data.

CAUTION

 This operation requires confirmation since all calls in progress will be disconnected and the current database will be erased!
 

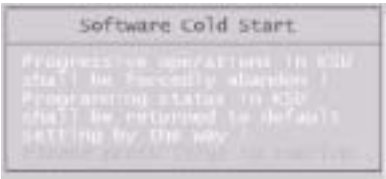

3.6.10 BLOCK CONTROL

You can use Block Control to restrict access to certain system resources for the purposes of troubleshooting, e.g. you might block a CO line from use in order to test the circuit while avoiding user access to the CO line circuit. To use Block Control, you must know the cabinet number, board/module number and port number.

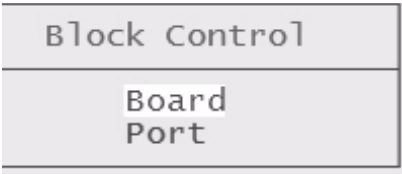

Block Control can be used to block access to a board or a port. The specific board/module and/or port number must be known.

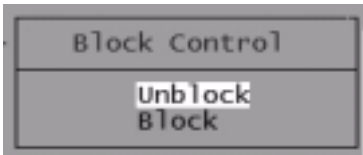



When a port or board is blocked, it must be Unblocked to regain access to the resource.

3.6.11 I/O MEMORY MAPPING

Use I/O Memory Mapping when instructed to do so by a Comdial technical support representative. This operation is used to view system input/output port values.

CAUTION

 The Engineering Maintenance Tools should only be used by trained personnel. Attempts to access these tools without knowledge of their use, can cause call processing and system malfunctions or resets. All risks are assumed by the user. 

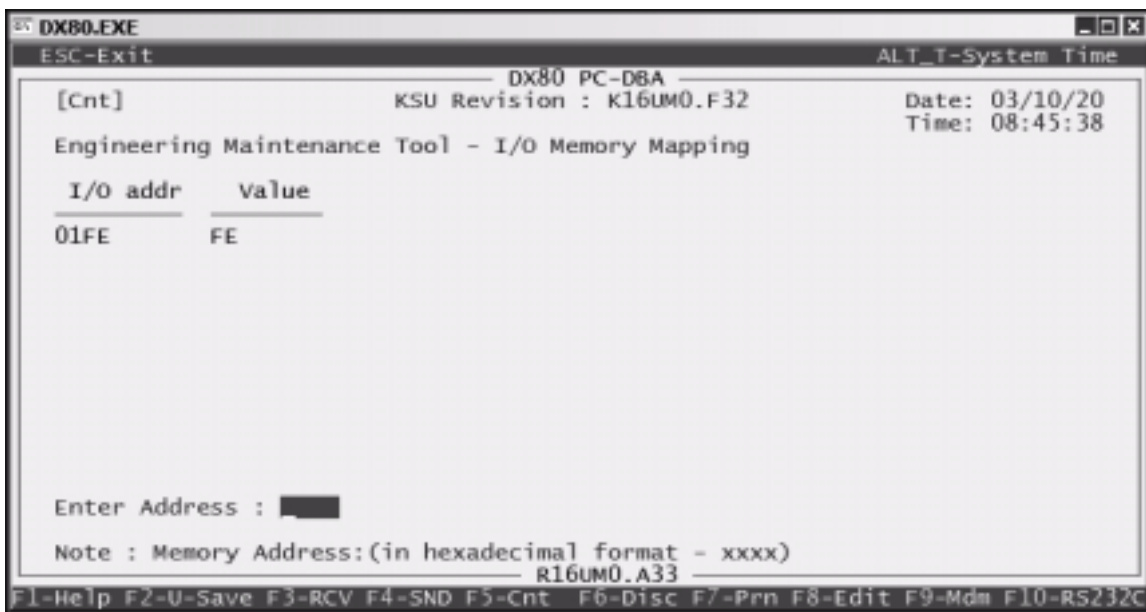

4. TROUBLESHOOTING INSTALLATION ISSUES

This chapter outlines the most common installation problems for the DX-80, and provides a corrective action addressing each issue.

4.1 Corrupted Database on Initial System Setup

SOLUTION: DX-80 Power-Up Initialization

You must successfully initialize the DX-80 system during start up procedures for the system to operate properly. **The installation of the DX-80 is complete only when you perform this critical initialization/cold start operation.**

You must also initialize/cold start the DX-80 system after adding any new hardware in KSU1 or KSU2. If you are adding new hardware, go to Section 4.2, *Adding Hardware to an Existing System (Making Sure the DX 80 Recognizes It)*.

When you initialize the DX-80, the system establishes and organizes an operational customer database—the system uses this database organization for future system updates. When the system completes the initialization process, it loads the default database contents into memory; the system is then ready to run with this database configuration. You can later make custom changes to the database using appropriate program settings for the various features.

To initialize the DX-80, perform the steps in Section 2.18, *Power-up Initialization (Cold Start)*. **Note:** *If you have previously entered programming information into the DX-80 database, perform the procedure in Section 4.2, Adding Hardware to an Existing System (Making Sure the DX 80 Recognizes It).*

4.2 Adding Hardware to an Existing System (Making Sure the DX 80 Recognizes It)

SOLUTION: Follow the steps required when adding hardware to an existing system.

When you add any optional expansion/circuit modules (COM4, DPM8, APM4, In-Skin Voicemail, or Modem) to either KSU1 or KSU2, you must follow certain procedures to ensure the DX-80 configures itself properly with the newly added equipment. These procedures include performing a cold start/initialization. If your customer's DX-80 switch uses a customized database, be sure to take these measures first to back up that database. **Note:** *If you program using the DET instead of PC-DBA, you cannot save the custom database; you will have to re-program the custom settings after performing the cold start. For further details on DX-80 programming options, see the DX-80 Technical Manual, Volume II, Programming.*

When adding new equipment, perform the following steps.

1. Connect and login to PC-DBA by pressing *F5*. From the main Database Programming screen press *F3* and **Receive All**.
2. After Receiving All, log out of PC-DBA by pressing *F6*.
3. Turn OFF the power supply to the DX-80 KSUs by moving the ON/OFF switch to the OFF position.
4. Un-plug the DX-80 AC power cords on KSU1 and KSU2.
5. At this point, begin the cold start initialization. To do so, follow the procedure in Section 2.18, *Power-up Initialization (Cold Start)*.

When you have finished the cold start initialization, the default data will be loaded and ready and the telephones will be functional. In this status, all CO lines will ring at extension 101, all extensions may take and place calls, and all systems features are operational per the default configuration.

6. If you are programming using the telephone, you will have to customize the database again manually.

If you are programming using a laptop, log in to the PC-DBA. From the main Database Programming screen press *F4* to send and select *All*. The system reloads the custom database you previously saved in step 1, writing over the default database created during the cold start.

4.3 Voice Mail Doesn't Work (No Legal Member)

SOLUTION: Follow the steps required when initializing the system.

The No Legal Member error indicates that the DX-80 has not been properly initialized. You must properly initialize the system when you first install it, and every time you add a piece of hardware to the system (a new board, etc.).

If you do not have an existing database, perform a cold start initialization. Follow the detailed procedure in Section 2.18, *Power-up Initialization (Cold Start)*.

If you have an existing database, and you have PC-DBA loaded onto a laptop, you can:

- save the customized database

- perform a cold start initialization (which loads a default database, writing over your custom database), and then
- reload the saved database over the default database.

Follow the detailed procedure in Section 4.2, *Adding Hardware to an Existing System (Making Sure the DX 80 Recognizes It)*.



If you have an existing database, and do not have access to PC-DBA, you must program using the telephone. When you take the system down and reinitialize it, you will have to re-program your database afterwards.

If circumstances on the customer site keep you from performing a cold restart, perform the following steps using the telephone.

1. Dial into the programming mode and enter *01-(101~156)-21*. The range of numbers in the middle of this command represent the extension's port type. The voice mail ports are in range 157-164. Press *save*.
2. Press *chg* until the port type "VM" displays for this extension.
3. Press *HOLD* to return to the previous menu level, or press the Up or Down Volume arrows to return to the DB Item.
4. Return to the Selection screen.
5. Next, you will be checking the UCD group numbers. Enter *06-01-24-03-01*. The 24 in the middle of this command represents the UCD group number. Press *save*. This advances to member #1 of the new UCD Group selected.
6. Press *chg*.
7. Enter the extension number of the digital channel you want to program into this member (at default the digital channels of DX-80 Voicemail are 157, 158, 159, 160, 161, 162, 163, 164.) Press *save*.
8. Press *next*.
9. Repeating steps 6 through 8, program all voice mail channels as members of this UCD group.
10. Press *HOLD* to return to the previous menu level or press the Up or Down Volume arrows to return to the DB Item
11. Return to the Selection screen.
12. Next, you will be checking the UCD assignment for the Voice Mail Hunt group. Enter *06-02-(1~3)-01*. The range of numbers in the middle of this command represent the tenant group number (usually 1). Press *save*. This advances you to Voice Mail Table for Tenant 1 – Hunt Group.
13. Press *chg* until the UCD group you want to use as the VM hunt group displays (new UCD Group selected and programmed with digital channel members.)
14. Press *next* to continue programming the various call handling digits (Prefix/Suffix).
15. Press *HOLD* to return to the previous menu level, or press Up or Down Volume arrows to return to the DB Item
16. Exit programming.
17. Test to see if these changes have corrected the problem. If not, you MUST reinitialize the system. Go Section 4.2, *Adding Hardware to an Existing System (Making Sure the DX 80 Recognizes It)* and follow the instructions.

4.4 Invalid Entries Calling a Busy Station; Issues with Multiple Mailbox Greetings

SOLUTION: The following items should be applied to all DX-80 (PC8 In-Skin) Voice Mail Systems; build 8.5.9 and earlier.

<div style="display: flex; justify-content: space-between; align-items: center;">  <div style="text-align: center;"> <p>CAUTION</p> <p>All characters must be entered as shown for proper programming. Commands in bold indicate changes to previously documented material, and are not to be entered as bold.</p> </div>  </div>
--

1. Add the new TRANS.TXT file – 8.5.9. R41 does not support multiple mailbox greetings (all users should use greeting 0).

```

;Direct call (internal)
a1b1czdx=x*,*,#
;Direct call (external)
a1b2czdx=
;Transfer from operator (internal)
a2b1czdx=x*,*,1,1
;Transfer from operator (external)
a2b2czdx=x*,*
;Busy call forward
*a3byczdx=x*,*
a3byczdx=x*,*
;No answer call forward
a4byczdx=x*,*
;Direct call forward
a5byczdx=x*,*
;Record
a6byczdx=x*,*,1,1:n
;Individual greeting for trunk 1-8
a7byczd740=
a7byczd741=
a7byczd742=
a7byczd743=
a7byczd744=
a7byczd745=
a7byczd746=
a7byczd747=
a7byczdx=
;Recall (from Hold / No ans)
a8byczdx=x*,*
;UCD re-route for UCD groups 1-5
a9byd13=3301
a9byd23=3302
a9byd33=3303
a9byd34=3304
a9byd05=3305
;UCD overflow 1 for UCD groups 1-5
a9byd1=3101
    
```

```

a9byd2=3102
a9byd3=3103
a9byd4=3104
a9byd5=3105
;UCD overflow 2 for UCD groups 1-5
a9byd91=3201
a9byd01=3202
a9byd*1=3203
a9byd#1=3204
a9byda1=3205
;UCD overflow for all other groups
a9bydx=

```

2. Remove Mail Box 157. This is a voice mail port and cannot be used as a mail box.
3. Remove Custom 16384 from voice mail – it adds an asterisk (*) to the end of transfers. This causes problems with analog phones (phone rings once but are dead air when answered).
4. Change the System Technical “Seconds of non silence” from 5 to 99. Hang-ups occur when a user is leaving a message if this parameter is set too low.
5. Set Routing boxes 3301-3305, 3101-3105, 3201-3205 to hang up if no digit is dialed. The UCD overflow feature will not work if routing boxes are not set this way.

Note: All of these changes have been incorporated in build 8.5.10.1 and later.

4.5 Ensuring Optimum Call Handling Performance

SOLUTION: Apply the following settings to all DX-80 KSUs.

Call Handling Category 1 set:

```

Xfer_I Recall    60sec
Xfer_B Recall    60sec
Hold Recall SLT  5min
Hold Recall DEKT5min

```

Call Handling Category 3 set, VM Dialing Ratio:

```

Tone Time        60ms
Int_Dgt Time     60ms

```

4.6 Ringing a Group Of Phones Before Routing the Call to Auto-Attendant

SOLUTION: Implement delayed ringing to Voice Mail, AutoAttendant.

Note that UCD groups 1- 5 (410-414) are used for the DX-80's built in UCD functionality with the In-skin Voice mail system.

To implement delayed ringing, perform the following steps.

1. Set up a UCD group. Use Hunt group 6 through 23 (415-432) when using the inskin voice mail.

The screenshot shows a terminal window titled "DX80 - PXR" with a menu bar containing "Auto" and several icons. The main display area has a blue background with yellow and white text. At the top, it says "ESC-Exit" on the left and "ALT_T-System Time" on the right. Below that, it displays "DX80 PC-DBA" and "Date: 01/12/26 Time: 10:10:53". The main content is titled "Uniform Call Distribution - Parameter Programming: Hunt Group 6" and lists various parameters:

Attribute	:UCD	(UCD/U.A.)
Tenant Group	:1	(1-3)
Name	:UCD 6	('0'-'9', 'A'-'Z', 'a'-'z', Space)
Member	:---	(EXT DIR No.)
Hunting Method	:All Ring	(All Ring/Linear/Distributed)
No Answer Timer	:10	(5-60 sec)
Overflow 1 Timer	:10	(0-255 sec)
Overflow 1 Dest.	:NULL	(EXT/Hunt Gp. DIR No.)
Overflow 2 Timer	:0	(0-255 sec)
Overflow 2 Dest.	:NULL	(EXT/Hunt Gp. DIR No.)
Overflow Count	:1	(1-128 times)
Re_Route Dest.	:433	(EXT/Hunt Gp. DIR No.)

At the bottom of the screen, it says "R16UMD.F28" and a row of function key shortcuts: "F1-Help F2-U-Save F3-RCV F4-SND F5-Cnt F6-Disc F7-Prn F8-Init F9-Mdm F10-RS232C".

This example will ring Hunt Group 6 (Directory # 415) three times and then re-route to the Voice Mail Auto Attendant.

2. Set up the CO line Answering Position.
 - Make the following UCD Group the only Destination for Day / Eve, and
 - Set Pre-CFW NoAns to NULL.

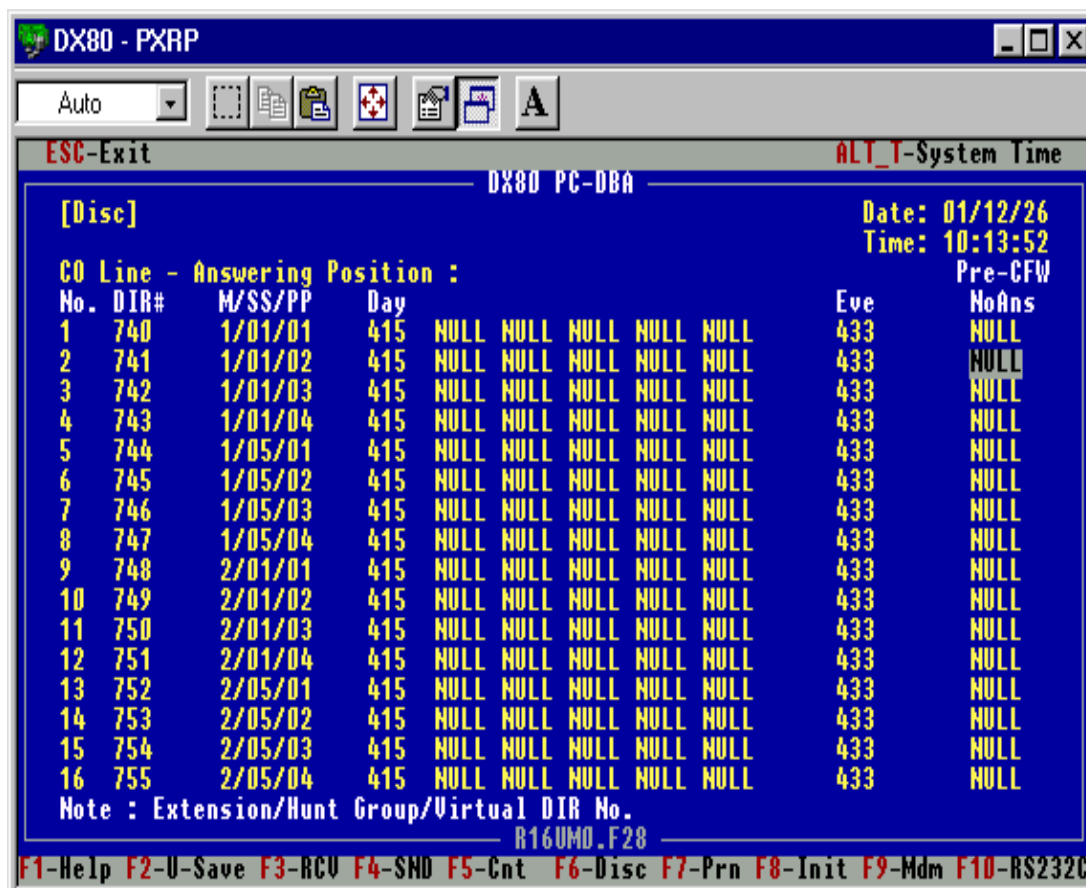

4.6.1 INSKIN VOICE MAIL

If you use UCD groups 6 through 23, you do not have to modify TRANS.TXT unless you want a specific routing box or mailbox to answer.

If you use UCD group 1 through 5, you must modify the TRANS.TXT to route the integration to the proper Routing Box/greeting desired.

Example (PC8):

UCD Group 1 (410) will re-route to Voice mail with the string; [a9b2d13](#). The line in the TRANS.TXT currently reads:

```
a9byd13=3301
```

Modify this line to read:

```
a9byd13=9
```

and make sure the initial routing box destination for digit 9 is the routing box's extension number.

Example (PC8):

UCD group 6 (415) will re-route to VM with the String; **a9b2d63**. This digit string will get a success on the rule:

a9bydz=

and will follow the voice mail's Line Information screen to answer the call based on Day, Lunch or Night. So, if you need the voice mail to answer with a different greeting, (i.e., routing box 805) you must add a line to the TRANS.TXT above the following rule:

a9byd63=805
a9bydz=

4.6.2 EXTERNAL VOICE MAIL: DEBUT-SMALL OFFICE LITE

Example:

UCD group 1 (410) will re-route to voice mail and receive the digit string: **348** requiring a rule to be added **3X=9** or **348=805**

Note also that this method can be used for Auto Attendant options when customers, for example, want to press 4 for technical support, ring a group of phones, and then route back to Voice mail and play a specific greeting.

4.7 Using Multiple Lines and Assigning Different Auto-Attendant Greetings for Each Line

SOLUTION: CO Line Routing

Both of the following examples will use:

- Trunks 1-2 for Company A
- Trunks 3-5 for Company B
- Trunks 6-8 for Company C.

Example 1: Voice Mail Answers Incoming CO Lines Immediately

1. Set the Day and or Eve answering positions to directory 433 (Voice Mail Hunt Group).

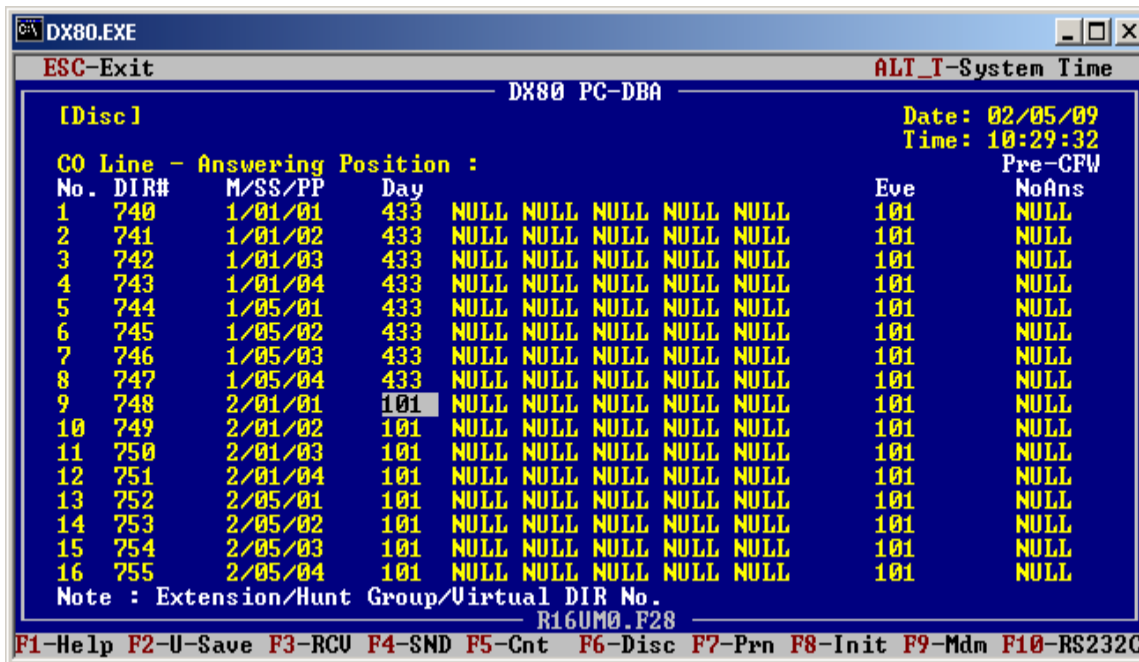

When the DX-80 forwards a call to Voice Mail hunt group 24 (dir 433) the following in-band digits are sent to voice mail.

a7byezd740 for line 1	a7byezd741 for line 2
a7byezd742 for line 3	a7byezd743 for line 4
a7byezd744 for line 5	a7byezd745 for line 6
a7byezd746 for line 7	a7byezd747 for line 8

2. Assuming that:

- Company A will be using Routing Box 800 to answer incoming calls;
- Company B will use Routing Box 810, and
- Company C will use Routing Box 820.

Add the following lines to the top of the TRANS.TXT file.

```
a7byczd740 = 800
a7byczd741 = 800
a7byczd742 = 810
a7byczd743 = 810
a7byczd744 = 810
a7byczd745 = 820
a7byczd746 = 820
a7byczd747 = 820
```

Example 2: Incoming CO lines ring a UCD group first then re-route to Voice Mail if no one answers.

1. Set the Day answering positions to their respective UCD group numbers.

- CO Lines 1& 2 will be answered by UCD group 415
- CO Lines 3, 4, & 5 will be answered by UCD group 416
- CO Lines 6, 7, & 8 will be answered by UCD group 417

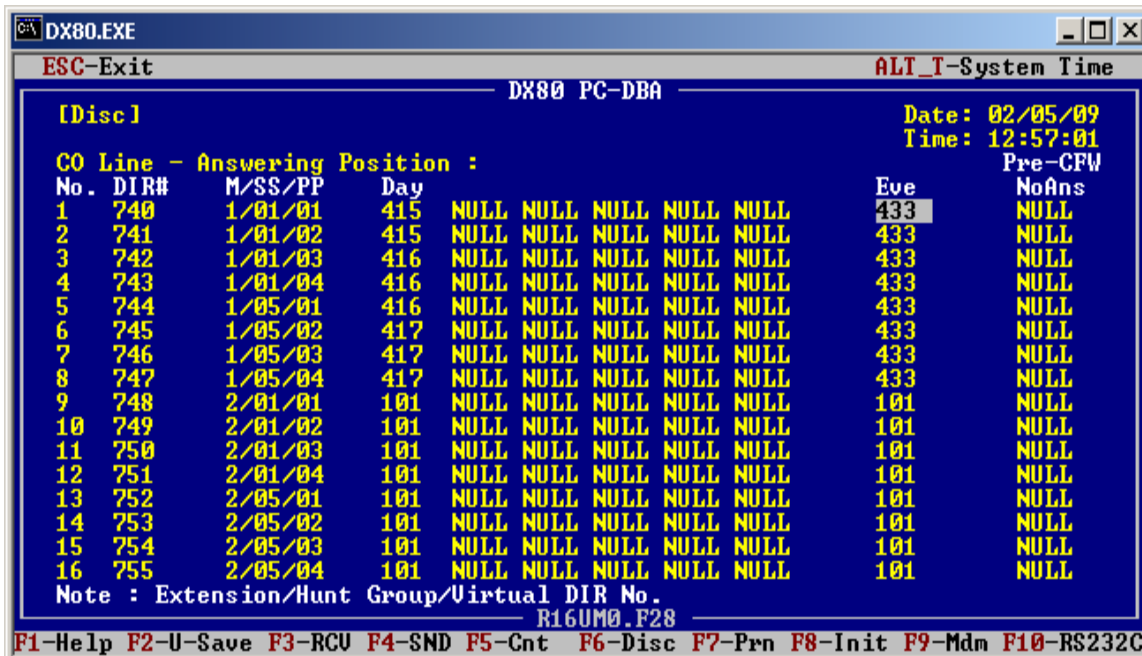

The following UCD group 6 (dir 415) will ring all phones approximately three to four rings, then re-route to Voice Mail with the following in-band digits.

```
a9b2d63
```

The following line is needed at the top of the TRANS.TXT file.

```
a9b2d63 = 800
```

```

DX80.EXE
ESC-Exit                                ALT_I-System Time
----- DX80 PC-DBA -----
[Disc]                                     Date: 02/05/09
                                           Time: 12:44:42
Uniform Call Distribution - Parameter Programming: Hunt Group 6
Attribute      :UCD          <UCD/U.A.>
Tenant Group   :1           <1-3>
Name           :Comp A      <'0'-'9','A'-'Z','a'-'z',Space>
Member         :---->      <EXT DIR No.>
Hunting Method :All Ring    <All Ring/Linear/Distributed>
No Answer Timer:10         <5-60 sec>
Overflow 1 Timer:10        <0-255 sec>
Overflow 1 Dest.:NULL      <EXT/Hunt Gp. DIR No.>
Overflow 2 Timer:0         <0-255 sec>
Overflow 2 Dest.:NULL      <EXT/Hunt Gp. DIR No.>
Overflow Count :1          <1-128 times>
Re_Route Dest. :433        <EXT/Hunt Gp. DIR No.>
----- R16UM0.F28 -----
F1-Help F2-U-Save F3-RCU F4-SND F5-Cnt F6-Disc F7-Prn F8-Init F9-Mdm F10-RS232C

```

The following UCD group 7 (dir 416) will ring all phones approximately three to four rings, then re-route to Voice Mail with the following in-band digits.

```
a9b2d73
```

The following line is needed at the top of the TRANS.TXT (C:\VM\TRANS.TXT) file.

```
a9b2d73 = 810
```

```

DX80.EXE
ESC-Exit                                ALT_I-System Time
----- DX80 PC-DBA -----
[Disc]                                     Date: 02/05/09
                                           Time: 12:46:10
Uniform Call Distribution - Parameter Programming: Hunt Group 7
Attribute      :UCD          <UCD/U.A.>
Tenant Group   :1           <1-3>
Name           :Comp B      <'0'-'9','A'-'Z','a'-'z',Space>
Member         :---->      <EXT DIR No.>
Hunting Method :All Ring    <All Ring/Linear/Distributed>
No Answer Timer:10         <5-60 sec>
Overflow 1 Timer:10        <0-255 sec>
Overflow 1 Dest.:NULL      <EXT/Hunt Gp. DIR No.>
Overflow 2 Timer:0         <0-255 sec>
Overflow 2 Dest.:NULL      <EXT/Hunt Gp. DIR No.>
Overflow Count :1          <1-128 times>
Re_Route Dest. :433        <EXT/Hunt Gp. DIR No.>
----- R16UM0.F28 -----
F1-Help F2-U-Save F3-RCU F4-SND F5-Cnt F6-Disc F7-Prn F8-Init F9-Mdm F10-RS232C

```

Troubleshooting Installation Issues

The following UCD group 8 (dir 417) will ring all phones approximately three to four rings then Re-Route to Voice Mail with the following in-band digits a9b2d83. The following line is needed at the top of the TRANS.TXT file.

```
a9b2d83 = 820
```

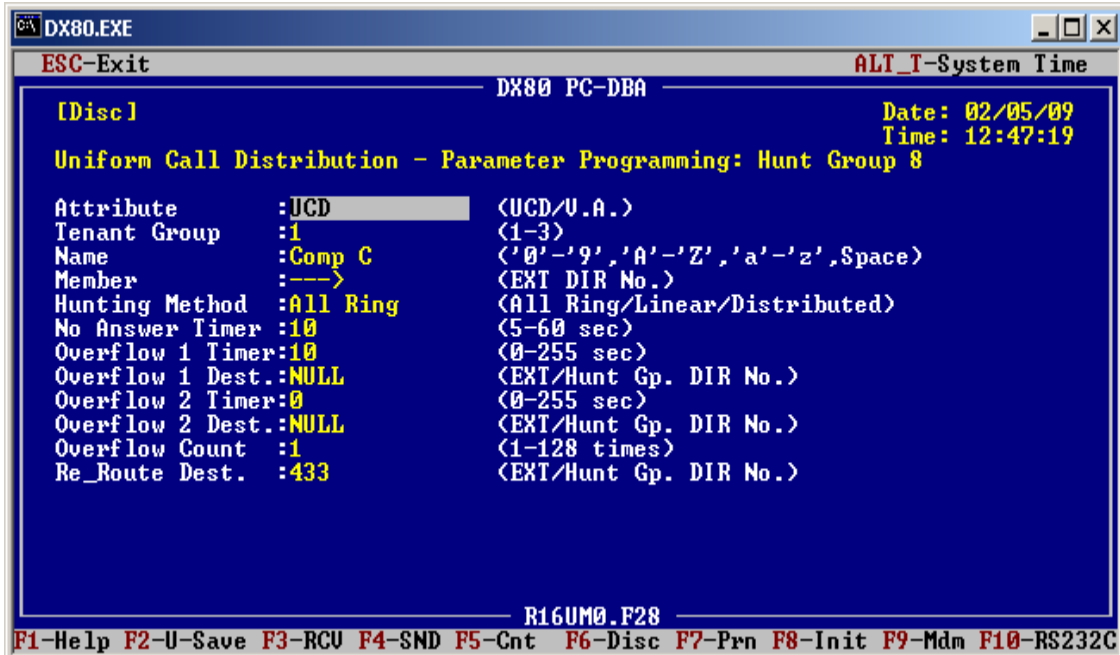

The screenshot shows a DOS-style window titled "DX80.EXE" with a blue background and white text. The window title bar includes "ESC-Exit" on the left and "ALT_I-System Time" on the right. The main content area displays the following information:

```
[Disc]                                     Date: 02/05/09
                                           Time: 12:47:19
Uniform Call Distribution - Parameter Programming: Hunt Group 8

Attribute      :UCD          <UCD/U.A.>
Tenant Group   :1          <1-3>
Name           :Comp C     <'0'-'9', 'A'-'Z', 'a'-'z', Space>
Member         :---->     <EXT DIR No.>
Hunting Method :All Ring   <All Ring/Linear/Distributed>
No Answer Timer:10        <5-60 sec>
Overflow 1 Timer:10      <0-255 sec>
Overflow 1 Dest.:NULL    <EXT/Hunt Gp. DIR No.>
Overflow 2 Timer:0      <0-255 sec>
Overflow 2 Dest.:NULL    <EXT/Hunt Gp. DIR No.>
Overflow Count :1        <1-128 times>
Re_Route Dest. :433      <EXT/Hunt Gp. DIR No.>
```

At the bottom of the window, there is a status bar with the text "R16UM0.F28" and a row of function key shortcuts: "F1-Help F2-U-Save F3-RCU F4-SND F5-Cnt F6-Disc F7-Prn F8-Init F9-Mdm F10-RS232C".

4.8 Setting Up Message Delivery to a Cell Phone

SOLUTION: External Transfers with Voice Mail

1. If the system has In-Skin or analog voice mail, and uses Centrex transfer on the same CO line, go to the Call Transfer Information screen in PC-DBA. Then enter the following values in the External column.
 - Sequence to initiate a transfer: !,#3,,
 - Sequence to complete a transfer: !,#3,,
 - Sequence to transfer a 3-way call: !,#3,,

```

REMOTE.EXE
8-line          U 8.5          Serial number: 30P8M71708

CALL TRANSFER INFORMATION

INTERNAL          EXTERNAL
Sequence to initiate a transfer : :#3,,
Sequence to complete a transfer : :#3,,
Sequence to transfer 3-way call : :#3,,
Sequence to return from busy: :
Sequence to return from no-ans : :
Sequence to return call screening: :!

Detect dial tone?      Yes
Detect call-progress tones? Yes

Use transfer bypass digit ? Last digit

DIGITS THAT MEAN YES, WHEN ASKING FOR CONFIRMATION 1

Max time for 3-way call (mins) : 15

F1=Help  PgUp=Previous field  PgDn=Next Field  F10=System Info Menu

```

If the system DX80 3-way call transfer or analog voice mail 3-way call transfer, and uses one voice mail port with two CO lines, go to the Call Handling screen in PC-DBA. Enter the following values in the Unsupervised talk time column.

- Sequence to initiate a transfer: !,9,
- Sequence to complete a transfer: !,3,
- Sequence to transfer a 3-way call: !,3,

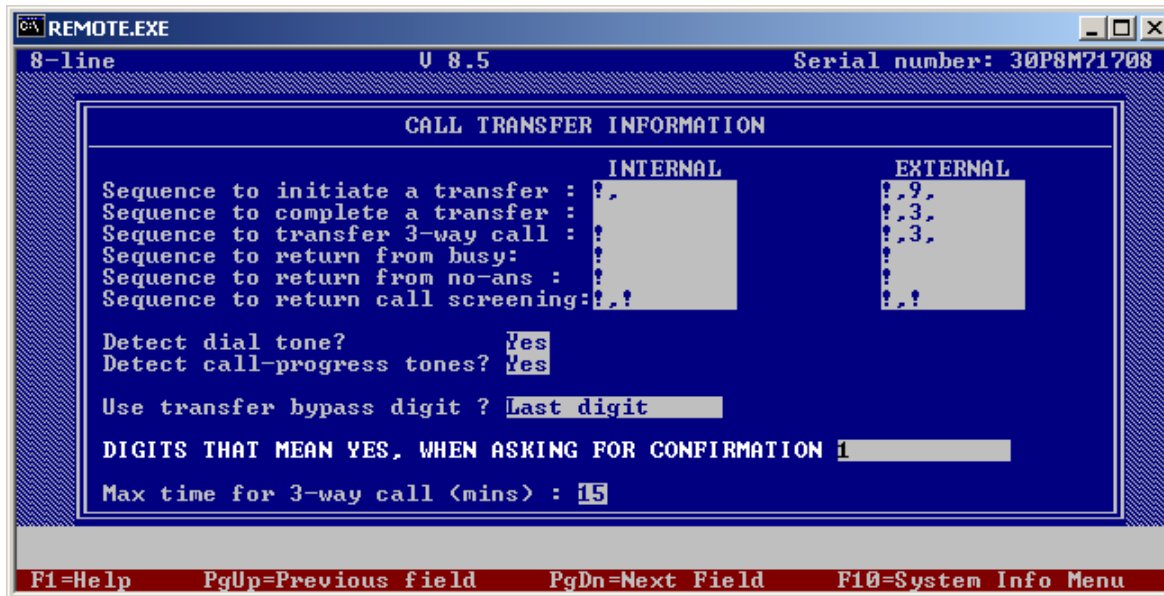

- Next, you must enable ECF. Go to the DX80 Extension – Category 2 PC-DBA screen and enter Y in the ECF Operation field.

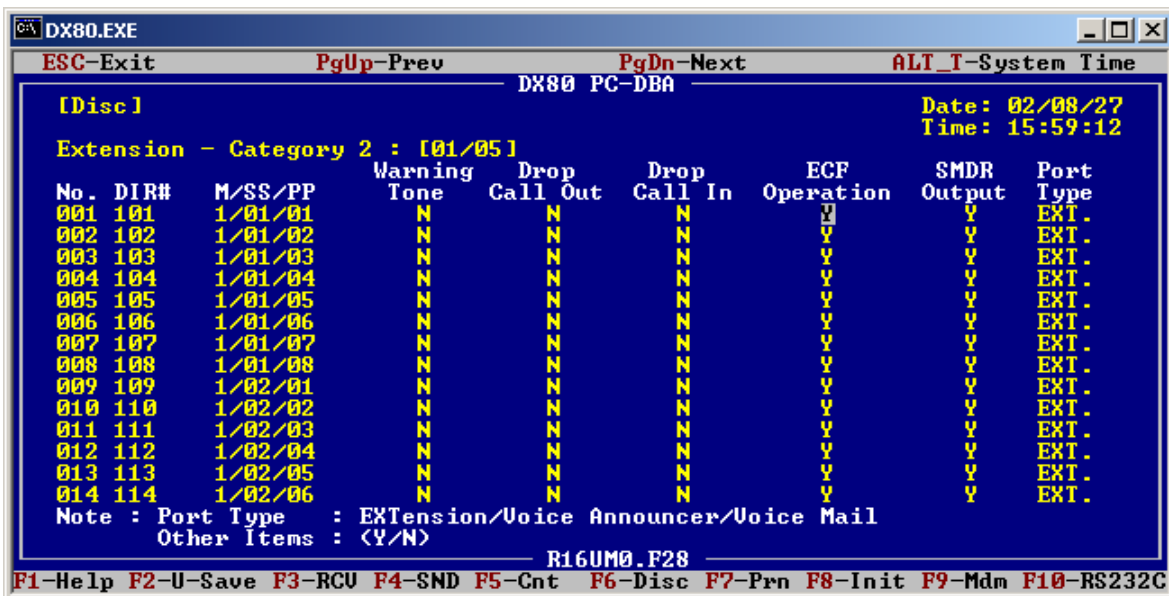

- Finally, using the phone dial into the programming mode and enter 01-(101~156)-18. The range of numbers in the middle of this command represent the station number. So, to program station 102 you would enter 01-102-18, to program station 123 you would enter 01-123-18, etc.

4.9 Using Prime CO Instead of Intercom with Modem or Fax

SOLUTION: Analog Prime Line—Setting Up A Prime Line for a FAX Connected to an Analog Port Using CO line 4.

1. Place line 4 (743) into CO group2 (800).
2. From the Fax machine, go off hook and dial 800 (be sure you are accessing line 4). Then dial a valid number. You must dial out on that line /(line group) before programming the hot line (dial 740 for line 1, 741 for line 2, 742 for line 3 etc....).
3. Program a System Speed dial bin with a pause. To do this, you can use PCDBA or program using the phone.

Using PCDBA

Go to the DX80 PC-DBA System Resource SPD. No. Programming Tenant 1screen in PCDBA. Choose a system speed dial bin (DIR#s 500-699), and insert a P for pause in its SPD. No. field.

```

ESC-Exit          PgUp-Prev          PgDn-Next          ALT_I-System Time
-----
[Disc]
System Resource - SPD. No. Programming : System [001/020]
Date: 02/08/27
Time: 16:01:32

No.  DIR#    SPD. No.
0001 500      P
0002 501      NULL
0003 502      NULL
0004 503      NULL
0005 504      NULL
0006 505      NULL
0007 506      NULL
0008 507      NULL
0009 508      NULL
0010 509      NULL

Note : 0-9 / * / # / Pause<P> / Chain<E> / Flash</>
R16UM0.F28
F1-Help F2-U-Save F3-RCU F4-SND F5-Cnt F6-Disc F7-Prn F8-Init F9-Mdm F10-RS232C

```

Using the Telephone

Dial into the programming mode and enter the following commands.

*FEATURE # **

Enter the password. The default is *#####*.

Show

04-09-1 [Tenant 1]

Save

500~699 [System Speed dial bin number]

Show

Chg

Feature 7 0

Save

4. From the fax machine extension, go off hook and program the fax extension as a hot line to that system speed dial bin number.

Dial (# 9 * 500 0). Confirmation tone is heard.

5. Every time the fax machine goes off hook, line 4 will be accessed.

To cancel do a hook flash and dial # * 9 *.

4.10 Digits Passed Inband to the Voice Mail in an Overflow 1 Condition

SOLUTION: UCD Overflow 1 Integration to Voice Mail

The following table shows what the switch passes inband to the Voice Mail during an Overflow 1 condition.

Table 1-1 Overflow from UCD groups / In band Strings / Digits Received

Hunt Group #	UCD#	In-Skin	Associated VM Routing Box
1	410	a9byd1	3101
2	411	a9byd2	3102
3	412	a9byd3	3103
4	413	a9byd4	3104
5	414	a9byd5	3105
6	415	a9byd6	
7	416	a9byd7	
8	417	a9byd8	
9	418	a9byd9	
10	419	a9byd0	
11	420	a9byd*	
12	421	a9byd#	
13	422	a9byda	
14	423	a9bydb	
15	424	a9bydc	
16	425	a9bydd1	
17	426	a9byd11	
18	427	a9byd21	
19	428	a9byd31	
20	429	a9byd41	
21	430	a9byd51	
22	431	a9byd61	
23	432	a9byd71	
24	433	a9byd81	Voice Mail UCD

4.11 Digits Passed Inband to the Voice Mail in an Overflow 2 Condition

SOLUTION: UCD Overflow 2 Integration to Voice Mail

The following table shows what the switch passes inband to the Voice Mail during an Overflow 2 condition.

Table 1-2 Overflow from UCD groups / In band Strings / Digits Received

Hunt Group #	UCD #	In-Skin	Associated VM Routing Box
1	410	a9byd91	3201
2	411	a9byd01	3202
3	412	a9byd*1	3203
4	413	a9byd#1	3204
5	414	a9byda1	3205
6	415	a9bydb1	
7	416	a9bydc1	
8	417	a9bydd2	
9	418	a9byd12	
10	419	a9byd22	
11	420	a9byd32	
12	421	a9byd42	
13	422	a9byd52	
14	423	a9byd62	
15	424	a9byd72	
16	425	a9byd82	
17	426	a9byd92	
18	427	a9byd02	
19	428	a9byd*2	
20	429	a9byd#2	
21	430	a9byda2	
22	431	a9bydb2	
23	432	a9bydc2	
24	433	a9bydd3	Voice Mail UCD

4.12 Digits Passed Inband to the Voice Mail in a Re-Route Condition

SOLUTION: UCD ReRoute Integration to Voice Mail

The following table shows what the switch passes inband to the Voice Mail during a re-route condition.

Table 1-3 Transferring to UCD groups / In band Strings / Digits Received

Hunt Group #	UCD #	In-Skin	External Voice Mail
1	410	a9b2d13	348
2	411	a9b2d23	349
3	412	a9b2d33	350
4	413	a9b2d43	351
5	414	a9b2d53	352
6	415	a9b2d63	353
7	416	a9b2d73	354
8	417	a9b2d83	355
9	418	a9b2d93	356
10	419	a9b2d03	357
11	420	a9byd*3	358
12	421	a9byd#3	359
13	422	a9byda3	360
14	423	a9bydb3	361
15	424	a9bydc3	362
16	425	a9bydd4	363
17	426	a9b2d14	364
18	427	a9b2d24	365
19	428	a9b2d34	366
20	429	a9b2d44	367
21	430	a9b2d54	368
22	431	a9b2d64	369
23	432	a9b2d74	370
24	433	N/A	Voice Mail UCD

This Page Intentionally Left Blank

Index

Numerics

408E 20, 47, 48
408M 18, 47, 48

A

AAM 56
 installation 56
AAM (Automated Attendant Module) 26
Adding a COM4 53
Adding a DPM8 49
Adding a KSU2 Second Cabinet 58
Adding a Music Source 60
Adding an AAM 56
Adding an APM4 50
Adding an External Pager 62
Adding an MDM 55
Adding Hardware to an Existing System (Making Sure the DX 80 Recognizes It) 100
Adding Loud Bell Control or Gate Control 63
add-on modules, KSU assembly 48
APM4 50
 adding 50
APM4 (Analog Port Module - 4 Circuits) 21
A-save 79
Assembling the MDF 42
Auto Attendant
 AAM 26

B

Block Control 97

C

Cable 78
 cable connections 78
 call handling performance, optimum 103
 cell phone message delivery 111
 cold start 67, 97
COM4 53
 installation 53
COM4 (Central Office Module - 4 Circuits) 24
Communicating with the System 78
Configuration 84
configuration 13
connect 80
Connecting a Serial Cable for PC-DBA 64
Connecting a Serial Cable for SMDR 66
connection, modem 82
Corrupted Database on Initial System Setup 99
CPM (Central Processor Module) 17
Current draw 29

D

DET (Digital Executive Telephone) 26
Diagnostics 87

Digits Passed Inband to the Voice Mail in a Re-Route Condition 116
Digits Passed Inband to the Voice Mail in an Overflow 1 Condition 114
Digits Passed Inband to the Voice Mail in an Overflow 2 Condition 115
disconnect 81
Disconnecting from the DX-80 processor 81
DPM8 49
DPM8 (Digital Port Module - 8 Circuits) 23
DSS (Direct Station Selection Terminal) 28
DX-80 processor
 disconnecting from 81

E

Electrical data 33
Ensuring Optimum Call Handling Performance 103
Entering into PC-DBA Maintenance 77
Environmental data 33
Establishing a Modem Connection 82
Event 94
external music source 61
external pager
 installation 62
External Pager Installation Procedure 62
external pager, adding 62
External Voice Mail
 Debut-Small Office Lite 106

F

F1 - Help 79
F10-RS232C 82
F2 - A-Save 79
F3 - Receive 79
F4 - Send 79
F5 - Connect 80
F6 - Disconnect 81
F7 - Print 81
F8 - Initialize 81
F9 - Mdm 82
figures
 AAM (Automated Attendant Module) 26
 APM4 (Analog Port Module - 4 Circuits) 21
 COM4 (Central Office Module - 4 Circuits) 24
 DET (Digital Extension Terminal) 27
 Direct Station Selection (DSS) Console 28
 DPM8 (Digital Port Module - 8 Port) 23
 DX-80 Key Service Unit 16
 DX-80 KSU2 20
 KSU1 19
 MDM (Modem Module) 25
 power supply 17

G

gate control
 installation 63
gate control, loud bell 63

help 79

H

I

I/O Memory Mapping 98
initialization, power-up 67
initialize 81
installation 39
 AAM 56
 add-on modules 48
 APM4 50
 COM4 53
 environmental conditions 40
 external pager 62
 gate control 63
 KSU assembly 48
 KSU components 42, 48
 KSU2 58
 loud bell control 63
 Main Distribution Frame 42
 MDF wiring 44
 MDM 55
 mounting the KSU 43
 music source 60
 outline 39
 site planning 40
 tools and supplies 41
 typical MDF installation 46
Installation Overview 39
installation, trouble shooting 99
installing external music source to MC1/MC2/both 61
Installing the DX-80 39
internal music, selecting 60
Invalid Entries Calling a Busy Station 102
Issues with Multiple Mailbox Greetings 102

K

Key Service Unit 15
KSU Assembly, Add-on Modules 48
KSU Components 47
KSU Components and Installation 42
KSU configuration 15
KSU Wiring 44
KSU1 408M and KSU2 408E 47
KSU1 components 13
KSU2 47, 58
 installation 58
KSU2 components 13

L

Loading PC-DBA software 77
Logon Data 95
loud bell 63
loud bell control
 installation 63
Loud Ringing Bell Installation Procedure 63

M

Maintenance 71

 maintenance 71
Maintenance and Trouble Shooting 71
Maintenance Utilities 76, 83
MC1 60, 61
MC2 61
MDF
 installation 42
MDF preparation 42
MDF wiring 44
MDM 55
 installation 55
MDM (Modem Module) 25
memory mapping, I/O 98
modem 78
modem connect 82
modem connection 82
Modem connection to the DX-80 82
Mounting the KSU 43
MTBF (Mean-Time Between Failure) data 38
multiple mailbox greetings 102
music source installation 60
music source, adding 60
music source, external 61
music tune 60

N

no legal member 100
No MDF 45

O

Optional System Modem 78
overflow1 114
overflow2 115
Overview 11

P

pager, external 62
paging system installation 62
Pass-Through Communications with Corporate Office
 DX 79
PC8-Inskin 105
PC-DBA 77
 connecting serial cable for 64
 loading 77
PC-DBA Control Menu 79
PC-DBA serial cable 64
performance, call handling 103
power supply 16
power up initialization 67
Power-up Initialization (Cold Start) 67
Preparing the Main Distribution Frame 42
prime CO 112
print 81

R

receive 79
Remote connection to the DX-80 82
Remote Control 96
Replacing a 408M or 408E 48
re-route 116

Ringling a Group Of Phones Before Routing the Call to
Auto-Attendant 104
RS232 82

S

second cabinet, adding 58
selecting internal music tune for music channel MC1 60
send 79
serial cable for PC-DBA 64
serial cable installation procedure 64, 66
serial cable, SMDR 66
Setting Up Message Delivery to a Cell Phone 111
Signaling (internal) data 36
Site Planning 40
SMDR
 connecting serial cable for 66
SMDR, serial cable 66
Software Cold Start 97
Software Warm Start 97
Specifications
 Current draw 29
 Electrical data 33
 Environmental data 33
 MTBF (Mean-Time Between Failure) data 38
 Signaling (internal) data 36
 System criteria and capacity 30
 Wiring data 35
Status 91
supplies needed for installation 41
symptoms, trouble shooting 71
System criteria and capacity 30
system initialization 67
System Maintenance 71
System Technology 11

T

Technical Problem Solving 71
Tools and Supplies 41
trouble shooting 71
trouble shooting symptoms 71
Troubleshooting Installation Issues 99
Typical MDF Installation 46

U

User maintenance 71
Using Multiple Lines and Assigning Different Auto-
Attendant Greetings for Each Line 106
Using Prime CO Instead of Intercom with Modem or
Fax 112
utilities 83

V

Voice Mail Doesn't Work (No Legal Member) 100
voice processing modules 14

W

warm start, software 97
Wiring data 35

