



at&t

User's manual

**TL72108/TL72208/**

**TL72308/TL72408**

**5.8 GHz cordless**

**telephone/answering system**

**with caller ID/call waiting**



# Congratulations

on your purchase  
of this AT&T product.

Before using this AT&T product, please  
read the **Important safety information**  
on pages 65-67 of this manual.

Please thoroughly read this user's  
manual for all the feature operations  
and troubleshooting information necessary  
to install and operate your new  
AT&T product. You can also visit our  
website at **www.telephones.att.com** or call  
**1 (800) 222-3111.**

In Canada, dial **1 (866) 288-4268.**

Model #: TL72108 (single handset)/TL72208 (two handsets)/  
TL72308 (three handsets)/TL72408 (four handsets)

Type: 5.8 GHz cordless telephone/answering system

Serial #: \_\_\_\_\_

Purchase date: \_\_\_\_\_

Place of purchase: \_\_\_\_\_

Both the model and serial number of your AT&T product can be found on the  
bottom of the telephone base.

Save your sales receipt and original packaging in case it is necessary to return  
your telephone for warranty service.

# Parts checklist

Save your sales receipt and original packaging in case it is necessary to ship your telephone for warranty service.

Your telephone package includes the following items.

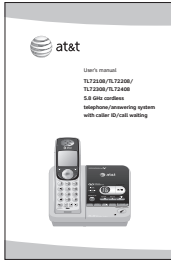

User's manual

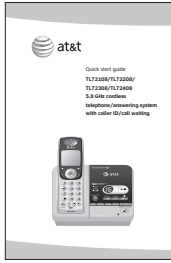

Quick start guide



Cordless handset  
(One for TL72108)  
(Two for TL72208)  
(Three for TL72308)  
(Four for TL72408)



Telephone base with mounting bracket installed



Charger for cordless handset  
(One for TL72208)  
(Two for TL72308)  
(Three for TL72408)



Battery for cordless handset  
(One for TL72108)  
(Two for TL72208)  
(Three for TL72308)  
(Four for TL72408)



Battery compartment cover  
(One for TL72108)  
(Two for TL72208)  
(Three for TL72308)  
(Four for TL72408)



Power adapter for telephone base



Power adapter for handset charger  
(One for TL72208)  
(Two for TL72308)  
(Three for TL72408)



Belt clip for cordless handset  
(One for TL72108)  
(Two for TL72208)  
(Three for TL72308)  
(Four for TL72408)



Telephone line cord

**TL72108/TL72208/  
TL72308/TL72408  
5.8 GHz cordless  
telephone/answering system  
with caller ID/call waiting**



Table of contents

**Getting started**

- Quick reference guide
  - handset..... 2
  - telephone base..... 3
- Installation preparation ..... 4
- Telephone base & charger
  - installation ..... 5
- Battery installation & charging .... 6
- Belt clip & optional headset..... 7
- Installation options..... 8

**Telephone operation**

- Handset operation..... 12
- Options while on calls..... 15
- Chain dialing ..... 17
- Intercom ..... 18
- Call transfer using intercom..... 19
- Handset settings ..... 20

**Directory**

- Directory..... 25
- New directory entries ..... 26
- Directory review ..... 28
- Directory search ..... 29
- To dial, delete or edit entries..... 30

**Caller ID operation**

- Caller ID operation ..... 31
- Caller ID history..... 34

**Answering system operation**

- About the answering system .... 36
- Day & time announcement ..... 38
- Answering system mode..... 39
- Outgoing announcements..... 40
- Answering system setup ..... 42
- Message playback..... 46
- Recording & playing memos ..... 47
- Message counter displays ..... 48
- Remote access ..... 49

**Appendix**

- Screen icons, indicator
  - lights & tones..... 51
- Handset display screen
  - messages..... 52
- Adding and registering
  - handsets..... 54
- Replacing a handset..... 55
- Troubleshooting..... 56
- Maintenance ..... 64
- Important safety information.... 65
- FCC Part 68 and ACTA ..... 68
- FCC Part 15..... 70
- Limited warranty ..... 71
- Technical specifications..... 74
- Index..... 75

# Quick reference guide - handset

## CHARGE

On when the handset is charging in the telephone base or charger.

## CID

Press to display caller ID information (page 34).

## PHONE/FLASH

Press to make or answer a call.  
During a call, press to receive an incoming call if call waiting is activated (page 15).

## REDIAL/PAUSE

Press to view redial memory (page 13).  
While entering numbers, press and hold to insert a dialing pause (page 26).

## MUTE/REMOVE

During a call, press to mute microphone (page 16).  
While reviewing the caller ID history, press to delete an individual entry, or press and hold to clear the caller ID history (page 34).  
While predialing, press to delete digits (page 12).

## SPEAKER

Press to turn on the handset speakerphone.  
Press again to resume normal handset use (page 12).

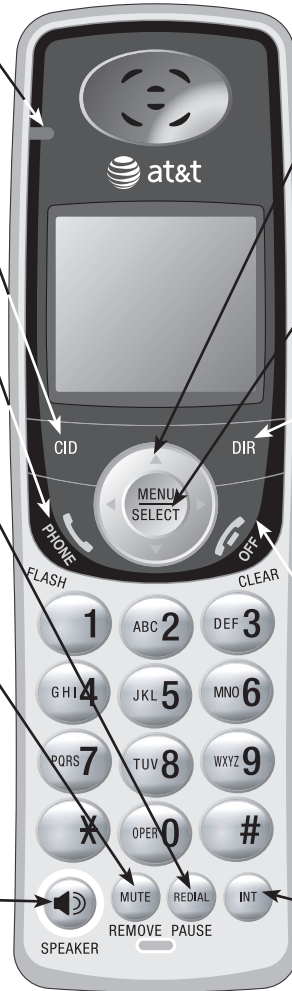

Press or to scroll up or down while in menus. While entering names or numbers, press or to move the cursor to the left or right.

## MENU/SELECT

Press to enter the menu. While in the menu, press to select an item or save an entry or setting.

## DIR

Press to display directory entries (page 28).

## VOLUME ▲▼

Press the volume key on the side of the handset to adjust listening volume. Each press of the button increases or decreases the volume.

## OFF/CLEAR

During a call, press to hang up.  
While using menus, press to cancel an operation, back up to the previous menu, or exit the menu display.

## INT

Press to begin an intercom conversation or to transfer a call (pages 18-19).

## Feature menu

The > symbol shows a highlighted menu item.



## Feature menu

- DIRECTORY (page 25)
- CALL LOG (page 31)
- RINGER VOLUME (page 20)
- RINGER TONE (page 21)
- KEY TONE (page 21)
- LANGUAGE (page 22)
- CLR VOICE MAIL (page 23)

## Using menus

Press or to scroll through menu items.

Press **MENU/SELECT** to select or modify a highlighted item.

Press **OFF/CLEAR** to cancel an operation, back up to the previous menu, or exit the menu display.

# Quick reference guide - telephone base

## IN USE

- On when handset is in use, when the answering system is answering an incoming call or when you are registering a handset.
- Flashes when another telephone is in use on the same line or when you are deregistering handset(s) from the telephone base.
- Flashes quickly when there is an incoming call.



## VOICEMAIL

Flashes when you have new voicemail. Voicemail is a service offered by your local telephone company, and is different from answering system messages (page 23).

## HANDSET LOCATOR

Press so that handsets will beep to locate misplaced handsets (page 14).

## Answering System Functions

### MESSAGE COUNTER

Number of messages (or during playback, message number currently playing).

### ◀/REPEAT

Press to repeat message. Press **twice** to play previous message (page 46).

### ANSWER ON

Press to turn answering system on or off (page 39).

### CLOCK

Press to review or set clock (page 38).

### SETUP

Press to hear and change setup options (pages 42-45).

### ANNC.

Press to review or record outgoing announcement. Press again to end announcement playback or recording (pages 40-41).



### ▶/■ PLAY/STOP

Press to start or stop message playback (page 46).

### X/DELETE

Press to delete the message currently playing. When no messages are playing, press twice to delete all old messages (page 46).

### ▶▶/SKIP

Press to skip message (page 46).

### VOLUME

Press to adjust playback volume (page 46).

### RECORD

Press to record a memo (page 47) or, after pressing **ANNC.**, to record an outgoing announcement (pages 40-41).

## Installation preparation

You must install and charge the battery before using the telephone.



See page 6 for easy instructions.

If you subscribe to high-speed Internet service (Digital Subscriber Line - DSL) through your telephone lines, you must install a DSL filter between the telephone base and the telephone wall jack (see page 5). The filter will prevent noise and caller ID problems caused by DSL interference. Please contact your DSL service provider for more information about DSL filters.

Your product may be shipped with a protective sticker covering the handset or telephone base display - remove it before use.

For customer service or product information, visit our website at **[www.telephones.att.com](http://www.telephones.att.com)** or call **1 (800) 222-3111**. In Canada, dial **1 (866) 288-4268**.

### **Avoid placing the telephone base too close to:**

- Communication devices such as: television sets, VCRs, or other cordless telephones.
- Excessive heat sources.
- Noise sources such as a window with traffic outside, motors, microwave ovens, refrigerators, or fluorescent lighting.
- Excessive dust sources such as a workshop or garage.
- Excessive moisture.
- Extremely low temperature.
- Mechanical vibration or shock such as on top of the washing machine or work bench.

## Telephone base & charger installation

If you subscribe to high-speed Internet service (Digital Subscriber Line - DSL) through your telephone lines, you must install a DSL filter between the telephone base and the telephone wall jack. The filter will prevent noise and caller ID problems caused by DSL interference. Please contact your DSL service provider for more information about DSL filters.

Install the telephone base as shown below.

### Telephone base installation

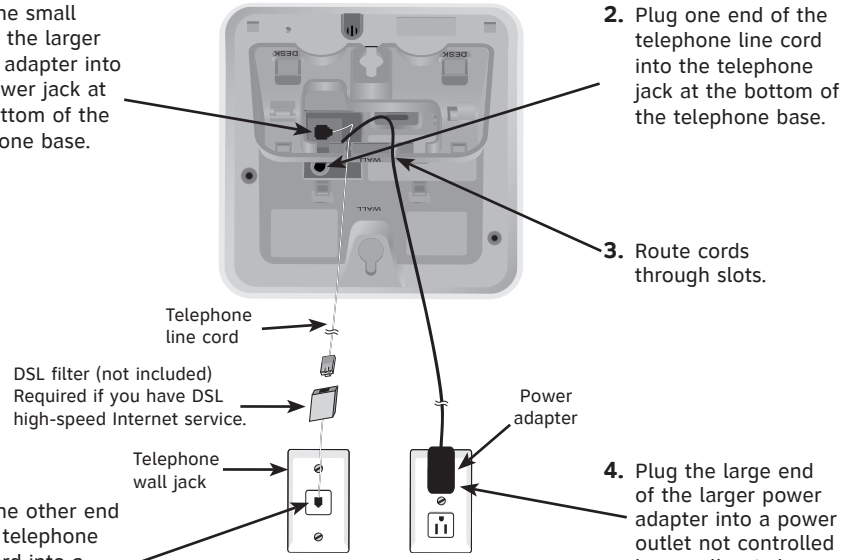
1. Plug the small end of the larger power adapter into the power jack at the bottom of the telephone base.
  2. Plug one end of the telephone line cord into the telephone line jack at the bottom of the telephone base.
  3. Route cords through slots.
  4. Plug the large end of the larger power adapter into a power outlet not controlled by a wall switch.
  5. Plug the other end of the telephone line cord into a telephone wall jack.
- 

### Charger installation

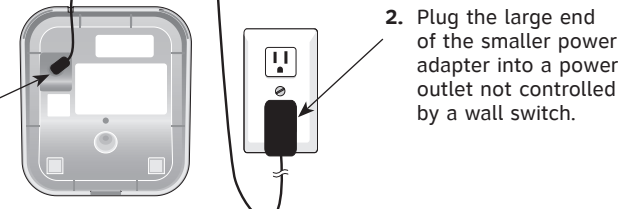
1. Plug the small end of the smaller power adapter into the jack on the underside of the charger, then route the cord through the slot as shown.
  2. Plug the large end of the smaller power adapter into a power outlet not controlled by a wall switch.
- 

### IMPORTANT INFORMATION

1. Use only the power adapter supplied with this product. To order a replacement power adapter, visit our website at [www.telephones.att.com](http://www.telephones.att.com), or call **1 (800) 222-3111**. In Canada dial **1 (866) 288-4268**.
2. The power adapters are intended to be correctly oriented in a vertical or floor mount position. The prongs are not designed to hold the plug in place if it is plugged into a ceiling, under-the-table or cabinet outlet.



## Battery installation & charging

Install the battery as shown below. After installing the battery, you can make and receive short calls, but replace the handset in the telephone base or additional charger when not in use. For optimal performance, charge the handset battery for at least 16 hours before use. When fully charged, the handset battery provides approximately five hours of talk time or three days of standby time.

If the battery is depleted, it may take approximately four minutes to charge the handset before it can resume screen display. The screen will continue to display **LOW BATTERY** until the battery has charged for approximately one hour.

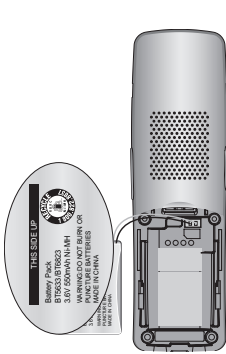

### Step 1

Plug the battery securely into the plug inside the handset battery compartment, matching the color-coded label.



### Step 2

Insert the supplied battery with the label **THIS SIDE UP** facing up as indicated.



### Step 3

Align the cover flat against the battery compartment cover, then slide it upwards until it clicks into place.

### Step 4

Charge the handset by placing the handset face up in the telephone base or in the additional charger. The **CHARGE** light will be on when charging.



## IMPORTANT INFORMATION

Use only the battery supplied with this product. To order a replacement or spare battery (AT&T model 27910, part number 89-0099-00-00) or equivalent, visit our website at [www.telephones.att.com](http://www.telephones.att.com), or call **1 (800) 222-3111**. In Canada dial **1 (866) 288-4268**.

## Belt clip & optional headset



### To attach the belt clip:

Snap the belt clip into the retaining tabs on both sides of the handset as shown in the figure.



### To remove the belt clip:

Gently lift either of the belt clip retaining tabs, shown in the figure, outwards to remove the belt clip from the handset.

For handsfree headset conversations, use any industry standard 2.5 mm headset (purchased separately). For best results, use an AT&T 2.5 mm headset. To purchase a headset, visit our website at **[www.telephones.att.com](http://www.telephones.att.com)** or call **1 (800) 222-3111**. In Canada, dial **1 (866) 288-4268**.

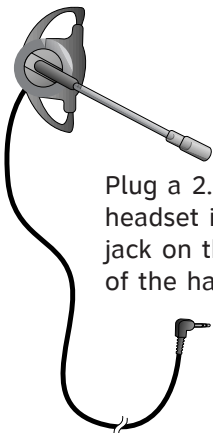

Plug a 2.5 mm headset into the jack on the side of the handset.



Lift the rubber flap here.

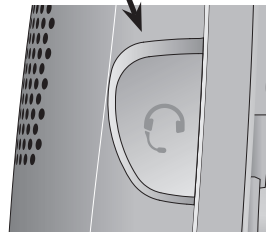

Side of handset.



## Installation options



**NOTE:** The mounting bracket must be used for both tabletop and wall mounting positions.

The telephone base comes with the mounting bracket already installed for desktop use. If wall mounting is desired, a telephone outlet wall mounting plate with mounting studs is required. This mounting plate with studs is available for purchase from many hardware or consumer electronics retailers and may require professional installation.

### Desktop to wall mount installation

To install the telephone base in the wall mount position, make sure that you unplug all cords connected to the telephone base before you begin.

1. Push the top of the bracket towards the back of the telephone base.

With the top of the bracket pushed up against the telephone base, the **WALL** labels will match.

Push down firmly on the bracket until it clicks into place.

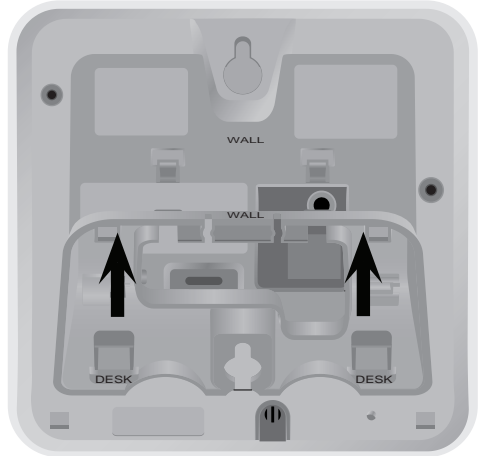

### Side view

Desk mode

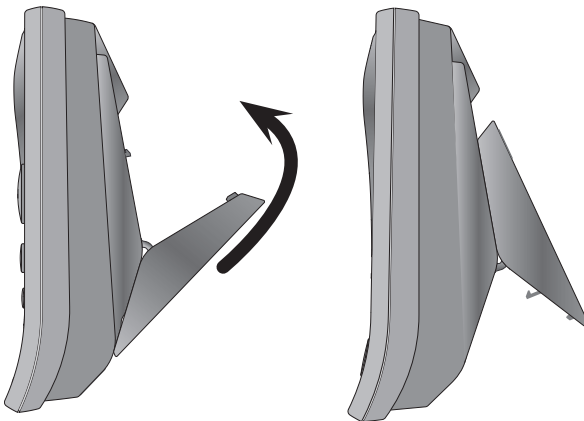

Wall mode

## Installation options

### Desktop to wall mount installation (continued)

2. Plug the telephone line cord and power adapter into the telephone base. Bundle the telephone line cord and power adapter cord, and secure them with a twist tie before placing them in the bracket channels.

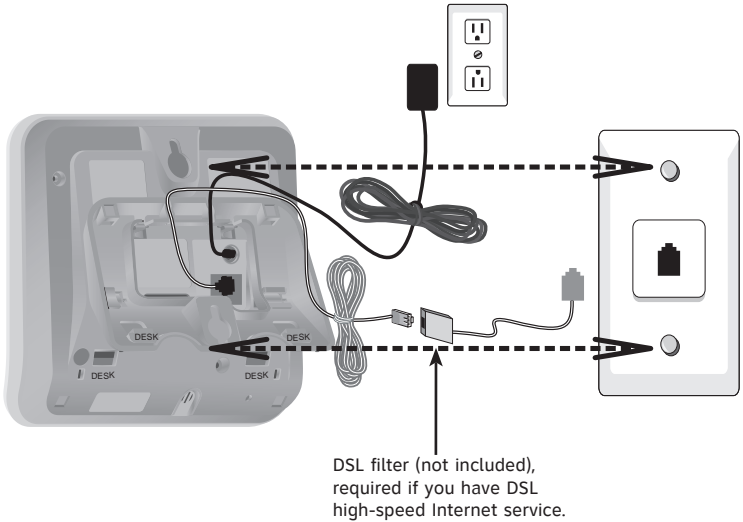

3. Place the bundled telephone line cord and power adapter cord into the cavity under the telephone base as shown below.

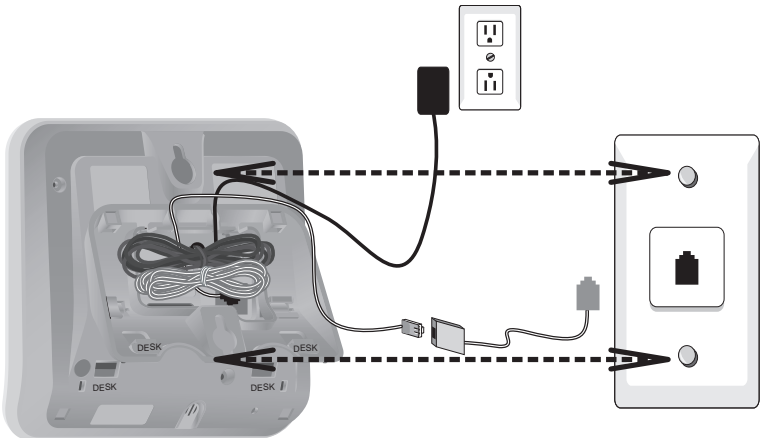

4. Plug the power adapter and telephone line cord into the wall outlets, then align the mounting studs on the telephone outlet plate with the mounting holes on the bracket.

## Installation options

### Wall mount to desktop installation

---

To change the telephone base from the wall mount position to desktop position.

1. Make sure that you unplug the power adapter and telephone line cord from the wall outlets before you begin.
2. Untie the bundled telephone cord and power adapter cord, and remove them from the telephone base.
3. Push the bottom of the bracket down towards the back of the telephone base.

With the bottom of the bracket pushed down against the telephone base, the **DESK** labels will match.

Push down on the bracket until it clicks into place.

#### Side view

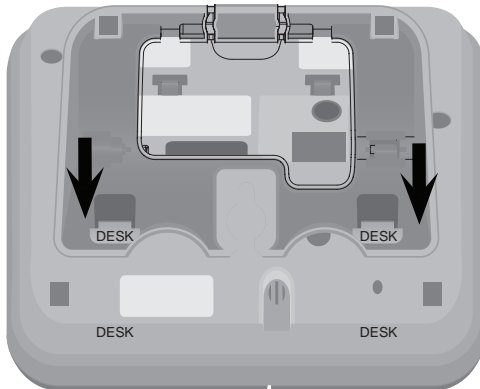
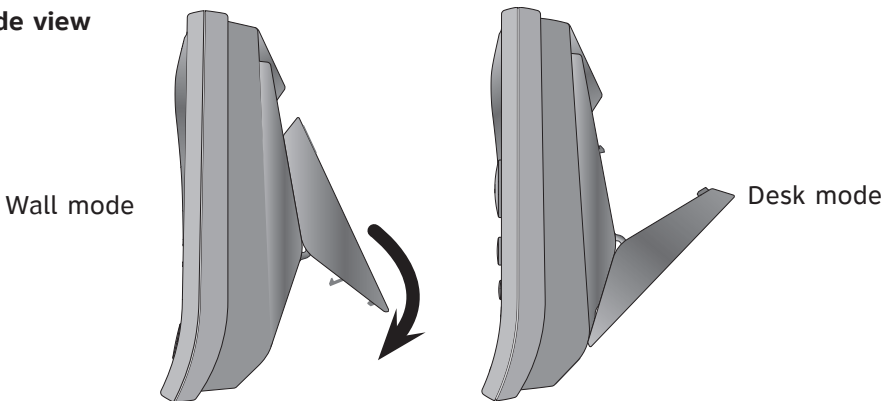

## Installation options

### Wall mount to desktop installation (continued)

4. Plug the telephone line cord into the telephone base and telephone wall jack, then plug the power adapter plug into the telephone base and an electrical wall outlet not controlled by a wall switch (see page 5) and place the cords in the bracket channels.

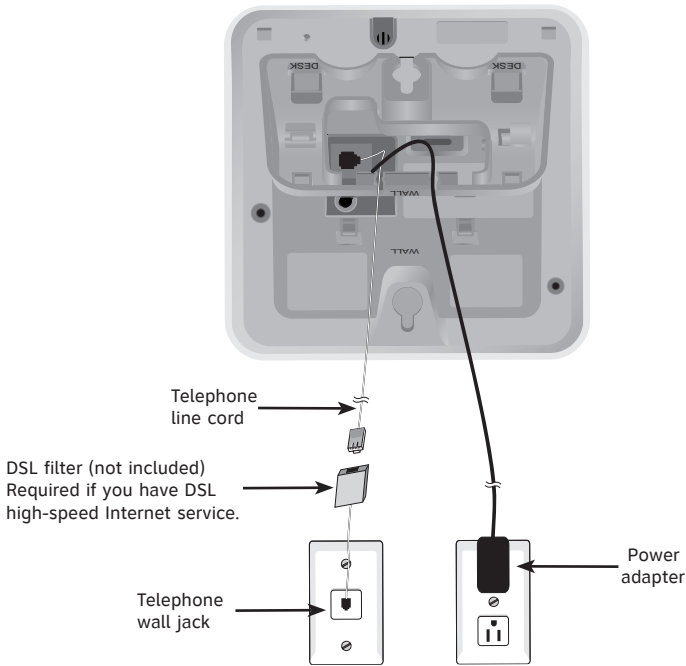

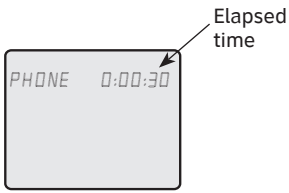

**i** **NOTE:** Pressing **PHONE/FLASH** to access services from your local telephone service provider will not affect the elapsed time.

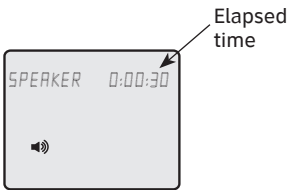

## Handset operation

### Making a call

---

To make a call:

- Press **PHONE/FLASH** or **SPEAKER**, then enter the telephone number.

To end a call:

- Press **OFF/CLEAR** or return the handset to the telephone base or charger.

The screen displays the elapsed time as you talk (in hours, minutes and seconds).

### On-hook dialing (predialing)

---

- Enter the telephone number. Press **MUTE/REMOVE** or **OFF/CLEAR** to make corrections as you enter the phone number.
- Press **PHONE/FLASH** or **SPEAKER** to dial.

### Handset speakerphone

---

During a call you can press **SPEAKER** to alternate between hands-free speakerphone and normal handset use. Press **OFF/CLEAR** to hang up.

**i** **NOTE:** If a headset is plugged into the handset, you will not be able to use the handset speakerphone.

### Answering a call

---

To answer a call:

- Press **PHONE/FLASH** or **SPEAKER**.
- OR–
- Press any dial pad key (0-9, \* or #).

To end a call:

- Press **OFF/CLEAR** or return the handset to the telephone base or charger.

## Handset operation

### Auto off



---

A call will be ended automatically when you put the handset in the telephone base or charger.

### Last number redial

---





To view the five most recently dialed numbers:

- Press **REDIAL/PAUSE** to display the most recently called number (up to 30 digits).
- Press ,  or **REDIAL/PAUSE** repeatedly to view up to five recently called numbers.

The handset will beep twice at the beginning and end of the list.

Press  **OFF/CLEAR** to exit.

To redial a number:

- Press  **PHONE/FLASH** or  **SPEAKER** to dial the displayed number.
- OR–
- Press  **PHONE/FLASH** or  **SPEAKER** then **REDIAL/PAUSE** to call the most recently called number (up to 30 digits).

Press **MUTE/REMOVE** to delete the displayed number from the redial memory.





## Handset operation

### Handset locator

The handset locator feature is useful if you misplace a handset.



To start the paging tone:

- Press  **HANDSET LOCATOR** at the telephone base. This starts the paging tone at the handset(s) for 60 seconds to help you locate the handset(s).



**NOTE:** When paging, if you press  **OFF/CLEAR** or **MUTE/REMOVE** on a handset, the ringer of the handset will be silent but the handset locator feature will not be canceled.

To stop the paging tone:

- Press  **PHONE/FLASH**,  **SPEAKER**, or any dial pad key (0-9, \*, or #) on the handset(s).

–OR–

- Press  **HANDSET LOCATOR** on the telephone base.



**NOTE:** The handset ringer volume also determines the level of the paging tone. If the handset ringer volume level is set to off, that handset will be silent for all calls and paging (page 20).



## Options while on calls

### Volume control

---

Press the **VOLUME ▼▲** keys on the side of the handset to adjust listening volume. Each press of the button increases or decreases the volume.



**NOTES:**

1. All volume settings (normal handset, speakerphone and headset) are independent.
2. When the volume level has reached the minimum or maximum setting, you will hear two beeps.

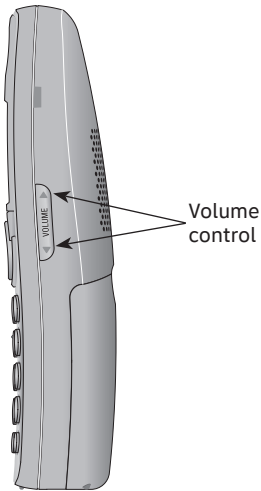

### Call waiting

---

If you subscribe to call waiting service with your local telephone service provider, you will hear a beep if someone calls while you are already on a call. Press **PHONE/FLASH** to put your current call on hold and answer the new call. You can press **PHONE/FLASH** at any time to switch back and forth between the calls.

### Multiple handset use (not for model TL72108)

---

If you would like to join an ongoing call, press **PHONE/FLASH** or **SPEAKER** on another system handset.

Press **OFF/CLEAR** or place the handset in the telephone base or charger to exit the call. The call will not be terminated until all handsets hang up.



**NOTE:** A maximum of two handsets can be used at once on an outside (not an intercom) call.

## Options while on calls

### Mute

---

The mute function allows you to silence the microphone. You can hear the caller, but the caller will not be able to hear you.

To mute the call:

- Press **MUTE/REMOVE** to silence the microphone. When mute is on, the handset screen will show **MUTED** for a few seconds and the **MUTE** icon will be shown until mute is turned off.

To un-mute the call:

- Press **MUTE/REMOVE** again and resume speaking. When mute is turned off, **MICROPHONE ON** will display temporarily on the handset screen.



**NOTE:** You cannot press **OFF/CLEAR** to exit redial, directory or caller ID access without ending the call.



**NOTES:**

1. While reviewing the directory on a call, editing an entry is not allowed. For more details about the directory, see page 25.
2. While reviewing the caller ID history on a call, storing the caller ID number in the directory is not allowed. For more details about the caller ID history, see page 31.
3. While on a call, only the most recently called number can be reviewed, and erasing the entry is not allowed. For more details about the redial memory, see page 13.

## Chain dialing

This feature allows you to initiate a dialing sequence from numbers stored in the directory, caller ID history or redial list while you are on a call.

Chain dialing can be useful if you wish to access numbers other than phone numbers (such as bank account information or access codes) from the directory, caller ID history or redial list.

### Directory

---

While on a call, you can press **DIR** to review the directory. To dial the displayed number, press **MENU/SELECT**.

### Caller ID history (call log)

---

While on a call, you can press **CID** to review the caller ID history. To dial the displayed number, press **MENU/SELECT**.

### Last number redial

---

If you have already pressed **\PHONE/FLASH** or **☎SPEAKER**, press **REDIAL/PAUSE** to display and dial the most recently dialed number. If you press **REDIAL/PAUSE** again within two seconds, the number will not be dialed.

## Intercom

Use the intercom feature for conversation between handsets. (This feature is not available on model TL72108.)



### Models TL72208/TL72308/TL72408

1. Press **INT**. The screen will show **INTERCOM TO:**
2. Enter a handset number. The screen will show **CALLING HANDSET X**. The called handset will ring, and its screen will show **HANDSET Y IS CALLING**.
3. On the ringing handset, press **PHONE/FLASH**, **INT**, **SPEAKER**, or any dial pad key (0-9, \* or #) to answer the intercom call.

### To end the intercom call:

- Press **OFF/CLEAR** or **INT** on either handset.
- OR-
- Place either handset in the charger or telephone base.



### NOTES:

1. Before the intercom call is answered, you can cancel the intercom call by pressing **OFF/CLEAR** or **INT** on the calling handset.
2. If the called handset is not answered within 100 seconds or if it is in the directory or call log mode, or on a call, or out of range, the calling handset will show the message **UNABLE TO CALL TRY AGAIN**.
3. Pressing **OFF/CLEAR** or **MUTE/REMOVE** will temporarily silence the intercom ringer.
4. A maximum of two handsets can be used at once on the same intercom call. For model TL72408, four handsets can be used for two different intercom calls at once.
5. During an intercom call, there will be an alert tone signaling an incoming call. Press **PHONE/FLASH** or **INT** to answer the incoming call. The intercom call will be ended automatically.

### To make an intercom call while on a call:

If you are on an external call and you wish to intercom another system handset without disconnecting the external call:

1. During a conversation with an outside call, press **INT**. The outside call is automatically placed on hold and **TRANSFER TO:** is displayed on the screen.
2. Enter a handset number. The screen will show **CALLING HANDSET X**. The called handset will ring, and its screen will show **HANDSET Y IS CALLING**.
3. On the ringing handset, press **PHONE/FLASH**, **INT**, **SPEAKER**, or any dial pad key (0-9, \* or #) to answer the intercom call. You can now talk without the outside caller hearing the conversation.
4. Press **INT** repeatedly on the calling handset to alternate between the external (outside) call and the intercom call.

## Call transfer using intercom

Use the intercom feature to transfer an outside call from one handset to another. (This feature is not available on model TL72108.)

### Models TL72208/TL72308/TL72408

1. During a conversation with an outside call, press **INT**. The outside call is automatically placed on hold and **TRANSFER TO:** is displayed on the screen.
2. Enter a handset number. The screen will show **CALLING HANDSET X**. The called handset will ring, and its screen will show **HANDSET Y IS CALLING**.
3. On the ringing handset, press **\PHONE/FLASH**, **INT**, **▶SPEAKER**, or any dial pad key (0-9, \* or #) to answer the intercom call. You can now talk without the outside caller hearing the conversation.
4. Press **↵OFF/CLEAR** on the calling handset or place it in the telephone base or handset charger to complete the transfer. The calling handset's screen will show **CALL TRANSFERED** and the other handset will automatically be connected to the outside call.





#### NOTES:



1. Before the intercom call is answered, you can cancel the transfer and return to the outside call by pressing **↵OFF/CLEAR**, **\PHONE/FLASH**, or **INT**.
2. If the called handset does not answer the intercom call within 100 seconds, or if the other handset is in the directory or call log mode, or out of range, the calling handset will show **UNABLE TO CALL TRY AGAIN** on its screen and will automatically return to the outside call.
3. You can switch between the intercom call and the outside call by pressing **INT** on the calling handset. The display will change between **INTERCOM** and **OUTSIDE CALL** to indicate which party is active.
4. You can end the intercom call and return to the outside call by pressing **\PHONE/FLASH** on the calling handset.

## Handset settings

Using the feature menu, you can change settings to customize how the telephone works.

1. Press **MENU/SELECT** in idle mode (when the phone is not in use) to enter the feature menu.
2. Use  or  to scroll to the feature to be changed. When scrolling through the menu, the top menu item is always highlighted with a > symbol.
3. Press **MENU/SELECT** to select the highlighted item.







**NOTE:** To cancel an operation, back up to the previous menu or exit the menu display, press  **OFF/CLEAR**. Press and hold  **OFF/CLEAR** to return to idle mode.

### Ringer volume

Using this menu, you can set a ring volume level (1-6), or turn the ringer off. When the ringer is turned off, the  will appear on the handset screen.

To adjust the **RINGER VOLUME**:

1. Press **MENU/SELECT** in idle mode to enter the feature menu.
2. Use  or  to scroll to the **>RINGER VOLUME** menu, then press **MENU/SELECT**.
3. Press  or  to sample each volume level.
4. Press **MENU/SELECT** to save your preference and return to the feature menu.

**- OR -**

When the handset is in idle mode, press the **VOLUME ▼▲** buttons on the right side of the handset to change ringer volume.



**NOTE:** The ringer volume level also determines the ringer levels of intercom calls (pages 18-19) and the handset locator paging tone (page 14). If the handset ringer volume level is set to off, that handset is silenced for all incoming calls and paging.

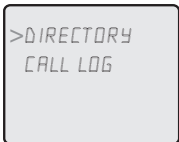





## Handset settings

### Ringer tone

---

This feature allows you to choose one of 10 ringer tones.

To choose a ringer tone:

1. Press **MENU/SELECT** in idle mode to enter the feature menu.
2. Use  or  to scroll to the **>RINGER TONE** menu, then press **MENU/SELECT**.
3. Press  or  to sample each ringer tone.
4. Press **MENU/SELECT** to save your preference and return to the feature menu.

>DIRECTORY  
CALL LOG

>RINGER TONE  
KEY TONE





RINGER TONE  
1

### Key tone

---

The handset is factory programmed to beep with each key press. If you turn off the **KEY TONE**, there will be no beeps when keys are pressed.

To turn the **KEY TONE** on or off:

1. Press **MENU/SELECT** in idle mode to enter the feature menu.
2. Use  or  to scroll to the **>KEY TONE** menu, then press **MENU/SELECT**.
3. Press  or  to select **ON** or **OFF**.
4. Press **MENU/SELECT** to save your preference and return to the feature menu.

>DIRECTORY  
CALL LOG

>KEY TONE  
LANGUAGE

KEY TONE  
ON







## Handset settings

### **Language**

---

In this menu, you can select the language used for all screen displays.

To select a language:

1. Press **MENU/SELECT** in idle mode to enter the feature menu.
2. Use  or  to scroll to the **>LANGUAGE** menu, then press **MENU/SELECT**.
3. Press  or  to select **ENGLISH, FRANCAIS** or **ESPANOL**.
4. Press **MENU/SELECT** to save your preference and return to the feature menu.

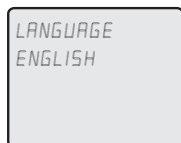
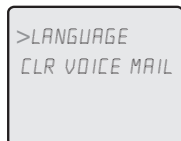

## Handset settings

### Visual message waiting (voicemail) indicator

If you subscribe to a voicemail service offered by your local telephone company, the voicemail waiting indicator feature will provide visual indication when you have new voicemail messages. The **VOICEMAIL** light on the telephone base will flash, and **NEW VOICE MAIL** and the  icon will appear on the handset screen(s).





#### NOTES:

1. This feature does not indicate new answering system messages recorded on your phone.
2. For more information about the difference between your answering system and voicemail, see page 36.

### To clear voicemail indication

Use this feature when the telephone indicates that there is new voicemail but there is none (for example, when you have accessed your voicemail from a different telephone line while away from home). This feature only turns off the displayed **NEW VOICE MAIL** message, the  icon and the **VOICEMAIL** light; it does not delete your voicemail message(s). If there actually are new voicemail messages, your local telephone company will continue to send the signal to turn on the visual message waiting indication.

To manually turn off the new voicemail indication:

1. Press **MENU/SELECT** in idle mode to enter the feature menu.
2. Use  or  to scroll to the **>CLR VOICE MAIL** menu, then press **MENU/SELECT**.
3. Press **MENU/SELECT** again to turn the voicemail indication off, or press  **OFF/CLEAR** to cancel the procedure.

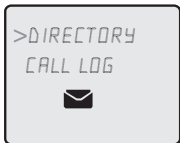

#### NOTES:

1. Telephone company voicemail may alert you to new messages with stutter (broken) dial tone. Contact your telephone company for more details.
2. For information about using your voicemail service contact your telephone company for assistance.



## Handset settings

### Temporary ring silencing

---

Press  **OFF/CLEAR** or **MUTE/REMOVE** while the telephone is ringing to silence the ringer temporarily. This will silence the ringer without disconnecting the call. The next incoming call will ring normally at the preset volume.



**NOTE:** If more than one handset is installed, each handset will ring when there is an incoming call unless the volume is turned off. Pressing  **OFF/CLEAR** or **MUTE/REMOVE** on one handset will only silence the ringer of that particular handset.

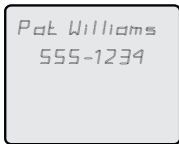

## Directory

### Shared directory

---

The directory is stored in the telephone base, and is shared by all handsets. Changes made to the directory on any one handset will apply to all.



**NOTE:** Only one handset can review the directory at a time. If another handset attempts to use the directory, the screen will display **NOT AVAILABLE AT THIS TIME**.

### Memory capacity

---

The directory can store up to 50 entries, with a maximum of 15 alphanumeric characters (including spaces) for the names and 30 digits for the telephone numbers. A convenient search feature can help you find and dial numbers quickly (page 29).

If all memory locations are in use, the screen will display **LIST FULL**. You will not be able to store a new number until an existing one is deleted.

### Exiting the directory

---

Press **OFF/CLEAR** to cancel an operation, back up to the previous menu, or exit the menu display. Press and hold **OFF/CLEAR** to return to the idle mode.

If you pause for too long while creating or reviewing an entry, the procedure will time out and you will have to begin again.

## New directory entries



### To create and store a new directory entry

>DIRECTORY  
CALL LOG



>REVIEW  
STORE

>STORE  
REVIEW

ENTER NUMBER  
555-1234\_

1. Press **MENU/SELECT** in idle mode to enter the feature menu.
2. Press **MENU/SELECT** again to enter the >**DIRECTORY** menu.
3. Press  to highlight **STORE**.
4. Press **MENU/SELECT**.
5. Enter the telephone number when prompted.
  - Use the dial pad to enter up to 30 digits.
    - Press  or  to move the cursor to the left or right.
    - Press **MUTE/REMOVE** to erase numbers.
    - Press and hold **MUTE/REMOVE** to erase all numbers.
    - Press and hold **REDIAL/PAUSE** to enter a three-second dialing pause.

#### **-OR-**

- Copy a number from redial by pressing **REDIAL/PAUSE** then press  or  to locate the number to copy. Press **MENU/SELECT** to copy the number.
6. Press **MENU/SELECT** to save the number in the display. The display will show **ALREADY SAVED** if the number is already in the directory, then you will need to enter another number before pressing **MENU/SELECT** to continue.

## New directory entries

### 7. Enter the name when prompted.

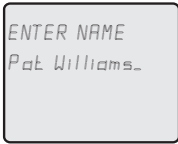

**NOTE:** The first letter of every word will be capitalized. The remaining letters in a word will be lowercase as shown in the chart on the right.

- Use the dial pad to enter a name (up to 15 characters). Each time a key is pressed, the character on that key will be displayed. Additional key presses will produce other characters on that key. See the chart below.
  - Press or to move the cursor to the left or right.
  - Press **MUTE/REMOVE** to erase letters.
  - Press and hold **MUTE/REMOVE** to erase all letters.

Dial Key	Characters by number of key presses								
	1	2	3	4	5	6	7	8	9
1	1	#	'	,	-	.	&		
2	A	B	C	2	a	b	c		
3	D	E	F	3	d	e	f		
4	G	H	I	4	g	h	i		
5	J	K	L	5	j	k	l		
6	M	N	O	6	m	n	o		
7	P	Q	R	S	7	p	q	r	s
8	T	U	V	8	t	u	v		
9	W	X	Y	Z	9	w	x	y	z
0	0								
*	*	?	!	/	(	)	@		
#	space								





### 8. Press **MENU/SELECT** to store your new directory entry. The name and the telephone number will then be shown on the screen. To change it later, see page 30.

## Directory review

### To review directory entries

---



1. Press **DIR** in idle mode to display the first listing in the directory. **DIRECTORY EMPTY** will be displayed if there are no directory entries.  
**-OR-**  
You can also display the first listing in the directory by first pressing **MENU/SELECT** twice, then press **MENU/SELECT** again to choose **>REVIEW**.
2. Press  or  to browse through the directory. Entries will be displayed alphabetically by the first letter in the name.

## Directory search

### To search by name

---

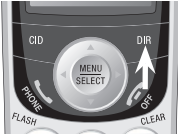

1. Press **DIR** in idle mode to display the first listing in the directory. **DIRECTORY EMPTY** will be displayed if there are no directory entries.
2. When a name entry is displayed, press the dial pad keys (2-9) to start a name search.

The directory will display the first name beginning with the first letter associated with the dial pad key, if there is an entry in the directory that begins with that letter.

3. To see other names that start with the letters on the dial pad key, keep pressing the key. The names will be shown in alphabetical order.

For example, if you have name entries **Jennifer**, **Jessie**, **Kevin** and **Linda** in your directory:

- If you press **5 (JKL)** once, you will see **Jennifer**.
- If you press **5 (JKL)** twice, you will see **Jessie**.
- If you press **5 (JKL)** three times, you will see **Kevin**.
- If you press **5 (JKL)** four times, you will see **Linda**.
- If you press **5 (JKL)** five times, you will see **Jennifer** again.



#### NOTES:

1. If there is no name entry matching the first letter of the key you press, you will see a name entry that matches the second letter of the key.
2. If you press a key (2-9) and there is no name entry to match those letters, the directory will show the entry that matches the next letter in the directory.



## To dial, delete or edit entries

To dial, delete or edit a directory entry (name and number), the entry must be displayed on the handset. Use directory search or review (pages 28-29) to display an entry.

### Display dial

---

To dial a displayed number from the directory, press **\PHONE/FLASH** or **☎SPEAKER**.

### To delete an entry

---

When a directory entry is displayed, press **MUTE/REMOVE** to delete the displayed entry from the directory. Once deleted, an entry cannot be retrieved.

### To edit an entry

---

When a directory entry is displayed:

1. Press **MENU/SELECT** to modify the entry. You will be prompted to **EDIT NUMBER**.
  - Press the dial pad keys to add digits.
  - Press **MUTE/REMOVE** to erase digits.
  - Press **⬅** or **➡** to move the cursor.
  - Press and hold **REDIAL/PAUSE** to add a three-second pause if desired.
  - Press **REDIAL/PAUSE**, then **⬅** or **➡** to scroll to a previously dialed number. Press **MENU/SELECT** to add the redial number to the entry.
2. Press **MENU/SELECT**. You will be prompted to **EDIT NAME**.
  - Press the dial pad keys to add characters (page 27).
  - Press **MUTE/REMOVE** to erase characters.
  - Press **⬅** or **➡** to move the cursor.
3. Press **MENU/SELECT** to confirm.

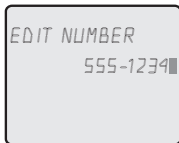



**NOTE:** Caller ID features will work only if both you and the caller are in areas offering caller ID service, and if both telephone companies use compatible equipment. The time and date are sent by the telephone company along with the call information.

## Caller ID operation

### Information about caller ID with call waiting

This product has caller ID with call waiting feature that works with your local telephone company service.

This product can be used with regular caller ID service, or this product's other features can be used without subscribing to either caller ID or combined caller ID with call waiting service.

There are fees for caller ID services. In addition, services may not be available in all areas.

Depending on your service, caller ID with call waiting lets you see the name and telephone number of the caller before answering the telephone, even while on another call.

It may be necessary to change your telephone service to use this feature. Contact your telephone company if:

- You have both caller ID and call waiting, but as separate services (you may need combined service).
- You have only caller ID service, or only call waiting service.
- You do not have any caller ID or call waiting services and would like to use this feature.



## Caller ID operation

### How the caller ID history (call log) works

The caller ID history stores information about the last 50 incoming calls. Review the caller ID history to find out who called, to easily return the call, or to copy the caller's name and number into your directory.

The caller ID history deletes the oldest entry when the log is full to make room for new incoming calls.

If you answer a call before the information appears on the screen, it will not be saved in the caller ID history.

The caller ID history is stored in the telephone base, and is shared by all handsets. Changes made at any one handset will be reflected in all.



**NOTE:** Only one handset can review the caller ID history at a time. If another handset attempts to enter the directory or caller log, it will display **NOT AVAILABLE AT THIS TIME.**

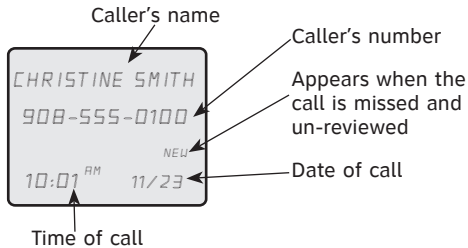

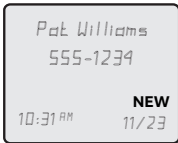

## Caller ID operation

### Memory match

If the incoming telephone number exactly matches a telephone number in your directory, the name that appears on the screen will match the corresponding name in your directory.

For example, if Christine Smith calls, her name will appear as **Chris** if this is how you entered it into your directory.



**NOTE:** The number shown by your caller ID will be in the format sent by the phone company. The phone company usually delivers ten-digit phone numbers (area code plus phone number). If the telephone number of the person calling does not exactly match a number in your directory, the name will appear as delivered by the phone company. For example if the phone company includes the area code and the directory number does not, the name will appear as delivered by the phone company.

### Missed (new) call indicator

When a handset is in idle mode and has calls that have not been reviewed, its screen will show **XX MISSED CALLS**.

All entries which have not been reviewed will be counted as missed calls when the phone is idle. Each time an entry from the caller ID history marked **NEW** is reviewed, the number of missed calls decreases by one.

If you do not want to review all the missed calls one by one, but you still want to keep all the missed calls in the caller ID history, you can press and hold **OFF/CLEAR** for four seconds when the handset is idle. All the entries in the caller ID history will be considered old (have been reviewed), and the missed calls counter is reset to 0.

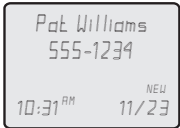
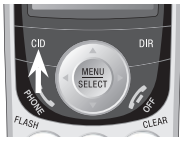

The various dialing options are:

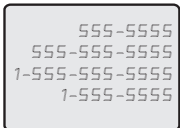

## Caller ID history

### To review caller ID history

1. Press **CID** to review the caller ID history. The caller ID history displays the caller ID entries in reverse chronological order starting with the most recent call.

**-OR-**

You can also review the caller ID history by pressing **MENU/SELECT**, then use or to scroll to the **>CALL LOG**, then press **MENU/SELECT**.

2. Press or to scroll through the list as shown on the left.

### To dial from caller ID history

While reviewing an entry in the caller ID history:

- Press **\PHONE/FLASH** or **▶SPEAKER** to call the number as it is displayed in the caller ID history.

**-OR-**

- Press **#** repeatedly to see the various dialing options (you can choose to dial with or without an area code, or with or without the 1), then press **\PHONE/FLASH** or **▶SPEAKER** to place the call.



**NOTE:** You may need to change how a caller ID number will be dialed if the entry is not displayed in the correct format. Caller ID numbers may appear with an area code which may not be required for local calls, or without a 1 which may be needed for long distance calls.

### Other options

- Press **MUTE/REMOVE** to delete the displayed entry from the caller ID history.
- With an entry from the caller ID history displayed, **press and hold MUTE/REMOVE** to delete all entries from the caller ID history. When asked to confirm, press **MENU/SELECT** to clear the caller ID history of all entries, or press **▶OFF/CLEAR** to exit and leave all entries in the caller ID history intact.



**NOTE:** If both the name and number are not provided, **UNABLE TO SAVE** will be displayed.

## Caller ID history

- Press **MENU/SELECT** to copy this entry into your directory. You will be given the opportunity to edit the name or the number (page 30) if they are not provided.
- Press **OFF/CLEAR** to exit the caller ID history.

## About the answering system

### **Answering system and voicemail**

---

Your telephone has both a digital answering system and voicemail indication. Voicemail is offered by your telephone service provider (fees may apply). Your telephone's answering system and voicemail indication are independent features. Each alerts you to new messages differently. For more information on the voicemail indicators, see page 23. To listen to your voicemail, you typically dial an access number provided by your telephone company, followed by a security code or PIN. To listen to messages recorded on your digital answering system, press ►/■ **PLAY/STOP** button on the telephone base.

If you subscribe to caller ID/call waiting service through your telephone service provider, you can use your telephone answering system and voicemail together. Set your answering system to answer calls at least two rings earlier than your voicemail is set to answer. For example, set your voicemail to answer calls after six rings and set your answering system to answer after four rings. Some voicemail providers may program the delay before answering calls in seconds instead of rings; in this case allow six seconds per ring when determining the appropriate setting. By doing this, if you are on a call, or if the answering system is busy recording a message and you receive another call, the second caller can leave a voicemail message.

## About the answering system

The answering system can record up to 99 messages, depending on the length of each message. Individual messages can be up to four minutes long, and the total maximum recording time is 14 minutes. Messages will remain available for replay until you delete them.

If **F** is flashing in the message window, memory is full. You will have to delete some messages before new ones can be recorded.

When there are new messages (including memos) on the answering system, the number of messages stored will flash in the message counter.

To play answering system messages, press **▶/■ PLAY/STOP**. Press **VOLUME ▼▲** to adjust the playback volume when playing messages.

### Voice prompts

---

The system provides voice prompts to guide you through setup.







**NOTE:** If the clock was not set when a message was recorded, the system will announce "Time and day not set" before the message is played back.

## Day & time announcement

### To check day & time

You can press **CLOCK** when the system is idle to hear the current day and time.

If you subscribe to caller ID service from your local telephone company, the time will automatically be set with every incoming call. You must set the year so that the day of the week can be calculated from the caller ID information.

If you do not hear the correct time, day, and year, follow the steps below.

### To set day & time

Before playing each message, the answering system announces the day and time the message was received.

Follow the steps below to set the year, time and day, so the day and time are correct. Each time you press **▶SKIP** or **◀REPEAT**, the year, hour, minute or day increases or decreases by one. Press and hold **▶SKIP** or **◀REPEAT** to increase or decrease the minutes or year by increments of ten. When you hear the correct setting, press **CLOCK** to move to the next setting.

1. Press **CLOCK**, the system will announce the current clock setting, and then announce "To set the clock, press **CLOCK**."
2. Press **CLOCK**, The system will announce the current year setting, and then announce "To change the year, press **SKIP** or **REPEAT**, to change the hour, press **CLOCK**."
3. Press **CLOCK**, The system will announce the current hour setting, and then announce "To change the hour, press **SKIP** or **REPEAT**, to change the minute, press **CLOCK**."
4. Press **CLOCK**, The system will announce the current minute setting, and then announce "To change the minute, press **SKIP** or **REPEAT**, to change the day, press **CLOCK**."
5. Press **CLOCK**, The system will announce the current day setting, and then announce "To change the day, press **SKIP** or **REPEAT**, press **CLOCK** when you are done."
6. Press **CLOCK**. The system announces the current clock setting.

## Answering system mode

Unless you change it, the answering system will be on, that is, ready to record messages. You can turn the answering system off, but if you do so, the answering system will not answer calls and record incoming messages.

To turn the answering system on or off:

- Press **ANSWER ON** to turn off your answering system. The system will announce *"Calls will not be answered"* and then beep to confirm the system is off. The **ANSWER ON** light will be off.
- To turn the system back on, press **ANSWER ON**. The system will announce *"Calls will be answered"* and then beep to confirm the system is on. The **ANSWER ON** light will be on.



**NOTE:** If the answering system is off, and there is an incoming call, the system will answer after 10 rings and announce to the caller *"Please enter your remote access code."* For more information about remote access, see pages 49-50.

### Call screening at the telephone base

If the answering system is on and the base volume is not off, you will hear the announcement and the incoming message when a call comes in.

### Call intercept

While you are screening a call, you can stop recording and speak to the caller by pressing **PHONE/FLASH** or **SPEAKER** on the handset.

## Outgoing announcements

Outgoing announcements are the messages callers hear when calls are answered by the answering system.

The telephone has a prerecorded outgoing announcement: *"Hello. Please leave a message after the tone."* You can use this announcement, or replace it with your own recording.

### **To play your current outgoing announcement**

1. Press **ANNC.**, you will hear "Announcement. Press **PLAY** or press **RECORD.**"
2. Press **▶/■ PLAY/STOP** to hear the outgoing announcement, press again to replay the announcement.

Press **ANNC.** at anytime to exit the announcement menu.

### **To record a new outgoing announcement**

1. Press **ANNC.** You will hear "Announcement. Press **PLAY** or press **RECORD.**"
2. Press **RECORD** and begin speaking after you hear "Record after the tone. Press **STOP** when you are done."
3. Speak facing the telephone base from approximately nine inches away.
4. Press **▶/■ PLAY/STOP** when you are done. Your recorded announcement will be played back.

To listen to the recorded announcement again, press **▶/■ PLAY/STOP.**

To record a new announcement, press **RECORD** and follow the above steps. Press **ANNC.** at anytime to exit the announcement menu.

Elapsed time (in seconds) will be shown in the message window when recording. You can record an announcement up to 90 seconds long. An announcement shorter than two seconds long will not be recorded.

## Outgoing announcements

### **To delete your outgoing announcement**

---

1. Press **ANNC**. You will hear "Announcement. Press **PLAY** or press **RECORD**."
2. Press **▶/■ PLAY/STOP** to begin playback.
3. Press **X DELETE** during playback to delete your announcement, "Announcement deleted." will be announced.

Press **ANNC**. to exit the announcement menu.

When your announcement is deleted, calls will be answered with the pre-set announcement described on page 40.

## Answering system setup

You can change the number of rings, telephone base ringer volume, remote access code and message alert tone.

To change the answering system setup:

1. Press **SETUP** repeatedly to hear the settings for different features.
2. When you hear the feature you want to change, press **▶SKIP** or **◀REPEAT** to change the setting.

- **Number of rings** - set the number of rings before the answering system answers an incoming call.
- **Base ringer** - set the volume of the telephone base ringer.
- **Remote access code** - change the code required to access your answering system from another telephone.
- **Message alert tone** - set the message alert tone to **On** so that it will beep when you have a new answering system message.

3. Press **SETUP** to save your selection and move to the next menu option.

**-OR-**

Press **▶/■ PLAY/STOP** to save your selection and exit the menu.



**NOTE:** To adjust the voice prompt volume, press **VOLUME ▼▲**.

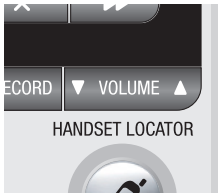

## Answering system setup

### Number of rings

---

You can set the answering system to answer an incoming call after two, four, or six rings. You can also select toll saver, which is explained below. Unless you change it, the answering system answers an incoming call after four rings.

To set the number of rings:

1. Press **SETUP**. The system will announce "Number of rings," followed by the current setting, and then "To change the setting press **SKIP** or **REPEAT**; to continue setup, press **SETUP**."
2. Press **▶SKIP** or **◀REPEAT** to change to two, four, or six rings, or toll saver.
  - Toll saver - the answering system answers a call after two rings when there are new messages, and after four rings when there are no new messages. This allows you to check for new messages without paying for a toll call.
3. Press **SETUP** to save your selection and move to the next menu option.

**-OR-**

Press **▶/■ PLAY/STOP** to save your selection and exit the menu.



**NOTE:** If you subscribe to caller ID/call waiting and voicemail service through your telephone service provider, you can use your telephone answering system and voicemail together. Set your answering system to answer calls at least two rings earlier than your voicemail is set to answer. For example, set your voicemail to answer calls after six rings and set your answering system to answer after four rings. By doing this, if you are on a call, or if the answering system is busy recording a message and you receive another call, the second caller can leave a voicemail message.

## Answering system setup

### **Base ringer volume**

---

You can set the volume to high or low, or turn the base ringer off. Unless you change it, the telephone base ringer volume is set to low.

To change the setting:

1. Press **SETUP** twice. The system will announce *"Base ringer,"* followed by the current setting, and then *"To change the setting press **SKIP** or **REPEAT**; to continue setup, press **SETUP**."*
2. Press **▶SKIP** or **◀REPEAT** to change among off, low or high.
3. Press **SETUP** to save your selection and move to the next menu option.

**-OR-**

Press **▶/■ PLAY/STOP** to save your selection and exit the menu.

### **Remote access code**

---

To access your answering system remotely from any touch tone phone, you need to enter a two-digit number (10-99). Unless you change it, the remote access code is 19.

To change the remote access code:

1. Press **SETUP** three times. The system will announce *"Remote access code,"* followed by the current setting, and then *"To change the setting press **SKIP** or **REPEAT**; to continue setup, press **SETUP**."*
2. Press **▶SKIP** or **◀REPEAT** to increase or decrease the remote access code number by one. Press and hold **▶SKIP** or **◀REPEAT** to increase or decrease the remote access code number by 10.
3. Press **SETUP** to save your selection and move to the next menu option.

**-OR-**

Press **▶/■ PLAY/STOP** to save your selection and exit the menu.

## Answering system setup

### Message alert tone

---

When the message alert tone is set to , and there is at least one new message, the telephone base will beep every 10 seconds. Unless you change it, the message alert tone is set to off.

To change the setting:

1. Press **SETUP** four times. The system will announce "Message alert tone," followed by the current setting, and then "To change the setting press **SKIP** or **REPEAT**; to continue setup, press **SETUP**."
2. Press **▶SKIP** or **◀REPEAT** to change between on and off.
3. Press **SETUP** to save your selection and move to the next menu option.

**-OR-**

Press **▶/■ PLAY/STOP** to save your selection and exit the menu.



**NOTE:**

The message alert tone will beep only if all the conditions below are met:

- Answering system is on.
- Message alert tone setting is on.
- There are new messages.

### Temporarily turning off the message alert tone

---

Pressing any telephone base key (except  **HANDSET LOCATOR**) will temporarily silence the message alert tone.

If you press X **DELETE** in idle mode, there will be a voice prompt to direct you to press X **DELETE** again to delete all old messages, and the message alert tone will be temporarily silenced.

The message alert tone will be re-activated with the next incoming message.



## Message playback

Press ►/■ **PLAY/STOP** to hear messages. The system announces the number of messages, then begins playback.

If you have new messages, you will hear only the new messages (oldest first). If there are no new messages, the system will play back all messages (oldest first).

Before each message, you will hear the day and time it was received. After the last message, you will hear "End of messages." If the system has less than five minutes of recording time left, you will hear the remaining time.

1. Press ►/■ **PLAY/STOP**. Message playback begins.
2. Press ►/■ **PLAY/STOP** again to end message playback.

### Options during playback

When a message is playing, you can adjust the playback volume, and skip, repeat, or delete the message.

When playing messages:

- Press **VOLUME ▼▲** button to adjust the message playback volume.
- Press ►**SKIP** to skip to the next message.
- Press ◀**REPEAT** to repeat the message. Press twice to hear the previous message.
- Press X **DELETE** to delete the message.
- Press ►/■ **PLAY/STOP** to stop playback.

### To delete all old messages

You can only delete old (reviewed) messages. New messages must be played before you can delete them. Deleted messages cannot be retrieved again.

To delete all old messages:

1. Press X **DELETE** when the telephone is in idle mode. The system will announce "To delete all old messages, press **DELETE** again."
2. Press X **DELETE** again. The system will announce "All old messages deleted."

## Recording & playing memos

Memos are messages you record yourself. They are saved, played back and deleted exactly like incoming messages. You can record a memo as a reminder to yourself, or leave a message for someone else who uses the answering system.

To record a memo:

1. Press **RECORD**. The system will announce "Record after the tone. Press **STOP** when you are done."

The message window will show the elapsed time (in seconds) as you record. You can record a memo up to four minutes long. Memos less than one second long will not be saved.

2. Speak facing the **MIC** (microphone) at the bottom front of the telephone base from approximately nine inches away.
3. Press **▶/■ PLAY/STOP** to stop recording. The system will announce "Recorded" and a confirmation tone.



### To play back a memo

---

Press **▶/■ PLAY/STOP** to hear messages and memos (see page 46 for other options).



## Message counter displays

The message counter usually displays the total number of answering system messages. See the table below for other message counter displays.

### Message counter displays

<i>0</i>	No messages.
<i>0</i> (flashing)	The clock needs to be set (page 38).
<i>1-99</i>	Total number of messages and memos, or message number currently playing.
<i>1-99</i> (flashing)	Total number of messages and memos. The number flashes when there are new (un-reviewed) messages.  After a power failure, the number in the message counter will flash to indicate the clock needs to be set.
<i>10-99</i>	Current remote access code while setting (page 44).
<i>1-99</i> (counting)	Elapsed time while recording a memo (page 47) or announcement up to 90 seconds (pages 40-41).
<i>99</i> (flashing)	A memo recording is more than 99 seconds.
<i>F</i> (flashing)	Memory is full. Messages must be deleted before new messages can be recorded.
--	System is answering a call, being accessed remotely, or the clock is being set.
-- (flashing)	System is being setup, initialized or messages are being deleted.
<i>02, 09, 06, 15</i>	Displayed while setting the number of rings (page 43).
<i>1-8</i>	Displayed for two seconds while telephone base speaker volume is being adjusted.
<i>H1, L0, 0F</i>	Displayed for two seconds while the telephone base ringer volume is being adjusted.

## Remote access

You can access your answering system remotely by dialing your home telephone number from any touch-tone telephone.

To remotely access your answering system:

1. Dial your telephone number from any touch-tone telephone.
2. When the system answers, enter the two digit remote access code (**19** is the default code, see page 44 to change it).
  - If you have new messages, the system will automatically announce the number of new messages and then begin to play them.
3. You can also enter the following remote commands.



### NOTES:

1. If a valid remote access code is not entered, the call will be ended automatically.
2. If you pause for more than four seconds during remote access, you will hear a help menu listing all features and commands. If there is no command for another 20 seconds, the call will end automatically.
3. If you want to delete all your old messages remotely, you can press **3** twice in remote standby mode to delete them.
4. If memory is full, after 10 rings the answering system will answer and announce "Memory is full, enter the remote access code." Enter your remote access code for access to messages and announcements.

### Remote commands

Command	Description
	Press to hear all messages.
	Press to hear only new messages.
	Press to delete the current message (during playback).
	Press twice to delete all old messages.
	Press to repeat the current message (during playback).
	Press twice to hear the previous message.
	Press to stop any operation (including recording).
	Press to hear a list of remote commands.
	Press to skip to the next message (during playback).

## Remote access



Press to record a new announcement.

---



Press to turn the answering system on or off.

---



Press to end remote access (the call will be terminated).

---

4. Hang up to end the call and save all undeleted messages.

Cut out the remote access wallet card at the back of this user's manual for quick reference.

# Screen icons, indicator lights & tones

## Screen icons & alert tones



### Screen icons

- Speakerphone is in use.
- New voicemail messages have been received.
- Ringer off.
- MUTE** Microphone is muted.
- NEW** Missed and un-reviewed calls.
- Battery charging (animated display).
- Low battery (flashing); place handset in telephone base or charger to recharge.

### Handset alert tones

- Two short beeps** **VOLUME**  $\blacktriangledown$   $\blacktriangle$  keys are pressed when the volume is already at its highest or lowest setting.
- Four short beeps** Low battery warning.
- Two beeps** Out of range while the handset is on a call.
- Confirmation tone** Command completed successfully.

### Telephone base tones

- One beep every 10 seconds** Message alert.
- A series of beeps** **VOLUME**  $\blacktriangledown$   $\blacktriangle$  keys are pressed when the volume is already at its highest or lowest setting.

## Indicator lights

### IN USE

- On when handset is in use, when the answering system is answering an incoming call or you are registering a handset.
- Flashes when another telephone is in use on the same line, or you are deregistering a handset from the telephone base.
- Flashes quickly when there is an incoming call.



### ANSWER ON

On when answering system is on and ready to receive calls.

### VOICEMAIL

Flashes when you have new voicemail. Voicemail is a service offered by your local telephone company, and is different from answering system messages.

### CHARGE

On when the handset is charging in the telephone base or charger

Blue lighted display

Blue lighted keypad

### SPEAKER

On when speakerphone is in use.



## Handset display screen messages



## Screen display messages

<i>PHONE</i>	The handset is in use.
<i>ENDED</i>	You have just ended a call.
<i>CALL LOG EMPTY</i>	You are accessing an empty caller ID history.
<i>DIRECTORY EMPTY</i>	You are accessing an empty directory.
<i>LIST FULL</i>	The directory is full. No new entries can be saved.
<i>MUTED</i>	The microphone is muted.
<i>SPEAKER</i>	The handset speakerphone is in use.
<i>LOW BATTERY</i>	The battery needs to be recharged.
<i>INCOMING CALL</i>	There is a call coming in.
<i>NEW VOICE MAIL</i>	There are new voicemail messages.
<i>XX MISSED CALLS</i>	There are new calls in the caller ID history.
<i>CONNECTING ...</i>	The handset has lost communication with the telephone base.
<i>** PAGING **</i>	The telephone base is paging handset(s).
<i>HANDSET X IS CALLING</i> (For TL72208/TL72308/ TL72408)	Another handset is calling.
<i>LINE IN USE</i>	An extension phone or one of the handsets is in use.
<i>NO LINE</i>	No telephone line is connected.
<i>ALREADY SAVED</i>	The telephone number you have entered is already stored in the directory.
<i>SAVED</i>	The entry in the caller ID history is saved to the directory successfully.
<i>PLACE IN CHARGER</i>	The battery is very low. The handset should be placed in the telephone base or charger.
<i>CHARGING</i>	A handset with a low battery has been placed in the telephone base or charger.

# Handset display screen messages



## Screen display messages

---

<i>UNABLE TO CALL TRY AGAIN</i>	Failed intercom or conference call (there are already two handsets being used).
<i>NOT AVAILABLE AT THIS TIME</i>	Someone else is already using the directory or call log when you try to do so.
<i>MICROPHONE ON</i>	Mute has just been turned off so your voice is again being sent out.
<i>INTERCOM TO: (For TL72208/TL72308/ TL72408)</i>	You have started the intercom process, and need to enter the handset number you want to call.
<i>INTERCOM ENDED</i>	The intercom call has just been ended by you or the receiver of the call.
<i>CALLING HANDSET X (For TL72208/TL72308/ TL72408)</i>	The handset is intercomming another handset.
<i>TRANSFER TO: (For TL72208/TL72308/ TL72408)</i>	You have started the call transfer using intercom process, and need to enter the handset number to which you want to transfer the call.
<i>CALL TRANSFERED</i>	You have transferred an outside call to another handset.

---



## Adding and registering handsets

Your telephone can accommodate up to four cordless handsets. You can add new handsets (TL70008, sold separately) to the TL72108/TL72208/TL72308 at any time, but each new handset must be registered with the telephone base before use. Each handset must be registered separately.

The handset provided with your TL72108 is automatically registered as handset 1. Additional handsets will be assigned numbers in the order they are registered (handset 2, handset 3 and handset 4). You can register a maximum of four handsets.

The TL72208 has two handsets automatically registered as handset 1 and handset 2. You can register two additional handsets, which will be assigned as handset 3 and handset 4.

The TL72308 has three handsets automatically registered as handset 1, handset 2 and handset 3. You can register one additional handset, which will be assigned as handset 4.

The TL72408 has four pre-registered handsets, so you cannot register any additional handset to it.

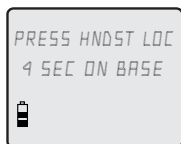
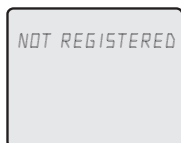

Handsets purchased separately need to be registered to the telephone base before use. When first purchased, all optional accessory handsets will show **NOT REGISTERED** on the screen. The new handset may need to be charged for five minutes before registering to the main telephone base.

### To register a handset to your telephone base

1. Place the unregistered handset into the telephone base. If **PRESS HNDST LOC 4 SEC ON BASE** does not appear on the handset screen after a few seconds, remove the handset and place it in the telephone base again.
2. On the telephone base, press and hold **HANDSET LOCATOR** for about four seconds (until the red **IN USE** light on the telephone base turns on) and then release the button. The handset will show **PLEASE WAIT...** and it will take about 10 seconds to complete the registration. The handset will show **HS X REGISTERED** and will beep if the registration is successful.



#### NOTES:

1. If the registration is not successful, the display will show **NOT REGISTERED**. To reset the handset, remove the handset from the telephone base and place it back in. Try the registration process again.
2. You cannot register a handset if any other system handset is in use.

## Replacing a handset

### You may need to de-register your handsets if:

You have four registered handsets and need to replace a handset.

#### **-OR-**





You wish to change the designated handset number of your registered handsets.

You must first de-register ALL the handsets, and then re-register each handset you wish to use.

**Please read carefully through all the instructions on this page before beginning the de-registration process.**

### To de-register all handsets

---

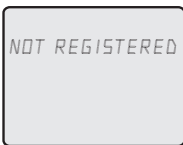

1. Press and hold  **HANDSET LOCATOR** on the telephone base for about 10 seconds (until the IN USE light turns on and starts to flash), then release the  **HANDSET LOCATOR** button.
2. Immediately press and release  **HANDSET LOCATOR** again. You must press  **HANDSET LOCATOR** while the **IN USE** light is still flashing. (The light flashes for about seven seconds. If the light stops flashing, pick up the handset and place it back into the telephone base, then repeat step one above.)
3. The handset(s) will show **CONNECTING...** and it will take about 10 seconds to complete de-registration. ALL handsets will show **NOT REGISTERED** if de-registration was successful.



4. To re-register the handset(s) to the telephone base, follow the registration instructions on page 54.



#### **NOTES:**

1. If the de-registration process was not successful, you may need to reset the system and try again. To reset: pick up the handset and press the  **PHONE/FLASH** button, then press the  **OFF/CLEAR** button and place the handset back into the telephone base. You may also reset by unplugging the power from the telephone base and plugging it back in.
2. You cannot de-register the handset(s) if any other system handset is in use.
3. You will need to reset the system clock after de-registering handset(s), refer to page 38 for details.

## Troubleshooting

If you have difficulty with your telephone, please try the suggestions below. For Customer Service, visit our website at **www.telephones.att.com**, or call **1 (800) 222-3111**. In Canada dial **1 (866) 288-4268**.

My phone doesn't work at all.

- Make sure the power cord is securely plugged in.
- Make sure that the battery connector is securely plugged into the cordless handset.
- Make sure the telephone line cord is securely and firmly plugged into the telephone base and the telephone wall jack.
- Charge the battery in the cordless handset for at least 16 hours. For optimum daily performance, return the cordless handset to its base when not in use.
- **If the battery is depleted, it may take approximately four minutes to charge the handset before it can resume screen display.**
- Reset the telephone base. Unplug the unit's electrical power. Wait for approximately 15 seconds, then plug it back in. Allow up to one minute for the cordless handset and telephone base to reset.
- You may need to purchase a new battery, please refer to page 6 of this user's manual.

---

I cannot get a dial tone.

- First try all the suggestions above.
- Move the cordless handset closer to the telephone base. You might have moved out of range.
- If the previous suggestions don't work, disconnect the telephone base from the telephone jack and connect to a different phone. If there is no dial tone on that phone either, the problem is in your wiring or local service. Contact your local telephone company.
- Your line cord might be malfunctioning. Try installing a new line cord.

---

I cannot dial out.

- First try all the suggestions above.
- Make sure you have a dial tone before dialing. The cordless handset may take a second or two to find the telephone base and produce a dial tone. This is normal. Wait an extra second before dialing.

# Troubleshooting

- Eliminate any background noise. Noise from a television, radio or other appliances may cause the phone to not dial out properly. If you cannot eliminate the background noise, first try muting the cordless handset before dialing, or dialing from another room in your home with less background noise.
- If the other phones in your home are having the same problem, the problem is in your wiring or local service. Contact your local telephone company (charges may apply).

---

My cordless handset isn't performing normally.

- Make sure the power cord is securely plugged into the telephone base. Plug the unit into a different, working electrical outlet not controlled by a wall switch.
- Move the cordless handset closer to the telephone base. You might have moved out of range.
- Reset the telephone base. Unplug the unit's electrical power. Wait for 15 seconds then plug it back in. Allow up to one minute for the cordless handset and telephone base to reset.
- Other electronic products can cause interference to your cordless phone. Try installing your phone as far away from these types of electronic devices as possible: television sets, VCRs, or other cordless telephones.

---

**CONNECTING...**  
displays on my cordless handset.

- Ensure that the telephone base is powered up.
- Place the cordless handset in the telephone base for one minute to allow the cordless handset and base to resynchronize channels.
- Move the cordless handset closer to the telephone base. You might have moved out of range.
- Reset the telephone base. Unplug the unit's electrical power. Wait for 15 seconds then plug it back in. Allow up to one minute for the cordless handset and telephone base to reset.

## Troubleshooting

- Other electronic products can cause interference with your cordless phone. Try installing your phone as far away from these types of electronic devices as possible: television sets, VCRs, or other cordless telephones.

---

The batteries will not hold a charge.

- If the cordless handset is in its telephone base or charger and the charge light does not come on, refer to **The charge light is off** in this **Troubleshooting** guide.
- Charge the battery in the cordless handset for at least 16 hours. For optimum daily performance, return the cordless handset to its base when not in use.
- **If the battery is depleted, it may take approximately four minutes to charge the handset before it can resume screen display.**
- You may need to purchase a new battery, please refer to the **Battery installation and charging** section of this user's manual.
- Your phone might be malfunctioning. Please refer to the **Limited warranty** section of this user's manual for further instruction.

---

I get noise, static, or weak signal even when I'm near the telephone base.

- If you subscribe to high-speed Internet service (Digital Subscriber Line - DSL) through your telephone line, you must install a DSL filter between the telephone base and the telephone wall jack (see page 5). The filter will prevent noise and caller ID problems caused by DSL interference. Please contact your DSL service provider for more information about DSL filters.
- You may be able to improve the performance of your cordless phone by installing your new telephone base as far as possible from any other existing cordless telephone system that may already be installed.
- Other electronic products can cause interference to your cordless phone. Try installing your phone as far away from the following electronic devices as possible: television sets, VCRs, or other cordless telephones.
- Do not install this phone near a microwave oven or on the same electrical outlet. You may experience decreased performance while the microwave oven is operating.

# Troubleshooting

- If your phone is plugged in with a modem or a surge protector, plug the phone (or modem/surge protector) into a different location. If this doesn't solve the problem, re-locate your phone or modem farther apart from one another, or use a different surge protector.
- Relocate your phone to a higher location. The phone will likely have better reception when not installed in a low area.
- If the other phones in your home are having the same problem, the problem is in your wiring or local service. Contact your local telephone company (charges may apply).

---

I hear other calls while using my phone.

- Disconnect the telephone base from the telephone jack, and plug in a different telephone. If you still hear other calls, the problem is probably in your wiring or local service. Call your local telephone company.

---

My cordless handset does not ring when I receive a call.

- Make sure that the ringer is not turned off. Refer to the section(s) on ringer selection in this user's manual.
- Make sure the telephone line cord is plugged securely into the telephone base and the telephone jack. Make sure the power cord is securely plugged in.
- The cordless handset may be too far from the telephone base.
- Charge the battery in the cordless handset for at least 16 hours. For optimum daily performance, return the cordless handset to its base when not in use.
- You may have too many extension phones on your telephone line to allow all of them to ring simultaneously. Try unplugging some of the other phones.
- The layout of your home or office might be limiting the operating range. Try moving the telephone base to another location, preferably on an upper floor.

## Troubleshooting

- If the other phones in your home are having the same problem, the problem is in your wiring or local service. Contact your local telephone company (charges may apply).
- Test a working phone at the phone jack. If another phone has the same problem, the problem is the phone jack. Contact your local telephone company (charges may apply).
- Other electronic products can cause interference with your cordless phone. Try installing your phone as far away as possible from electronic devices like television sets, VCRs, or other cordless telephones.
- Re-install the battery, and place cordless handset in the telephone base. Wait for the cordless handset to re-establish its connection with the telephone base. Allow up to one minute for this to take place.
- Your line cord might be malfunctioning. Try installing a new line cord.

---

My calls fade out or cut in and out while I'm using my cordless handset.

- Other electronic products can cause interference with your cordless phone. Try installing your phone as far away from the following electronic devices as possible: television sets, VCRs, or other cordless telephones.
- Do not install this phone near a microwave oven or on the same electrical outlet. You may experience decreased performance while the microwave oven is operating.
- If your phone is plugged in with a modem or surge protector, plug the phone (or modem/surge protector) into a different location. If this doesn't solve the problem, re-locate your phone or modem farther apart from one another, or use a different surge protector.
- Relocate your telephone base to a higher location. The phone will have better reception when not installed in a low area.
- If the other phones in your home are having the same problem, the problem is in your wiring or local service. Contact your local telephone company (charges may apply).

# Troubleshooting

The charge light is off.

- Make sure the power and line cords are plugged in correctly and securely.
- Unplug the unit's electrical power. Wait for 15 seconds, then plug it back in. Allow up to one minute for the cordless handset and telephone base to reset.
- Clean the cordless handset and telephone base charging contacts each month using a pencil eraser or cloth.
- Your phone might be malfunctioning. Please refer to the **Limited warranty** section of this user's manual for further instruction.

---

My caller ID isn't working.

- Caller ID is a subscription service. You must subscribe to this service from your local telephone company for this feature to work on your phone.
- If you subscribe to high-speed Internet service (Digital Subscriber Line - DSL) through your telephone line, you must install a DSL filter between the telephone base and the telephone wall jack (see page 5). The filter will prevent noise and caller ID problems caused by DSL interference. Please contact your DSL service provider for more information about DSL filters.
- Your caller must be calling from an area that supports caller ID.
- Both you and your caller's telephone companies must use caller ID compatible equipment.

---

System does not receive caller ID when on a call.

- Make sure you subscribe to caller ID with call waiting features services provided by your local telephone company. Caller ID features will work only if both you and the caller are in areas offering caller ID service, and if both telephone companies use compatible equipment.



## Troubleshooting

Incomplete messages.

- If a caller leaves a very long message, part of it may be lost when the system disconnects the call after four minutes.
  - If the caller pauses for more than seven seconds, the system stops recording and disconnects the call.
  - If the system's memory becomes full during a message, the system stops recording and disconnects the call.
  - If the caller's voice is very soft, the system may stop recording and disconnects the call.
- 

Difficulty hearing messages.

- Press **VOLUME ▲** to increase speaker volume.
- 

System does not answer after correct number of rings.

- Make sure that the answering system is on (see page 39).
  - If toll saver is activated, the number of rings changes to two when you have new messages stored (see page 43).
  - If the memory is full or the system is off, the system will answer after 10 rings.
- 

System announces "*Time and day not set.*"

- You need to reset the answering system clock (page 38).

# Troubleshooting

- System does not respond to remote commands.
- Make sure to enter your remote access code correctly (see pages 49-50).
  - Make sure you are calling from a touch-tone phone. When you dial a number, you should hear tones. If you hear clicks, the phone is not a touch-tone telephone and cannot activate the answering system.
  - The answering system may not detect the remote access code while your announcement is playing. Try waiting until the announcement is over before entering the code.
  - There may be noise or interference on the phone line you are using. Press dial pad keys firmly.
- 

- System does not record message.
- Make sure answering system is on (see page 39).
  - Make sure the memory of the answering system is not full.
- 

- Outgoing announcement is not clear.
- When you record your announcement, make sure you speak in a normal tone of voice, about nine inches from the telephone base.
  - Make sure there is no background noise (TV, music, etc.) while you are recording.
- 

- Common cure for electronic equipment.
- If the unit does not seem to be responding normally, try putting the cordless handset in its base. If it does not seem to respond, do the following (in the order listed):
- Disconnect the power to the telephone base.
  - Disconnect the cordless handset battery, and spare battery, if applicable.
  - Wait a few minutes.
  - Connect power to the telephone base.
  - Re-install the battery, and place the cordless handset into the telephone base.
  - Wait for the cordless handset to re-establish its connection with the telephone base. Allow up to one minute for this to take place.

## Maintenance

### **Taking care of your telephone**

- Your cordless telephone contains sophisticated electronic parts, so it must be treated with care.
- Avoid rough treatment.
- Place the handset down gently.
- Save the original packing materials to protect your telephone if you ever need to ship it.

### **Avoid water**

- Your telephone can be damaged if it gets wet. Do not use the handset outdoors in the rain, or handle it with wet hands. Do not install the telephone base near a sink, bathtub or shower.

### **Electrical storms**

- Electrical storms can sometimes cause power surges harmful to electronic equipment. For your own safety, take caution when using electric appliances during storms.

### **Cleaning your telephone**

- Your telephone has a durable plastic casing that should retain its luster for many years. Clean it only with a soft cloth slightly dampened with water or a mild soap.
- Do not use excess water or cleaning solvents of any kind.

Remember that electrical appliances can cause serious injury if used when you are wet or standing in water. If the telephone base should fall into water, DO NOT RETRIEVE IT UNTIL YOU UNPLUG THE POWER CORD AND TELEPHONE LINE CORDS FROM THE WALL. Then pull the unit out by the unplugged cords.

## Important safety information



This symbol is to alert you to important operating or servicing instructions that may appear in this user's manual. Always follow basic safety precautions when using this product to reduce the risk of injury, fire, or electric shock.

### Safety information

---

- **Read and understand all instructions in the user's manual. Observe all markings on the product.**
- **Avoid using a telephone during a thunderstorm.** There may be a slight chance of electric shock from lightning.
- **Do not use a telephone in the vicinity of a gas leak.** If you suspect a gas leak, report it immediately, but use a telephone away from the area where gas is leaking. If this product is a cordless model, make sure the telephone base is also away from the area.
- **Do not use this product near water, or when you are wet.** For example, do not use it in a wet basement or shower, or next to a swimming pool, bathtub, kitchen sink, or laundry tub. Do not use liquids or aerosol sprays for cleaning. If the product comes in contact with any liquids, unplug any line or power cord immediately. Do not plug the product back in until it has dried thoroughly.
- **Install this product in a protected location** where no one can trip over any line or power cords. Protect cords from damage or abrasion.
- **If this product does not operate normally, see the Troubleshooting section on pages 56-63 of this user's manual.** If you cannot solve the problem, or if the product is damaged, refer to the **Limited warranty** on pages 71-73. Do not open this product except as may be directed in your user's manual. Opening the product or reassembling it incorrectly may expose you to hazardous voltages or other risks.
- **Replace batteries only as described in your user's manual.** Do not burn or puncture batteries — they contain caustic chemicals.
- **This power adapter is intended to be correctly oriented in a vertical or floor mount position.** The prongs are not designed to hold the plug in place if it is plugged into a ceiling or an under-the-table/cabinet outlet.



Caution: Use only the power adapter provided with this product. To obtain a replacement, visit our website at **[www.telephones.att.com](http://www.telephones.att.com)** or call **1 (800) 222-3111**. In Canada dial **1 (866) 288-4268**.

## Important safety information

Especially about cordless telephones:

- **Privacy:** The same features that make a cordless telephone convenient create some limitations. Telephone calls are transmitted between the telephone base and the handset by radio waves, so there is a possibility that your cordless telephone conversations could be intercepted by radio receiving equipment within range of the cordless handset. **For this reason, you should not think of cordless telephone conversations as being as private as those on corded telephones.**
- **Electrical power:** The telephone base of this cordless telephone must be connected to a working electrical outlet which is not controlled by a wall switch. **Calls cannot be made from the handset if the telephone base is unplugged, switched off, or if the electrical power is interrupted.**
- **Potential TV interference:** Some cordless telephones operate at frequencies that may cause interference to TVs and VCRs. To minimize or prevent such interference, do not place the telephone base of the cordless telephone near or on top of a TV or VCR. If interference is experienced, moving the cordless telephone farther away from the TV or VCR will often reduce or eliminate the interference.
- **Rechargeable batteries:** This product contains either nickel-cadmium or nickel-metal hydride rechargeable batteries. Exercise care in handling batteries in order not to create a short circuit with conductive material such as rings, bracelets, and keys. The battery or conductor may overheat and cause harm. Observe proper polarity between the battery and the battery charger.
- **Nickel-metal-hydride rechargeable batteries:** Dispose of these batteries in a safe manner. Do not burn or puncture. Like other batteries of this type, if burned or punctured, they could release caustic material which could cause injury.



The RBRC™ Seal means that the manufacturer is voluntarily participating in an industry program to collect and recycle nickel-metal hydride rechargeable batteries when taken out of service within the United States. These batteries may be taken to a participating local retailer of replacement batteries or recycling center. Or you may call 1-800-8-BATTERY for locations accepting spent Ni-MH batteries.

## Important safety information

### **Precautions for users of implanted cardiac pacemakers**

---

Cardiac pacemakers (applies only to digital cordless telephones):

Wireless Technology Research, LLC (WTR), an independent research entity, led a multidisciplinary evaluation of the interference between portable wireless telephones and implanted cardiac pacemakers. Supported by the U.S. Food and Drug Administration, WTR recommends to physicians that:

### **PACEMAKER PATIENTS**

---

- Should keep wireless telephones at least six inches from the pacemaker.
- Should NOT place wireless telephones directly over the pacemaker, such as in a breast pocket, when it is turned ON.
- Should use the wireless telephone at the ear opposite the pacemaker.

WTR's evaluation did not identify any risk to bystanders with pacemakers from other persons using wireless telephones.

### **Especially about telephones answering systems**

---

Two-way recording: This unit does not sound warning beeps to let the other party know that the call is being recorded. To ensure that you are in compliance with any federal or state regulations regarding recording a telephone call, you should start the recording process and then inform the other party that you are recording the conversation.

## **SAVE THESE INSTRUCTIONS**

## FCC Part 68 and ACTA

This equipment complies with Part 68 of the FCC rules and with technical requirements adopted by the Administrative Council for Terminal Attachments (ACTA). The label on the back or bottom of this equipment contains, among other things, a product identifier in the format US:AAAEQ##TXXXX. This identifier must be provided to your local telephone company upon request.

The plug and jack used to connect this equipment to premises wiring and the telephone network must comply with applicable Part 68 rules and technical requirements adopted by ACTA. A compliant telephone cord and modular plug is provided with this product. It is designed to be connected to a compatible modular jack that is also compliant. An RJ11 jack should normally be used for connecting to a single line and an RJ14 jack for two lines. See Installation Instructions in the user's manual.

The Ringer Equivalence Number (REN) is used to determine how many devices you may connect to your telephone line and still have them ring when you are called. The REN for this product is encoded as the 6th and 7th characters following the US: in the product identifier (e.g., if ## is 03, the REN is 0.3). In most, but not all areas, the sum of all RENs should be five (5.0) or less. For more information, please contact your local telephone company.

This equipment may not be used with Party Lines. If you have specially wired alarm dialing equipment connected to your telephone line, ensure the connection of this equipment does not disable your alarm equipment. If you have questions about what will disable alarm equipment, consult your telephone company or a qualified installer.

If this equipment is malfunctioning, it must be unplugged from the modular jack until the problem has been corrected. Repairs to this telephone equipment can only be made by the manufacturer or its authorized agents. For repair procedures, follow the instructions outlined under the Limited Warranty.

If this equipment is causing harm to the telephone network, the telephone company may temporarily discontinue your telephone service. The telephone company is required to notify you before interrupting service. If advance notice is not practical, you will be notified as soon as possible. You will be given the opportunity to correct the problem and the telephone company is required to inform you of your right to file a complaint with the FCC. Your telephone company may make changes in its facilities, equipment, operation, or procedures that could affect the proper functioning of this product. The telephone company is required to notify you if such changes are planned.

If this product is equipped with a corded or cordless handset, it is hearing aid compatible.

## FCC Part 68 and ACTA

If this product has memory dialing locations, you may choose to store emergency telephone numbers (e.g., police, fire, medical) in these locations. If you do store or test emergency numbers, please:

Remain on the line and briefly explain the reason for the call before hanging up.

Perform such activities in off-peak hours, such as early morning or late evening.

### **Industry Canada**

Operation is subject to the following two conditions: (1) this device may not cause harmful interference, and (2) this device must accept any interference, including interference that may cause undesired operation.

The term "IC:" before the certification/registration number only signifies that the Industry Canada technical specifications were met.

The Ringer Equivalence Number (REN) for this terminal equipment is 0.1. The REN is an indication of the maximum number of devices allowed to be connected to a telephone interface. The termination on an interface may consist of any combination of devices subject only to the requirement that the sum of the RENs of all the devices does not exceed five.

This product meets the applicable Industry Canada technical specifications.



## FCC Part 15

This equipment has been tested and found to comply with the requirements for a Class B digital device under Part 15 of the Federal Communications Commission (FCC) rules. These requirements are intended to provide reasonable protection against harmful interference in a residential installation. This equipment generates, uses and can radiate radio frequency energy and, if not installed and used in accordance with the instructions, may cause harmful interference to radio communications. However, there is no guarantee that interference will not occur in a particular installation. If this equipment does cause harmful interference to radio or television reception, which can be determined by turning the equipment off and on, the user is encouraged to try to correct the interference by one or more of the following measures:

- Reorient or relocate the receiving antenna.
- Increase the separation between the equipment and receiver.
- Connect the equipment into an outlet on a circuit different from that to which the receiver is connected.
- Consult the dealer or an experienced radio/TV technician for help.

Changes or modifications to this equipment not expressly approved by the party responsible for compliance could void the user's authority to operate the equipment.

This device complies with Part 15 of the FCC Rules. Operation is subject to the following two conditions: (1) this device may not cause harmful interference, and (2) this device must accept any interference received, including interference that may cause undesired operation. Privacy of communications may not be ensured when using this telephone.

To ensure safety of users, the FCC has established criteria for the amount of radio frequency energy that can be safely absorbed by a user or bystander according to the intended usage of the product. This product has been tested and found to comply with the FCC criteria. The handset may be safely held against the ear of the user. The telephone base shall be installed and used such that parts of the user's body other than the hands are maintained at a distance of approximately 20 cm (8 inches) or more. If you choose to use a clipping device, please make sure to only use the supplied AT&T belt clip.

This Class B digital apparatus complies with Canadian ICES-003.

## Limited warranty

The AT&T brand is used under license - any repair, replacement or warranty service, and all questions about this product should be directed to: In the United States of America, visit **www.telephones.att.com** or call **1 (800) 222-3111**. In Canada, call **1 (866) 288-4268**.

### 1. What does this limited warranty cover?

The manufacturer of this AT&T-branded product warrants to the holder of a valid proof of purchase (“CONSUMER” or “you”) that the product and all accessories provided in the sales package (“PRODUCT”) are free from defects in material and workmanship, pursuant to the following terms and conditions, when installed and used normally and in accordance with the PRODUCT operating instructions. This limited warranty extends only to the CONSUMER for products purchased and used in the United States of America and Canada.

### 2. What will be done if the PRODUCT is not free from defects in materials and workmanship during the limited warranty period (“materially defective PRODUCT”)?

During the limited warranty period, the manufacturer’s authorized service representative will repair or replace at the manufacturer’s option, without charge, a materially defective PRODUCT. If the manufacturer repairs the PRODUCT, they may use new or refurbished replacement parts. If the manufacturer chooses to replace the PRODUCT, they may replace it with a new or refurbished PRODUCT of the same or similar design. The manufacturer will retain defective parts, modules, or equipment. Repair or replacement of the PRODUCT, at the manufacturer’s option, is your exclusive remedy. The manufacturer will return repaired or replacement products to you in working condition. You should expect the repair or replacement to take approximately 30 days.

### 3. How long is the limited warranty period?

The limited warranty period for the PRODUCT extends for ONE (1) YEAR from the date of purchase. If the manufacturer repairs or replaces a materially defective PRODUCT under the terms of this limited warranty, this limited warranty also applies to repaired or replacement PRODUCT for a period of either (a) 90 days from the date the repaired or replacement PRODUCT is shipped to you or (b) the time remaining on the original one-year limited warranty; whichever is longer.

## Limited warranty

### 4. What is not covered by this limited warranty?

This limited warranty does not cover:

- PRODUCT that has been subjected to misuse, accident, shipping or other physical damage, improper installation, abnormal operation or handling, neglect, inundation, fire, water, or other liquid intrusion; or
- PRODUCT that has been damaged due to repair, alteration, or modification by anyone other than an authorized service representative of the manufacturer; or
- PRODUCT to the extent that the problem experienced is caused by signal conditions, network reliability or cable or antenna systems; or
- PRODUCT to the extent that the problem is caused by use with non-AT&T accessories; or
- PRODUCT whose warranty/quality stickers, PRODUCT serial number plates or electronic serial numbers have been removed, altered or rendered illegible; or
- PRODUCT purchased, used, serviced, or shipped for repair from outside the United States of America or Canada, or used for commercial or institutional purposes (including but not limited to products used for rental purposes); or
- PRODUCT returned without valid proof of purchase (see item 6 below); -or-
- Charges for installation or setup, adjustment of customer controls, and installation or repair of systems outside the unit.

### 5. How do you get warranty service?

To obtain warranty service in the United States of America, visit **[www.telephones.att.com](http://www.telephones.att.com)** or call **1 (800) 222-3111**. In Canada, call **1 (866) 288-4268**. NOTE: Before calling for service, please review the user's manual; a check of the PRODUCT controls and features may save you a service call.

Except as provided by applicable law, you assume the risk of loss or damage during transit and transportation and are responsible for delivery or handling charges incurred in the transport of the PRODUCT(s) to the service location. The manufacturer will return repaired or replaced PRODUCT under this limited warranty to you. Transportation, delivery or handling charges are prepaid. The manufacturer assumes no risk for damage or loss of the PRODUCT in transit. If the PRODUCT failure is not covered by this limited warranty, or proof of purchase does not meet the terms of this limited warranty, the manufacturer will notify you and will request that you authorize the cost of repair prior to any further repair activity. You must pay for the cost of repair and return shipping costs for the repair of products that are not covered by this limited warranty.

## Limited warranty

6. What must you return with the PRODUCT to get warranty service? You must:

- a. Return the entire original package and contents including the PRODUCT to the service location along with a description of the malfunction or difficulty; and
- b. Include “valid proof of purchase” (sales receipt) identifying the PRODUCT purchased (PRODUCT model) and the date of purchase or receipt; and
- c. Provide your name, complete and correct mailing address, and telephone number.

7. Other limitations

This warranty is the complete and exclusive agreement between you and the manufacturer of this AT&T branded PRODUCT. It supersedes all other written or oral communications related to this PRODUCT. The manufacturer provides no other warranties for this PRODUCT. The warranty exclusively describes all of the manufacturer’s responsibilities regarding the PRODUCT. There are no other express warranties. No one is authorized to make modifications to this limited warranty and you should not rely on any such modification.

State/Provincial Law rights: This warranty gives you specific legal rights, and you may also have other rights which vary from state to state or province to province.

Limitations: Implied warranties, including those of fitness for a particular purpose and merchantability (an unwritten warranty that the PRODUCT is fit for ordinary use) are limited to one year from date of purchase. Some states/provinces do not allow limitations on how long an implied warranty lasts, so the above limitation may not apply to you. In no event shall the manufacturer be liable for any indirect, special, incidental, consequential, or similar damages (including, but not limited to lost profits or revenue, inability to use the PRODUCT or other associated equipment, the cost of substitute equipment, and claims by third parties) resulting from the use of this PRODUCT. Some states/provinces do not allow the exclusion or limitation of incidental or consequential damages, so the above limitation or exclusion may not apply to you.

**Please retain your original sales receipt as proof of purchase.**

## Technical specifications

RF frequency band (handset to telephone base)	2400 MHz — 2483.5 MHz
RF frequency band (telephone base to handset)	5725 MHz — 5850 MHz
Channels	95
Operating temperature	32°F — 122°F 0°C — 50°C
Telephone base voltage (AC voltage, 60Hz)	96 — 130 Vrms
Telephone base voltage (AC adapter output)	9VDC @600mA
Handset voltage	3.2 — 4.7 VDC 550mAh
Charger voltage (AC adapter output)	9VDC @200mA
Replacement battery	3.6V 600mAh

### **5.8 GHz digital spread spectrum frequency hopping technology**

This technology digitally transmits your voice across multiple channels in both the 5.8GHz and 2.4GHz frequencies to provide enhanced range, ultimate sound clarity and advanced privacy against eavesdropping on your calls, while not interfering with wireless routers.

### **Telephone operating range**

This cordless telephone operates within the maximum power allowed by the Federal Communications Commission (FCC). Even so, this handset and telephone base can communicate over only a certain distance — which can vary with the locations of the telephone base and handset, the weather, and the construction of your home or office.

# Index

## A

---

- AC adapter, 5
- Alert tones, 51
- Answering calls, 12
- Answering system, 36-50
- Auto off, 13

## B

---

- Battery charging, 6
- Battery installation, 6
- Belt clip, 7

## C

---

- Call intercept, 39
- Call screening, 39
- Call transfer using intercom, 19
- Call waiting, 15
- Caller ID (CID), 31
  - add entries to phone directory, 35
  - delete entries, 34
  - dial entries, 34
  - review history, 34
- Charger installation, 5
- Clear voicemail indication, 23

## D

---

- Delete caller ID history entries, 34
- Delete redial entries, 13
- Dialing,
  - from a caller ID record, 34
  - directory dialing, 30
- Directory, 25
  - dial number, 30
  - edit entries, 30
  - name search, 29
  - new entries, 26-27
- Display dial, 30
- DSL, 4, 5, 58, 61

## E

---

- Elapsed time, 12
- Ending calls, 12

## F

---

- Flash (switchhook flash), 15

## H

---

- Handset speakerphone, 12
- Handset locator, 14
- Handset settings, 20-24
- Headset, 7

## I

---

- Intercom, 18
- Incoming caller ID history, 34
- Incoming calls, answering, 12
- Indicator lights, 51

## L

---

- Language, 22
- Last number redial, 13

## M

---

- Making calls, 12
- Memory match, 33
- Missed calls indicator, 33
- Mute, 16

## N

---

- Names,
  - enter into directory, 27
  - search for, 29

## O

---

- On-hook dialing, 12

## Q

---

- Quick reference guide, 2-3

## R

---

- Receiving calls, 12
- Recharging, 6
- Redial, 13
- Remote access, 49-50
- Review caller ID history, 50
- Ring silencing, 24
- Ringer tone options, 21
- Ringer volume, 20

## S

---

- Search for names, 29
- Speakerphone, 12
- Switchhook flash, 15

# Index

## **T**

---

- Technical specifications, 74
- Telephone base installation, 5
- Telephone operating range, 74
- Troubleshooting, 56-63

## **V**

---

- Voicemail, 3, 51
- Voicemail waiting indicator, 22
- Voice prompts, 37
- Volume controls, 15, 20

# Remote access wallet card

Use the wallet card below to help you remember commands to control your answering system from any touch tone telephone.

Cut along dotted line.



Call your phone number, then enter your two-digit access code (preset to **19**).

Action	Remote command
--------	----------------

Play all messages .....	<b>1</b>
Play new messages.....	<b>2</b>
Delete the message.....	<b>3</b>
Delete all old messages.....	<b>33</b>
Repeat or go back.....	<b>4</b>
Stop.....	<b>5</b>
Help menu .....	<b>*5</b>

Fold here.

Skip the message.....	<b>6</b>
Record announcement .....	<b>*7</b>
Turn system off or on .....	<b>0</b>
End remote access call .....	<b>8</b> (or hang up)

**Model name: TL72108/TL72208/TL72308/TL72408**  
**Type: 5.8 GHz cordless telephone/answering system with caller ID/call waiting**

© 2008 Advanced American Telephones. All rights reserved.  
AT&T and the AT&T logo are trademarks of AT&T Intellectual Property II, L.P. d/b/a AT&T Intellectual Property licensed to Advanced American Telephones. Printed in China.





**[www.telephones.att.com](http://www.telephones.att.com)**