



Syn248 Installation and Configuration Guide



CONTENTS

Preface	4
Additional Documentation	4
Topic Navigation	5
Text Conventions	5
Installation	6
System Overview	7
Software Version Compatibility	7
System Installation Overview	9
Recommended Installation Sequence.....	10
Site Preparation.....	11
Network Requirements.....	11
Placement Considerations.....	12
Power Considerations.....	12
Other Preparations.....	12
Assigning Telephone Lines and Extensions.....	13
Providing Limited Telephone Service During AC Power Outages	13
Analog Line Connection Order on Gateways	13
Connecting a Two-Line Wall Jack to the Gateway.....	13
Extension Assignments.....	14
Gateway Placement.....	15
Rack Mounting	15
Wall Mounting.....	16
Gateway Installation	17
Deskset Installation.....	19
System Configuration.....	26
Logging in to the WebUI	27
Error Handling.....	29
System Settings.....	30
Changing the System Basic Settings.....	30
Configuring the Auto Attendant	33
Name Recording for the Auto Attendant Directory.....	38
Configuring Hold Settings.....	39
Configuring Phone Line CFNA	41



Creating, Editing and Deleting Paging Zones	43
System Directory.....	45
Line Naming.....	46
Extension Settings.....	47
Extension Basic Settings.....	47
Personal Directory	50
Deskset Programmable Feature Keys (PFKs)	52
Device Management.....	56
Deleting Devices.....	56
Change an Extension Number	57
Back Up and Restore Settings.....	58
Updating Devices.....	62
Device Log.....	65
Line Calibration Configuration.....	67
Help	68
Product Registration	69
Device Configuration.....	70
SB35010 Gateway Features.....	71
Gateway Front Panel Interface.....	73
Gateway Configuration.....	74
Upgrade Gateway Software	75
Resetting Devices.....	77
Deskset Admin Settings	78
Setting Intercom Call Forward–No Answer	79
Fwd/Trans to Outside Line.....	80
IP Settings.....	80
Reset User Password.....	82
Upgrade Deskset Software.....	82
Set Time and Date	83
Troubleshooting	84
Common Troubleshooting Procedures.....	85
Resetting Devices.....	85
Resolving General Functional Issues.....	86
Resolving Audio Echoes.....	87
Resolving General Audio Issues.....	88
Reintroducing a Deskset Into the System	88
Power Failure Recovery Procedure.....	90
Initial Installation	91
Display Messages.....	91
Gateway Setup.....	94
WebUI.....	95
Administrator WebUI	95
System Upgrade.....	99
User WebUI	100
PC/Deskset Interaction	101
Other Deskset Features.....	102



Appendixes	103
Appendix A: Expanding Your System.....	103
Appendix B: IP Addresses and Connectivity.....	104
Appendix C: Technical Specifications.....	105
Appendix D: Default Settings.....	106
Appendix E: Part Lists.....	108
SB35010 Gateway Parts List.....	108
SB35020 Deskset Parts List.....	109
Appendix F: Maintenance.....	110
Appendix G: Important Safety Instructions.....	111
Glossary	112



PREFACE

This Installation and Configuration Guide provides instructions for installing and setting up your Syn248 system with software version 1.0 or later. See [page 7](#) for instructions on checking the software version on the Gateway and the Deskset.

Before using this AT&T product, please read [“Appendix G: Important Safety Instructions” on page 111](#). Please read this guide thoroughly for all the information necessary to install your new AT&T product.



NOTE

For customer service or product information, visit our web site at www.telephones.att.com/smb or call **1 (888) 386-2006**. In Canada, dial **1 (888) 469-2005**.

Additional Documentation



Downloadable copies of all Syn248 documents, including user's guides and quick-start guides, are available from www.telephones.att.com/smb.





Topic Navigation

This Syn248 Installation and Configuration Guide features easy navigation between topics and the ability to return to your original topic.

Text in blue indicates a link to another page in the document. **Bold text in blue** indicates a hyperlink to an external web site.



You can also click the arrows at the bottom of the page to move around this document.

	Go back to the last page viewed.
	Go to the previous page.
	Go to the next page.

Text Conventions

Table 1 lists text formats and describes how they are used in this guide.

Table 1. Description of Text Conventions

Text Format	Description
Screen	Identifies text that appears on a device screen or a WebUI page in a title, menu, or prompt.
HARD KEY or DIAL-PAD KEY	Identifies a hard key, including the dial-pad keys.
CallFwd	Identifies a soft key.
 NOTE	Notes provide important information about a feature or procedure. Example of a Note.
 CAUTION	A caution means that loss of data or unintended circumstances may result. Example of a Caution.



CHAPTER

1

INSTALLATION

This section describes the physical installation of the Syn248 devices. Each system must include at least one Analog Gateway and one Deskset. Each Gateway supports up to four analog telephone lines.

- [“System Overview” on page 7](#)
- [“Recommended Installation Sequence” on page 10](#)
- [“Site Preparation” on page 11](#)
- [“Assigning Telephone Lines and Extensions” on page 13](#)
- [“Gateway Placement” on page 15](#)
- [“Gateway Installation” on page 17](#)
- [“Deskset Installation” on page 19.](#)



System Overview

AT&T SB35010 Analog Gateway — Each Gateway provides access to up to four analog outside telephone lines.



AT&T SB35020 Deskset — A Deskset with a standard screen and Programmable Feature Keys. A system can have up to 24 Desksets.



Web User Interface (WebUI) — The WebUI provides the ability to customize your system for your business from a PC that is on the same Local Area Network. The WebUI resides on the Gateways and Desksets, and is updated with device software updates. See [“Updating Devices” on page 62](#).



The Syn248 System can be expanded to support two Gateways and up to eight lines. For more information, see [“Appendix A: Expanding Your System” on page 103](#).

Software Version Compatibility

Systems with software versions 1.0 and later support the features described in this guide. **All Gateways and Desksets must have compatible software versions installed.**

- To determine the software version of a SB35010 Gateway from the device front panel, from idle, press **SELECT**, **SELECT**, and then **DOWN**. The software version appears.

Device Info	
SW Ver:	1.0.0
FW Ver:	Z003
S-Series:	1.0.0

- To determine the SB35020 Deskset software version, press **MENU**, then **4**, and then **▽** until **Software Ver** appears.

Deskset Information	
Software Ver:	1.0.0
Firmware Ver:	D023
S-Series:	1.0.0

- To determine the software version of all installed devices, log in as administrator. See [“Logging in to the WebUI” on page 27](#). Then click [Detailed Site Information](#) to see the software versions and other information. There may be a delay as the system gathers this information.



System Information

The following devices are registered at this site:

Desksets: 2
PSTN Gateways: 1

For detailed information regarding this site, press the button below.

[Detailed Site Information](#)

PSTN GATEWAYS				MODEL: SB35010	
Device ID	Lines Connected	IP Address	Software Version	Connected	
PSTN GW-1	1,2	192.168.0.103	1.0.0	Yes	

DESKSETS				MODEL: SB35020	
Ext Number	Name	IP Address	Software Version	Connected	
200	Amy Lee	192.168.0.105	1.0.0	Yes	
201	Graham Bell	192.168.0.102	1.0.0	Yes	



System Installation Overview

Figure 1 illustrates how the Syn248 system differs from conventional telephone systems in that calls are not coordinated by a central controller. Instead, the system uses a distributed control system over a new or existing LAN.

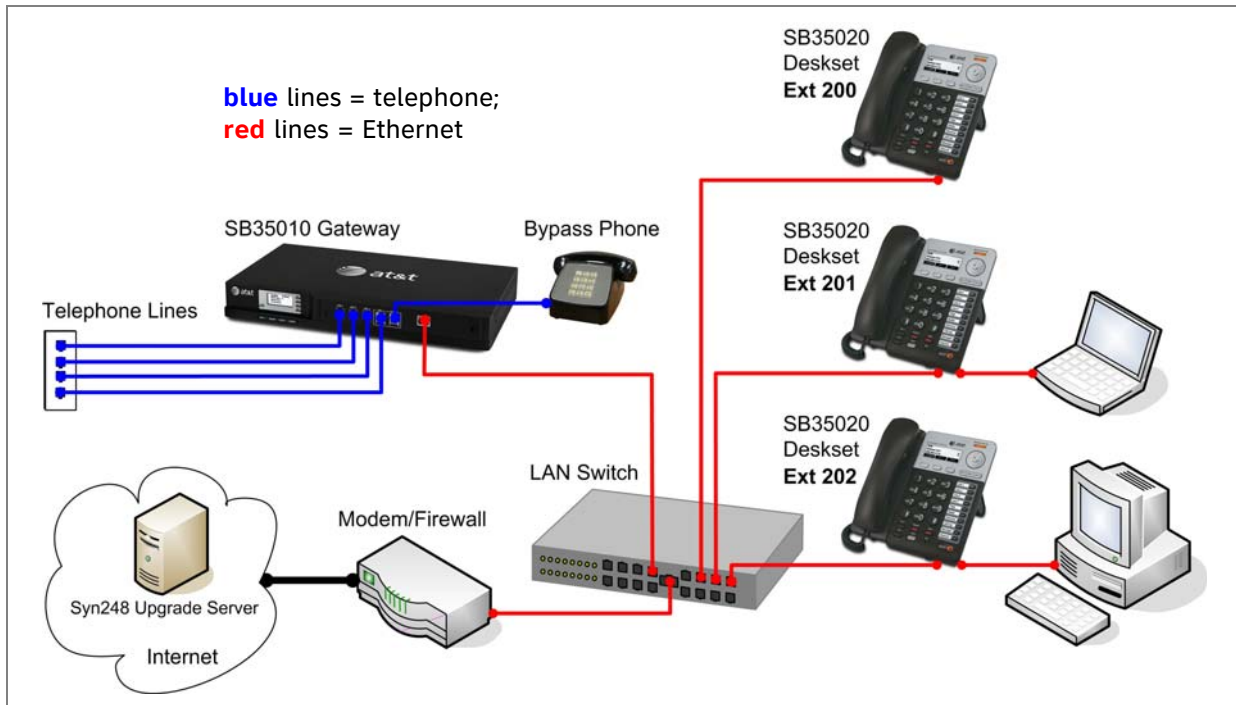

Figure 1. Sample System Network



Recommended Installation Sequence

1. Prepare your site for installation. See [“Site Preparation” on page 11](#).
2. Install the Gateway(s). See [“Gateway Installation” on page 17](#).
3. If you have only one Gateway, install the first Deskset. See [“Deskset Installation” on page 19](#). This Deskset is assigned extension number 200.
4. Install the other Desksets. See [“Deskset Installation” on page 19](#).
5. Configure the system using the WebUI. See [“System Configuration” on page 26](#).
6. Complete post-installation tasks.
 - Ask all users to record their user names on their Desksets. See [“Name Recording for the Auto Attendant Directory” on page 38](#).
 - Check for software upgrades and register your Syn248 system products. See [“Updating Devices” on page 62](#) and [“Product Registration” on page 69](#).



Site Preparation

This section describes how to prepare your site for a successful Syn248 system installation.

Network Requirements

- A switched network topology is recommended for your LAN (using standard 10/100 Ethernet switches that carry traffic at a nominal rate of 100 Mbit/s).
- The office LAN infrastructure should use Cat.-5 (or better) cable.
- The LAN connections to Syn248 devices should all be wired. However, wireless connections to other devices (such as laptops) in your office network that are not part of the Syn248 system will not impede performance.
- All devices in the Syn248 system must reside on a single subnet.
- A DHCP server is recommended and must be on the same subnet as the Syn248 system so that IP addresses can be auto-assigned. In most cases, your network router will have a Dynamic Host Configuration Protocol (DHCP) server that will automatically assign IP addresses to Syn248 devices in the system. By default, Syn248 assumes that this automatic assignment will occur.

If no DHCP server is present, you can assign static IPs. DHCP or static IPs are only required if the system is to be managed from a routable network and/or automatic time updates from an NTP server are desired. Syn248 devices will self-assign link-local IP addresses for all voice communication in addition to any DHCP or static IPs that are assigned for management purposes. For more information, see [“Appendix B: IP Addresses and Connectivity” on page 104](#).

- Unless you want to manually set the Syn248 clock and manually upgrade Syn248 software, an Internet connection to the LAN is required.
- A DNS server is recommended to resolve the path to the Internet and to the AT&T server for software upgrades.
- If a routing path to the Internet is not available, the system administrator can download the upgrade files and use the WebUI to upgrade the software manually.
- For users whose computers require a GigE Ethernet frame rate (a gigabit per second), use separate Ethernet connections for the Deskset and the computer. The Ethernet connection through a Deskset is limited to 100 Mbits/s.



Placement Considerations

Avoid placing any Syn248 component too close to the following:

- Communication devices, such as television sets, DVD players, or other cordless telephones
- Excessive heat sources
- Noise sources, such as a window with traffic outside, motors, microwave ovens, refrigerators, or fluorescent lighting
- Excessive dust sources, such as a workshop or garage
- Excessive moisture
- Extremely low temperature
- Mechanical vibration or shock, such as on top of the washing machine or workbench.

Power Considerations

Ensure that there is an electrical outlet not controlled by a wall switch within 6 feet (1.83 m) of each device location.

SB35020 Desksets are also compatible with Power over Ethernet (PoE). To use PoE, your network needs a switch that provides PoE. Using PoE simplifies your installation by eliminating the need to route separate power cords. It also allows you to protect your system from power outages by connecting an Uninterruptible Power Supply (UPS) to your PoE switch and Gateway(s). For power requirement specifications, see [“Appendix C: Technical Specifications” on page 105](#).

Other Preparations

Before installing the Gateway and Desksets, the following preparations may need to be taken:

- All telephone lines must be gathered into one access point situated no more than 9 feet (2.74 m) from the Gateway location. If rewiring is required, contact your telephone service provider and request the help of a qualified technician.
- You may need one or more network switches set up to ensure there are sufficient ports available for other devices in the network (such as a DSL modem).
- If you plan to use the emergency bypass feature on the Gateway, you will need an analog phone.
- An Ethernet Port must be available within 9 feet (2.74 m) of each Deskset location. Each Deskset is capable of sharing an Ethernet port with a PC. If one Ethernet port already exists at a workstation, another port is not necessary unless you need a GigE Ethernet frame rate. If this is the case, use a separate Ethernet connection for the Deskset and the computer.



Assigning Telephone Lines and Extensions

This section discusses various telephone line configuration issues to consider.

Providing Limited Telephone Service During AC Power Outages

The fourth line on each Gateway is a Bypass port that works during AC power failures. If you have a telephone line plugged into **LINE 4**, connect a line-powered analog telephone to the RJ-11 jack labeled **BYPASS** for telephone service during power failures. When power returns and the line is idle, a relay disconnects this emergency bypass line so that the bypass line cannot be used to eavesdrop on normal calls.

If your telephone lines are part of a hunt group (a telephone company feature that allows calls to a busy phone number to roll over to the next available telephone line), connect the line with your main (pilot) telephone number to Gateway **LINE 4**.

Analog Line Connection Order on Gateways

For outgoing calls, by default the system seizes the lowest idle LINE port numbers (as labeled on the Gateway) when users go off hook. You can also configure the automatic off-hook line selection for each extension (see [“Extension Basic Settings” on page 47](#)).

If you plan not to change the default settings, telephone lines should be connected to your system with your busiest incoming line placed in the highest port number on the highest numbered Gateway (that is, Gateway #2 if you have the maximum two Gateways installed), so that incoming calls are less likely to receive busy signals. For instance, if your customer service team receives many calls, you would want to plug their phone lines into higher-numbered LINE ports.

Connecting a Two-Line Wall Jack to the Gateway

If you have two phone lines coming from one wall jack, you must use a two-line adapter (or A/B splitter) as shown in Figure 2 to convert the two-line jack into two single-line jacks. Each single-line jack will then connect to a Gateway LINE port.

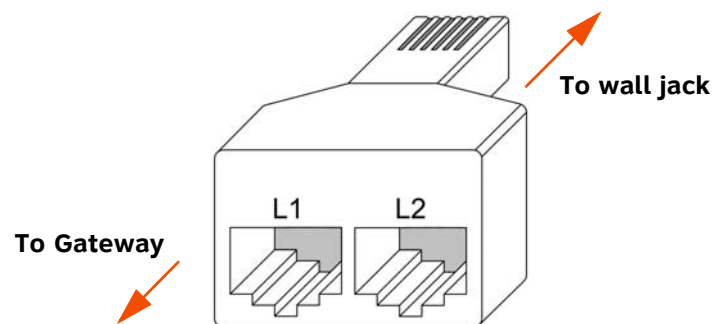

Figure 2. Two-line Adapter

Extension Assignments

The system assigns the first Deskset to join the network as extension 200. The system automatically assigns each additional Deskset an extension number in ascending order as it is connected to the LAN.

Once the Desksets are connected to the same network, they find each other through Peer-to-Peer (P2P) discovery protocols and automatically self-configure. Additional telephony and network configuration is administered through the WebUI.

Even if you disconnect a unit from the network, its extension number is reserved. If you want to remove an extension from the network permanently, you must disconnect it, then delete the extension number using the WebUI **Device Management** menu. Deletion ensures that the Deskset does not tie up an extension. You can also use the WebUI to change extension numbers for Desksets connected to the network.



Gateway Placement

You can place the Gateway on a tabletop, mount it into a standard 19-inch metal rack, or wall mount it. The Gateway must be installed within three feet of the building ground point. Install each device using the following instructions.

Rack Mounting

To mount the Gateway into a standard 19-inch rack:

1. Remove the two mounting brackets and six screws from the packing tissue.
2. Position a bracket at the front of the device.
3. To align the screw holes, place the bracket on the device so that the locating indent on the bracket matches the indent on the device.

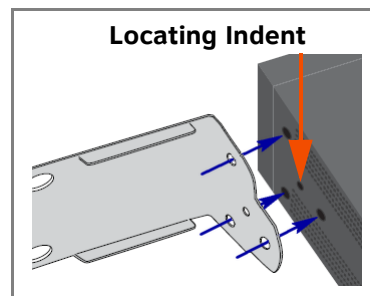

4. Insert each of the three screws into the holes provided and tighten securely. Repeat the process for the other bracket.

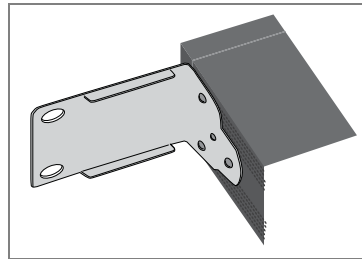

5. Position the chassis into the rack.



6. Insert a top mounting screw (not included) in one side and turn it several turns to establish support. Repeat for the other side.
7. Tighten the screws.

Wall Mounting

You can mount the Gateway to a wall using the two mounting slots on the bottom of the device. Ensure that the device is oriented as shown in Figure 3 to allow air to flow vertically through the ventilation holes on each side of the device.

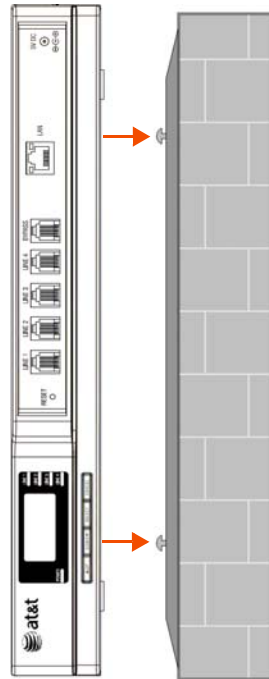



Figure 3. Wall Mount Orientation

To mount the Gateway to a wall:

1. Install two pan-head screws (with $\frac{1}{4}$ -inch diameter head) 7 $\frac{7}{8}$ inches (20 cm) apart. The screw shaft diameter should be $\frac{1}{8}$ -inch (3.2 mm). Ensure you use anchors appropriate for your mounting surface. Leave about $\frac{1}{8}$ -inch (3.2 mm) clearance between the screw head and the wall.
2. Position the device with the mounting slot centers aligned over the mounting screws. Carefully bring the device down onto the screws.
3. Slide the device downwards so that the screws go into the mounting slots on the device. Ensure the device is secure.

Gateway Installation

CAUTION  The Gateway grounding terminal shown in Figure 4 must be connected to reliable earth ground using a separate ground wire before connecting the telecommunication lines. The connection to earth ground must be verified by qualified personnel.

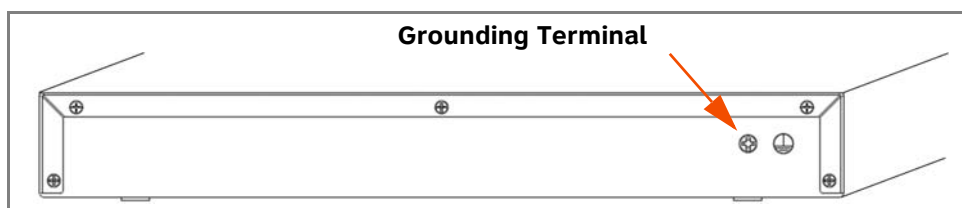



Figure 4. Gateway Grounding Terminal

NOTE  If your service provider uses Centrex lines, you must log in to the WebUI and enter a line access code for each line to allow calibration to take place. Before connecting the PSTN lines, connect the Gateway and one Deskset to the network, then see [“Logging in to the WebUI” on page 27](#) and [“Line Calibration Configuration” on page 67](#).

Connect the telephone lines to the Gateway:

1. Remove the plastic covers from the Gateway LINE ports to be used, as shown in Figure 5.

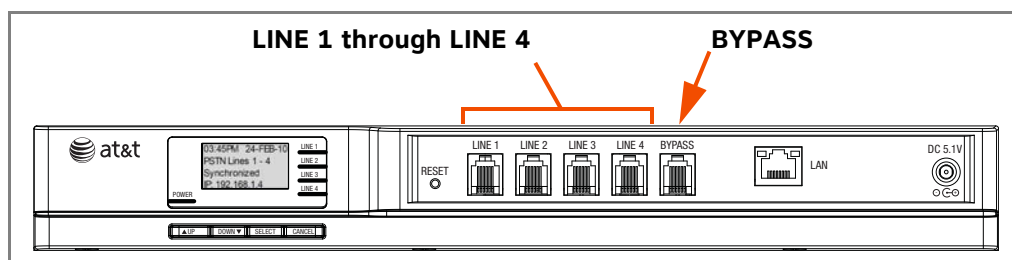



Figure 5. Gateway Telephone Line Connections

2. Plug up to four telephone lines from the telephone wall jacks into the Gateway.

CAUTION  If you subscribe to Digital Subscriber Line (DSL) high-speed Internet service through your telephone line, you must plug each telephone line with DSL service into a DSL filter. Then plug the DSL filter into the telephone wall jack, as shown in Figure 6.

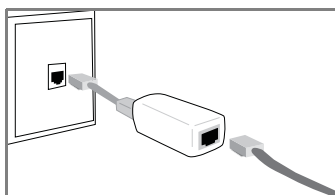
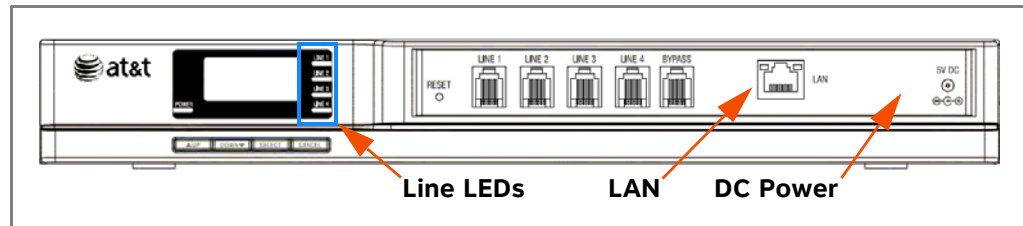

Figure 6. DSL Connection

Connect the Gateway to the Network:

1. Connect the supplied Cat.-5 LAN cable (or a comparable substitute) from your office LAN to the Gateway LAN port.

**Figure 7. Gateway Power and LAN Connections**

2. Plug the AC plug into an electrical outlet not controlled by a wall switch and the DC plug into the DC jack, as shown in Figure 7. Wait up to one minute until the screen lights up.

The Gateway takes about a minute to power up. The Line LEDs blink for up to 15 seconds during initialization, then turn off.

After another Syn248 device is installed, and after the Gateway has found the network and the other Syn248 device, **Synchronized** appears on the third line of the display as shown in Figure 8. This is the Idle screen.

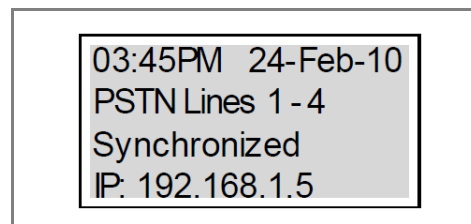
**Figure 8. Gateway Idle Screen, Synchronized**

An IP address beginning with 169.xxx indicates there is no DHCP server on the network. Without a DHCP auto-assigned IP address (usually beginning with 192.xxx), the Syn248 devices may not show the correct time and date and you may not be able to access the WebUI to configure the system. You may have to set the time and date manually from a Deskset. See ["Set Time and Date" on page 83](#).



Deskset Installation

Figure 9 identifies the features on the bottom and side of the Deskset. You can install the Deskset on a desktop or mount it on a wall.

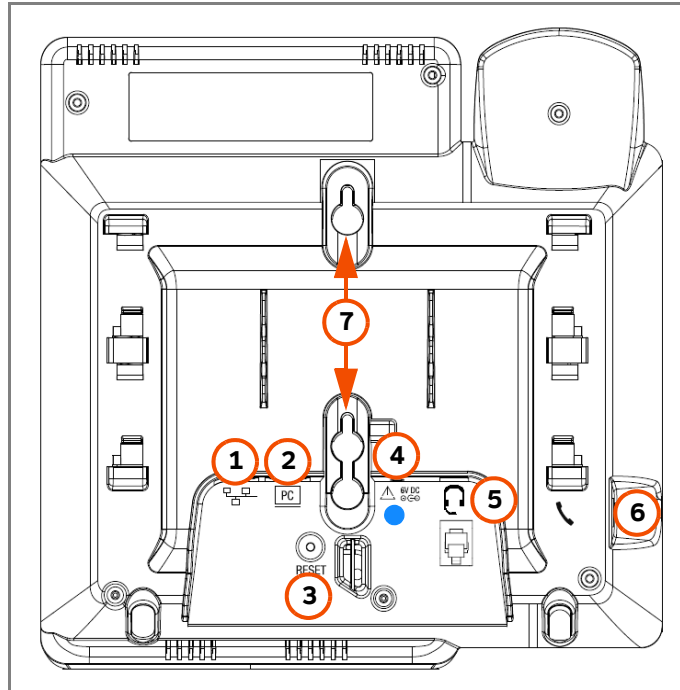

Figure 9. Deskset Connections

- | | |
|-------------------------------|---|
| 1. Network Port | <p>The two LEDs next to each network port indicate network status and AC power status.</p> <ul style="list-style-type: none"> ■ The green LED is on when the Deskset is connected to the network and has AC power. ■ The yellow LED flashes when there is network activity. |
| 2. PC Port | <p>Intended for connecting an end-user PC to share the same LAN connection as the Deskset.</p> |
| 3. Reset Button | <p>Restarts the Deskset when pressed momentarily.</p> <p>Restores factory defaults when pressed and held for more than five seconds with the LAN cable disconnected.</p> |
| 4. Power Jack | <p>For connecting the AC adapter to the Deskset. The Deskset also supports Power over Ethernet.</p> |
| 5. Corded Headset Jack | <p>Actual jack location may be different than shown</p> |
| 6. Handset Jack | |
| 7. Wall-Mount Slots | <p>See "To install the Deskset on a wall:" on page 22.</p> |



To attach the Desktop Stand for desktop installation:

1. Select a Deskset position. The desktop setup requires the Deskset Stand and provides two positions, Option 1 at 45° and Option 2 at 60°, as shown in Figure 10. If you use Option 2, rotate the Handset tab as explained in [“To rotate the Handset tab for wall and Deskset Option 2 installation:”](#) on page 21.

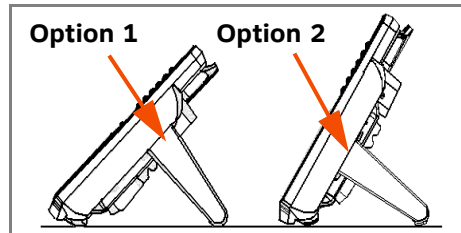
**Figure 10. Deskset Stand Options**

2. Place the Deskset on a flat surface with the power and network ports facing you, as illustrated in Figure 12.
3. Place the stand, illustrated in Figure 11, on the base with the flexible tab side away from you.

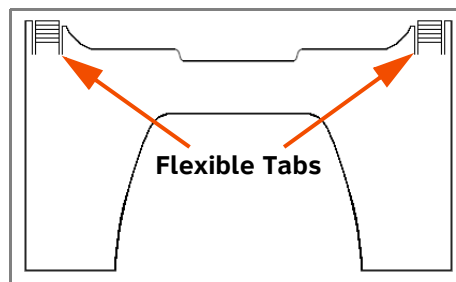
**Figure 11. Deskset Stand Tabs**

4. Insert the solid tabs of the stand into the Option 1 or Option 2 slots on the base that are marked in red in Figure 12.

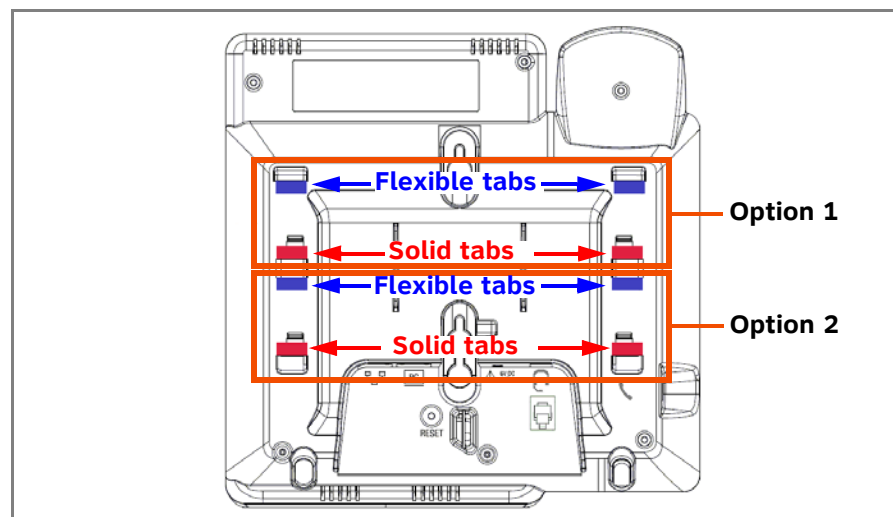
**Figure 12. Deskset Stand Installation**

5. Rotate the stand away from you until it rests against the base and you hear a click as the flexible tabs lock into place.

To rotate the Handset tab for wall and Deskset Option 2 installation:

1. Press the switch hook and slide the Handset Tab toward the top of the base, as shown.

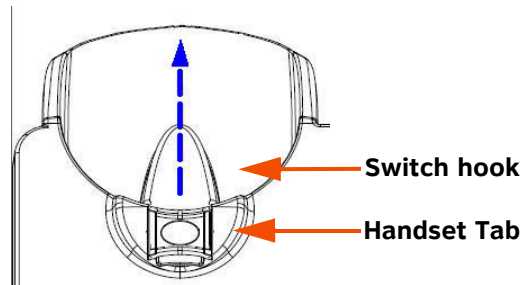

2. Rotate the Handset Tab 180° so that the "hook" is at the top.

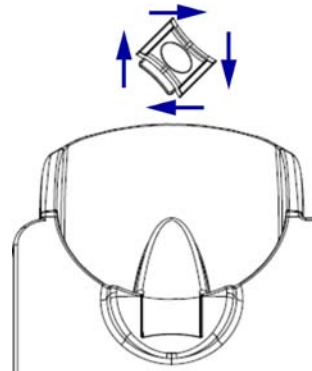

3. Slide the Handset Tab back into the base.

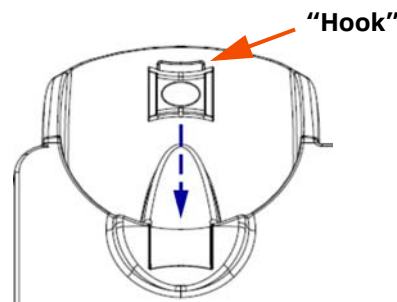

To install the Deskset on a wall:

1. Plug the Ethernet cable into the port on the back of the Deskset. (See [“To connect the Deskset to the Network:”](#) on page 24.)
2. Plug the power adapter into the jack on the back of the Deskset. Skip this step if using PoE. (See [“To connect power:”](#) on page 25.)
3. Place the Deskset base over the mounting plate above the mounting studs as shown in **1**.
4. Slide the Deskset base down as shown in **2**.

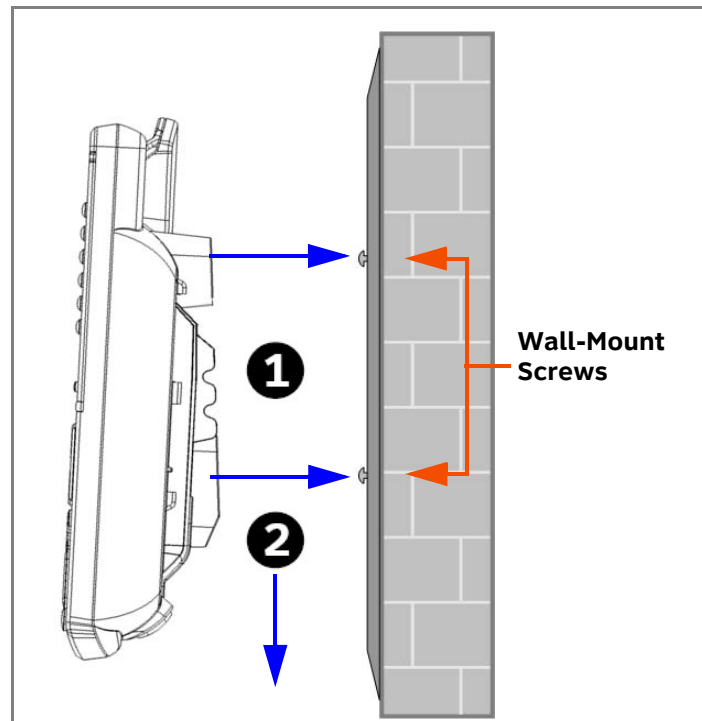

5. Plug the Ethernet cable into the wall jack.
6. Plug the power adapter into a power outlet not controlled by a wall switch. Skip this step if using PoE.
7. Make sure the Handset tab is in Wall position, as described in [“To rotate the Handset tab for wall and Deskset Option 2 installation:”](#) on page 21.
8. Connect the handset to the handset jack on the left side of the Deskset.

Connect the corded handset:

1. Plug the coiled end of the handset cord into the handset jack on the left side of the Deskset.

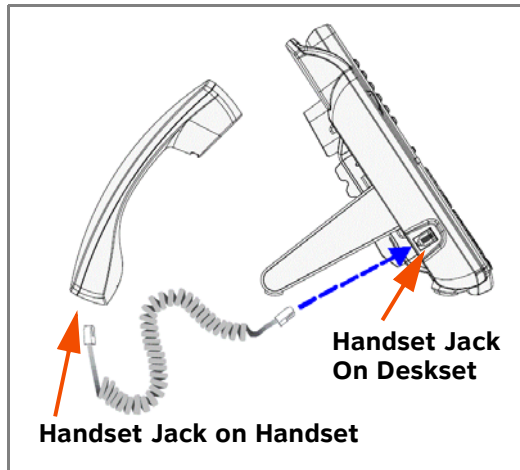

2. Plug the end of the handset cord with the longer straight portion into the handset, then hang up.

Connect an optional corded headset:

Plug an optional corded headset or cordless headset base into the RJ-9 connector on the bottom of the Deskset, as shown.

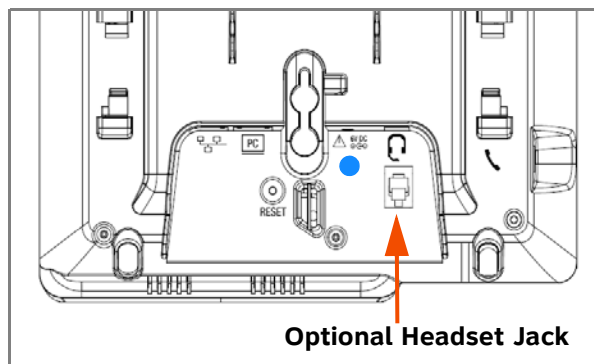

Do not plug a headset into the jack for the corded handset.



To connect the Deskset to the Network:

If the Deskset has a dedicated network connection, then connect the Deskset to the network connection only.

1. Plug a Cat.-5 Ethernet cable into the Network port on the back of the Deskset.
2. Plug the other end into an Ethernet wall jack that connects to your LAN switch.

If there is a networked computer and no extra Ethernet wall jacks near the Deskset, then the Deskset and PC can share the same network connection.

1. Unplug the Cat.-5 Ethernet cable from your computer.
2. Plug that Cat.-5 Ethernet cable into the Network port on the back of the Deskset, as shown below.

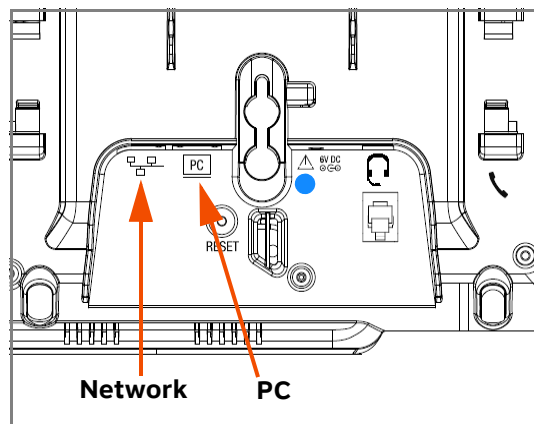

3. Plug another Cat.-5 Ethernet cable into the PC port on the Deskset.
4. Plug the other end of the second Cat.-5 Ethernet cable into your computer.
 - If a GigE network is being used, a computer connected through the Deskset will be limited to 100 Mbits/s. If you require a GigE Ethernet rate, use separate Ethernet connections for the Deskset and the computer so that the computer can take advantage of the greater bandwidth.
 - If a PC is connected to your LAN through a Deskset, any Deskset resets and power or network interruptions will disrupt the PC's connection to the network.



CAUTION The PC port on the Deskset is intended for connection to an end-user PC only.

- Do not use the PC port to connect to a PC with a heavy bandwidth load (such as a network server PC or a hub, switch, or router).
- Do not use the PC port to extend the network. The end-user PC should be the final point. Do not use the PC port to connect to other system devices.



To connect power:

If you are using PoE, connecting the Deskset to the network also connects the power.

If you are using the supplied power adapter:

1. Plug the power adapter (blue tag) into the DC Power jack on the back of the Deskset.

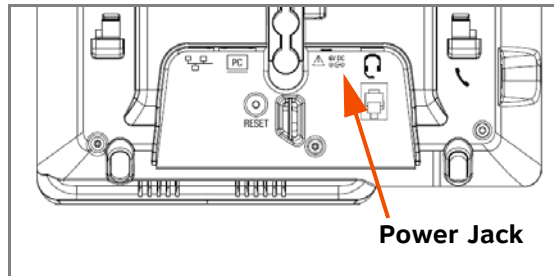

2. Plug the power adapter into an outlet not controlled by a wall switch. The display screen illuminates within about a minute.

If the user's computer is plugged into an uninterruptible power supply (UPS), consider plugging the Deskset into it, too.



CHAPTER
2

SYSTEM CONFIGURATION

You can configure the Syn248 System using the WebUI. The WebUI consists of web pages with editable settings for the system and each Syn248 device. The WebUI is embedded in every SB35010 Gateway and SB35020 Deskset. When you access the WebUI, you are accessing it on the device, not on the Internet.

This chapter shows you how to access and log in to the WebUI, then guides you through the settings you may have to configure to commission or to customize a Syn248 System.

This chapter also covers device management using the WebUI. As the system administrator, you will use the WebUI to delete devices from the system, change extension numbers, back up your settings, and upgrade devices.

**NOTE**

After completing the configuration of the system, back up the system settings. See [“Back Up and Restore Settings” on page 58](#).



Logging in to the WebUI



CAUTION

Only one person at a time should log in as the system administrator to prevent unintentional overwriting of changes.



WebUI information for individual users is contained in the “Web Interface” chapter of the SB35020 Deskset User’s Guide at www.telephones.att.com/smb.

To access the browser interface and log in:

1. Ensure your computer is connected to the same IP subnet as the Syn248 system. The easiest way to ensure this is to connect your PC to the **PC** port on the back of a Deskset with an Ethernet cable.
2. On the Deskset, press **MENU** then **4**. The **Deskset Information** screen appears. Note the IP Address.

Deskset Information ▼	
Model No:	SB35020
Status:	Synchronized
IP Address:	192.168.1.3

3. Open a browser. We recommend Internet Explorer 7 or higher for best performance. If you are using a different browser, some of the pages presented here may look different and have different controls.
4. Type the Deskset **IP Address** as shown in Step 2 in the browser address bar, then press **ENTER**.

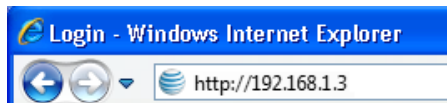

NOTE

You can also use a Gateway IP address (shown in [Figure 18 on page 73](#)) to log in to the WebUI.

The **Login** page appears.



Login

Login Name:

Login Name: Users should enter the extension number. Administrators should enter the Administrator ID.

Password:

Password: If there is an Extension password, the User should enter that password. If there is no Extension password, the User should leave the password field blank. Administrators should enter the administrator password.



5. Enter **admin** in the **Login Name** field and **12345** in the **Password** field, then click [Login](#). You may change the Admin ID and password once you are logged in.

The **System Information** page appears.



The **System Information** page displays the count of Desksets and Gateways. You can also expand the **System Information** page to display **Detailed System Information**, which lists information specific to each installed device (such as the **IP Address** and **Software Version**).

Click topics from the navigation menu on the left side of the WebUI to see them. You view and change settings in two different types of fields: drop-down lists and entry fields into which you type information. For your security, the WebUI times out after 10 minutes, so if it is idle for that time, you must log in again.

The remaining procedures in this chapter assume that you are already logged in to the WebUI as administrator.



CAUTION

In most cases there are multiple settings on one page. Changing a setting does not instantly apply the new value. Click [Apply](#) on the WebUI to save all changes on that page.



NOTE

Changes made on the WebUI are transmitted to all connected devices when applied. If changes are being made at the Deskset and WebUI simultaneously, a first-come-first-served policy on resource allocation applies. System configuration changes are transmitted globally when you press **Save** on the Deskset or click [Apply](#) on the WebUI.



Error Handling

If you type an invalid value into one of the WebUI fields and click [Apply](#), the page is not saved. The WebUI displays an error message at the top of the page. The field with the incorrect value is highlighted in yellow, as shown in Figure 13. You can view a more detailed error description by resting your mouse pointer on the highlighted field.

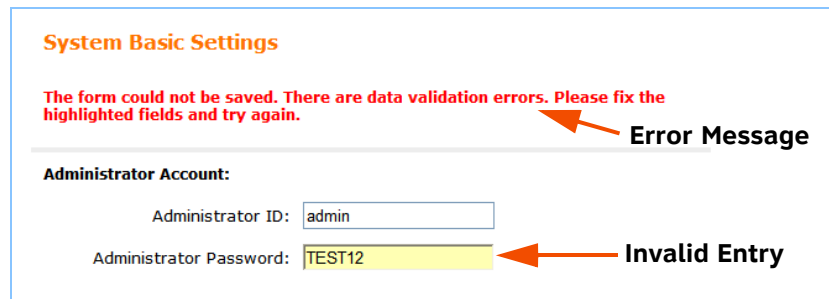

Figure 13. WebUI Error Indication

To view Detailed System Information:

1. On the **System Information** page, click [Detailed Site Information](#).

Information specific to each installed device appears. There may be a delay as the system gathers this information.



The **Connected** column indicates whether or not the listed device is synchronized with the system, so that communication can occur. **No** means the device is registered with the system, but not currently powered on or detected.

[Logout](#)

System Settings

- [System Information](#)
- [Basic Settings](#)
- [Auto Attendant](#)
- [Hold Settings](#)
- [Phone Line CFNA](#)
- [Paging Zones](#)
- [System Directory](#)
- [Line Naming](#)
- Extension Settings**
- Device Management**
- Help**

System Information

The following devices are registered at this site:

Desksets: 2
PSTN Gateways: 1

For detailed information regarding this site, press the button below.

[Detailed Site Information](#)

PSTN GATEWAYS			MODEL: SB35010	
Device ID	Lines Connected	IP Address	Software Version	Connected
PSTN GW-1	1,2	192.168.0.103	1.0.0	Yes

DESKSETS			MODEL: SB35020	
Ext Number	Name	IP Address	Software Version	Connected
200	Amy Lee	192.168.0.105	1.0.0	Yes
201	Graham Bell	192.168.0.102	1.0.0	Yes



System Settings

After you log on to the WebUI as the administrator with a Gateway or Deskset IP address, you can make changes to the system or to individual Desksets.



CAUTION When making changes to the System Settings through the WebUI, ensure that no one is using the system. To ensure the system is idle, you might need to make the changes outside of normal office hours.

The System Settings covered in this chapter include:

- [“Changing the System Basic Settings” on page 30](#)
- [“Configuring Phone Line CFNA” on page 41](#)
- [“Configuring the Auto Attendant” on page 33](#)
- [“Creating, Editing and Deleting Paging Zones” on page 43](#)
- [“Configuring Hold Settings” on page 39](#)
- [“System Directory” on page 45](#)
- [“Line Naming” on page 46](#)

Changing the System Basic Settings

To view or modify the System Basic Settings:

1. In the navigation menu at left, click **Basic Settings**.

The **System Basic Settings** page appears.

System Basic Settings

Administrator Account:

Administrator ID:

Administrator Password:

Operator Extension:

Assign Operator "0" Extension:

2. If necessary, change the **Administrator Account**. The **Administrator ID** can be up to 16 characters long. The **Administrator Password** is limited to four to six digits. Values outside this range generate an error message.
3. Select the **Operator Extension**. Any Deskset can be designated as the system operator. The default is Extension 200. The Operator can select the current Auto Attendant menu. See [“Configuring the Auto Attendant” on page 33](#). As well, incoming external calls are forwarded to the operator extension if the caller presses **0** (zero) after the Auto Attendant answers or when callers reach an extension’s voicemail. Deskset users can call the operator by pressing **0** from an active Intercom line.



4. Set the **Timer for Forwarded and Transferred Outside Calls**. This sets the **Maximum Call Duration** for incoming calls when they are forwarded to non-system phone numbers, such as to cell phones. When you forward these calls, two phone lines are in use for the duration of the forwarded call — one for the incoming call and one for the call to the forwarded line — with no Syn248 user able to end the call. The default time is 30 minutes, adjustable from 15 to 120 minutes. Calls exceeding the Maximum Call Duration are dropped with no warning to the callers.

Timer for Forwarded and Transferred Outside Calls:

Maximum Call Duration:

Hook Flash:

Enable Hook Flash System-Wide: Yes No

System Time/Date Options:

If you are changing the time settings, please ensure the system is idle and not in use before continuing.

Set Time by NTP Server

NTP Server:

Default

Custom Time Server:

Time Zone:

Daylight Savings Time: Yes No

Manual

Hour Min Am/Pm Month Day Year

Time Zone:

Daylight Savings Time: Yes No

5. Enable or disable Hook Flash system-wide. When enabled, Desksets have a **Flash** soft key available when an external line is active. Pressing **Flash** simulates a hook flash, which signals your telephone service provider to activate a feature. For example, hook flash may switch you to another incoming call when you hear a call-waiting tone, or enable you to create a conference call. These features may be offered as part of your phone plan. Features that use hook flash occur at the Central Office (CO) and are separate from any similar functions in Syn248.
6. Set the **System Time/Date Options**. You can set the system time to follow a Network Time Protocol (NTP) Server (recommended) or you can set the time and date manually.

Click **Set Time by NTP Server**:

- a. Click **Default** to set the time automatically from the Internet.



- b. Click **Custom Time Server** if you have your own preferred time server, then enter the server's URL.
- c. Select your **Time Zone**.
- d. Click **Yes** or **No** for **Daylight Savings Time**.

OR

To set the time and date manually, click **Manual**.

- a. Enter the current time and date.
 - b. Select your **Time Zone**.
 - c. Click **Yes** or **No** for **Daylight Savings Time**.
7. Click to save these settings or click .



Configuring the Auto Attendant

The Auto Attendant automatically answers unanswered external calls when it is set as a Call Forward–No Answer destination on the **Phone Line CFNA** page. See [“Configuring Phone Line CFNA” on page 41](#). When calls are forwarded to the Auto Attendant, callers hear the Auto Attendant menu, which tells them how to use a touch-tone telephone to reach the appropriate person, operator, or extension mailbox.

You can select one of three Auto Attendant menus from the Operator extension — the Default menu, a Day Menu, or a Night Menu. The default menu instructs callers to “Enter the extension number or enter 0 for the operator.”

You can configure the Day Menu and Night Menu with your own voice greetings and key-press commands.

Customizing the Auto Attendant Day and Night Menus

Auto Attendant menus consist of the recordings that the callers hear and lists of actions they can take. To customize the Day and Night menus, plan what you want callers to be able to do. In preparation for recording, write down the greeting and instructions you want callers to hear when they reach each menu. See [“Auto Attendant Voice Prompts” on page 36](#).



To customize a menu:

1. Click **System Settings**, then **Auto Attendant**. The Day Menu appears.

2. Click **Play/Record** to record a menu voice prompt. The **Auto Attendant Voice Prompts** screen appears. See [“Auto Attendant Voice Prompts” on page 36](#).
3. Set **Enable Direct Dial**. Enabling Direct Dial allows callers to directly dial extensions by entering an extension number after reaching the Auto Attendant.

**NOTE**

If you assign dial key values that are the same as the first digit of any extension (2, for example), callers will be unable to directly dial those extensions. Instead, they will be connected to the menu action associated with that key value.

4. Select **Enable Operator**. Enabling the operator allows callers to press zero (0) to reach the operator. (The default operator extension is 200.) When **Enable Operator** is **On**, callers cannot press **0** for other actions.



- Set the dial key values. Program an action for each digit as needed by selecting the action from each digit's drop-down list.

The screenshot shows a configuration window with the following elements:

- Buttons for "Press 1:" through "Press #:" (asterisk and hash), each with a dropdown menu.
- A dropdown menu for "Press 1:" is open, showing:
 - None
 - Preset Actions**
 - Replay
 - Auto Attendant Directory
 - Extensions**
 - Ext. 200
 - Ext. 201
 - Personal Voicemails**
 - Mailbox 200
 - Mailbox 201
- Buttons for "Apply" and "Cancel" at the bottom.

The available choices are:

- **None** — No action.
- **Replay** — Replays the current message.
- **Auto Attendant Directory** — Accesses the Auto Attendant Directory, which allows callers to spell a name, followed by the pound (#) sign. See [“Name Recording for the Auto Attendant Directory” on page 38](#) and [“Extension Basic Settings” on page 47..](#)
- **<Extensions>** — Sends calls directly to a specific extension.
- **<Personal Voicemail>** — Sends call directly to a specific extension's personal voicemail.



If no digit keys have been pressed five seconds after the voice prompt, the voice prompt replays. After replaying the voice prompt three times, the Auto Attendant says “Goodbye” and hangs up the call.

If the caller hangs up the phone, the Auto Attendant stops.

- When you are done, click **Apply** to save these settings or click **Cancel** to refresh the screen without saving the changes.



Auto Attendant Voice Prompts

To record Auto Attendant voice prompts:

1. Click **System Settings**, then **Auto Attendant**.
2. On an Auto Attendant **Day Menu** or **Night Menu** page, click [Play/Record](#). The **Auto Attendant Voice Prompts** page appears.

Auto Attendant Voice Prompts

1. Select the extension to be used for recording:
2. When you are ready to start recording, click the "Start Recording" button. The selected extension will begin ringing.
3. Answer the call to begin the prompt recording session. Follow the voice instructions:
 - o To record a new prompt, press 1.
 - o Press 5 when you are done.
 - o To play the recorded prompt, press 2.
4. After you've completed recording the prompt, hang up.
5. Click the "Save Recording" button to save the new voice prompt.
6. To cancel the recording at any time, hang up and click the "Cancel" button.

[Start Recording](#) [Save Recording](#) [Cancel](#)

3. Follow the instructions on the web page to record the voice prompt.

Here is an example of a script for a Day menu:

"This is the Widget Company. We are open from 9 AM to 5 PM, Monday to Friday. If you know your party's extension, dial it now. To reach someone by spelling their name, followed by the pound sign, press 1. For Sales, press 3. For Customer Service, press 4. To replay this message, press 5. To speak with the operator, press 0." The Auto Attendant menu that you configure might look like the menu shown in Figure 14.

4. Click [Save Recording](#). You return to the Auto Attendant Menu Editor so that you can add actions to the menu. If you press [Save Recording](#) before you hang up, the recording is not saved.

OR

Click [Cancel](#) to return to the previous screen without saving the changes.



Day Menu

Voice Prompt: [Play/Record](#)

Enable Direct Dial: On Off

Enable Operator: On Off

Press 1: Auto Attendant Direct	Press 2: None
Press 3: Ext. 200	Press 4: Ext. 201
Press 5: Replay	Press 6: None
Press 7: None	Press 8: None
Press 9: None	Press 0: None
Press *: None	Press #: None

[Apply](#) [Cancel](#)

Figure 14. Day Menu Example



Name Recording for the Auto Attendant Directory

The administrator and individual users can create name recordings at the Desksets. When callers access the Directory through the Auto Attendant, the name recording plays to confirm the selection.

In order to create a fully functional Auto Attendant Directory, ensure that you also enter a name for every extension. See [“Extension Basic Settings” on page 47](#).

To create consistent Auto Attendant name recordings for incoming callers, ask Deskset users to state their name slowly, clearly, and at a reasonable volume. You may also recommend that users state both their name and extension number to assist incoming callers further.



You are limited to a 10-second recording. Recording stops automatically if you exceed the limit.

To record, play, or delete a personal name:

1. Press **MENU**, then **2**, then **1**, and then **2** to display the **Name Recording** menu. The **Play** and **Delete** soft keys do not appear if the name has not already been recorded.

Play/Rec: Personal Name	
Duration: 2s	Max: 10s
<input type="text"/>	
Play	Record Delete

2. Pick up the handset and press **Record**. The **Record** key changes to **Stop**.
3. Press **Stop** when finished.
4. Press **Play** to review the recorded name or press **Delete** to delete the greeting.
5. Press **CANCEL** to return to the **Message Greetings** menu.



Configuring Hold Settings

You can create a hold announcement for callers to hear when they are on hold. When the hold announcement is disabled, callers on hold hear two short beeps every 10 seconds.



The hold announcement does not play when placing a conference on hold, or if one of the parties drops out of the conference.

To configure Hold Settings:

1. In the navigation menu at left, click **Hold Settings**. The **Hold Settings** page appears.

Hold Settings

Hold Announcement

Hold Announcement: Enable Disable

Delay Before Playing: seconds

Delay Before Repeating: seconds

Hold Announcement Recording:

2. If you want to use a hold announcement, click **Enable**.
3. Enter the amount of delay before the announcement first plays to a caller on hold.
4. Enter the delay before the announcement repeats.
5. To play, record, or delete the announcement, click .
6. Follow the instructions on the **Hold Announcement** page to record a prompt.

OR

Click to delete the announcement.



Hold Announcement

Record Hold Announcement

1. Select the extension to be used for recording:

Select Extension ▾

2. When you are ready to start recording, click the "Start Recording" button. The selected extension will begin ringing.
3. Answer the call to begin the prompt recording session. Follow the voice instructions:
 - To record a new prompt, press 1.
 - Press 5 when you are done.
 - To play the recorded prompt, press 2.
4. After you've completed recording the prompt, hang up.
5. Click the "Save Recording" button to save the new voice prompt.
6. To cancel the recording at any time, hang up and click the "Cancel" button.

Start Recording

Save Recording

Cancel

Delete existing Hold Announcement

To delete the existing Hold Announcement and use the default Hold tones, press the Delete Recording button.

Delete Recording

7. After hanging up and clicking **Save Recording**, you return to the **Hold Settings** page. If you press **Save Recording** before you hang up, the recording is not saved.

OR

Click **Cancel** to return to the **Hold Settings** page without saving the changes.

8. On the **Hold Settings** page, click **Apply** to save these settings or click **Cancel** to return to the previous page without saving the changes.



Configuring Phone Line CFNA

On the **Phone Line CFNA** (Call Forward–No Answer) page, you can specify how to forward calls that do not get answered. You can set a CFNA destination for each telephone line connected to the Gateway.

If your telephone lines are part of a hunt group (a telephone company feature that allows calls to a busy phone number to roll over to the next available telephone line), then we recommend setting the same CFNA destination for all lines in that group.

To configure CFNA settings:

1. In the navigation menu at left, click **Phone Line CFNA**. The **Phone Line Call Forward No Answer** page appears.

Phone Line Call Forward No Answer

Current Line Configuration:

Line	Line Name	CFNA Destination
PSTN GW-1 Line 1	Line 1	Voicemail (201)
PSTN GW-1 Line 2	Line 2	Auto Attendant
PSTN GW-1 Line 3		Off
PSTN GW-1 Line 4		Off

Select a Line to Edit: Select a Line ▼

Call Forward No Answer Settings:

Target: Off

Voicemail: Select a Mailbox ▼

Extension: Select an Extension ▼

Outside Phone Number:

Auto Attendant

Seconds before Forwarding: 15 Seconds ▼

Apply
Cancel

2. Select a line. The lines are listed along with their names. See [“Line Naming” on page 46](#).
3. Select a Call Forward–No Answer **Target** for the line.
 - **Off**. The line rings until the call is answered or the caller hangs up.
 - **Voicemail**. The unanswered call is directed to the selected extension’s voicemail.



- **Extension.** The unanswered call is directed to the selected extension. Note that if the call is not answered at the extension, then the call is forwarded again according to the extension's Intercom CFNA setting.
 - **Outside Phone Number.** After selecting this, enter a telephone number.
 - **Auto Attendant.** The unanswered call is directed to the currently selected Auto Attendant menu.
4. Select the **Seconds before Forwarding**, from 5 to 45 seconds.
 5. Click to save the setting. The new setting appears in the **CFNA Destination** column at top. To configure another line, return to step 2.



Creating, Editing and Deleting Paging Zones

Use paging zones to set up extensions that can be paged as a group. For example, all extensions in the sales department could be defined as a paging zone. Any Deskset user can initiate a page to all extensions or only to the members of a paging zone. You can configure up to six paging zones, each with one or more members. You can place every extension in a paging zone.

To create a paging zone:

1. In the navigation menu at left, click **Paging Zones**. The **Paging Zones Summary** page appears.

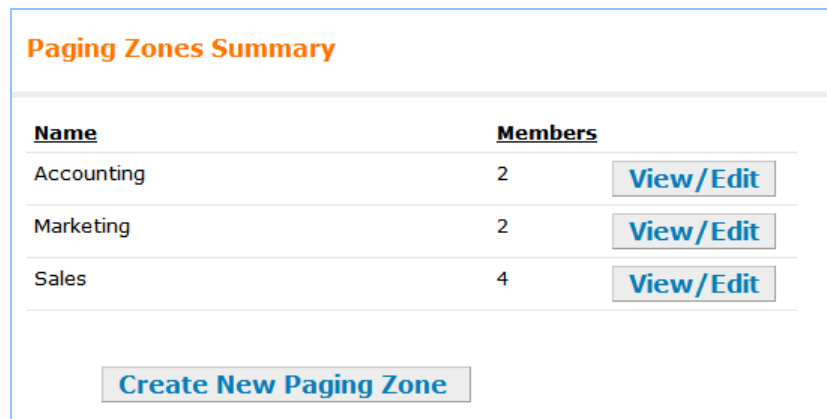

Name	Members	
Accounting	2	View/Edit
Marketing	2	View/Edit
Sales	4	View/Edit

[Create New Paging Zone](#)

2. Click [Create New Paging Zone](#) to create a new paging zone. The **Create Paging Zone** page appears.

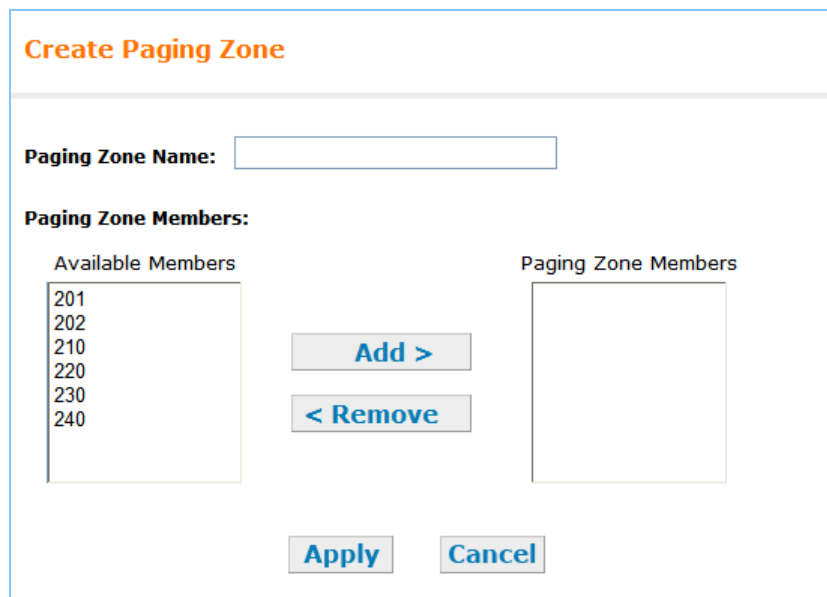

Create Paging Zone

Paging Zone Name:

Paging Zone Members:

Available Members		Paging Zone Members
201 202 210 220 230 240	Add > < Remove	

[Apply](#) [Cancel](#)

3. Enter the **Paging Zone Name**.



- Select one or more extensions that you want in this paging zone from the **Available Members** list and click .

OR

Select one or more extensions to remove from this paging zone from the **Paging Zone Members** list and click .

- Click to save these settings or click to return to the previous page without saving the changes.

The new paging zone appears on each Deskset when the user views the **Paging Zones** menu.

To edit or delete a paging zone:

- On the **Paging Zones Summary** page, click the button for the paging zone you want to edit or delete. The **Edit Paging Zone** page appears.

- Select one or more extensions that you want in this paging zone from the **Available Members** list and click .

OR

Select one or more extensions to remove from this paging zone from the **Paging Zone Members** list and click .

OR

Click to delete this paging zone.

- Click to save these settings or click to return to the previous page without saving the changes.



System Directory

Create a list of up to 100 phone numbers (referred to as the **System list** on the Deskset) that people at your business frequently call. These numbers are available to all of the extensions.

To set up the System Directory:

1. In the navigation menu at left, click **System Directory**. The **System Directory List** page appears.

System Directory List		
<input type="button" value="Add New Entry"/>		
<input type="button" value="Delete Selected Entries"/>		<input type="button" value="Sort By Last Name"/>
<input type="checkbox"/>	ABC Accountants	503-555-0194 [Edit]
<input type="checkbox"/>	Angela Martin	732-555-7318 [Edit]
<input type="checkbox"/>	Charlie Johnson	888-883-2445 [Edit]

2. Click .
3. Complete the **Add System Directory List Entry** page with the information indicated.

Add System Directory List Entry

First Name:

Last Name:

Phone Number:

4. Click to save the entry. The System Directory menu appears with the entry added.

OR

Click to return to the previous page without saving the changes.



To edit an entry, click **[Edit]** to the right of the entry. The **Edit System Directory List Entry** page appears with the fields populated with the entry to be edited.



Line Naming

You can name the lines connected to the Gateway for easier identification.

To name a line:

1. In the navigation menu at left, click **Line Naming**. The **Line Naming** page appears.

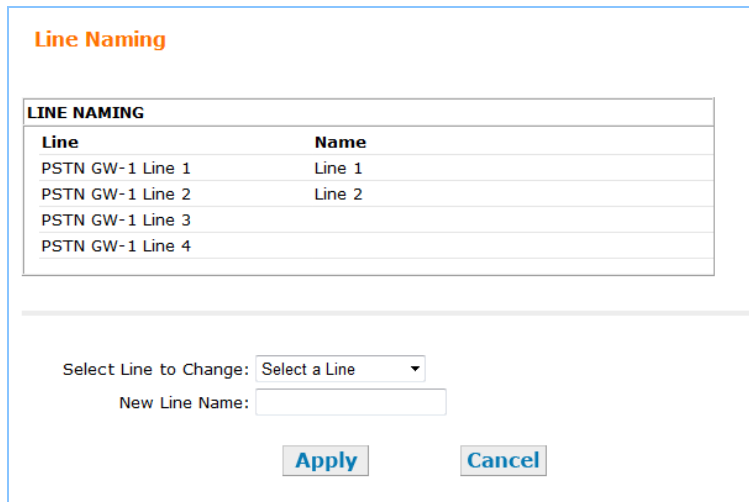

Line	Name
PSTN GW-1 Line 1	Line 1
PSTN GW-1 Line 2	Line 2
PSTN GW-1 Line 3	
PSTN GW-1 Line 4	

Select Line to Change:

New Line Name:

2. In the **Select Line to Change** list, select a line. All Gateway lines are listed.
3. Enter the **New Line Name** using up to 16 characters.
4. Click to save the entry. The new name appears in the Line Naming summary table.



Extension Settings

Use the WebUI to configure the following Extension Settings:

- [“Extension Basic Settings” on page 47](#)
- [“Personal Directory” on page 50](#)
- [“Deskset Programmable Feature Keys \(PFKs\)” on page 52.](#)



Ensure that the extension you are configuring is not in use, or the configuration changes may fail.

Extension Basic Settings

You can modify the settings for individual extensions from the **Extension Basic Settings** page.



Deskset users have different Extension Settings available when they log in to the WebUI. They are described in “Web Interface” of the SB35020 Deskset User’s Guide available from www.telephones.att.com/smb.

To set the Extension Basic Settings as the administrator:

1. In the navigation menu at left, click **Extension Settings**, then **Basic Settings**. The **Extension Basic Settings** page appears.

Extension Basic Settings

Select Extension:

Extension Name:

First Name:

Last Name:

Change Extension Number to:

Please make sure the extension is not in use before changing the extension number.

2. Select an extension from the **Select Extension** list to display the current settings for that extension.
3. Enter an **Extension Name** into the **First Name** and **Last Name** fields. Enter up to 16 characters for each. Be aware that with very long names, depending on the characters used, the entire name may not fit across the Deskset screen.

Extension Name displays the name for the current extension. This name is used on the Idle screen of the Deskset and in the Auto Attendant Directory. Callers spell the **Extension Name**, followed by the pound (#) sign, using their touch-tone phones when they search for extensions in the Auto Attendant Directory.



4. You can enter a new extension number in the range 100–999 into the **Change Extension Number to** box. The first digit of the extension number need not match the default extension number first digit.

**CAUTION**

Ensure that the extension is not in use and do not assign an extension number with the first digit of any extension that is the same as an Auto Attendant menu digit key value, as callers will be unable to dial that extension. Instead, they will be connected to that Auto Attendant menu action. See [“Configuring the Auto Attendant” on page 33](#).

**NOTE**

Desksets do not lose their assigned extensions even if a Deskset is disconnected and unplugged. If you want to remove a Deskset from the system, the Deskset must be deleted using the WebUI. (See [“Deleting Devices” on page 56](#).) This ensures that the extension number becomes available again.

5. You can select **Call Forward/Transfer to Outside Telephone Number** to enable or disable forwarding or transferring of calls to an external number. This function is enabled by default and uses two outside lines when calls are forwarded. Disabling this function prohibits the user from setting the **Call Forward All** target to **Phone #**.

Call Forward / Transfer to Outside Telephone Number: Off On

Intercom Call Forward No Answer Settings:

Target: Off

Voicemail:

Extension:

Outside Phone Number:

Seconds before Forwarding:

Automatic Off-hook Line Selection:

Intercom Auto Answer Settings:

Delay:

Set Password:

User Password:

6. Change the **Intercom Call Forward–No Answer Settings**:
 - a. Select the **Target** for unanswered calls:
 - **Off**. The extension rings until the call is answered or the caller hangs up. Conference room extensions typically have Call Forward–No Answer Settings set to **Off** and have their ringers set very low or off.
 - **Voicemail**.
 - **Extension**.
 - **Outside Phone Number**.



- b. Select the number of **Seconds before Forwarding**.



The Intercom Call Forward–No Answer settings apply to Intercom calls and external calls forwarded from a Phone Line Call Forward–No Answer setting (including calls routed to the extension by the Auto Attendant).

7. Set the **Automatic Off-hook Line Selection**. Users can select and make calls on any line assigned to their extension, but if you have a preferred line that you want the extension to seize when the user goes off hook, select it here.
8. Select the Intercom Auto Answer **Delay**. The user can set the Deskset to automatically answer Intercom calls after the delay. Without touching the Deskset, you can speak to and be heard by the person who called.

If Intercom Auto Answer is enabled on the Deskset, a **Disable** button appears, allowing you to disable the feature. The user can always enable or disable Intercom Auto Answer again.
9. Under **User Password**, create or change the Deskset password. The password must consist of up to 6 digits.
10. Click to save any changes or click to return to the previous page without saving the changes.



Personal Directory

The Personal Directory is only available at the extension for which it was created. Personal Directory entries can be created and managed by the administrator or by a Deskset user.

To manage the Personal Directory:

1. In the navigation menu at left, click **Extension Settings**, then **Personal Directory**. The **Directory List for Extension:** page appears.
2. Select the desired extension number from the list.

The Directory list appears. You can add, edit, delete, and sort the entries, as described below.

Directory List for Extension: Ext. 201		
<input type="checkbox"/>	ABC Accountants	1-503-555-0194 [Edit]
<input type="checkbox"/>	Angela Martin	1-732-555-7318 [Edit]
<input type="checkbox"/>	Davis Carterer	1-317-555-0129 [Edit]
<input type="checkbox"/>	Graham Bell	1-232-555-0176 [Edit]
<input type="checkbox"/>	Mary Williams	1-888-722-7702 [Edit]
<input type="checkbox"/>	Milford Taxi	1-604-555-0182 [Edit]

- To add a new entry, click . The **Add Personal Directory List Entry** page appears.

Add Personal Directory List Entry

First Name:

Last Name:

Phone Number:

- a. Complete the form with the information indicated.
- b. Click to save the entry. The **Directory List** page appears with the entry added.



- To edit an entry, click **[Edit]** to the right of the entry. The **Edit Personal Directory List Entry** page appears with the fields populated with the entry to be edited.

Edit Personal Directory List Entry

First Name:

Last Name:

Phone Number:

Click to save the entry. The **Directory List** page appears with the entry added.

- To sort entries by last name, click . The list updates and the button changes to .
- To delete **Directory List** entries:
 - a. Mark the entries to delete by selecting the check box to the left of each entry.
 - b. Click . The selected entries are removed.



Deskset Programmable Feature Keys (PFKs)

Use the **Programmable Feature Keys** page to set the PFKs on the Desksets in your Syn248 system. PFKs give users access to lines (Gateway lines and Intercom lines) and provide one-touch access to certain Deskset features.

To edit Programmable Feature Key assignments:

1. In the navigation menu at left, click **Extension Settings**, then **Feature Keys**.
2. Select the desired Deskset Extension from the **Select an Extension** list. The default PFK assignments appear.

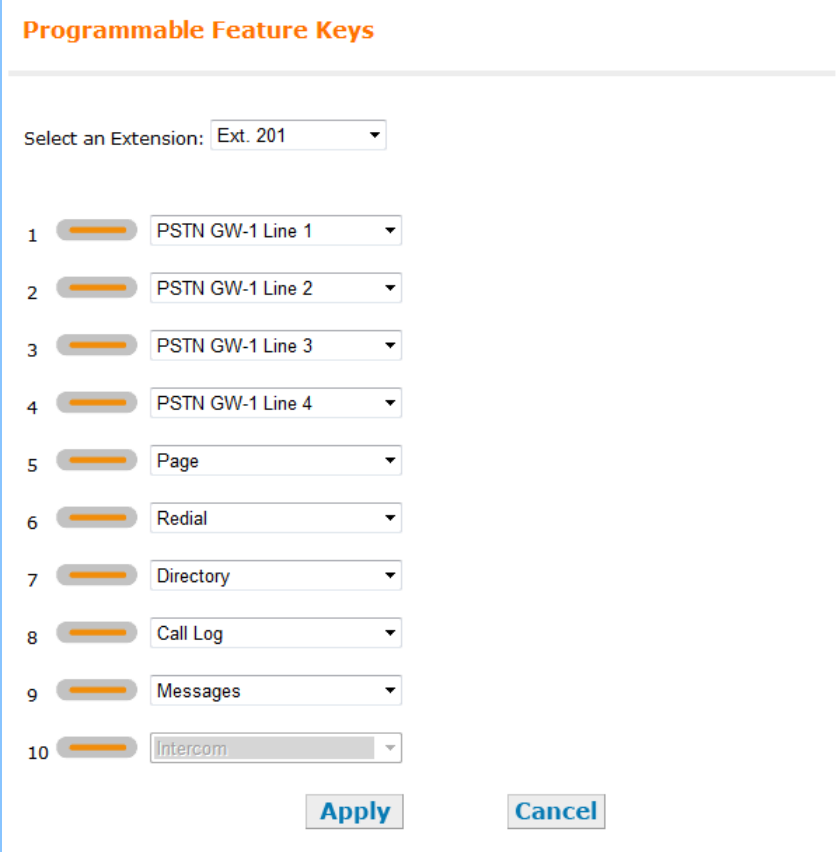

The screenshot shows the 'Programmable Feature Keys' configuration page. At the top, there is a title 'Programmable Feature Keys' in orange. Below the title is a dropdown menu labeled 'Select an Extension:' with 'Ext. 201' selected. Below this are ten numbered rows, each with a key indicator (a small orange bar) and a dropdown menu. The dropdown menus are: 1. PSTN GW-1 Line 1, 2. PSTN GW-1 Line 2, 3. PSTN GW-1 Line 3, 4. PSTN GW-1 Line 4, 5. Page, 6. Redial, 7. Directory, 8. Call Log, 9. Messages, and 10. Intercom. At the bottom of the page are two buttons: 'Apply' and 'Cancel'.

3. Reassign functions to each key. See [“Programmable Feature Keys” on page 53](#).
4. Click **Apply** to save the entries or click **Cancel** to refresh the page without saving the changes.



Programmable Feature Keys

Keys **1** to **4** are assigned to Gateway lines 1 to 4 by default. Key **10** is fixed as an **Intercom** key to enable internal, extension-to-extension calls.

You can assign the following features to the keys:

- Phone lines connected to the Gateway
- Call Log
- Directory
- Do Not Disturb
- Held Calls List
- Help
- Intercom
- Messages
- Page
- Quick Dial
- Redial



Clicking **Apply** after configuring PFKs causes the Deskset to reboot and drop any active calls. Before configuring PFKs, ensure that there are no calls in progress.

You can assign Phone Lines, **Intercom** and **Quick Dial** to multiple keys. Every other feature can be assigned only once. After one of these features has been assigned, it disappears from the list for the other PFKs.

If all 10 PFKs are assigned to **Intercom**, the Deskset cannot make or receive external calls.



Deskset Quick-Dial Keys

On the Deskset, Quick-Dial entries are only available if you have assigned PFKs as Quick-Dial keys. After assigning Quick-Dial keys, you or a Deskset user can assign phone numbers to the keys.

To edit Quick-Dial entries:

1. Log in, either as administrator or a user (enter an extension number and the user's password, if needed).
2. In the navigation menu at left, click **Extension Settings**, then **Feature Keys**.
3. If necessary, select the desired Deskset extension number from the **Select an Extension** list. When logging in as a user, you cannot select a different extension.
4. On the **Programmable Feature Keys** page, enter a name and number for every Quick-Dial entry you want to create. Any hyphens in phone numbers are ignored.

Programmable Feature Keys

Select an Extension: Ext. 201

Key	Status	Feature Key	Name	Number
1	On	PSTN GW-1 Line 1		
2	On	PSTN GW-1 Line 2		
3	On	Quick Dial	Angela Mart	203
4	On	Quick Dial	Davis Carter	13175550129
5	On	Page		
6	On	Redial		
7	On	Directory		
8	On	Call Log		
9	On	Messages		
10	Off	Intercom		

Apply **Cancel**

Enter **P** for a pause in the number.

5. Click **Apply** to save the entries or click **Cancel** to refresh the page without saving the changes.
6. To verify the entries, try a Quick Dial key on the Deskset, as shown in Figure 15.



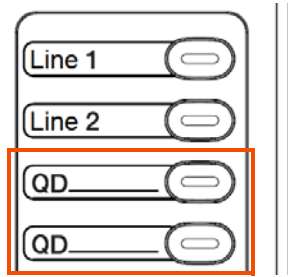

Figure 15. Quick-Dial Key Location

Device Management

Use the **Device Management** page to delete devices from the system and to change Deskset extension numbers. If you unplug a Deskset from the system, the extension remains in the system database until you use the **Device Management** page to delete the device. All local settings and personal information (Call Logs and Voicemail, for example) remain stored in the Deskset.

Device Management consist of:

- [“Deleting Devices” on page 56](#)
- [“Change an Extension Number” on page 57](#)
- [“Back Up and Restore Settings” on page 58](#)
- [“Updating Devices” on page 62](#)
- [“Device Log” on page 65.](#)

Deleting Devices

You can delete any device in the system from the **Device Management** page. Disconnect the device before deleting it from the system. If the device is not disconnected, an error message appears and you are not be able to delete it.

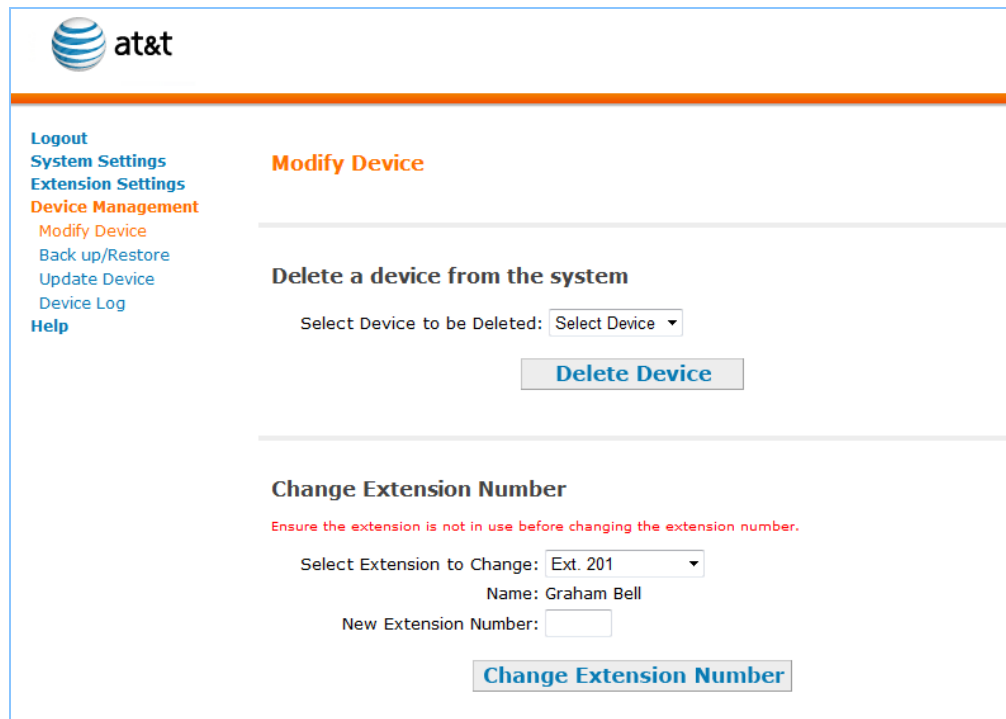

The screenshot shows the AT&T Device Management web interface. The top left corner features the AT&T logo. A navigation menu on the left includes links for Logout, System Settings, Extension Settings, Device Management (highlighted), Modify Device, Back up/Restore, Update Device, Device Log, and Help. The main content area is titled 'Modify Device' and contains two sections:

- Delete a device from the system:** This section includes a dropdown menu labeled 'Select Device to be Deleted:' with the text 'Select Device' and a downward arrow. Below the dropdown is a blue button labeled 'Delete Device'.
- Change Extension Number:** This section includes a red warning message: 'Ensure the extension is not in use before changing the extension number.' Below this is a dropdown menu labeled 'Select Extension to Change:' with the text 'Ext. 201' and a downward arrow. Underneath, the text 'Name: Graham Bell' is displayed. Below that is a text input field labeled 'New Extension Number:'. At the bottom of this section is a blue button labeled 'Change Extension Number'.



Deleting an Extension (Deskset)

If you unplug a Deskset from the system, such as when an employee leaves, it remains in the system database until you use the **Device Management** page to delete the device.

If the Auto Attendant menu programming has set a far-end key press to ring that extension or leave a message in its personal voice mailbox, that key assignment reverts to **None**.

If the operator extension is deleted, the lowest extension number is automatically assigned as operator.

When you delete a Deskset, only the extension number is removed from the system database—all local settings and personal information (Call Logs, Voicemail, etc.) remain stored in the Deskset. To erase all data on the Deskset (if, for example, the Deskset is being given to another user), press the **RESET** button on the Deskset for more than 5 seconds to return all settings to factory defaults.

Deleting a Gateway

When replacing a Gateway, delete the old Gateway first if you want the new Gateway to use the same line numbers (Lines 1 to 4, for example). If you do not delete the old Gateway after disconnecting it, then the new Gateway will be assigned the next available line numbers (Lines 5 to 8, for example). System settings other than specific line numbers are stored in all devices, so deleting devices does not erase these settings.

Change an Extension Number

You can change extension numbers. Ensure that the extension is not in use when you make the change.

To change a Deskset extension number:

1. On the **Modify Device** page, under **Change Extension Number**, select the desired extension.
2. Enter the **New Extension Number**.

Change Extension Number

Ensure the extension is not in use before changing the extension number.

Select Extension to Change: 

Name: Graham Bell

New Extension Number:

[Change Extension Number](#)

3. Click [Change Extension Number](#).



Back Up and Restore Settings

Back up individual Deskset settings and system settings so that they can be restored if the network or a Deskset loses its settings. You can also back up a Deskset to copy the settings to other Desksets.



Backup files are automatically saved on your computer using the following naming convention:

backup_[device]_[extension number]_[year]-[month]-[day]_[time].cfg.

The device will be either “ds” for a Deskset or “system” for a system backup:

The backup file for extension 208 that was created at 4:29 PM on October 26, 2010 would be named **backup_ds_208_2010-10-26_1629.cfg.**

The system backup file that was created at 4:35 PM on October 26, 2010 would be named **backup_system_2010-10-26_1635.cfg.**

If you are using Safari®, the backup file will be saved as a .tar file instead of a .cfg file. You will still be able to restore this file safely.

Back Up and Restore Extension Settings

Each extension has its own settings and must be backed up and restored individually.

The following items are backed up:

- Calls: New Messages, Redial, and Call Logs
- Messages and Lists: Voicemail Messages, Personal Directory, and Quick Dial
- Deskset Settings: Display, Sounds, and Preferred Audio mode
- User Settings: Greetings, Name Recording, and Intercom Auto Answer
- Admin Settings: CFNA, FWD/Trans Line, Programmable Feature Keys, and User Password.



CAUTION *Only back up one Deskset at a time. Only restore one Deskset at a time. If you back up an extension less than one minute after creating another backup for that extension, you may overwrite the earlier one, since the file names may be identical.*

To back up the Extension Settings:

1. In the navigation menu at left, click **Device Management**, then **Back up/Restore**. The **Back up/Restore Extension Settings** page appears.
2. Select the desired extension from the **Select Extension to Back up** list.



Back up/Restore Extension Settings

Back up Extension Settings

Select Extension to Back up:

3. Click .



NOTE

If the desired extension does not appear in the list, then you may need to reintroduce that extension. See [“Reintroducing a Deskset Into the System” on page 88](#).

4. Your web browser opens a window asking if you would like to save the backup file; click .

To restore the Extension Settings:

1. On the **Back up/Restore Extension Settings** page, choose the desired extension from the **Select Extension to Restore** list.



CAUTION

Ensure that there are no calls in progress or they will be dropped.

Back up/Restore Extension Settings

Back up Extension Settings

Select Extension to Back up:

Restore Extension Settings

Please make sure the extension is not in use. The deskset will reboot after restoration, so any call in progress will be dropped.

Select Extension to Restore:

Overwrite voicemail/call logs: Yes No

Restore Settings From File:

2. Select whether you want to overwrite Voicemail and Call Logs.



3. Enter the file name or click and select a file.

Make sure you select the correct file to restore. The restore file name includes your extension number and the date and time.

4. Click .

Deskset settings are restored and the Deskset restarts. You are then logged out of the WebUI.



If a PC is installed in series with the Deskset, restarting the Deskset causes the PC to lose its network connection briefly.

Back Up and Restore System Settings

The system settings are distributed over all the Desksets and Gateways. System settings are globally backed up once, and restored to the whole system at one time. The following items are backed up and restored:

- Auto Attendant user prompts
- Assigned Operator set
- Timer for Forwarded and Transferred Outside Calls
- System Time settings
- Paging Zones
- Hold Announcement
- System Directory
- Line Naming

The following items are not backed up:

- The extension list
- The assignment of line numbers to the lines.



To back up the System Settings:

1. In the navigation menu at left, click **Device Management**, then **Back up/Restore**, then **System Settings**. The **Back up/Restore System Settings** page appears.

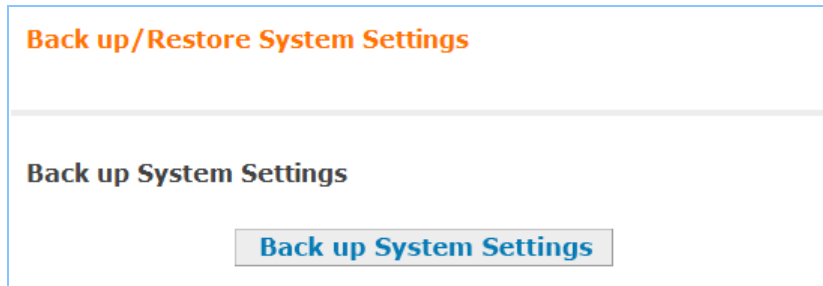

2. Click **Back up System Settings**.
 - Your web browser opens a window asking you if you would like to save the backup file. Click **Save**.
 - Save the file to a location on your computer so that you can restore your settings later.

To restore the System Settings:

1. If practical, unplug the telephone lines from each Gateway while restoration is in progress to ensure you do not receive any incoming calls.

If you have two Gateways, and you log into one of the Gateways using the Gateway's IP address, you do not need to unplug all of the other outside lines from the other Gateway; just the one that you are logged into.

2. In the navigation menu at left, click **Device Management**, then **Back up/Restore**, then **System Settings**. The **Back up/Restore System Settings** page appears.

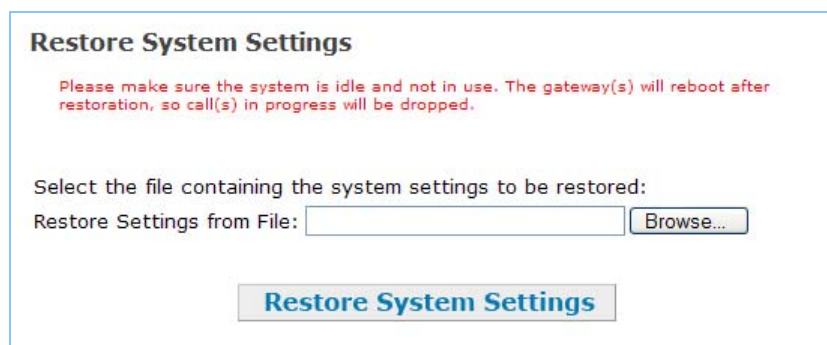

3. Enter the name for the restore file or click **Browse...** and select a system file. Make sure you select the correct file to restore. The restore file name includes "system" and the date and time.
4. Click **Restore System Settings**. The system settings are restored and the Gateway restarts. You are then logged out of the WebUI.



Updating Devices

New software versions improve system functionality. All Gateways and all Desksets should be running the same software version number.

You can update all devices with one command, or you can update the Syn248 devices individually.

We recommend automatic device software upgrades for installations with Internet access. This allows your system to obtain the latest upgrade from our server. Automatic upgrades may not work if your network's firewall prohibits connection to the AT&T servers, or if you do not have DNS services provided by your ISP. If you need to manually initiate updates, see ["To update all devices to the latest software version:" on page 63](#). If Internet access is not available, see ["To update a single device to the latest software version:" on page 64](#).

**NOTE**

Sometimes devices with different versions of software cannot detect each other in the WebUI. Some versions of Syn248 software codes are incompatible, so that when you use one device's IP address for logging into the WebUI, only the devices with compatible code versions appear in the device lists. For this reason, if you are updating devices individually, wait until all other devices are updated before updating the software version of the device whose IP address was used for logging into the WebUI. When an updated device restarts with new software, it may disappear from the device list.

**NOTE**

When you add a new "out of box" device to the system, the device automatically gets new software from the network and then restarts. Allow this process to complete before using the device. The process may take anywhere between 30 seconds to a few minutes, depending on server speed.

**CAUTION**

Although unlikely, some types of software upgrades could interfere with system settings and directories. Therefore, back up the system settings and Deskset settings before updating the system software. If you receive automatic updates, back up each device after each configuration change. See ["Back Up and Restore Settings" on page 58](#).

The device restarts after a software upgrade. Ensure that there are no calls in progress or they will be dropped.

**NOTE**

If a PC is installed in series with the Deskset, restarting the Deskset causes the PC to lose its network connection briefly.



To update all devices to the latest software version:

1. In the navigation menu at left, click **Device Management**, then **Update Device**. The **Update Device** page appears.

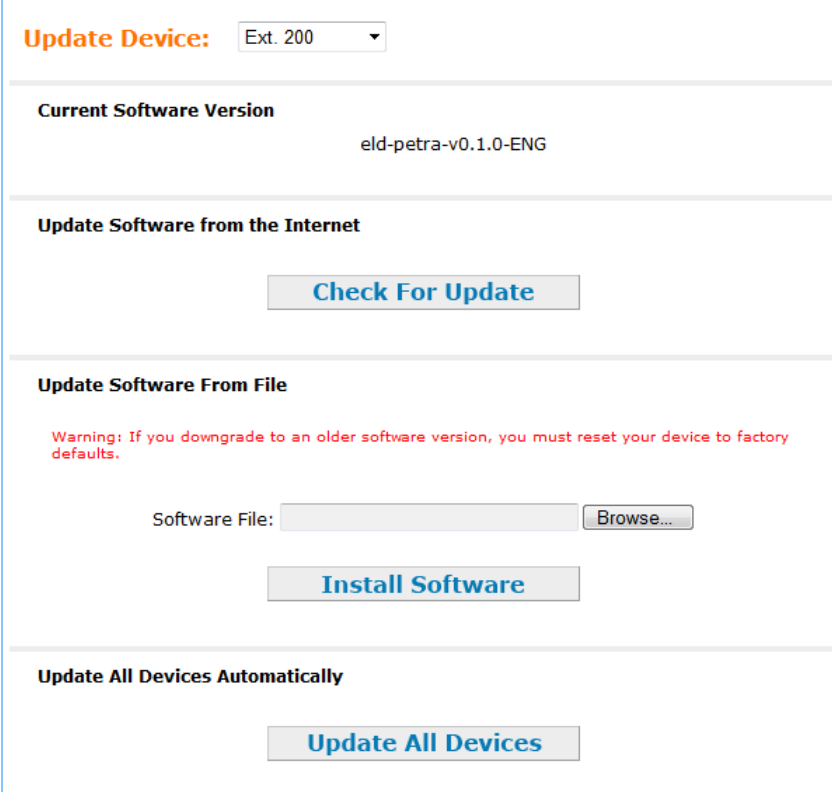

Update Device: Ext. 200

Current Software Version
eld-petra-v0.1.0-ENG

Update Software from the Internet

[Check For Update](#)

Update Software From File

Warning: If you downgrade to an older software version, you must reset your device to factory defaults.

Software File: [Browse...](#)

[Install Software](#)

Update All Devices Automatically

[Update All Devices](#)

2. At the bottom of the page, click [Update All Devices](#). The system looks on the Internet for the latest software and systematically updates and then restarts each device. All calls are dropped.

A caution appears to remind you that all devices will be restarted as each is updated.



Any Desksets registered with the system but disconnected at the time of the update will be updated as soon as they are reconnected to the system.

After you have started an update using [Update All Devices](#), attempts to manually update a device through the device itself or the WebUI may be interrupted by the system software update in progress.





Using [Update All Devices](#) requires a minimum Internet download bandwidth of 1 Mbps and an Internet router that can handle the same number of total simultaneous connections as the number of Syn248 devices. Refer to your router specification. Performing an update without meeting the minimum requirement may cause some or all devices not to update correctly. See [“System Upgrade” on page 99](#).

The total time to update all the devices varies. The update time depends on Internet connection speed, the number of connections to the server, and the number of devices in the system. AT&T recommends conducting system updates overnight to reduce the impact on Deskset users.

If the Update All Devices process does not work, you can upgrade a Deskset or Gateway individually.

To update a single device to the latest software version:

1. In the navigation menu at left, click **Device Management**, then **Update Device**.
2. In the **Update Device** list, select a Gateway or Deskset to update.

The Current Software Version for that device appears.



You can only update one device at a time. Only the selected device is updated.

3. Click [Check For Update](#).

If there is an update available on the Internet, the message “There is new software available” appears. Click [Install Update](#). The specified device restarts.

OR

In the **Update Software From File** section of the page, enter a file name or click [Browse...](#) to select a previously acquired upgrade file. Once selected, click [Install Software](#). The specified device restarts.

4. After the device restarts, check the software version number at the device to confirm that the upgrade was successful.

On a Deskset, press **MENU**, then **4**. Check the **Software Ver.**

On a Gateway, press **SELECT**, **SELECT** and **DOWN**. Check the **SW Ver.**



If the device is sluggish or unresponsive during the upgrade process, see [“A Syn248 device becomes sluggish or unresponsive during or immediately after software upgrade.” on page 99](#).

When an updated device restarts with the new software, it may disappear from the device list if its software version is incompatible with the device whose IP address was used for logging into the WebUI.



Device Log

If you have trouble with your system and you contact the installer or customer service, they may need the device log for troubleshooting purposes. You can generate a device log on the **Device Log** page.

You can also configure a device log prior to generating the log. Your installer or Product Support specialist may want to see specific information in the device log. If so, you must configure the device log using a configuration file that your Syn248 support person provides.

**NOTE**

For customer service, repair, replacement, or warranty service, and all questions about this product, visit our web site at www.telephones.att.com/smb or call **1 (888) 386-2006**. In Canada, call **1 (888) 469-2005**.

To generate the Device Log:

1. In the navigation menu at left, click **Device Management**, then **Device Log**. The **Device Log** page appears.

A screenshot of a web interface for generating a device log. At the top, it says "Device Log:" followed by a dropdown menu showing "Ext. 201". Below this is a section titled "Save Device Log" with a horizontal line above it. The text in this section reads: "The device log contains detailed device events and current device configuration information. To generate a detailed device log, select the device then press the 'Save Device Log' button. A device log file will be saved onto your computer which can be used by your installer or Product Support to assist in troubleshooting." At the bottom of this section is a button labeled "Save Device Log".

2. In the **Device Log** list, select the desired device and click **Save Device Log**. If you select a Gateway, Line Calibration Data and Configuration tables also appear. For more information about Line Calibration, see ["Resolving Audio Echoes" on page 87](#) and ["Line Calibration Configuration" on page 67](#).
3. It takes a minute for the file to generate. A pop-up box then asks you where to save the file on your computer.
4. After the download is complete you should provide the file to the installer or customer service.



To configure the Device Log:

1. In the navigation menu at left, click **Device Management**, then **Device Log**.
2. In the **Device Log** list, select the desired device.
3. Under **Configure Device Log**, click **Browse...** and select the Device Log Configuration file.

Configure Device Log

The type of information sent to the device log is configurable by uploading a file containing the specific types of messages required. Please ask your installer or Product Support specialist to assist you.

Device Log Configuration File:

4. Click **Configure Device Log**. After configuration is complete, you can proceed with generating the Device Log, as described on page 65.



Line Calibration Configuration

If your system uses Centrex lines, you must enter an outbound line prefix or code in order for line calibration to take place. You should perform this procedure before connecting the lines to the Gateway. Consult your Centrex line provider for the correct code to enter.

To enter Centrex line access codes:

1. In the navigation menu at left, click **Device Management**, then **Device Log**.
2. Select the Gateway from the **Device Log** drop-down list. **Line Calibration Data** and **Line Calibration Configuration** appear.

Line Calibration Data

Port	VRMS	Loss	Index	Profile	RX Offset	TX Offset
1	1087	22.5	5	0	0	0
2	1231	21.4	5	0	0	0
3	954	23.6	6	0	0	0
4	5402	8.5	0	1	0	0

Line Calibration Configuration

Port	Line Access Code
1	<input type="text"/>
2	<input type="text"/>
3	<input type="text"/>
4	<input type="text"/>

[Save Configuration](#)

3. Enter the Line Access Code for each line.
4. Click **Save Configuration**.

You can now connect the physical lines to the Gateway.



Help

To display the Help menu:

1. In the navigation menu at left, click **Help**.

A PDF Help file opens.

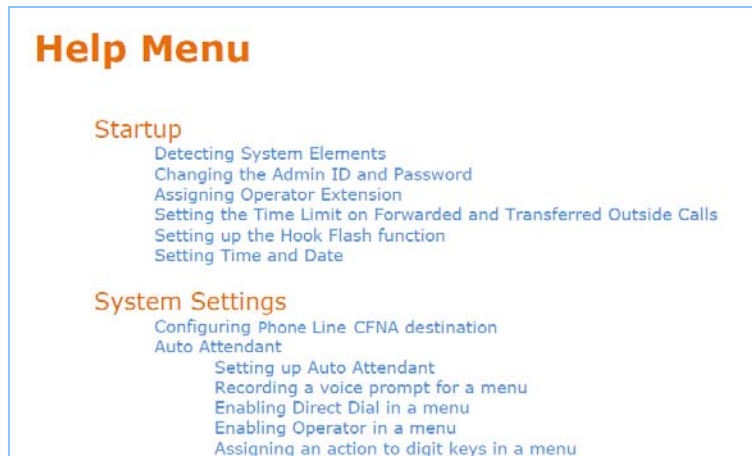

2. To view a topic, click the link for that topic. The page for that topic appears.

Detecting System Elements

To initiate a search of all system components:

1. Click **System Settings**, then **System Information**.
2. Click "Detailed Site Information" then wait while the system gathers the requested information.

The number of Desksets and Gateways will be listed, including their assigned extension number, IP address, software version, and connected status.

Note that this information will not be refreshed until you click "Detailed Site Information" once more.



Product Registration

In order to keep your system up to date with the latest upgrades and ensure timely warranty support, it is extremely important to register your system. To register a device, you need its MAC address.

To find a Deskset MAC address:

- Press **MENU**, then press **4**. Note the **MAC Address** line.

Deskset Information ▼▲	
MAC Add:	00:11:A0:19:FB:0D
Serial No:	MS00000022
Boot Ver:	2.7.0

To find a Gateway MAC address:

- Press **SELECT**, **DOWN**, **SELECT**, and then press **DOWN** until **MAC Address** appears.

Network Status ▲▼	
MAC Address:	00:11:A0:09:96:CC

To register your Syn248 system:

1. Open a new browser tab and navigate to the product registration web site <http://smbtelephones.att.com/registration>
2. Select your products, then complete the form.
3. When the form is complete, click [Register Product](#).



CHAPTER

3

DEVICE CONFIGURATION

This chapter shows you how to configure the Syn248 system using the device configuration menus. Most of these functions are duplicated in the WebUI, but if you need to assign static IP addresses, they must be set at each device. You can only directly reset a device from the device, although some functions in the WebUI include device resets.

This chapter covers:

- [“SB35010 Gateway Features” on page 71](#)
- [“Gateway Front Panel Interface” on page 73](#)
- [“Resetting Devices” on page 77](#)
- [“Deskset Admin Settings” on page 78.](#)



SB35010 Gateway Features

Figure 16 illustrates the Gateway features and connections.

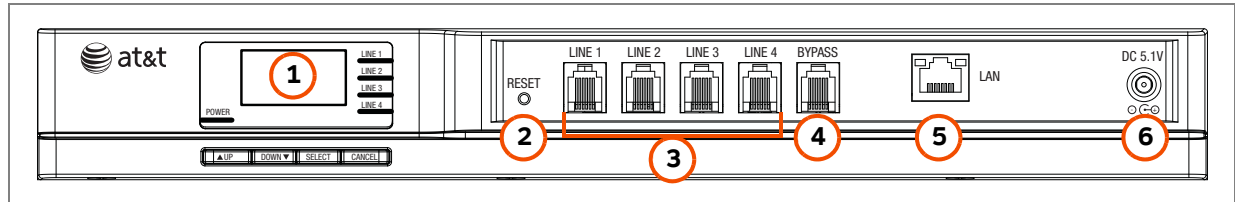

Figure 16. Gateway Features and Connections

1. Display	Provides system and network status, device information, and configuration data. See “Gateway Front Panel Interface” on page 73 .
2. Reset	Restarts the Gateway when pressed momentarily. Restores factory defaults when pressed and held for more than five seconds with the LAN cable disconnected.
3. PSTN Line Ports 1–4	Traditional 2-conductor wiring (FXO—Foreign Exchange Office Ports).
4. Bypass Port	Traditional analog POTS (Plain Old Telephone Service) that is available during an AC power outage. When the Gateway power fails, calls on Line 4 are routed to the bypass line.
5. RJ-45 Ethernet Network Port	10Base-T/100Base-Tx with Auto MDI/MDI-X switching.
6. DC 5.1V Power-Supply Jack	



Figure 17 and Table 2 provide an illustration and description of the Gateway front panel.

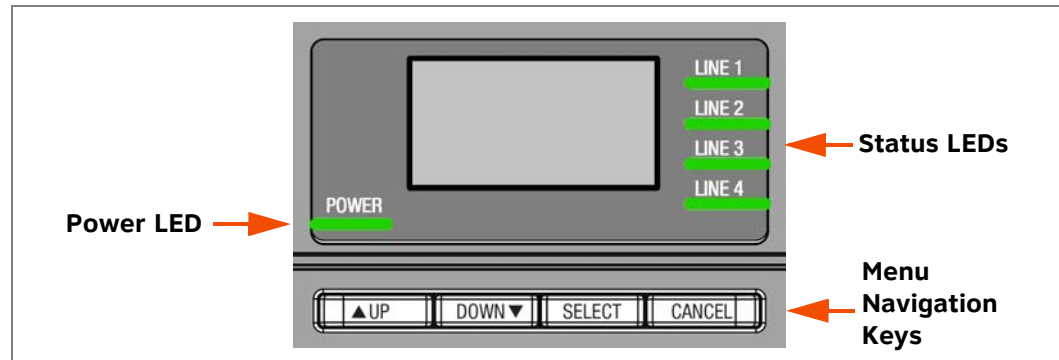

Figure 17. Gateway Front Panel

Table 2. Gateway Front Panel Keys and LEDs

Key	Used To:	LED	Description
<input type="button" value="▲UP"/> <input type="button" value="DOWN▼"/>	Navigate through the menus, and to increase/decrease editable fields. Highlight the previous or next item in the list.	LINE 1 LINE 2 LINE 3 LINE 4	Line-status LEDs indicate the status for each PSTN line. Indications include: Off —Connected. Red (steady)—Disconnected. Green (steady)—In use. Green (flashing)—Ringing. Line-status LEDs flash red after lines are connected (while matching line impedance).
<input type="button" value="SELECT"/>	Display the Main menu when in idle mode or while in network detection mode; save current setting and return to previous menu.		
<input type="button" value="CANCEL"/>	Terminate current operation without saving new settings and to return to the previous menu.	POWER	Off —No power to the device. Green —Power is present.



Gateway Front Panel Interface

You can access basic information and perform some configuration tasks using the Gateway's front panel. Most of these tasks are easier to do using the WebUI. See ["Logging in to the WebUI" on page 27](#).

The Gateway displays the Idle screen after completing the power-up sequence. Use the Gateway Main menu to perform some system operations.

To access the Gateway Main menu from the Idle screen, as shown in Figure 18, press the **SELECT** key.

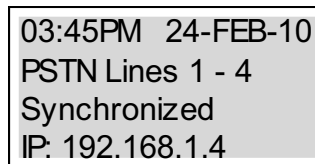

Figure 18. Gateway Idle Screen

From the Main menu you can access **Device Information**, **Network Status**, and the **Configuration** menu.

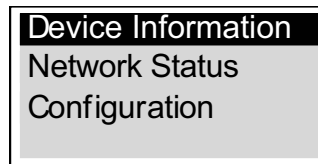

Figure 19. Gateway Menu Screens

Press the **DOWN** key to highlight an entry, then press **SELECT** to see information about your Gateway or your Network.

On the **Device Information** screen, you can view:

- Model #
- Serial #
- Boot Version
- Software Version
- Firmware Version.

On the **Network Status** screen, you can view:

- IP Address
- Subnet Mask
- Default Gateway
- DNS Server x
- MAC Address
- Network Port
- Local Address.

Select **Configuration** to view or modify some Gateway settings. See ["Gateway Configuration" on page 74](#).

Press **CANCEL** to return to the Main Menu.



Gateway Configuration

Press **UP** or **DOWN** in the Gateway Main menu until **Configuration** is highlighted, as shown in Figure 20, and press **SELECT** to display the Configuration menu. The current setting is indicated with **[x]**.

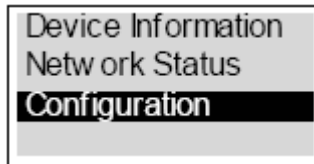

Figure 20. Gateway Configuration

Configuration — Current Gateway settings.

- **Auto IP** — Is set automatically.
- **Static IP** — You can change the static IP only from the Gateway. See your network administrator if you require details regarding IP assignments.
- **Restore Defaults** — Highlight **Restore Defaults** and press and hold **SELECT** for two seconds when prompted to restore the Gateway to factory defaults.
- **Upgrade Software** — Highlight **Upgrade Software** and press **SELECT**. If new software is available, you are prompted to press **SELECT** again to accept the upgrade. You can use this interface or the WebUI to upgrade software.



Upgrade Gateway Software

If you have system settings that you want to retain, back up the settings before upgrading the system software.

To upgrade the Gateway software to the latest version:

1. Press **UP** or **DOWN** in the Gateway Main menu until **Configuration** is highlighted and press **SELECT** to display the Configuration menu.
2. Press **DOWN** to highlight **Upgrade Software** and press **SELECT** to initiate the software upgrade process. The device initiates a link to the Syn248 Software Updates web site host and any new software.

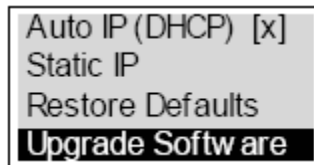

- If a host cannot be found or the server name cannot be resolved, **Timeout** or **Host Not Found** appears. Upgrade the software from the PC, which can offer more information about connection issues.

If the host is found, but there is no new software available, then the **No New Version** message appears.



NOTE

If the device is sluggish or unresponsive during the upgrade process, see [“A Syn248 device becomes sluggish or unresponsive during or immediately after software upgrade.”](#) on page 99.

3. If new software is available, you are prompted to initiate the upgrade by pressing **SELECT**, or abort by pressing **CANCEL**.

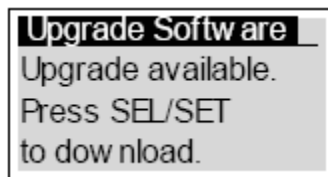

Once the downloading starts, the display indicates the progress as shown by the percentage indicator.

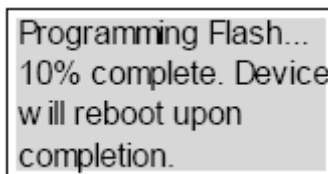

- If the upgrade process is interrupted by removing the server connection, no restart occurs. The Gateway remains on the xx% complete screen, until an action is taken at that Gateway. The process does not resume even after the server connection is reestablished.



- Pressing **CANCEL** during the programming process terminates the download midstream and returns you to the Configuration menu. The previous software version remains in effect.
 - When the upgrade is complete, the screen briefly displays **100% complete**, then **0% complete** for few seconds, before restarting the Gateway.
4. Press **CANCEL** repeatedly until you return to the Gateway Main menu.



Resetting Devices

You may need to manually restart a device or return a device to factory defaults (see [“Appendix D: Default Settings” on page 106](#)). To reset a device, press the **RESET** button shown in Figure 21 and [Figure 22 on page 77](#) by inserting a pen or paper clip into the hole and applying pressure to the button.

If the device does not respond or fails to synchronize with the system, the device should be restarted. To restart the device without losing any custom settings, press the **RESET** button for less than five seconds. You can get the same result by disconnecting and reconnecting power to the device.

To completely reset the device to factory defaults, unplug the LAN cable from the device and press the **RESET** button for more than five seconds. You might do this if the device is not synchronized or you want to reset the IP address settings to Auto (DHCP). Any static IP configurations are lost.

When resetting a Deskset to factory defaults, the User Settings, Personal directory, Voicemail messages, Call Log, and the Redial list are all deleted. You can use this complete reset when assigning Desksets to new users. If you do not disconnect the LAN cable before pressing the **RESET** button, the extension number is retained. During the reset, a PC connected to the Deskset PC port momentarily loses network connectivity.



NOTE

To reset the entire system to factory defaults and completely clear the system of all settings (Auto Attendant, hold message, and System Directory) and Voicemail messages, unplug the LAN cables from all devices and press the **RESET** button for more than five seconds on each device. Then reconnect all devices to the LAN.

If there is one Gateway in the system, but there are still Desksets connected, then only the voice prompts and hold messages are deleted; the rest of the Auto Attendant settings are maintained on the Desksets. If there is another Gateway, the other Gateway maintains all system configuration settings.



NOTE

If you have already set up the system, back up the Deskset and system settings before resetting the device to factory defaults. See [“Back Up and Restore Settings” on page 58](#).

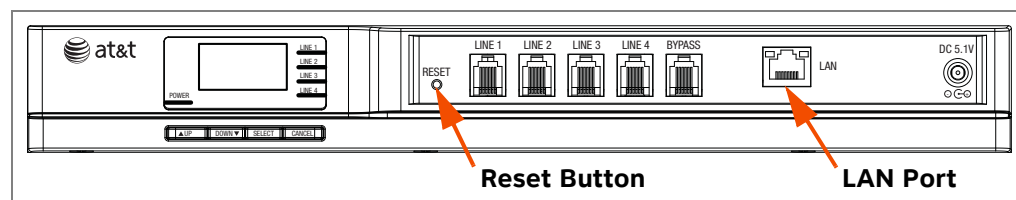

Figure 21. Gateway Reset Button

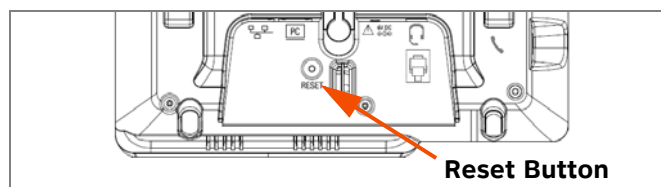

Figure 22. Deskset Reset Button



Deskset Admin Settings

You can use the Deskset Admin Settings to set up the system features described in Table 3. The WebUI also provides an interface for setting up your system. See [“Logging in to the WebUI” on page 27](#).

To display the Admin Settings menu:

1. On the Deskset, press **MENU** then **3**.
2. Enter the Admin password, and press **SELECT**.

The Admin Settings screen appears as shown in Figure 23.

The default Admin password is **12345**. To change this password, see [“Changing the System Basic Settings” on page 30](#).

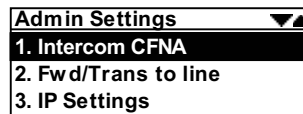

Figure 23. Admin Settings Screen

The Admin Settings menu contains the items listed in Table 3.

Table 3. Admin Settings Menu

Menu Item	See...
Intercom CFNA	page 79
Fwd/Trans to line	page 80
IP Settings	page 80
Reset User Password	page 82
Software Upgrade	page 82
Set Time and Date	page 83



Setting Intercom Call Forward–No Answer

Intercom Call Forward–No Answer is an administrator setting to handle unanswered Intercom calls for each Deskset, including outside calls that have been routed to a Deskset by a Phone Line Call Forward–No Answer setting. See [“Configuring Phone Line CFNA” on page 41](#).

By default, Intercom calls are forwarded to Voicemail after they ring for 15 seconds. You can change the target destination to another extension or to an outside phone number, or you can turn off call forwarding when there is no answer. You can adjust the delay from 5 to 45 seconds.



NOTE

Calls forwarded to outside lines use two telephone lines. You can limit the duration of calls forwarded to outside lines with the **Timer for Forwarded and Transferred Outside Calls** setting. See [“Changing the System Basic Settings” on page 30](#).

You can also disable **Fwd / Trans to Outside Line** individually for each extension. See [“Fwd/Trans to Outside Line” on page 80](#). If **Fwd / Trans to Outside Line** is disabled, you cannot change the target destination to an outside phone number.

To set up Intercom Call Forward–No Answer:

1. On the **Admin Settings** menu, press **1** to display the Intercom CFNA settings.

2. Press \triangleleft or \triangleright to select a target:
 - **Mailbox.**
 - **Ext.** Then press ∇ and enter a valid extension in the **to Ext:** field.
 - **Phone#.** Then press ∇ and enter a valid phone number. Before you can save this setting, “Fwd/Trans to Outside Line” must be enabled.
 - **OFF.** Calls will not be forwarded. Go to Step 5.
3. Press ∇ to highlight the **Delay** before forwarding.
4. Press \triangleleft or \triangleright to adjust the delay time in five-second increments.
5. Press **Save** to accept the change and display the **Admin Settings** menu.



Fwd/Trans to Outside Line

You can enable or disable the ability of each Deskset to forward or transfer a call to an outside line. These features use two of your telephone lines. This function is enabled by default. Disabling this function prohibits the user from sending a call to an outside line via the Gateway.

To enable or disable Forward/Transfer to an outside line:

1. On the **Admin Settings** menu, press **2** to display the **Forward/Transfer to line** screen.

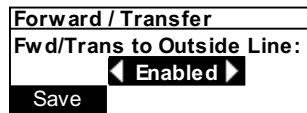

2. Press \triangleleft or \triangleright to select **Enabled** or **Disabled**.
3. Press **Save** to accept the changes and return to the **Admin Settings** menu.



If Intercom Call Forward–No Answer is set to **Phone#**, disabling Fwd/Transfer to Outside Line causes a warning message to appear, warning you that Call Forward–No Answer is set to OFF. You may want to select a new target for the Intercom Call Forward–No Answer setting.

IP Settings

On the IP Settings menu, you can manually configure the Deskset IP address. See [“Appendix B: IP Addresses and Connectivity” on page 104](#) for a discussion of the Syn248 network configuration and IP settings.

To display the IP Settings screen:

1. On the **Admin Settings** menu, press **3** to display the **IP Settings** screen.

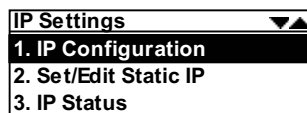

2. Perform one of the following:
 - a. Press **1** to select **IP Configuration**. See [“To set the IP Configuration:” on page 81](#).
 - b. Press **2** to select **Set/Edit Static IP**. See [“To set and edit static IP Address:” on page 81](#).
 - c. Press **3** to select **IP Status**. See [“To view the IP status:” on page 81](#).



To set the IP Configuration:

1. On the **IP Settings** menu, press **1** to select **IP Configuration**.
2. Press \triangleleft or \triangleright to select **Auto** or **Static**.

IP Configuration	
Set IP to:	\triangleleft Auto \triangleright
Save	

3. Press **Save** to accept the changes and return to the **Admin Settings** menu.

Set/Edit Static IP

If your business requires a static IP address, you can enter static IP info at each Deskset.

To set and edit static IP Address:

1. On the **IP Settings** menu, press **2** to display the **Set/Edit Static IP** screen.

Set/Edit Static IP		
IP Address:		
Subnet Mask:		
Save	."	Backspc

2. Enter digits:
 - The number field is limited to 12 digits (not including dots).
 - Pressing **."** inserts a dot.
 - Pressing **Backspc** when the cursor is positioned next to a dot deletes the dot and the digit to the left of the dot.
3. Press \triangle or ∇ to move to another field.
4. Press **Save** to accept the changes and return to the **Admin Settings** menu.

IP Status

The **IP Status** screen is for informational purposes only.

To view the IP status:

1. On the **IP Settings** menu, press **3** to display the **IP Status** screen.

IP Status	
IP Type:	Auto
IP Address:	192.168.0.123
Subnet Mask:	255.255.255.0

2. Press \triangle or ∇ to view status entries that are not shown on screen.
3. Press **Exit** to return to the **Admin Settings** menu.



Reset User Password

Having a user password is not required, but users may want to set one in order to prevent others from accessing their Voicemail or User Settings. If users forget their passwords, or you want to eliminate the need for a password, or to enter a new user password, you need to reset the user password.

To reset the user password:

1. On the **Admin Settings** menu, press **4** to begin the password reset process. The confirmation screen appears.

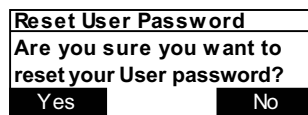

2. Press **Yes** to confirm password reset.

A screen appears, informing you that the password has been reset. The Deskset user can now access the settings menus and Voicemail without entering a password.

Upgrade Deskset Software

You can upgrade Deskset software from the Deskset or using the WebUI. To update the Deskset software from the WebUI, see [“Updating Devices” on page 62](#).

To access the Deskset Software Upgrade feature:

1. On the **Admin Settings** menu, press **5** to display the Software Upgrade screen. The system scans for an upgrade.

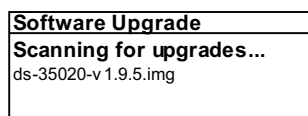

- If an upgrade is available, the **Found New Upgrade** screen appears. Press **Upgrade** to install the upgrade or press **Cancel** to return to the Admin Settings menu.
- If no upgrade is available, the **No New Version** screen appears. Press **Exit** to return to the Admin Settings menu.



NOTE If the device is sluggish or unresponsive during the upgrade process, see [“A Syn248 device becomes sluggish or unresponsive during or immediately after software upgrade.” on page 99](#).

The Deskset automatically resets at the end of the software upgrade process. If a PC is connected to the Deskset that you are using, any network traffic involving that PC halts until the Deskset has resumed operation. Avoid updating the Deskset when the user is likely to be at the workstation.

See [“Updating Devices” on page 62](#) to update the Deskset software from the WebUI.



Set Time and Date

You can set the system time and date using a Deskset. To set the system time and date from the WebUI, see [“Changing the System Basic Settings” on page 30](#).

To set the System time and date:

1. On the **Admin Settings** menu, press **6** to display the screen shown below.

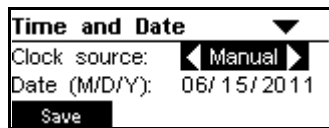

2. Press \triangleleft or \triangleright to select the **Clock source**. You can set the system time to follow a Network Time Protocol (NTP) Server (recommended) or you can set the time and date manually.

If you select **NTP Server**, the manual time and date settings disappear from the screen. Ensure that you have configured the NTP Server on the WebUI. See [“Changing the System Basic Settings” on page 30](#).

3. If you select **Manual**, use the dial-pad keys and press \triangleleft or \triangleright and ∇ or \triangle to manually set the Date, Time, Time Zone and Daylight Savings.
4. Press **Save** to return to the **Admin Settings** menu.



CHAPTER
4

TROUBLESHOOTING

If you have difficulty operating your system, try the following suggestions in this section:

- *“Common Troubleshooting Procedures” on page 85*
- *“Initial Installation” on page 91*
- *“Display Messages” on page 91*
- *“Gateway Setup” on page 94*
- *“WebUI” on page 95*
- *“PC/Deskset Interaction” on page 101*
- *“Other Deskset Features” on page 102.*

**NOTE**

For customer service or product information, visit our web site at www.telephones.att.com/smb or call **1 (888) 386-2006**. In Canada, call **1 (888) 469-2005**.



Common Troubleshooting Procedures

Follow these procedures to resolve common issues.

Resetting Devices

You may need to manually restart a device or return a device to factory defaults (see ["Appendix D: Default Settings" on page 106](#)). To reset a device, press the **RESET** button shown in [Figure 24 on page 85](#) and [Figure 25 on page 86](#) by inserting a pen or paper clip into the hole and applying pressure to the button.

To restart the device without losing any custom settings, press the **RESET** button for less than five seconds. You can get the same result by disconnecting and reconnecting power to the device. You can restart the device if the device does not respond or fails to synchronize with the system.

To completely reset the device to factory defaults, unplug the LAN cable and press the **RESET** button for more than five seconds. You might do this if the device is not synchronized or you want to reset the IP address settings to Auto (DHCP). Any static IP configurations are lost.

When resetting a Deskset to factory defaults, the system configuration (the user settings and Personal directory) and Voicemail messages, Call Log, and the Redial list are all deleted. You can use this complete reset when assigning Desksets to new users. If you do not disconnect the LAN cable before pressing the **RESET** button, the extension number is retained. During the reset, any PC connected to the Deskset PC port momentarily loses network connectivity.

**NOTE**

To reset the entire system to factory defaults and completely clear the system of all settings (Auto Attendant, hold message, and System Directory) and Voicemail messages, unplug the LAN cables from all devices and press the **RESET** button for more than five seconds on each device. Then reconnect all devices to the LAN.

If there is one Gateway in the system, but there are still Desksets connected, then only the voice prompts and hold messages are deleted; the rest of the Auto Attendant settings are maintained on the Desksets. If there is another Gateway, the other Gateway maintains all system configuration settings.

**NOTE**

If you have already set up the system, back up the Deskset and system settings before resetting the device to factory defaults.

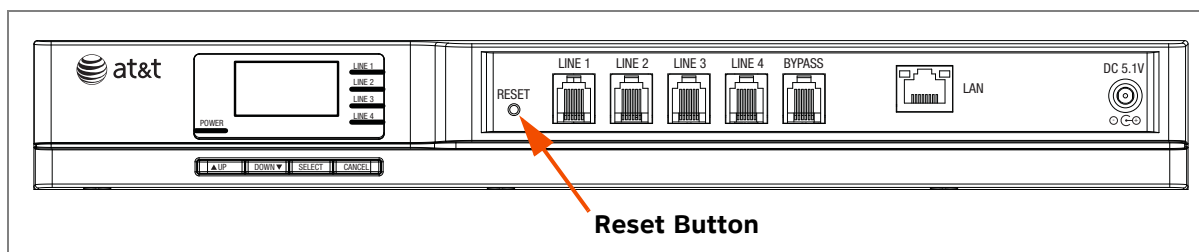

Figure 24. Gateway Reset Button



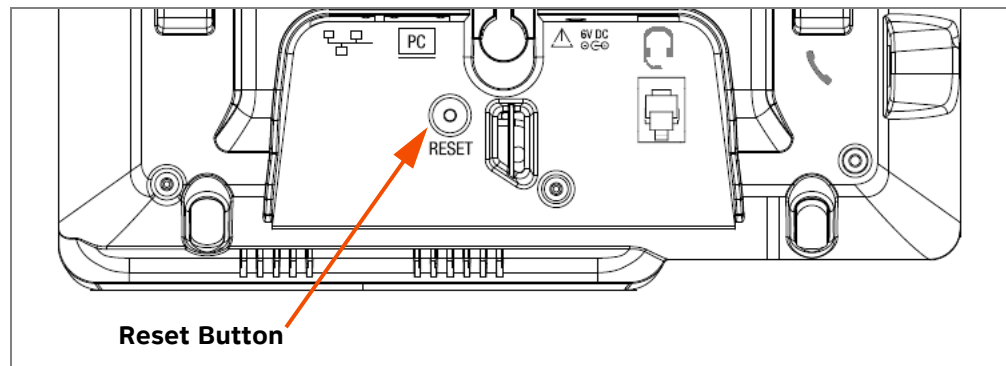

Figure 25. Deskset Reset Button

Resolving General Functional Issues

To resolve a blank screen or device that does not work at all:

- Ensure the AC plug is plugged into an electrical outlet not controlled by a wall switch.
- Verify that the AC power outlet has power. Try plugging in some other AC device. If nothing works, contact an electrician or use another power outlet.
- Verify that the DC plug is plugged into the power jack on the device.
- The system devices are not immediately active when powered up and after a power interruption. Allow at least 30 seconds for the device to boot up.
- If this is a Gateway, check the LED status. The POWER LED should be **GREEN**.
- For Desksets connected to PoE, check whether any PoE switch ports have been configured for devices that require less power. If so, configure your PoE switch to auto-detect device power requirements. For Deskset PoE specifications, see ["Appendix C: Technical Specifications" on page 105](#).

To resolve a sluggish, unresponsive, or unusually behaving device:

Reset the device by pressing the **RESET** button for less than five seconds (see [Figure 25 on page 86](#)) or by removing and restoring AC power.



CAUTION Pressing the **RESET** button for more than five seconds will erase all data and settings.

To resolve an incorrect system clock:

If the system clock displays the wrong time, the system lacks Internet access for acquiring current time data.

1. Log on to the WebUI as administrator and click **System Basic Settings**.
2. In the **System Time/Date Options** section, specify a local Network Time Protocol (NTP) Server, or manually set the time. Then click .



Resolving Audio Echoes

The SB35010 Gateway uses automatic telephone line calibration to ensure optimal audio performance on outside calls. If excessive echo occurs on outside calls consistently, observe the Gateway line calibration data to understand any telephone line issues. Occasional echoes may be caused by the other person's phone.

To resolve audio echo issues:

1. Log on to the WebUI as administrator. Click **Device Management**, then **Device Log** in the navigation menu at left.
2. Select the Gateway from the drop-down list. Line Calibration Data appears as shown in Figure 26.
3. Check the loss numbers within the Line Calibration Data box for each telephone line on each Gateway. (A loss number above 10 indicates good audio performance.)

Line Calibration Data						
Port	VRMS	Loss	Index	Profile	RX Offset	TX Offset
1	1087	22.5	5	0	0	0
2	1231	21.4	5	0	0	0
3	954	23.6	6	0	0	0
4	5402	8.5	0	1	0	0

Figure 26. Line Calibration Data

4. If the loss number is below 10, the system will most often function normally, but there is an increased likelihood of audio performance issues like echo. If the loss number is below 10 the following procedures can be used to increase the loss value:
 - a. Unplug that telephone line at the Gateway.
 - b. After the line LED turns red and waiting 15 to 30 seconds, plug the line back in to recalibrate.
5. If the recalibration has no effect, a parallel device such as a fax adapter, alarm system, DSL modem, or DSL splitter/filter may be connected to the system. Parallel external devices may affect line calibration. Disconnect these devices from the telephone wall jacks that are connected to the same telephone lines, as follows:
 - a. Unplug these non-system external devices from their telephone wall jacks.
 - b. Unplug the telephone line connections from the Gateway.
 - c. After the Gateway Line-Status LEDs turn red and waiting 15 to 30 seconds, plug the telephone lines into the Gateway again to recalibrate.
 - d. If there is a significant increase in the loss number and improved audio performance on those lines after disconnecting a parallel device, consult your telephone service provider to either investigate the problem or to install separate lines for those parallel devices.



Resolving General Audio Issues

Check the following if you hear static, sudden silences, gaps in speech, echoes, distorted speech, or garbled speech.

To resolve general audio issues:

You may be experiencing network problems.

- Your LAN administrator should ensure the following minimum guidelines are met:
 - A switched network topology, which requires attaching network components to switches rather than hubs, is recommended. The network should use standard 10/100 Ethernet switches that carry traffic at a nominal rate of 100 Mbit/s.
 - The office network infrastructure should use Cat.-5 wiring.
- Do not connect a network server PC to the PC port on the Deskset.

If you have Digital Subscriber Line (DSL) service, you may be experiencing telephone line problems.

- Make sure you have a DSL filter plugged in between each DSL line and the telephone wall jack.
- You may need a higher quality DSL filter than you are currently using. You can also try plugging in multiple DSL filters in sequence to decrease DSL interference.
- Move the DSL line to the lowest priority line, which is Line 4 on the highest numbered Gateway, as indicated on the Gateway display.

The Gateway might not have recognized a new outside telephone line, so line calibration — which allows the Gateway to adjust its performance depending on the phone lines' characteristics — did not occur. After unplugging the telephone line, wait for 15 to 30 seconds before plugging the telephone line back into the Gateway.

Reintroducing a Deskset Into the System

If there are no more than 24 Desksets in the system and a Deskset screen displays **Synch Failed** or **Synchronizing** for a long time, you may need to remove the Deskset from the system and reintroduce it. This problem may have been caused by a network disruption, the Deskset having been part of a different network, or by an AC power failure.

To reintroduce a Deskset into the system:

1. Ensure that the Deskset is connected to the same LAN subnet as other system Gateways and Desksets. Ensure that the PC you will use to access the WebUI is either on the same subnet as Syn248, or that the PC subnet can communicate with the Syn248 subnet. Devices on the same subnet generally share the first three octets of their IP addresses. If the subnets are different, contact your installer.
2. If you want to retain the programming for a problem Deskset, back up the Deskset.
 - a. Log on to the WebUI as administrator on the problem Deskset. Click **Device Management**, then **Back up/Restore**, and then **Extension Settings** in the navigation menu at left.



- b. Select the extension from the **Select Extension to Back up** drop-down list, and click **Back up Extension** to save the file to a specified location on your computer. You will need to locate and retrieve this file later, so make sure you remember where you saved it. The default file name will be in the format:

backup_ds_[extension number]_[year]-[month]-[day]_[time].cfg.

If you back up the same extension less than one minute after creating the backup, you may overwrite the earlier backup file.

3. Perform a complete factory reset to return to the values set at the factory.
 - a. Unplug the LAN cable.
 - b. Insert a pen or the end of a paper clip into the **RESET** button, located on the underside of the Deskset. Hold until **Restoring to Factory Defaults** appears on the screen (approximately 5 seconds).

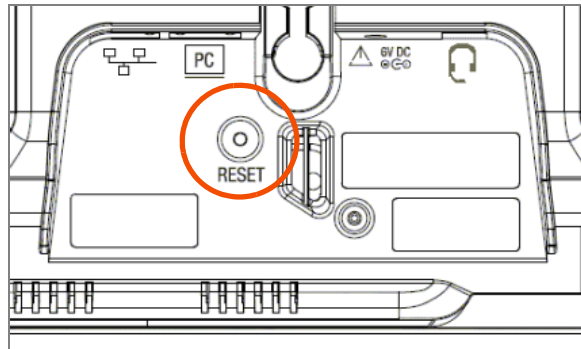

After the Deskset restarts, the screen displays **EXT 0**.

- c. Reconnect the LAN cable.

The Deskset rejoins the system. Unless the entire system was reset, the Deskset retains its previous extension number. After the Deskset rejoins the system, the screen changes from **EXT 0** to the previous extension number.
4. If you backed up the Deskset settings in Step 2, restore your settings.
 - a. Log on to the WebUI as the Administrator at the PC where you stored the backup file.

Syn248 Desksets with static IP addresses need to have new addresses assigned if the Deskset IP addresses are to be used for logging into the WebUI. At the Deskset, press **MENU** → **3** → **3** → **2** to set the **IP address**.
 - b. Click **Device Management**, then click **Back up/Restore**.
 - c. Under **Restore Extension Settings**, select the Deskset's extension number from the **Select Extension to Restore** drop-down list. See ["Back Up and Restore Settings" on page 58](#).
 - d. Select the backup file.
 - e. Click **Restore Extension**.



Power Failure Recovery Procedure

The Syn248 system automatically recovers after a power failure. The following describes the recovery process.

Allow about a minute for the Gateway to boot up when power returns after a power failure. The power-up sequence for the Gateway follows:

1. About 20 seconds after turning on power to the device, the POWER LED turns on.
2. When the device finds the network, **Synchronizing** momentarily appears, indicating that the device is in the process of detecting and synchronizing with other system devices.

```
03:45PM 24-FEB-10
PSTN Lines 1 - 4
Synchronizing...
```

3. Once the device has successfully finished synchronizing with the rest of the system, **Synchronized** appears.

```
03:45PM 24-FEB-10
PSTN Lines 1 - 4
Synchronized
IP: 192.168.1.4
```

When AC power returns after a power failure, the system self-assigns a link-local address to the Deskset beginning with number 169.254.

- If the Deskset is set for automatic IP address configuration, it searches for the DHCP server. If the DHCP server is found, it assigns an IP address.
- If the Deskset is set with static IP addresses, the address does not change.

We recommend that you check each Deskset and Gateway to confirm that it has started up properly.

If any of the system devices' screens report **Synch Failed** or **Synchronizing** for more than 10 minutes, see ["Reintroducing a Deskset Into the System" on page 88](#) for recovery methods from these states.



NOTE

The time and date may not be correct. The time and date are set using the WebUI ["System Settings" on page 30](#).

The Desksets also automatically restart and synchronize after an AC power failure.



NOTE

Some systems will take longer than others depending on the network topology.



Initial Installation

The device screen displays **Synchronizing**.

Probable Cause	Corrective Action
The device has previous data and settings that are now inconsistent with current system settings.	<ul style="list-style-type: none"> ■ Erase all Deskset data and settings by unplugging the LAN cable and pressing the reset button on the bottom of the Deskset for more than five seconds. ■ The LAN cable may be connecting the Network port on the bottom of the Deskset, marked , to another system device, rather than to the Network. Make sure the LAN cable is attached to the LAN.

Display Messages

The Gateway screen is blank.

Probable Cause	Corrective Action
Many.	<ul style="list-style-type: none"> ■ See “To resolve a blank screen or device that does not work at all:” on page 86.

The Gateway screen displays **Joining Site...** for more than one minute.

Probable Cause	Corrective Action
The Gateway is failing to synchronize with a Deskset configured for a different system configuration.	<ul style="list-style-type: none"> ■ Always disconnect the LAN cable before restoring factory defaults (by pressing the RESET button more than five seconds).

The device screen displays **Network Down**.

Probable Cause	Corrective Action
The LAN cable is unplugged.	<ul style="list-style-type: none"> ■ Ensure that one end of the LAN cable is plugged into the Network/LAN port on the device and that the other end is plugged into your office LAN. ■ Confirm that the light next to the LAN port is green. If it is not, unplug the cable and plug it in again.
There may be a problem with the office network.	<ul style="list-style-type: none"> ■ Check if other network devices, such as computers, are communicating with the network. If not, then contact your IT administrator.



The device screen displays Synch Failed.

Probable Cause	Corrective Action
The device synch failed when trying to connect to the system.	<ul style="list-style-type: none"> Reset the device. Disconnect power or insert a pen or paper clip to press the RESET button for less than five seconds.
The device was disconnected, then reconnected after configuration changes were made to the system.	<ul style="list-style-type: none"> See “Reintroducing a Deskset Into the System” on page 88.
The device was configured on another network or has returned to the system after being deleted from the system.	<ul style="list-style-type: none"> Reset to factory defaults by using a paper clip to press and hold the RESET button for more than five seconds. See “Reintroducing a Deskset Into the System” on page 88.
The maximum number of that type of device has been reached.	<ul style="list-style-type: none"> A device must be removed from the network and deleted from the system before another device can be added.
The same Deskset extension number already exists.	<ul style="list-style-type: none"> Reset the Deskset to factory defaults without the network cable connected. Use a paper clip to press and hold the RESET button for more than five seconds.

The device screen displays Synchronizing.

Probable Cause	Corrective Action
Not enough time has elapsed.	<ul style="list-style-type: none"> The device may display Synchronizing for a few seconds. This is normal and does not indicate a problem.
This device is the first Syn248 device on the network.	<ul style="list-style-type: none"> Connect another Syn248 device to the network.
The devices are on different subnets.	<ul style="list-style-type: none"> If you use static IP addresses, ensure that the first three octets of the device IP address matches the IP addresses of the other system devices.



Probable Cause	Corrective Action
The device may have been configured on another network.	<ul style="list-style-type: none"> ■ Power cycle the Deskset by unplugging the power cord and plugging it back in. ■ If power cycling does not work, back up your Deskset and reset to factory defaults. <ol style="list-style-type: none"> a. Back up the Deskset. See “Back Up and Restore Settings” on page 58. b. Unplug the LAN cable c. Press the RESET button for at least five seconds. d. Restore your settings after the Deskset restarts.

Deskset cannot make or receive phone calls and the Deskset screen displays Synchronizing.

Probable Cause	Corrective Action
The Deskset may have an incompatible software version.	<ul style="list-style-type: none"> ■ Log on to the WebUI using the IP address of the Deskset and update the software. See “Updating Devices” on page 62.

A Syn248 device displays Host Not Found after a user attempts a software upgrade.

Probable Cause	Corrective Action
The user attempted a software upgrade with no outside Internet connection.	<ul style="list-style-type: none"> ■ Ensure you have Internet connectivity and that your connection to your Internet Service Provider is operating normally. ■ Ensure your firewall is not blocking http requests. ■ Ensure that http requests are not being directed to a firewall log-in page. ■ Ensure that your http requests are not being routed through a proxy server.



A Syn248 device displays an error message other than Host Not Found after a user attempts a software upgrade.

Probable Cause	Corrective Action
The device encountered an unexpected problem.	<ol style="list-style-type: none"> 1. Disconnect the power to the device, wait a few minutes, then reconnect the power and try the upgrade process again. 2. If the error message persists, visit our web site at www.telephones.att.com/smb or call 1 (888) 386-2006. In Canada, call 1 (888) 469-2005.

Gateway Setup

Line-Status LEDs do not flash red when the telephone line cords are plugged into the Gateway after power is switched on.

Probable Cause	Corrective Action
Line calibration allows the Gateway to adjust its performance depending on the phone lines' characteristics. The Gateway may not have performed calibration.	<ul style="list-style-type: none"> ■ Make sure an LAN cable is plugged into the port marked LAN. ■ Unplug the telephone line. After the Gateway line LED turns red, wait 15 to 30 seconds before plugging the line back in.

Bypass jack does not work during power failure.

Probable Cause	Corrective Action
The line is not in the correct jack.	<ul style="list-style-type: none"> ■ Make sure there is a line plugged into Line 4. ■ Make sure an analog phone is plugged into the Bypass jack (using a modular line cord).



WebUI

Administrator WebUI

The WebUI is unresponsive.

Probable Cause	Corrective Action
The web browser encountered an unexpected problem.	<ol style="list-style-type: none"> 1. Close the unresponsive web browser, reopen the browser, and log back in as administrator. 2. If this does not work, try again using the IP address of a Deskset that is connected to the PC you are using. 3. If this does not work, try closing the browser and waiting 10 minutes before logging back in.

The WebUI displays “Login to target device failed.”

Probable Cause	Corrective Action
The software version of the device you are currently logged into is no longer compatible with the software version of other devices within the network.	<ol style="list-style-type: none"> 1. Log on to the WebUI as administrator using the IP address of the device that caused the problem. Click Device Management, then Update Device in the WebUI navigation menu at left. 2. Click <input type="button" value="Install Update"/>. The selected device updates its software and reboots. 3. After the device reboots, check the software version number on the device to confirm that the upgrade was successful. <ul style="list-style-type: none"> ■ On the Deskset, press MENU → 4. Note the Software Ver value. ■ On the Gateway, press the SELECT key to access the Main Menu. Then select Device Information, then SW Ver.
The device to be updated is unplugged.	<ul style="list-style-type: none"> ■ Verify that the device is powered up.
The device to be updated has failed to synchronize with the system.	<ul style="list-style-type: none"> ■ Verify that the other device says Synchronized. If it does not, see “Reintroducing a Deskset Into the System” on page 88.



A Syn248 device upgrade failed, the WebUI displays “Login to target device failed”, and the WebUI and device screens display the old software version.

Probable Cause	Corrective Action
The software version of the device you are currently logged into is no longer compatible with the software version of other devices within the network.	<ol style="list-style-type: none">1. Log on to the WebUI as administrator using the IP address of a device that does not have updated software and is not having any problems. Click Device Management, then Update Device.2. Select a device from the Update Device drop-down list. Do not select the device whose IP address you are using.3. Click <input type="button" value="Install Update"/> . The selected device updates its software and reboots.4. After the device reboots, check the software version number on the device to confirm that the upgrade was successful.<ul style="list-style-type: none">■ On the Deskset, press MENU → 4. Note the Software Ver value.■ On the Gateway, press the SELECT key to access the Main Menu. Then select Device Information, then SW Ver.5. After updating all other devices, upgrade the device whose IP address you are using.



Some devices did not update after using [Update All Devices](#).

Probable Cause	Corrective Action
Did not allow enough time for software to update due to a slow Internet connection.	<ul style="list-style-type: none"> ■ Wait 30 minutes, then check whether additional devices have been updated. If devices are still being updated, then the Internet connection is slow and you must wait for all the devices to complete the update process. ■ If the update has failed (you see a failure message), retry Update All Devices. Allow sufficient time for the upgrade process to complete. You may prefer to schedule a system update to take place overnight. ■ Update individual devices manually either through the front panel or through the WebUI for that particular device. <hr/> <p> NOTE If you are using the WebUI to upgrade the device, ensure that you log on using that device's IP address.</p> <hr/> <ul style="list-style-type: none"> ■ Power cycle each device that did not get upgraded. Unplug the power cord and plug it back in. As each device reboots, it automatically updates if it detects updated software in the system.

An extension number was not changed correctly.

Probable Cause	Corrective Action
That extension may have been on a call while the extension number was changed in the WebUI, or someone tried to change the extension number to a number that was already being used.	<ul style="list-style-type: none"> ■ Change the extension number again. Make sure no one is using that extension while you are changing its settings. <ul style="list-style-type: none"> a. Log on to the WebUI as administrator, click Extension Settings, then Basic Settings. b. Enter a new extension number in the Change Extension Number to box.



WebUI reverts to Log-in page after clicking a navigation link.

Probable Cause	Corrective Action
The browser is not checking for newer versions of pages.	<ul style="list-style-type: none"> Ensure that your Internet browser is working normally. It may not be automatically caching pages. For example, in Internet Explorer 7, click Tools → Internet Options. Then under Browsing history, click Settings. Under Check for newer versions of stored pages, select Automatically.

Changes made to System Configuration from the WebUI are not saved.

Probable Cause	Corrective Action
The device whose IP address you used to log in to the WebUI failed to synchronize with the system. The WebUI displays "Unable to save data at this time. Please re-enter and try again."	<ul style="list-style-type: none"> Check the device status in the footer of the WebUI page. If the status reads "Synch Failed," see "Reintroducing a Deskset Into the System" on page 88.
More than one person is using the WebUI to change System Configuration at the same time.	<ul style="list-style-type: none"> Make sure only one person at a time logs on as the administrator.
Apply must be clicked on each page to confirm the changes.	<ul style="list-style-type: none"> Click Apply on each page to confirm the changes.

Prompt created for Auto Attendant menu or Hold Announcement is not saved.

Probable Cause	Corrective Action
You must hang up the extension before saving the recording.	<ul style="list-style-type: none"> After recording a prompt for an Auto Attendant menu or for the Hold Announcement, hang up the extension before clicking Save Recording in the WebUI.



System Upgrade

A Syn248 device becomes sluggish or unresponsive during or immediately after software upgrade.

Probable Cause	Corrective Action
Cannot connect to AT&T server or the device encountered an unexpected problem.	<ul style="list-style-type: none"> Disconnect the power to the device, wait a few minutes, then reconnect the power and try the upgrade process again.

During device upgrade one of the following messages appears: “UNKNOWN ERROR Current image version” or “UNKNOWN ERROR”.

Probable Cause	Corrective Action
A communication error between the devices and the server.	<ul style="list-style-type: none"> If this failure occurred after clicking Update All Devices, power cycle each device that did not get upgraded. Unplug the power cord and plug it back in. As each device reboots, it automatically updates (if it detects updated software in the system). Wait 30 minutes to allow for the device to update. If the system has a very low bandwidth Internet connection, it may take up to 4 hours. If this failure occurred during a manual single-device update, power cycle the device that did not get upgraded. Unplug the power cord and plug it back in. As the device reboots, it automatically updates if it detects updated software in the system.



User WebUI

Unable to access the WebUI Log-in page from my computer.

Probable Cause	Corrective Action
The computer is not connected to the same subnet (network) as the Deskset, and the subnets are not set up to communicate.	<ul style="list-style-type: none"> Verify the IP address. You must correctly enter the IP address of your Deskset into your Internet browser's address bar. At the Deskset, press MENU → 4 to see the IP address displayed in the third line of the information. Ensure that there is an LAN cable attached to Network port on the Deskset and to the LAN. If a PC at the same workstation is sharing the LAN connection, attach a network cable to your computer's network port and to the PC port on the back of the Deskset. Confirm that your computer and your Deskset are on the same subnet so that they can talk to each other. Check that the first three sections of each IP address are the same. If they are not, they may not be connected to the same subnet. Contact the installer; the subnets may not be set up to communicate.
The local address, rather than the network IP address, was used in the address line of the browser.	<ul style="list-style-type: none"> Use the network IP address assigned through DHCP or manually in the address bar of the browser.

Changes made to System Configuration from the WebUI are not saved.

Probable Cause	Corrective Action
Apply must be clicked on each page to confirm the changes.	<ul style="list-style-type: none"> Click Apply on each page to confirm the changes.



PC/Deskset Interaction

Internet connection or access to the local network on my computer does not work after installing the Deskset.

Probable Cause	Corrective Action
The LAN cables are not installed correctly.	<ul style="list-style-type: none"> Check that the network cable from the computer is plugged into the Deskset port labeled PC. A second LAN cable should be plugged into the port on the Deskset marked  with the other end plugged into your LAN.

My PC is slower now that I have connected it to the LAN through the Deskset.

Probable Cause	Corrective Action
A computer connected through the Deskset will be limited to 100 Mbits/s.	<ul style="list-style-type: none"> Use separate network connections for the Deskset and the computer so that the computer can take advantage of the network's greater bandwidth.

My PC, which is connected to the LAN through the Deskset, briefly loses its network connection.

Probable Cause	Corrective Action
For PCs connected to the LAN through Desksets, disruption to the Deskset operation affects the PC. For example, when the Deskset restarts (possibly due to a software upgrade) the connection to the LAN is temporarily lost.	<ul style="list-style-type: none"> If the PC is connected to the LAN through the Deskset, avoid updating software or restoring the Deskset settings when a user is at the workstation. If the PC is connected to the Deskset, and if the PC is connected to an Uninterruptible Power Supply (UPS), plug the Deskset into a UPS. Use separate network connections for the Deskset and the computer.



Other Deskset Features



For more information about the corrective actions recommended in this troubleshooting section, see the SB35020 Deskset User's Guide at www.telephones.att.com/smb.

Other Desksets do not appear in the extension list.

Probable Cause	Corrective Action
The Deskset is not connected to the same subnet as the other Desksets.	<ul style="list-style-type: none"> Verify that the first two sections of the IP address (the portion before the second "dot") match the IP addresses of the other Desksets or that the subnets are set up to communicate with each other. Press MENU → 4 at a Deskset to find the IP address. If the other Desksets have been assigned static IP addresses, you may have to assign your Deskset a static IP address to match the other Desksets.

Users cannot add Quick-Dial entries.

Probable Cause	Corrective Action
You must configure one or more Programmable Function Keys as Quick Dial keys before they can be used.	<ul style="list-style-type: none"> Configure one or more Quick-Dial keys for the Deskset. See Feature Keys under the Extension Settings menu.



APPENDIXES

Appendix A: Expanding Your System

You can add another SB35010 Gateway to expand your system to support up to 8 incoming lines, as shown in Figure 27.

After adding the Gateway to the system, ensure that you select a Phone Line CFNA destination for the additional phone lines connected to the Gateway (see ["Configuring Phone Line CFNA" on page 41](#)), and that you assign the lines to Line keys on the Desksets (see ["Deskset Programmable Feature Keys \(PFKs\)" on page 52](#)).

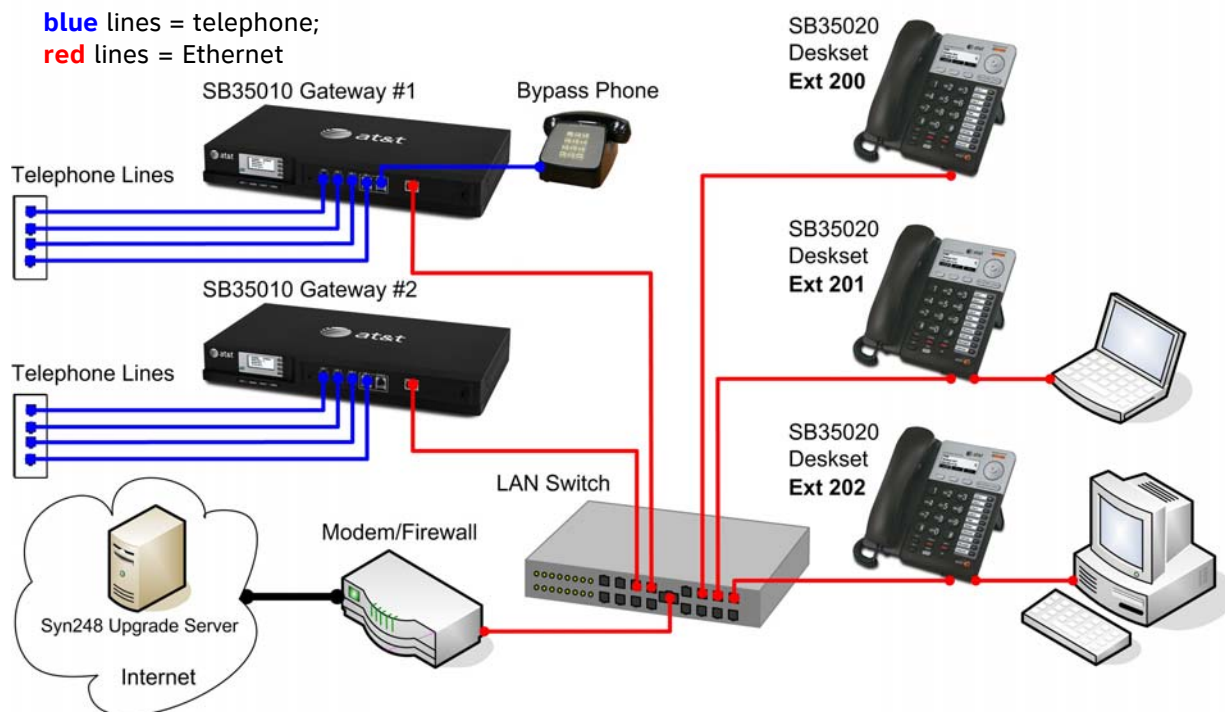

Figure 27. Expanded Syn248 System

Appendix B: IP Addresses and Connectivity

An IP address is an individual numeric identification assigned to devices on a computer network. At least one Syn248 device needs a network-assigned IP address on the subnet shared with any computers that will allow access to the WebUI. Valid IP addresses on the same subnet allow devices on the network to identify each other and enable communication.

This IP address may be assigned from a Dynamic Host Configuration Protocol (DHCP) server, or set statically to the same subnet, and will be separate from the self-assigned 169.254.xxx.xxx link-local address that the Syn248 devices use to communicate with each other. When setting up the IP address on a Syn248 device, this network IP address used for WebUI connectivity is the only address you can change.

The network IP addresses can be assigned in two ways:

1. The Syn248 device can request a network server to automatically assign an IP address. This IP address is a dynamic assignment; the address is on lease from the server. The lease is renewed as long as the device remains connected and there is no change to the network. However, if the device is disconnected, or if there is a network or AC power interruption, the lease may not be renewed (that is, the IP address expires) and a new IP address may be assigned.

Most LANs use servers to automatically assign IP addresses. Syn248 defaults to assuming that this automatic assignment will occur.



Some servers have default settings that limit the number of network IP addresses assigned to devices on the network. You should log in to your server to confirm that the IP range is sufficient to accommodate at least one of the Syn248 devices that you are adding as at least one Syn248 device needs an assigned IP address to enable WebUI configuration activities. Consult the IT department if you need help checking the server.

2. The Syn248 system administrator can manually assign a static system IP address. This IP address does not change, even when there are network or AC power interruptions. Some installations will require manual static IP assignment. You can assign a static IP address for a Gateway using the device front panel interface. See [“Gateway Configuration” on page 74](#). You can assign a static IP address for a Deskset from the Deskset IP Settings menu. See [“IP Settings” on page 80](#).



Appendix C: Technical Specifications

Table 4 lists the technical specifications for the SB35010 Analog Gateway and SB35020 Deskset.

Table 4. Technical Specifications

Feature	Specification
Frequency control	Crystal controlled PLL synthesizer
Size	SB35020 Deskset: 6.9" × 7.9" × 8.1" (H × W × D @ 57° angle), 7.9" × 7.9" × 7.1" (H × W × D @ 41° angle) SB35010 Gateway: 1.8" × 13.5" × 7.9" (H × W × D)
Weight	SB35010 Gateway: 88.18 oz. (2500 g) (including adapter) SB35020 Deskset: 35.59 oz. (1009 g) (including adapter)
Power Requirements	SB35010 Gateway: 5.1 V DC @ 1700 mA SB35020 Deskset: 5.1 V DC @ 1700 mA (AC Adapter), PoE Class 2
RJ-45 Ethernet Network Jack	(10Base-T/100Base-Tx) with auto MDI/MDIX switching
Gateway Telephone Jacks	1–4 and BYPASS (FXO ports) use traditional 2-conductor wiring
Gateway BYPASS	26 mA loop current; REN 5; 100 m max loop length
LAN Cable	Cat.-5 standard cable
Deskset Headset	Traditional corded handset jack type with 2-conductor wiring



Appendix D: Default Settings

Table 5 and Table 6 list the default settings for the Syn248 system.

Table 5. System Default Settings

Parameter	Selection	Default
Admin Password	4 through 6 digits	12345
Administrator Login Name	16 characters max	Admin
Auto Attendant Digit Assignment (1–9, *, #)	None, Replay, Directory, Previous Menu, Main Menu, Default Menu, (user created)	None
Auto Attendant Enable Direct Dial	On, Off	On
Auto Attendant Enable Operator	On, Off	On
Backup/Restore Settings	All extensions	Nothing
Call Forward-No Answer	On, Off	On
Call Forward-No Answer Extension Number	200 through 299	Nothing
Call Forward-No Answer Seconds Before Forwarding	5 though 45	15
Intercom Call Forward-No Answer Target Type	Voicemail, Extension, Outside Phone Number	Voicemail
Phone Line Call Forward-No Answer Target Type	Off, Voicemail, Extension, Outside Phone Number, Auto Attendant	Auto Attendant
Call Forward-No Answer Telephone Number	32 Digits Maximum	Nothing
Delete Extension	All extensions	Nothing
Directory First and Last Name Fields	20 Digits Maximum	Nothing
Directory Number Field	32 Digits Maximum	Nothing
Directory Sort	First Name, Last Name	First Name
Display First and Last Name	16 characters maximum	Nothing
Hold message: Extension for Recording	All extensions	Nothing
Operator Extension	All extensions	200
System Time/Date Option	NTP Server, Custom Server, Manual	NTP Server
Timer for Forwarded and Transferred Outside Calls	15 through 120 (in 5-minute increments)	30
User Password	6 digits maximum	Nothing



Table 6. Deskset Default Settings

Parameter	Selection	Default
Backlight	Hi, Lo, Off	Hi
Call Forward–No Answer Delay	5 through 45 (in 5-second increments)	15
Call Forward–No Answer Target	Auto Attendant, Mailbox, Ext, Phone #, OFF	Auto Attendant
Call Forward/Trans to outside line	Enabled/Disabled	Enabled
Contrast	1 through 9	5
Current Greeting	Primary, Alternate, Pre-Set	Pre-Set
Current Name	Personal, Pre-Set	Pre-Set
Date and Time (when server is not available)		12:00PM, January 1, 2009
Directory List	All, Personal, System, Extension	All
First Name/Last Name toggle	First Name, Last Name	First Name
IP Configuration	Auto, Static	Auto
Key Beeps	On, Off	On
Preferred Audio Mode	Speakerphone, Headset	Speakerphone
Ring Volume	0 through 9	3
Ringtones	1 through 9	1
User Password	0 through 6 Digits	Nothing



Appendix E: Part Lists

SB35010 Gateway Parts List

Figure 28 illustrates the Gateway parts.

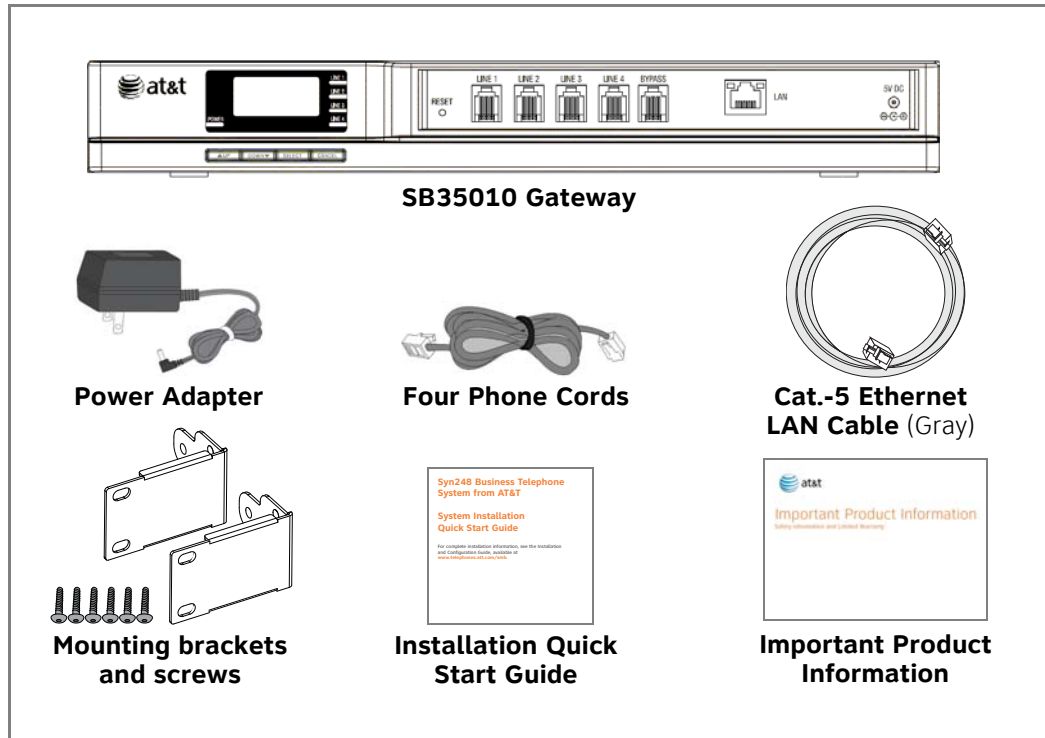

Figure 28. Gateway Parts List



SB35020 Deskset Parts List

Figure 29 illustrates the Deskset parts.

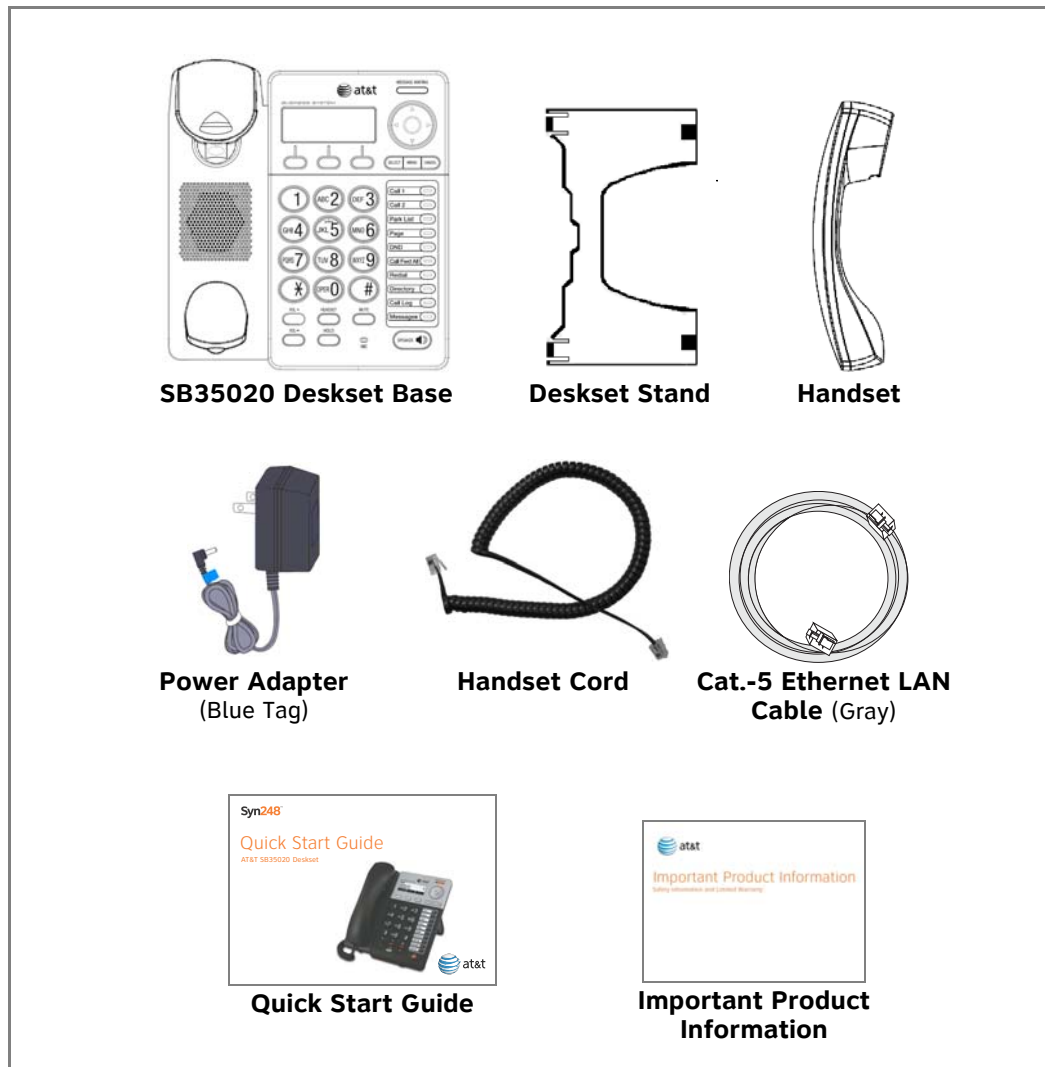

Figure 29. SB35020 Deskset Parts List



Appendix F: Maintenance



CAUTION *Your system contains sophisticated electronic parts, so it must be treated with care.*

Avoid Rough Treatment

Handle the unit gently. Save the original packing materials to protect your equipment if you ever need to ship it.

Avoid Water

Your unit can be damaged if it gets wet. Do not use the equipment outdoors in the rain or handle it with wet hands. Do not install the equipment near a sink, bathtub, or shower.

Electrical Storms

Electrical storms can sometimes cause power surges harmful to electronic equipment. For your own safety, exercise caution when using electrical appliances during storms.

Cleaning Your Unit

Your unit has a durable plastic casing that should retain its luster for many years. Clean it only with a soft cloth slightly dampened with water or a mild soap solution. Do not use excess water or cleaning solvents of any kind.



Appendix G: Important Safety Instructions



This symbol alerts you to important operating or servicing instructions in this document. Always follow basic safety precautions when using this product to reduce the risk of injury, fire, or electric shock.

When using your telephone equipment, basic safety precautions should always be followed to reduce the risk of fire, electric shock, and injury, including the following:

- Read and understand all instructions.
- Follow all warnings and instructions marked on the product.
- Unplug this product from the wall outlet before cleaning. Do not use aerosol or liquid cleaners. Use a damp cloth for cleaning.
- Do not use this product near water (for example, near a bathtub, kitchen sink, or swimming pool).
- Do not place this product on an unstable surface.
- This product should be operated only from the type of power source indicated on the marking label. If you are not sure of the type of power supply in your home or office, consult your dealer or local power company.
- Do not allow anything to rest on the power cord. Do not install this product where the cord may be walked on.
- Never push objects of any kind into this product through the slots in the unit because they may touch dangerous voltage points or create a short circuit. Never spill liquid of any kind on the product.
- To reduce the risk of electric shock, do not disassemble this product; take it to an authorized service facility. Opening or removing parts of the unit other than specified access doors may expose you to dangerous voltages or other risks. Incorrect reassembling can cause electric shock when the product is subsequently used.
- Do not overload wall outlets and extension cords.
- The power adapter is intended to be correctly oriented in a vertical or floor mount position. The prongs are not designed to hold the plug in place if it is plugged into a ceiling or an under-the-table or cabinet outlet.

Unplug this product from the wall outlet and refer servicing to an authorized service facility under the following conditions:

- When the power supply cord or plug is damaged or frayed.
- If liquid has been spilled on the product.
- If the product has been exposed to rain or water.
- If the product does not operate normally when following the operating instructions. Adjust only those controls that are covered by the operating instructions. Improper adjustment of other controls may result in damage and often requires extensive work by an authorized technician to restore the product to normal operation.
- If the product has been dropped and the unit has been damaged.
- If the product exhibits a distinct change in performance.



GLOSSARY

This glossary provides definitions that pertain to the Syn248 telephone system.

10/100 Ethernet Port: An Ethernet port that supports two different speeds of Ethernet on the same port. The two speeds supported are 10Base-T and 100Base-TX.

10Base-T/100Base-TX: An Ethernet network operating at up to 100 megabits per second

active call: An established telephone call that is not on hold

analog: A continuously variable signal

analog phone: A non-Syn248 telephone that plugs directly into a normal telephone wall plug or into the Gateway BYPASS port.

Auto Answer: You can set the Deskset to automatically answer Intercom calls after a delay that you specify. Without touching the Deskset, you can speak to and be heard by people who call you.

Auto Attendant: A system that automatically answers incoming calls and provides instructions to callers

BYPASS port: An RJ-11 jack on the Gateway that allows for communication during power outages. Plug an analog telephone into this jack.

Call Forward–No Answer: Automatically forward unanswered calls to Voicemail, the Auto Attendant, an extension, or outside phone number. The system administrator can configure a Call Forward–No Answer setting for each line connected to the Gateway, and an Intercom Call Forward–No Answer setting for each Deskset.

Cat.-5 wiring: A twisted pair data cable commonly used in offices for computer communication

CO (Central Office): An office to which subscriber home and business lines are connected. The central office has switching equipment that can switch calls locally or to long-distance carrier phone offices.

default: The original product settings

DHCP (Dynamic Host Configuration Protocol): A network protocol that automatically assigns computer IP addresses

dial pad: The 0 through 9, *, and # keys on the Deskset

direct dial: Allows callers to directly dial users' extension numbers after the Auto Attendant answers

Directory: A list of names and phone numbers

Display Names: The names that the system administrator enters to identify each extension number. The Auto Attendant uses these names to assist callers in forwarding calls.

DND (Do Not Disturb): A feature that suppresses audible ringing and incoming paging at the Deskset



DND ON: An indicator in the top right corner of the Deskset display that illuminates when you turn on the Do Not Disturb feature

DNS (Domain Name System) server: A server that stores the Domain Name System records, such as address, name server, and mail exchanger records for a domain name and responds with answers to queries against its database

DSL (Digital Subscriber Line): High-speed Internet service through your telephone line. Telephone lines with DSL service require DSL filters to separate the telephone and data signals.

DTMF (Dual-Tone Multi-Frequency): Telephone tones commonly known as “touch-tone”

dynamic IP address: An IP address that is automatically assigned by the server

Emergency Bypass Port: The fifth SB35010 Gateway jack that can provide telephone operation during a power failure when used with an analog phone

Ethernet: A type of computer networking technology that connects devices via Local Area Networks (LANs)

Extension list: A list of names and extension numbers for the Syn248 system telephones

extension number: The three-digit number representing each individual Deskset

factory default: The original product settings

FXO (Foreign Exchange Office): The Gateway telephone signaling interface between the telephone lines and the LAN

Gateway: A network device equipped for interfacing with another network that uses different protocols

greeting, preset: The voice message that plays to callers if the user has not recorded an outgoing message

grounding: An electrical ground connection that minimizes interference, reduces the risk of equipment damage due to lightning, eliminates electrostatic buildup, and helps protect people who service the equipment

hard key: Any physical key on the Deskset or Gateway. Examples include **MENU** and **1**.

hard reset: An action that restores factory default settings

Hold announcement: A recorded message to play while calls are on hold.

hub: A network hub or repeater hub is a device for connecting electronic devices, making them act as a single link

hunt group: A telephone company feature that allows calls to a busy phone number to roll over to the next available line

icon: A small picture in the display that presents status information

Idle: The mode of a device when it is not involved in call or call setup activity

Intercom call, internal call: A phone call placed from one of your Syn248 system extensions to another extension

interference: Electrical signals close by that cause degraded audio performance for cordless devices



IP address (Internet Protocol address): An individual numeric identification assigned to devices on your LAN

key beep: When enabled, pressing a Deskset key plays a tone

LAN (Local Area Network): A communications network that allows data devices to communicate with each other

LCD (Liquid Crystal Display): The screen that provides instructions and feedback

LED (Light Emitting Diode): A small light on a device that indicates status

link-local address: A local address used for network address creation when no external source of network addressing information is available

live dial: Dialing after the phone is off hook

MAC address (Media Access Control address): A unique identifier assigned to most network adapters or network interface cards that is required for registering your devices

main menu, Auto Attendant: The Auto Attendant messages and actions that are available to callers before the callers take additional actions

MDI/MDIX: (Medium-Dependent Interface Crossover): A computer networking technology

mute: Stop sending your voice to the other party during a phone call

NTP (Network Time Protocol): An Internet standard protocol that assures time synchronization in a computer network

Network Termination Unit (NTU): A device that terminates a network access point

off hook: Indicates that you are on a phone call, have lifted the corded handset, or have pressed the **SPEAKER** or **HEADSET** key to answer a call or to prepare to place a call. You are off hook from the moment that you hear a dial tone to when you hang up a call.

on hook: Indicates that no Deskset is active

operator: The extension that callers reach by dialing **0** (zero) when the Auto Attendant operator feature is enabled or that system users reach at any time by dialing **0** (zero)

outside call: A phone call between a phone not a part of your Syn248 system and an extension within your Syn248 system

P2P (Peer-to-Peer): A telecommunication system architecture in which some resources associated with a device are directly available to other similar system devices

page: Broadcasts your voice to all idle extensions that do not have Do Not Disturb turned on

paging zone: A set of extensions that can be paged as a group

Personal Directory: A private list of names and phone numbers available to only a single extension

POTS (Plain Old Telephone Service): Basic telephone operation. The ability to make and receive phone calls.

predial: Enter digits before going off hook to place a call

PSTN (Public Switched Telephone Network): The world's telephone network



Quick Dial: Provides two-touch dialing for frequently called phone numbers

reboot: Restart a device

Redial: Accesses the log of outgoing calls

router: An electronic device that connects two or more other electronic devices to each other, allowing them to communicate

soft key: The Syn248 Desksets feature keys below the LCD screen. The bottom of the LCD displays the appropriate label for each key as the function of the key changes.

static IP address: An IP address that is manually assigned to a computer by a system administrator. This type of addressing requires specific knowledge of the LAN.

subnet (subnetwork): Typically a LAN served by one router

switch: A network switch links electronic devices. The switch processes and routes data flexibly, allowing more data to be handled without error.

system administrator: A person to perform functions such as setting up and modifying system configurations. This system administrator can be an employee or your telephone equipment provider.

System Directory: (see System list)

System list: This list of names and phone numbers is created and maintained by the system administrator. All system users can sort and view this list.

system operator: The extension that callers reach by dialing **0** (zero) when the Auto Attendant operator feature is enabled or that system users reach at any time by dialing **0** (zero)

UPS (Uninterruptible Power Supply): A battery-powered emergency power supply device

URL (Uniform Resource Locator): An Internet address

VoIP (Voice over Internet Protocol): A transmission technology for delivery of voice communications over IP networks such as the Internet or other packet-switched networks. Other synonymous terms include IP telephony, Internet telephony, Voice Over BroadBand (VoBB), broadband telephony, and broadband phone.

WebUI (Web User Interface): A means of interacting with a product using a computer interface. Connection to the World Wide Web is not necessary.

