



at&t

User's manual

**AT&T SB67118 DECT 6.0
4-line corded/cordless
small business system**



Congratulations

on your purchase of this AT&T product. Before using this AT&T product, please read the **Important safety information** on pages 80-81 of this manual. Please thoroughly read this user's manual for all the feature operations and troubleshooting information necessary to install and operate your new AT&T product. You can also visit our website at **www.telephones.att.com** or call **1 (888) 915-2007**. In Canada, dial **1 (866) 288-4268**.

Model #: SB67118

Type: DECT 6.0 4-line corded/cordless small business system

Serial #: _____

Purchase date: _____

Place of purchase: _____

Both the model and serial number of your AT&T product can be found on the bottom of the telephone base.

Save your sales receipt and original packaging in case it is necessary to return your telephone for warranty service.



Telephones identified with this logo have reduced noise and interference when used with most T-coil equipped hearing aids and cochlear implants. The TIA-1083 Compliant Logo is a trademark of the Telecommunications Industry Association. Used under license.

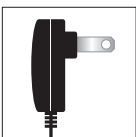

Powered by an ENERGY STAR® qualified adapter for a better environment

The ENERGY STAR® program (www.energystar.gov) recognizes and encourages the use of products that save energy and help protect our environment. We are proud to supply this product with an ENERGY STAR® qualified power adapter meeting the latest energy efficiency guidelines.

Parts checklist

Check to make sure the telephone package includes the following items:

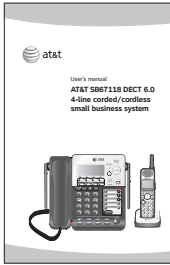

SB67118
User's manual



SB67118
Quick start guide

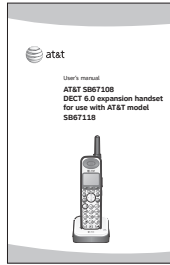

SB67108
User's manual



SB67108
Quick start guide

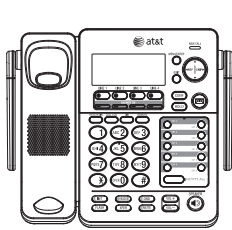

Telephone base



Corded handset



Coiled handset cord

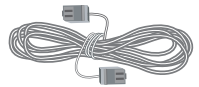

Two telephone line cords
(4-conductor)

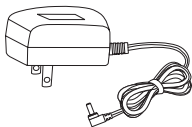

Telephone base
power adapter



Cordless handset



Battery for
cordless handset

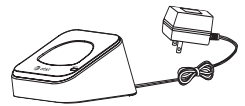

Charger for cordless
handset with power
adapter installed

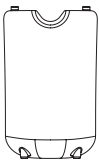

Battery
compartment
cover

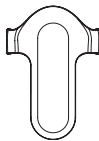

Belt clip for
cordless handset

User's manual

SB67118 DECT 6.0 4-line corded/cordless small business system



Table of contents

Getting started

Quick reference guide	1	Language	19
Installation	4	Line selection	20
Planning your system	5	Set line mode	20
Telephone base installation	6	Area codes	21
To connect the corded handset and power adapter to the telephone base	6	Hold reminder	22
To connect the telephone line cords to the telephone base	7	Set date and time	22
Optional backup battery installation	9	Music on hold (MOH)	23
Add and register handsets	10	Auto attendant setup (for answering system)	25
To register a handset to your telephone base	10	Record announcement (auto attendant)	25
Add and register a cordless headset	11	Record extension list	26
To register a cordless headset to your telephone base	11	Number of rings (auto attendant)	27
Deregister handsets and headset	13	Mailbox setup (for answering system)	28
Add a corded headset	14	Number of rings (general mailbox)	28
To add a corded headset to the telephone base	14	Record announcement (independent mailbox)	28
Optional audio cable	15	Select announcement	29
To use an audio cable	15	Mailbox setup (for general mailbox)	30
Telephone base setup	16	Set access code (remote code)	30
Menu settings	16	Call screening	30
Ringer volume	16	Notify alert	31
Volume control	17	Remaining space	32
Ringer tone	17	Speed dial setup	33
Ring group	18	Enter, edit or delete a speed dial number	33
Do not disturb (DND)	18	Customer support	33
LCD contrast	19	Screen icons, indicator tones and lights	34
Key tone	19		

Telephone base operation

Telephone base basic operation.....	36
Line indicators.....	36
Making a call.....	36
On-hook dialing (predialing).....	37
Using the speakerphone.....	37
Calling a speed dial number.....	37
Answering a call.....	38
Temporary ringer silencing.....	38
Last number redialing.....	38
Options while on calls.....	39
Volume control.....	39
Call waiting.....	39
Call privacy.....	40
Recording a call.....	40
MUTE.....	41
HOLD.....	42
Switching between lines.....	42
Join a call in progress.....	42
Chain dialing.....	43
Three-way conference calls.....	43
COVM (central office voicemail).....	45
COVM reset.....	45
Intercom.....	46
Make an intercom call to a cordless handset.....	46
Answer an intercom call.....	47
End an intercom call.....	47
Make another intercom call while on an intercom call.....	47
Answer an incoming call during an intercom call.....	47
Call transfer.....	48
Blind transfer.....	48
Transfer a call and speak to the receiving party.....	48
Answer a transferred call.....	49
Push to talk (PTT) intercom.....	50
PTT to a single handset.....	50
PTT to all handsets.....	50
Answer a PTT call.....	51
Convert PTT call to intercom call.....	51
End a PTT call.....	51

Directory

About the directory.....	52
Capacity.....	52

Exit the directory.....	52
Create directory entries.....	53
Create a new directory entry.....	53
Store a pause in a directory number.....	54
Store a flash in a directory number.....	54
Review directory.....	55
Review directory entries.....	55
Search directory.....	56
Search by name.....	56
Dial, delete or edit entries.....	57
Display dial.....	57
Delete an entry.....	57
Delete all entries.....	57
Edit an entry.....	57

Caller ID

About Caller ID.....	58
Information about caller ID with call waiting.....	58
Caller ID Information.....	59
How the caller ID information (call log) works.....	59
Caller ID operation.....	60
Memory match.....	60
Missed (new) calls indicator.....	60
Review the caller ID information..	60
Make a call log entry ready to dial.....	61
Dial a call log entry.....	61
Delete entries.....	61
Save a call log entry to the directory.....	62
Reasons for missing caller ID information.....	63

Answering system

Answering system and voicemail.....	64
Setting your system to automatically answer calls.....	65
An example of a 2-line answering system setup.....	65
An example of a 4-line answering system setup.....	66
Select the answer mode.....	66
Answering system capacity.....	66
Auto attendant operation.....	67

Turn the auto attendant on.....	67
Using the auto attendant	67
Using multiple auto attendants.....	68
Auto attendant flow chart	69
Answering system operation.....	70
Set general delivery mailbox to answer	70
Incoming messages.....	70
New message indication.....	70
Message playback.....	70
Options during playback.....	71
Delete all old messages.....	71
Transfer message	72
Recording and delivering memos.....	72
Play back a memo	73
Set general delivery mailbox to not answer.....	73
Disable the answering system.....	73
Remote access.....	74

Cordless headset

Cordless headset operation.....	76
Cordless headset extension number	76
Switch between corded or cordless handset, telephone speakerphone and cordless headset.....	76

Appendix

Telephone base display screen messages	77
Maintenance.....	79
Important safety information	80
FCC part 68 and ACTA.....	82
FCC part 15	83
Limited warranty.....	84
Technical specifications	86
Troubleshooting	87

Index

Index	95
-------------	----

Quick reference guide

LINE 1-LINE 4 keys

Press to make or answer a call on the desired line (pages 36-38).

NEW CALL indicator

On when there are unreviewed calls (page 60).

MENU/ENTER

Press to enter the menu. While in the menu, press to select an item or save an entry or setting.

Messages

When in idle mode, press to enter the general mailbox menu (page 70).

CONF

Press to add another extension or outside line to an existing call (page 43).

HOLD

Press to place an outside call on hold (page 42).

ANSWER ON keys

Press to show the automatic answer options for that line (page 66).

EXIT

While in a menu, press to cancel an operation and exit the menu display.



Navigation keys

While in menus, press ▲ or ▼ to scroll through the menus, highlight items or to change settings. Press ◀REP to return to the previous menu.

While entering names or numbers, press ◀REP or SKIP▶ to move the cursor to the left or right.

While playing back messages, press ◀REP to repeat the message, or press ◀REP twice to hear the previous message, or press SKIP▶ to skip to the next message.

Quick reference guide

CALL LOG

Press to view caller ID information (page 60).

PAUSE/REDIAL

Press repeatedly to view the last 10 numbers dialed (page 38).
While entering digits, press to insert a dialing pause (page 54).

DIR

Press to view directory information (page 55).

REMOVE

While playing a message, press to delete (page 71).
While reviewing the caller ID information, press to delete an individual entry (page 61).
While predialing, press to delete digits (page 37).

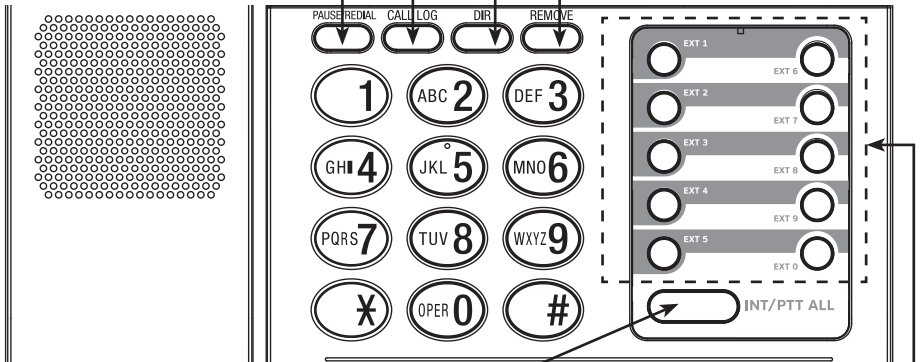

INT/PTT ALL

Press to page all extensions. An intercom connection is established with the first extension that answers (page 46).

Press and hold to broadcast to all extensions (page 50).

One-touch keys, EXT 1-0

Press to intercom with the desired cordless extension number (page 46).

Press and hold to broadcast a message to that extension (page 50).

Directory card

To write names on the directory card, follow the steps below:

1. Remove the clear plastic cover by inserting the tip of a small item such as a paperclip into the hole at the top edge of the cover.
2. Pull out the directory card.
3. Write the information on the directory card.
4. Replace the directory card and the plastic cover.

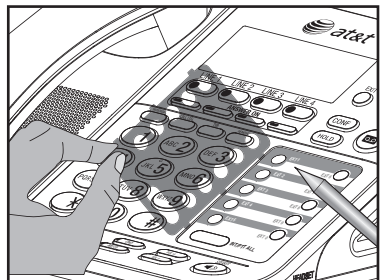

Quick reference guide

HEADSET

When a corded headset is connected to the telephone base, press to get a line, answer a call or hang up (pages 37-38). The red indicator is on when the headset is in use.

INT

When in idle mode, press to initiate an intercom call (page 46).

MUTE

During a call, press to mute the microphone (page 41). During an incoming call, press to mute the ringer (page 38).

DND (do not disturb)

Press twice to turn the feature on. Press again to turn off (page 18).

SPEAKER

Press to turn on the speakerphone. Press again to turn it off (page 37).

FLASH

During a call, press to answer an incoming call when you receive a call waiting alert (page 39).

XFER (transfer)

Press to transfer a call to an extension (page 48).
Press to transfer messages from the general mailbox to a handset mailbox (page 72).

VOL+/VOL-

During a call, press to adjust the listening volume (page 17).
During message playback, press to adjust the playback volume (page 71).

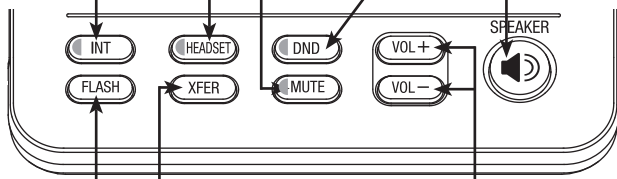

Main menu

The > symbol highlights a menu item.

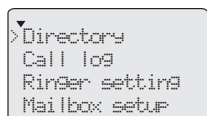

Main menu

- Directory (page 52)
- Call log (page 60)
- Ringer setting (page 17)
- Mailbox setup (page 28)
- Base setup (page 19)
- COVM (page 45)
- Speed dial setup (page 33)
- Customer support (page 33)
- Registration (page 10)

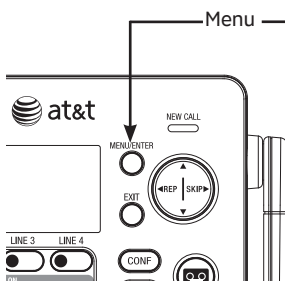

Using menus

- Press **MENU/ENTER** to show the first menu item, **Directory**.
- Press **▲** or **▼** to scroll through menu items.
- Press **MENU/ENTER** to select or save changes to a highlighted menu item.
- Press **EXIT** to cancel an operation, exit the menu display or return to the idle screen.
- Press **◀REP** to back up to the previous menu.

Installation

Install the telephone base close to a telephone jack and a power outlet not controlled by a wall switch. The telephone base should be placed on a flat surface. For optimum range and better reception, place the telephone base in a central and open location.

If you subscribe to high-speed Internet service (digital subscriber line - DSL) through your telephone lines, you must install a DSL filter between the telephone line cord and the telephone wall jack (page 7). The filter prevents noise and caller ID problems caused by DSL interference. Please contact your DSL service provider for more information about DSL filters.

Your product may be shipped with a protective sticker covering the telephone base and handset displays - remove them before use.

For customer service or product information, visit our website at **www.telephones.att.com** or call **1 (888) 915-2007**. In Canada, dial **1 (866) 288-4268**.

Avoid placing the telephone base too close to:

- Communication devices such as: television sets, VCRs, or other cordless telephones.
- Excessive heat sources.
- Noise sources such as a window with traffic outside, motors, microwave ovens, refrigerators, or fluorescent lighting.
- Excessive dust sources such as a workshop or garage.
- Excessive moisture.
- Extremely low temperature.
- Mechanical vibration or shock such as on top of the washing machine or work bench.

Planning your system

The SB67118 package includes one telephone base and one cordless handset (pre-registered at the factory). The included cordless handset has been assigned extension number 1. The system supports a maximum of four external lines, which are provided by your telephone service provider.

You can expand the system by adding up to nine more cordless handsets (AT&T model SB67108), or a combination of cordless handsets and one cordless headset (AT&T model TL7600). The system automatically assigns an extension number to each handset.

You can use a DECT 6.0 repeater (AT&T model SB67128) to extend the operating range for cordless handsets to cover areas where the signal is very weak or not available.



NOTES:

1. If you have two or three telephone lines, you will need one two-line adapter for each two lines. If you have four telephone lines, you will need two two-line adapters.
2. If your establishment has four telephone lines from one-line telephone jacks, you will need to purchase a telephone line cord (purchased at an electronics store in your area) or equivalent for each two-line adapter.
3. If you have high-speed Internet service (digital subscriber line - DSL), you need to have an external or internal DSL splitter for each telephone line installed at your location by your DSL provider.

IMPORTANT INFORMATION

For complete instructions on using the accessory cordless handset or headset, please refer to the appropriate manual.

Purchase any desired accessories:

- Cordless handsets (AT&T model SB67108)
- Cordless headset (AT&T model TL7600)
- DECT 6.0 repeater (AT&T model SB67128)
- Two-line adapters (Model 16598, part number 89-0071-00)
- Additional telephone line cords

To order these accessories or to view the manuals, visit our website at **www.telephones.att.com**, or call **1 (888) 915-2007**. In Canada, dial **1 (866) 288-4268**.

Telephone base installation

To connect the corded handset and power adapter to the telephone base

Plug the large end of the power adapter into a power outlet not controlled by a wall switch.

Raise the two antennas for optimum wireless range and performance. For greater range, add optional repeaters (AT&T model SB67128).

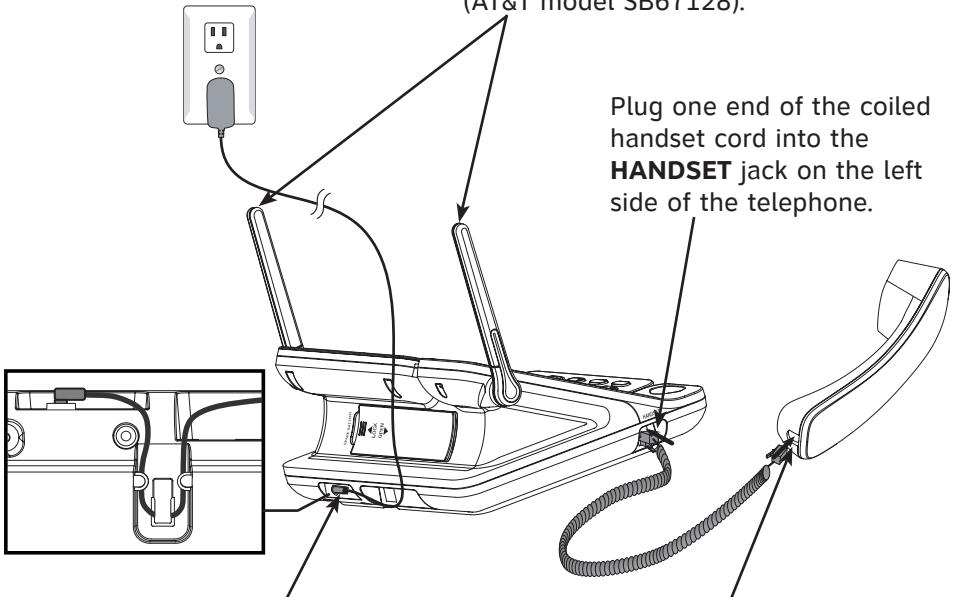

Plug one end of the coiled handset cord into the **HANDSET** jack on the left side of the telephone.

Plug the small end of the power adapter into the power jack at the bottom of the telephone base. Route the power adapter cord through the slot on the bottom of the telephone.

Plug the other end of the coiled handset cord into the corded handset.

i **NOTE:** For complete instructions on installing the cordless handset, see **Add and register handsets** on page 10 of this user's manual, refer to the AT&T SB67108 user's manual or visit www.telephones.att.com to download the manual.

IMPORTANT INFORMATION

1. Use only the power adapter supplied with this product. To order a replacement power adapter, visit our website at www.telephones.att.com, or call **1 (888) 915-2007**.
In Canada dial **1 (866) 288-4268**.
2. The power adapter is intended to be correctly oriented in a vertical or floor mount position. The prongs are not designed to hold the plug in place if it is plugged into a ceiling, under-the-table or cabinet outlet.

Telephone base installation

To connect the telephone line cords to the telephone base

If you subscribe to high-speed Internet service (digital subscriber line - DSL) through your telephone lines, you must install a DSL filter between the telephone line cord and the telephone wall jack. The filter prevents noise and caller ID problems caused by DSL interference. Please contact your DSL service provider for more information about DSL filters.

Install the telephone line cords as shown below:

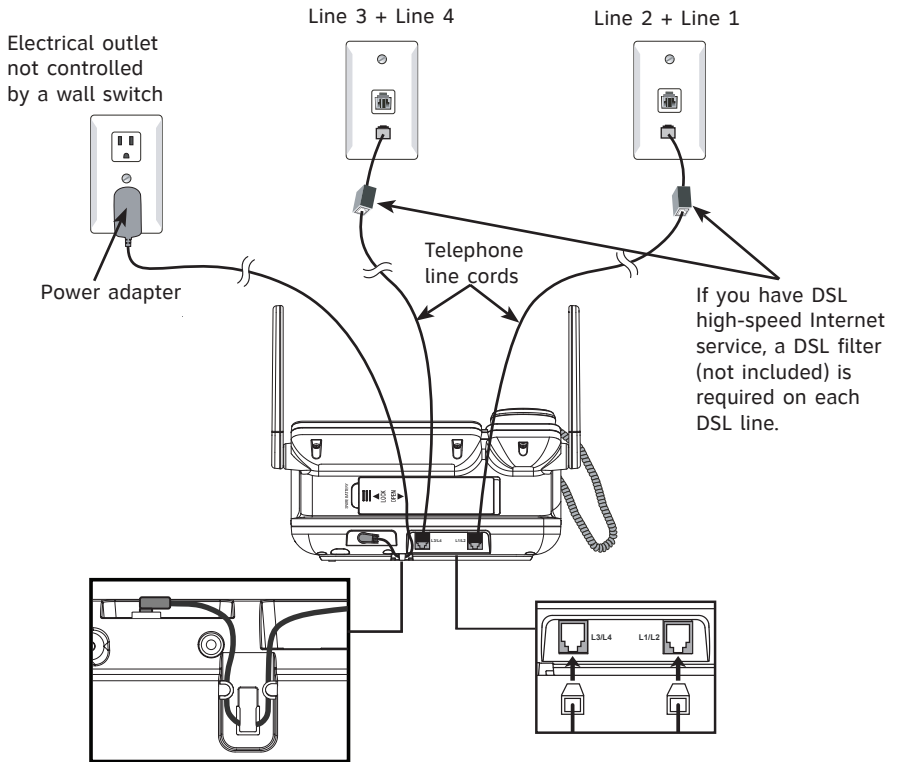

Option 1: To connect two 2-line wall jacks

Telephone base installation

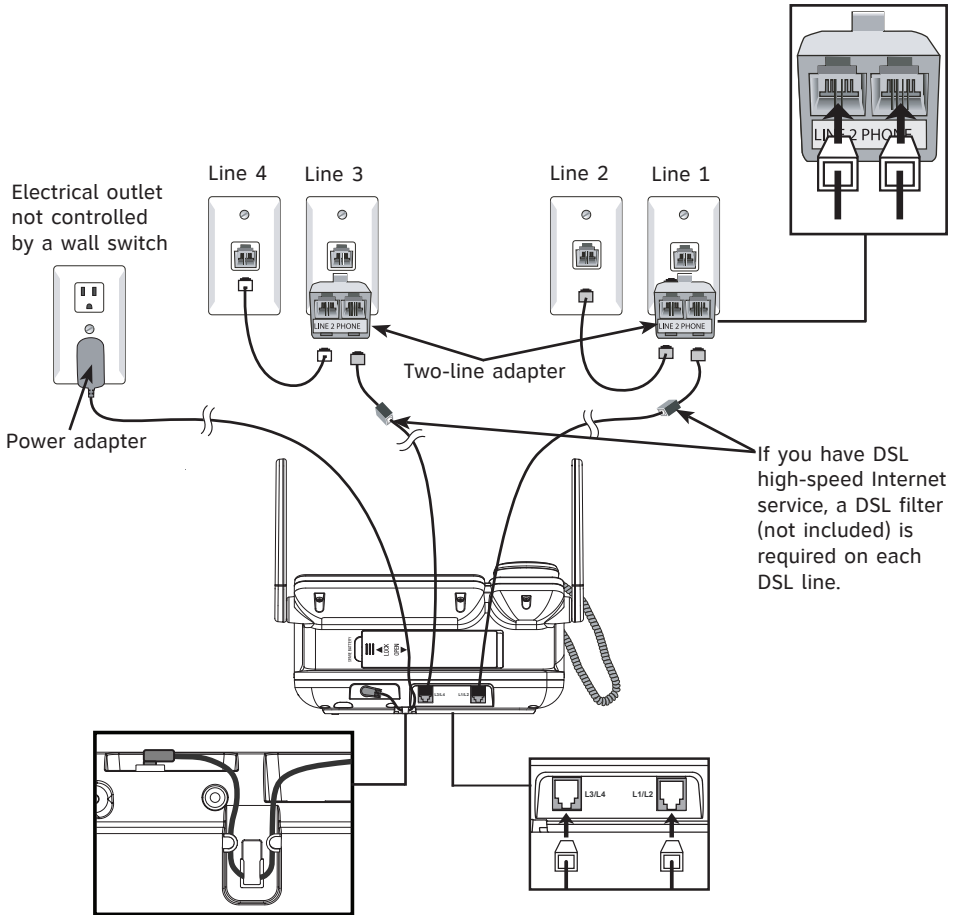

Option 2: To connect four one-line wall jacks



NOTES:

1. If you have three one-line wall jacks, you need a two-line adapter for two of the lines.
2. The long cords supplied with the telephone are four-conductor cords.
3. To order a two-line adapter (model 16598, part number 89-0071-00), visit our website at www.telephones.att.com, or call **1 (888) 915-2007**. In Canada, dial **1 (866) 288-4268**.

Optional backup battery installation

Install four AA batteries (purchased separately) to use some features of this telephone in the event of a power failure. If power fails with working batteries installed, all the lines of this telephone will work only with the corded handset. You can answer calls, and dial calls using the telephone base dial pad and the one touch or redial features. No other features will work until AC power is restored.

Install the telephone base as shown below:

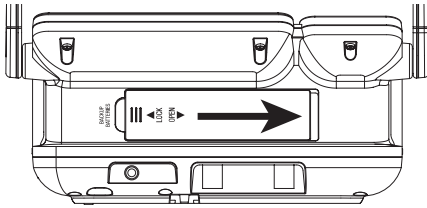

Step 1 Open the backup battery compartment cover.

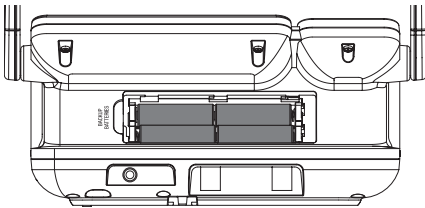
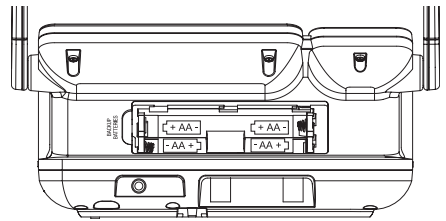

Step 2 Place the batteries in the compartment following the polarity label +/-.

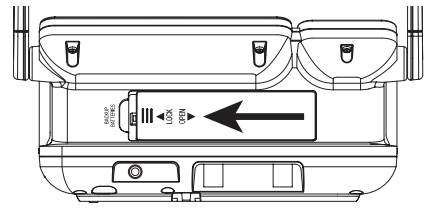

Step 3 Align the cover flat against the battery compartment, then slide it to the left until it clicks into place to lock the cover.



NOTES:

1. Use disposable AA alkaline batteries only. Do not use rechargeable batteries.
2. When there is no AC power, the screen backlight is off.

Add and register handsets

Your telephone can support up to 10 cordless handsets or nine cordless handsets and one cordless headset. You can add new handsets and headset (AT&T model SB67108 and TL7600, sold separately) to the SB67118 at any time, but each new handset or headset must be registered with the telephone base before use. You must register each handset and headset separately.

The handset provided with your SB67118 is pre-registered as **Handset 1**. Additional handsets are assigned numbers in the order they are registered (**Handset 2** to **Handset 10**).

If the handset does not have enough power to proceed with the registration, you need to charge the new handset for at least five minutes (see **Battery installation and charging** in the SB67108 cordless handset manual). Start registration when the handset screen shows **Press MENU on BS, sel Registration & sel Register HS. Then put HS in cradle.**

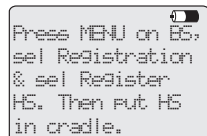

Press MENU on BS,
sel Registration
& sel Register
HS. Then put HS
in cradle.

To register a handset to your telephone base

1. Make sure the handset is out of the charger and the screen shows **Press MENU on BS, sel Registration & sel Register HS. Then put HS in cradle.** before you begin registration.
2. On the telephone base, press **MENU/ENTER**.
3. Scroll down to **Registration** and press **MENU/ENTER**.
4. Press **MENU/ENTER** again to select **Register HS**.
5. Place the unregistered handset into the cradle. The telephone base screen shows **Handset registering**. It takes up to 60 seconds to complete the registration. There is a beep sound when the registration is successful. The handset shows **Handset registered**, and then shows **X:Handset X** (**X** represents the extension number [1-0]; **Handset X** represents the default handset name).

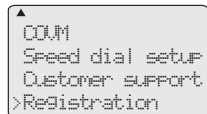

COUM
Speed dial setup
Customer support
>Registration

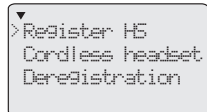

>Register HS
Cordless headset
Deregistration

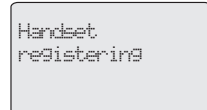

Handset
registering

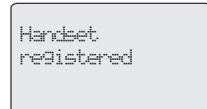

Handset
registered

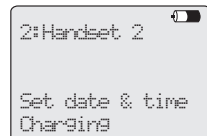

2:Handset 2
Set date & time
Charging

NOTES:

1. If the registration is not successful, the telephone base screen displays **Error**. To reset the handset, remove the handset from the cradle. Try the registration process again.
2. Please make sure to remove all unregistered system handsets or cordless headset from the cradles before registering a new handset.

Add and register a cordless headset

You can use this phone hands-free when you register a DECT 6.0 cordless headset (AT&T model TL7600, sold separately) to the telephone base. The cordless headset must have a charged battery. Make sure the headset battery is properly installed.

Place the headset in the headset charger and note the color of the **ON/OFF** button. If the button flashes a blue and orange light twice every five seconds, the headset is unregistered. If the button shows a constant blue light, the headset is registered. You need to deregister the headset before you can register it to the SB67118. See the deregistration instructions in the user's manual of the telephone to which it is currently registered. See page 76 for instructions on using the cordless headset with this telephone.

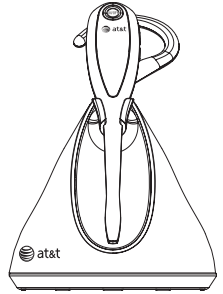

To register a cordless headset to your telephone base

1. Place the headset in the headset charger and allow it to charge for at least five minutes before beginning registration. Make sure the headset is out of the headset charger before you begin registration.
2. On the telephone base, press **MENU/ENTER**.
3. Scroll down to **Registration** and press **MENU/ENTER**.
4. Scroll down to **Cordless headset** and press **MENU/ENTER**. The telephone base screen shows **Cordless headset registering**. It takes up to 60 seconds to complete the registration.
5. Place headset into the cradle. The telephone base screen shows **Cordless headset registered** and beeps when the registration is successful.
6. Press the headset **ON/OFF** button. If you hear a dial tone and the extension  icon appears on the telephone base display, the registration was successful.

```
▲
  COVM
  Speed dial setup
  Customer support
  >Registration
```

```
▲
  Register HS
  >Cordless headset
  Deregistration
```

```
Cordless headset
registering
```

```
Cordless headset
registered
```

```
Line1 00:00:05
```

If there is no dial tone, or the **ON/OFF** light on the headset flashes twice every five seconds, the registration was not successful. Remove the headset from the headset charger and repeat the registration process again, starting with step two above.



Add and register a cordless headset

If you have a dial tone but some extension number other than 0 is on the telephone base display, then the headset is registered as a handset and will not function properly. If this is the case, you must deregister and start over, being careful to select **Cordless headset** in step four on the previous page. See **Deregister handsets and headset** on the next page.

Deregister handsets and headset

If you already have 10 registered handsets and need to replace a cordless handset, add a cordless headset (AT&T model TL7600, sold separately); or, if you wish to change the assigned extension numbers of your handsets, you must first deregister all the handsets, and then re-register each handset you wish to use. **Please read carefully through all the instructions on this page before beginning the deregistration process.** Deregistering a cordless handset does not remove the data saved on the handset.

This process deregisters all cordless handsets and any cordless headset registered to the telephone base. Please make sure the telephone system is not in use before deregistration.

1. On the telephone base, press **MENU/ENTER**.
2. Scroll down to **Registration** and press **MENU/ENTER**.
3. Scroll down to **Deregistration** and press **MENU/ENTER**.
4. The telephone base screen shows **Deregister all handsets?** **<=No >=Yes**. Press **◀REP** to exit or press **SKIP▶** to continue the deregistration.

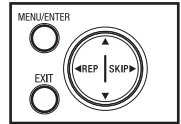
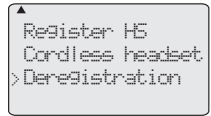
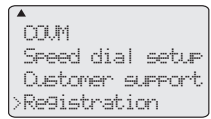

5. The telephone base screen shows **Deregistering**. It takes about 10 seconds to complete the deregistration. The screen shows **All handsets deregistered** and beeps when the deregistration is successful.

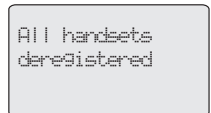
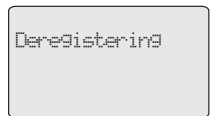
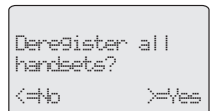

NOTES:

1. If the deregistration process is not successful, you might need to reset the system and try again. To reset: you can press **EXIT** on the telephone base. You can also reset the telephone base by unplugging the power from the telephone base and plugging it back in.
2. To re-register a cordless handset, refer to the registration information on page 10.

Add a corded headset

You can use this telephone hands-free when you install any industry-standard 2.5mm corded telephone headset (purchased separately). For best results, use an AT&T 2.5 mm corded headset. To purchase a headset, visit our website at www.telephones.att.com, or call **1 (888) 915-2007**. In Canada, dial **1 (866) 288-4268**. See page 37 for instructions on using the corded headset with this telephone.

To add a corded headset to the telephone base

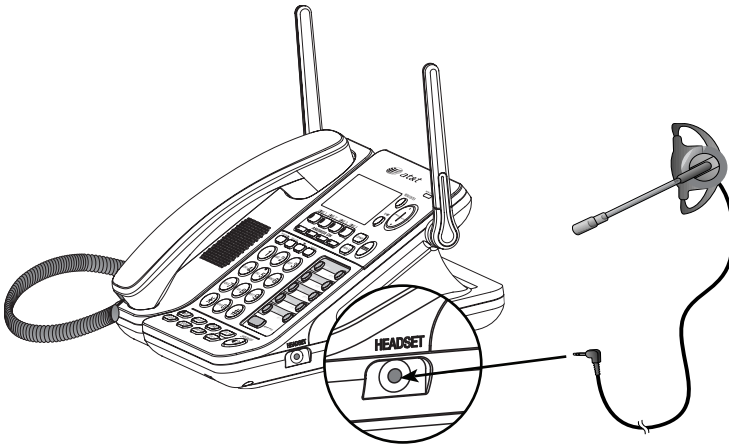

Plug a 2.5 mm headset into the **HEADSET** jack on the side of the telephone base.

Side view of the telephone base



NOTE: If you have corded and cordless headsets connected to your telephone base, the **HEADSET** button only controls the corded headset.

Optional audio cable

You can record music or an audio clip for callers to hear while their calls are put on hold from an audio device, such as a computer, CD player or radio. See the **Music on hold (MOH)** feature on page 23.

You can purchase a mono type audio cable with a 2.5mm plug on one end and a 3.5mm plug on the other at an electronics store in your area.

To use an audio cable

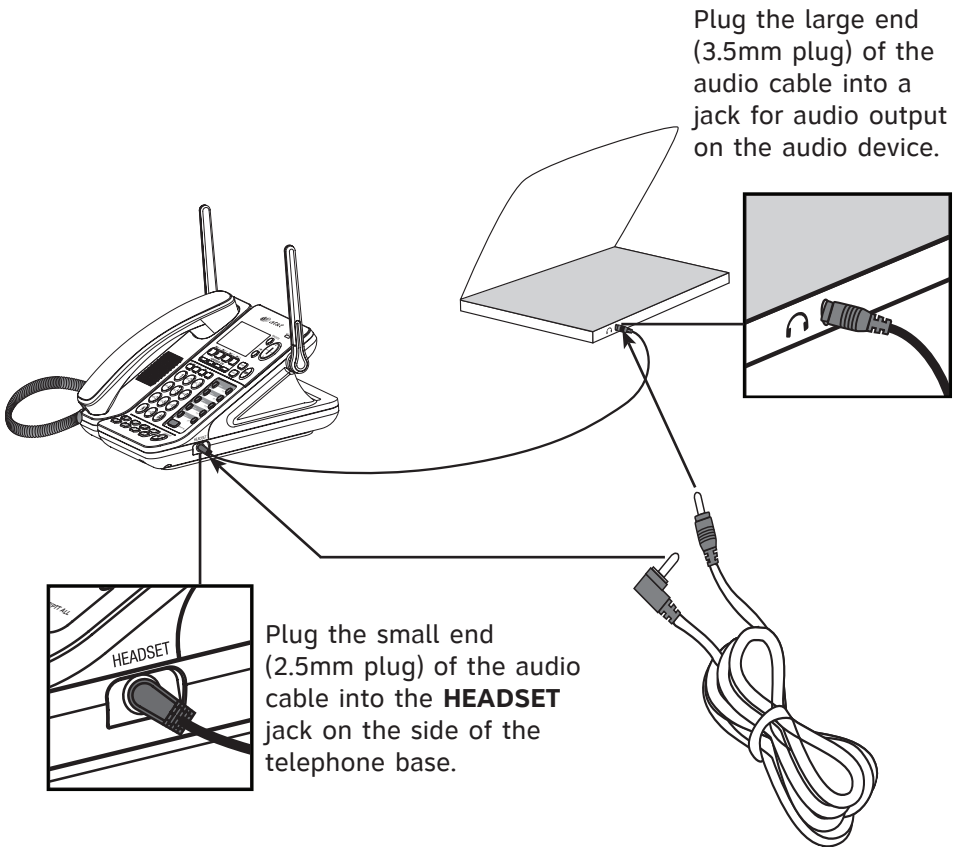

NOTE: It is the user's responsibility to comply with the copyright laws and to provide lawfully acquired music for the music on hold feature. Unlawful use of copyright protected music and/or lyrics may subject the user to fines and other legal action.

Telephone base setup

Menu settings

Use this feature to use the menus to change the telephone base settings.

1. Press **MENU/ENTER** when in idle mode (when the telephone is not in use) to enter the main menu.
2. Press **▲** or **▼** to scroll to the feature to be changed. The **>** symbol indicates the selected menu item.
3. Press **MENU/ENTER** to select the menu item.
4. Press **EXIT** to exit setup without making changes.

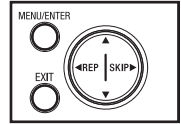

i NOTE: Press **EXIT** to cancel an operation, exit the menu display, or return to idle mode.

Ringer volume

Use this feature to set the ringer volume to one of three levels or turn the ringer off. When the ringer is off,  icon appears on the telephone base screen.

1. When the telephone is idle, press **MENU/ENTER**.
2. Press **▲** or **▼** to scroll to **Ringer setting**.
3. Press **MENU/ENTER** twice to select **Ringer volume**.
4. Press **▲** or **▼**, or **VOL+** or **VOL-** on the telephone base to adjust the ringer volume.
5. Press **MENU/ENTER** to save the setting and return to the previous menu. There is a confirmation tone. To exit without making changes, press **EXIT**.

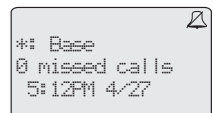
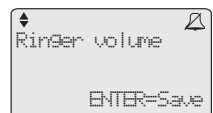
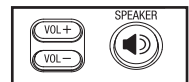
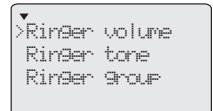
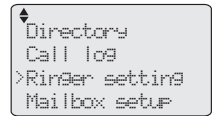

Telephone base setup

Volume control

Use this feature to independently set the listening volume to one of five levels for each of the three listening options (corded handset, speakerphone and corded headset). While using each, press ▲ or ▼, or **VOL+** or **VOL-** to adjust the listening volume.

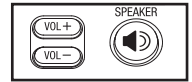

While using the volume control, you will hear a triple beep when you reach the minimum or maximum level.

The SB67118 telephone base remembers the volume setting for each listening option.

Ringer tone

Use this feature to choose one of the seven ringer tones for incoming calls. You can choose different ringer tones for different lines so you can easily identify which line is ringing.

1. When the telephone is idle, press **MENU/ENTER**.
2. Press ▲ or ▼ to scroll to **Ringer setting**. Press **MENU/ENTER**.
3. Press ▲ or ▼ to scroll to **Ringer tone**. Press **MENU/ENTER**.
4. Press ◀**REP** or **SKIP**▶ to select the desired line (**L1, L2, L3, L4**).
5. Press ▲ or ▼ to select the desired ringer tone.
6. To move to another line, press ◀**REP** or **SKIP**▶.
7. Press **MENU/ENTER** to save the setting and return to the previous menu. There is a confirmation tone. To exit without making changes, press **EXIT**.

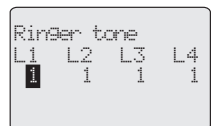
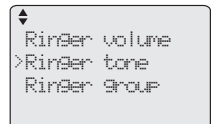
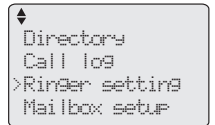

Telephone base setup

Ring group

Use this feature to specify which extensions receive incoming calls. By default, all extensions and the telephone base receive incoming calls. You can block some extensions from receiving calls, however, they can still be used to place outgoing calls.

1. When the telephone is idle, press **MENU/ENTER**.
2. Press **▲** or **▼** to scroll to **Ringer setting**. Press **MENU/ENTER**.
3. Press **▲** or **▼** to scroll to **Ring group**. Press **MENU/ENTER**.
4. Press **◀REP** or **SKIP▶** to select the desired line (**L1**, **L2**, **L3**, **L4**) while **Ring group** flashes.
5. Press **▲** or **▼**, then, while **Extension number:** flashes, press the extension number on the dial pad (***,1,2,3,4,5,6,7,8,9,0**) that you want to delete from the ring group, or press the number again to add it up to the group.
6. Press **MENU/ENTER** to save the setting and return to the previous menu. There is a confirmation tone. To exit without making changes, press **EXIT**.

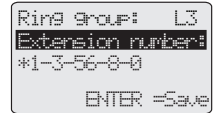
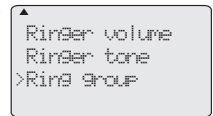

NOTE: The symbol * represents the telephone base; 0 represents extension 10.

Do not disturb (DND)

Use this feature to silence your telephone base. When you activate the do not disturb function, you will not hear paging tones, voice paging, or incoming call rings.

Instead, the **LINE 1-LINE 4** indicator flashes to signal an incoming call. If you receive an intercom call, the extension number of that intercom call appears on the screen display.

1. Press **DND** twice to prevent interruptions. The **DND** indicator turns on.
2. Press **DND** again to resume normal call alerts. The **DND** indicator turns off.

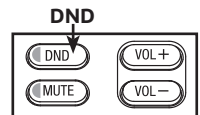

Telephone base setup

LCD contrast

Use this feature to adjust the screen contrast to one of six levels to optimize readability in different lighting conditions.

1. When the telephone is idle, press **MENU/ENTER**.
2. Press ▲ or ▼ to scroll to **Base setup**.
3. Press **MENU/ENTER** twice to select **LCD contrast**.
4. Press ▲ or ▼ to adjust the screen contrast level. The screen display temporarily fades away as you press ▼ and reappears as you press ▲.
5. Press **MENU/ENTER** to save the setting and return to the previous menu. There is a confirmation tone. To exit, press **EXIT**.

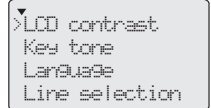

Key tone

Use this feature to turn the key tone on and off. The telephone base is factory programmed to beep with each key press. If you turn off the key tone, there are no beeps when you press keys.

1. When the telephone is idle, press **MENU/ENTER**.
2. Press ▲ or ▼ to scroll to **Base setup**. Press **MENU/ENTER**.
3. Press ▲ or ▼ to scroll to **Key tone**. Press **MENU/ENTER**.
4. Press ▲ or ▼ to scroll to **On** or **Off**.
5. Press **MENU/ENTER** to save the setting and return to the previous menu. There is a confirmation tone. To exit without making changes, press **EXIT**.

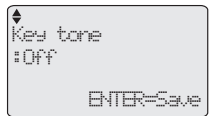
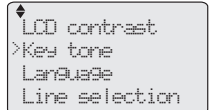
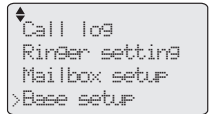

Language

Use this feature to change the display language that is used in all menus and screen displays. Set the display language on the telephone base and each extension separately. This telephone comes factory set for English displays.

1. When the telephone is idle, press **MENU/ENTER**.
2. Press ▲ or ▼ to scroll to **Base setup**. Press **MENU/ENTER**.
3. Press ▲ or ▼ to scroll to **Language**. Press **MENU/ENTER**.
4. Press ▲ or ▼ to select **English** or **Espanol**.
5. Press **MENU/ENTER** again to save the setting and return

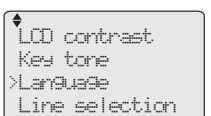
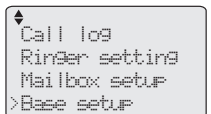

Telephone base setup

to the previous menu. There is a confirmation tone.
To exit without making changes, press **EXIT**.

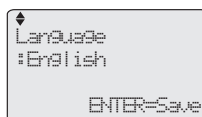

Line selection

Use this feature to select the default telephone line to be used when you make outgoing calls. This telephone comes factory set for **Auto** selectable line, which chooses the first available line for making a call. To select a particular line, choose **Line 1**, **Line 2**, **Line 3** or **Line 4**.

1. When the telephone is idle, press **MENU/ENTER**.
2. Press **▲** or **▼** to scroll to **Base setup**. Press **MENU/ENTER**.
3. Press **▲** or **▼** to scroll to **Line selection**. Press **MENU/ENTER**.
4. Press **▲** or **▼** to select **Auto**, **Line 1**, **Line 2**, **Line 3** or **Line 4**.
5. Press **MENU/ENTER** to save the setting and return to the previous menu. There is a confirmation tone. To exit without making changes, press **EXIT**.

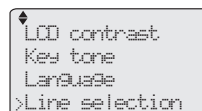
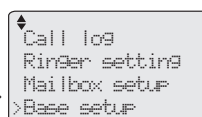

Set line mode

Use this feature to individually select the line mode for each available telephone line. For the system to behave properly, it needs to be set for:

a) **PBX** lines, which are typical business telephone systems that require you to dial **8** or **9** to get an outside line.

-OR-

b) **CO** lines, which are standard residential telephone lines.

This telephone comes factory set for **PBX** lines.

1. When the telephone is idle, press **MENU/ENTER**.
2. Press **▲** or **▼** to scroll to **Base setup**. Press **MENU/ENTER**.
3. Press **▲** or **▼** to scroll to **Set line mode**. Press **MENU/ENTER**.
4. Press **▲** or **▼** to scroll to a desired line (**L1**, **L2**, **L3**, **L4**).
5. Press **◀REP** or **SKIP▶** to select **PBX** or **CO**.
6. Press **▲** or **▼** to move to another line.

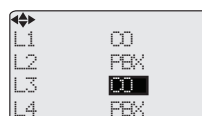
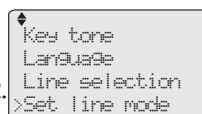
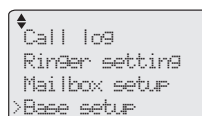

Telephone base setup

7. Press **MENU/ENTER** to save the setting and return to the previous menu. There is a confirmation tone. To exit without making changes, press **EXIT**.

Area codes

Use this feature to program this system to recognize one home area code and up to four local area codes. This feature makes it easy for you to place a call from the caller ID log.

If you dial seven digits to make a local call (no area code required), enter your area code into the telephone as the home area code. When you receive a call from within your home area code, the caller ID information only displays the seven digits of the telephone number, and when you dial from the call log, only seven digits are dialed.

If you must dial 10 digits (the area code and telephone number) for local calls, enter **000** for the home area code and enter your area code as a local area code. Then, if you receive a call from within your area code, the screen displays the 10 digits of the telephone number, and when you dial from the call log, all 10 digits will be dialed.

If you have more than one area code for your region, enter those area codes as local area codes.

1. When the telephone is idle, press **MENU/ENTER**.
2. Press **▲** or **▼** to scroll to **Base setup**. Press **MENU/ENTER**.
3. Press **▲** or **▼** to scroll to **Area codes**. Press **MENU/ENTER**.
4. Press **▲** or **▼** to scroll to **Home area** or **Local area 1-Local area 4**. Press **MENU/ENTER** to edit it.
5. Use the dial pad keys to enter a three-digit area code. Enter **000** for your home area code if you never dial seven-digit numbers. Press **◀REP** or **SKIP▶** to scroll to the digit you want to edit, or press **REMOVE** to delete digits while entering.
6. Press **MENU/ENTER** to save the setting and return to the previous menu. There is a confirmation tone. To exit without making changes, press **EXIT**.

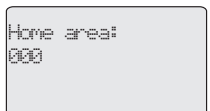
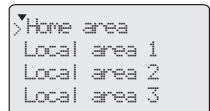
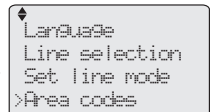
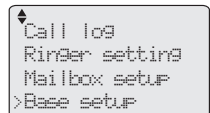

Telephone base setup

Hold reminder

Use this feature to have silence or play a beep tone every 30 seconds when there is a call on hold.

1. When the telephone is idle, press **MENU/ENTER**.
2. Press **▲** or **▼** to scroll to **Base setup**. Press **MENU/ENTER**.
3. Press **▲** or **▼** to scroll to **Hold reminder**. Press **MENU/ENTER**.
4. Press **▲** or **▼** to scroll to **On** or **Off**.
5. Press **MENU/ENTER** to save the setting and return to the previous menu. There is a confirmation tone. To exit without making changes, press **EXIT**.

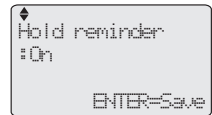
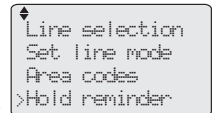

Flashing



Set date and time

The answering system displays the date and time of the message while playing messages. Before using the answering system, set the date and time as follows. If you subscribe to caller ID service, the day, month and time are set automatically with each incoming call. The year must be set so that the day of the week can be calculated from the caller ID information.

Follow the steps below to set the month, day, year and time:

1. When the telephone is idle, press **MENU/ENTER**.
2. Press **▲** or **▼** to scroll to **Base setup**. Press **MENU/ENTER**.
3. Press **▲** or **▼** to scroll to **Date and time**. Press **MENU/ENTER**.
4. Using the dial pad to enter the date. Press **◀REP** or **SKIP▶** to scroll to the item you want to edit, and press the dial pad keys to enter the correct digit.
5. Press **▼** to move to the time editing.
6. Press **▲** or **▼** to select **AM** or **PM**.
7. Press **◀REP** or **SKIP▶** to scroll to the item you want to edit, and press the dial pad to enter the correct digit.
8. Press **MENU/ENTER** to save the setting and return to the previous menu. There is a confirmation tone. To exit without making changes, press **EXIT**.

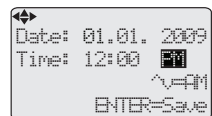
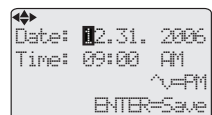
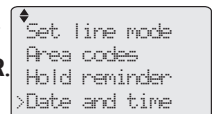

Telephone base setup



NOTES:

1. The time is in a 12-hour clock format. If you set an invalid time, you will hear an error tone while pressing **MENU/ENTER** to save the setting. The error tone means the setting cannot be saved. You need to correct the time entry to continue the setup process.
2. If the date and time are not set when a message is recorded, the system does not display date and time on the screen while playing messages.

Music on hold (MOH)

Use this feature to turn **MOH** on or off. When **MOH** is on, the system plays either pre-recorded music or your own music or message to people whom you have put on hold.

You have two options for creating your own recording to play as music on hold (up to three minutes). This recording replaces the pre-recorded music. You can use the audio cable (purchased separately) to copy a recording from an audio device, or you can record a message using the corded handset.

Turning MOH on or off:

1. When the telephone is idle, press **MENU/ENTER**.
2. Press **▲** or **▼** to scroll to **Base setup**. Press **MENU/ENTER**.
3. Press **▲** or **▼** to scroll to **Music on hold**.
4. Press **MENU/ENTER** twice to select **Music on/off**.
5. Press **▲** or **▼** to select **On** or **Off**.
6. Press **MENU/ENTER** to save the setting and return to the previous menu. There is a confirmation tone. To exit without making changes, press **EXIT**.

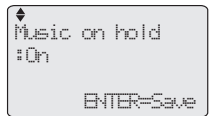
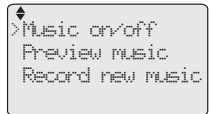
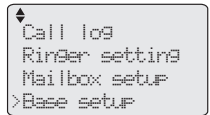

Reviewing the recording:

1. When the telephone is idle, press **MENU/ENTER**.
2. Press **▲** or **▼** to scroll to **Base setup**. Press **MENU/ENTER**.
3. Press **▲** or **▼** to scroll to **Music on hold**. Press **MENU/ENTER**.
4. Press **▲** or **▼** to scroll to **Preview music**. Press **MENU/ENTER** to hear the current recording.
5. Press **◀REP** to return to the previous menu.

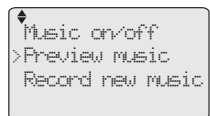

Telephone base setup

Recording music or message using an audio device:

1. When the telephone is idle, press **MENU/ENTER**.
2. Press **▲** or **▼** to scroll to **Base setup**. Press **MENU/ENTER**.
3. Press **▲** or **▼** to scroll to **Music on hold**. Press **MENU/ENTER**.
4. Press **▲** or **▼** to scroll to **Record new music**. Press **MENU/ENTER**.
5. When you are ready, start playing the music on your audio device and press **MENU/ENTER** to start recording. A timer appears on the screen and starts counting.
6. Press **MENU/ENTER** to stop recording. Then the display returns to the previous menu. To exit without making changes, press **EXIT**.

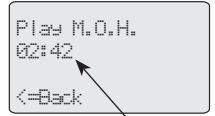

Elapsed time

Recording music or message using the corded handset:

1. When the telephone is idle, press **MENU/ENTER**.
2. Press **▲** or **▼** to scroll to **Base setup**. Press **MENU/ENTER**.
3. Press **▲** or **▼** to scroll to **Music on hold**. Press **MENU/ENTER**.
4. Press **▲** or **▼** to scroll to **Record new music**. Press **MENU/ENTER**.
5. When the screen shows **M.O.H. record ENTER=Start**, pick up the handset. When you are ready, press **MENU/ENTER** to start recording. A timer appears on the screen and starts counting.
6. Press **MENU/ENTER** to stop recording. Then the display returns to the previous menu. To exit without making changes, press **EXIT**.

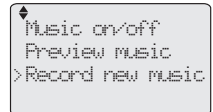

NOTES:

1. If there is silence detected for six seconds while recording, the screen display automatically returns to the previous menu. That means the recording was unsuccessful. The M.O.H. pre-recorded music plays when calls are on hold until you successfully record new music or a message.
2. After three minutes, the base stops recording, but the recording is saved. The screen returns to the previous menu.
3. If the message fails to record, try speaking louder into the corded handset or playing the volume louder on your audio device. If you are using the audio cable, ensure that it is fully plugged into the **HEADSET** jack.
4. If you want to return to the pre-recorded music on hold, record nothing for a few seconds.

Auto attendant setup (for answering system)

You can set up the auto attendant to answer outside calls, provide callers with a company directory, automatically forward calls to a specified extension, and enable callers to record voice messages when there is no answer. You can use a pre-recorded outgoing announcement or record up to five announcements of your own. For details on how to use the auto attendant feature, see the **Answering system** section on pages 64-74 of this user's manual.

Record announcement (auto attendant)

Use this feature to record up to five new announcements so that you can have different announcements for different lines, or different announcements for daytime and after hours. You can easily switch among the recorded announcements. Each announcement can be up to two minutes.

The auto attendant announcement should contain instructions for the caller. Following are example scripts.

Pre-recorded announcement: *"Hello, this is an automated attendant. Please enter your parties' extension, followed by the pound key. If you are using a rotary telephone, please stay on the line. For a company directory, dial star twice."*

If you have many extensions, record a separate extension list (page 26) and reference it in your auto attendant announcement as shown in **Sample announcement 1**. If you have only a few extensions, you can list them in the auto attendant announcement as shown in **Sample announcement 2** without the separate extension list.

Sample announcement 1: *"Hello, you have reached XYZ Corp. Please enter your parties' extension, followed by the pound key. To hear a list of extensions, dial star twice."*

Sample announcement 2: *"Hello, you have reached XYZ Corp. For sales, press 1 pound; for service, press 2 pound; for shipping, press 3 pound; or press star for the receptionist."*

1. When the telephone is idle, press **ANSWER ON** for the desired line.
2. Press **▲** or **▼** to scroll to **Setup**. Press **MENU/ENTER**.
3. Press **▲** or **▼** to scroll to **Announcement**. Press **MENU/ENTER**.
4. Press **▲** or **▼** to scroll to one of the announcements, **Announcement 1** through **Announcement 5**. If no message has been recorded, **(none)** appears. Press **MENU/ENTER**.
5. Press **MENU/ENTER** to start recording. The timer starts counting.

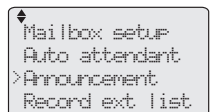

```
Mailbox setup
Auto attendant
>Announcement
Record ext list
```

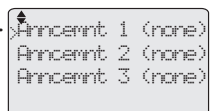

```
>Announcement 1 (none)
Announcement 2 (none)
Announcement 3 (none)
```



```
Record announcement 1
ENTER=Start
```

Auto attendant setup (for answering system)

6. Press **MENU/ENTER** to stop recording. The timer stops and the recorded announcement automatically plays back.

7. Press **2** to save the setting and return to the previous menu, or press **1** to re-record that announcement.

```
Record annrcmnt 1
00:11
ENTER=Stop
```

```
Play annrcmnt 1
00:03
1=Change 2=OK
```

-OR-

To exit without making changes, press **EXIT**.



NOTE: Once you record an announcement, **(none)** disappears.

```
↓
>Annrcmnt 1
Annrcmnt 2 (none)
Annrcmnt 3 (none)
```

Record extension list

Use this feature to record a list of your phone extensions that plays when the auto attendant answers a call and the user presses star twice. Use this auto attendant option when you do not want to list extension numbers in the initial message that callers hear.

Sample extension list: *“For sales, press 1 pound; for service, press 2 pound; for shipping, press 3 pound; or press star for the receptionist.”*

1. When the telephone is idle, press **ANSWER ON** for the desired line.

2. Press **▲** or **▼** to scroll to **Setup**. Press **MENU/ENTER**.

3. Press **▲** or **▼** to scroll to **Record ext list**. Press **MENU/ENTER**.
The current extension list plays.

```
↓
Mailbox setup
Auto attendant
Announcement
>Record ext list
```

4. Press **1** to select **Change**.

```
Record ext list
00:05
1=Change 2=OK
```

5. Press **MENU/ENTER** to start recording. The timer starts counting.

6. Press **MENU/ENTER** to stop recording. The timer stops and the recorded message automatically plays back.

```
Record ext list
ENTER=Start
```

7. Press **2** to save the setting and return to the previous menu, or press **1** to re-record the message.

```
Record ext list
00:17
ENTER=Stop
```

-OR-

To exit without making changes, press **EXIT**.



NOTE: The auto attendant and the private mailboxes share the same list of announcements.

Auto attendant setup (for answering system)

Number of rings (auto attendant)

Use this feature to set the number of times the telephone rings before the auto attendant answers. The number of rings can be between 2 and 7.

1. When the telephone is idle, press **ANSWER ON** for the desired line.
2. Press ▲ or ▼ to scroll to **Setup**. Press **MENU/ENTER**.
3. Press ▲ or ▼ to scroll to **Auto attendant**.
4. Press **MENU/ENTER** twice to select **Number of rings**.
5. Press ▲ or ▼ to select a number (**2-7**).
6. Press **MENU/ENTER** to save the setting and return to the previous menu. There is a confirmation tone. To exit without making changes, press **EXIT**.

```
Ans->Gen MB only
Ans->Auto att
No answer
>Setup
```

```
Mailbox setup
>Auto attendant
Announcement
Record ext list
```

```
Number of rings
Select anncemnt
```

```
Number of rings
#2

ENTER=Save
```

Mailbox setup (for answering system)

You can set each telephone line mailbox separately. By default, line 1 is set to have the auto attendant to answer. Lines 2, 3, and 4 are set to no answer; the answering system is disabled and any calls to those lines will ring on all extensions.

Number of rings (general mailbox)

Use this feature to set the number of times the telephone rings before the mailbox answers. The number of rings can be between 2 and 7. You can also select **Toll saver**, which is explained below. Unless you change it, the answering system answers an incoming call after four rings.

1. When the telephone is idle, press **ANSWER ON** for the desired line.
2. Press **▲** or **▼** to scroll to **Setup**.
3. Press **MENU/ENTER** twice to select **Mailbox setup**.
4. Press **MENU/ENTER** again to select **Number of rings**.
5. Press **▲** or **▼** to scroll to a number (2-7) or **Toll saver**.
 - **Toll saver** - the answering system answers a call after two rings when there are new messages, and after four rings when there are no new messages. This enables you to check for new messages without paying for a toll call.
6. Press **MENU/ENTER** to save the setting and return to the previous menu. There is a confirmation tone. To exit without making changes, press **EXIT**.

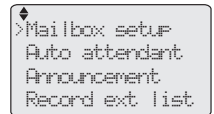

◆ Mailbox setup
Auto attendant
Announcement
Record ext list

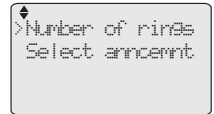

◆ Number of rings
Select annocmnt

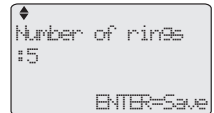

◆ Number of rings
#5
ENTER=Save



◆ Number of rings
#Toll saver
ENTER=Save

Record announcement (independent mailbox)

Use this feature to record up to five new announcements so that you can have different announcements for different lines. Each announcement can be up to two minutes. Please see **Record announcement (auto attendant)** for detail instructions on page 25.

 **NOTE:** You cannot record an announcement when the telephone system is out of space. You will hear "Memory is full." Please refer to **Remaining space** on page 32.

Mailbox setup (for answering system)

Select announcement

Use this feature to select an announcement for your independent mailbox from the list of announcements.

1. When the telephone is idle, press **ANSWER ON** for the desired line.
2. Press ▲ or ▼ to scroll to **Setup**.
3. Press **MENU/ENTER** twice to select **Mailbox setup**.
4. Press ▲ or ▼ to scroll to **Select anncemnt**. Press **MENU/ENTER**.
5. Press ▲ or ▼ to scroll to an announcement.
6. Press **MENU/ENTER** to save the setting and return to the previous menu. The selected announcement plays. To exit without making changes, press **EXIT**.

```
Mailbox setup
>Auto attendant
Announcement
Record ext list
```

```
Number of rings
>Select anncemnt
```

```
Select anncemnt
#Prerecord
ENTER=Save
```

```
Select anncemnt
#Anncemnt 1
ENTER=Save
```



NOTE: The auto attendant and the mailbox share the same list of announcements.

Mailbox setup (for general mailbox)

Set access code (remote code)

Use this feature to enter a four-digit number (0000-9999) to allow remote access to your general mailbox from any touch-tone telephone. Unless you change it, the remote access code is 0000.

1. When the telephone is idle, press **MENU/ENTER**.
2. Press **▲** or **▼** to scroll to **Mailbox setup**.
3. Press **MENU/ENTER** twice to select **Set access code**.
4. Use the dial pad to enter a four-digit number. Use **REMOVE** to backspace and delete a digit.
5. Press **MENU/ENTER** to save the setting and return to the previous menu. There is a confirmation tone. To exit without making changes, press **EXIT**.

```
Directory
Call log
Ringer setting
>Mailbox setup
```

```
>Set access code
Call screening
Notify alert
Remaining space
```

```
Enter mailbox
access code:
0000
ENTER=Save
```

```
Enter mailbox
access code:
9999
ENTER=Save
```



NOTES:

1. The access code must have four digits.
2. You will hear an error tone if you enter an access code that is already assigned.

Call screening

Use this feature to choose whether incoming messages can be heard over the speaker when they are being recorded. If you turn call screening on, you hear the incoming message.

If more than one incoming message comes from different telephone lines at the same time, only the first incoming message is monitored. While monitoring message is recording, you can answer the call by lifting the corded handset or by pressing **🔊 SPEAKER**.

You can press **VOL+** or **VOL-** to adjust the message volume. If you want to mute the message playback, press **MUTE** on the telephone base.

Follow the steps below to set the call screening feature on or off:

1. When the telephone is idle, press **MENU/ENTER**.
2. Press **▲** or **▼** to scroll to **Mailbox setup**. Press **MENU/ENTER**.
3. Press **▲** or **▼** to scroll to **Call screening**. Press **MENU/ENTER**.
4. Press **▲** or **▼** to highlight **On** or **Off**.
5. Press **MENU/ENTER** to save the setting and return to the previous menu. There is a confirmation tone. To exit without making changes, press **EXIT**.

```
>Set access code
>Call screening
Notify alert
Remaining space
```

```
>Call screening
On
ENTER=Save
```

Mailbox setup (for general mailbox)

Notify alert

Use this feature to receive notification calls to your cell telephone or paging device after each new telephone call message has been recorded to the general mailbox. You can remotely access the message from a touch-tone telephone (page 74). To receive notification calls, you must save your phone number on the telephone base, and then set the system to call that number after it finishes recording a message.

There is no message sent on the notification call. If the phone number called has caller ID service, there will be an indication of the purpose of the call. When you receive a notification call, you hear silence that lasts for about 15 seconds; then the call is ended. If no one picks up the call within three rings, the telephone base cancels the call. The system only calls the alert number once. If your paging device is busy, not available or off during the call, you may not receive the notification call.

1. When the telephone is idle, press **MENU/ENTER**.
2. Press **▲** or **▼** to scroll to **Mailbox setup**. Press **MENU/ENTER**.
3. Press **▲** or **▼** to scroll to **Notify alert**. Press **MENU/ENTER**.

```
◆
Set access code
Call screening
>Notify alert
Remaining space
```

Set alert number:

1. Press **MENU/ENTER** again to select **Alert call #**.
2. Use the dial pad to enter the number (up to 32 digits) of the telephone you want to be notified.
 - Press **REMOVE** to backspace and delete a digit.
 - Press **◀REP** or **SKIP▶** to move the cursor to the left or right.
 - Press **REMOVE** to delete the left digit.

```
>Alert call #
Alert on/off
Calling alert #
```

3. Press **MENU/ENTER** to save the setting and return to the previous menu. There is a confirmation tone. To exit without making changes, press **EXIT**.

Turn alert on or off:

1. Press **▲** or **▼** to scroll to **Alert on/off**. Press **MENU/ENTER**.
2. Press **▲** or **▼** to scroll to **On** or **Off**.
3. Press **MENU/ENTER** to save the setting and return to the previous menu. There is a confirmation tone. To exit without making changes, press **EXIT**.

```
◆
Alert on/off
:On
ENTER=Save
```

Mailbox setup (for general mailbox)

Call alert confirmation:

You can confirm whether the system can successfully call the alert number that you entered.

1. Press ▲ or ▼ to scroll to **Calling alert #**. Press **MENU/ENTER**.
2. The screen displays **Press SPKR to confirm the alert call**.
3. Press **⏮ SPEAKER** on the telephone base. You should hear the telephone number being dialed. To exit without making changes, press **EXIT**.
4. After confirming that the call went to the telephone number you specified, press **⏮ SPEAKER** again to end the test. The screen returns to idle mode.

```
↑
Alert call #
Alert on/off
>Calling alert #
```

```
Press SPKR to
confirm the
alert call
```

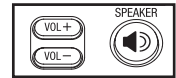

```
Calling alert #
```



NOTES:

1. If you turn on **Notify alert** before you enter the alert number, **Please set the alert #.** appears on the screen.
2. The called telephone hears silence when the system calls the alert number.
3. The system only calls the alert number once, even the call is unsuccessful. You should do the above 1-3 steps to initiate a call alert call again.

Remaining space

Use this feature to check the current system space for the estimated remaining recording time and number of messages.

1. When the telephone is idle, press **MENU/ENTER**.
2. Press ▲ or ▼ to scroll to **Mailbox setup**. Press **MENU/ENTER**.
3. Press ▲ or ▼ to scroll to **Remaining space**. Press **MENU/ENTER**.
4. After checking the screen display, press **◀REP** to return to the previous menu.

```
↑
Directory
Call log
Ringer setting
>Mailbox setup
```

```
↑
Set access code
Call screening
Notify alert
>Remaining space
```

```
Remaining space
Time: 175 min
Messages: 243
```

Speed dial setup

The telephone base has 10 speed dial locations where you can store the telephone numbers you wish to dial using fewer keys than usual. You can store up to 32 digits in each location.

Enter, edit or delete a speed dial number

1. When the telephone is idle, press **MENU/ENTER**.
2. Press **▲** or **▼** to scroll to **Speed dial setup**. Press **MENU/ENTER**.
3. Press **▲** or **▼** to choose the desired speed dial location, then press **MENU/ENTER**.
4. Use the dial pad to enter or edit the telephone number up to 32 digits. If you want to delete the entry, erase all the digits.
 - Press **◀REP** or **SKIP▶** to move the cursor to the left or right.
 - Press **REMOVE** to backspace and delete digits.
 - Press and hold REMOVE to delete all digits.
5. Press **MENU/ENTER** to save the setting and return to the previous menu. There is a confirmation tone. To exit without making changes, press **EXIT**.

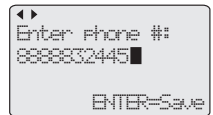
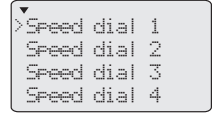
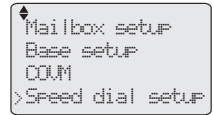

NOTES:

1. See **Calling a speed dial number** on page 37 for instructions on calling a speed dial number.
2. The memory locations for speed dial and the directory are not the same, so setting up speed dial numbers does not decrease your directory storage space.

Customer support

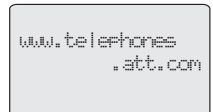
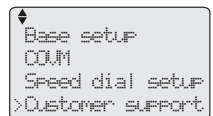

Use this feature to display the AT&T website.

1. When the telephone is idle, press **MENU/ENTER**.
2. Press **▼** to scroll to **Customer support**. Press **MENU/ENTER**.
3. To exit, press **EXIT**.



Screen icons, indicator tones and lights

Screen icons:

	On when that extension is in use.
	Ringer off - the telephone base ringer is off.
-MUTE	Microphone is muted.
-PRIV	Call privacy is on.
-REC	The call is being recorded.
Conf.	Three-way conference call is active.
COVM	There is new voicemail for the telephone line below the COVM indicator.
AuAt	Auto attendant is on for the telephone line below the AuAt indicator.
LineX	The line is in use (X is the telephone line number).

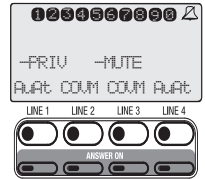

Indicator tones:

One short beep	<ul style="list-style-type: none"> The Hold reminder is active; a call has been on hold for more than three minutes. The telephone conversation recording begins. During the recording, you will hear one beep per minute.
Error tone (a triple-beep)	<ul style="list-style-type: none"> You are pressing VOL+ or VOL- when the volume has reached its highest or lowest setting. You are pressing CALL LOG when the call log is empty.
Four beeps	You cannot intercom with an extension when it is set to Privacy ON .
Fast busy beeps	The caller cancels the intercom call before the destination party answers it.
Confirmation tone	Command completed successfully.

Screen icons, indicator tones and lights

Indicator lights:

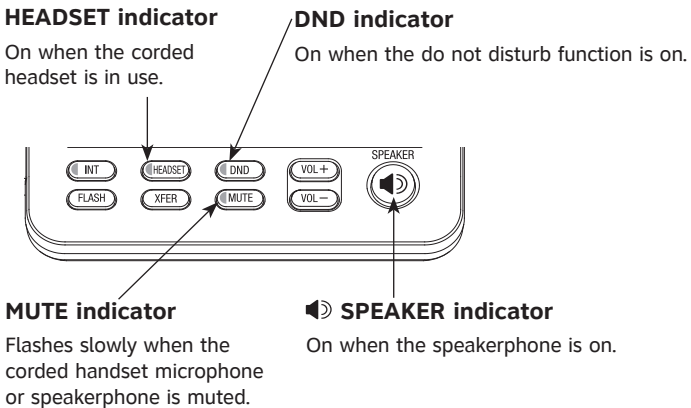
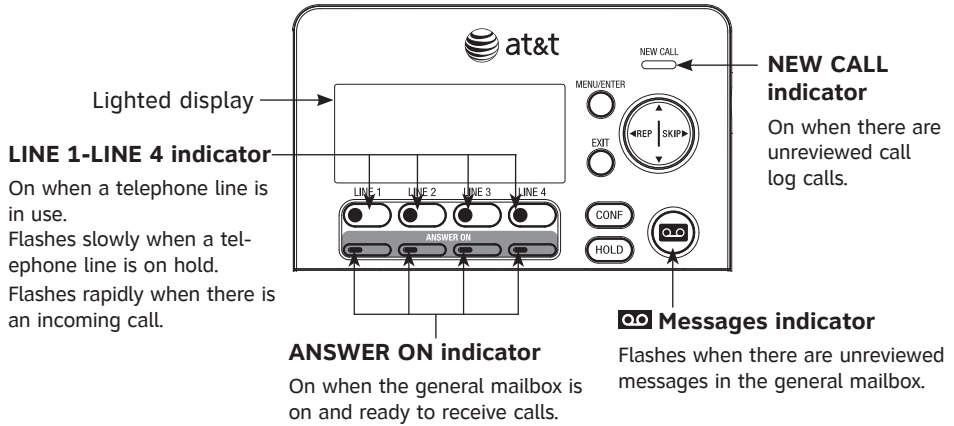

Telephone base basic operation

The telephone comes programmed to use line 1 (default primary line) for calls when you do not press a line key. (To change the primary line, see **Line selection** on page 20.) When you answer a call, the telephone automatically selects the ringing line.

Line indicators

Each of the four indicators on **LINE 1-LINE 4** indicate the state of the corresponding telephone line.

- On when the corresponding line is in use.
- Flashes slowly when the line is on hold.
- Flashes slowly when there is a transferred call on the corresponding line.
- Flashes slowly when there is an incoming auto attendant transferred call on the corresponding line.
- Flashes rapidly when there is an incoming call on the corresponding line.

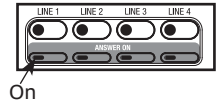

Making a call

To make a call from the telephone base:

1. Lift the handset or press **SPEAKER**.

-OR-

To override automatic line selection, press **LINE 1-LINE 4** for the desired line, then lift the handset.

2. Wait for a dial tone, then enter the telephone number.
The screen displays the elapsed time as you talk (in hours, minutes and seconds).



To end a call from the telephone base:

Place the handset on the telephone base to hang up.

-OR-

If you are using the speakerphone, press **SPEAKER** to hang up.

i NOTE: The elapsed time is not affected by accessing services from your telephone service provider.

Telephone base basic operation

To make a call with a corded headset:

Make sure a corded headset is connected to the telephone base (page 14).

1. Press **HEADSET** on the telephone base.
2. Wait for a dial tone, then dial the number.
3. To hang up, press **HEADSET**.

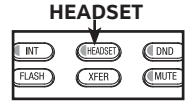

To make a call with a cordless headset:

You can make a call using a registered cordless headset and the dial pad on the telephone base.

1. Press the **ON/OFF** button on the cordless headset.
2. Wait for a dial tone, then dial the number on the base.
3. To hang up, press the **ON/OFF** button.

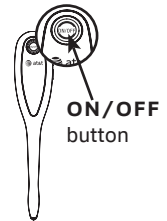

On-hook dialing (predialing)

1. Enter the telephone number. Press **REMOVE** to make corrections when entering the telephone number.
2. Lift the handset or press **SPEAKER** to dial.

-OR-

To override automatic line selection, press **LINE 1-LINE 4** for the desired line, then lift the handset.

Using the speakerphone

During a call, press **SPEAKER** to switch between hands-free speakerphone and normal handset use. Press **SPEAKER** again or place the handset on the telephone base to hang up.

Calling a speed dial number

1. Press and hold a dial pad key (**1-0**) to display the speed dial number.
2. Lift the handset, press **SPEAKER** or **HEADSET**.

-OR-

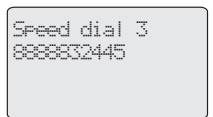

Telephone base basic operation

To override automatic line selection, press **LINE 1-LINE 4** for the desired line, then lift the handset.

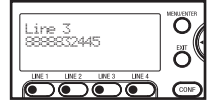

NOTE: If there is no telephone number stored in the speed dial location, **No number** displays on the screen.

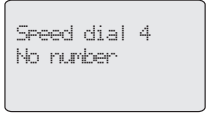

Answering a call

To answer a call:

- Lift the handset, press **SPEAKER**, **HEADSET** or the **ON/OFF** button on a registered cordless headset.

-OR-

To override automatic line selection, press **LINE 1-LINE 4** for the desired line, then lift the handset.

Temporary ringer silencing

Press **MUTE** while the telephone is ringing to silence the ringer temporarily on the telephone base only. This turns off the ringer without disconnecting the call. The next incoming call rings normally at the preset volume.

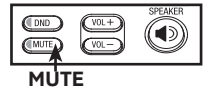

Last number redialing

The last 10 telephone numbers dialed (up to 32 digits) are stored in system memory.

To view the 10 most recently dialed numbers:

- Press **PAUSE/REDIAL** to enter the redial list and display the most recently called number.
- Press **▲** or **▼**, or press **PAUSE/REDIAL** repeatedly to view other recently called numbers.
- Press **EXIT** to exit the redial list.



To redial a number:

- To dial the displayed number, lift the handset, press **SPEAKER** or **HEADSET**.



Options while on calls

- To override automatic line selection, press **LINE 1-LINE 4** for the desired line, then lift the handset.



To edit a number:

- While the desired number displays, press **MENU/ENTER** to enter editing mode.
- Press **◀REP** or **SKIP▶** to move the cursor to the left or right. Press **REMOVE** to backspace and delete characters



To delete a number:

- While the screen displays the desired number, press **REMOVE** to delete the number from the redial memory.

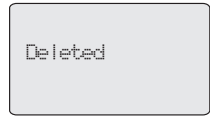

Volume control

While on a call, press **VOL+** or **VOL-** to adjust the listening volume.

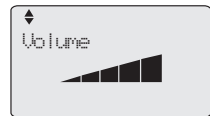

NOTES:

1. The corded headset and corded handset volume settings are the same, but they are independent volume settings from the speakerphone.
2. While using the volume control, you hear a triple beep when you've reached the minimum or maximum level.

Call waiting

If you subscribe to call waiting service with your telephone service provider, you hear a beep if someone calls while you are already on a call.

- Press **FLASH** to put your current call on hold and take the new call.
- Press **FLASH** at any time to switch back and forth between calls.

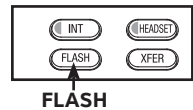

NOTES:

1. If you miss a call waiting call, the caller ID of the missed call displays for 15 seconds after the first call.
2. For more information on caller ID with call waiting, see page 58.

Options while on calls

Call privacy

To ensure call privacy, this telephone allows only one set at a time to use a line. You can also block all system handsets from joining a phone conversation (see page 42 for instructions for joining calls).

To enable call privacy:

- During the call, press **MENU/ENTER** twice to select call privacy. The screen displays **-PRIV**. Any other extensions are dropped and no extensions can join the call. If another extension tries to access the line you are using, their screen displays **Privacy**.

```
>Privacy ON
Record call ON
```

```
Line1 00:00:06
8888832445
-PRIV
```

To cancel call privacy:

- During the call, press **MENU/ENTER** twice to cancel call privacy and continue with the conversation. The icon **-PRIV** disappears from the screen. Other telephones can now join the call by pressing the appropriate line key.

```
>Privacy OFF
Record call ON
```

```
Line1 00:10:06
8888832445
```



NOTES:

1. Call privacy is automatically canceled when you end or transfer a call.
2. You cannot set call privacy during intercom or conference calls.
3. Call privacy applies only to system telephones. It does not affect on non-system phones using the same line(s).

Recording a call

Use this feature to record two-way phone conversations during a call. The recording is treated the same as memos and is always marked as a new message in the mailbox. However, the  **Messages** indicator does not flash for new and unreviewed recorded calls. You cannot record a conference call or an intercom call and you cannot use another line while you are recording a phone conversation.

To record a call:

1. While on a call, press **MENU/ENTER**.
2. Press **▲** or **▼** to scroll to **Record call ON**. Press **MENU/ENTER**.
3. The recording starts and the system activates call privacy. The screen displays **-PRIV** and **-REC**, and the timer starts counting while recording.
4. To stop recording and continue the call, press **MENU/ENTER**

```
Privacy ON
>Record call ON
```

```
Line1 00:00:06
-PRIV -REC
```

Options while on calls

twice. The system saves the conversation into the handset mailbox.



>Record call OFF

-OR-

The recording ends when you disconnect the call.

While recording a phone conversation:

The other party hears a short beep when the recording begins and once each minute during the recording. To ensure compliance with state and federal regulations regarding the recording of a telephone call, you should start the recording process by informing the caller that you are recording the call.

To play back a memo or phone conversation:

Play memos or two-way phone conversations the same way as messages (see **Message playback** on page 70).



NOTES:

1. Call privacy is automatically on when recording a call.
2. Calls that you record use the same memory as the answering system. Recording long conversations uses up space available for recording normal messages. Please see **Remaining spaces** on page 32.

MUTE

Use this feature during a telephone conversation to silence the microphone. You can hear the caller, but the caller cannot hear you.

To mute a call:

- Press **MUTE**. When mute is on, the **MUTE** light flashes; the screen also flashes **-MUTE**.

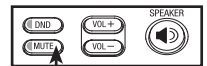

MUTE

To un-mute a call:

- Press **MUTE** again and resume speaking.

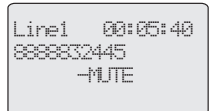

NOTE: Transferring the call, changing lines or putting a call on hold also cancels the mute function.

Options while on calls

HOLD

Use this feature to hold one line while accessing another, or as part of the conference and call transfer features.

While on a call, press and release **HOLD**. The **LINE 1-LINE 4** indicator for the line on hold flashes slowly in red. After the call has been on hold for more than three minutes, a beep sounds every 30 seconds. (To turn off the reminder beep, see **Hold reminder** on page 22).

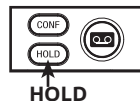

If you are using the speakerphone, the speakerphone turns off automatically when you press **HOLD**.

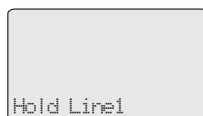

To release the hold, press and release **LINE 1-LINE 4** of the call on hold.



NOTES:

1. A call on hold after 10 minutes is automatically forwarded to auto attendant, even if the auto attendant is not activated. To keep a call on hold longer than 10 minutes, release hold within 10 minutes and then place the call on hold again.
2. You cannot put an intercom call on hold.

Switching between lines

Use this feature to switch between lines during an outside call:

1. Press **LINE 1-LINE 4** of another telephone line to make or answer another call. The current call is put on hold automatically.
2. To return to the first call, press the original **LINE 1-LINE 4**. The second line is put on hold automatically.

Join a call in progress

Use this feature to join in an ongoing call on any line that does not have call privacy set (see **Call privacy** on page 40 for more information). The corresponding line icon appears on the screen when the line is in use.

- Press and hold the desired **LINE 1-LINE 4** on the telephone base to join in the call, which becomes a three-way conference (page 43).

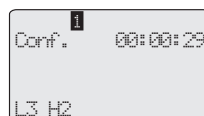

NOTE: When you try to join in an ongoing call on a line with call privacy on, the screen displays **Privacy** and you hear four beep tones.



Options while on calls

Chain dialing

While you are on a call, you can initiate a dialing sequence from the numbers in the directory.

Chain dialing can be useful if you wish to access other numbers (such as bank account numbers or access codes) from the directory.



To access the directory while on a call:

1. During the call, press **DIR**, then press ▲ or ▼ to review the directory.
2. To dial the displayed number, press **MENU/ENTER**. To exit without making changes, press **EXIT** or ◀**REP** and continue with the conversation.

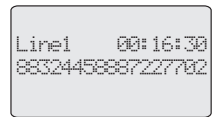
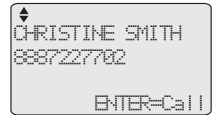

NOTE: You cannot edit a directory entry while on a call. See page 57 for more details about the directory.

Three-way conference calls

Use this feature to set up a three-party call by using two lines at the same time. You can also join an intercom call with a call on an outside line. The outside line call must be established first because an intercom call cannot be placed on hold.

To make a three-way conference call:

1. Make or answer an outside call.
2. Press **HOLD** and call someone on another line, or start an intercom connection.

-OR-

Call someone on another line, or intercom someone. The first line is automatically put on hold.

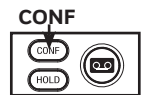
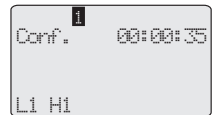

3. Press **CONF** at any time to begin the three-party conference.

To talk privately with one external party:

1. Press **HOLD** to place both lines on hold.
2. Press **LINE 1-LINE 4** to talk privately with the person on that line.
3. Press **CONF** to resume the conference call.

Options while on calls

To talk privately with one internal party:

1. Press **HOLD** to talk privately with the person on that handset. The external line is automatically placed on hold.
2. Press **CONF** to resume the conference call.

To drop one line:

1. Press **LINE 1-LINE 4** to activate the line you want to drop and place the handset on the telephone base to hang up or press **🔊 SPEAKER**. The other line is put on hold automatically.
2. Press **LINE 1-LINE 4** to resume the call and lift the handset on the telephone base.

To drop an intercom:

- Press **LINE 1-LINE 4** to activate the external call. The intercom call drops automatically.

To end a conference call:

- Place the handset on the telephone base to hang up or press **🔊 SPEAKER**. The call does not terminate until all extensions hang up.



NOTES:

1. If an internal party hangs up, the ongoing call becomes a two-way conversation.
2. You cannot make any conference calls if all four telephone lines are in use.
3. If you are experiencing difficulty in using the conference features on this telephone, please consider using AT&T's complete line of teleconference services to find a solution that best meets your needs. AT&T TeleConference Services reduces travel time and expense while increasing productivity wherever people are located, enabling you to host truly virtual meetings and share important information in real time. To sign up for AT&T TeleConference Services, go to: **www.att.com/orderconference** for details.

COVM

COVM (central office voicemail)

If you subscribe to voicemail service with your telephone service provider, turn on the **COVM** feature. This feature displays **COVM** on the screen above the line key of any telephone line that receives new voicemail messages.

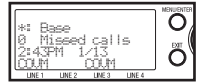

If you do not subscribe to voicemail service or want to disable the indicator, turn off the **COVM** feature.

1. When the telephone is idle, press **MENU/ENTER**.
2. Press **▲** or **▼** to scroll to **COVM**.
3. Press **MENU/ENTER** twice to select **COVM on/off**.
4. Press **▲** or **▼** to select **On** or **Off**.
5. Press **MENU/ENTER** to save the setting and return to the previous menu. There is a confirmation tone. To exit without making changes, press **EXIT**.

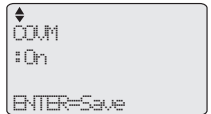
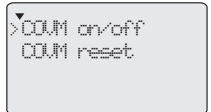
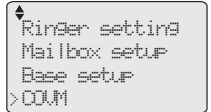

COVM reset

Use this feature when the telephone indicates there is new voicemail but there is none. For example, when you have accessed your voicemail while away from the building. This feature only turns off the **COVM** indicator; it does not delete your voicemail messages. As long as you have new voicemail messages, your telephone service provider continues to send the signal to turn on the indicator. You can reset **COVM** indicators individually or for all the telephone lines at a time using the **All COVM reset** command.

1. When the telephone is idle, press **MENU/ENTER**.
2. Press **▲** or **▼** to scroll to **COVM**. Press **MENU/ENTER**.
3. Press **▲** or **▼** to scroll to **COVM reset**. Press **MENU/ENTER**.
4. Press **▲** or **▼** to scroll to **COVM 1 reset-COVM 4 reset** to clear the **COVM** indicator of a telephone line, or scroll to **All COVM reset** to clear the indicators for all the lines at a time.
5. Press **MENU/ENTER** to execute the command and return to the previous menu. There is a confirmation tone. To exit without making changes, press **EXIT**.

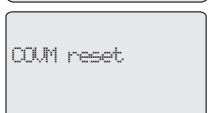
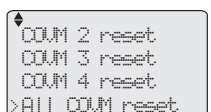
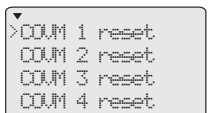
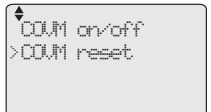

NOTE: For information about using your voicemail service, contact your telephone service provider for assistance.

Intercom

You can use the intercom feature for conversations between the telephone base and an accessory cordless handset or registered cordless headset, or between two accessory cordless handsets (one of which can be a registered cordless headset). When the system is making one or more external calls, the cordless handsets can make intercom calls with each other.

You can register up to 10 extensions to the telephone base. The extensions are cordless handsets. You can substitute a cordless headset for one of the handsets. The extensions are assigned sequential numbers (1-0) as they are added. If you register a cordless headset, it is always assigned extension number 0. See pages 10-11 for information on adding and registering cordless handsets and cordless headsets.

 **NOTE:** A telephone base connected to AC power but not to any telephone lines can still intercom with charged and registered accessory cordless handsets.

Make an intercom call to a cordless handset

Press the one-touch **EXT 1-0** key for the destination extension or press the **INT/PTT ALL** key, then lift the handset. The screen displays **Calling X:Handset X** (**X** represents the extension number [1-0], **Handset X** represents the default handset name) or **Calling All**.

-OR-

Press **INT** key on the telephone base, then scroll to the destination extension handset. Press **MENU/ENTER**.

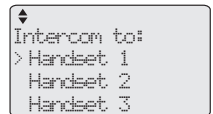

```

Intercom to:
> Handset 1
  Handset 2
  Handset 3
  
```

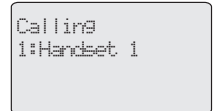

```

Calling
1:Handset 1
  
```

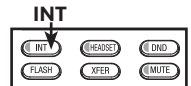

 **NOTES:**

1. Before the intercom call is answered, you can cancel the intercom by pressing  **SPEAKER**, lifting and resetting the handset, or by pressing the corresponding **LINE 1-LINE 4** to resume a call.
2. The intercom call automatically cancels if the call is unanswered after one minute.
3. Press **MUTE** to temporarily silence the intercom ringer.
4. When you choose **All** in the menu, all the extensions and the telephone base ring. The intercom call is established with the first extension to answer the call.
5. If a line is in use, pressing **INT** places the line on hold and activates the intercom.

Intercom

Answer an intercom call

When you receive an intercom call, you hear a ringing tone and your screen displays **Call X: Handset X** (**X** represents the extension number [**1-0**], **Handset X** represents the default handset name). Answer an intercom call just as you would answer a normal call.

End an intercom call

End an intercom just as you would end a normal call.

Make another intercom call while on an intercom call

You can make an intercom call to another destination extension while on an intercom call. The first intercom automatically disconnects. While on an intercom call:

Press the one-touch **EXT 1-0** key or the **INT/PTT ALL** key for another destination extension(s). The screen displays **Calling X:Handset X** (**X** represents the extension number [**1-0**], **Handset X** represents the default handset name) or **Calling All**.

-OR-

Press **INT** on the telephone base, then scroll to the destination extension. Press **MENU/ENTER**.



NOTES:

1. Before the intercom call is answered, you can cancel the intercom by pressing **⏏ SPEAKER**, lifting and resetting the handset, or by pressing the corresponding **LINE 1-LINE 4** to resume a call.
2. The intercom call automatically cancels if the call is unanswered after one minute.
3. Press **MUTE** to temporarily silence the intercom ringer.
4. When you choose **All** in the menu, all the extensions and the telephone base ring. The intercom call is established with the first extension to answer the call.

Answer an incoming call during an intercom call

If you receive an incoming outside call during an intercom call, there is an alert tone.

To answer the call, press **LINE 1-LINE 4**. The intercom call ends automatically.

Call transfer

You can transfer a call to any other system telephone. Once you transfer a call, it can be answered by any system telephone, not just at the extension you called.

Blind transfer

While on a call, you can transfer a call directly without notifying the desired extension:

1. Press **XFER** on the telephone base.
2. Press the one-touch **EXT 1-0** key for the desired extension.

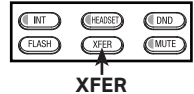

-OR-

Press **▲** or **▼** to scroll to the desired extension, then press **MENU/ENTER**.

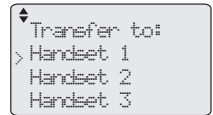

3. The current line is put on hold. The destination handset rings and the call is answered by pressing **L 1-L 4**. You hear a short tone from the telephone base. The outside call is automatically transferred to the desired extension.

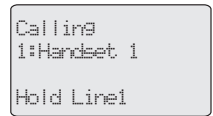

4. Put the corded handset on the telephone base or press **☎ SPEAKER** to hang up.

-OR-

You can resume the call by pressing the corresponding flashing line key **LINE 1-LINE 4** before the desired extension answers the call.

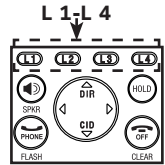

You hear a beep tone every 30 seconds when a transferred call has not been answered (To turn off the reminder beep, see **Hold reminder** on page 22).

NOTES:

1. If the desired extension does not answer the intercom call within one minute, the extension rings as an incoming call to remind the extension user.
2. If the outside call is put on hold for 10 minutes, it is automatically transferred to the auto attendant. The telephone base returns to idle mode.

Transfer a call and speak to the receiving party

You can transfer a call and speak to the receiving party before completing the transfer while on a call:

1. Press **XFER** on the telephone base.
2. Press the one-touch **EXT 1-0** key for the desired extension.

-OR-

Call transfer

Press ▲ or ▼ to scroll to the desired extension, then press **MENU/ENTER**.

3. The current line is put on hold. The destination extension rings and the call is answered by pressing **PHONE/FLASH** on the cordless handset. You can announce the call. There is an intercom call between the corded handset and the extension.
4. Put the corded handset on the telephone base or press **SPEAKER** to hang up. The outside call is automatically transferred to the desired extension.

-OR-

You can resume the call by pressing the corresponding flashing line key **LINE 1-LINE 4** before the desired extension answers the call.

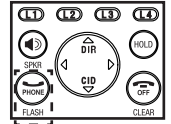
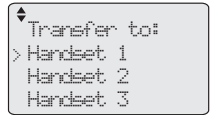

PHONE/FLASH

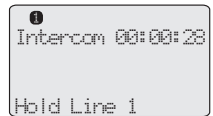

You hear a beep tone every 30 seconds when a transferred call has not been answered (To turn off the reminder beep, see **Hold reminder** on page 22).

NOTES:

1. If the desired extension does not answer the intercom call within one minute, the extension rings as an incoming call to remind the extension user.
2. If the outside call is put on hold for 10 minutes, it is automatically transferred to the auto attendant. The telephone base returns to idle mode.

Answer a transferred call

When you hear a short intercom ring from the telephone base:

Lift the handset to intercom with an extension. You can talk privately with the extension before picking up the outside call that is waiting on hold. Press the blinking **LINE 1-LINE 4** when you are ready to talk to the outside call.



Other options for answering the transferred call:

- To answer using the telephone base speakerphone, press **SPEAKER** before pressing **LINE 1-LINE 4**.
- To answer hands-free using the corded headset, press **HEADSET** before pressing **LINE 1-LINE 4**.
- To answer hands-free using the cordless headset, press **ON/OFF** on the headset before pressing **LINE 1-LINE 4**.

Push to talk (PTT) intercom

You can directly broadcast messages to the speakerphone of any extension. The extension you called can respond by pressing the **INT** key to begin a two-way communication. Any registered cordless handset can make PTT call with each other or the telephone base. Up to five pairs of PTT calls can establish at a time.

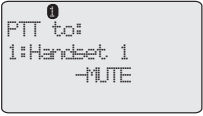
PTT to a single handset

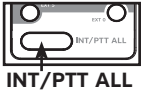
1. When the system is idle, press and hold the one-touch **EXT 1-0** key for the destination party. When the connection is made, both the caller and the destination party hear two beeps. The telephone base screen shows **PTT to: X:Handset X Release PTT key to stop** (**X** represents the extension number [1-0], **Handset X** represents the default handset name).
2. Speak into the base speakerphone while continuing to hold down the one-touch **EXT 1-0** key. Your voice is broadcast to the desired extension.
3. Release the one-touch **EXT 1-0** key after speaking. There is a three-second PTT wait state with **-MUTE** slowly flashing on the screen and the **MUTE** indicator flashing. During the PTT wait state, if necessary, you can press and hold the previous one-touch **EXT 1-0** key or the **INT/PTT ALL** key to continue speaking into the base speakerphone.
4. The destination party can now respond (see **Answer a PTT call** section in the SB67108 handset manual).

PTT to all handsets

1. When the telephone base is idle, press and hold the **INT/PTT ALL** key to automatically activate the speakerphones of all the extensions. Both the caller and the destination parties hear two beeps.
2. Speak into the base speakerphone. Your voice is broadcast to all extensions. Release the **INT/PTT ALL** key after speaking. There is a three-second PTT wait state with **-MUTE** slowly flashing on the screen and the **MUTE** indicator flashing. During the PTT wait state, if necessary, you can press and hold the **INT/PTT ALL** key to continue speaking into the base speakerphone.
3. Any extension can reply. The first extension to reply will either convert the call into a normal intercom call with the caller or start a new PTT call. See **Answer a PTT call** section in the SB67108 handset manual.

Push to talk (PTT) intercom

Answer a PTT call

1. When you hear two beeps, the screen displays **PTT from: X:Handset X** (X represents the extension number [1-0], **Handset X** represents the default handset name).
2. Press **INT** to convert the call into a normal intercom call with that extension.
-OR-

Respond with a new PTT call. Wait for the end of the three-second PTT wait state (the screen changes to idle mode) then, to respond with the telephone base, see **PTT to a single handset** or **PTT to all handsets** on the previous page. To respond with a handset, see **Answer a PTT call** in the SB67108 handset manual.



NOTE: If the PTT call is sent to all handsets, the intercom call is established with the first one who presses **INT**.

Convert PTT call to intercom call

You can convert the PTT call to a two-way intercom call on the called telephone base.

1. Press **INT** on the called extension to convert the call to a two-way intercom call.
2. Optionally, put the corded handset on the telephone base or press  **SPEAKER** to end the intercom.

End a PTT call

- Press **EXIT** to end the incoming PTT call.

About the directory

Use the directory to store names and phone numbers. Directory entries are not shared with the extensions. Each handset has its own directory.

Capacity

The directory of this telephone base can store up to 100 entries, with a maximum of 16 alphanumeric characters (including spaces) for names and 32 digits for telephone numbers. A convenient search feature can help you quickly find and dial numbers (page 56).

If there are already 100 entries, the screen shows **Memory is full**. You cannot store a new number until you delete one. If you try to view the directory entries when there are no entries, the screen displays

Directory empty.

Exit the directory

On the telephone base, press **EXIT** to cancel an operation and return to idle mode.

If you pause for too long while creating or reviewing an entry, the procedure times out and you have to begin again.

Create directory entries

Create a new directory entry

Use the following steps to store a name and number in the directory.

1. When the telephone is idle, press **MENU/ENTER** twice to select **Directory**.

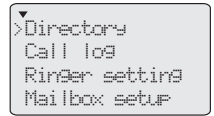

-OR-

Press **DIR** on the telephone base.

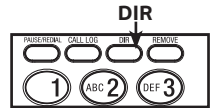

2. Press **MENU/ENTER** to add an entry.
3. Enter the telephone number (up to 32 digits) using the dial pad when prompted.

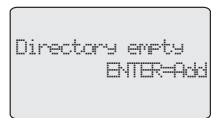

- Press **◀REP** or **SKIP▶** to move the cursor to the left or right.
- Press **REMOVE** to backspace and delete characters.
- Press and hold REMOVE to erase all digits.
- Press **PAUSE/REDIAL** to enter a 3.5 seconds dialing pause (a **P** appears) (page 54).
- Press **FLASH** to enter a flash (page 54).

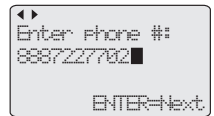

4. Press **MENU/ENTER** to save the number, then enter the name when prompted.
 - Use the dial pad to enter a name (up to 16 characters). Each time you press a key, the character on that key appears. Additional key presses produce other characters on that key. See the chart below.

Number key	Characters by number of key presses								
	1	2	3	4	5	6	7	8	9
1	&	'	()	,	-	.	/	1
2	a	b	c	A	B	C	2		
3	d	e	f	D	E	F	3		
4	g	h	i	G	H	I	4		
5	j	k	l	J	K	L	5		
6	m	n	o	M	N	O	6		
7	p	q	r	s	P	Q	R	S	7
8	t	u	v	T	U	V	8		
9	w	x	y	z	W	X	Y	Z	9
0	space	0							
*	*								
#	#								

Create directory entries

- Press **◀REP** or **SKIP▶** to move the cursor to the left or right.
 - Press **REMOVE** to backspace and delete characters.
 - Press and hold **REMOVE** to erase all characters.
 - Press **0** once to add a space.
5. Press **MENU/ENTER** to save the setting and return to the previous menu. There is a confirmation tone. The name and the telephone number appear on the screen. To exit without making changes, press **EXIT**.



Store a pause in a directory number

Use this feature to include a pause in a number stored in the directory. You might need a pause in a directory number to enable access to automated telephone systems.

- When you wish to enter a pause in the dialing sequence, press **PAUSE/REDIAL** to store a 3.5 seconds pause. A **P** appears in the telephone number. Each pause counts as one digit. If you want to save the number in the directory, press **MENU/ENTER**.

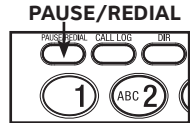

Store a flash in a directory number

Use this feature to store the flash needed to access certain custom-calling services in a directory number.

- When you wish to enter a flash in the dialing sequence, press **FLASH**. An **F** appears in the telephone number. Each flash counts as one digit. If you want to save the number in the directory, press **MENU/ENTER**.

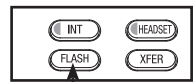

Review directory

Review directory entries

1. When the telephone is idle:

Press **MENU/ENTER** twice to select **Directory**.

-OR-

Press **DIR** on the telephone base.

If there are no directory entries, the screen displays **Directory empty**.

2. Press **▲** or **▼** to browse through the directory. Entries appear alphabetically by the first letter in the name.

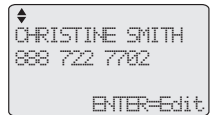
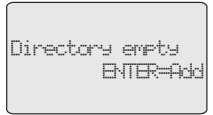
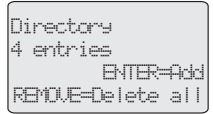

Search directory

Search by name

Follow the steps below to search for directory entries on the telephone base.

1. When the telephone is idle, press **MENU/ENTER** twice to select **Directory**.

-OR-

Press **DIR** on the telephone base.

2. Press **▲** or **▼** browse through the directory.

3. When a name appears, press the dial pad keys (**2-9**) to start a name search.



- The directory shows the first name beginning with the first letter associated with the dial pad key if there is an entry in the directory beginning with that letter. If there is no entry matching the letter you press, it remains in the current entry.

4. To see other names starting with the letters on the same dial pad key, keep pressing the key. The names appear in alphabetical order.

For example, if you have the names **Jennifer**, **Jessie**, **Kevin** and **Linda** in your directory:

- If you press **5 (JKL)** once, you see **Jennifer**.
- If you press **5 (JKL)** twice, you see **Kevin**.
- If you press **5 (JKL)** three times, you see **Linda**.
- If you press **5 (JKL)** four times, you see **Jennifer**.
- To view **Jessie**, press **▼** while **Jennifer** is displayed.

Dial, delete or edit entries

You can dial, delete or edit a directory entry (name and number) when it is shown on the telephone base screen. You can use the directory review or search (pages 55-56) to show an entry.

Display dial

When a number is displayed on the screen you can dial the number by lifting the corded handset, pressing **SPEAKER** or **LINE 1-LINE 4** for the desired line.

Delete an entry

When a directory entry appears, press **REMOVE** on the telephone base to delete the displayed entry from the directory. You cannot retrieve a deleted entry.

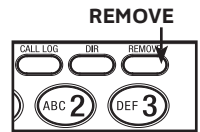

Delete all entries

1. When the telephone is idle, press **MENU/ENTER** twice to select **Directory**.

-OR-

Press **DIR** on the telephone base.

2. Press **REMOVE** and the screen displays **Delete entire directory?** **<=No >=Yes**. Press **SKIP▶** to confirm or press **◀REP** to return to the previous screen.

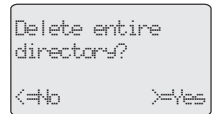

NOTE: You cannot retrieve deleted entries.

Edit an entry

1. When a directory entry appears, press **MENU/ENTER**.

2. Follow steps 3 to 5 on pages 53-54.



NOTE: If the telephone number in the directory exceeds 16 digits, **<** appears in front of the telephone number in the editing screen. Press **◀REP** to move towards the beginning of the telephone number or press **▶REP** to move towards the end of the telephone number.

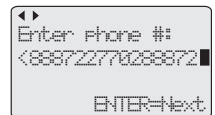

About Caller ID

This telephone supports caller ID services that most telephone service providers offer. Depending on your service subscription, you might see the caller's number, or the caller's name and number from the telephone service provider after the first or second ring. Caller ID allows you to see the name, number, date and time of calls.

Information about caller ID with call waiting

Caller ID with call waiting lets you see the name and telephone number of the caller before answering the telephone, and while on another call.

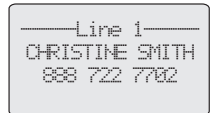

There are fees associated with caller ID services. In addition, this service might be called by different names (such as caller ID with visual call waiting) by different telephone service providers and might not be available in all areas.

It might be necessary to change telephone service to use this feature. Contact your telephone service provider if:

- You have both caller ID and call waiting, but as separate services (you might need to combine these services)
- You only have caller ID service, or only call waiting service.
- You do not subscribe to caller ID or call waiting services.

This product can provide information only if both you and the caller are in areas offering caller ID service and if both telephone service providers use compatible equipment. The time and date are from the telephone service provider along with the call information.

Caller ID information might not be available for every incoming call. Callers may intentionally block their names and/or telephone numbers.

NOTES:

1. You can use this telephone with regular caller ID service, or you can use this telephone's other features without subscribing to caller ID or combined caller ID with call waiting service.
2. The format of telephone numbers displayed depends on the home and local area codes you set (See **Area codes** on page 21 for explanations and instructions for setting of area codes).

Caller ID Information

How the caller ID information (call log) works

The telephone stores caller ID information for the last 50 incoming calls in the telephone base. Entries are stored in reverse chronological order. The telephone deletes the oldest entry when the log is full to make room for new calls.

Each extension has an independent caller ID information. Deleting the caller ID information on any one extension does not affect the caller ID information on other extensions.

If you answer a call before the information appears on the screen, it does not show in the caller ID information.

Review the caller ID information to determine who called, to easily return the call, or to copy the caller's name and number into your directory.

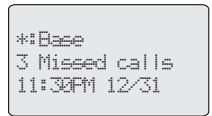

NEW CALL indicator turns on and **XX Missed call(s)** appears if there are new call log entries (including missed and unreviewed calls).



The time and date of the call and the caller's name and telephone number are included in the display.

Caller ID information appears on the screen as the telephone rings, or until the caller hangs up, or until the call has been answered at another extension, or until the call ends.

If you subscribe to caller ID service, this phone automatically resets the time and date each time new call information is received. You can also set the time and date yourself (see **Set date and time** on page 22).

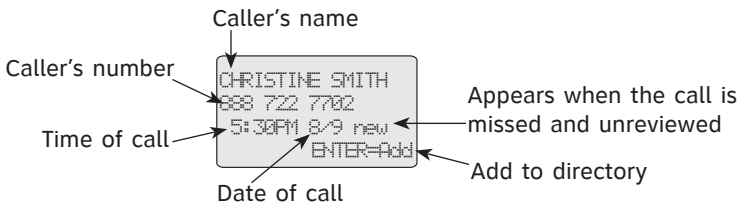

Screen display of the telephone base

NOTES:

1. The caller ID information might not be available for every incoming call. Callers might intentionally block their names and/or telephone numbers.
2. Each entry can store up to 32 digits for the telephone number and 16 characters for the name. If the telephone number has more than 16 digits but less than or equal to 24 digits, only the last 17 digits appear. If the telephone number has more than 24 digits, only the 8th to 24th digits (17 digits) appear. In order to view the entire number, you must first save the entry to the directory (see page 62). For instructions on viewing the digits, see page 60. If the telephone number has more than 32 digits, it is not saved or shown in the call log.

Caller ID operation

Memory match

If the incoming telephone number is an exact match with a telephone number in your directory, the name that appears on the screen matches the corresponding name in your directory.

For example, if Christine Smith calls, her name appears as Chris if this is how you entered it into your directory.

i NOTE: The number you see on your caller ID is in the format from the telephone service provider. It usually delivers 10-digit telephone numbers (area code plus telephone number). The telephone system ignores the area code when searching for a match and displays the name of the first corresponding number from the directory.

Missed (new) calls indicator

When the telephone base is in idle mode and has unreviewed calls, its screen shows **XX Missed call(s)**.

All unreviewed entries are counted as missed calls. Each time you review a call log entry with the icon **NEW**, the number of missed calls decreases by one. When all the entries in the caller ID information become old (have been reviewed), the system removes the missed calls alert from the display, and the **NEW CALL** indicator turns off.

CHRISTINE SMITH
688 722 7782
5:38PM 8/9 new
ENTER=Add

*: Base
0 Missed calls
6:00PM 8/9

Review the caller ID information

1. When the telephone is idle, press **CALL LOG**.

-OR-

When the telephone is idle, press **MENU/ENTER**. Press **▲** or **▼** to scroll to **Call log**. Press **MENU/ENTER**.

2. Press **▲** or **▼** to review the caller ID information. The caller ID information displays the caller ID entries in reverse chronological order starting with the most recent call first.

3. To exit without making changes, press **EXIT**.

CALL LOG
PULSE-RING CALL LOG DIR REMOVE
1 ABC 2 DEF 3

Directory
>Call log
Ringer setting
Mailbox setup

Caller ID operation

Make a call log entry ready to dial

Although the incoming call log entries have 10 digits (the area code plus the seven-digit number), in some areas, you may only need to dial the seven digits, 1 plus the seven digits, or 1 plus the area code plus the seven digits. You can change and store the number of digits that you dial in the call log.

While reviewing the call log, press the pound key (#) repeatedly on the telephone base to show different dialing options for local and long distance numbers before dialing or saving the telephone number in the directory.

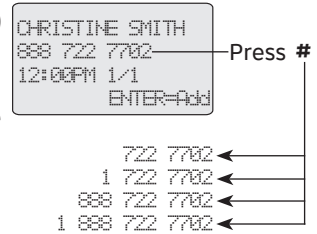

Dial a call log entry

1. When in the call log, press ▲ or ▼ to browse the number you wish to call.
2. Lift the handset or press **◀ SPEAKER**.

-OR-

To override automatic line selection, press **LINE 1-LINE 4** for the desired line, then lift the handset.

Delete entries

Delete a caller ID entry:

1. When in the call log, press ▲ or ▼ to browse to the number you wish to delete.
2. Press **REMOVE** to delete the shown entry from the caller ID information.

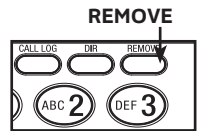

Delete all caller ID entries:

1. When the telephone is idle, press **CALL LOG**.

-OR-

When the telephone is idle, press **MENU/ENTER**. Press ▲ or ▼ to scroll to **Call log**. Press **MENU/ENTER**.

2. Press **REMOVE**. The screen displays **Delete all calls?** Press **SKIP▶** to clear the caller ID information of all entries, or press **◀REP** to exit and leave all entries in the caller ID information intact.

3. To exit without making changes, press **EXIT**.

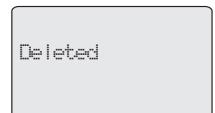
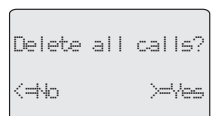
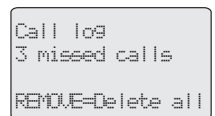

Caller ID operation

Save a call log entry to the directory

1. When in the call log, press ▲ or ▼ to browse the desired number to save.
2. The screen displays **ENTER=Add**. Press **MENU/ENTER**.

```
CHRISTINE SMITH
1 888 722 7702
12:00PM 1/1
ENTER=Add
```

3. When the telephone number appears,

- Press the dial pad keys to add digits (page 53).
- Press **REMOVE** to erase digits.
- Press and hold REMOVE to erase all digits.
- Press ◀**REP** or **SKIP**▶ to move the cursor to the left or right.

```
◀▶
Enter phone #:
18887227702█
ENTER=Next
```

4. Press **MENU/ENTER** to move to the name.

- Press the dial pad keys to add characters (page 53).
- Press **REMOVE** to erase characters.
- Press and hold REMOVE to erase all characters.
- Press ◀**REP** or **SKIP**▶ to move the cursor to the left or right.
- Press **0** once to enter a space.

```
◀▶
Enter name:
CHRISTINE SMITH█
ENTER=Save
```

5. Press **MENU/ENTER** to save the new directory entry. There is a confirmation tone. The name and the telephone number appear.

```
CHRISTINE SMITH
1 888 722 7702
```

- If the entry is already saved in the directory, the screen display remains the same and waits for more editing.
- If there is no caller ID information, you hear an error tone. The number is unable to save.

-OR-

To exit without making changes, press **EXIT**.

 **NOTE:** You will need to change how a caller ID number is dialed if the entry does not appear in the correct format. Caller ID numbers might appear with an area code that might not be necessary for local calls, or without a 1 that might be necessary for long distance calls (see **Make a call log entry ready to dial** on page 61 for more information).

Reasons for missing caller ID information

Reasons for missing caller ID information

There are also occasions when other information or no information shows for various reasons:

On-screen message	Reason
PRIVATE CALLER	The caller prefers not to show the telephone number and name.
UNKNOWN CALLER	Your telephone service provider cannot determine the caller's name and telephone number. Calls from other countries may also generate this message.

Answering system and voicemail

Your telephone has separate indicators for two different types of voice messages: those left on its built-in answering system and those left at your service provider's voicemail (fees may apply). Your telephone's built-in answering system messages and voicemail messages are separate. Each alerts you to new messages differently. If you turn on the **COVM** feature (See **COVM** on page 45 for more information.) and the **COVM** icon displays on the base screen, your telephone service provider is indicating that it has new voicemail for you. To listen to your voicemail, you typically dial an access number provided by your telephone service provider, followed by a security code or PIN. To listen to messages recorded on your digital answering system, press  **Messages** on the telephone base.

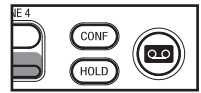
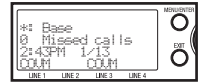

Some service providers bundle or combine multiple services like voicemail and call waiting, so you may not be aware that you have voicemail. To check what services you have and how to access them, contact your telephone service provider.

You can use your telephone answering system and voicemail together by setting your built-in answering system to answer before voicemail answers. To learn how to program your voicemail settings, contact your telephone service provider. Set your answering system to answer calls at least two rings earlier than your voicemail is set to answer. For example, if your voicemail answers after six rings, set your answering system to answer after four rings. Some voicemail providers may program the delay before answering calls in seconds instead of rings; in this case, allow six seconds per ring when determining the appropriate setting. By doing this, if you are on a call, or if the answering system is busy recording a message and you receive another call, the second caller can leave a voicemail message.

Setting your system to automatically answer calls

Use this feature to separately set each of the four lines to automatically answer incoming calls in two different ways.

General mailbox (gen MB only):

The called line rings on every extension for each incoming call. If there is no answer, the caller is prompted to leave a message in the general mailbox, which a person at any handset can review. The general mailbox stores incoming messages, memos, and two-way conversations (see **Answering system operation** on pages 70-74 for more information.)

Auto attendant (auto att):

The called line for each incoming call flashes on every extension, but does not ring. Instead, the auto attendant answers. The caller can specify an extension or leave a general mailbox message. When the auto attendant directs a call to an extension but it is not answered, the auto attendant prompts the caller to leave a message for that extension or try another extension.

The auto attendant can answer only one call at a time, so you might want to have more than one auto attendant in your system so that even when a call on one line is being answered, a second auto attendant can answer another ringing line. You can designate up to four auto attendants in your system (see **Auto attendant operation** on pages 67-69 for more information.)

No answer:

You can disable automatic answering on any of the telephone lines.

An example of a 2-line answering system setup

If you have two phone lines and two or more extensions and you wish to use the auto attendant, then configure both lines to use the auto attendant. Then, if a call comes in while one line is busy, it will still be answered by the auto attendant.

Line 1 : Auto attendant (2 rings)

Line 2: Auto attendant (2 rings)

Setting your system to automatically answer calls

An example of a 4-line answering system setup

If you have four phone lines and many extensions, you can set up to the auto attendant to answer up to three simultaneous calls. You can set up the fourth line to ring as a private direct line to a single extension by excluding all others in the **Ring group** (page 18).

Line 1 : Auto attendant (2 rings)

Line 2: Auto attendant (2 rings)

Line 3: Auto attendant (2 rings)

Line 4: General mailbox (4 rings, all but one extension excluded)

Select the answer mode

1. When the telephone is idle, press **ANSWER ON** for the desired line.
2. Press **▲** or **▼** to scroll to the desired answer mode (**Ans->Gen MB only**, **Ans->Auto att**, or **No answer**). Press **MENU/ENTER** to select the mode. To exit without making changes, press **EXIT**.

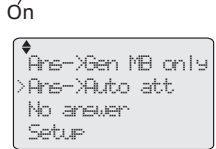

Answering system capacity

You can record up to five new announcements to have different announcements for each line. Each announcement can be up to two minutes.

Auto attendant and general mailbox announcements both require system memory to record, so we suggest recording brief announcements in order to leave more space for messages.

The maximum recording time of all handsets and base is 180 minutes. The actual recording time depends on individual message characteristics. Individual messages can be up to three minutes. Messages remain available for review until you delete them.

If the system memory is full, the screen displays **Message full**, and you cannot record new messages until old ones have been deleted. Check remaining system space frequently to keep maintain availability of space for incoming messages.

i **NOTE:** You cannot record an announcement when the telephone system is out of space. You will hear a two-beep alert tone and voice prompt "Memory is full." Please refer to **Remaining space** on page 32.

Auto attendant operation

Turn the auto attendant on

1. When the telephone is idle, press **ANSWER ON** for the desired line to set up.
2. Press **▲** or **▼** to scroll to **Ans->Auto att.**
3. Press **MENU/ENTER** to turn on the auto attendant. The current auto attendant announcement plays. The screen displays **Auto Attendant ON Play announcement** with voice prompt *“Hello, this is automatic attendant,”* and then the idle screen appears.

-OR-

Press **▲** or **▼** to scroll to **No answer** to turn the auto attendant off. Press **MENU/ENTER** to turn off the auto attendant feature for that line.

To exit without making changes, press **EXIT**.



NOTES:

1. The auto attendant only answers outside calls.
2. The auto attendant does not answer calls when that line is in use.
3. You can press **VOL+** or **VOL-** to adjust the announcement playback volume.

Using the auto attendant

When you set a line to be an auto attendant, it automatically picks up the ringing line after the number of rings you programmed (see **Number of rings** on page 27), and plays your selected auto attendant announcement.

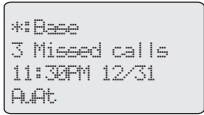

While the line silently rings, and while the auto attendant is answering and directing a call, the line indicator flashes (page 36). To interrupt the auto attendant, press the flashing line indicator **LINE 1-LINE 4** or **L 1-L 4** to talk to the caller on that line. You can also allow the auto attendant to answer the incoming call while you make a new call on another line.

When a caller enters a correct extension number, the auto attendant transfers the call to that extension and announces to the caller, *“Please wait.”* If the called extension does not answer, the caller is prompted to try another extension or leave a message in a private mailbox for the last attempted extension. The auto attendant attempts to transfer the call up to five times.

If the caller enters an extension number plus the pound key (#) after hearing the announcement, the auto attendant transfers the call to the specified extension. If the call is not picked up after five rings, the caller

Auto attendant operation

hears *"No one is available to answer the call. To leave a message press 1, to call another extension press 2, to call the operator press star."* and waits five seconds for another entry from the caller. If the caller still hasn't entered an extension number after hearing this message three times, the auto attendant forwards the call to the general mailbox to leave a message.

If the caller enters an invalid extension number, the auto attendant announces, *"Please wait, this number is not assigned. To leave a message, press 1, to call another extension, press 2, to call the operator, press star."*

If the caller enters the star key (*) plus the pound key (#), the auto attendant announces *"Calling the operator,"* and then transfers the call to the telephone base.

If the caller enters the remote access code while hearing the announcement, the auto attendant stops playing the announcement and the caller can remotely access the general mailbox (See **Remote access** on page 74 for information).

If the caller does not enter any number after hearing the announcement, the auto attendant announces three times *"Please enter your party's extension, followed by the pound key. If you are using a rotary telephone, please stay on the line. For a company directory, dial star twice."* Then the auto attendant transfers the call to the general mailbox for the caller to leave a message.

Using multiple auto attendants

Use this feature to set one or more telephone lines to act as auto attendants when the primary auto attendant is turned off or busy.



An auto attendant is busy when someone at that extension is doing any of the following:

- dialing from the directory or call history
- using any of the lines to make or answer a call
- when the answering system is recording a message at that extension

You can choose a particular telephone line to always be the primary auto attendant by setting that line to have the shortest auto attendant pickup delay (number of rings) and setting the pickup delays of other auto attendants with a longer pickup delay (more rings). If the auto attendant pickup delays are the same, incoming calls are distributed randomly to the auto attendants.

Auto attendant operation

Auto attendant flow chart

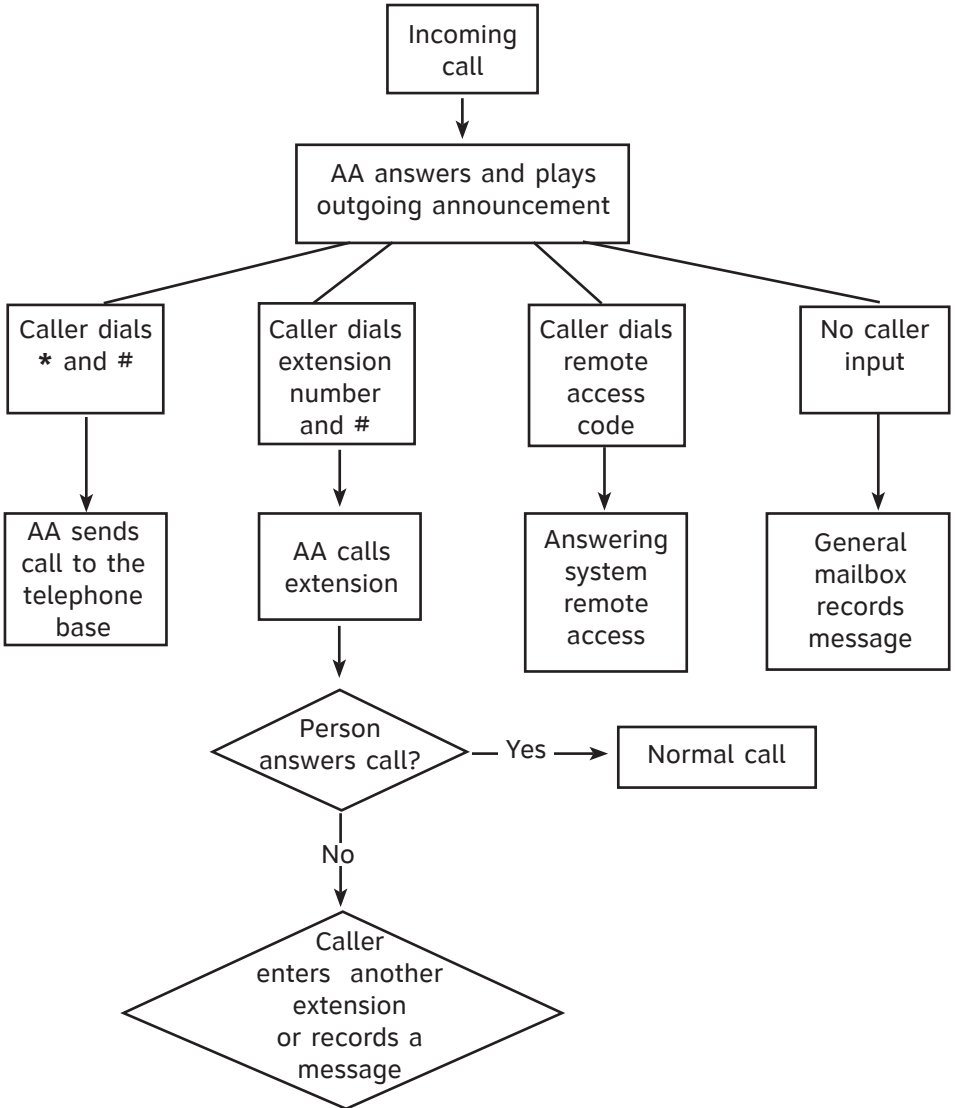

Answering system operation

Set general delivery mailbox to answer

1. When the telephone is idle, press **ANSWER ON** for the desired line.
2. Press **▲** or **▼** to scroll to **Ans->Gen MB only**.
3. Press **MENU/ENTER**. The **ANSWER ON** indicator turns on. The current mailbox announcement plays. The screen displays **General Mbox ON Play announcement**, and then it returns to the idle screen.

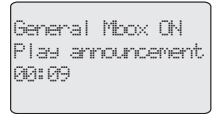
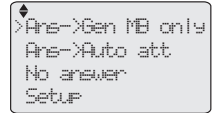
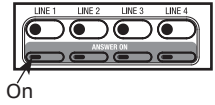

-OR-

To exit without making changes, press **EXIT**.

i **NOTE:** While previewing the announcement, you can adjust the volume by pressing **VOL+** or **VOL-**. If you do not want to hear the announcement, press **EXIT**.

Incoming messages

This telephone also accepts **COVM** recorded by your telephone service provider which you subscribe to for voicemail service (page 45).

New message indication

The  **Messages** indicator on the telephone base flashes when there are new and unreviewed messages and memos in the general mailbox.

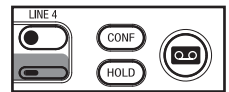

Message playback

From the telephone base, you can only play the messages in the general mailbox. You can only access the mailboxes for the handsets through each individual handset.

If you have new messages, you hear only the new messages (oldest first). If there are no new messages, the system plays back all the messages (oldest first).

When playback begins, the total number of messages is announced. Before each message, you hear the date and time of the recording. After the last message, you hear *“End of the messages.”*

Answering system operation

To listen to messages at the telephone base:

1. While the telephone is idle, press **☎ Messages** on the telephone base.
2. The system announces the number of new and unreviewed messages in the general mailbox.
3. Press **MENU/ENTER** to select **Play all** to listen to all messages. Press **◀REP** to repeat the message, press **◀REP** twice to listen to the previous message. Press **▶SKIP** to move forward to the next message. There is a long beep after each message playback as a separator.
4. Playback ends after playing all the messages, and then returns to the previous menu.
5. Press **☎ Messages** again to end the message playback at any time.

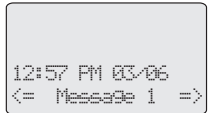
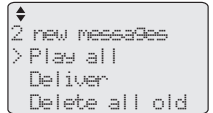

Options during playback

When a message is playing, you can adjust the playback volume, skip, repeat, or delete the message.

When messages are playing on the telephone base:

- Press **VOL+** or **VOL-** to adjust the message playback volume.
- Press **▶SKIP** to skip to the next message.
- Press **◀REP** to repeat the message. Press twice to hear the previous message.
- Press **REMOVE** to delete the message. The system announces "Message deleted."
- Press **☎ Messages** to stop the playback.

Delete all old messages

Use this feature to only delete old (reviewed) messages. You cannot delete new messages until you review them. You cannot retrieve deleted messages.

Delete all old messages on the telephone base:

1. When the telephone is idle, press **☎ Messages** on the telephone base.
2. Press **▲** or **▼** to scroll to **Delete all old**. Press **MENU/ENTER**.
3. The screen displays **Delete all old messages? <=No >=Yes**. Press **◀REP** to cancel this operation, and returns to the previous menu, or press **▶SKIP** to remove all old messages from the general mailbox.

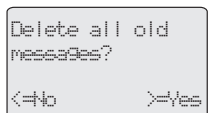

Answering system operation



NOTE: If there are any new and unreviewed messages in the general mailbox, the **Messages** indicator still flashes after you delete all old messages.

Transfer message

When a message is playing in the general mailbox, you can transfer the message to a single extension or all extensions.

When a message is playing on the telephone:

1. Press **XFER** on the telephone base.
2. Press **▲** or **▼** to scroll to an extension or all extensions, then press **MENU/ENTER**.

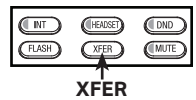

-OR-

Press the one-touch **EXT 1-0** key on the telephone base, the message is automatically transferred to the desired extension.

A copy of the message automatically transfers to the desired extension or all extensions. The general mailbox retains the original copy of the message.

Recording and delivering memos

Memos are messages you record into the general mailbox at the telephone base. You can save, play back, and delete them like incoming messages. You can record a memo as a reminder to yourself, or send a message to other extensions using the answering system.

To record a memo, then deliver it:

1. When the telephone is idle, press **Messages** on the telephone base.
2. Press **▲** or **▼** to scroll to **Deliver**. Press **MENU/ENTER**.
3. Press **▲** or **▼** to scroll to select the telephone base or a desired registered extension, or select all the registered extensions.
4. Press **MENU/ENTER**. The system announces *“Record after the tone. Press stop when you are done.”* There is a reminder beep. The timer starts counting.
5. Press **MENU/ENTER** again to stop recording. The timer stops and the recorded memo automatically plays back. The screen displays **1=Change 2=OK**.

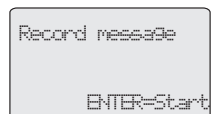
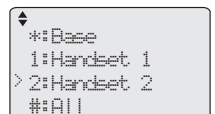
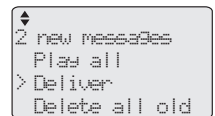

Answering system operation

6. Press **1** to re-record that memo.

-OR-

Press **2** to save the memo and send it to the extension you selected. The system announces "Message transferred to mailbox X," and then returns to the previous menu or memo.

-OR-

To exit without making changes, press **EXIT**.

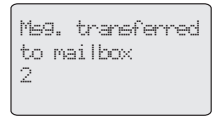

Play back a memo

Play memos the same way as normal messages (see **Message playback** on page 70).

Set general delivery mailbox to not answer

1. When the telephone is idle, press **ANSWER ON** for the desired line.
2. Press **▲** or **▼** to scroll to **No answer**. Press **MENU/ENTER**.

Disable the answering system

1. When the telephone is idle, press **ANSWER ON** for the desired line to set up.
2. Press **▲** or **▼** to scroll to **No answer**. Press **MENU/ENTER** to prevent the answering machine from answering calls on that line.

-OR-

To exit without making changes, press **EXIT**.

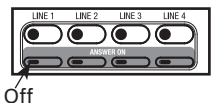
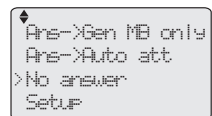

Remote access

Use this feature to reach your answering system remotely by dialing your telephone number from any touch-tone telephone.









To remotely reach the answering system:

1. Dial your telephone number from any touch-tone telephone.
2. When the system answers, enter the four-digit remote access code (**0000** is the default code, see page 30 to change it).

The system automatically announces the number of messages (new and/or old) if there are any, and then begins to play them.

3. You can also enter the following remote commands.

Remote commands:

	Press to play to all messages.
	Press to delete the current message (during playback).
	Press to repeat the current message (during playback).
	After you hear “Repeat” and within five seconds, press 4 again to listen to the previous message (during playback).
	Press to stop and return to the remote commands (during playback).
	Press to skip to the next message (during playback).
	Press to transfer the current message (during playback).
	Press to end the call.

4. Hang up to end the call and save all undeleted messages.

Cut out the remote access wallet card at the back of this user’s manual for quick reference.

NOTES:

1. If you do not enter a valid remote access code, the answering system answers the call as usual and all the voice and digits entered will be recorded as messages stored in your general mailbox.
2. If you do not enter any remote access code, the answering system announces “Thank you for calling,” and the call is terminated.
3. When there is no new message or all the new messages are played during remote access, you hear a help menu listing all features and commands. If there is no command after help menu is played three times, the call ends automatically.

Remote access

4. If the memory is full, you hear a two-beep alert tone and the answering system announces, *"Memory is full."* The telephone base screen displays **Message full**, and you cannot record new messages until old ones have been deleted. Check the system remaining space (page 32) frequently to maintain availability of space for incoming messages.
5. If you press **4** within five seconds of each message playback start, the previous message plays instead of repeating the current message.

Cordless headset operation

To register and deregister an AT&T compatible DECT 6.0 cordless headset (AT&T model TL7600) to the SB67118 telephone base, please refer to the page 11-13. To view the TL7600 manual, visit our website at www.telephones.att.com, or call **1 (888) 915-2007**. In Canada dial **1 (866) 288-4268**.

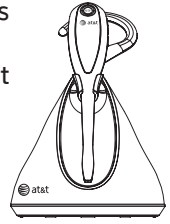

Cordless headset extension number

The cordless headset is always assigned extension number **0** regardless of how many handsets are registered.

By pressing the **ON/OFF** button on the cordless headset, you can see the extension  icon on the telephone base screen.

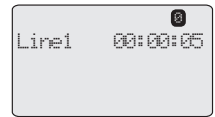

Switch between corded or cordless handset, telephone speakerphone and cordless headset

Use the following instructions to switch between the telephone base components (corded handset, speakerphone, corded headset and cordless headset). You must use the intercom system (page 46) to switch between the base and the cordless handsets.

To switch from corded handset, corded headset, or speakerphone to cordless headset:

During a call, press the **ON/OFF** button on the cordless headset.

To switch from cordless headset to corded handset, or corded headset, or speakerphone:

During a call, lift the corded handset, or press **HEADSET**, or press  **SPEAKER** on the telephone base.

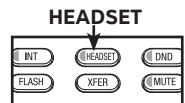

Telephone base display screen messages

All deleted	All old messages in the general mailbox are erased.
All handsets deregistered	The cordless handsets and cordless headset deregistration was successful.
Auto Attendant ON Play announcement	Auto attendant is on and the selected announcement plays back.
Busy	Failed intercom or conference call (there are already two cordless handsets being used).
Calling alert #	The alert call number is dialing out.
Calling X:Handset X	The telephone base is calling a cordless handset (for intercom calls).
Call log empty	There are no entries in the caller ID information.
Cordless headset registered	The cordless headset registration was successful.
Cordless headset registering	The cordless headset is registering to the telephone base.
COVM reset	COVM feature is reset.
Deleted	A call log entry, a redial number or a directory entry was deleted.
Deregistering	The telephone system is deregistering all the cordless handsets and cordless headset from the telephone base.
Directory empty	There are no directory entries.
Directory No items stored	There is no directory entry when you press DIR for chain dialing.
Ended	You have just ended a call.
Error	The handset or headset registration failed.
General Mbox ON Play announcement	General mailbox is on and the selected announcement plays back.
Handset registered	The cordless handset registration was successful.
Handset registering	The cordless handset is registering to the telephone base.
———Line X——— Incoming call	There is an incoming call.
Intercom to:	You have started the intercom process, and need to enter the number of the handset you wish to call.
Line X	The telephone line X is in use.
LIST FULL	If the directory contains 100 entries, the directory list is full.
Memory is full	The directory is full. You cannot save new entries unless you delete some current entries.

Telephone base display screen messages

Message full	The system memory is full. You cannot record new messages unless you delete some old messages.
Msg. transferred to mailbox X	A message is transferring from the general mail to a particular private mailbox.
No handsets registered	There are no handsets registered to the base to deregister.
No items stored	The redial list is empty.
MOH currently in use. Please try again later.	You cannot record or playback music on the telephone base while a call is listening to the current hold music.
Please enter another access code.	The access code you are trying to save already exists in the system.
Please set alert #	You are trying to confirm the alert number or set the notify alert on or off before you set the alert number.
Press SPKR to confirm the alert call	Press the telephone base speakerphone to call the alert call number.
PTT To: X:Handset X Release PTT key to stop	You are using push to talk (PTT) intercom feature to call Handset X , release the one-touch EXT 1-0 key to complete a one-way conversation.
Sorry, this mailbox is being used.	You cannot access a mailbox that is being used.
Speed dial X No number	You cannot initiate a speed dial without a telephone number stored in that speed dial location.
The system is busy. Please try again later.	The system resources are all occupied.
This is your mailbox.	You cannot transfer a message to the telephone base general mailbox.
Users in mailbox. Please try again later.	You cannot access a private mailbox in use. You should try again later.
Transfer to: (For systems with two or more handsets)	You have started the intercom process and need to enter the number of the handset you wish to call.
XX Missed calls	There are new calls in the caller ID information.

Maintenance

Taking care of your telephone

- Your telephone base contains sophisticated electronic parts, so you must treat it with care.
- Avoid rough treatment.
- Place the corded handset down gently.
- Save the original packing materials to protect your telephone base if you ever need to ship it.

Avoid water

- You can damage your telephone base if it gets wet. Do not use the corded handset in the rain, or handle it with wet hands. Do not install the telephone base near a sink, bathtub or shower.

Electrical storms

- Electrical storms can sometimes cause power surges harmful to electronic equipment. For your own safety, take caution when using electric appliances during storms.

Cleaning your telephone

- Your telephone base has a durable plastic casing that should retain its luster for many years. Clean it only with a soft cloth slightly dampened with water or a mild soap.
- Do not use excess water or cleaning solvents of any kind.

Remember that electrical appliances can cause serious injury if used when you are wet or standing in water. If the telephone base should fall into water, DO NOT RETRIEVE IT UNTIL YOU UNPLUG THE POWER CORD AND TELEPHONE LINE CORDS FROM THE WALL. Then pull the unit out by the unplugged cords.

Important safety information



This symbol is to alert you to important operating or servicing instructions that may appear in this user's manual. Always follow basic safety precautions when using this product to reduce the risk of injury, fire, or electric shock.

Safety information

- Read and understand all instructions in the user's manual. Observe all markings on the product.
- Avoid using a telephone during a thunderstorm. There may be a slight chance of electric shock from lightning.
- Do not use a telephone in the vicinity of a gas leak. If you suspect a gas leak, report it immediately, but use a telephone away from the area where the gas is leaking. If this product is a cordless model, make sure the telephone base is also away from the area.
- Do not use this product near water, or when you are wet. For example, do not use it in a wet basement or shower, or next to a swimming pool, bathtub, kitchen sink, or laundry tub. Do not use liquids or aerosol sprays for cleaning. If the product comes in contact with any liquid, unplug any line or power cord immediately. Do not plug the product back in until it has dried thoroughly.
- Install this product in a protected location where no one can trip over any line or power cords. Protect cords from damage or abrasion.
- If this product does not operate normally, see the **Troubleshooting** section on pages 87-94 of this user's manual. If you cannot solve the problem, or if the product is damaged, refer to the **Limited warranty** section on pages 84-85. Do not open this product except as directed in your user's manual. Opening the product or reassembling it incorrectly may expose you to hazardous voltages or other risks.
- Replace backup battery only as described in your user's manual (see page 9). Do not burn or puncture batteries — they contain caustic chemicals.
- This power adapter is intended to be correctly oriented in a vertical or floor mount position. The prongs are not designed to hold the plug in place if it is plugged into a ceiling or an under-the-table/cabinet outlet.



Caution: Use only the power adapter provided with this product. To obtain a replacement, visit our website at www.telephones.att.com or call **1 (888) 915-2007**. In Canada, dial **1 (866) 288-4268**.

Important safety information

Especially about cordless telephones

- **Electrical power:** The telephone base must be connected to a working electrical outlet. The electrical outlet should not be controlled by a wall switch. Calls cannot be made from the handset if the telephone base is unplugged, switched off or if the electrical power is interrupted.
- **Power adapter:** The power adapter is intended to be correctly oriented in a vertical or floor mount position. The prongs are not designed to hold the plug in place if it is plugged into a ceiling, under-the-table or cabinet outlet.

Precautions for users of implanted cardiac pacemakers

Cardiac pacemakers (applies only to digital cordless telephones):

Wireless Technology Research, LLC (WTR), an independent research entity, led a multidisciplinary evaluation of the interference between portable wireless telephones and implanted cardiac pacemakers. Supported by the U.S. Food and Drug Administration, WTR recommends to physicians that:

Pacemaker patients

- Should keep wireless telephones at least six inches from the pacemaker.
- Should NOT place wireless telephones directly over the pacemaker, such as in a breast pocket, when it is turned ON.
- Should use the wireless telephone at the ear opposite the pacemaker.

WTR's evaluation did not identify any risk to bystanders with pacemakers from other persons using wireless telephones.

Especially about telephone answering systems

Two-way recording: This unit does not sound warning beeps to inform the other party that the call is being recorded. To ensure that you are in compliance with any federal or state regulations regarding recording a telephone call, you should start the recording process and then inform the other party that you are recording the conversation.

SAVE THESE INSTRUCTIONS

FCC part 68 and ACTA

This equipment complies with Part 68 of the FCC rules and with technical requirements adopted by the Administrative Council for Terminal Attachments (ACTA). The label on the back or bottom of this equipment contains, among other things, a product identifier in the format US: AAAEQ##TXXXX. This identifier must be provided to your telephone service provider upon request.

The plug and jack used to connect this equipment to premises wiring and the telephone network must comply with the applicable Part 68 rules and technical requirements adopted by ACTA. A compliant telephone cord and modular plug is provided with this product. It is designed to be connected to a compatible modular jack that is also compliant. An RJ11 jack should normally be used for connecting to a single line and an RJ14 jack for two lines. See Installation Instructions in the user's manual.

The Ringer Equivalence Number (REN) is used to determine how many devices you may connect to your telephone line and still have them ring when you are called. The REN for this product is encoded as the 6th and 7th characters following the US: in the product identifier (e.g., if ## is 03, the REN is 0.3). In most, but not all areas, the sum of all RENs should be five (5.0) or less. For more information, please contact your telephone service provider.

This equipment may not be used with Party Lines. If you have specially wired alarm dialing equipment connected to telephone line, ensure the connection of this equipment does not disable your alarm equipment. If you have questions about what will disable the alarm equipment, consult your telephone service provider or a qualified installer.

If this equipment is malfunctioning, it must be unplugged from the modular jack until the problem has been corrected. Repairs to this telephone equipment can only be made by the manufacturer or its authorized agents. For repair procedures, follow the instructions outlined under the Limited Warranty.

If this equipment is causing harm to the telephone network, the telephone service provider may temporarily discontinue your telephone service. The telephone service provider is required to notify you before interrupting service. If advance notice is not practical, you will be notified as soon as possible. You will be given the opportunity to correct the problem and the telephone service provider is required to inform you of your right to file a complaint with the FCC. Your telephone service provider may make changes in its facilities, equipment, operation, or procedures that could affect the proper functioning of this product. The telephone service provider is required to notify you if such changes are planned.

If this product is equipped with a corded or cordless handset, it is hearing aid compatible.

If this product has memory dialing locations, you may choose to store emergency telephone numbers (e.g., police, fire, medical) in these locations. If you do store or test emergency numbers, please:

Remain on the line and briefly explain the reason for the call before hanging up.

Perform such activities in off-peak hours, such as early morning or late evening.

Industry Canada

Operation is subject to the following two conditions: (1) this device may not cause harmful interference, and (2) this device must accept any interference, including interference that may cause undesired operation.

The term "IC:" before the certification/registration number only signifies that the Industry Canada technical specifications were met.

The Ringer Equivalence Number (REN) for this terminal equipment is 0.1. The REN is an indication of the maximum number of devices allowed to be connected to a telephone interface. The termination on an interface may consist of any combination of devices subject only to the requirement that the sum of the RENs of all the devices does not exceed five.

This product meets the applicable Industry Canada technical specifications.

FCC part 15

This equipment has been tested and found to comply with the requirements for a Class B digital device under Part 15 of the Federal Communications Commission (FCC) rules. These requirements are intended to provide reasonable protection against harmful interference in a residential installation. This equipment generates, uses and can radiate radio frequency energy and, if not installed and used in accordance with the instructions, may cause harmful interference to radio communications. However, there is no guarantee that interference will not occur in a particular installation. If this equipment does cause harmful interference to radio or television reception, which can be determined by turning the equipment off and on, the user is encouraged to try to correct the interference by one or more of the following measures:

- Reorient or relocate the receiving antenna.
- Increase the separation between the equipment and receiver.
- Connect the equipment into an outlet on a circuit different from that to which the receiver is connected.
- Consult the dealer or an experienced radio/TV technician for help.

Changes or modifications to this equipment not expressly approved by the party responsible for compliance could void the user's authority to operate the equipment.

This device complies with Part 15 of the FCC Rules. Operation is subject to the following two conditions: (1) this device may not cause harmful interference, and (2) this device must accept any interference received, including interference that may cause undesired operation. Privacy of communications may not be ensured when using this telephone.

To ensure safety of users, the FCC has established criteria for the amount of radio frequency energy that can be safely absorbed by a user or bystander according to the intended usage of the product. This product has been tested and found to comply with the FCC criteria. The handset may be safely held against the ear of the user. The telephone base shall be installed and used such that parts of the user's body other than the hands are maintained at a distance of approximately 20 cm (8 inches) or more. If you choose to use a clipping device, please make sure to only use the supplied AT&T help clip.

This Class B digital apparatus complies with Canadian ICES-003.

Limited warranty

The AT&T brand is used under license - any repair, replacement or warranty service, and all questions about this product should be directed to: In the United States of America, visit **www.telephones.att.com** or call **1 (888) 915-2007**. In Canada, call **1 (866) 288-4268**.

1. What does this limited warranty cover?

The manufacturer of this AT&T-branded product warrants to the holder of a valid proof of purchase ("CONSUMER" or "you") that the product and all accessories provided in the sales package ("PRODUCT") are free from defects in material and workmanship, pursuant to the following terms and conditions, when installed and used normally and in accordance with the PRODUCT operating instructions. This limited warranty extends only to the CONSUMER for products purchased and used in the United States of America and Canada.

2. What will be done if the PRODUCT is not free from defects in materials and workmanship during the limited warranty period ("materially defective PRODUCT")?

During the limited warranty period, the manufacturer's authorized service representative will repair or replace at the manufacturer's option, without charge, a materially defective PRODUCT. If the manufacturer repairs the PRODUCT, they may use new or refurbished replacement parts. If the manufacturer chooses to replace the PRODUCT, they may replace it with a new or refurbished PRODUCT of the same or similar design. The manufacturer will retain defective parts, modules, or equipment. Repair or replacement of the PRODUCT, at the manufacturer's option, is your exclusive remedy. The manufacturer will return repaired or replacement products to you in working condition. You should expect the repair or replacement to take approximately 30 days.

3. How long is the limited warranty period?

The limited warranty period for the PRODUCT extends for ONE (1) YEAR from the date of purchase. If the manufacturer repairs or replaces a materially defective PRODUCT under the terms of this limited warranty, this limited warranty also applies to repaired or replacement PRODUCT for a period of either (a) 90 days from the date the repaired or replacement PRODUCT is shipped to you or (b) the time remaining on the original one-year limited warranty; whichever is longer.

4. What is not covered by this limited warranty?

This limited warranty does not cover:

- PRODUCT that has been subjected to misuse, accident, shipping or other physical damage, improper installation, abnormal operation or handling, neglect, inundation, fire, water, or other liquid intrusion; or
- PRODUCT that has been damaged due to repair, alteration, or modification by anyone other than an authorized service representative of the manufacturer; or
- PRODUCT to the extent that the problem experienced is caused by signal conditions, network reliability or cable or antenna systems; or
- PRODUCT to the extent that the problem is caused by use with non-AT&T accessories; or
- PRODUCT whose warranty/quality stickers, PRODUCT serial number plates or electronic serial numbers have been removed, altered or rendered illegible; or
- PRODUCT purchased, used, serviced, or shipped for repair from outside the United States of America or Canada, or used for commercial or institutional purposes (including but not limited to products used for rental purposes); or
- PRODUCT returned without a valid proof of purchase (see item 6 below); or
- Charges for installation or setup, adjustment of customer controls, and installation or repair of systems outside the unit.

Limited warranty

5. How do you get warranty service?

To obtain warranty service in the United States of America, visit

www.telephones.att.com or call **1 (888) 915-2007**. In Canada, call **1 (866) 288-4268**. NOTE: Before calling for service, please review the user's manual; a check of the PRODUCT controls and features may save you a service call.

Except as provided by applicable law, you assume the risk of loss or damage during transit and transportation and are responsible for delivery or handling charges incurred in the transport of the PRODUCT(s) to the service location. The manufacturer will return repaired or replaced PRODUCT under this limited warranty to you. Transportation, delivery or handling charges are prepaid. The manufacturer assumes no risk for damage or loss of the PRODUCT in transit. If the PRODUCT failure is not covered by this limited warranty, or proof of purchase does not meet the terms of this limited warranty, the manufacturer will notify you and will request that you authorize the cost of repair prior to any further repair activity. You must pay for the cost of repair and return shipping costs for the repair of products that are not covered by this limited warranty.

6. What must you return with the PRODUCT to get warranty service?

You must:

- Return the entire original package and contents including the PRODUCT to the service location along with a description of the malfunction or difficulty; and
- Include a "valid proof of purchase" (sales receipt) identifying the PRODUCT purchased (PRODUCT model) and the date of purchase or receipt; and
- Provide your name, complete and correct mailing address, and telephone number.

7. Other limitations

This warranty is the complete and exclusive agreement between you and the manufacturer of this AT&T branded PRODUCT. It supersedes all other written or oral communications related to this PRODUCT. The manufacturer provides no other warranties for this PRODUCT. The warranty exclusively describes all of the manufacturer's responsibilities regarding the PRODUCT. There are no other express warranties. No one is authorized to make modifications to this limited warranty and you should not rely on any such modification.

State/Provincial Law rights: This warranty gives you specific legal rights, and you may also have other rights which vary from state to state or province to province.

Limitations: Implied warranties, including those of fitness for a particular purpose and merchantability (an unwritten warranty that the PRODUCT is fit for ordinary use) are limited to one year from date of purchase. Some states/provinces do not allow limitations on how long an implied warranty lasts, so the above limitation may not apply to you. In no event shall the manufacturer be liable for any indirect, special, incidental, consequential, or similar damages (including, but not limited to lost profits or revenue, inability to use the PRODUCT or other associated equipment, the cost of substitute equipment, and claims by third parties) resulting from the use of this PRODUCT. Some states/provinces do not allow the exclusion or limitation of incidental or consequential damages, so the above limitation or exclusion may not apply to you.

Please retain your original sales receipt as proof of purchase.

Technical specifications

RF frequency band	1921.536MHz — 1928.448MHz
Channels	5
Operating temperature	32°F — 122°F 0°C — 50°C
Telephone base voltage (AC voltage, 50/60Hz)	100 — 240Vrms
Telephone base voltage (AC adapter output)	8VDC @1000mA
Headset jack	2.5mm, 32-150ohm

DECT 6.0 digital technology

The AT&T DECT 6.0 products offer unsurpassed range performance and sound clarity. This is achieved through a unique antenna design and advances in noise-filtering technology. An independent laboratory has confirmed that AT&T DECT 6.0 products perform up to 45% better in range competitions. Now calls can be taken in the basement, backyard and garage with exceptional sound quality.

Telephone operating range

This cordless telephone operates within the maximum power allowed by the Federal Communications Commission (FCC). Even so, this handset and telephone base can communicate over only a certain distance — which can vary with the locations of the telephone base and handset, the weather, and the construction of your building.

Redefining long range coverage and clarity

This telephone base comes with two antennas that gives much better clarity and covers a longer range than before. For even greater range, add optional repeaters (AT&T model SB67128).

Troubleshooting

If you have difficulty with your telephone, please try the suggestions below. For Customer Service, visit our website at www.telephones.att.com or call **1 (888) 915-2007**. In Canada, dial **1 (866) 288-4268**.

My telephone base doesn't work at all.

- Make sure the power cord is securely plugged in.
- Make sure you plug the telephone line cord securely and firmly into the telephone base and the telephone wall jack.
- Reset the telephone base. Unplug the electrical power. Wait for approximately 15 seconds, then plug it back in. Allow up to one minute for the telephone base to reset.
- You may need to purchase four AA alkaline batteries as backup battery to make the telephone base work in the event of a power failure. Please refer to **Optional backup battery installation** on page 9 in this user's manual.

I cannot get a dial tone from the corded handset.

- First try all the suggestions above.
- Make sure you plug the handset cord securely and firmly into the **HANDSET** jack on the telephone base and the corded handset.
- If the previous suggestions do not work, disconnect the telephone base from the telephone jack and connect to a different telephone. If there is no dial tone on that telephone either, the problem is in your wiring or local service. Contact your telephone service provider.
- Your line cord might be malfunctioning. Try installing a new line cord.

I cannot dial out.

- First try all the suggestions above.
- Make sure you have a dial tone before dialing. The corded handset might take a second or two to connect the telephone base and produce a dial tone. This is normal. Wait an extra second before dialing.
- Eliminate any background noise. Noise from a television, radio or other appliances might cause the telephone to not dial out properly. If you cannot eliminate the background noise, first try muting the corded handset before dialing, or dialing from another room by a cordless handset with less background noise.

Troubleshooting

- If the other telephone in your building are having the same problem, contact your telephone service provider (charges might apply).
-

My telephone base isn't performing normally.

- Make sure you plug the power cord securely into the telephone base. Plug the power adapter into a different working electrical outlet without a wall switch.
 - Reset the telephone base. Unplug the electrical power. Wait for 15 seconds then plug it back in. Allow up to one minute for the telephone base to reset.
 - Other electronic products can cause interference to your telephone base. Try installing your telephone base as far away from these types of electronic devices as possible: television sets, VCRs, or other cordless telephones.
-

I get noise, static, or weak signals even when I'm near the telephone base.

- If you subscribe to high-speed Internet service (digital subscriber line - DSL) through your telephone lines, you must install a DSL filter between the telephone line cord and the telephone wall jack. The filter prevents noise and caller ID problems as a result of DSL interference. Please contact your DSL service provider for more information about DSL filters.
- You may be able to improve the performance of your telephone base by installing your new telephone base as far as possible from any other existing corded or cordless telephone system that may already be installed.
- Other electronic products can cause interference to your telephone base. Try installing your telephone base as far away from the following electronic devices as possible: television sets, VCRs, or other cordless telephones.
- Do not install this telephone base near a microwave oven or on the same electrical outlet. You might experience decreased performance while the microwave oven is operating.
- If you plug your telephone in with a modem or a surge protector, plug the telephone base (or modem/surge protector) into a different location. If this does not solve the problem, relocate your telephone base or modem farther apart from one another, or use a different surge protector.

Troubleshooting

- Relocate your telephone to a higher location. The telephone might have better reception in a high area.
- If the other telephones in your building are having the same problem, contact your telephone service provider (charges may apply).

I experience poor sound quality when using the speakerphone.

- For increased sound quality while using the telephone speakerphone, place the telephone base on a flat surface with the dial pad facing up.
- Excessive background noise will cause a speakerphone to fade in and out. Try controlling the background noise by turning off any audio devices near the speakerphone. Also, try to avoid interrupting the person at the other end of the conversation while they are speaking. If background noise cannot be controlled, you should stop speakerphone operation and return to normal corded handset mode.
- When using a speakerphone, controlling background noise in your environment is essential. While you are listening to your party, press **MUTE** to temporarily turn your microphone off. When it is your turn to speak, remember to press **MUTE** again to turn the microphone on.

I hear other calls while using my telephone.

- Disconnect the telephone base from the telephone jack, and plug in a different telephone. If you still hear other calls, call your telephone service provider.

My telephone base does not ring when I receive a call.

- Make sure that the ringer is not off. Refer to the section on ringer selection in this user's manual.
- Make sure you plug in the telephone line cord securely into the telephone base and the telephone jack. Make sure you plug in the power cord securely.
- You may have too many extension telephones on your telephone line to allow all of them to ring simultaneously. Try unplugging some of the other telephones.
- If the other telephones in your building are having the same problem, contact your telephone service provider (charges might apply).
- Test a working telephone at the telephone jack. If another telephone has the same problem, contact your telephone service provider (charges might apply).

Troubleshooting

- Other electronic products can cause interference with your telephone base. Try installing your telephone base as far away as possible from electronic devices such as television sets, VCRs, or other cordless telephones.
- Your line cord might be malfunctioning. Try installing a new line cord.

My calls cut in and out while I'm using my corded handset.

- Other electronic products can cause interference with your telephone base. Try installing your telephone base as far away from the following electronic devices as possible: television sets, VCRs, or other cordless telephones.
- Do not install this telephone base near a microwave oven or on the same electrical outlet. You might experience decreased performance while the microwave oven is operating.
- If you plug your telephone base in with a modem or surge protector, plug the telephone base (or modem/surge protector) into a different location. If this does not solve the problem, relocate your telephone base or modem farther apart from one another, or use a different surge protector.
- Relocate your telephone base to a higher location. The telephone base might have better reception when installed in a high area.
- If the other telephones in your building are having the same problem, contact your telephone service provider (charges may apply).
- Excessive background noise will cause a speakerphone to fade in and out. Try controlling the background noise by turning off any audio devices near the speakerphone. Also, try to avoid interrupting the person at the other end of the conversation while they are speaking. If background noise cannot be controlled, you should stop speakerphone operation and return to normal handset mode.
- When using a telephone base speakerphone, controlling background noise in your environment is essential. While you are listening to your party, press **MUTE** to temporarily turn your microphone off. When it is your turn to speak, remember to press **MUTE** again to turn the microphone on.

Troubleshooting

My caller ID isn't working.

- Caller ID is a subscription service. You must subscribe to this service from your telephone service provider for this feature to work on your telephone base.
- The caller must be calling from an area that supports caller ID.
- Both you and your caller's telephone service provider must use caller ID compatible equipment.
- If you subscribe to high-speed Internet service (digital subscriber line - DSL) through your telephone lines, you must install a DSL filter between the telephone line cord and the telephone wall jack. The filter prevents noise and caller ID problems resulting from DSL interference. Please contact your DSL service provider for more information about DSL filters.

System does not receive caller ID when on a call.

- Make sure you subscribe to caller ID with call waiting features from your telephone service provider. Caller ID features works only if both you and the caller are in areas offering caller ID service, and if both telephone companies use compatible equipment.

The answering system is recording incomplete messages.

- If a caller leaves a very long message, part of it may be lost when the system disconnects the call after three minutes.
- If the caller pauses for longer than six seconds, the system stops recording and disconnects the call.
- If the system's memory becomes full during a message, the system stops recording and disconnects the call.
- If the caller's voice is very soft, the system may stop recording and disconnects the call.

I have difficulty hearing messages.

- Press **VOL+** to increase the speaker volume on the telephone base.

Troubleshooting

System does not answer after correct number of rings.

- Make sure that the answering system is on (page 70).
- If toll saver is selected, the number of rings changes to two when there are new messages waiting (page 28).
- If the memory is full or if the system is off, the answering system answers after 10 rings.
- In some cases, the answering system is affected by the ringing system used by the local telephone company.
- If you subscribe to voicemail service, change the number of rings so that your answering system answers before your voicemail answers. To determine how many rings will activate your voicemail, please contact your local telephone service provider.
- If there is a fax machine connected to the same telephone line, try disconnecting the fax machine. If that solves the problem, consult your fax machine documentation for information on compatibility with answering systems.

System does not record messages.

- Make sure the answering system is on (page 70).
- Make sure the memory of the answering system is not full. Please refer to the **Remaining space** section on page 32 in the user's manual. When the answering system memory is full, it does not record new messages until some old messages are deleted.
- If you subscribe to voicemail service, change the number of rings so that your answering system answers before your voicemail answers. To determine how many rings will activate your voicemail, please contact your local telephone service provider.
- If there is a fax machine connected to the same telephone line, try disconnecting the fax machine. If that solves the problem, consult your fax machine documentation for information on compatibility with answering systems.

Troubleshooting

System does not respond to remote commands.

- Make sure to enter your remote access code correctly (page 74).
 - Make sure you are calling from a touch-tone telephone. When you dial a number, you should hear tones. If you hear clicks, the telephone is not a touch-tone telephone and cannot activate the answering system.
 - The answering system may not detect the remote access code while your announcement is playing. Try waiting until the announcement is over before entering the code.
 - There may be interference on the **telephone line you** are using. Press dial pad keys firmly.
-

Outgoing announcement is not clear.

- When you record your announcement, make sure you speak in a normal tone of voice, about nine inches from the telephone base.
 - Make sure there is no background noise (TV, music, etc.) while recording.
-

A **COVM** icon shows on the screen display and I do not know why.

- Your telephone has voicemail indication that is separate from the built-in answering system. If **COVM** icon appears on the display, then your telephone has received a signal from your telephone service provider. Contact your telephone service provider for more information on how to access your voicemail.
-

I cannot retrieve voicemail messages.

- Your telephone has both a built-in answering system and voicemail indication. They are independent features and each alerts you to new messages differently (page 64). If you subscribe to voicemail service from your telephone service provider (charges may apply), contact your telephone service provider for more information on how to access your voicemail.

Troubleshooting

Common cure for electronic equipment.

If the telephone base does not seem to be responding normally, do the following (in the order listed):

- Disconnect the power to the telephone base.
- Disconnect the spare battery, if applicable.
- Wait a few minutes.
- Connect power to the telephone base.
- Reinstall the backup battery.
- Wait for re-establishing the connection with the telephone base. Allow up to one minute for this to take place.

Index

A

- AC power, 9
- Access code, 30
- Add new handsets, 10
- Alert
 - set alert number, 31
 - confirmation call, 32
 - on or off, 31
- Announcement
 - record, 25-26, 28
 - select, 29
- Answer
 - incoming call, 38
 - intercom call, 47
 - transferred call, 49
 - Push to talk (PTT) call, 51
- Answering system, 64-74
- Antennas, 6, 86
- Area code, 21
- Audio cable, 15, 23-24
- Auto attendant
 - flow chart, 69
 - multi auto attendants, 68
 - operation, 67-69
 - setup, 25-27

B

- Battery installation, 9
- Blind transfer, 48

C

- Call privacy, 40
- Call screening, 30
- Call transfer, 48-49
- Call waiting, 39, 58

Caller ID

- save entries to directory, 62
- delete entries, 61
- dial an entry, 61
- review information, 60

Capacity, 52, 66

- Central office (CO) lines, 20
- Central office voicemail (COVM)
 - on or off, 45
 - reset, 45

Chain dialing, 43

Conference calls, 43-44

Customer support, 33

D

Delete

- all old messages, 71
- call log entries, 61
- directory entries, 57

Deliver a memo, 72

Deregister handsets and headset, 13

Dial pad, 53

Dialing

- directory entry, 57
- call log entry, 61

Directory

- capacity, 52
- entry dialing, 57
- edit entries, 57
- name search, 56
- new entries, 53-54

Directory card, 2

Display dial, 57

Do not disturb (DND), 18, 35

DSL, 4-5, 7-8

Index

E

Elapsed time, 23, 36

End

call, 36-37

conference call, 44

intercom call, 47

PTT call, 51

F

Flash, 39, 53-54

H

Hands-free use, 14, 37, 49

Handset registration, 10

Headset

corded installation, 14

cordless registration, 11

cordless operation, 76

Hold, 42

Hold reminder, 22

I

Incoming messages, 70

Indicator lights, 34

Indicator tones, 33

Installation

audio cable, 15

corded headset, 14

telephone base, 6-8

Intercom

with cordless handset, 46

with all extensions, 46

answer, 47

end, 47

J

Join a call in progress, 42

K

Key tone, 19

L

Language, 19

Last number redialing, 38

LCD contrast, 19

Line indicators, 36

Line mode, 20

Line selection, 20

Limited warranty, 84-85

M

Mailbox setup, 28-32

Maintenance, 79

Make

call, 36-37

conference call, 43-44

intercom call, 46-47

PTT call, 50-51

Memo

play back, 73

record and deliver, 72

Memory match, 60

Menu settings, 16

Message playback, 70

Messages indication, 70

Missed (new) calls indicator, 60

Music on hold (MOH), 15, 23-24

Mute, 42

Index

N

Name

- enter into directory, 53-54
- search, 56

Navigation keys, 1

New message indication, 70

Notify alert, 31-32

Number of rings, 27-28

O

One-touch keys, 2, 46-48, 50-51

On-hook dialing (predialing), 37

Outgoing announcement, 25, 69, 93

Outgoing calls, 18, 20

P

Pause, 54

PBX lines, 20

Planning your system, 5

Play back

- message, 70
- memo, 73

Power adapter, 6-7, 80-81

Predialing, 37

Pre-recorded

- announcement, 25
- music, 23-24

PTT (push to talk intercom)

- single handset, 50
- all handsets, 50-51
- answer, 51
- convert to intercom, 51
- end, 51

Q

Quick reference guide, 1-3

R

Record

- call, 40
- extension list, 26
- memo, 72
- announcement, 25, 28

Redial, 38-39

Registration

- cordless handset, 10
- cordless headset, 11

Remote access, 74-75

Remote code, 30

Remaining space, 32

Repeater, 5-6, 86

Review

- directory entries, 55
- caller ID information, 59

Ring group, 18

Ringer

- on or off, 16
- tone, 17
- volume, 16

S

Safety information, 80-81

Screen display messages, 77-78

Screen icons, 34

Search by name, 56

Set date and time, 22

Speakerphone, 37

Speed dial

- call, 37
- enter, edit or delete number, 33
- setup, 33

Index

T

- Technical specifications, 86
- Telephone base operation, 36-51
- Telephone operating range, 86
- Temporary ringer silencing, 38
- Three-way conference calls, 43-44
- Toll saver, 28
- Transfer
 - call, 48-49
 - message, 72
- Troubleshooting, 87-94
- Turn off
 - answering system, 73
 - auto attendant, 67
 - general delivery mailbox, 73
- Turn on
 - answering system, 67, 70
 - auto attendant, 67
 - general delivery mailbox, 70
- Two-way communication, 50
- Two-way intercom, 51
- Two-way phone conversation, 40-41
- Two-way recording, 81

U

- Un-mute, 41

V

- Voicemail,
 - COVM, 45
 - from answering system, 64
- Voice prompt, 66-67
- Volume control, 17, 39

W

- Warranty, 84-85

Remote access wallet card

Use the wallet card below to help you remember commands to control your answering system from any touch tone telephone.

Cut along dotted line.



Call your telephone number, then enter your four-digit access code (preset to 0000).

Action	Remote command
Play all messages	1
Delete the message.....	3
Repeat the message.....	4
Listen to the previous message.....	4 (twice)
Help menu and return to the remote commands	5
Skip the message	6
Transfer the message.....	7
End remote access call	* (or hang up)

Fold here.



Model name: AT&T SB67118

Type: DECT 6.0 4-line corded/cordless small business system

© 2009 Advanced American Telephones. All rights reserved. AT&T and the AT&T logo are trademarks of AT&T Intellectual Property licensed to Advanced American Telephones, San Antonio, TX 78219. Printed in China.



www.telephones.att.com