



Synapse[®] Installation Guide



CONTENTS

Preface	4
Additional Documentation	4
Topic Navigation	5
Text Conventions	5
Installation	6
System Overview	7
Software Version Compatibility	8
System Installation Overview	10
System Installation Overview for Remote Sites	12
Recommended Installation Sequence	13
Planning Your System and Network Configuration	15
About Modes of Operation	15
IP Addresses and Connectivity	16
Extension Assignments	17
Connecting Analog Devices to the ATA	18
Overhead Paging Overview	20
Door Phones Overview	23
Site Preparation	26
Network Requirements	26
Placement Considerations	26
Power Considerations	27
Other Preparations	27
Assigning Telephone Lines and Extensions	28
Providing Limited Telephone Service During AC Power Outages	28
Analog Line Connection Order on PSTN Gateways	28
ATA Fax Line Configuration	29
Gateway and ATA Placement	31
Rack Mounting	31
Wall Mounting	32
Grounding	33
Gateway Installation	35
Deskset Installation	38
SB67050 ATA Installation	45
Connecting Analog Telephones	45



Connecting a Fax Machine	46
Connecting an Overhead Paging System (OHP)	47
Connecting a Music on Hold Source	49
SB67040 Cordless Handset Installation.....	50
Charger Installation.....	50
Battery Installation	51
Battery Charging	52
TL7600 Cordless Headset Installation	53
Charger Installation.....	53
Battery Installation	54
Battery Charging	55
Getting Started.....	56
PSTN Gateway Features.....	57
T1 Gateway Features.....	59
SIP Gateway Features	61
Gateway Front Panel Interface.....	63
Gateway Configuration.....	64
Upgrade Gateway Software	65
ATA Features.....	67
ATA Front Panel Interface	69
ATA Configuration.....	70
Upgrade ATA Software	70
Resetting Devices.....	72
Deskset IP Settings.....	74
Set/Edit Static IP	75
IP Status.....	76
Upgrade Deskset Software	77
System Configuration.....	78
WebUI Overview.....	79
Log in as Administrator	80
Error Handling	82
System Settings.....	83
Configuring a Trunk Port (FXO) Door Phone	85
Line Calibration Configuration	90
Updating Devices.....	91
Product Registration	94
Troubleshooting	95
Common Troubleshooting Procedures.....	96
Resetting Devices.....	96
Resolving General Functional Issues.....	97
Resolving Audio Echoes (PSTN Gateway).....	100
Resolving General Audio Issues.....	101
Reintroducing a Deskset Into the System	101
Reintroducing a Gateway or ATA Into the System	103
Power Failure Recovery Procedure.....	104



Initial Installation.....	105
Display Messages.....	106
T1 Gateway Indicators.....	109
PSTN Gateway Setup.....	111
WebUI.....	112
Administrator WebUI.....	112
System Upgrade.....	117
User WebUI.....	118
PC/Deskset Interaction.....	119
Other Deskset Features.....	120
SB67050 Analog Terminal Adapter.....	123
General Troubleshooting.....	123
Music on Hold (MoH).....	125
Overhead Paging (OHP).....	128
Fax Configuration.....	137
Analog Phone.....	140
Group Mailbox.....	142
Appendixes.....	143
Appendix A: Technical Specifications.....	143
Appendix B: Default Settings.....	146
Appendix C: Part Lists.....	150
SB67010 PSTN Gateway Parts List.....	150
SB67060 T1 Gateway Parts List.....	151
SB67070 SIP Gateway Parts List.....	152
SB67050 Analog Terminal Adapter (ATA) Parts List.....	153
SB67020 Deskset Parts List.....	154
SB67030/031 Deskset Parts List.....	155
SB67040 Cordless Handset Parts List.....	156
TL7600 Cordless Headset Parts List.....	157
Appendix D: Maintenance.....	158
Appendix E: Important Safety Instructions.....	159
Glossary.....	161



PREFACE

This Installation Guide provides instructions for installing and setting up your Synapse system with software version 2.0 or later. See [page 8](#) for instructions on checking the software version on the Gateway, the Deskset, and the ATA.

Before using this AT&T product, please read "[Appendix E: Important Safety Instructions](#)" on [page 159](#). Please read this guide thoroughly for all the information necessary to install your new AT&T product.

**NOTE**

For customer service or product information, contact the person who installed your system. If your installer is unavailable, visit our web site at www.telephones.att.com/smb or call **1 (888) 916-2007**. In Canada, dial **1 (888) 883-2474**.

Additional Documentation



Downloadable copies of all Synapse documents, including user's and administrator's guides, installation instructions and quick-start guides, are available at www.telephones.att.com/synapseguides.





Topic Navigation

This Synapse Installation Guide features easy navigation between topics and the ability to return to your original topic.

Text in blue indicates a link to another page in the document. **Bold text in blue** indicates a hyperlink to an external web site.



You can also click the arrows at the bottom of the page to move around this document.

	Go back to the last page viewed.
	Go to the previous page.
	Go to the next page.

Text Conventions

Table 1 lists text formats and describes how they are used in this guide.

Table 1. Description of Text Conventions

Text Format	Description
Screen	Identifies text that appears on a device screen or a WebUI page in a title, menu, or prompt.
HARD KEY or DIAL-PAD KEY	Identifies a hard key, including the dial-pad keys.
CallFwd	Identifies a soft key.
[PSTN], [T1], [ATA], [Handset], [Headset]	Identifies information about devices and capabilities beyond the basic configuration of a Gateway and Desksets.
Line Appearance mode T1 Gateway	Text in the left-hand margin identifies a step or paragraph that applies to a specific configuration or Synapse device.
 NOTE Notes provide important information about a feature or procedure.	Example of a Note.
 CAUTION A caution means that loss of data or unintended circumstances may result.	Example of a Caution.



CHAPTER

1

INSTALLATION

This section describes the physical installation of the Synapse devices. Each system must include at least one PSTN Gateway, one T1 Gateway, or one SIP Gateway. Each PSTN Gateway supports up to four analog telephone lines. Up to four PSTN Gateways can support up to 16 analog telephone lines. The T1 Gateway supports up to 23 T1 PRI voice channels.

- [“System Overview” on page 7](#)
- [“Recommended Installation Sequence” on page 13](#)
- [“Planning Your System and Network Configuration” on page 15](#)
- [“Site Preparation” on page 26](#)
- [“Assigning Telephone Lines and Extensions” on page 28](#)
- [“Gateway and ATA Placement” on page 31](#)
- [“Gateway Installation” on page 35](#)
- [“Deskset Installation” on page 38](#)
- [“SB67050 ATA Installation” on page 45](#)
- [“SB67040 Cordless Handset Installation” on page 50](#)
- [“TL7600 Cordless Headset Installation” on page 53.](#)



NOTE

You can view Synapse installation videos at www.telephones.att.com/smb. In the left navigation menu, click **Product Support** and then **Video Gallery**.



System Overview

AT&T SB67010 PSTN Gateway — Each PSTN Gateway provides access to up to four analog outside telephone lines. The system can have up to four PSTN Gateways, supporting up to 16 telephone lines. Information that is only about the PSTN Gateway is designated by **[PSTN]** in this guide.



AT&T SB67060 T1 Gateway — The T1 Gateway supports the T1 PRI (Primary Rate Interface) that provides access to up to 23 voice channels to support up to 23 simultaneous calls. The system can have only one T1 Gateway. Information that is only about the T1 Gateway is designated by **[T1]** in this guide.



AT&T SB67070 SIP Gateway — The SIP Gateway enables calls using a SIP Trunk Service Provider. If the Provider supports PSTN connections, then calls can be made to a remote party. The system can have only one SIP Gateway. Information that is only about the SIP Gateway is designated by **[SIP]** in this guide.



AT&T SB67020 Deskset — A Deskset with a standard screen and Programmable Feature Keys. The system can have up to 100 Desksets, and you can combine SB67020 and SB67030/031 Desksets. Information that is only about the SB67020 Deskset is designated by **[020]** in this guide.



AT&T SB67030/031 Deskset — A Deskset with a large screen and a DECT 6.0 radio to host the optional Cordless Handset and Headset accessories. The system can have up to 100 Desksets, and you can combine SB67030/031 and SB67020 Desksets. Information that is only about the SB67030/031 Deskset is designated by **[030/031]** in this guide.



AT&T SB67040 Cordless Accessory Handset (Optional, requires SB67030/031 Deskset) — The Cordless Handset duplicates many of the Deskset features and provides a high degree of mobility. Information that is only about the Cordless Handset is designated by **[Handset]** in this guide.



AT&T TL7600 Cordless Accessory Headset (Optional, requires SB67030/031 Deskset) — The Headset lets you work while you talk. Information that is only about the Cordless Headset is designated by **[Headset]** in this guide.



AT&T SB67050 Analog Terminal Adapter (ATA - Optional) — The ATA allows the integration of non-Synapse devices, such as analog telephones, a fax machine, overhead paging equipment, and a music-on-hold source into the Synapse system. It also provides Group Mailboxes to allow different people to access the same Mailbox. The system can have only one ATA. Information that is only about the ATA is designated by [ATA] in this guide.



Web User Interface (WebUI) — The WebUI provides the ability to customize your system for your business from a PC that is on the same Local Area Network. The WebUI resides on the Gateways, ATA, and Desksets, and is updated with device software updates. See [“Updating Devices” on page 91](#).

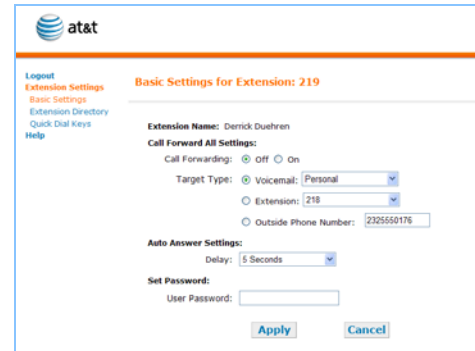

You can register only one AT&T SB67040 Cordless Handset and only one AT&T TL7600 Cordless Headset to a SB67030/031 Deskset. Up to five SB67030/031 Desksets can have cordless accessories, although this number can increase depending on your office environment. Factors such as proximity of Desksets, number of simultaneous calls, and structural obstacles affect how many Desksets can have cordless accessories. When a Deskset has cordless accessories, they are all part of the same extension, and only one extension device can be used at a time.



To integrate the Headset into the system, see “User Settings” in the SB67030/031 Deskset and Accessories User’s Guide at www.telephones.att.com/synapseguides, rather than the manual that is packaged with the Headset.

Software Version Compatibility

Systems with software versions 2.0 and later support the features described in this guide. **All Gateways, ATAs and Desksets must have compatible software versions installed.**

- To determine the software version of Gateways and the ATA from the device front panel, from idle, press **SELECT**, **SELECT**, and then **DOWN**. The software version appears.

Device Info	
SW Ver:	2.0
FW Ver:	Z003
S-Series:	1.11.0

- To determine the SB67020 Deskset software version, press **MENU**, then **4**, and then **▽** to display the software version.



Deskset Information ▼▲	
Software Ver:	2.0
Firmware Ver:	D023
S-Series:	1.11.0

- To determine the SB67030/031 Deskset software version, press **MENU**, then **4**. See the P Firmware version.

Deskset Information ▼	
Model No:	SB67030
Status:	Synchronized *
IP Address:	192.168.0.102
MAC Address:	00:11:A0:11:EA:4D
Serial No:	GG20013043
Boot Ver:	2.5.3
P Firmware Ver:	2.0
Use ▼ or ▲ to scroll. Press Exit when done.	
Quick Dial →	
Exit	

- To determine the software version of all installed devices, log in as administrator. See [“Log in as Administrator” on page 80](#). Then click [Detailed Site Information](#) to see the software versions and other information. There may be a delay as the system gathers this information.

Detailed Site Information				
PSTN GATEWAYS			MODEL: SB67010a	
Device ID	Lines Connected	IP Address	Software Version	Connected
PSTN GW-1	1,2,3	192.168.0.129	2.0	Yes
DESKSETS			MODEL: SB67xxx	
Ext Number	Model Name	IP Address	Software Version	Connected
200	030 Graham Bell	192.168.0.125	2.0	Yes
201	020 Mary Williams	192.168.0.130	2.0	Yes



System Installation Overview

Figure 1 illustrates how the Synapse system differs from conventional telephone systems in that calls are not coordinated by a central controller. Instead, the system uses a distributed control system over a new or existing LAN.

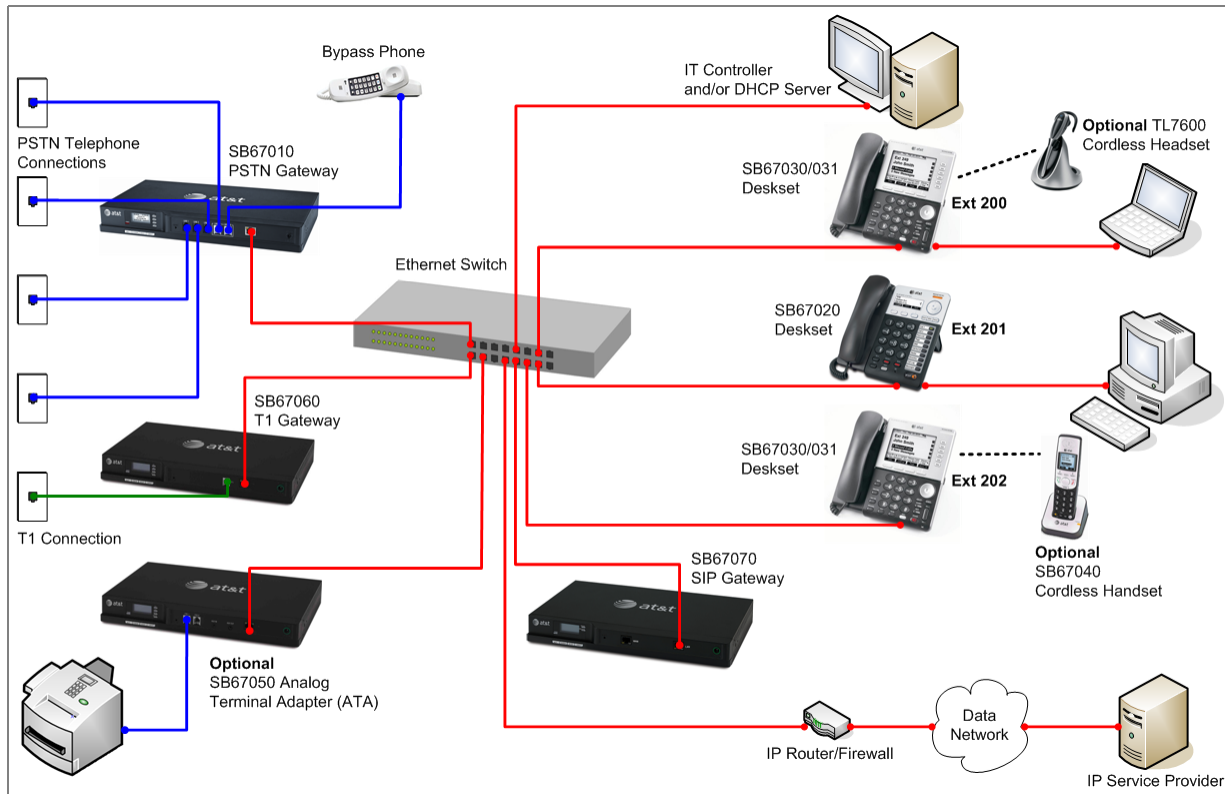

Figure 1. Sample System Network

A system must have at least one PSTN Gateway, one T1 Gateway, or one SIP Gateway. There can be up to four PSTN Gateways, and a system can include a T1 Gateway, SIP Gateway, and PSTN Gateways. Figure 2 illustrates the minimum components needed to make the system work (blue line = telephone; red lines = Ethernet).



The system uses a Local Area Network (LAN) for system communication. It uses Public Switched Telephone Network (PSTN) connections for outside calls.

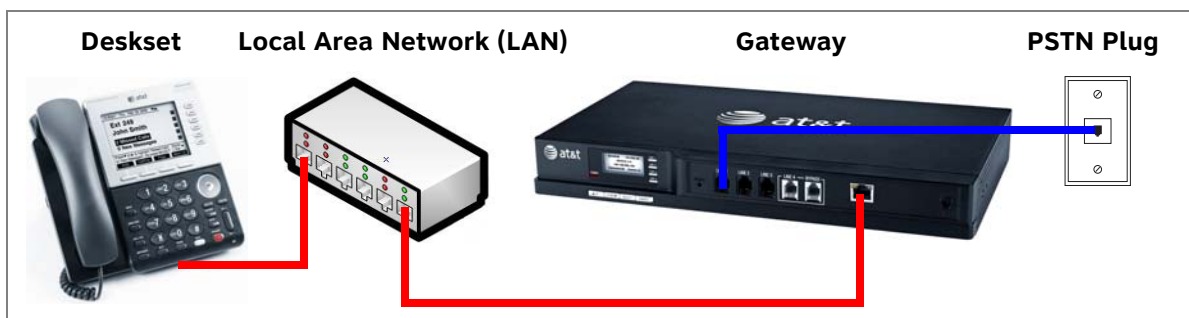

Figure 2. Simplified System (PSTN Gateway and SB67030/031 Deskset Shown)



System Installation Overview with Optional Analog Terminal Adapter

If you have analog devices that you want to attach to the system, you will need an AT&T SB67050 Analog Terminal Adapter (ATA). The Synapse system supports one ATA per system. The ATA allows you to attach hardware such as conference phones, overhead paging equipment, a fax machine, or a source for Music On Hold (MoH) to Synapse. Figure 3 illustrates a more complex installation (**blue** lines = telephone; **red** lines = Ethernet; **orange** lines = audio), but there are different options for attaching some of the equipment to the ATA.

Install the ATA after you have installed at least one Gateway and the Desksets.

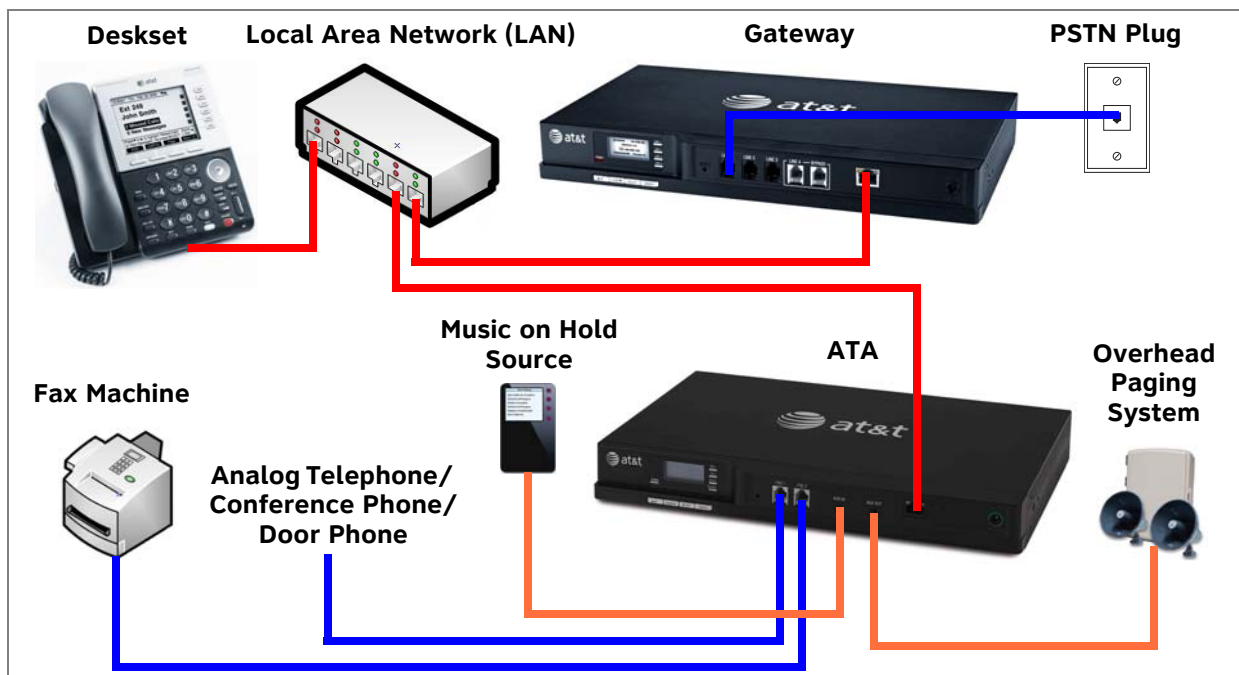

Figure 3. Example of a System Featuring an ATA

System Installation Overview for Remote Sites

If two separate Synapse systems both have SIP Gateways, then they can communicate with each other as “Remote Sites” on a privately managed network. Remote Sites allow users to make extension-to-extension calls between Synapse sites, thus avoiding long-distance charges. Users can also call external numbers at a Remote Site by routing a call through a remote Gateway, thereby completing a long-distance call as a local call.

To use Remote Sites, you must set up a dedicated router-to-router Virtual Private Network (VPN) between each site. This type of installation requires the following at each site:

- A router that supports simultaneous VPNs and IPsec. AT&T recommends using IPsec VPN.



NOTE

Ensure that you configure the VPN to allow communication between the two SIP Gateways by entering each Gateway’s private IP address into the VPN setup.

- A static Wide Area Network (WAN) IP address at both sites
- Each Synapse site should be on a different LAN subnet.

See also [“SIP Gateway Static IP Configuration” on page 16](#).

Configuring Remote Sites requires some coordination between the system administrators for each site. To configure Remote Sites, you must configure one Remote Site SIP Account for every other remote site. For more information, see “Configuring Remote Sites” in the Synapse Administrator’s Guide at www.telephones.att.com/synapseguides.

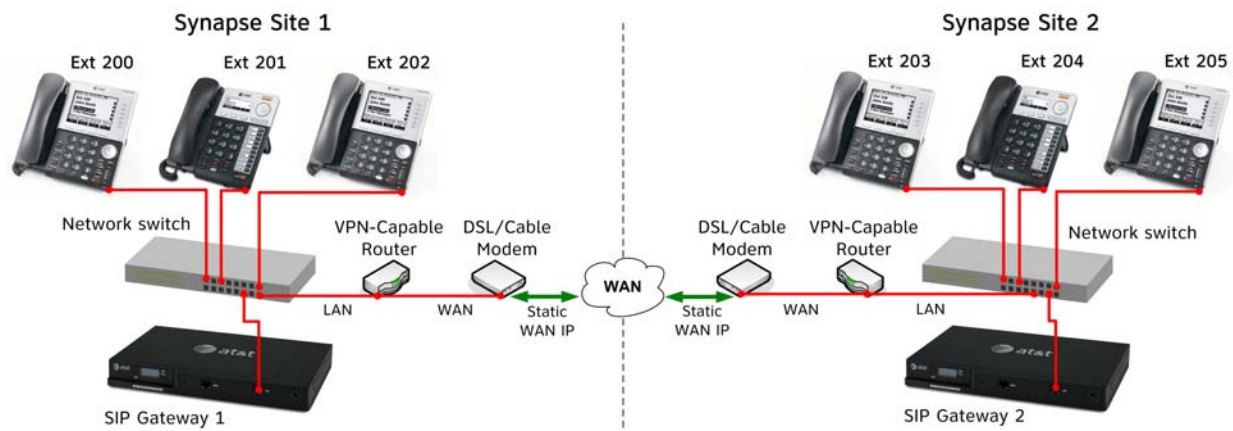

Figure 4. Example of Remote Site Installation



Recommended Installation Sequence

1. Prepare your site for installation. See [“Site Preparation” on page 26](#).
2. Install the Gateway(s). See [“Gateway Installation” on page 35](#).
3. If you have only one Gateway, install the first Deskset. See [“Deskset Installation” on page 38](#). This Deskset is assigned extension number 200 with no Direct Inward Dialing.
4. If necessary, use the WebUI to change the mode of operation from Call Appearance mode to Line Appearance mode. See [“About Modes of Operation” on page 15](#).

**NOTE**

You cannot enable Line Appearance mode if a T1 Gateway or SIP Gateway is installed in your system. Line Appearance mode is not compatible with the T1 Gateway and SIP Gateway.

5. Configure the Dial Plan Settings and **[T1/SIP]** Direct Inward Dialing (DID). Unless you do this, the other Desksets will be assigned sequential three-digit extension numbers starting with 201 and without DID numbers.



For more information about Dial Plan and DID configuration, see the Synapse Administrator’s Guide at www.telephones.att.com/synapseguides.

Use the WebUI to change the Dial Plan Settings if you want the first extension digit to be something other than 2, possibly to correspond to the DID numbers, or if you want the parked-call extension numbers to start with a digit other than 1.

After changing the Number of Digits and Default Phone Extension Prefix, manually change the extension number of the first Deskset you installed, and manually set its DID number.

Changing the number of extension digits after installing some Desksets may result in undesired extension number re-assignment, where the last three digits of previous extension numbers may not be preserved.

6. Install the other Desksets. See [“Deskset Installation” on page 38](#).
7. **Optional:** Install the AT&T SB67050 Analog Terminal Adapter (ATA). See [“SB67050 ATA Installation” on page 45](#). If you install the ATA with phones or a fax machine connected to an FXS port before installing a Deskset, that device will default to being the operator. Install the ATA after installing at least one Deskset so that a Deskset is the default operator.
8. Connect any analog device such as a fax machine, paging system, or door phone to the ATA. For more information, see:
 - [“Connecting Analog Telephones” on page 45](#)
 - [“Connecting a Fax Machine” on page 46](#)
 - [“Connecting an Overhead Paging System \(OHP\)” on page 47](#)
 - [“Station Port \(FXS\) Door Phone Support” on page 23](#).
9. Configure the system using the WebUI.



 See *“System Configuration” on page 78* and the Synapse Administrator’s Guide at www.telephones.att.com/synapseguides.

10. Complete post-installation tasks.

- If you have set the system to use Call Appearance mode, ask all users to record their user names on their Desksets.

 See *“Name Recording for the Auto Attendant Directory”* in the Synapse Administrator’s Guide at www.telephones.att.com/synapseguides.

- If you have set the system to use Call Appearance mode, distribute and register any Cordless Handsets or Headsets. Synapse Cordless Handsets are not compatible with Line Appearance mode. See *“SB67040 Cordless Handset Installation” on page 50* and *“TL7600 Cordless Headset Installation” on page 53*.
- Check for software upgrades and register your Synapse system products. See *“Updating Devices” on page 91* and *“Product Registration” on page 94*.



Planning Your System and Network Configuration

This section describes several important configuration options that you should be aware of before you install the Synapse system. These options include Operation Mode (Call Appearance versus Line Appearance), IP addresses and connectivity, extension number assignments, analog bypass lines and analog telephones in the Synapse system.

About Modes of Operation

The system administrator can configure the Synapse system to operate in one of two different modes: Call Appearance mode and Line Appearance mode. The operation mode affects how Deskset users make, answer, and manage calls. Each mode provides a unique set of configurable features.

Before beginning the installation, you and the system administrator should decide which mode will work best for the site.

Call Appearance Mode

In Call Appearance mode, each Deskset has virtual “lines” (5 on SB67030/031 Desksets, and up to 10 on SB67020 Desksets) for calls to and from external numbers (232-555-0176, for example) or other extensions (Extension 220, for example). These virtual lines are called Call Appearances.

Systems using Call Appearance mode can have any combination of PSTN Gateways, T1 Gateway, SIP Gateway, and an optional ATA. In Call Appearance mode, SB67030/031 Desksets can have SB67040 Cordless Handsets and TL7600 Cordless Headsets.

Line Appearance Mode

In Line Appearance mode, each line that Deskset users can access corresponds to an actual physical line connected to the PSTN Gateway (the Synapse system can have up to four PSTN Gateways providing up to 16 lines). Incoming lines are mapped to Programmable Feature Keys on Desksets. You can assign different lines to different Desksets or groups of Desksets. You can configure SB67020 Desksets to access up to 9 lines and SB67030/031 Desksets to access up to 4 lines.

Other Desksets in the system can share these lines and display the line status. Incoming calls on a line ring at all Desksets that share that line. Users at Desksets that share lines can see when lines are ringing, busy, or on hold.

Systems using Line Appearance mode must use PSTN Gateways only. An optional ATA is also compatible with Line Appearance mode. For more information, see [“ATA Fax Line Configuration” on page 29](#). A system using Line Appearance mode cannot support the T1 Gateway, SIP Gateway, Ring Groups, Call Queue and some Deskset-specific features.



For more information, see the Synapse Administrator’s Guide at www.telephones.att.com/synapseguides.

In Line Appearance mode, SB67030/031 Desksets cannot use SB67040 Cordless Handsets, although TL7600 Cordless Headsets are compatible with Line Appearance mode.



IP Addresses and Connectivity

An IP address is an individual numeric identification assigned to devices on a computer network. At least one Synapse device needs a network-assigned IP address on the subnet shared with any computers that will allow access to the WebUI. Valid IP addresses on the same subnet allow devices on the network to identify each other and enable communication.

This IP address may be assigned from a Dynamic Host Configuration Protocol (DHCP) server, or set statically to the same subnet, and will be separate from the self-assigned 169.254.xxx.xxx link-local address that the Synapse devices use to communicate with each other. When setting up the IP address on a Synapse device, this network IP address used for WebUI connectivity is the only address you can change.

The network IP addresses can be assigned in two ways:

1. The Synapse device can request a network server to automatically assign an IP address. This IP address is a dynamic assignment; the address is on lease from the server. The lease is renewed as long as the device remains connected and there is no change to the network. However, if the device is disconnected, or if there is a network or AC power interruption, the lease may not be renewed (that is, the IP address expires) and a new IP address may be assigned.

Most LANs use servers to automatically assign IP addresses. Synapse defaults to assuming that this automatic assignment will occur.



Some servers have default settings that limit the number of network IP addresses assigned to devices on the network. You should log in to your server to confirm that the IP range is sufficient to accommodate at least one of the Synapse devices that you are adding as at least one Synapse device needs an assigned IP address to enable WebUI configuration activities. Consult the IT department if you need help checking the server.

2. The Synapse Administrator can manually assign a static system IP address. This IP address does not change, even when there are network or AC power interruptions. Some installations will require manual static IP assignment. You can assign a static IP address for a Gateway or ATA using the device front panel interface. See [“Gateway Configuration” on page 64](#).

A switched-network topology is recommended. This topology refers to the network virtual shape or structure and does not necessarily reflect the physical layout. Switched networks involve connecting the network components to switches rather than hubs; this improves network communication.

SIP Gateway Static IP Configuration

If your SIP service provider requires static registration for a SIP Gateway, please ensure that:

- The SIP Gateway uses the same IP address, preferably via a static mapping in the DHCP Server. If this is not possible, you can configure a static IP address using the SIP Gateway’s front panel.
- Port forwarding on your router is configured to route UDP 5060 traffic from the WAN side to the SIP Gateway LAN IP address.



SIP ALG (application-level gateway) functionality may be required if the SIP service provider does not use hosted NAT traversal.

Extension Assignments

The system assigns the first Deskset to join the network as extension 200. At this point you can use the Dial Plan Settings page in the WebUI to set a different first digit for extension numbers for Desksets that will be connected to the network. The WebUI calls this the Default Phone Extension Prefix. If desired, you should also change the number of digits from three to four at this point.

The system automatically assigns each additional Deskset an extension number in ascending order as it is connected to the LAN.

Once the Desksets are connected to the same network, they find each other through Peer-to-Peer (P2P) discovery protocols and automatically self-configure. Additional telephony and network configuration is administered through the WebUI.

Even if you unplug a unit, its extension number is reserved. If you want to remove an extension from the network, you must delete the extension number using the WebUI **Device Management** menu. Deletion ensures that the Deskset does not tie up an extension. You can use the WebUI to change or delete extension numbers.

If your site is one of several Remote Sites using SB67070 SIP Gateways, depending on your dial plan and other configuration, you may want to ensure that extension numbers do not overlap with the Remote Sites. You can prevent overlap either by choosing a unique first digit (Default Phone Extension Prefix) or by restricting your extension numbers to a range. For example, your site uses 200 to 249, while another site uses 250 to 299.



For more information, see the Synapse Administrator's Guide at www.telephones.att.com/synapseguides.



Connecting Analog Devices to the ATA

The ATA allows you to attach the following analog devices to the ports and jacks identified in [Figure 23 on page 45](#). Most options require the system administrator to configure the feature in the WebUI. If you are planning to install more than one type of analog equipment, make sure there are suitable ATA ports available and configured.

- Analog telephones, including conference phones

If not used for a fax machine or for Overhead Paging, the two FXS station ports on the ATA allow for connecting standard POTS (Plain Old Telephone Service) analog telephones and conference phones. When an ATA is added to the Synapse system, the FXS ports are automatically assigned extension numbers that can be changed by the system administrator using the WebUI. Users can make and receive calls on those analog telephones, but system features such as Hold, Call Forward, and Transfer are not supported. You can use the WebUI to assign features such as Ring Group, Auto Attendant menus, and Call Forward–No Answer targets to an analog telephone.

An analog telephone connected to an FXS port can be used for Private Line Automatic Ringdown (PLAR). When you enable the PLAR feature through the WebUI, an analog telephone or device connected to an ATA FXS port will ring a destination when it goes off hook.



For more information about configuring a PLAR destination, see “PLAR Setup” in the Synapse Administrator’s Guide at www.telephones.att.com/synapseguides.

- A single fax machine to share your general telephone lines instead of using a dedicated fax line

See “[ATA Fax Line Configuration](#)” on [page 29](#). One of the two FXS station ports can be configured to support a fax machine. The system administrator must configure the Fax mode in the WebUI.



For more information about fax configuration and ATA configuration, see the Synapse Administrator’s Guide at www.telephones.att.com/synapseguides.

- Overhead Paging Equipment (OHP)

See “[Overhead Paging Overview](#)” on [page 20](#). The ATA provides three options to connect OHP. The system administrator must configure the OHP in the WebUI.

- Single-zone paging with OHP equipment connected to the ATA Aux Out jack
- Single-zone paging with OHP equipment connected to one of the FXS station ports
- Multi-zone paging with OHP equipment connected to one of the FXS station ports.



- Loud Ringers

Loud Ringer devices must be connected to an FXS port assigned as Voice (default setting). Loud Ringers can be used for alerting users of an incoming call via a loud speaker and are treated within Synapse as a regular analog phone instead of OHP equipment. This type of overhead alerting can only be done by including the voice FXS port in a Ring Group.

- A source for Music On Hold (MoH)

You can use the ATA to route MoH audio input to outside held, parked, or queued calls. When external callers are placed on hold, parked, or enter a call queue, they hear the audio source provided by the MoH input. The system administrator must configure the MoH in the WebUI. For more information, see [“Connecting a Music on Hold Source” on page 49](#).



For MoH WebUI configuration, see “Hold Settings and Music on Hold (Requires ATA)” in the Synapse Administrator’s Guide at www.telephones.att.com/synapseguides.

- Door phone

See [“Station Port \(FXS\) Door Phone Support” on page 23](#).



Overhead Paging Overview

You can set up either single or multi-zone external overhead paging (OHP), as shown in Table 2, but only one OHP system can be connected to the ATA. You can also use a loud ringer device, either on its own or with your existing OHP paging system, if supported. For more information, see [“Loud Ringers” on page 19](#).

Synapse supports most OHP systems that can connect to PBX Analog Station (FXS) ports as well as those that support direct Audio Input detection, also known as VOX Detect. This overview describes the differences between OHP systems and is intended to help you determine how your system connects to the ATA. You should also refer to your OHP system's product documentation for installation and configuration instructions or contact your OHP equipment provider.

Table 2. Single- vs. Multi-Zone Overhead Paging Systems

Single-Zone Paging	Multi-Zone Paging
Broadcasts to all overhead speakers at once.	Broadcasts to speakers grouped into separate zones.
Can be included in a Synapse Paging Zone.	Cannot be included in a Synapse Paging Zone because the multi-zone OHP cannot be paged together with Desksets.
Does not appear in the Deskset Paging Zones menu unless you add Single-Zone paging to a paging zone you create.	Automatically appears in the Deskset Paging Zones menu as Overhead Paging .
Requires no additional user input to initiate a page.	Requires using the Deskset dial pad to enter digits to address the OHP paging zone.
For a connection through a FXS port, requires you to set a delay determined by trial and error. This delay, which starts after the user presses Start , gives the paging equipment time to prepare to broadcast the message. It is required for every page, even if the OHP is not the chosen paging zone.	There is no programmed delay as the paging equipment provides feedback to the user when to start speaking.
Can be connected to an FXS port or the AUX Out jack.	Must be connected to the FXS port.

If your OHP is single-zone, you will have to decide whether it requires an FXS connection or an AUX OUT connection. You can only connect a multi-zone OHP to an ATA FXS port, i.e. a multi-zone OHP system cannot be connected to the AUX OUT port.

Equipment that can interface with the AUX OUT jack can have no “intelligence” in its audio output. It doesn't require any exchange of signals to be ready to broadcast.

Equipment that uses an FXS port must be able to go on and off hook, because the FXS ports use telephone signals to exchange information. The OHP generally includes some sort of controller or telephone interface, which often requires setting up, for example, “PABX loop start trunk port access”, or “RJ-11 for Tip and Ring connections”.





Even if the OHP has no RJ-11 jack, it may still have a Tip/Ring interface, requiring hard wiring. Whenever possible, try both the AUX OUT jack and an FXS port to find the best configuration for your needs.

To install an OHP system, see [“Connecting an Overhead Paging System \(OHP\)” on page 47](#). There are three possible OHP configurations.



For OHP WebUI configuration, see [“Overhead Paging Overview \(ATA Required\)”](#) and [“Creating, Editing and Deleting Paging Zones”](#) in the Synapse Administrator’s Guide at www.telephones.att.com/synapseguides.

Single-Zone Paging

Single-zone paging means that all speakers connected to the OHP system are activated together (that is, they are in the same zone).

Single-Zone OHP equipment connected to the AUX OUT jack:

Use this configuration to connect single-zone paging equipment that uses a 3.5 mm audio jack as input. For example, use this configuration if the OHP device is just an amplified speaker. See [Figure 26 on page 48](#) for connection details. Verify that the OHP input levels are compatible with ATA level. See [“Appendix A: Technical Specifications” on page 143](#). Only single-zone paging is supported in this configuration.



Figure 5. Single-Zone Overhead Paging on AUX OUT Jack

Single-Zone OHP equipment connected to one of the FXS ports:

Use this configuration to connect paging equipment that interfaces through a telephone line. Typically, any OHP that connects to an FXS port has some intelligence to go off and on hook or otherwise send a signal back to the pager. These are generally controllers or telephone interfaces with controls and settings.

In this configuration, you can specify a paging delay on the WebUI to compensate for the fixed delay introduced by the OHP system. This delay ensures that the paging tone is played simultaneously on both Desksets and on the OHP system.





Figure 6. Single-Zone Overhead Paging on FXS Port

Multi-Zone Paging

Broadcasts to speakers grouped into separate zones. Since the multi-zone OHP systems require zone selection, they cannot be combined into one zone together with Synapse Desksets.

Multi-Zone OHP equipment connected to one of the FXS ports:

When paging is configured as a multi-zone OHP, a dedicated **Overhead Paging** zone automatically appears as the last entry in the Deskset paging menu.



Overhead paging cannot be added to Synapse-specific paging zones because the multi-zone OHP cannot be paged together with Desksets.



Figure 7. Multiple-Zone Overhead Paging on FXS Port



The OHP system may have settings that need to be adjusted to work with Synapse. Refer to your OHP system's product documentation for installation and configuration instructions.

Desksets and single-zone OHPs can be included in the same zone. In the case of a single-zone OHP connected to the FXS port, this Paging System and the Desksets generate different paging tones. Note that users hear both tones at the same time if the paging delay is set properly in the WebUI settings.



Verified Overhead Paging Devices

Table 3 lists OHP systems that have been demonstrated to work with the Synapse System as of the publication of this document. More OHP systems may also have qualified for this list. For more information, call **1 (888) 916-2007**. In Canada, dial **1 (888) 883-2474**.

Table 3. [ATA] Verified Overhead Paging Devices

Single Zone	Multi Zone
Aux Out Jack <ul style="list-style-type: none"> • Bogen TPU35B • Valcom 1030c 	FXS Port <ul style="list-style-type: none"> • Bogen PCM 2000 • Bogen PCM TAMB • Bogen TPU15A or TPU35B • Bogen ZPM3
FXS Port <ul style="list-style-type: none"> • Bogen TAMB • Bogen TPU15A • Bogen TPU35B (alternate to TPU15A) • Viking CPA-7B • Valcom V-9940 (expandable for multi-zone) • Valcom V-9941A (with talkback) 	

Door Phones Overview

Door phones and their associated door-entry mechanisms have become a common accessory in business phone systems. Door phone systems provide an easy method for Deskset users to attend to someone who is present at a door elsewhere. Synapse supports two types of door phones: Station Port (FXS) and Trunk Port (FXO). The system lets you select which Desksets will be notified by the door phone.

A Deskset user can send DTMF digits from the Deskset to the door phone to activate associated door-latch and relay mechanisms. How the door phone operates using a Deskset and the method to control a door latch varies with the door phone model.

Station Port (FXS) Door Phone Support

This type of door phone emulates a regular analog phone and can be connected to either FXS1 or FXS2 of a Synapse SB67050 ATA as shown in Figure 8. For single-button door phones a feature called Private Line Automatic Ringdown (PLAR) is supported. With PLAR configured in Synapse, as soon as the phone goes off-hook it will cause the configured extension(s) to ring with a pre-set Caller ID. Any Synapse extension can call the associated extension of the ATA port connected to the Doorphone.

In Call Appearance mode, you can configure PLAR to ring either a single extension or group of extensions (a Ring Group) when the door phone goes off hook. In Line Appearance mode, you can configure PLAR to ring a single extension.





Figure 8. Station Port (FXS) Door Phone Connection

Trunk Port (FXO) Door Phone Support

You can connect a Trunk Port (FXO) door phone to any one of the four Line (FXO) ports on a Synapse SB67010 PSTN Gateway as shown in Figure 9. The FXO door phone can be configured to call either a single extension or a group of extensions (a Ring Group). You can use the WebUI to configure an FXO door phone. For more information, see [“Configuring a Trunk Port \(FXO\) Door Phone” on page 85](#).

In Call Appearance mode, Synapse requires a dedicated door phone line to be Trunk Reserved to a spare Deskset in order for other Desksets not to seize that line for outbound calls. If there are no extra Desksets available for Trunk Reservation, the door phone should be connected to the last, or closest to last, line of the last Gateway to limit the chance of the door phone line being seized.

In Line Appearance mode, the Deskset user must be aware not to use the assigned line key for regular outbound telephone calls. Desksets automatically select a line when going off-hook, so the Deskset will seize an assigned door phone line if all other lines are busy.

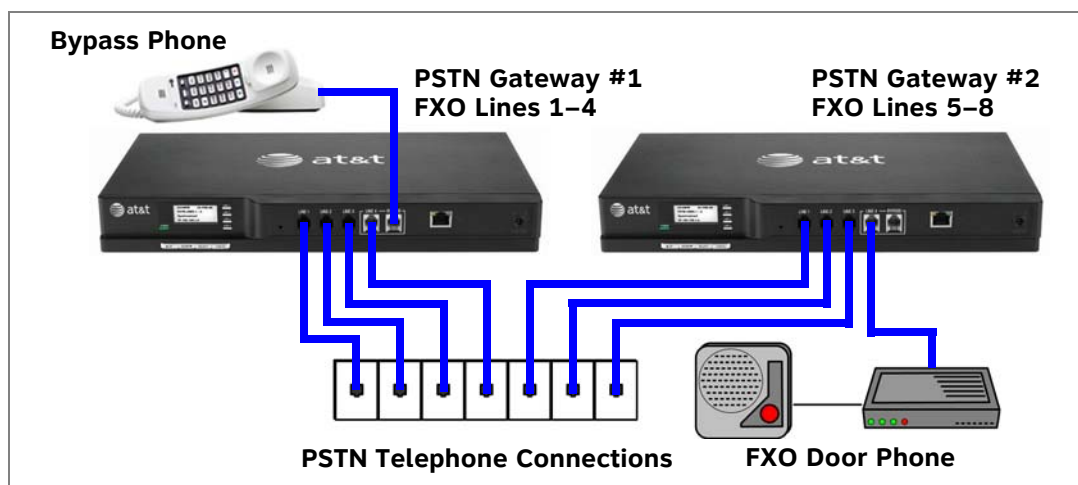

Figure 9. Trunk Port (FXO) Door Phone Connection

Tested Door Phone Models

Table 4 lists door phones that have been demonstrated to work with the Synapse System as of the publication of this document. More door phones may also have qualified for this list. For more information, call **1 (888) 916-2007**. In Canada, call **1 (888) 883-2474**.

Table 4. Verified Door Phones

PSTN Gateway Compatible Trunk Port (FXO) Door Phones	ATA Compatible Station Port (FXS) Door Phones
<ul style="list-style-type: none">■ ALGO 3226 Trunk Port Door Phone (with 3201 Digital Door Station)■ Valcom V-2900 Trunk Port Door Phone■ Valcom V-2901 Trunk Port Door Phone	<ul style="list-style-type: none">■ ALGO 3008 Station Port Door Phone (with 3106 Door Control Module)■ Viking E-30 (with SRC-1 Door Control Module)



Site Preparation

This section describes how to prepare your site for a successful Synapse system installation.

Network Requirements



For more information on the network configuration, see [“Planning Your System and Network Configuration” on page 15](#).

- A switched network topology is recommended for your LAN (using standard 10/100 Ethernet switches that carry traffic at a nominal rate of 100 Mbit/s).
- The office LAN infrastructure should use Cat.-5 (or better) cable.
- The LAN connections to Synapse devices should all be wired. However, wireless connections to other devices (such as laptops) in your office network that are not part of the Synapse system will not impede performance.
- All devices in the Synapse system must reside on a single subnet.
- A DHCP server is recommended and must be on the same subnet as the Synapse system so that IP addresses can be auto-assigned. If no DHCP server is present, you can assign static IPs if desired. DHCP or static IPs are only required if the system is to be managed from a routable network and/or automatic time updates from an NTP server are desired. Synapse devices will self-assign link-local IP addresses for all voice communication in addition to any DHCP or static IPs that are assigned for management purposes.
- Unless you want to manually set the Synapse clock and manually upgrade Synapse software, an Internet connection to the LAN is required.
- A DNS server is recommended to resolve the path to the Internet and to the AT&T server for software upgrades.
- If a routing path to the Internet is not available, the system administrator can download the upgrade files and use the WebUI to upgrade the software manually.
- For users whose computers require a GigE Ethernet frame rate (a gigabit per second), use separate Ethernet connections for the Deskset and the computer. The Ethernet connection through a Deskset is limited to 100 Mbits/s.

Placement Considerations

Avoid placing any Synapse component too close to the following:

- Communication devices, such as television sets, DVD players, or other cordless telephones
- Excessive heat sources
- Noise sources, such as a window with traffic outside, motors, microwave ovens, refrigerators, or fluorescent lighting
- Excessive dust sources, such as a workshop or garage
- Excessive moisture



- Extremely low temperature
- Mechanical vibration or shock, such as on top of the washing machine or workbench.

ATA Placement Considerations

You can install the optional ATA near the Gateway, or near one of the third-party devices that are being used with it. For example, it might be easier to connect the ATA to the fax machine in the room with the fax machine instead of running a telephone line connection from the fax to an ATA located in a telephone equipment cabinet.

Power Considerations

Ensure that there is an electrical outlet not controlled by a wall switch within 6 feet (1.83 m) of each device location.

SB67020 Desksets and SB67031 Desksets are also compatible with Power over Ethernet (PoE). To use PoE, your network needs a switch that provides PoE. Using PoE simplifies your installation by eliminating the need to route separate power cords. It also allows you to protect your system from power outages by connecting an Uninterruptible Power Supply (UPS) to your PoE switch, Gateways, and ATA. For power requirement specifications, see page 144.

Other Preparations

Before installing the Gateway and Desksets, the following preparations may need to be taken:

- All PSTN lines must be gathered into one access point situated no more than 9 feet (2.74 m) from the Gateway location. If rewiring is required, contact your telephone service provider and request the help of a qualified technician.
- You may need one or more network switches set up to ensure there are sufficient ports available for other devices in the network (such as a DSL modem).
- If you plan to use the emergency bypass feature on the PSTN Gateway, you will need an analog phone.
- An Ethernet Port must be available within 9 feet (2.74 m) of each Deskset location. Each Deskset is capable of sharing an Ethernet port with a PC. If one Ethernet port already exists at a workstation, another port is not necessary unless you need a GigE Ethernet frame rate. Use a separate Ethernet connection for the Deskset and the computer.



Assigning Telephone Lines and Extensions

This section discusses various telephone line configuration issues to consider.

Providing Limited Telephone Service During AC Power Outages

PSTN Gateway

The fourth line on each PSTN Gateway is a Bypass port that works during AC power failures. If you have a PSTN line plugged into **LINE 4**, connect a line-powered analog telephone to the RJ-11 jack labeled **BYPASS** for telephone service during power failures. When power returns, a relay disconnects this emergency bypass line so that the bypass line cannot be used to eavesdrop on normal calls.

If your telephone lines are part of a hunt group (a telephone company feature that allows calls to a busy phone number to roll over to the next available telephone line), connect the line with your main (pilot) telephone number to PSTN Gateway **LINE 4**.

If your system features both PSTN Gateways and a T1 Gateway, outbound calls are placed first through the T1 channels by default.

T1 Gateway and SIP Gateway

The T1 Gateway and SIP Gateway provide no analog bypass port. To provide telephone communication during power outages, either subscribe to at least one analog phone line and install a PSTN Gateway or use uninterruptible power supplies to provide power to your computer network, the Synapse T1 Gateway or SIP Gateway, and one or more system Desksets.

Analog Line Connection Order on PSTN Gateways

For outgoing calls, the system first seizes the lowest idle PSTN port numbers (as labeled on the PSTN Gateway). PSTN phone lines should be connected to your system with your busiest incoming line placed in the highest port number on the highest numbered PSTN Gateway, so that incoming calls are less likely to receive busy signals. For instance, if your customer service team receives many calls, you would want to plug their phone lines into higher-numbered PSTN ports.



ATA Fax Line Configuration

To support fax on the Synapse system, you should consider where the fax is, and which telephone line will be used for incoming faxes. Fax line configuration for the Synapse system differs depending on whether you are using a PSTN Gateway or a T1 or SIP Gateway.



For more information about fax configuration and ATA configuration, see the Synapse Administrator's Guide at www.telephones.att.com/synapseguides.



Figure 10. Fax Machine Connected to FXS Port

PSTN Gateway

The PSTN fax line can be connected to any FXO port (**LINE 1–4**) on the PSTN Gateway. However, trunks for outgoing calls are seized in ascending order (**LINE 1** then **LINE 2**, and so on). To avoid using the fax line for outgoing voice calls, make the fax line the highest possible numbered line on the highest numbered Gateway. Use the **Fax Configuration** page in the WebUI to select a telephone line on the PSTN Gateway as the fax line.

If your office has heavy fax volume, the fax line should be a separate dedicated line, and not part of a hunt group.



NOTE

Line Appearance mode only—Do not assign the PSTN fax line to any Programmable Feature Keys on Desksets.



For more information, see the Synapse Administrator's Guide at www.telephones.att.com/synapseguides.

Call Appearance mode only—If your office has low fax volume, your telephone service provider may be able to include your fax line in the hunt group. This way, you can save on the expense of a separate fax line. In this scenario, you can maximize your system for voice usage while maintaining the capacity to send or receive the occasional fax.

You should consider the following issues when fax and voice calls share a PSTN Gateway line:

- Incoming calls that get routed through the PSTN Gateway fax line are automatically checked by the system for a fax signal. If the system detects incoming fax tones, it routes the call through the configured ATA FXS port to the fax machine. Voice callers will experience a delay of up to eight seconds before the call is connected to the Auto Attendant or Operator. In addition, during the



delay, the ringback tone generated by the CO (Central Office) is no longer heard by the caller. Instead, the caller hears the ringback tone generated by the Gateway.

- For outgoing calls, the caller ID of the fax number may be sent instead of the primary business telephone number. If the recipient returns a missed call via their caller ID log, the caller will then experience the eight-second delay mentioned above.

T1 Gateway and SIP Gateway

When a T1 Gateway and/or SIP Gateway is installed, you can assign a DID number for the fax machine on the **DID Assignments** WebUI page. Incoming faxes are routed directly to that DID number (with no eight-second delay).



Gateway and ATA Placement

You can place the Gateway or ATA on a tabletop, mount it into a standard 19-inch metal rack, or wall mount it. The PSTN Gateway must be installed within three feet of the building ground point. Install each device using the following instructions.

Rack Mounting

To mount the Gateway or ATA into a standard 19-inch rack:

1. Remove the two mounting brackets and six screws from the packing tissue.
2. Position a bracket at the front of the device.
3. To align the screw holes, place the bracket on the device so that the locating indent on the bracket matches the indent on the device.

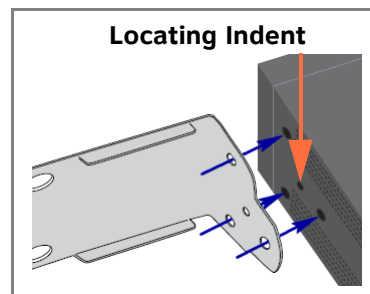

4. Insert each of the three screws into the holes provided and tighten securely. Repeat the process for the other bracket.

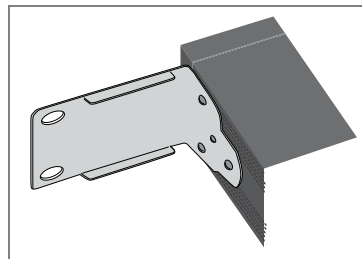

5. Position the chassis into the 19-inch metal rack.



6. Insert a top mounting screw (not included) in one side and turn it several turns to establish support. Repeat for the other side.
7. Tighten the screws.

Wall Mounting

You can mount the Gateway or ATA to a wall using the two mounting slots on the bottom of the device. Ensure that the device is oriented as shown in Figure 11 to allow air to flow vertically through the ventilation holes on each side of the device.

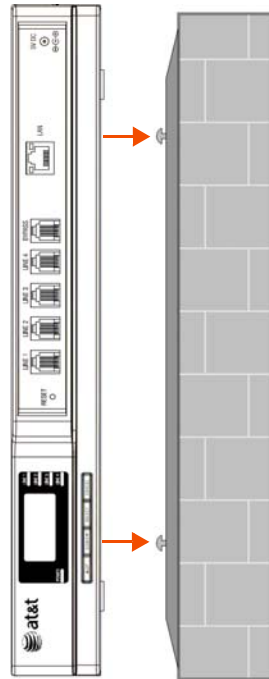

Figure 11. Wall Mount Orientation

To mount the Gateway or ATA to a wall:

1. Install two pan-head screws (with $\frac{1}{4}$ -inch diameter head) 7 $\frac{7}{8}$ inches (20 cm) apart. The screw shaft diameter should be $\frac{1}{8}$ -inch (3.2 mm). Ensure you use anchors appropriate for your mounting surface. Leave about $\frac{1}{8}$ -inch (3.2 mm) clearance between the screw head and the wall.
2. Position the device with the mounting slot centers aligned over the mounting screws. Carefully bring the device down onto the screws.
3. Slide the device downwards so that the screws go into the mounting slots on the device. Ensure the device is secure.



Grounding

The SB67010 PSTN Gateway, SB67060 T1 Gateway, SB67070 SIP Gateway, and the SB67050 Analog Terminal Adapter must be connected to reliable earth ground. The connection to earth ground must be verified by qualified personnel.

The SB67010 PSTN Gateway must be connected to reliable earth ground using the supplied ground wire connected to a terminal on the back of the Gateway chassis.

The SB67060 T1 Gateway and SB67070 SIP Gateway must be connected to reliable earth ground through a separate ground wire connected to a terminal on the back of the Gateway chassis before connecting the T1 cable or LAN cable.

The SB67050 Analog Terminal Adapter is connected to earth ground through a properly grounded wall outlet. Additional grounding may be necessary for the ATA if you need to improve immunity to Electrostatic Discharge (ESD) and to minimize the possibility of electrical interference when using third-party audio equipment.

To provide additional grounding, the ATA can be connected to reliable earth ground through a separate ground wire connected to a terminal on the back of the ATA chassis.

To ground the Gateway or ATA:

1. Acquire a grounding cable of 18 AWG or greater gauge. For the PSTN Gateway, use the supplied grounding cable.
2. Locate the device near the building ground point, usually located at the electrical breaker box. The PSTN Gateway must be within three feet (91.4 centimeters) of the building ground point.

WARNING  If you are unsure about the location of the building ground point or how to ground the device, contact the facilities manager.

3. Loosen the grounding terminal screw on the back of the device, as identified in Figure 12 and Figure 13.

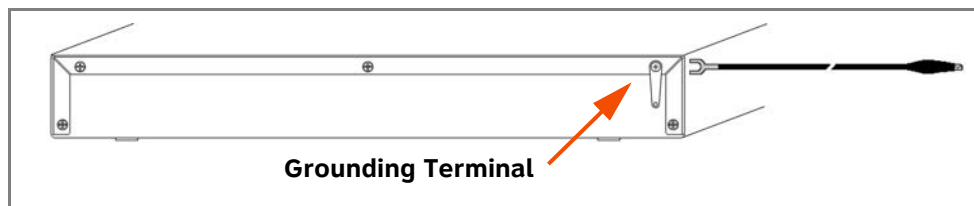

Figure 12. PSTN Gateway Grounding

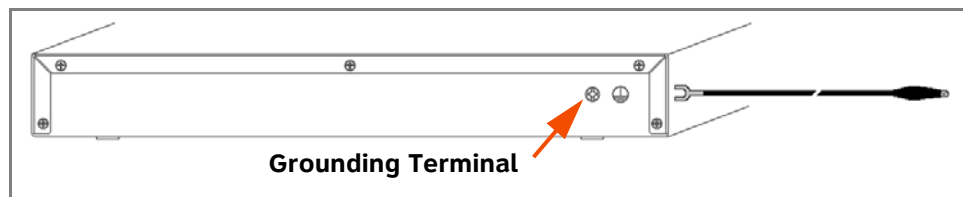

Figure 13. T1 Gateway, SIP Gateway, and ATA Grounding

4. Insert the end of the grounding cable under the grounding terminal.

5. Tighten the screw.
6. Connect the other end of the grounding cable to the building ground point, usually located at the electrical breaker box.



Gateway Installation

To install the Gateway:

1. Install a Gateway first. Plug the AC plug into an electrical outlet not controlled by a wall switch and the DC plug into the DC jack, as shown in Figure 14. Wait up to one minute until the screen lights up.
2. Plug a gray Cat.-5 LAN cable for the PSTN Gateway or SIP Gateway or yellow Cat.-6 LAN cable for the T1 Gateway into the Ethernet port marked LAN. Use the supplied cables or a comparable substitute. Plug the other end of the cable into your office LAN. The T1 Gateway is Gigabit Ethernet (GigE) capable, so it has a Cat.-6 LAN cable. The Desksets and other devices require only Cat.-5 cables.

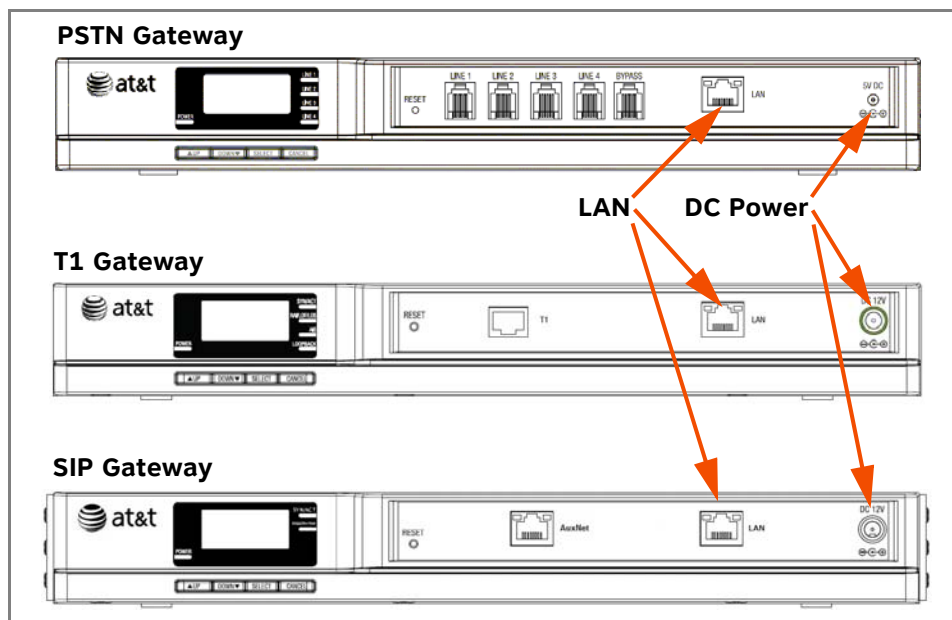

Figure 14. Gateway Power and LAN Connections

The Gateway takes about a minute to power up.

After another Synapse device is installed, and after the Gateway has found the network and the other Synapse device, **Synchronized** appears on the third line of the display as shown in Figure 15 (PSTN Gateway shown). This is the Idle screen.

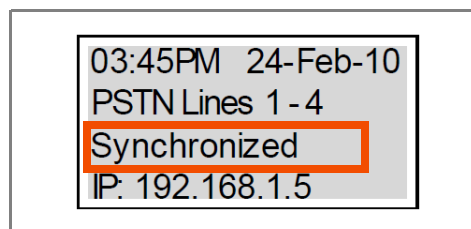



Figure 15. Gateway Idle Screen, Synchronized

The time and date may not be correct. You can set the time and date on the **System Basic Settings** page in the WebUI or using the Deskset **Admin Settings** menu.



 For more information, see the Synapse Administrator's Guide at www.telephones.att.com/synapseguides.

To connect the PSTN Gateway telephone lines:

1. Remove the plastic covers from the Gateway PSTN (telephone) jacks to be used, marked **LINE 1** through **LINE 4** and **BYPASS**, as shown in Figure 16.

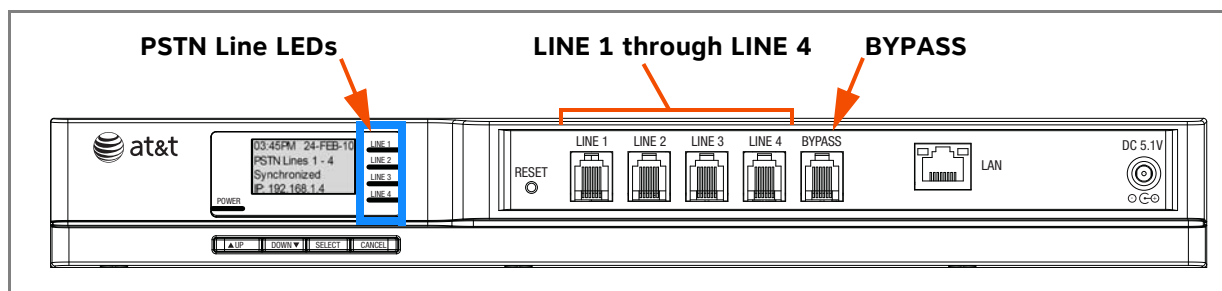

Figure 16. PSTN Gateway Telephone Line Connections



NOTE If your service provider uses Centrex lines, you must use the WebUI to enter a line access code to allow calibration to take place. Before connecting the PSTN lines, see ["Line Calibration Configuration" on page 90](#).

2. Plug up to four telephone lines from the telephone wall jacks into the Gateway. The line LEDs blink for up to 15 seconds during initialization.



CAUTION If you subscribe to Digital Subscriber Line (DSL) high-speed Internet service through your telephone line, you must plug each telephone line with DSL service into a DSL filter. Then plug the DSL filter into the telephone wall jack, as identified in Figure 17.

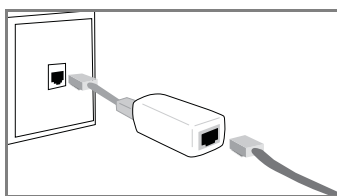

Figure 17. DSL Connection



NOTE For customer service or product information, visit our website at www.telephones.att.com/smb or call **1 (888) 916-2007**. In Canada dial **1 (888) 883-2474**.



To connect the T1 Gateway T1 cable:

Plug the black T1 cable into the Gateway T1 Port, as shown in Figure 18, and into your T1/PRI network device from your service provider.

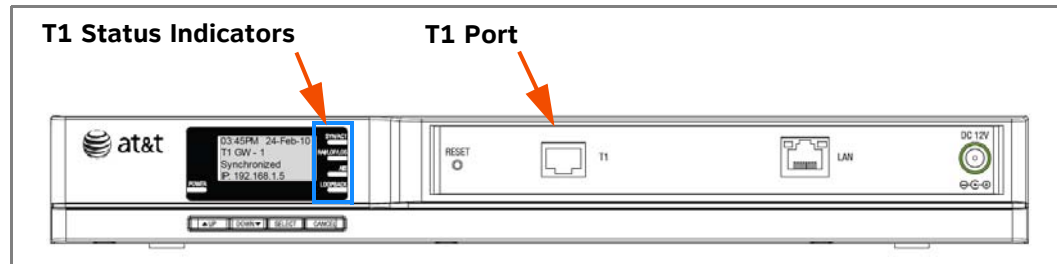

Figure 18. T1 Gateway Line Connections

Do not make any calls until the POWER and the SYN/ACT LEDs are green. See [“T1 Gateway Features” on page 59](#).



CAUTION

The SB67060 T1 Gateway must use only No.26 AWG or larger Telecommunications line cord to reduce the risk of fire.



NOTE

For customer service or product information, visit our website at www.telephones.att.com/smb or call **1 (888) 916-2007**. In Canada dial **1 (888) 883-2474**.



Deskset Installation

Figure 19 identifies the features on the bottom and side of the Deskset. You can install the Deskset on a desktop or mount it on a wall. Figure 19 represents the SB67030/031 Deskset. Although the SB67020 Deskset is slightly different, its features have the same basic layout.



The SB67031 Deskset is compatible only with Synapse systems with software version 1.9.5 and later. Ensure you have upgraded your system to software version 1.9.5 or later before installing an SB67031 Deskset.

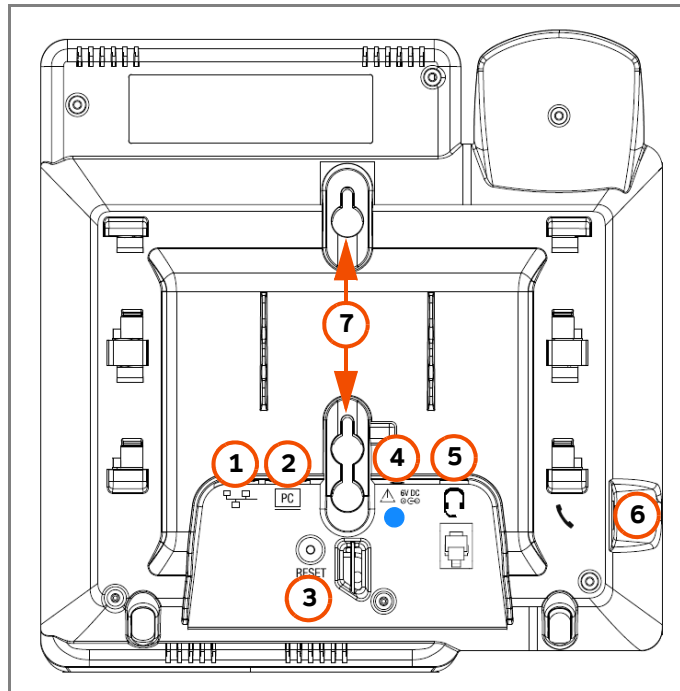

Figure 19. Deskset Connections

- | | |
|------------------------|---|
| 1. Network Port | <p>The two LEDs next to each network port indicate network status and AC power status.</p> <ul style="list-style-type: none"> ■ The green LED is on when the Deskset is connected to the network and has AC power. ■ The yellow LED flashes when there is network activity. |
| 2. PC Port | |
| 3. Reset Button | <p>Restarts the Deskset when pressed momentarily.</p> <p>Restores factory defaults when pressed and held for more than five seconds with the LAN cable not connected.</p> |
| 4. Power Jack | <p>SB67020 and SB67031 Desksets also support Power over Ethernet.</p> |



5. Corded Headset Jack Actual jack location may be different than shown

6. Corded Handset Jack

7. Wall-Mount Slots See ["To install the Deskset on a wall:"](#) on page 42.

To attach the Desktop Stand for desktop installation:

1. Select a Deskset position. The desktop setup requires the Deskset Stand and provides two positions, Option 1 at 45° and Option 2 at 60°, as shown in Figure 20. If you use Option 2, rotate the Handset tab as explained in ["To rotate the Handset tab for wall and Deskset Option 2 installation:"](#) on page 40.

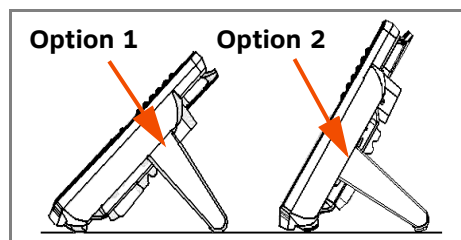

Figure 20. Deskset Stand Options

2. Place the Deskset on a flat surface with the power and network ports facing you, as illustrated in Figure 22.
3. Place the stand, illustrated in Figure 21, on the base with the flexible tab side away from you.

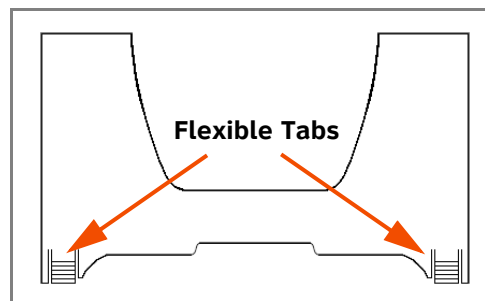

Figure 21. Deskset Stand Tabs

4. Insert the solid tabs of the stand into the Option 1 or Option 2 slots on the base that are marked in red in Figure 22.

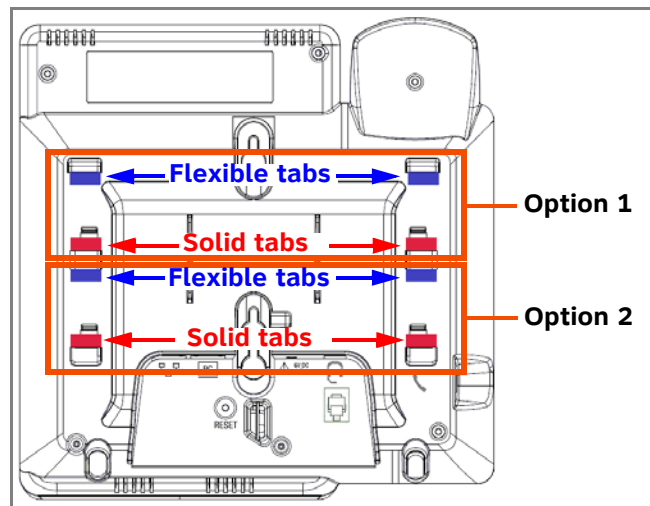
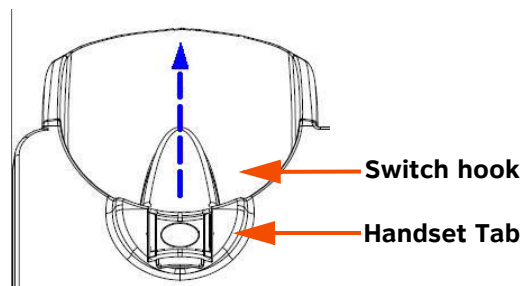

Figure 22. Deskset Stand Installation

5. Rotate the stand away from you until it rests against the base and you hear a click as the flexible tabs lock into place.

To rotate the Handset tab for wall and Deskset Option 2 installation:

1. Press the switch hook and slide the Handset Tab toward the top of the base, as shown.



2. Rotate the Handset Tab 180° so that the "hook" is at the top.

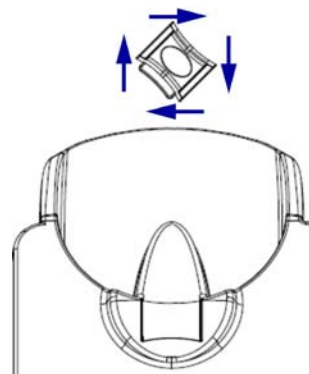

3. Slide the Handset Tab back into the base.

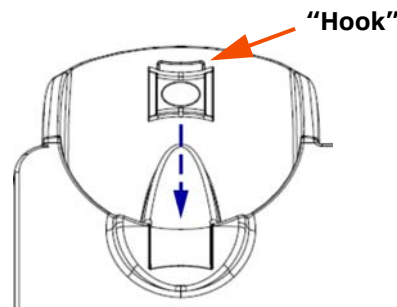

To connect the Cat.-5 LAN cable to the Deskset:

With a PC:

If there is a networked computer and no extra Ethernet wall jacks near the Deskset, then plug the PC Ethernet cable into the Deskset so the Deskset and PC share the same network connection.

1. Unplug the Cat.-5 Ethernet cable from your computer.
2. Plug that Cat.-5 Ethernet cable into the Network port on the back of the Deskset, as shown below.

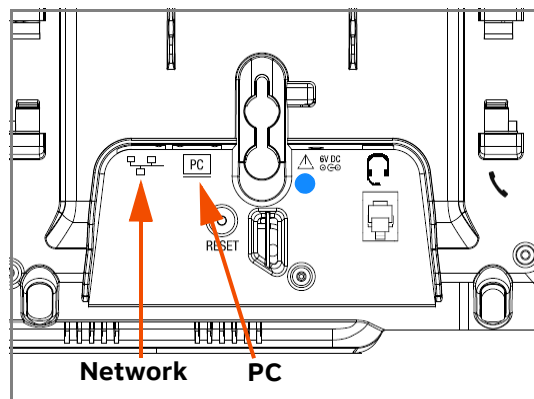

3. Plug another Cat.-5 Ethernet cable into the PC port on the Deskset.
4. Plug the other end of the second Cat.-5 Ethernet cable into your computer.
 - If a GigE network is being used, a computer connected through the Deskset will be limited to 100 Mbits/s. If you require a GigE Ethernet rate, use separate Ethernet connections for the Deskset and the computer so that the computer can take advantage of the greater bandwidth.
 - If a PC is connected to your LAN through a Deskset, any Deskset resets and power or network interruptions will disrupt the PC's connection to the network.



- CAUTION** ■ *The PC port on the Deskset is intended for connection to an end-user PC only.*
- *Do not use the PC port to connect to a PC with a heavy bandwidth load (such as a network server PC or a hub, switch, or router).*
 - *Do not use the PC port to extend the network. The end-user PC should be the final point. Do not use the PC port to connect to other system devices.*



Without a PC:

If the Deskset has a dedicated network connection, then connect the Deskset to the network connection only.

1. Plug a Cat.-5 Ethernet cable into the Network port on the back of the Deskset.
2. Plug the other end into the Ethernet wall jack.

To connect power:

[020/031] If you are using PoE, connecting the Deskset to the network also connects the power.

If you are using the supplied power adapter:

1. Plug the power adapter (blue tag) into the DC Power jack on the back of the Deskset.

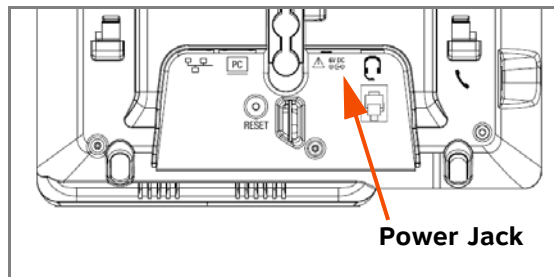

2. Plug the power adapter into an outlet not controlled by a wall switch. The display screen illuminates within about a minute.

If the user's computer is plugged into an uninterruptible power supply (UPS), consider plugging the Deskset into it, too.

To install the Deskset on a wall:

1. Plug the Ethernet cable into the port on the back of the Deskset. (See ["To connect the Cat.-5 LAN cable to the Deskset:"](#) on page 41.)
2. Plug the power adapter into the jack on the back of the Deskset. Skip this step if using POE. (See ["To connect power:"](#) on page 42.)
3. Place the Deskset base over the mounting plate above the mounting studs as shown in **1**.
4. Slide the Deskset base down as shown in **2**.



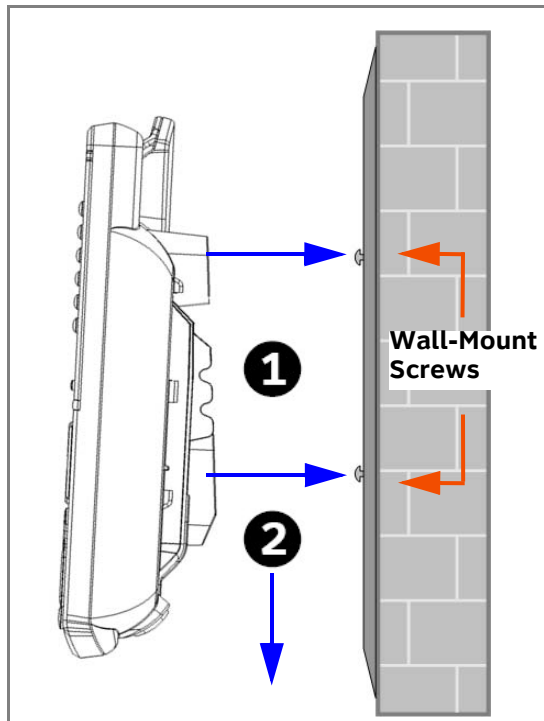

5. Plug the Ethernet cable into the wall jack.
6. Plug the power adapter into a power outlet not controlled by a wall switch. Skip this step if using PoE.
7. Make sure the Handset tab is in Wall position, as described in ["To rotate the Handset tab for wall and Deskset Option 2 installation:"](#) on page 40.
8. Connect the corded handset to the handset jack on the left side of the Deskset.

To connect the corded handset and an optional corded headset:**Connect the corded handset:**

1. Plug the coiled end of the handset cord into the handset jack on the left side of the Deskset.

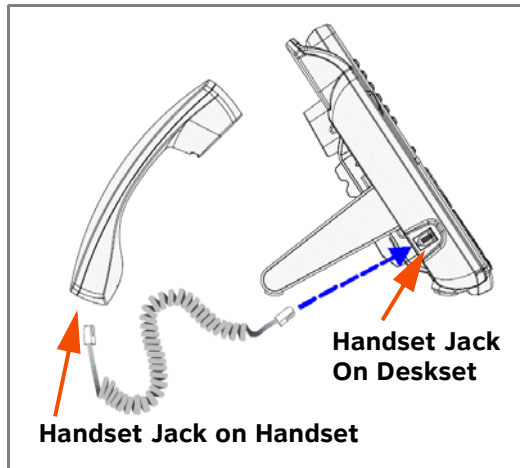

2. Plug the end of the handset cord with the longer straight portion into the handset, then hang up.

Connect an optional corded headset:

Plug an optional corded headset or cordless headset base into the RJ-9 connector on the bottom of the Deskset, as shown.

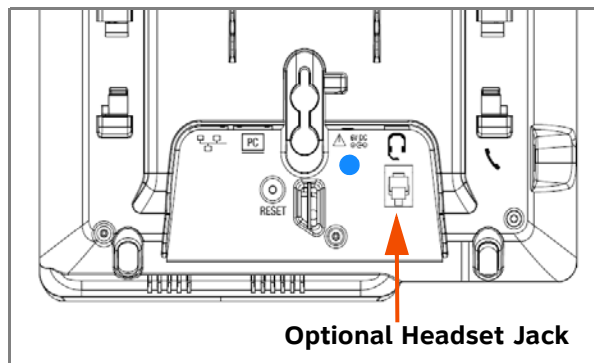

SB67030/031 A headset plugged into this jack takes precedence over a registered AT&T TL7600 Cordless Headset.



Do not plug a headset into the jack for the corded handset.



SB67050 ATA Installation

To install the ATA:

1. After installing at least one Deskset, plug the AC plug into an electrical outlet not controlled by a wall switch and the DC plug into the DC jack, as shown in Figure 23. Wait up to one minute until the screen lights up.

CAUTION  To prevent the loss of ATA-supported services during power outages, plug the AC power plug into an Uninterruptible Power Supply (UPS).

2. Plug a Cat-5 Ethernet cable into the port marked LAN. Plug the other end of the Ethernet cable into your office LAN.

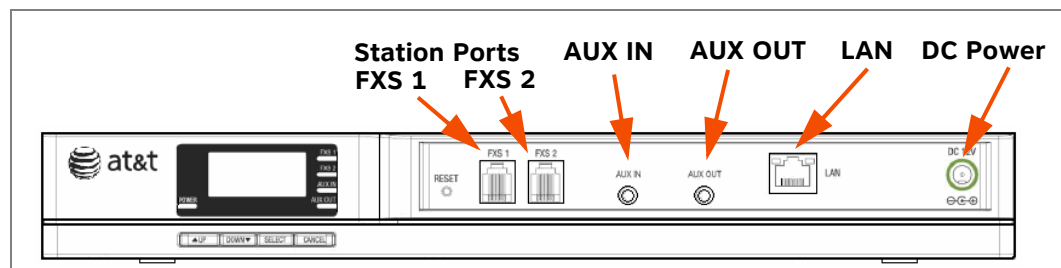

Figure 23. ATA Power, LAN, and Station Port Connections

The ATA takes about a minute to power up.

After the ATA has found the network and the Gateway, **Synchronized** appears on the third line of the ATA Idle screen.

```
03:45PM 24-Feb-10
ATA (216, 217)
Synchronized
IP: 192.168.1.4
```

3. Remove the plastic covers from the FXS station ports that you are using.

Connecting Analog Telephones

To install analog telephones:

1. Remove the plastic covers from the **FXS 1** and **FXS 2** (telephone) ports to be used on the ATA.
2. Plug up to two telephone lines from analog telephones into the ATA **FXS 1** and **FXS 2** ports, as shown in [Figure 24 on page 46](#).



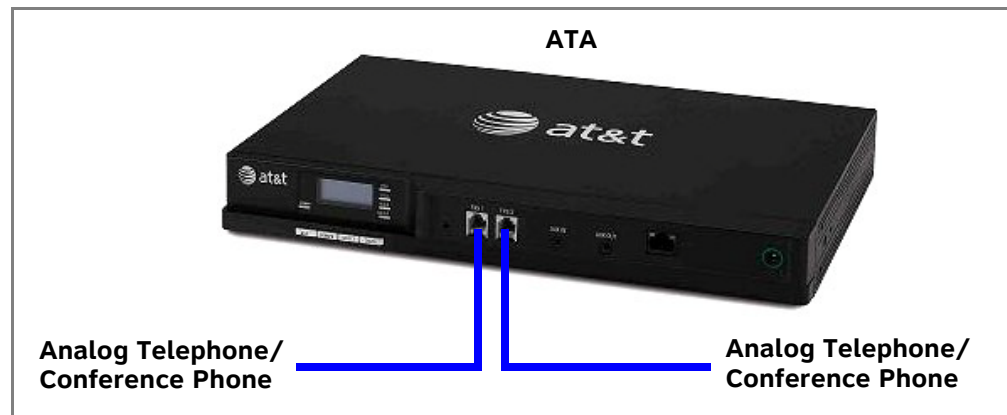

Figure 24. ATA Analog Telephone Connections

Connecting a Fax Machine

To install a fax machine:

1. Remove the plastic covers from the **FXS 1** or **FXS 2** (telephone) port to be used on the ATA.
2. Plug a telephone line from the fax machine into the ATA **FXS 1** or **FXS 2** port, as shown in Figure 25.
3. Configure the fax connection in the WebUI.



For information on configuring the ATA to work with your fax machine, see the Synapse Administrator's Guide at www.telephones.att.com/synapseguides.

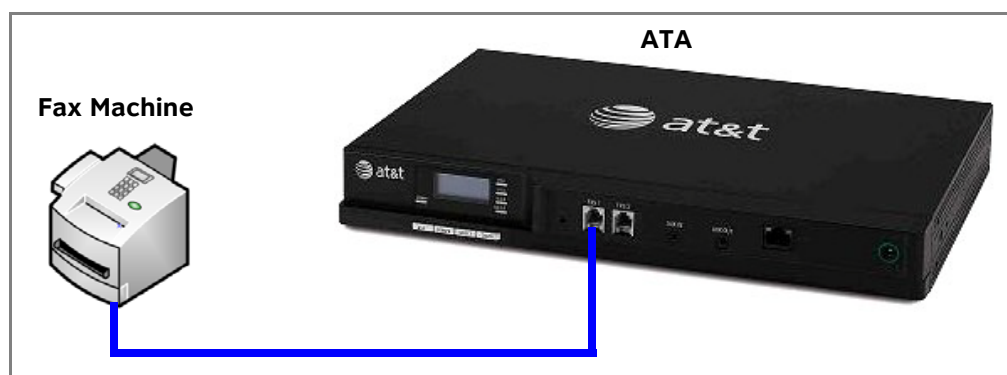

Figure 25. ATA Fax Machine Installation



If you are connecting your fax machine to the ATA and your Synapse Dial Plan uses a number for external line access, such as 9, you should inform users that they need to dial this number when sending faxes.



Connecting an Overhead Paging System (OHP)

A Single Zone or Multi-Zone system can be integrated into an existing Synapse network. The control unit or analog amplifier for the Overhead Paging system connects directly to the ATA via an FXS or the AUX OUT jack, depending on the type of paging system. Synapse supports most OHP systems that support PBX station ports or auxiliary audio-out connections to a PBX. Some settings for the OHP may have to be changed to work with Synapse.

If you don't know whether your OHP is Single Zone or Multi Zone, see [“Overhead Paging Overview” on page 20](#). There are so many types of paging equipment that you may need to contract with a communications equipment professional to install the OHP.



NOTE

Whether you are replacing a phone system and using an existing, functional OHP, or installing a new OHP, the paging system may have settings that need to be adjusted to work with Synapse.

OHPs that are “Line Mode” that cannot be set to “Station Mode” cannot be used with Synapse.

If you want to connect a single-zone paging system to the AUX OUT jack, you may need to buy or make a custom cable.



To install an overhead paging system:

1. Remove the plastic cover from the **FXS 1** or **FXS 2** port to be used on the ATA.
2. Plug the telephone line from the OHP device into the **FXS 1** or **FXS 2** port, or plug an audio cable from the OHP device into the ATA **AUX OUT** port, as shown in [Figure 23 on page 45](#), depending on the requirements of the paging system.

If you need to hard-wire a connection between your OHP device and the ATA **AUX OUT** jack, you can use the supplied auxiliary audio cable as follows:

- a. Remove the 3.5 mm plug from one end of the cable.
- b. Strip enough shielding from the cable to expose the three wires inside.
- c. Identify the Tip (Left channel) and Ground wires. Depending on the cable, the Tip wire may be white, the Ground wire may be bare/unshielded, and the Ring (Right channel) wire may be red, as shown in Figure 26. You can use a voltmeter to properly identify the wires.

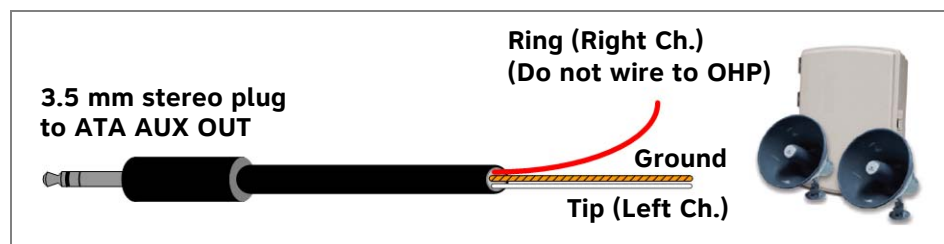

Figure 26. Hard-Wiring a Stereo Cable to the OHP

- d. Trim the Ring (Right channel) wire to ensure it does not contact other wires or terminals.
 - e. Connect the Ground wire to the negative terminal and the Tip wire to the positive terminal on the OHP device.
 - f. Plug the 3.5 mm plug on the other end of the cable into the **AUX OUT** port on the ATA.
3. Enable the OHP device in the WebUI.



For information on setting up OHP, see the Synapse Administrator's Guide at www.telephones.att.com/synapseguides.



Connecting a Music on Hold Source

To install a music on hold source:

1. Use the supplied auxiliary audio cable to plug a streaming audio source, such as a radio or MP3 music player, into the ATA **AUX IN** port as shown in Figure 27. If the supplied cable does not connect to your music source, use another cable that will connect your device to the 3.5 mm **AUX IN** port. This audio source must have a volume control. The volume adjustment on the audio device should be set to obtain the preferred level of music on hold within the system.



The ATA **AUX IN** port is set up to receive headset-out audio signals. Do not connect to a “Line-Out” audio source or to speaker outputs.

On-hold music functionality should only be used in conjunction with music specifically licensed for on-hold use. Licensed on-hold music is available from many third-party suppliers. AT&T disclaims any liability arising from the failure to obtain such a license.

2. Enable Music on Hold under **Hold Settings** in the WebUI.



For more information, see “Hold Settings and Music on Hold (Requires ATA)” in the Synapse Administrator’s Guide at www.telephones.att.com/synapseguides.



Figure 27. ATA Music on Hold Source Installation



SB67040 Cordless Handset Installation

**NOTE**

The SB67040 Cordless Handset requires registration to an SB67030/031 Deskset. The SB67020 Deskset does not support the SB67040 Cordless Handset. The SB67040 Cordless Handset is not supported when the system is in Line Appearance mode.

Charger Installation

Place the Handset in the charger when not in use.

To plug the Handset charger into AC power:

1. Plug the power adapter into an electrical outlet not controlled by a wall switch.
2. Plug the small end of the power adapter into the jack on the underside of the charger.
3. Route the cord through the slot, as shown.

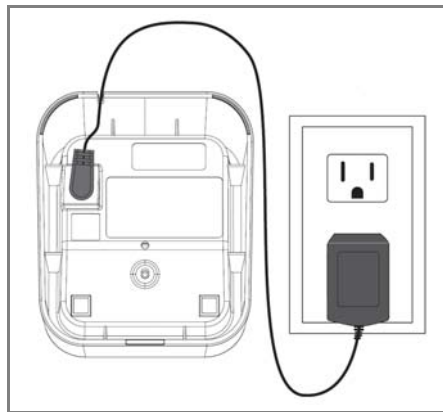

Battery Installation

The Cordless Handset uses a rechargeable 2.4v nickel-metal hydride cell (NiMH) battery pack.

To install the Handset battery:

1. Remove the battery cover by pressing and sliding the cover downward.

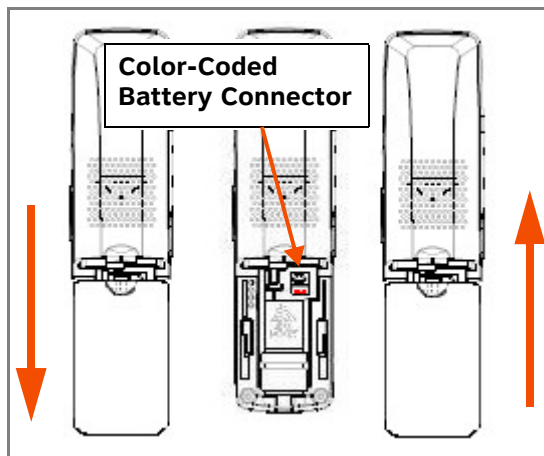

2. Plug the battery connector securely into the plug inside the Handset battery compartment, matching the color-coded label.



Use only the supplied rechargeable battery or replace it with battery model BT8001. To obtain a replacement battery, visit our website at www.telephones.att.com/smb or call **1 (888) 916-2007**. In Canada, call **1 (888) 883-2474**.

3. Place the battery in the compartment with THIS SIDE UP facing up.
4. Align the cover flat against the battery compartment, then slide it upward until it clicks into place.

If the battery has enough charge, within 10 seconds the **Place in charger** screen appears. If there is no charge, the screen remains blank.

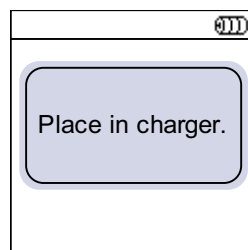

5. Place the Handset in the charger.



Battery Charging

Charge the Handset battery for at least 16 hours before use. When fully charged, the Handset battery provides approximately five hours of talk time or three days of standby time.

To charge the Handset battery:

Place the Handset in the charger, as shown.

- The **CHARGE** light is on when the Handset is charging.

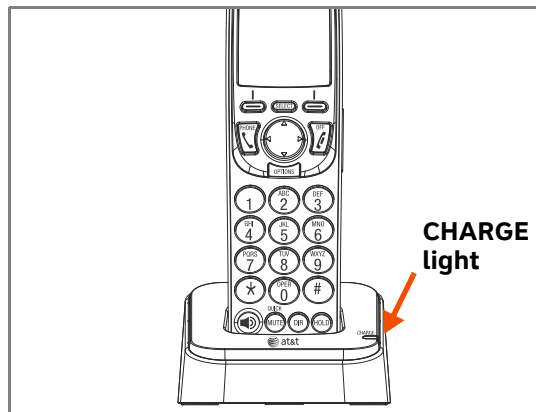

- If the Handset has not yet been registered, the Register screen appears within 15 seconds.

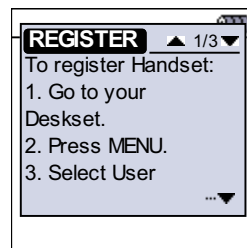

- 📘 To register the Handset, follow the on-screen instructions or see the "Handset Registration" section in the AT&T SB67040 Cordless Accessory Handset Quick Start Guide that was packaged with the Handset and available at www.telephones.att.com/synapseguides.



Place the Handset in the charger when not in use.

NOTE



TL7600 Cordless Headset Installation



The TL7600 Cordless Headset requires registration to an SB67030/031 Deskset. The SB67020 Deskset does not support the TL7600 Cordless Headset.

Charger Installation

To install the TL7600 charger:

1. Plug the small end of the charger power adapter into the jack on the underside of the charger, then route the cord through the slot.

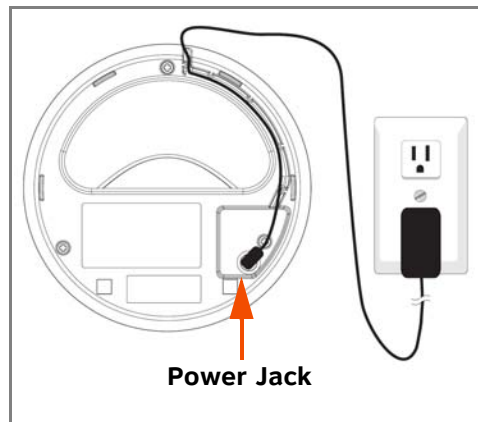

2. Plug the large end of the charger power adapter into an AC wall outlet not controlled by a wall switch.



Battery Installation

Install the battery as shown below. For optimal performance, charge the Headset battery for at least six hours before use. When not in use, recharge the Headset by returning it to the Headset charger.

To install a battery:

1. If the battery door is attached, press on both sides of the battery compartment cover and lift the cover up and off as shown.

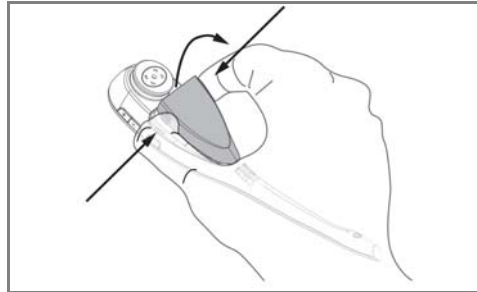

2. Insert the battery into the battery compartment with the label THIS SIDE UP facing up.
3. Push the battery plug into the connector inside the compartment according to the color-coded label and place the wires neatly inside the compartment as shown.

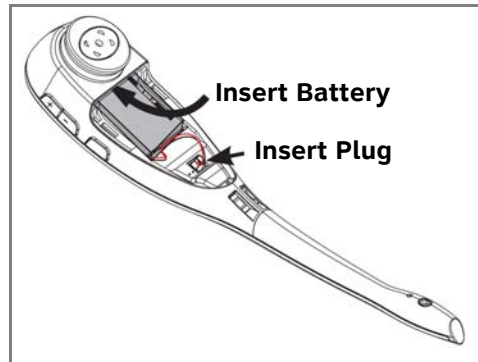

4. Insert the tab on the bottom of the battery cover into the battery compartment. Press down gently on the battery cover until it snaps into place.



NOTE

Remove the ear hook from the Headset before battery replacement.

Use only the supplied rechargeable battery or replace it with battery model BT191545. To obtain a replacement battery, visit our website at www.telephones.att.com/smb or call **1 (888) 916-2007**. In Canada, call **1 (888) 883-2474**.



Battery Charging

After installing the battery, charge the Headset by placing it in the Headset charger as shown below. Before registration, the Headset **ON/OFF** light flashes twice every five seconds whether the Headset is charging or not. After registration, the Headset **ON/OFF** light is on when the Headset is charging.

To charge the battery:

1. Insert the Headset into the charger as shown.

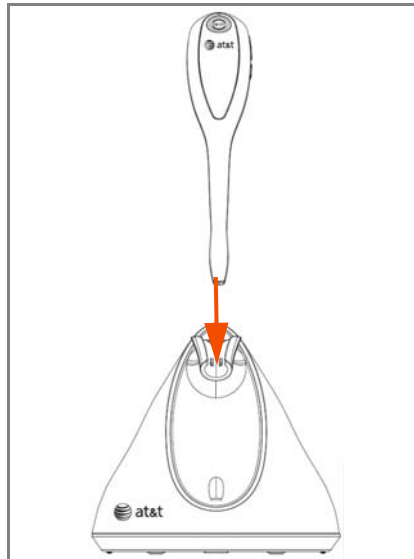

2. Push the Headset downward until the Headset **ON/OFF** light turns on.

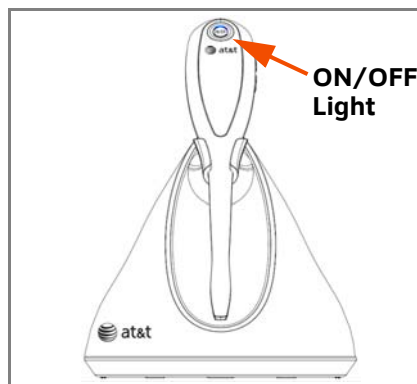

If the Headset has not yet been registered, the **ON/OFF** light flashes blue and orange.



To register the Headset, use the process described in "Registering an Optional Cordless Headset" in the AT&T SB67030/031 Deskset and Accessories User's Guide at www.telephones.att.com/synapseguides.



NOTE Place the Headset in the charger when not in use.



CHAPTER

2

GETTING STARTED

This chapter gets you started with configuring the Synapse system from the devices. Most of these functions are duplicated in the easier-to-use WebUI described in the next chapter, but if you need to assign static IP addresses, they must be set at each device. You can only directly reset a device from the device, although some functions in the WebUI include device resets.

This chapter covers:

- [“PSTN Gateway Features” on page 57](#)
- [“T1 Gateway Features” on page 59](#)
- [“SIP Gateway Features” on page 61](#)
- [“Gateway Front Panel Interface” on page 63](#)
- [“ATA Features” on page 67](#)
- [“Resetting Devices” on page 72](#)
- [“Deskset IP Settings” on page 74](#)
- [“Upgrade Deskset Software” on page 77.](#)



PSTN Gateway Features

Figure 28 illustrates the PSTN Gateway features and connections.

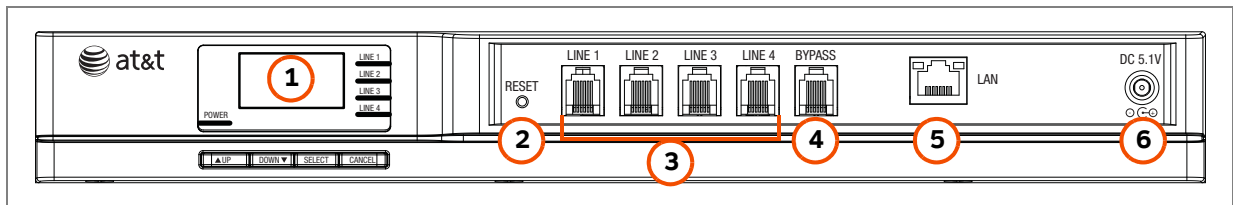

Figure 28. PSTN Gateway Features and Connections

1. Display	Provides system and network status, device information, and configuration data. See "Gateway Front Panel Interface" on page 63.
2. Reset	Restarts the Gateway when pressed momentarily. Restores factory defaults when pressed and held for more than five seconds with the LAN cable not connected.
3. PSTN Line Ports 1–4	Traditional 2-conductor wiring (FXO—Foreign Exchange Office Ports).
4. Bypass Port	Traditional analog POTS (Plain Old Telephone Service) that is available during an AC power outage. When the Gateway power fails, calls on Line 4 are routed to the bypass line.
5. RJ-45 Ethernet Network Port	10Base-T/100Base-Tx with Auto MDI/MDI-X switching.
6. DC 5.1V Power-Supply Jack	



Figure 29 and Table 5 provide an illustration and description of the PSTN Gateway front panel.

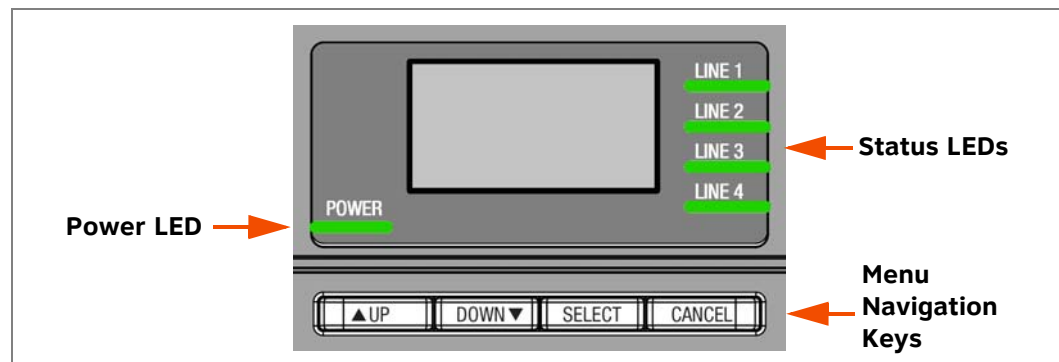

Figure 29. PSTN Gateway Front Panel

Table 5. PSTN Gateway Front Panel Keys and LEDs

Key	Used To:	LED	Description
<input type="button" value="▲UP"/> <input type="button" value="DOWN▼"/>	Navigate through the menus, and to increase/decrease editable fields. Highlight the previous or next item in the list.	LINE 1 LINE 2 LINE 3 LINE 4	Line-status LEDs indicate the status for each PSTN line. Indications include: Off —Connected. Red (steady)—Disconnected. Green (steady)—In use. Green (flashing)—Ringing. Line-status LEDs flash red after lines are connected (while matching line impedance).
<input type="button" value="SELECT"/>	Display the Main menu when in idle mode or while in network detection mode; save current setting and return to previous menu.		
<input type="button" value="CANCEL"/>	Terminate current operation without saving new settings and to return to the previous menu.	POWER	Off —No power to the device. Green —Power is present.



T1 Gateway Features

Figure 30 illustrates the T1 Gateway features and connections.

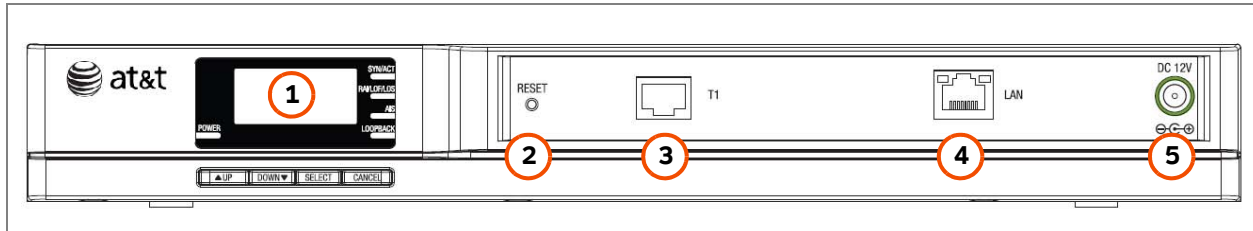

Figure 30. T1 Gateway Features and Connections

1. Display	Provides system and network status, device information, and configuration data. See “Gateway Front Panel Interface” on page 63.
2. Reset	When pressed momentarily, restarts the Gateway. When pressed and held for more than five seconds and with the LAN cable not connected, restores factory defaults.
3. T1 Port	
4. RJ-45 Ethernet Network Port	10Base-T/100Base-Tx with Auto MDI/MDI-X switching.
5. DC 12V Power-Supply Jack	



Figure 31 and Table 6 provide an illustration and description of the T1 Gateway front panel.

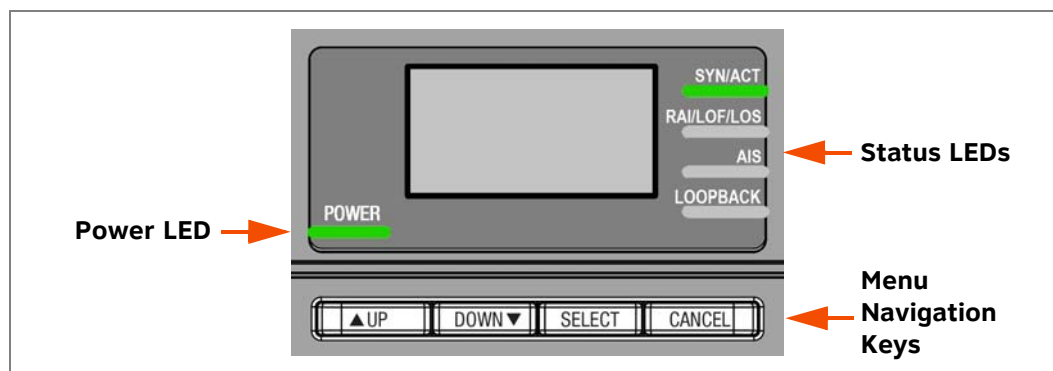

Figure 31. T1 Gateway Front Panel

Table 6. T1 Gateway Front Panel Keys and LEDs

Key	Used To:	LED	Description
<input type="button" value="▲ UP"/> <input type="button" value="DOWN ▼"/>	Navigate through the menus, and to increase/decrease editable fields. Highlight the previous or next item in the list.	SYN/ACT	Off —Not synchronized with T1 network. Green —T1 Synchronization. Green (flashing) —Active call.
<input type="button" value="SELECT"/>	Display the Main menu when in idle mode or while in network detection mode; save current setting and return to previous menu.	RAI/LOF/LOS	Off —No RAI/LOF/LOS errors. Yellow —Remote Alarm Indication (RAI). Red (steady) —Loss Of Frame (LOF). Red (flashing) —Loss Of Signal (LOS).
<input type="button" value="CANCEL"/>	Terminate current operation without saving new settings and to return to the previous menu.	AIS	Off —No Alarm Indication Signal. Blue —Alarm Indication Signal.
		LOOPBACK	Off —Network not in local loopback mode. Green (steady) —Network Loopback. Green (flashing) —Payload Loopback. Red —T1 Gateway is not synchronized with the LAN.
		POWER	Off —No power to the device. Green —Power is present.



SIP Gateway Features

Figure 32 illustrates the SIP Gateway features and connections.

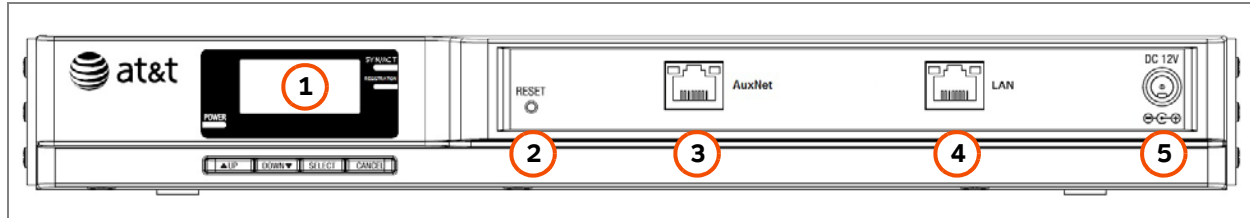

Figure 32. SIP Gateway Features and Connections

1. Display	Provides system and network status, device information, and configuration data. See “Gateway Front Panel Interface” on page 63.
2. Reset	When pressed momentarily, restarts the Gateway. When pressed and held for more than five seconds and with the LAN cable not connected, restores factory defaults.
3. AuxNet Port	Reserved for future use. This Ethernet port will be enabled in a future product upgrade.
4. RJ-45 Ethernet LAN Port	Connects to the Synapse network. 10Base-T/100Base-Tx with Auto MDI/MDI-X switching.
5. DC 12V Power-Supply Jack	



Figure 33 and Table 7 provide an illustration and description of the SIP Gateway front panel.

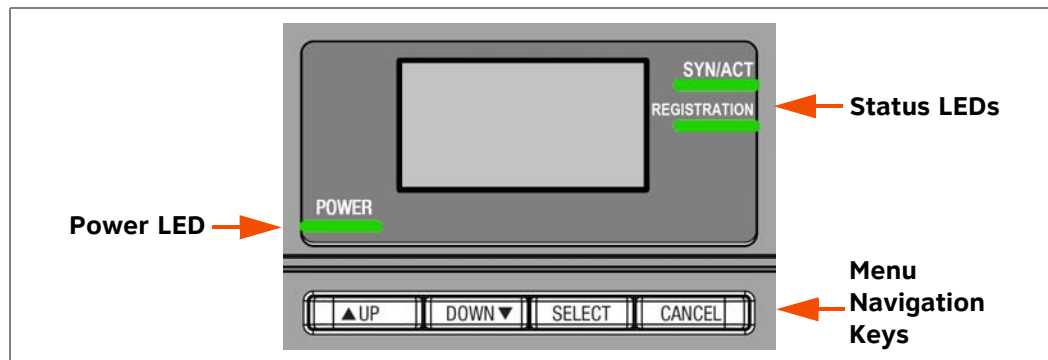

Figure 33. SIP Gateway Front Panel Description

Table 7. SIP Gateway Front Panel Keys and LEDs

Key	Used To:	LED	Description
<input type="button" value="▲UP"/> <input type="button" value="DOWN▼"/>	Navigate through the menus, and to increase/decrease editable fields. Highlight the previous or next item in the list.	SYN/ACT	Off —Synchronization failed. Green —Synchronized to Synapse. Green (flashing) —Active call(s).
<input type="button" value="SELECT"/>	Display the Main menu when in idle mode or while in network detection mode; save current setting and return to previous menu.	REGISTRATION	Off —No accounts configured; all accounts disabled; all accounts configured for static registration. Green (steady) —All registrations active. Red (steady) —One or more registrations failed. Red (flashing) —All registrations failed.
<input type="button" value="CANCEL"/>	Terminate current operation without saving new settings and to return to the previous menu.	POWER	Off —No power to the device. Green —Power is present.



Gateway Front Panel Interface

You can access basic information and perform some configuration tasks using the Gateway's front panel. Most of these tasks are easier to do using the WebUI. See ["WebUI Overview" on page 79](#).

The Gateway displays the Idle screen after completing the power-up sequence. Use the Gateway Main menu to perform some system operations.

To access the Gateway Main menu from the Idle screen, as shown in Figure 34 (PSTN Gateway shown), press the key.

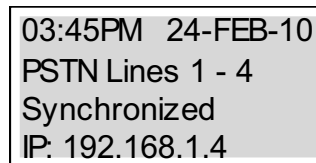

Figure 34. Gateway Idle Screen

From the Main menu you can access the:

- **Device Information** screen
- **Network Status** screen
- **Configuration** menu.



Figure 35. Gateway Menu Screens

Press the key to highlight an entry, then press to see information about your Gateway or your Network.

- Select **Configuration** to view or modify some Gateway settings. See ["Gateway Configuration" on page 64](#).
- On the **Device Information** screen, you can view:
 - Model #
 - Serial #
 - Boot Version
 - Software Version
 - Firmware Version (PSTN Gateway only).
- On the Network Status screen, you can view:
 - IP Address
 - Subnet Mask
 - Default Gateway
 - DNS Server x
 - MAC Address
 - Network Port
 - Local Address.



Press to return to the Main Menu.

Gateway Configuration

Press / in the Gateway Main menu until **Configuration** is highlighted, as shown in Figure 36, and press to display the Configuration menu. The current setting is indicated with **[x]**.

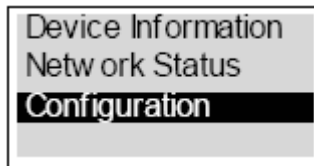

Figure 36. Gateway Configuration

Configuration — Current Gateway settings.

- Auto IP — Is set automatically.
- Static IP — You can change the static IP only from the Gateway. See your network administrator if you require details regarding IP assignments.
- Restore Defaults — Highlight **Restore Defaults** and press and hold for two seconds when prompted to restore the Gateway to factory defaults.
- Upgrade Software — Highlight **Upgrade Software** and press . If new software is available, you are prompted to press again to accept the upgrade. You can use this interface or the WebUI to upgrade software.



Upgrade Gateway Software

If you have system settings that you want to retain, back up the settings before upgrading the system software.

To upgrade the Gateway software to the latest version:

1. Press / in the Gateway Main menu until **Configuration** is highlighted and press to display the Configuration menu.
2. Press to highlight **Upgrade Software** and press to initiate the software upgrade process. The device initiates a link to the Synapse Software Updates web site host and any new software.

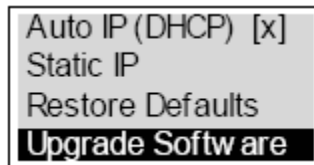

- If a host cannot be found or the server name cannot be resolved, **Timeout** or **Host Not Found** appears. Upgrade the software from the PC, which can offer more information about connection issues.



For more information, see the Synapse Administrator's Guide at www.telephones.att.com/synapseguides.

If the host is found, but there is no new software available, then the **No New Version** message appears.



If the device is sluggish or unresponsive during the upgrade process, see "[A Synapse device becomes sluggish or unresponsive during or immediately after software upgrade.](#)" on page 117.

3. If new software is available, you are prompted to initiate the upgrade by pressing , or abort by pressing .

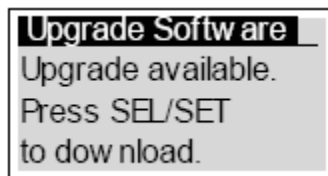

Once the downloading starts, the display indicates the progress as shown by the percentage indicator.

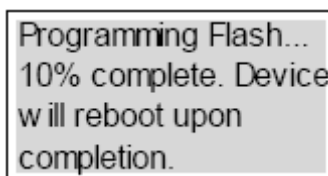

- If the upgrade process is interrupted by removing the server connection, no restart occurs. The Gateway remains on the xx% complete screen, until an action is taken at that Gateway. The process does not resume even after the server connection is reestablished.
 - Pressing during the programming process terminates the download midstream and returns you to the Configuration menu. The previous software version remains in effect.
 - When the upgrade is complete, the screen briefly displays **100% complete**, then **0% complete** for few seconds, before restarting the Gateway.
4. Press repeatedly until you return to the Gateway Main menu.



ATA Features

When the ATA is first connected to your LAN, the two FXS ports are configured as POTS phone lines and assigned the next available extension numbers. ATA extension numbers do not appear in the Extension list on Deskset screens. They do, however, appear on Call Logs, Redial lists, and Message lists. The two ATA extensions do not count toward the 100-extension limit of the Synapse system.

In addition, one 10/100BT Ethernet port is provided for communication with the Synapse network. The front panel LCD and buttons allow network configuration, firmware upgrades, and information functions. Figure 37 illustrates the ATA features and connections.

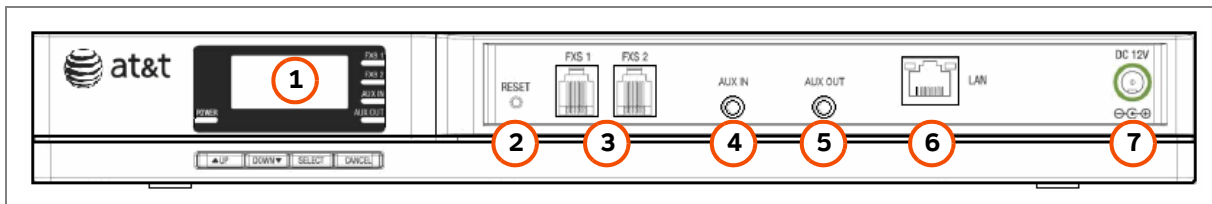

Figure 37. ATA Features and Connections

1. Display	Provides system and network status, device information, and configuration data.
2. Reset	When pressed momentarily, restarts the ATA. When pressed and held for more than five seconds and with the LAN cable not connected, restores factory defaults.
3. FXS 1, FXS 2	Station ports for analog telephones, a fax machine, door phone, or overhead paging equipment.
4. AUX IN	Audio in for MoH.
5. AUX OUT	Audio out, an option for OHP.
6. RJ-45 Ethernet Network Port	10Base-T/100Base-Tx with Auto MDI/MDI-X switching.
7. DC 12V Power-Supply Jack	



Figure 38 and Table 8 provide an illustration and description of the ATA front panel.

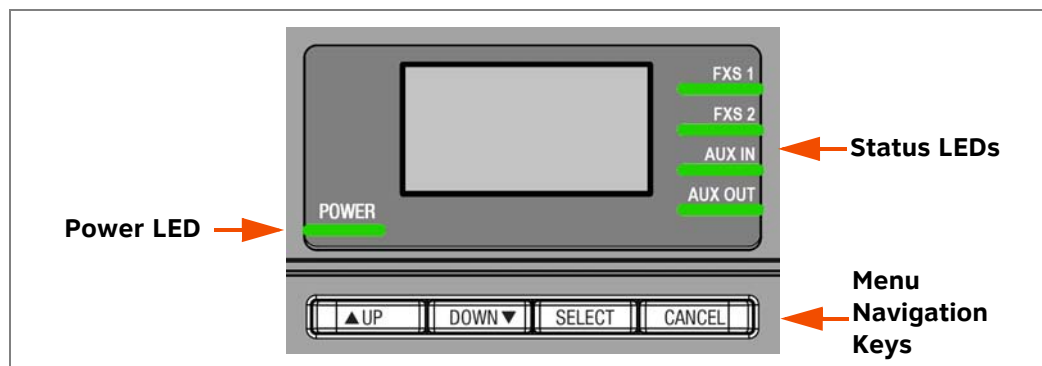

Figure 38. ATA Front Panel Description

Table 8. ATA Front Panel Keys and LEDs

Key	Used To:	LED	Description
<input type="button" value="▲UP"/> <input type="button" value="DOWN▼"/>	Navigate through the menus, and to increase/decrease editable fields. Highlight the previous or next item in the list.	FXS 1 FXS 2	Station port status LEDs indicate: Off —No connection detected or idle Green (steady)—Line activity detected Green (flashing)—Ringing
<input type="button" value="SELECT"/>	Display the Main menu when in idle mode or while in network detection mode. Save current setting and return to previous menu.	AUX IN AUX OUT	Audio status LEDs indicate: Off —Not configured in the WebUI Red (steady)—Configured in the WebUI, but no connection detected. Green (steady)—Configured and connected. Green (flashing)—Paging active.
<input type="button" value="CANCEL"/>	Terminate current operation without saving new settings and to return to the previous menu.	POWER	Off —No power to the device. Green —When power is present.



ATA Front Panel Interface

You can access basic information and perform some configuration tasks using the ATA front panel. These tasks are easier to do using the WebUI. See [“WebUI Overview” on page 79](#).

The ATA displays the Idle screen after powering up. Access the ATA Main menu to perform the system operation functions.

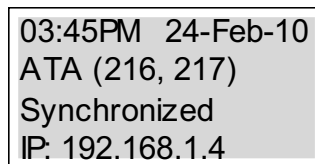

Figure 39. ATA Idle Screen

To access the ATA Main menu from the Idle screen, as shown in Figure 39, press the **SELECT** key. The menu provides the following functions:

- **Device Information**
- **Network Status**
- **Configuration**

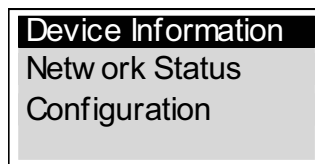

Figure 40. ATA Menu Screens

Press the **DOWN** key to highlight an entry, then press **SELECT** to see information about your ATA or your network, as shown in Figure 40. Select **Configuration** to view or modify some ATA settings. Here is the information you can see in Device Information and Network Status:

Device Information

- Model #
- Serial #
- Boot Version
- Software Version
- Firmware Version

Network Status

- IP Address
- Subnet Mask
- Default Gateway
- DNS Server X
- MAC Address
- Network Port
- Local Address



ATA Configuration

Press / in the ATA Main menu until **Configuration** is highlighted, as shown in Figure 41, and press to display the Configuration menu. The current setting is indicated with **[x]**. You can use this interface or the WebUI to upgrade software.

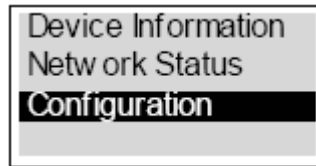

Figure 41. ATA Configuration

Configuration — Current ATA settings:

- Auto IP — Is set automatically.
- Static IP — You can change the Static IP only from the ATA. See your network administrator if you require details regarding IP assignments.
- Restore Defaults — Highlight **Restore Defaults** and press and hold for two seconds when prompted to restore the ATA to factory defaults.
- Upgrade Software — Highlight **Upgrade Software**, and press . If new software is available, you are prompted to press again to accept the upgrade.

Upgrade ATA Software

If you have system settings that you want to retain, back up the settings before upgrading the system software.

To upgrade the ATA software to the latest version:

1. Press / in the ATA Main menu until **Configuration** is highlighted and press to display the Configuration menu.
2. Press to highlight **Upgrade Software** and press to initiate the software upgrade process. The device initiates a link to the Synapse software updates web site host and any new software.

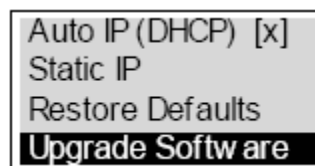

- If a host cannot be found or the server name cannot be resolved, **Timeout** or **Host Not Found** appears. Upgrade the software from the PC, which can offer more information about connection issues.



For more information, see the Synapse Administrator's Guide at www.telephones.att.com/synapseguides.



If the host is found, but there is no new software available, then the **No New Version** message appears.



If the device is sluggish or unresponsive during the upgrade process, see [“A Synapse device becomes sluggish or unresponsive during or immediately after software upgrade.”](#) on page 117.

3. If new software is available, you are prompted to initiate the upgrade by pressing , or abort by pressing .

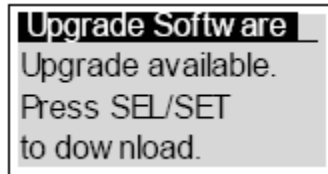

Once the downloading starts, the display indicates the progress as shown by the percentage indicator. The device restarts automatically once the programming is completed.

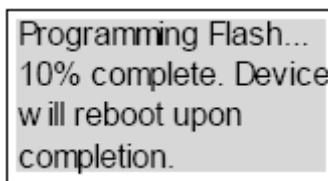

- If the programming process is interrupted by removing the server connection, no restart occurs. The process does not resume even after the server connection is reestablished. The ATA remains on the xx% complete screen until an action is taken at the ATA.
 - Pressing during the programming process terminates the download and returns you to the Configuration menu. The previous software version remains in effect.
 - When the upgrade is complete, the screen briefly displays **100% complete**, then **0% complete** for few seconds, before restarting the ATA.
4. Press repeatedly until you return to the ATA Main menu.



Resetting Devices

You may need to manually restart a device or return a device to factory defaults (see [“Appendix B: Default Settings” on page 146](#)). To reset a device, press the **RESET** button shown in Figure 42 and [Figure 43 on page 73](#) by inserting a pen or paper clip into the hole and applying pressure to the button. The T1 Gateway, SIP Gateway, and ATA (not shown) have a **RESET** button in the same location on the front panel as the PSTN Gateway. Although [Figure 43 on page 73](#) shows the SB67030/031 Deskset, the SB67020 Deskset reset button is in the same location.

To restart the device without losing any custom settings, press the **RESET** button for less than five seconds. You can get the same result by disconnecting and reconnecting power to the device. You can restart the device if the device does not respond or fails to synchronize with the system.

To completely reset the device to factory defaults, unplug the LAN cable from the device and press the **RESET** button for more than five seconds. You might do this if the device is not synchronized or you want to reset the IP address settings to Auto (DHCP). Any static IP configurations are lost.

When resetting a Deskset to factory defaults, the system configuration (the user settings and Personal directory) and Voicemail messages, Call Log, and the Redial list are all deleted. You can use this complete reset when assigning Desksets to new users. If you do not disconnect the LAN cable before pressing the **RESET** button, the extension number is retained, and Group Mailbox messages associated with the Deskset are recovered from the ATA. During the reset, any PC connected to the Deskset PC port momentarily loses network connectivity.



NOTE

To reset the entire system to factory defaults and completely clear the system of all settings (Auto Attendant, Ring Groups, hold message, and System Directory) and Voicemail messages, unplug the LAN cables from all devices and press the **RESET** button for more than five seconds on each device. Then reconnect all devices to the LAN.

If there is one Gateway in the system, but there are still Desksets connected, then only the voice prompts and hold messages are deleted; the rest of the Auto Attendant settings are maintained on the Desksets. If there is another Gateway, the other Gateway maintains all system configuration settings.



NOTE

If you have already set up the system, back up the Deskset and system settings before resetting the device to factory defaults. For more information, see the Synapse Administrator's Guide.

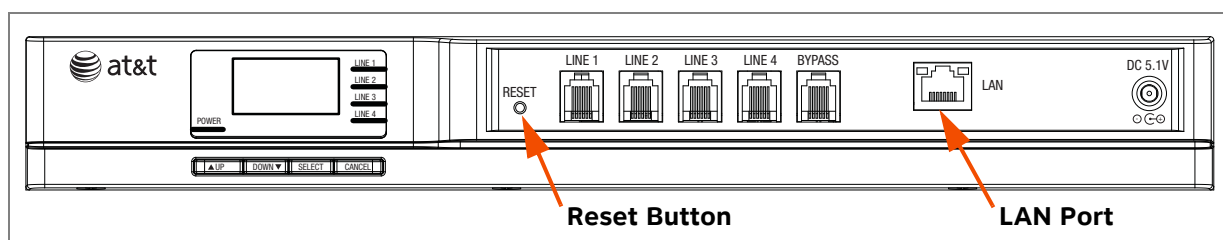

Figure 42. PSTN Gateway Reset Button



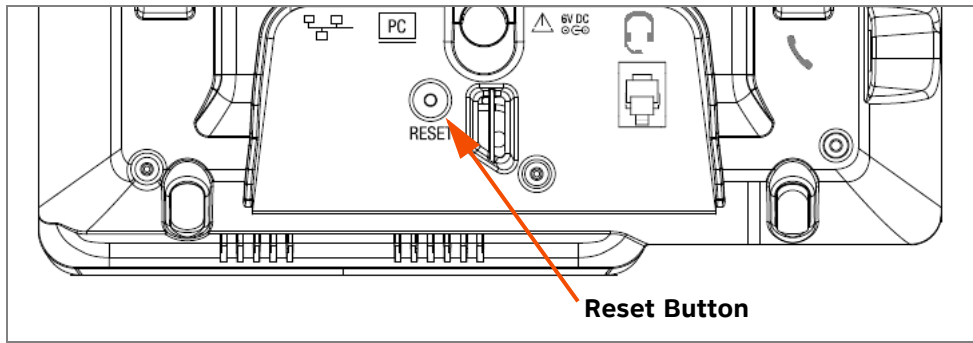

Figure 43. Deskset Reset Button

Deskset IP Settings

Synapse devices are connected to a LAN so they can communicate with each other. See [“System Installation Overview” on page 10](#) and [“IP Addresses and Connectivity” on page 16](#) for a discussion of the Synapse network configuration and IP settings.

To display the IP Settings screen:

1. Access the **Admin Settings** menu: Press **MENU**, then press **3** on the dial pad, then enter the Admin password (**12345** is the default password), and press **SELECT**.
2. Press **3** on the dial pad to display the **IP Settings** menu.

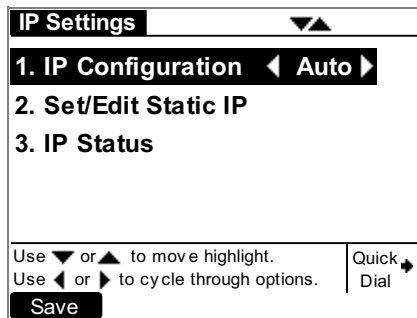

030/031 Deskset IP Settings

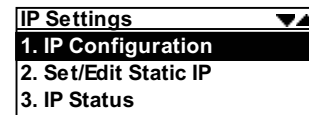

020 Deskset IP Settings

3. Perform one of the following:
 - a. Press **1** to select **IP Configuration**. See [“To set the IP Configuration:” on page 74](#).
 - b. Press **2** to select **Set/Edit Static IP**. See [“To set and edit static IP Address:” on page 75](#).
 - c. Press **3** to select **IP Status**. See [“To view the IP status:” on page 76](#).

To set the IP Configuration:

1. From the SB67020 Deskset **IP Settings** menu, press **1** to select **IP Configuration**. The **IP Configuration** screen appears.
From the SB67030/031 Deskset **IP Settings** menu, go to Step 2.
2. Press ◀ or ▶ to select **Auto** or **Static**.



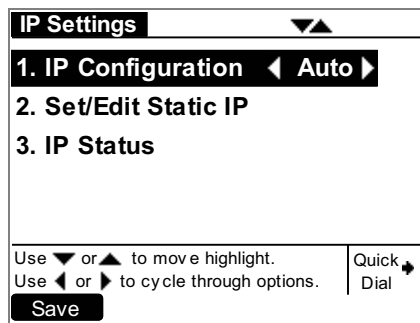

030/031 Deskset IP Configuration

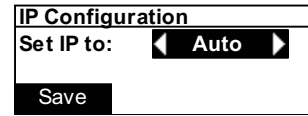

020 Deskset IP Configuration

- Press **Save** to accept the changes and return to the **Admin Settings** menu.

Set/Edit Static IP

If your business requires a static IP address, contact your network administrator.

To set and edit static IP Address:

- Access the **Admin Settings** menu: Press **MENU**, then press **3** on the dial pad, then enter the Admin password, and press **SELECT**.
- Press **3** on the dial pad to display the **IP Settings** screen.
- Press **2**. The **Set/Edit Static IP** screen appears.

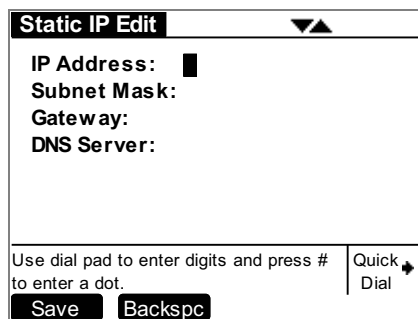

030/031 Deskset Set/Edit Static IP

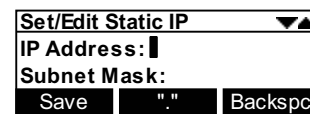

020 Deskset Set/Edit Static IP

- Enter digits:
 - There is a 12-digit limit on the number field (not including dots).
 - On the SB67030/031 Deskset, press the pound key (#) to insert a dot.
On the SB67020 Deskset, press **."** to insert a dot.
 - Pressing **Backspc** when the cursor is positioned next to a dot deletes the dot and the digit to the left of the dot.
- Press **△** or **▽** to cycle through the four fields.
- Press **Save** to accept the changes and return to the **Admin Settings** menu.



IP Status

This screen is for informational purposes only.

To view the IP status:

1. Access the **Admin Settings** menu: Press **MENU**, then press **3** on the dial pad, then enter the Admin password, and press **SELECT**.
2. Press **3** on the dial pad. The **IP Settings** screen appears.
3. On the **IP Settings** screen, press **3**. The **IP Status** screen appears.

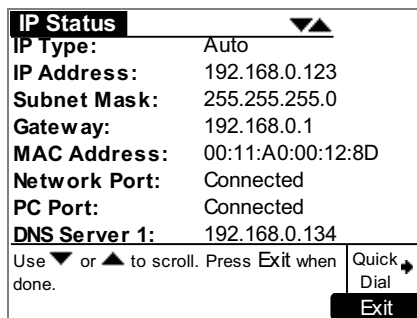

030/031 Deskset IP Status

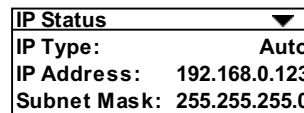

020 Deskset IP Status

4. Press \triangle or ∇ to view status entries that are not shown on-screen.



The list is not circular, so when you reach the end of the available text, pressing ∇ has no effect. If you are at the top of the screen, pressing \triangle has no effect.

5. Press **Exit** [**030/031**] or **CANCEL** [**020**] to return to the **Admin Settings** menu.



Upgrade Deskset Software

To access the Deskset Software Upgrade feature:

1. Access the **Admin Settings** menu: Press **MENU**, then press **3** on the dial pad, then enter the Admin password, and press **SELECT**.
2. Press **5**. The Software Upgrade screen appears. The system scans for an upgrade.

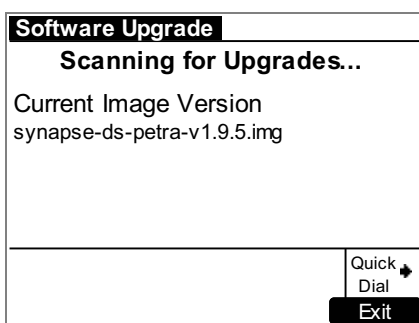

030/031 Deskset Software Upgrade

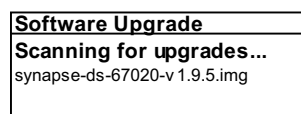

020 Deskset Software Upgrade

- If an upgrade is available, a **Found New Version** screen appears.
 - If no upgrade is available, a **No New Version** screen appears. Press **Exit** [030/031] or **CANCEL** [020] to return to the Admin Settings menu.
3. Press **Upgrade** to install the upgrade. The **Upgrading** screen appears.

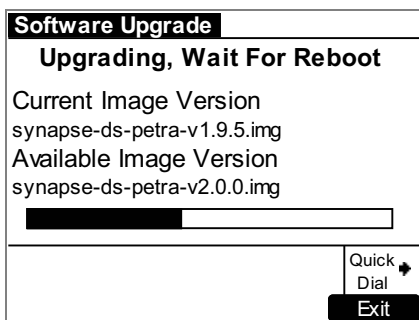

030/031 Deskset Upgrading

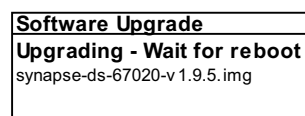

020 Deskset Upgrading



NOTE

If the device is sluggish or unresponsive during the upgrade process, see [“A Synapse device becomes sluggish or unresponsive during or immediately after software upgrade.”](#) on page 117.

The Deskset automatically resets at the end of the software upgrade process. If a PC is connected to the Deskset that you are using, any network traffic involving that PC halts until the Deskset has resumed operation. Avoid updating the Deskset when the user is likely to be at the workstation.

See [“Updating Devices”](#) on page 91 to update the Deskset software from the WebUI.



CHAPTER
3

SYSTEM CONFIGURATION

You can configure the Synapse System using the WebUI. The WebUI consists of web pages with editable settings for the system and each Synapse device. The WebUI is embedded in every SB67010 PSTN Gateway, SB67020 Deskset, SB67030/031 Deskset, and optional SB67050 Analog Terminal Adapter (ATA). When you access the WebUI, you are accessing it on the device, not on the Internet.

This chapter shows you how to access and log in to the WebUI. This chapter also lists the settings you may have to configure to commission a basic Synapse System with Gateways, Desksets, ATA, and an optional fax machine and paging system.

 To fully configure a newly installed Synapse System, see the Synapse Administrator's Guide at www.telephones.att.com/synapseguides.



NOTE The feature descriptions and sample screens in this chapter are from a system that includes optional devices. Your Deskset screens and WebUI pages may be different. For example, if your system does not include an ATA, the Fax Configuration, Group Mailbox, Overhead Paging, and ATA Settings items do not appear in the WebUI menu.

This chapter also includes some settings you may have to configure as part of the installation process:

- ["Configuring a Trunk Port \(FXO\) Door Phone" on page 85](#)
- ["Line Calibration Configuration" on page 90](#)
- ["Updating Devices" on page 91](#)
- ["Product Registration" on page 94.](#)



WebUI Overview

If two Synapse devices are connected to the LAN, and as long as one Synapse device is currently on the same subnet as a PC, you can use the WebUI to administer the system. Only one person should log in as system administrator at a time to prevent accidentally overwriting and losing intended changes.

Any PCs used for configuring the WebUI must be connected to the same IP subnet as the devices they will manage, or to other subnets that the PCs can communicate with. Confirm either that all devices are connected to the same router, or that the first three octets of the IP address are the same for all system devices. The Gateway displays its IP address in the Idle mode as shown in Figure 44. To determine the Deskset IP address, press **MENU**, then **4** on the Deskset dial pad to display the **Deskset Information** screen shown in Figure 44.

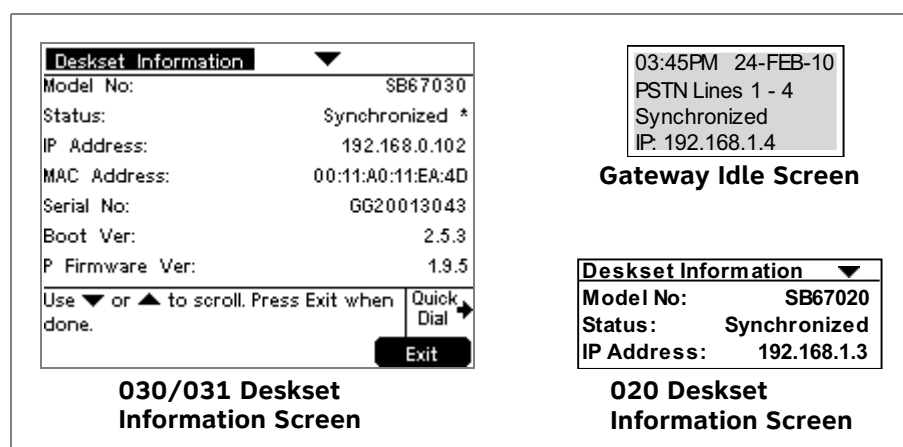

Figure 44. Device IP Addresses



CAUTION In most cases there are multiple settings on one page. Changing a setting does not instantly apply the new value. Click **Apply** on the WebUI to save all changes on that page.



NOTE Changes made on the WebUI are transmitted to all connected devices when applied. If changes are being made at the Deskset and WebUI simultaneously, a first-come-first-served policy on resource allocation applies. System configuration changes are transmitted globally when you press **Save** on the Deskset or click **Apply** on the WebUI.



WebUI information for individual users is contained in the “Web Interface” chapter of the SB67020 Deskset User’s Guide and the SB67030/031 Deskset and Accessories User’s Guide at www.telephones.att.com/synapseguides.



Log in as Administrator

To access the browser interface and log in:

1. Ensure your computer is connected to the same IP subnet as the Synapse system. You can connect your computer to the PC port on the back of a Deskset.
2. On the Deskset, press **MENU** then **4**. The **Deskset Information** screen appears.

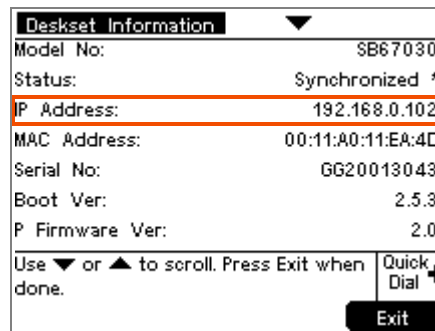

030/031 Deskset Information Screen

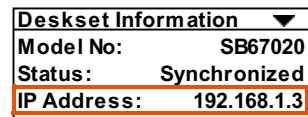

020 Deskset Information Screen

3. Find the IP address on the **Deskset Information** screen.
4. Open a browser. AT&T recommends Internet Explorer 7 or higher for best performance. (If you are using a different browser, some of the pages presented here may look different and have different controls.) The PC must be on the same subnet as the Deskset, or your network administrator must have set it up so that devices on different subnets are able to communicate.
5. Type the Deskset **IP Address** in the address bar, and press **ENTER**.

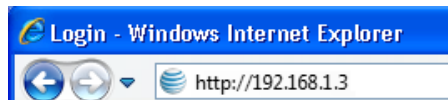

You can also use a Gateway IP address (shown in [Figure 34 on page 63](#)) to log in to the WebUI.

The **Login** page appears in the browser.



Login

Login Name:

Login Name: Users should enter the extension number. Administrators should enter the Administrator ID.

Password:

Password: If there is an Extension password, the User should enter that password. If there is no Extension password, the User should leave the password field blank. Administrators should enter the administrator password.



6. Enter **admin** in the **Login Name** field and **12345** in the **Password** field, then click [Login](#). You may change the Admin ID and password once you are logged in.

The **System Information** page appears.

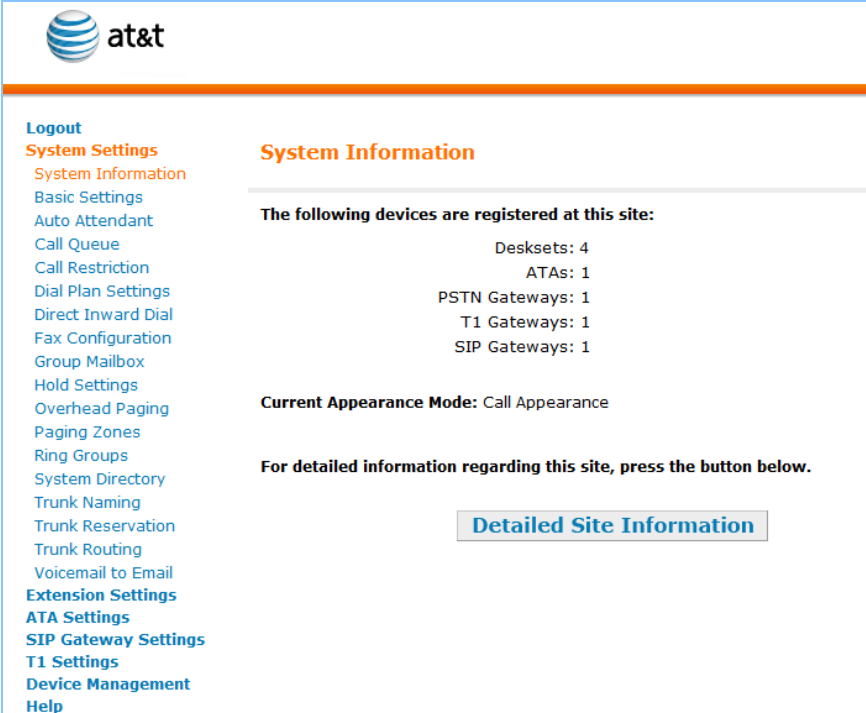

at&t

Logout

System Settings

System Information

Basic Settings

Auto Attendant

Call Queue

Call Restriction

Dial Plan Settings

Direct Inward Dial

Fax Configuration

Group Mailbox

Hold Settings

Overhead Paging

Paging Zones

Ring Groups

System Directory

Trunk Naming

Trunk Reservation

Trunk Routing

Voicemail to Email

Extension Settings

ATA Settings

SIP Gateway Settings

T1 Settings

Device Management

Help

System Information

The following devices are registered at this site:

Desksets: 4

ATAs: 1

PSTN Gateways: 1

T1 Gateways: 1

SIP Gateways: 1

Current Appearance Mode: Call Appearance

For detailed information regarding this site, press the button below.

[Detailed Site Information](#)

Click topics from the navigation menu on the left side of the WebUI to see them. You view and change settings in two different types of fields: drop-down lists and entry fields into which you type information. For your security, the WebUI times out after 10 minutes, so if it is idle for that time, you must log in again.

The remaining procedures in this chapter assume that you are already logged in to the WebUI as administrator.



Only one person at a time should log in as the system administrator to prevent unintentional overwriting of changes.



Error Handling

If you type an invalid value into one of the WebUI fields and click [Apply](#), the page is not saved. The WebUI displays an error message at the top of the page. The field with the incorrect value is highlighted in yellow, as shown in Figure 45. You can view a more detailed error description by resting your mouse pointer on the highlighted field.

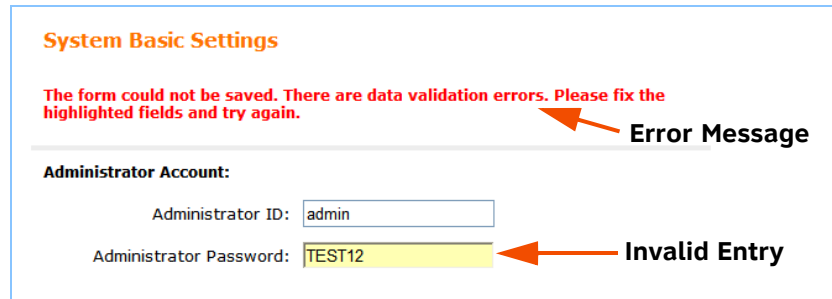

Figure 45. WebUI Error Indication



System Settings



When making changes to the System Settings through the WebUI, ensure that no one is using the system. You might need to make the changes after normal office hours.



The WebUI settings available to you vary according to the system configuration.

- T1, SIP, and ATA settings and features are only available and visible in the WebUI when those devices are installed.
- Many settings available in Call Appearance mode are not available in Line Appearance mode.



To configure a newly installed Synapse System, see the Synapse Administrator's Guide at www.telephones.att.com/synapseguides.

To configure the Synapse System, you may have to change the default settings for the following features and devices.

Appearance Mode

By default, the Synapse system starts up in Call Appearance mode. If you need to change the appearance mode, change it at the beginning of the installation—after you have installed one Deskset but before you have installed all the Desksets. If possible, setting the appearance mode should be a one-time procedure. See **“Changing the System Basic Settings”** and **“Configuring Line Appearance”** in the System Administrator's Guide.

Dial Plan Settings

Synapse features a configurable dial plan, with which you can configure settings for internal calls and outgoing external calls. You can select formats for Deskset extension numbers and parked call extension numbers. You can also configure how numbers for outgoing calls are dialed to maximize user convenience and compatibility with your Synapse equipment, location, and service provider. See **“Dial Plan Settings”** in the System Administrator's Guide.

Call Restriction Settings

Call Restriction enables you to prohibit certain types of calls from being made from certain extensions. The feature affects outgoing calls only. No matter how Call Restriction is configured, users can answer and transfer all incoming calls. See **“Call Restriction Configuration”** and **“Configuring ATA Call Restriction Settings”** in the System Administrator's Guide.

Direct Inward Dial

When the system is set to Call Appearance mode, use the **Direct Inward Dial** page to assign unique telephone numbers to specific Desksets. Callers can bypass the Call Queue, Auto Attendant, or Operator by using those telephone numbers. The T1 Gateway



and SIP Gateway use the Direct Inward Dial (DID) data from your Telephone Service Provider to automatically route incoming calls. See **“Direct Inward Dial”** in the System Administrator’s Guide.

Trunk Naming

Name the system trunks for easier identification. For PSTN Gateways, you can assign names to all lines—up to 16, depending how many PSTN Gateways are installed. For the T1 Gateway, there is only one physical trunk, so only that one trunk can be named. You can name SIP accounts on the SIP Account Settings page. Renaming PSTN Gateway trunks is highly recommended in Line Appearance mode and when reserving trunks. See **“Trunk Naming”** in the System Administrator’s Guide.

Trunk Reservation

Reserve a PSTN telephone line, T1 channel, or SIP account for an extension, so that only that extension can use that line, channel or account for outgoing calls. Trunk reservations apply only to outgoing calls. A user with a reserved trunk will not be able to make outgoing calls if all lines and channels are busy with incoming calls. If necessary, 911 calls use trunks that are reserved for other extensions. See **“Trunk Reservation (Outgoing Calls)”** in the System Administrator’s Guide.

Trunk Routing

Route incoming calls on a PSTN Gateway line, T1 Gateway, or SIP Account to specific destination. See **“Trunk Routing (Incoming Calls)”** in the System Administrator’s Guide.

ATA Settings

Configure the two FXS ports on the ATA. See **“Configuring ATA FXS Ports”** in the System Administrator’s Guide.

SIP Gateway Settings

Enter SIP account details to register the SIP Gateway with your Service Provider. See **“SIP Gateway Settings”** in the System Administrator’s Guide.

T1 Gateway Settings

Modify the settings of your T1 connection. Most installations will use the default settings. See **“T1 Gateway Settings”** in the System Administrator’s Guide.

Fax Configuration

Select a PSTN Gateway line as your fax line and assign an ATA FXS port as your fax line destination. You can select a DID number for incoming faxes on the Direct Inward Dial Assignments WebUI page. See **“Fax Configuration (Requires ATA)”** and **“DID Assignments”** in the System Administrator’s Guide.

Overhead Paging

Set up Overhead Paging and create Paging Zones. See **“Overhead Paging Overview (ATA Required)”** and **“Creating, Editing and Deleting Paging Zones”** in the System Administrator’s Guide.



Configuring a Trunk Port (FXO) Door Phone

You can configure a Trunk Port (FXO) door phone as described in [“Trunk Port \(FXO\) Door Phone Support” on page 24](#) using several different WebUI pages. The procedure varies depending on whether the system is in Call Appearance mode or Line Appearance mode. The outcome of the procedure ensures that door phone calls are routed to the correct destination, and that the door phone’s connection to a PSTN Gateway line does not affect regular inbound and outbound call activity.

To configure a trunk port (FXO) door phone (Call Appearance mode):

1. Enable Door Phone Mode.
 - a. In the navigation menu at left, click **Device Management**, then **Device Log**.

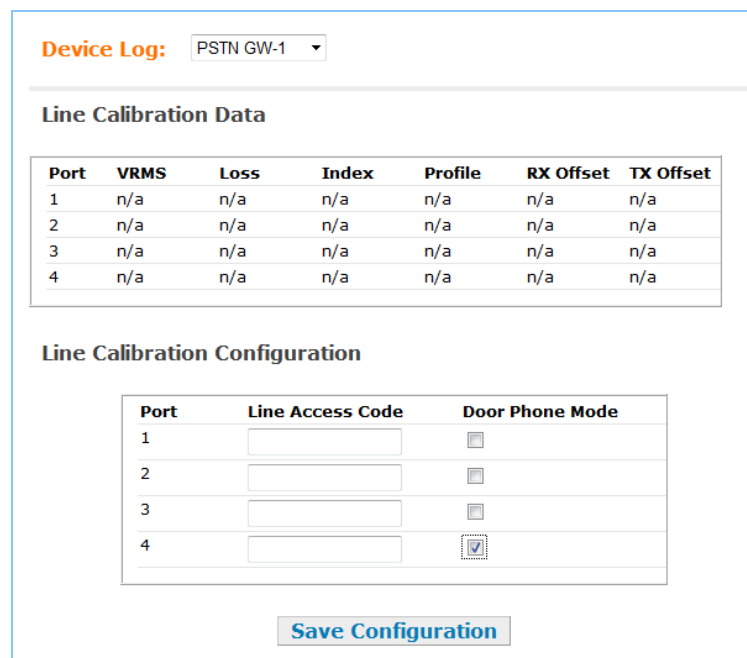

The screenshot shows the 'Device Log' configuration page. At the top, there is a dropdown menu for 'Device Log' set to 'PSTN GW-1'. Below this is a section titled 'Line Calibration Data' containing a table with the following data:

Port	VRMS	Loss	Index	Profile	RX Offset	TX Offset
1	n/a	n/a	n/a	n/a	n/a	n/a
2	n/a	n/a	n/a	n/a	n/a	n/a
3	n/a	n/a	n/a	n/a	n/a	n/a
4	n/a	n/a	n/a	n/a	n/a	n/a

Below the table is a section titled 'Line Calibration Configuration' containing another table:

Port	Line Access Code	Door Phone Mode
1	<input type="text"/>	<input type="checkbox"/>
2	<input type="text"/>	<input type="checkbox"/>
3	<input type="text"/>	<input type="checkbox"/>
4	<input type="text"/>	<input checked="" type="checkbox"/>

At the bottom of the configuration area is a 'Save Configuration' button.

- b. In the **Device Log** list, select the PSTN Gateway that will connect to the door phone.
 - c. Under **Line Calibration Configuration**, select a PSTN Gateway port to be the door phone port (under **Door Phone Mode**).
 - d. Click **Save Configuration**.
2. Name the trunk that the door phone will use.
 - a. In the navigation menu at left, click **Trunk Naming**.



- b. On the **Trunk Naming** page, select the trunk (PSTN Gateway port) for which you enabled Door Phone Mode in Step 1.
 - c. Give this trunk a name such as “Door” or “Entry”.
3. Click **Apply**.
4. Reserve the trunk that the door phone will use. Doing this will prevent other Desksets from seizing the door phone line for outside calls.
 - a. In the navigation menu at left, click **Trunk Reservation**.

- b. Select an extension to reserve the door phone trunk for outgoing calls. The Deskset should then be disconnected from the network or used only for internal calls.
 - c. In the **Trunk Assigned** list, select the trunk you named in Step 2.
 - d. Click **Apply**.
5. Route the door phone trunk to the desired destination.
 - a. In the navigation menu at left, click **Trunk Routing**.



Trunk Routing

TRUNK ROUTING	
Trunk	Destination

Select Trunk:

Route Call to:

- b. In the **Select Trunk** list, select the door phone trunk.
 - c. In the **Route Call to** list, select the extension or Ring Group that you want the door phone to ring.
6. Click .

To configure a trunk port (FXO) door phone (Line Appearance mode):

1. Enable Door Phone Mode.
 - a. In the navigation menu at left, click **Device Management**, then **Device Log**.

Device Log:

Line Calibration Data

Port	VRMS	Loss	Index	Profile	RX Offset	TX Offset
1	n/a	n/a	n/a	n/a	n/a	n/a
2	n/a	n/a	n/a	n/a	n/a	n/a
3	n/a	n/a	n/a	n/a	n/a	n/a
4	n/a	n/a	n/a	n/a	n/a	n/a

Line Calibration Configuration

Port	Line Access Code	Door Phone Mode
1	<input type="text"/>	<input type="checkbox"/>
2	<input type="text"/>	<input type="checkbox"/>
3	<input type="text"/>	<input type="checkbox"/>
4	<input type="text"/>	<input checked="" type="checkbox"/>

- b. In the **Device Log** list, select the PSTN Gateway that will connect to the door phone.
- c. Under **Line Calibration Configuration**, select a PSTN Gateway port to be the door phone port (in the **Door Phone Mode** column).
- d. Click **Save Configuration**.



2. Name the trunk that the door phone will use.
 - a. In the navigation menu at left, click **System Settings**, then **Trunk Naming**.

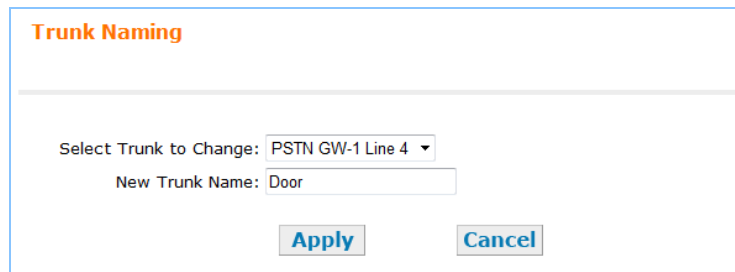

- b. On the **Trunk Naming** page, select the trunk (PSTN Gateway port) for which you enabled Door Phone Mode in Step 1.
 - c. Give this trunk a name such as “Door” or “Entry”. Because this name appears on SB67030/031 Deskset screens, names should be four to six characters in length.
 3. Click **Apply**.

If you selected GW-1 (PSTN Gateway 1) in Step 1b, all Desksets that were assigned the door phone line you selected in Step 1c now have the Line Appearance key for that line assigned to answer door phone calls. On SB67030/031 Desksets, the Trunk Name you assigned in Step 2 appears. If necessary, go to Step 4 to assign the door phone line to a different key, or disable door phone line access for certain Desksets.

4. If necessary, assign the door phone trunk to an extension’s Programmable Feature Key (PFK). You can assign this trunk to a single extension or multiple extensions, thereby controlling which Deskset users can answer door phone calls.
 - a. In the navigation menu at left, click **Extension Settings**.
 - b. Select an extension, then click **Feature Keys** in the navigation menu at left.
 - c. Select the door phone trunk from the list for the desired PFK. If the door phone trunk is already assigned to a PFK, select **None** to make it available to other PFKs or to disable door phone functionality for the Deskset. SB67030/031 Deskset PFKs are shown in [Figure 46 on page 89](#) and SB67020 Deskset PFKs are shown in [Figure 47 on page 89](#).
 - d. Click **Apply**.



Programmable Feature Keys

Current Appearance Mode: Line Appearance

Select an Extension: 229

Select the door phone trunk, or select None to assign it to other PFKs or disable door phone access for this Deskset.

1	<input type="checkbox"/>	Line 1
2	<input type="checkbox"/>	Line 2
3	<input type="checkbox"/>	Line 3
4	<input type="checkbox"/>	Door
5	<input type="checkbox"/>	Intercom
6	<input type="checkbox"/>	Quick Dial

Apply Cancel

Figure 46. SB67030/031 Deskset PFKs

Programmable Feature Keys

Current Appearance Mode: Line Appearance

Select an Extension: 219

For outside phone numbers, enter a Trunk Prefix first (if your system uses a Trunk Prefix)

Select the door phone trunk, or select None to assign it to other PFKs or disable door phone access for this Deskset.

1	<input type="checkbox"/>	Line 1	
2	<input type="checkbox"/>	Line 2	
3	<input type="checkbox"/>	Line 3	
4	<input type="checkbox"/>	Door	
5	<input type="checkbox"/>	Quick Dial	Name: Milford Taxi Number: 916045550182
6	<input type="checkbox"/>	Held Calls List	
7	<input type="checkbox"/>	Redial	
8	<input type="checkbox"/>	Directory	
9	<input type="checkbox"/>	Call Log	
10	<input type="checkbox"/>	Intercom	

Apply Cancel

Figure 47. SB67020 Deskset PFKs



Line Calibration Configuration

If your system uses Centrex lines, you must enter an outbound line prefix or code in order for line calibration to take place. You should perform this procedure before connecting the lines to the PSTN Gateway. Consult your Centrex line provider for the correct code to enter.



NOTE

Centrex lines operate in Line Appearance mode only.

To enter Centrex line access codes:

1. In the navigation menu at left, click **Device Management**, then **Device Log**.
2. Select the PSTN Gateway from the **Device Log** drop-down list. **Line Calibration Data** and **Line Calibration Configuration** appear.

Line Calibration Data

Port	VRMS	Loss	Index	Profile	RX Offset	TX Offset
1	1087	22.5	5	0	0	0
2	1231	21.4	5	0	0	0
3	954	23.6	6	0	0	0
4	5402	8.5	0	1	0	0

Line Calibration Configuration

Port	Line Access Code	Door Phone Mode
1	<input type="text"/>	<input type="checkbox"/>
2	<input type="text"/>	<input type="checkbox"/>
3	<input type="text"/>	<input type="checkbox"/>
4	<input type="text"/>	<input checked="" type="checkbox"/>

[Save Configuration](#)

3. Enter the Line Access Code for each line. Do not enter a code for a line that has been selected for Door Phone Mode.



NOTE

The **Door Phone Mode** column is used for selecting a line for a Trunk Port (FXO) door phone. See ["Configuring a Trunk Port \(FXO\) Door Phone" on page 85](#).

4. Click **Save Configuration**.

You can now connect the physical lines to the PSTN Gateway.



Updating Devices

New software versions improve system functionality. All Gateways, the optional ATA, and all Desksets should be running the same software version number. (The optional Cordless Handsets and Cordless Headsets have different software version number sequences.)

You can update all devices with one command, or you can update the Synapse devices individually.

AT&T recommends automatic device software upgrades for installations with Internet access. This allows your system to obtain the latest upgrade from our server. Automatic upgrades may not work if your network's firewall prohibits connection to the AT&T servers, or if you do not have DNS services provided by your ISP. If you need to manually initiate updates, see ["To update all devices to the latest software version:" on page 92](#). If Internet access is not available, see ["To update a single device to the latest software version:" on page 93](#).

**NOTE**

Sometimes devices with different versions of software cannot detect each other in the WebUI. Some versions of Synapse software codes are incompatible, so that when you use one device's IP address for logging into the WebUI, only the devices with compatible code versions appear in the device lists. For this reason, if you are updating devices individually, wait until all other devices are updated before updating the software version of the device whose IP address was used for logging into the WebUI. When an updated device restarts with new software, it may disappear from the device list.

**NOTE**

When you add a new "out of box" device that has software version 1.7.10 or higher to the system, the device automatically gets new software from the network and then restarts. Allow this process to complete before using the device. The process may take anywhere between 30 seconds to a few minutes, depending on server speed.

**CAUTION**

Although unlikely, some types of software upgrades could interfere with system settings and directories. Therefore, back up the system settings and Deskset settings before updating the system software. If you receive automatic updates, back up each device after each configuration change.

The device restarts after a software upgrade. Ensure that there are no calls in progress or they will be dropped.

**NOTE**

If a PC is installed in series with the Deskset, restarting the Deskset causes the PC's connection to the network to be briefly lost.



To update all devices to the latest software version:

1. In the navigation menu at left, click **Device Management**, then **Update Device**. The **Update Device** page appears.

Update Device: Ext. 202

Current Software Version
synapse-ds-petra-v1.10.0

Update Software from the Internet
[Check For Update](#)

Update Software From File
Software File: [Browse...](#)
[Install Software](#)

Update All Devices Automatically
[Update All Devices](#)

2. At the bottom of the page, press [Update All Devices](#). The system looks on the Internet for the latest software and systematically updates and then restarts each device. All calls are dropped.

A caution appears to remind you that all devices will be restarted as each is updated.

**NOTE**

Any Desksets registered with the system but disconnected at the time of the update will be updated as soon as they are reconnected to the system.

After you have started an update using [Update All Devices](#), attempts to manually update a device through the device itself or the WebUI may be interrupted by the system software update in progress.

**NOTE**

Using [Update All Devices](#) requires a minimum Internet download bandwidth of 1 Mbps and an Internet router that can handle the same number of total simultaneous connections as the number of Synapse devices. Refer to your router specification. Performing an update without meeting the minimum requirement may cause some or all devices not to update correctly. See [“System Upgrade” on page 117](#).

The total time to update all the devices varies. The update time depends on Internet connection speed, the number of connections to the server, and the number of devices in the system. AT&T recommends conducting system updates overnight to reduce the impact on Deskset users.

If the automatic process does not work, you can manually upgrade a Deskset, Gateway, or ATA individually.



To update a single device to the latest software version:

1. In the navigation menu at left, click **Device Management**, then **Update Device**.
2. In the **Update Device** list, select a Gateway, ATA, or Deskset to update.

The Current Software Version for that device appears.

**NOTE**

You can only update one device at a time. Only the selected device is updated.

3. Click **Check For Update** .

If there is an update available on the Internet, the message “There is new software available” appears. Click **Install Update** . The specified device restarts.

OR

In the **Update Software From File** section of the page, enter a file name or click **Browse...** to select a previously acquired upgrade file. Once selected, click **Install Software** . The specified device restarts.

4. After the device restarts, check the software version number at the device to confirm that the upgrade was successful.

SB67030/031

Press **MENU**, then **4**. Check the **P Firmware Ver.**

SB67020

Press **MENU**, then **4**. Check the **Software Ver.**

Gateway, ATA

Press **SELECT**, **SELECT** and **DOWN**. Check the **SW Ver.**

**NOTE**

If the device is sluggish or unresponsive during the upgrade process, see [“A Synapse device becomes sluggish or unresponsive during or immediately after software upgrade.” on page 155.](#)

When an updated device restarts with the new software, it may disappear from the device list if its software version is incompatible with the device whose IP address was used for logging into the WebUI.



Product Registration

In order to keep your system up to date with the latest upgrades and ensure timely warranty support, it is extremely important to register your system. To register a device, you need its MAC address.

To find a Deskset MAC address:

- For Desksets, at the Desksets, press **MENU**, then press **4**. Note the **MAC Address** line.

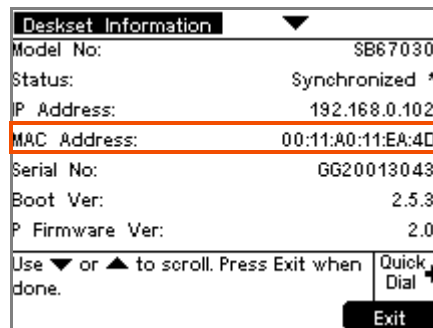

SB67030/031 Deskset

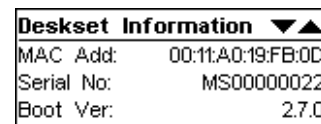

SB67020 Deskset

To find a Gateway or ATA MAC address:

- For Gateways and the ATA, at the devices, press **SELECT**, **DOWN**, **SELECT**, and then press **DOWN** until **MAC Address** appears.

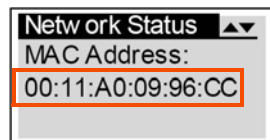

To register your Synapse system:

- Open a new browser tab and navigate to the product registration web site <http://smbtelephones.att.com/registration>
- Select your products, then complete the form.
- When the form is complete, click [Register Product](#).



CHAPTER
4

TROUBLESHOOTING

If you have difficulty operating your system, try the following suggestions in this section:

- [“Common Troubleshooting Procedures” on page 96](#)
- [“Initial Installation” on page 105](#)
- [“Display Messages” on page 106](#)
- [“WebUI” on page 112](#)
- [“PC/Deskset Interaction” on page 119](#)
- [“Other Deskset Features” on page 120](#)
- [“SB67050 Analog Terminal Adapter” on page 123.](#)

**NOTE**

For customer service or product information, contact the person who installed your system. If your installer is unavailable, visit our web site at www.telephones.att.com/smb or call **1 (888) 916-2007**. In Canada dial **1 (888) 883-2474**.



Common Troubleshooting Procedures

Follow these procedures to resolve common issues.

Resetting Devices

You may need to manually restart a device or return a device to factory defaults (see [“Appendix B: Default Settings” on page 146](#)). To reset a device, press the **RESET** button shown in [Figure 48 on page 97](#) and [Figure 49 on page 97](#) by inserting a pen or paper clip into the hole and applying pressure to the button. The T1 Gateway and ATA (not shown) have a **RESET** button in the same front-panel location as the PSTN Gateway. Although [Figure 49 on page 97](#) shows the SB67030/031 Deskset, the SB67020 Deskset reset button is in the same location.

To restart the device without losing any custom settings, press the **RESET** button for less than five seconds. You can get the same result by disconnecting and reconnecting power to the device. You can restart the device if the device does not respond or fails to synchronize with the system.

To completely reset the device to factory defaults, unplug the LAN cable and press the **RESET** button for more than five seconds. You might do this if the device is not synchronized or you want to reset the IP address settings to Auto (DHCP). Any static IP configurations are lost.

When resetting a Deskset to factory defaults, the system configuration (the user settings and Personal directory) and Voicemail messages, Call Log, and the Redial list are all deleted. You can use this complete reset when assigning Desksets to new users. If you do not disconnect the LAN cable before pressing the **RESET** button, the extension number is retained. During the reset, any PC connected to the Deskset PC port momentarily loses network connectivity.

**NOTE**

To reset the entire system to factory defaults and completely clear the system of all settings (Auto Attendant, Ring Groups, hold message, and System Directory) and Voicemail messages, unplug the LAN cables from all devices and press the **RESET** button for more than five seconds on each device. Then reconnect all devices to the LAN.

If there is one Gateway in the system, but there are still Desksets connected, then only the voice prompts and hold messages are deleted; the rest of the Auto Attendant settings are maintained on the Desksets. If there is another Gateway, the other Gateway maintains all system configuration settings.

**NOTE**

If you have already set up the system, back up the Deskset and system settings before resetting the device to factory defaults.



For more information, see the Synapse Administrator's Guide at www.telephones.att.com/synapseguides.



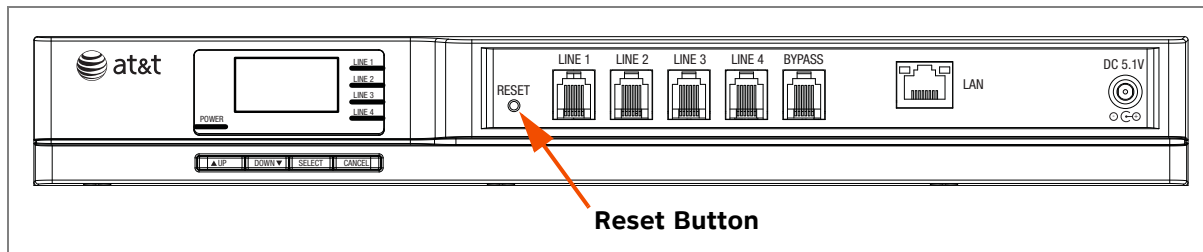

Reset Button

Figure 48. PSTN Gateway Reset Button

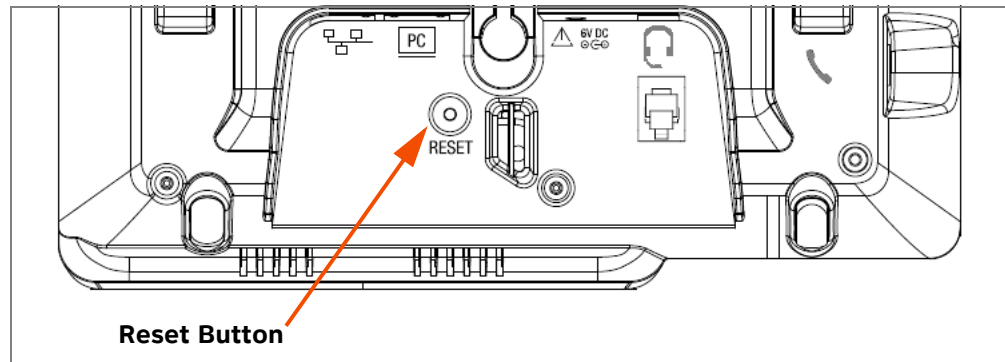

Reset Button

Figure 49. Deskset Reset Button

Resolving General Functional Issues

To resolve a blank screen or device that does not work at all:

- Ensure the AC plug is plugged into an electrical outlet not controlled by a wall switch.
- Verify that the AC power outlet has power. Try plugging in some other AC device. If nothing works, contact an electrician or use another power outlet.
- Verify that the DC plug is plugged into the power jack on the device.
- The system devices are not immediately active when powered up and after a power interruption. Allow at least 30 seconds for the device to boot up.
- If this is a Gateway or ATA, check the LED status. The POWER LED should be **GREEN**.
- For Desksets connected to PoE, check whether any PoE switch ports have been configured for devices that require less power. If so, configure your PoE switch to auto-detect device power requirements. For Deskset PoE specifications, see [page 144](#).

To resolve a sluggish, unresponsive, or unusually behaving device:

Reset the device by pressing the **RESET** button for less than five seconds (see [Figure 50 on page 99](#)) or by removing and restoring AC power.



CAUTION Pressing the **RESET** button for more than five seconds will erase all data and settings.



To resolve an incorrect system clock:

If the system clock displays the wrong time, the system lacks Internet access for acquiring current time data.

1. Log on to the WebUI as administrator and click **System Basic Settings**.
2. In the **System Time/Date Options** section, specify a local Network Time Protocol (NTP) Server, or manually set the time. Then click [Apply](#).



To restore a Deskset to factory defaults:

To restore a Deskset to factory defaults, insert a pen or paper clip into the reset hole on the bottom of the Deskset (as shown in Figure 50) and press the **RESET** button for more than five seconds.

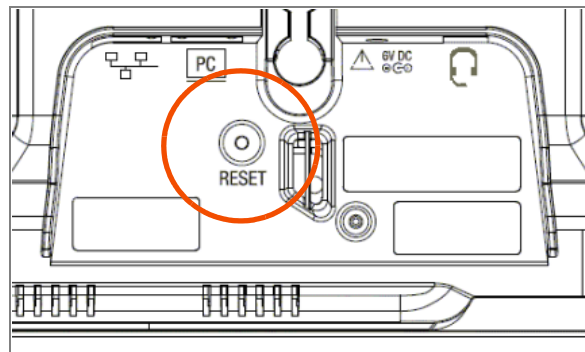

Figure 50. Deskset Reset Button

To resolve problems with a cordless device:

For features or audio problems, make sure that the Deskset associated with the cordless device does not share the problem.

1. Verify that the device battery has power.
 - When removed from the charger, the Handset screen is lit for about 30 seconds.
 - When removed from the charger, the Headset emits a dial tone or three beeps when you press **ON/OFF**.
2. Verify that the Deskset **Cordless Settings** screen indicates that the device is registered.
 - Press **MENU** → **2** → **6**.
 - If the Handset is not registered, register it:
 - a. Place the Handset in the charger.
 - b. At the Deskset, press **MENU** → **2** → **6** → **1** → **Register**.
 - If the Headset is not registered, register it:
 - a. Place the Headset in the charger.
 - b. At the Deskset, press **MENU** → **2** → **6** → **2** → **Register**. In Line Appearance mode, press **MENU** → **2** → **3** → **2** → **Register**.



Resolving Audio Echoes (PSTN Gateway)

The SB67010 PSTN Gateway uses automatic telephone line calibration to ensure optimal audio performance on outside calls. If excessive echo occurs on outside calls consistently, observe the Gateway line calibration data to understand any telephone line issues. Occasional echoes may be caused by the other person's phone.

To resolve audio echo issues:

1. Log on to the WebUI as administrator. Click **Device Management**, then **Device Log** in the navigation menu at left.
2. Select the PSTN Gateway from the drop-down list. Line Calibration Data appears as shown in Figure 51.
3. Check the loss numbers within the Line Calibration Data box for each telephone line on each Gateway. (A loss number above 10 indicates good audio performance.)

Line Calibration Data						
Port	VRMS	Loss	Index	Profile	RX Offset	TX Offset
1	1087	22.5	5	0	0	0
2	1231	21.4	5	0	0	0
3	954	23.6	6	0	0	0
4	5402	8.5	0	1	0	0

Figure 51. Line Calibration Data

4. If the loss number is below 10, the system will most often function normally, but there is an increased likelihood of audio performance issues like echo. If the loss number is below 10 the following procedures can be used to increase the loss value:
 - a. Unplug that telephone line at the Gateway.
 - b. After the line LED turns red, plug the line back in to recalibrate.
5. If the recalibration has no effect, a parallel device such as a fax adapter, alarm system, DSL modem, or DSL splitter/filter may be connected to the system. Parallel external devices may affect line calibration. Disconnect these devices from the telephone wall jacks that are connected to the same telephone lines, as follows:
 - a. Unplug these non-system external devices from their telephone wall jacks.
 - b. Unplug the telephone line connections from the Gateway.
 - c. After the Gateway Line-Status LEDs turn red, plug the telephone lines into the Gateway again to recalibrate.
 - d. If there is a significant increase in the loss number and improved audio performance on those lines after disconnecting a parallel device, consult your telephone service provider to either investigate the problem or to install separate lines for those parallel devices.



Resolving General Audio Issues

Check the following if you hear static, sudden silences, gaps in speech, echoes, distorted speech, or garbled speech.

To resolve general audio issues:

You may be experiencing network problems.

- Your LAN administrator should ensure the following minimum guidelines are met:
 - A switched network topology, which requires attaching network components to switches rather than hubs, is recommended. The network should use standard 10/100 Ethernet switches that carry traffic at a nominal rate of 100 Mbit/s.
 - The office network infrastructure should use Cat.-5 wiring.
- Do not connect a network server PC to the PC port on the Deskset.

If you have Digital Subscriber Line (DSL) service, you may be experiencing telephone line problems.

- Make sure you have a DSL filter plugged in between each DSL line and the telephone wall jack.
- You may need a higher quality DSL filter than you are currently using. You can also try plugging in multiple DSL filters in sequence to decrease DSL interference.
- Move the DSL line to the lowest priority line, which is Line 4 on the highest numbered PSTN Gateway, as indicated on the Gateway display.

The PSTN Gateway might not have recognized a new outside telephone line, so line calibration — which allows the PSTN Gateway to adjust its performance depending on the phone lines' characteristics — did not occur. After unplugging the telephone line, wait two full seconds for the LED to turn red before plugging the telephone line back into the Gateway.

Reintroducing a Deskset Into the System

If there are no more than 100 Desksets in the system and a Deskset screen displays **Synch Failed** or **Synchronizing** for a long time, you may need to remove the Deskset from the system and reintroduce it. This problem may have been caused by a network disruption, the Deskset having been part of a different network, or by an AC power failure.

To reintroduce a Deskset into the system:

1. Ensure that the Deskset is connected to the same LAN subnet as other system Gateways and Desksets. Ensure that the PC you will use to access the WebUI is either on the same subnet as Synapse, or that the PC subnet can communicate with the Synapse subnet. Devices on the same subnet generally share the first three octets of their IP addresses. If the subnets are different, contact your installer.
2. If you want to retain the programming for a problem Deskset, back up the Deskset.
 - a. Log on to the WebUI as administrator on the problem Deskset. Click **Device Management**, then **Back up/Restore**, and then **Extension Settings** in the navigation menu at left.



- b. Select the extension from the **Select Extension to Back up** drop-down list, and click **Back up Extension** to save the file to a specified location on your computer. You will need to locate and retrieve this file later, so make sure you remember where you saved it. The default file name will be in the format:

backup_ds_[extension number]_[year]-[month]-[day]_[time].cfg.

If you back up the same extension less than one minute after creating the backup, you may overwrite the earlier backup file.

3. Perform a complete factory reset to return to the values set at the factory.
 - a. Unplug the LAN cable.
 - b. Insert a pen or the end of a paper clip into the **RESET** button, located on the underside of the Deskset. Hold until **Restoring to Factory Defaults** appears on the screen (approximately 5 seconds).

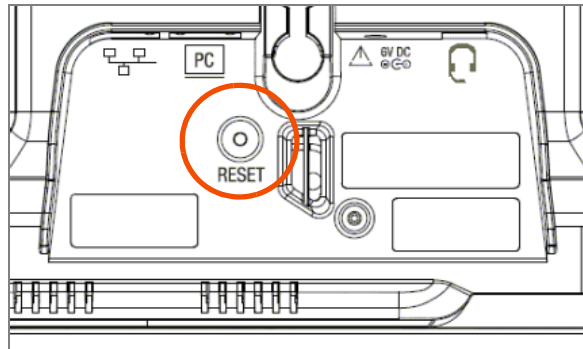

After the Deskset restarts, the screen displays **EXT 0**.

- c. Reconnect the LAN cable.

The Deskset rejoins the system. Unless the entire system was reset, the Deskset retains its previous extension number. After the Deskset rejoins the system, the screen changes from **EXT 0** to the previous extension number.
4. If you backed up the Deskset settings in Step 2, restore your settings.
 - a. Log on to the WebUI as the Administrator at the PC where you stored the backup file.

Synapse Desksets with static IP addresses need to have new addresses assigned if the Deskset IP addresses are to be used for logging into the WebUI. At the Deskset, press **MENU** → **3** → **3** → **2** to set the **IP address**.
 - b. Click **Device Management**, then click **Back up/Restore**.
 - c. Under **Restore Extension Settings**, select the Deskset's extension number from the **Select Extension to Restore** drop-down list. See ["Back Up and Restore Settings" on page 130](#).
 - d. Select the backup file.
 - e. Click **Restore Extension**.



Reintroducing a Gateway or ATA Into the System

If there are no more than five Gateways in the system (four PSTN Gateways and one T1 Gateway), and a Gateway or ATA screen displays **Synch Failed** or **Synchronizing** for more than a few minutes, you may need to remove the Gateway or ATA from the system and reintroduce it. This problem may have been caused by the Gateway or ATA having been part of a different network or by a network disruption, which may have been caused by an AC power failure.

To reintroduce a Gateway or ATA into the system:

1. Ensure that the Gateway or ATA is connected to the same LAN as other system Gateways, Desksets, and the PC you will use to access the WebUI. Confirm that the first three octets of the IP address match other devices in the system.
2. Back up the system if you are reintroducing a Gateway and this is the only Gateway.



If you are reintroducing a Gateway or ATA, and there are other Gateways that are synchronized, this step is **NOT** necessary.

- a. Log on to the WebUI as administrator using the Gateway or ATA **IP Address** shown on the Gateway or ATA display.
- b. Click **Device Management**, then **Back up/Restore**, then **System Settings** in the WebUI navigation menu at left.
- c. Click **Back up System Settings** and save the file to a specified location on your computer. You will need to locate and retrieve this file later, so make sure you remember where you saved it. The file name will be in the format:

backup_system_[year]-[month]-[day]_[time].cfg.

If you back up the system less than one minute after creating another backup, you may overwrite the earlier file.

The system backup also saves ATA setup information.

3. Disconnect the Gateway or ATA from the network by unplugging the Ethernet cable from the Ethernet port located on the front of the Gateway.
4. Complete a factory reset to restore factory values. Insert a pen or the end of a paper clip into the **RESET** button (located on the front of the Gateway and ATA) and hold it for more than five seconds until the LCD displays **Restoring to factory defaults**.
5. Reconnect the Gateway or ATA to the network and ensure that it synchronizes with the other devices.
6. If you are reintroducing the only system Gateway, restore your settings.
 - a. Log on to the WebUI as administrator at the PC where you stored the backup file.
 - b. Click **Device Management**, then **Back up/Restore**, then **System Settings** in the navigation menu at left.
 - c. Under **Restore System Settings**, click and select the correct backup file.
 - d. Click **Restore System Settings**.



Power Failure Recovery Procedure

The Synapse system automatically recovers after a power failure. The following describes the recovery process.

Allow about a minute for the Gateways and ATA to boot up when power returns after a power failure. The power-up sequence for the Gateways and ATA follows:

1. About 20 seconds after turning on power to the device, the POWER LED turns on.
2. When the device finds the network, **Synchronizing** momentarily appears, indicating that the device is in the process of detecting and synchronizing with other system devices.

```
03:45PM 24-FEB-10
PSTN Lines 1 - 4
Synchronizing...
```

3. Once the device has successfully finished synchronizing with the rest of the system, **Synchronized** appears.

```
03:45PM 24-FEB-10
PSTN Lines 1 - 4
Synchronized
IP: 192.168.1.4
```

When AC power returns after a power failure, the system self-assigns a link-local address to the Deskset beginning with number 169.254.

- If the Deskset is set for automatic IP address configuration, it searches for the DHCP server. If the DHCP server is found, it assigns an IP address.
- If the Deskset is set with static IP addresses, the address does not change.

We recommend that you check each Deskset, Gateway and ATA to confirm that it has started up properly.

If any of the system devices' screens report **Synch Failed** or **Synchronizing** for more than 10 minutes, see ["Reintroducing a Deskset Into the System" on page 101](#) and ["Reintroducing a Gateway or ATA Into the System" on page 103](#) for recovery methods from these states.



NOTE

The time and date may not be correct. The time and date are set using the WebUI ["System Basic Settings" on page 28](#).

The Desksets also automatically restart and synchronize after an AC power failure.



NOTE

Some systems will take longer than others depending on the network topology.



Initial Installation

The device screen displays **Synchronizing**.

Probable Cause	Corrective Action
The device has previous data and settings that are now inconsistent with current system settings.	<ul style="list-style-type: none">■ Erase all Deskset data and settings by unplugging the LAN cable and pressing the reset button on the bottom of the Deskset for more than five seconds.■ The Ethernet cable may be connecting the Network port on the bottom of the Deskset, marked , to another system device, rather than to the Network. Make sure the Ethernet cable is attached to the LAN.



Display Messages

The Gateway screen is blank.

Probable Cause	Corrective Action
Many.	<ul style="list-style-type: none"> See “To resolve a blank screen or device that does not work at all:” on page 97.

The Gateway screen displays Joining Site... for more than one minute.

Probable Cause	Corrective Action
The Gateway is failing to synchronize with a Deskset configured for a different system configuration.	<ul style="list-style-type: none"> Always disconnect the LAN cable before restoring factory defaults (by pressing the RESET button more than five seconds).

The device screen displays Network Down.

Probable Cause	Corrective Action
The Ethernet cable is unplugged.	<ul style="list-style-type: none"> Ensure that one end of the Ethernet cable is plugged into the port marked LAN on the device and that the other end is plugged into your office LAN. Confirm that the Ethernet port light next to the Ethernet port is green. If it is not, unplug the cable and plug it in again.
There may be a problem with the office network.	<ul style="list-style-type: none"> Check if other network devices, such as computers, are communicating with the network. If not, then contact your IT administrator.

The device screen displays Synch Failed.

Probable Cause	Corrective Action
The device synch failed when trying to connect to the system.	<ul style="list-style-type: none"> Reset the device. Insert a pen or paper clip into the reset hole and press for more than five seconds.
The device was disconnected, then reconnected after configuration changes were made to the system.	<ul style="list-style-type: none"> See “Reintroducing a Deskset Into the System” on page 101 or “Reintroducing a Gateway or ATA Into the System” on page 103.



Probable Cause	Corrective Action
The device was configured on another network or has returned to the system after being deleted from the system.	<ul style="list-style-type: none"> Reset to factory defaults by using a paper clip to press and hold the RESET button for more than five seconds. See “Reintroducing a Deskset Into the System” on page 101 or “Reintroducing a Gateway or ATA Into the System” on page 103.
The maximum number of that type of device has been reached.	<ul style="list-style-type: none"> A device must be removed from the network and deleted from the system before another device can be added.
The same Deskset extension number already exists.	<ul style="list-style-type: none"> Reset the Deskset to factory defaults without the network cable connected. Use a paper clip to press and hold the RESET button for more than five seconds.

The device screen displays **Synchronizing**.

Probable Cause	Corrective Action
Not enough time has elapsed.	<ul style="list-style-type: none"> The device may display Synchronizing for a few seconds. This is normal and does not indicate a problem.
This device is the first Synapse device on the network.	<ul style="list-style-type: none"> Connect another Synapse device to the network.
The devices are on different subnets.	<ul style="list-style-type: none"> If you use static IP addresses, ensure that the first three octets of the device IP address matches the IP addresses of the other system devices. For more information, see the Synapse Installation Guide.
The device may have been configured on another network.	<ul style="list-style-type: none"> Power cycle the Deskset by unplugging the power cord and plugging it back in. If power cycling does not work, back up your Deskset and reset to factory defaults. <ol style="list-style-type: none"> Back up the Deskset. See “Back Up and Restore Settings” on page 130. Unplug the LAN cable Press the RESET button for at least five seconds. Restore your settings after the Deskset restarts.



Deskset cannot make or receive phone calls and the Deskset screen displays Synchronizing.

Probable Cause	Corrective Action
The Deskset may have an incompatible software version.	<ul style="list-style-type: none"> Log on to the WebUI using the IP address of the Deskset and update the software. See “Updating Devices” on page 135.

A Synapse device displays Host Not Found after a user attempts a software upgrade.

Probable Cause	Corrective Action
The user attempted a software upgrade with no outside Internet connection.	<ul style="list-style-type: none"> Ensure you have Internet connectivity and that your connection to your Internet Service Provider is operating normally. Ensure your firewall is not blocking http requests. Ensure that http requests are not being directed to a firewall log-in page. Ensure that your http requests are not being routed through a proxy server.

A Synapse device displays an error message other than Host Not Found after a user attempts a software upgrade.

Probable Cause	Corrective Action
The device encountered an unexpected problem.	<ol style="list-style-type: none"> Disconnect the power to the device, wait a few minutes, then reconnect the power and try the upgrade process again. If the error message persists, contact the person who installed your system. If your installer is unavailable, visit our web site at www.telephones.att.com/smb or call 1 (888) 916-2007. In Canada, call 1 (888) 883-2474.



T1 Gateway Indicators

I cannot make or receive phone calls and the T1 Gateway SYN/ACT LED is **GREEN**.

Probable Cause	Corrective Action
There are no T1 channels available to make the call.	<ul style="list-style-type: none"> ■ Check the T1 trunk configuration. <ol style="list-style-type: none"> a. Log on to the WebUI as administrator, click System Settings, then T1 Settings. b. Verify that Number of Voice Channels and Lowest Voice Channel have been configured correctly according to your T1 service. c. Click Trunk Reservation and verify that the assignments are correct.

I cannot make or receive phone calls and the T1 Gateway RAI/LOF/LOS LED is **YELLOW**.

Probable Cause	Corrective Action
<p>The Yellow Alarm is a Remote Alarm Indication.</p> <p>Telephone equipment outside of your Synapse system is sending an alarm that signals that it is receiving unreliable signals.</p>	<ol style="list-style-type: none"> 1. Check the T1 Settings to confirm that the configuration parameters (Signaling type, Buildout) correspond to the service provider's. 2. If the problem remains, contact your T1 service provider.

I cannot make or receive phone calls and the T1 Gateway RAI/LOF/LOS LED is **RED**.

Probable Cause	Corrective Action
<p>The Red Alarm indicates Loss of Frame. A signal is present, but its pattern cannot be interpreted.</p> <p>There is an error in the signal from the service provider.</p>	<ol style="list-style-type: none"> 1. Check the T1 Settings to confirm that the configuration parameters (Signaling type, Build out) correspond to the service provider's. 2. If the problem remains, contact your T1 service provider.



I cannot make or receive phone calls and the T1 Gateway RAI/LOF/LOS LED is flashing RED.

Probable Cause	Corrective Action
The Flashing Red alarm indicates Loss of Signal	1. Verify that your T1 cable is connected to the equipment.
There is loss of valid signal from the service provider.	2. Check the T1 Settings to confirm that the configuration parameters (Signaling type, Build out) correspond to the service provider's.
	3. If the problem remains, contact your T1 service provider.

I cannot make or receive phone calls and the T1 Gateway AIS LED is flashing BLUE.

Probable Cause	Corrective Action
The Blue Alarm is an Alarm Indication Signal.	<ul style="list-style-type: none"> ■ Contact your T1 service provider.
The T1 circuit is operating correctly, but the service provider is not sending proper data.	

I cannot make or receive phone calls and the T1 Gateway LOOPBK LED is GREEN or flashing GREEN.

Probable Cause	Corrective Action
The system is in Local Network or Loopback test mode.	<ul style="list-style-type: none"> ■ The LOOPBK LED should only be ON when you have activated a Loopback test. If this test should not be running, disable the Loopback Test in the Admin WebUI. <ul style="list-style-type: none"> a. Log on to the WebUI as administrator, click T1 Settings, then T1 Diagnostics. b. In the Set Loopback Mode list, select None. c. Click <input type="button" value="Apply"/>.

I cannot make or receive phone calls and the T1 Gateway LOOPBK LED is RED.

Probable Cause	Corrective Action
The T1 Gateway is not synchronized with the Synapse system.	<ul style="list-style-type: none"> ■ Check the Ethernet connection to your Synapse T1 Gateway.



I cannot make or receive phone calls and the T1 Gateway SYN/ACT LED is OFF and RAI/LOF/LOS LED is **RED**.

Probable Cause	Corrective Action
The T1 Gateway is not synchronized with the T1 service.	<ul style="list-style-type: none"> Check the correct T1 cable is used and that it is properly connected to the T1 Gateway.

PSTN Gateway Setup

Line-Status LEDs do not flash red when the telephone line cords are plugged into the Gateway after power is switched on.

Probable Cause	Corrective Action
Line calibration allows the PSTN Gateway to adjust its performance depending on the phone lines' characteristics. The Gateway may not have performed calibration.	<ul style="list-style-type: none"> Make sure an Ethernet cable is plugged into the port marked LAN. Unplug the PSTN telephone line and wait two full seconds for the Gateway line LED to turn red before plugging it back in.

Bypass jack does not work during power failure.

Probable Cause	Corrective Action
The PSTN line is not in the correct jack.	<ul style="list-style-type: none"> Make sure there is a PSTN line plugged into Line 4. Make sure an analog phone is plugged into the Bypass jack (using a modular line cord).



WebUI

Administrator WebUI

The WebUI is unresponsive.

Probable Cause	Corrective Action
The web browser encountered an unexpected problem.	<ol style="list-style-type: none"> 1. Close the unresponsive web browser, reopen the browser, and log back in as administrator. 2. If this does not work, try again using the IP address of a Deskset that is connected to the PC you are using. 3. If this does not work, try closing the browser and waiting 10 minutes before logging back in.

The WebUI displays “Login to target device failed.”

Probable Cause	Corrective Action
The software version of the device you are currently logged into is no longer compatible with the software version of other devices within the network.	<ol style="list-style-type: none"> 1. Log on to the WebUI as administrator using the IP address of the device that caused the problem. Click Device Management, then Update Device in the WebUI navigation menu at left. 2. Click <input type="button" value="Install Update"/>. The selected device updates its software and reboots. 3. After the device reboots, check the software version number on the device to confirm that the upgrade was successful. <ul style="list-style-type: none"> ■ On the Deskset, press MENU → 4. Note the P Firmware Ver [030/031] or Software Ver [020] value. ■ On the Gateway or ATA, press the <input type="button" value="SELECT"/> key to access the Main Menu. Then select Device Information, then SW Ver.
The device to be updated is unplugged.	<ul style="list-style-type: none"> ■ Verify that the device is powered up.
The device to be updated has failed to synchronize with the system.	<ul style="list-style-type: none"> ■ Verify that the other device says Synchronized. If it does not, see “Reintroducing a Deskset Into the System” on page 101 or “Reintroducing a Gateway or ATA Into the System” on page 103.



A Synapse device upgrade failed, the WebUI displays “Login to target device failed”, and the WebUI and device screens display the old software version.

Probable Cause	Corrective Action
The software version of the device you are currently logged into is no longer compatible with the software version of other devices within the network.	<ol style="list-style-type: none">1. Log on to the WebUI as administrator using the IP address of a device that does not have updated software and is not having any problems. Click Device Management, then Update Device.2. Select a device from the Update Device drop-down list. Do not select the device whose IP address you are using.3. Click <input type="button" value="Install Update"/> . The selected device updates its software and reboots.4. After the device reboots, check the software version number on the device to confirm that the upgrade was successful.<ul style="list-style-type: none">■ On the Deskset, press MENU → 4. Note the P Firmware Ver [030/031] or Software Ver [020] value.■ On the Gateway or ATA, press the <input type="button" value="SELECT"/> key to access the Main Menu. Then select Device Information, then SW Ver.5. After updating all other devices, upgrade the device whose IP address you are using.



Some devices did not update after using [Update All Devices](#).

Probable Cause	Corrective Action
Did not allow enough time for software to update due to a slow Internet connection.	<ul style="list-style-type: none"> ■ Wait 30 minutes, then check whether additional devices have been updated. If devices are still being updated, then the Internet connection is slow and you must wait for all the devices to complete the update process. ■ If the update has failed (you see a failure message), retry Update All Devices. Allow sufficient time for the upgrade process to complete. You may prefer to schedule a system update to take place overnight. ■ Update individual devices manually either through the front panel or through the WebUI for that particular device. <hr/> <p> NOTE If you are using the WebUI to upgrade the device, ensure that you log on using that device's IP address.</p> <hr/> <ul style="list-style-type: none"> ■ Power cycle each device that did not get upgraded. Unplug the power cord and plug it back in. As each device reboots, it automatically updates (if it detects updated software in the system).

The Outgoing Caller ID option does not appear on the Extension Basic Settings page of the administrator WebUI.

Probable Cause	Corrective Action
A DID number has not been assigned.	<ul style="list-style-type: none"> ■ Assign a DID number to the extension. <ul style="list-style-type: none"> a. Log on to the WebUI as administrator and click System Settings, then Direct Inward Dial, then DID Assignments. b. In the Destination column, select the desired extension as the destination for a DID Number. c. Click Apply.



An extension number was not changed correctly.

Probable Cause	Corrective Action
That extension may have been on a call while the extension number was changed in the WebUI, or someone tried to change the extension number to a number that was already being used.	<ul style="list-style-type: none"> ■ Change the extension number again. Make sure no one is using that extension while you are changing its settings. <ol style="list-style-type: none"> a. Log on to the WebUI as administrator, click Extension Settings, then Basic Settings. b. Enter a new extension number in the Change Extension Number to box.

I changed an extension number, but the DID number did not change.

Probable Cause	Corrective Action
DID numbers do not change when extension numbers are changed.	<ul style="list-style-type: none"> ■ Assign a DID number to the extension. <ol style="list-style-type: none"> a. Log on to the WebUI as administrator and click System Settings, then Direct Inward Dial, then DID Assignments. b. In the Destination column, select the desired extension as the destination for a DID Number. c. Click Apply.

I cannot find the specific DID number for assignment on the DID Assignments page.

Probable Cause	Corrective Action
There may be a DID range error. The DID is not within the DID ranges configured.	<ul style="list-style-type: none"> ■ Check the DID ranges configuration. <ol style="list-style-type: none"> a. Log on to the WebUI as administrator, click System Settings, then Direct Inward Dial. b. Verify the Current DID Ranges.

WebUI reverts to Log-in page after clicking a navigation link.

Probable Cause	Corrective Action
The browser is not checking for newer versions of pages.	<ul style="list-style-type: none"> ■ Ensure that your Internet browser is working normally. It may not be automatically caching pages. For example, in Internet Explorer 7, click Tools → Internet Options. Then under Browsing history, click Settings. Under Check for newer versions of stored pages, select Automatically.



Changes made to the T1 Settings WebUI page do not change the system.

Probable Cause	Corrective Action
Clicking Apply alone may not perform the needed reset of the T1 Gateway.	<ul style="list-style-type: none"> After you make changes to the T1 Settings WebUI page and click Apply, press the T1 Gateway RESET button for less than five seconds or remove and restore AC power to the T1 Gateway.
	 <i>Pressing the RESET switch for more than five seconds will erase all data and settings.</i>

Changes made to System Configuration from the WebUI are not saved.

Probable Cause	Corrective Action
The device whose IP address you used to log in to the WebUI failed to synchronize with the system. The WebUI displays "Unable to save data at this time. Please re-enter and try again."	<ul style="list-style-type: none"> Check the device status in the footer of the WebUI page. If the status reads "Synch Failed," see "Reintroducing a Deskset Into the System" on page 101 or "Reintroducing a Gateway or ATA Into the System" on page 103.
More than one person is using the WebUI to change System Configuration at the same time.	<ul style="list-style-type: none"> Make sure only one person at a time logs on as the administrator.
Apply must be clicked on each page to confirm the changes.	<ul style="list-style-type: none"> Click Apply on each page to confirm the changes.

Prompt created for Auto Attendant menu or Hold Announcement is not saved.

Probable Cause	Corrective Action
You must hang up the extension before saving the recording.	<ul style="list-style-type: none"> After recording a prompt for an Auto Attendant menu or for the Hold Announcement, hang up the extension before clicking Save Recording in the WebUI.

I cannot record a Hold Announcement or an Auto Attendant prompt.

Probable Cause	Corrective Action
Calls to the extension you want to use may be immediately forwarded.	<ul style="list-style-type: none"> Choose an extension that is not set up to automatically forward calls.



My hold announcement is cut off.

Probable Cause	Corrective Action
Hold announcements in later versions of Synapse are limited to two minutes.	<ul style="list-style-type: none"> Record your hold announcement again. Keep it under two minutes in length.

System Upgrade**A Synapse device becomes sluggish or unresponsive during or immediately after software upgrade.**

Probable Cause	Corrective Action
Cannot connect to AT&T server or the device encountered an unexpected problem.	<ul style="list-style-type: none"> Disconnect the power to the device, wait a few minutes, then reconnect the power and try the upgrade process again.

During device upgrade one of the following messages appears: “UNKNOWN ERROR Current image version” or “UNKNOWN ERROR”.

Probable Cause	Corrective Action
A communication error between the devices and the server.	<ul style="list-style-type: none"> If this failure occurred after clicking Update All Devices, power cycle each device that did not get upgraded. Unplug the power cord and plug it back in. As each device reboots, it automatically updates (if it detects updated software in the system). Wait 30 minutes to allow for the device to update. If the system has a very low bandwidth Internet connection, it may take up to 4 hours. If this failure occurred during a manual single-device update, power cycle the device that did not get upgraded. Unplug the power cord and plug it back in. As the device reboots, it automatically updates (if it detects updated software in the system).



User WebUI

Unable to access the WebUI Log-in page from my computer.

Probable Cause	Corrective Action
The computer is not connected to the same subnet (network) as the Deskset, and the subnets are not set up to communicate.	<ul style="list-style-type: none"> Verify the IP address. You must correctly enter the IP address of your Deskset into your Internet browser's address bar. At the Deskset, press MENU → 4 to see the IP address displayed in the third line of the information. Ensure that there is an Ethernet cable attached to Network port on the Deskset and to the LAN. If a PC at the same workstation is sharing the LAN connection, attach an Ethernet cable to your computer's Ethernet port and to the PC port on the back of the Deskset. Confirm that your computer and your Deskset are on the same subnet so that they can talk to each other. Check that the first three sections of each IP address are the same. If they are not, they may not be connected to the same subnet. Contact the installer; the subnets may not be set up to communicate.
The local address, rather than the network IP address, was used in the address line of the browser.	<ul style="list-style-type: none"> Use the network IP address assigned through DHCP or manually in the address bar of the browser.



Changes made to System Configuration from the WebUI are not saved.

Probable Cause	Corrective Action
Apply must be clicked on each page to confirm the changes.	<ul style="list-style-type: none"> Click Apply on each page to confirm the changes.



PC/Deskset Interaction

Internet connection or access to the local network on my computer does not work after installing the Deskset.

Probable Cause	Corrective Action
The Ethernet cords are not installed correctly.	<ul style="list-style-type: none"> Check that the Ethernet cord from the computer is plugged into the Deskset port labeled . A second Ethernet cord should be plugged into the Ethernet port on the Deskset marked  with the other end plugged into your LAN.

My PC is slower now that I have connected it to the LAN through the Deskset.

Probable Cause	Corrective Action
A computer connected through the Deskset will be limited to 100 Mbits/s.	<ul style="list-style-type: none"> Use separate Ethernet connections for the Deskset and the computer so that the computer can take advantage of the network's greater bandwidth.

My PC, which is connected to the LAN through the Deskset, briefly loses its network connection.

Probable Cause	Corrective Action
For PCs connected to the LAN through Desksets, disruption to the Deskset operation affects the PC. For example, when the Deskset restarts (possibly due to a software upgrade) the connection to the LAN is temporarily lost.	<ul style="list-style-type: none"> If the PC is connected to the LAN through the Deskset, avoid updating software or restoring the Deskset settings when a user is at the workstation. If the PC is connected to the Deskset, and if the PC is connected to an Uninterruptible Power Supply (UPS), plug the Deskset into a UPS. Use separate Ethernet connections for the Deskset and the computer.



Other Deskset Features



For more information about the corrective actions recommended in this troubleshooting section, see the SB67030/031 Deskset and Accessories User's Guide and SB67020 Deskset User's Guide at www.telephones.att.com/synapseguides.

Other Desksets do not appear in the extension list.

Probable Cause	Corrective Action
The Deskset is not connected to the same subnet as the other Desksets.	<ul style="list-style-type: none"> Verify that the first two sections of the IP address (the portion before the second "dot") match the IP addresses of the other Desksets or that the subnets are set up to communicate with each other. Press MENU → 4 at a Deskset to find the IP address. If the other Desksets have been assigned static IP addresses, you may have to assign your Deskset a static IP address to match the other Desksets.

I am unable to record a greeting.

Probable Cause	Corrective Action
The selected Deskset is set up to forward all calls.	<ul style="list-style-type: none"> Select a different Deskset to record the greeting. Disable the call forwarding on the selected Deskset. Press CallFwd [030/031] or MENU → 1 → 6 [020].

There is no **DistrList key so I cannot forward messages to Distribution list.**



Probable Cause	Corrective Action
The DistrList key is not present unless the Distribution List feature is enabled and the extension user created at least one Distribution List.	<ul style="list-style-type: none"> Log in to the WebUI as a user and click Voicemail Distribution. Enable Voicemail Distribution, and create one or more Distribution Lists.



My Deskset soft keys have changed.

Probable Cause	Corrective Action
The highlight bar has moved to another line on the screen.	<ul style="list-style-type: none"> The soft keys reflect the call state and Deskset functions. They change depending on which line is highlighted. <p>For example, there may be a held call, an active call, or an incoming call on the screen. To view the soft keys for that call, move the highlight bar by pressing Δ or ∇.</p>

I am unable to add an entry to Quick-Dial list.

Probable Cause	Corrective Action
If you have an SB67030/031 Deskset, the Quick-Dial list is full — there are six entries available.	<ul style="list-style-type: none"> Edit Quick-Dial entries on the Deskset to write over an existing entry: <ol style="list-style-type: none"> Press the button to the right of . Press Edit List to add or edit a Quick-Dial entry. Edit Quick-Dial entries on the WebUI to write over an existing entry: <ol style="list-style-type: none"> Log in to the WebUI as a user and click Quick Dial Keys. Edit the Quick-Dial entries. Press Apply.
Your SB67030/031 Deskset has been configured for Call Queue and the Quick-Dial key and Quick-Dial list are unavailable.	<ul style="list-style-type: none"> If necessary, configure the Deskset to use Quick Dial instead of Call Queue. See Feature Keys under the Extension Settings menu. <ul style="list-style-type: none">  For more information, see the Synapse Administrator's Guide at www.telephones.att.com/synapse_guides.
If you have an SB67020 Deskset, you must configure one or more Programmable Function Keys as Quick Dial keys before they can be used.	<ul style="list-style-type: none"> Configure one or more Quick-Dial keys for the Deskset. See Feature Keys under the Extension Settings menu. <ul style="list-style-type: none">  For more information, see the Synapse Administrator's Guide at www.telephones.att.com/synapse_guides.



I am unable to locate the Cordless Handset from the SB67030/031 Deskset.

Probable Cause	Corrective Action
The Cordless Handset's battery is dead.	<ul style="list-style-type: none"> Charge the Cordless Handset battery.
The Cordless Handset is out of range or not registered.	<ul style="list-style-type: none"> If LocateHS does not appear on the Deskset Idle screen, then the Cordless Handset is not registered. Register the Handset at the Deskset. Press MENU → 2 → 6 → 1 → Register.
You deregistered the Cordless Handset on the Handset, but the Deskset still indicates it is registered.	<ul style="list-style-type: none"> Deregister the Cordless Handset on the Deskset. On the Deskset, press MENU → 2 → 6. If the Handset is registered, the screen indicates 1. Handset (Registered). Press 1 → DeReg to deregister the Handset.

Cannot make or receive phone calls on the T1 channels.

Probable Cause	Corrective Action
Incoming or outgoing calls using the T1 trunk are attempted before the SYN/ACT LED is GREEN .	<ul style="list-style-type: none"> Press the RESET button on the front panel of the T1 Gateway for less than 5 seconds. Wait for the SYN/ACT LED to turn GREEN before making or receiving any T1 calls or receiving calls on the T1 Gateway.



SB67050 Analog Terminal Adapter

General Troubleshooting

ATA does not work at all. The Power LED is off.

Probable Cause	Corrective Action
There is no power to the device.	<ul style="list-style-type: none"> ■ Ensure the AC plug is plugged into an electrical outlet not controlled by a wall switch. ■ Verify that the AC power outlet has power. Plug in a lamp. If the lamp won't light, contact an electrician or use another power outlet. ■ Verify that the DC plug is a 12V 1500mA adapter and plugged into the power jack marked DC 12V  on the front of the ATA.

ATA screen displays Network Down.

Probable Cause	Corrective Action
The Ethernet cable is unplugged.	<ul style="list-style-type: none"> ■ Ensure that one end of the Ethernet cable is plugged into the port marked LAN on the front of the ATA and that the other end is plugged into your office LAN. ■ Confirm that the Ethernet port light next to the Ethernet port on the ATA is green. If it is not, unplug the cable and plug it in again.
There may be a problem with the office network.	<ul style="list-style-type: none"> ■ Check if other network devices, such as computers, are communicating with the network. If not, then contact your IT administrator.

ATA screen displays Synch Failed.

Probable Cause	Corrective Action
The ATA was disconnected, then reconnected after configuration changes were made to the system.	<ul style="list-style-type: none"> ■ See “Reintroducing a Gateway or ATA Into the System” on page 103.
The ATA was configured on another network or has returned to the Synapse system after being deleted from the system.	<ul style="list-style-type: none"> ■ Reset to factory defaults by using a paper clip to press and hold the reset button (located on the front of the unit) for more than five seconds. See “Reintroducing a Gateway or ATA Into the System” on page 103.



ATA is not active immediately after a power interruption.

Probable Cause	Corrective Action
The ATA needs time to restore service.	<ul style="list-style-type: none"><li data-bbox="776 359 1421 428">■ Allow at least 30 seconds for the ATA to boot up again after a power failure.



Music on Hold (MoH)

Music on Hold (MoH) is not playing and the AUX IN LED is OFF.

Probable Cause	Corrective Action
MoH is disabled.	<ul style="list-style-type: none"> Log in to the WebUI as administrator, click System Settings, then Hold Settings. Set Select Port to be ATA: AUX IN and then click Apply.

MoH is not playing and the AUX IN LED is solid **RED**, but MoH is enabled in the WebUI.

Probable Cause	Corrective Action
MoH not properly connected and no connected equipment is detected in AUX IN.	<ul style="list-style-type: none"> Verify that an audio source is connected to AUX IN on the ATA and power is applied.

MoH audio is interrupted.

Probable Cause	Corrective Action
Hold Announcement is enabled.	<ul style="list-style-type: none"> The Hold Announcement is a feature that repeats a recorded audio clip at regular intervals during MoH. <p> For more information, see the Synapse Administrator's Guide at www.telephones.att.com/synapse guides.</p>

My audio player jack is not the same size as the supplied audio cable.

Probable Cause	Corrective Action
Your audio device does not have a 3.5mm audio out jack.	<ul style="list-style-type: none"> Use a different audio cable with ends to fit your audio device and the 3.5mm AUX IN jack on the ATA.

 **CAUTION** Do not exceed the ATA AUX IN input specifications. Grossly exceeding these specifications can damage the ATA. See "[Appendix A: Technical Specifications](#)" on page 143.



MoH is not playing and the AUX IN LED is GREEN.

Probable Cause	Corrective Action
MoH not properly configured.	<ul style="list-style-type: none">■ Verify that the audio source is playing and not muted.■ Set the MoH output volume level by adjusting the playback volume of the music source device connected to the ATA. You may need to set the volume near the maximum.■ Some MoH sources without volume controls, such as those with audio-out jacks, are usually very loud and might be too loud.■ Synapse limits the volume of the sound delivered to the phone line. Because of this, there may be audio clipping (missing sounds) for some sources.■ Some forms of music do not play well over a telephone line.■ Verify that the audio source meets the electrical specifications for ATA AUX IN. See "Appendix A: Technical Specifications" on page 143.■ Verify that Hold Announcement is not playing a silent message. <p> For more information, see the Synapse Administrator's Guide at www.telephones.att.com/synapse/guides.</p>



MoH audio is too quiet, fluctuating, or dropping out.

Probable Cause	Corrective Action
<p>The volume on the audio source is too low or too high. If the volume is too high, overdriving the audio components may be causing short periods of sound to drop out (not be heard).</p>	<ul style="list-style-type: none"> ■ If you can adjust the output volume of your audio source (like the headset jack of an MP3 player), call into your Synapse system, place the call on hold, listen to MoH on the outside line, and adjust the audio volume on your audio source up or down until the best sound quality is achieved. ■ If your audio source does not have adjustable volume, such as the AUX OUT on a radio, verify that the audio source meets the electrical specs for ATA AUX IN. See “Appendix A: Technical Specifications” on page 143. ■ If you created a recording to use as the audio source, try to adjust the recording volume by speaking louder or speaking closer to the microphone. ■ Please note that some types of music sound better than others when played across a telephone line. For example, classical music with extreme volume fluctuations may not sound very good when used as MoH.
<p>Use of audio source outputs whose levels are not adjustable, such as RCA “Line Out” may result in unacceptable background music levels and should not be used.</p>	<ul style="list-style-type: none"> ■ Use an audio source with output volume control.
<p> CAUTION Do not exceed the ATA AUX IN input specifications. Grossly exceeding these specifications can damage the ATA. See “Appendix A: Technical Specifications” on page 143.</p>	



Overhead Paging (OHP)

OHP General Troubleshooting

Overhead paging (OHP) is not working.

Probable Cause	Corrective Action
<p>You don't know whether your OHP is single- or multi-zone and whether it needs an FXS or an Audio-Out connection.</p>	<ul style="list-style-type: none"> ■ There are three possible configurations for OHP: <ul style="list-style-type: none"> ● Single-zone paging connected to the AUX OUT jack. ● Single-zone paging connected to one of the two FXS ports. ● Multi-zone paging connected to one of the two FXS ports. ■ Select the appropriate configuration for your specific paging equipment. See “Overhead Paging Overview” on page 20. ■ Refer to your OHP product documentation and the respective troubleshooting section below. The paging equipment, the jack it is plugged into, and the WebUI must all match.
<p>The OHP may not be properly installed.</p>	<ul style="list-style-type: none"> ■ For OHP equipment connected to an FXS port, verify WebUI configuration: <ol style="list-style-type: none"> a. Connect a corded phone to the FXS port configured for paging and verify that the phone rings when it is paged. b. If the phone does not ring, there is a problem with the WebUI configuration or the installation at the ATA. c. If the phone rings, the configuration allows communication with the OHP. Verify your paging equipment. Does it have power? Is it turned on? ■ For OHP equipment connected to the AUX OUT port, verify the correct cable connections. See “Connecting an Overhead Paging System (OHP)” on page 47. <p>Refer to your paging equipment documentation if there are still problems.</p>



I cannot add a multi-zone Paging Zone to other Paging Zones.

Probable Cause	Corrective Action
Multi-zone paging does not allow a combination of OHP equipment and Desksets within one Paging Zone.	<ul style="list-style-type: none">■ Page multi-zone OHP zones separately from extensions.

Unable to make phone calls on the extension configured for the FXS OHP jack.

Probable Cause	Corrective Action
System limitation.	<ul style="list-style-type: none">■ Once an FXS is configured for OHP, it cannot be used for audio calls, nor will it receive voice calls.



Single-Zone OHP Connected to AUX OUT Jack

For OHP equipment connected to the AUX OUT jack, this Troubleshooting refers to the ATA front-panel AUX OUT LED. This describes the behavior of these LEDs:

- **OFF**: There is a problem with the WebUI configuration for OHP. Either **Paging** is disabled, or the selected **Paging Port** is not AUX OUT.
- **RED**: Although the WebUI supports OHP, no connection is detected.
- Steady **GREEN**: The WebUI is configured for OHP on AUX OUT, it is enabled, and the ATA has detected that a cable is connected.
- Flashing **GREEN**: An OHP is in progress.

We also use these LEDs to help diagnose problems.

Single-zone OHP on AUX OUT is not working and the AUX OUT LED (right of the ATA LCD screen) is OFF.

Cause	Action
The OHP is not configured in the WebUI for use on AUX OUT.	<ul style="list-style-type: none"> ■ Verify the Single-Zone on AUX OUT WebUI configuration: <ol style="list-style-type: none"> a. Log on to the WebUI as administrator, click System Settings, then Overhead Paging. b. Verify that Paging is Enabled. If not, select Enable. c. Verify that the Paging System Type is set to Single Zone. d. Verify that Select Paging Port is set to AUX OUT and that your OHP system is physically plugged into the AUX OUT jack. e. Click <input type="button" value="Apply"/>
The OHP is not a member of a Paging Zone.	<ul style="list-style-type: none"> ■ Verify that the OHP equipment is part of the Paging Zone that you are trying to page.

Single-zone OHP on AUX OUT is not working and AUX OUT LED (right of the ATA LCD screen) is solid RED.

Cause	Action
The OHP is configured for use, but no connector is detected in the jack.	<ul style="list-style-type: none"> ■ Verify that your paging equipment is connected to AUX OUT. If not, connect it, or change the OHP configuration in the WebUI if your OHP equipment is intended to be connected to an FXS port. For background information and configuration instructions, see “Overhead Paging Overview” on page 20..



Single-zone OHP on AUX OUT is not working and the AUX OUT LED (right of the ATA LCD screen) is solid GREEN and the WebUI is configured for paging through the AUX OUT jack.

Cause	Action
The ATA has detected a cable connected to the AUX OUT jack. There may be a problem with your paging equipment or its configuration.	<ul style="list-style-type: none"> ■ Refer to your OHP product documentation for installation and configuration instructions. ■ To isolate OHP-related problems, connect PC speakers to the AUX OUT jack configured for paging. If the page is broadcast through the speakers when paged, refer to the documentation that came with your OHP. ■ Verify your paging equipment configuration. Check to see if the OHP system has settings that need to be adjusted to work with Synapse. Refer to your paging equipment documentation or to your VAR.

Single-zone OHP on AUX OUT is not working and the AUX OUT LED (right of the ATA LCD screen) is flashing GREEN.

Cause	Action
Paging is active (a user on the system is paging the OHP system). There may be a problem with the paging equipment or its setup.	<ul style="list-style-type: none"> ■ Verify your paging equipment configuration. Check to see if the OHP system has settings that need to be adjusted to work with Synapse. Refer to your paging equipment documentation or to your installer.

In single-zone paging, paging starts on Desksets before the paging starts on the OHP system.

Cause	Action
Paging delay is too short.	<ul style="list-style-type: none"> ■ Verify that the Paging Delay is set to an appropriate delay to work with your OHP system. <ol style="list-style-type: none"> a. Log on to the WebUI as administrator, click System Settings, then Overhead Paging. b. Set the Paging Delay. c. Click <input type="button" value="Apply"/> .



Single-Zone OHP Connected to an FXS Port

For OHP equipment connected to an FXS port, this Troubleshooting refers to the ATA front-panel FXS LED for the FXS port you are using for the OHP equipment. When the equipment is properly installed, and everything is configured correctly, this is the behavior of these LEDs:

- **OFF**: There is no paging activity.
- Flashing **GREEN**: A user has initiated a page.
- Solid **GREEN**: A device other than an OHP (such as a fax machine) is connected to the FXS port and has gone off hook.

We also use these LEDs to help diagnose problems.

Single-zone OHP on FXS is not working.

Cause	Action
The OHP may not be properly installed.	<ul style="list-style-type: none"> ■ Test basic OHP functionality. <ol style="list-style-type: none"> a. Connect a corded phone to the FXS port configured for paging. b. Page all extensions and verify that the phone rings when paged. c. If the phone does not ring, there is a problem with the WebUI configuration or the installation at the ATA. d. If the phone rings, the configuration allows communication with the OHP, verify your paging equipment: <ul style="list-style-type: none"> □ Does it have power? Is it turned on? □ Refer to your paging equipment documentation if there are still problems.
There may be a problem with the paging equipment or its setup.	<ul style="list-style-type: none"> ■ Verify your paging equipment configuration. Check to see if the OHP system has settings that need to be adjusted to work with Synapse. Refer to your paging equipment documentation or to your installer.



Cause	Action
There may be a problem with the connection between the FXS port and the OHP system.	<ul style="list-style-type: none"> ■ Verify that your paging equipment is connected to FXS 1 or FXS 2. If not, connect it, or change the OHP configuration in the WebUI if your OHP equipment is intended to be connected to the AUX OUT jack. For background information and configuration instructions, see “Overhead Paging Overview” on page 20. ■ Verify the Single-Zone on FXS WebUI configuration: <ul style="list-style-type: none"> a. Log on to the WebUI as administrator and click Overhead Paging. b. Verify that Paging is set to Enable. c. Verify that the Paging System Type is set to Single Zone. d. Verify that Select Paging Port is set to FXS 1 or FXS 2 and that your OHP system is physically plugged into the FXS port with the same number. e. Click <input type="button" value="Apply"/> .
There may be a problem with the Paging Zone setup.	<ul style="list-style-type: none"> ■ Verify that the Paging Zone you are paging includes Overhead Page.

Single-zone OHP on FXS is not working and the FXS LED (right of the ATA LCD screen) for the FXS port that is used for the OHP equipment is solid GREEN.

Cause	Action
A device other than an OHP (such as a fax machine) is connected to the FXS port and has gone off hook.	<ul style="list-style-type: none"> ■ Ensure that the OHP is connected to the correct ATA port. ■ Refer to your OHP product documentation for installation and configuration instructions. ■ Verify WebUI configuration (see “Verify the Single-Zone on FXS WebUI configuration:” on page 133).



Single-zone OHP on FXS is not working and the FXS LED (right of the ATA LCD screen) for the FXS port that is used for the OHP equipment is OFF.

Cause	Action
No signal is detected.	<ul style="list-style-type: none"> ■ There is no signal when no one is paging or the FXS ports are not configured for overhead paging. ■ Verify that your paging equipment is connected to FXS 1 or FXS 2. If not, plug it in, and verify your OHP equipment connections.
The OHP is not a member of a Paging Zone.	<ul style="list-style-type: none"> ■ Add OHP to the Paging Zone. <ol style="list-style-type: none"> a. Log on to the WebUI as administrator, click System Settings, then Paging Zones. b. Click the View/Edit button for the desired paging zone. c. Select Overhead Page from the Available Members list and click Add >. d. Click Apply.

In single-zone paging, paging starts on Desksets before the paging starts on the OHP system.

Cause	Action
Paging delay is too short.	<ul style="list-style-type: none"> ■ Verify that the Paging Delay is set to an appropriate delay to work with your OHP system. <ol style="list-style-type: none"> a. Log on to the WebUI as administrator, click System Settings, then Overhead Paging. b. Set the Paging Delay. c. Click Apply.



Multi-Zone OHP Connected to an FXS Port

For OHP equipment connected to an FXS port, this Troubleshooting refers to the ATA front-panel FXS LED for the FXS port you are using for the OHP equipment. When the equipment is properly installed, and everything is configured correctly, this is the behavior of these LEDs:

- **OFF**: There is no paging activity.
- Flashing **GREEN**: A user has initiated a page.
- Solid **GREEN**: A device other than an OHP (such as a fax machine) is connected to the FXS port and has gone off hook.

We also use these LEDs to help diagnose problems.

With multi-zone paging, paging all extensions does not broadcast over my OHP equipment.

Cause	Action
Multi-zone OHP cannot be paged at the same time as Desksets.	<ul style="list-style-type: none"> ■ To page the OHP, the user must select Overhead Paging from the Paging Zones selection screen on the Deskset. Selecting any other zone will not page the OHP system, even if the Paging Zones did include Overhead Paging prior to changing the Paging System Type to multi-zone.

Multi-zone OHP is not working.

Cause	Action
Inconsistent configuration.	<ul style="list-style-type: none"> ■ Verify the Multi-Zone WebUI configuration: <ol style="list-style-type: none"> a. Log on to the WebUI as administrator, click System Settings → Overhead Paging. b. Verify that Paging is set to Enable. c. Verify that the Paging System Type is set to Multi Zone. d. Verify that Select Paging Port is set to an FXS port and that your OHP system is physically plugged into that FXS port. e. Click <input type="button" value="Apply"/> .
The OHP cannot be paged at the same time as the Desksets.	<ul style="list-style-type: none"> ■ Page the Desksets and OHP separately.
There may be a problem with the paging equipment or its setup.	<ul style="list-style-type: none"> ■ Verify your paging equipment configuration. Check to see if the OHP system has settings that need to be adjusted to work with Synapse. Refer to your paging equipment documentation or to your installer.



Cause	Action
There may be a problem with the Paging Zone setup.	<ul style="list-style-type: none"> Verify that the Paging Zone you are paging is Overhead Paging.
There may be a problem with the connection between the FXS port and the OHP system.	<ul style="list-style-type: none"> Verify the connection between the FXS port and your OHP system. For background information and configuration instructions, see “Overhead Paging Overview” on page 20.

Multi-zone OHP is not working and the FXS LED for the FXS port that is used for the OHP equipment is OFF.

Cause	Action
No signal is detected.	<ul style="list-style-type: none"> There is no signal when no one is paging. Verify that your paging equipment is connected to FXS 1 or FXS 2. If not, connect it, and check your OHP equipment connections.
Inconsistent configuration.	<ul style="list-style-type: none"> Verify the WebUI configuration. See “Verified Overhead Paging Devices” on page 23.

Multi-zone OHP is not working and the FXS LED for the FXS port that is used for the OHP equipment is solid GREEN.

Cause	Action
A device other than an OHP (such as a fax machine) is connected to the FXS port and has gone off hook.	<ul style="list-style-type: none"> Refer to your OHP product documentation for installation and configuration instructions. Verify the WebUI configuration. See “Verified Overhead Paging Devices” on page 23.

Multi-zone OHP is not working and the FXS LED for the FXS port that is used for the OHP equipment is flashing GREEN.

Cause	Action
Someone has initiated a page, but the OHP equipment has not yet acknowledged the page request.	<ul style="list-style-type: none"> Verify the connection between the FXS port and your OHP system. See “Overhead Paging Overview” on page 20. Verify your paging equipment configuration. Check to see if the OHP system has settings that need to be adjusted to work with Synapse.



Fax Configuration

While using T.38 mode, unable to receive faxes or having persistent fax transmission failures.

Cause	Action
Incompatible Fax Mode setting.	<ul style="list-style-type: none"> ■ Change the Fax Mode setting: <ol style="list-style-type: none"> a. Log on to the WebUI as administrator, click System Settings, then Fax Configuration. b. Set Fax Mode to G.711. c. Click Apply .

While using T.38 mode, fax usually works with occasional failures.

Cause	Action
Network impairment issues.	<ul style="list-style-type: none"> ■ Resend the fax later or use the fax machine's retransmission feature.

While using G.711 mode, fax usually works with occasional failures.

Cause	Action
Network impairment issues.	<ul style="list-style-type: none"> ■ Resend the fax later or use the fax machine's retransmission feature. ■ If the above does not work, try switching the Fax Mode setting. <ol style="list-style-type: none"> a. Log on to the WebUI as administrator, click System Settings, then Fax Configuration. b. Set Fax Mode to T.38. c. Click Apply .



The fax is not working and the ATA FXS LED that corresponds to the port connected to the fax machine is OFF when the fax is attempting to send or receive a fax.

Cause	Action
The Gateway and the fax are not communicating.	<ul style="list-style-type: none"> ■ Verify the connection between the FXS port and your fax machine. For background information and configuration instructions, see “Overhead Paging Overview” on page 20. ■ Verify the fax configuration on the WebUI: <ol style="list-style-type: none"> a. Log on to the WebUI as administrator, click System Settings, then Fax Configuration. b. Verify that Fax is set to Enable and that Fax Mode is set to the appropriate setting. c. Verify that Fax Destination is set to the appropriate ATA FXS port and that the fax machine is physically connected to that jack. d. Verify that Fax Line is set to the correct Gateway line. Verify that the physical outside line on which incoming faxes are received is connected to the chosen Fax Line on the Gateway. If not, outgoing faxes will work but incoming faxes will be directed to the Auto Attendant instead of being directed to the fax. e. Click <input type="button" value="Apply"/> . f. Make sure the fax machine has power and is turned on.

The fax is not working and the ATA FXS LED that corresponds to the port connected to the fax machine is solid GREEN.

Cause	Action
The FXS port is configured for fax, and a phone connected to the FXS port is off hook.	<ul style="list-style-type: none"> ■ Verify the fax machine settings.



The fax is not working and the ATA FXS LED that corresponds to the port connected to the fax machine is flashing **GREEN**.

Cause	Action
The ring voltage is present but your FXS configuration may be wrong.	<ul style="list-style-type: none"> ■ Change the Fax Mode: <ol style="list-style-type: none"> a. Log on to the WebUI as administrator, click System Settings, then Fax Configuration. b. Change the Fax Mode setting, then click Apply. <p>The default Fax Mode is G.711. If the fax fails to work in G.711 mode, switch to T.38.</p>

The fax machine is connected to the telephone line through the Synapse system and the FXS LED indications appear correct, yet outgoing faxes fail.

Cause	Action
Number dialed incorrectly.	<ul style="list-style-type: none"> ■ To send faxes, ensure that you enter a 9 or whatever digit, if any, that must be dialed first for an outside call. For example, 9-1-555-0123.

Unable to receive incoming faxes.

Cause	Action
Fax line not configured properly.	<ol style="list-style-type: none"> 1. Log on to the WebUI as administrator, click System Settings, then Fax Configuration. 2. Verify that Fax Line is set to the correct line. 3. Verify that the physical outside line on which incoming faxes are received is connected to the chosen Fax Line on the Gateway. If not, outgoing faxes will work but incoming faxes will be directed to the Auto Attendant instead of being directed to the fax. 4. Click Apply.

Unable to make phone calls on the telephone that is part of my fax machine.

Cause	Action
System limitation.	<ul style="list-style-type: none"> ■ Once an FXS port is configured for fax, the fax machine's integrated telephone cannot be used for audio calls. If the fax machine has a corded handset, it will not receive voice calls, and even though a user may get a dial tone, dialing out is not possible.



Analog Phone

Analog phone connected to FXS port does not work as expected.

Cause	Action
The WebUI configuration is incorrect.	<ul style="list-style-type: none">■ Verify that your telephone is connected to FXS 1 or FXS 2. If not, plug it in, or change the analog telephone configuration in the WebUI. Verify that your phone is connected to the correct FXS port and that the phone has power. <ol style="list-style-type: none">1. Log on to the WebUI as administrator and click ATA Settings.2. Verify that the desired FXS port has a Voice assignment. If not, try connecting the analog telephone to the other FXS port or disable the other assignment. Voice is the default setting when no other assignments are enabled. If the desired FXS port is assigned to Fax:<ol style="list-style-type: none">a. Click System Settings, then Fax Configuration.b. Set Fax to Disable.c. Click <input type="button" value="Apply"/> . If the desired FXS port is configured for Overhead Paging:<ol style="list-style-type: none">a. Click System Settings, then Overhead Paging.b. Set Paging to Disable.c. Click <input type="button" value="Apply"/> .



Cause	Action
Analog phone is working with Synapse, but does not have Deskset capabilities.	<ul style="list-style-type: none"><li data-bbox="779 304 1425 556">■ Consider the analog phone limitations:<ul style="list-style-type: none"><li data-bbox="828 357 1425 556">● To make outgoing calls on an analog phone connected to the FXS port on the ATA, the outside phone number must be preceded by 9 or whatever digit, if any, that must be dialed first for an outside call (same as on a Deskset).<li data-bbox="779 567 1425 810">■ The analog phone connected to the FXS port on the ATA can pick up incoming calls and make outgoing calls. Idle, Ringing, Dial, caller ID, and Active states are all supported, but advanced features such as Call Waiting, Call Forward, Hold, Transfer, DND, Paging, Park, and Voicemail are not supported on analog phones.



Group Mailbox

Group Mailbox does not work.

Cause	Action
Needs an ATA to be available.	<ul style="list-style-type: none"> Group Mailboxes reside on the ATA. The ATA must be connected.

Group Mailbox is full even though it has not reached quota.

Cause	Action
The sum of the quotas for individual Group Mailboxes may exceed 60 minutes or some Group Mailboxes do not have quotas enabled. In other words, quotas do not reserve recording time for a given Group Mailbox. Quotas only limit the maximum amount of recording time available for a Group Mailbox.	<ul style="list-style-type: none"> The ATA allows for a total of 60 minutes of recording time for all Group Mailboxes. You can assign quotas for individual Group Mailboxes. Note that the sum of the quotas for individual Group Mailboxes may exceed 60 minutes. <ul style="list-style-type: none"> To free additional recording time for a Group Mailbox, delete messages on any of the Group Mailboxes. To prevent this problem from occurring again, reduce quotas to add up to 60 minutes or less, and make sure that all Group Mailboxes have quotas enabled. Note that personal messages reside on the specific Desksets and do not affect Group Mailbox recording time.

Unable to find a message.

Cause	Action
Group Mailboxes are accessed by multiple users.	<ul style="list-style-type: none"> None. Another user may have deleted the message you are looking for.

The number of new messages changed spontaneously.

Cause	Action
Group Mailboxes are accessed by multiple users.	<ul style="list-style-type: none"> None. Another user may have listened to the new messages or cleared "New" indicators from messages.



APPENDIXES

Appendix A: Technical Specifications

Table 9 lists the technical specifications for the SB67010 PSTN Gateway, SB67060 T1 Gateway, SB67070 SIP Gateway, SB67050 ATA, SB67030 Deskset, SB67031 Deskset, SB67020 Deskset, and SB67040 Cordless Handset.

Table 9. Technical Specifications

Feature	Specification
Frequency control	Crystal controlled PLL synthesizer
Transmit Frequency	Deskset, Cordless Handset, Cordless Headset: 1921.536–1928.448 MHz Deskset: 1921.536–1928.448 MHz
Nominal Effective Range	Maximum power allowed by FCC (Federal Communications Commission) and IC (Industry Canada). Actual operating range might vary according to environmental conditions at the time of use.
Voice Channels	Deskset, Cordless Handset, Cordless Headset: 5
Size	Cordless Handset: 6.9" × 1.8" × 1.4" (H × W × D) SB67020 Deskset: 6.9" × 7.9" × 8.1" (H × W × D @ 57° angle), 7.9" × 7.9" × 7.1" (H × W × D @ 41° angle) SB67030/031 Deskset: 8.2" × 8.9" × 6.5" (H × W × D) Gateways and ATA: 1.8" × 13.5" × 7.9" (H × W × D)
Weight	PSTN Gateway: 88.18 oz. (2500 g) (including adapter) T1 Gateway and SIP Gateway: 63.5 oz. (1800 g) (including adapter) ATA: 63.5 oz (1800 g) (including adapter) SB67020 Deskset: 35.59 oz. (1009 g) (including adapter) SB67030/031 Deskset: 59.96 oz. (1700 g) (including adapter) Cordless Handset: 7.05 oz. (200 g) (including battery)



Table 9. Technical Specifications (Continued)

Feature	Specification
Power Requirements	PSTN Gateway: 5.1 V DC @ 1700 mA T1 Gateway and ATA: 12 V @ 18 Watts SIP Gateway: 12 V @ approx. 13 Watts SB67020 and SB67030/031 Deskset: 5.1 V DC @ 1700 mA (AC Adapter) SB67020 Deskset: PoE Class 2 SB67031 Deskset: PoE Class 3 Cordless Handset, Cordless Headset chargers: 6 V DC @ 200 mA Cordless Handset: 2.4 V 550 mA Ni-MH battery Cordless Headset: 3.7 V 240 mAH battery
RJ-45 Ethernet Network Jack	(10Base-T/100Base-Tx) with auto MDI/MDIX switching
PSTN Gateway Telephone Jacks	1–4 and BYPASS (FXO ports) use traditional 2-conductor wiring
T1 Jack	RJ48C jack on the supplied T1 cable: Pin 1: R pair, RX-Ring Pin 2: T pair, RX-Tip Pin 4: R1 pair, TX-Ring Pin 5: T1 pair, TX-Tip
	
	Figure 52. T1 Jack Pinouts
Gateway BYPASS	26 mA loop current; REN 5; 100 m max loop length
LAN Cable	Cat.-5 standard cable, except the T1 Gateway, which uses a standard Cat.-6 LAN cable
[T1] T1 Port	RJ48C standard T1 interface The T1 Gateway provides ITU G.168 compliant hardware-based echo cancellation.
[ATA] FXS	26 mA loop current; REN 5; 100 m max loop length



Table 9. Technical Specifications (Continued)

Feature	Specification
[ATA] AUX In	3.5 mm Tip (Signal), Ring (NC) Sleeve (Ground) (TRS) jack Frequency range 300 to 3.4 KHz Input level -15 dBm nominal Impedance greater than or equal to 10 K ohms input AC coupling
[ATA] AUX Out	3.5 mm Tip (Signal), Ring (NC) Sleeve (Ground) (TRS) jack Frequency range 300 to 3.4 KHz Output level -15 dBm nominal Output impedance less than or equal to 8 ohms AC coupling
Deskset Headset	Traditional corded handset jack type with 2-conductor wiring

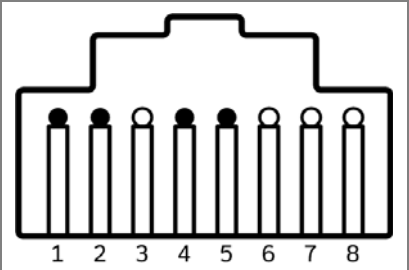

Appendix B: Default Settings

Table 10, Table 11, Table 12, and Table 13 list the default settings for the Synapse system, Deskset, SB67040 Cordless Handset, and SB67050 ATA.

Table 10. System Default Settings

Parameter	Selection	Default
Admin Password	4 through 6 digits	12345
Administrator Login Name	16 characters max	Admin
Auto Attendant Day Start	12-hour clock	8:00AM
Auto Attendant Digit Assignment (1–9, *, #)	None, Replay, Directory, Previous Menu, Main Menu, Default Menu, (user created)	None
Auto Attendant Enable Direct Dial	On, Off	On
Auto Attendant Enable Operator	On, Off	On
Auto Attendant Main Day, Night, and Lunch Menu	Default Menu, User Created Menu	Default Menu
Auto Attendant Night Start	12-hour clock	5:00PM
Backup/Restore Settings	All extensions	Nothing
Call Forward Unconditional	On, Off	Off
Call Forward Unconditional Target Type	Voicemail, Extension	Voicemail
Call Forward-No Answer	On, Off	On
Call Forward-No Answer Extension Number	200 through 299	Nothing
Call Forward-No Answer Seconds Before Forwarding	5 though 45	15
Call Forward-No Answer Target Type	Voicemail, Extension	Voicemail
Call Forward-No Answer Telephone Number	32 Digits Maximum	Nothing
Delete Extension	All extensions	Nothing
Directory First and Last Name Fields	20 Digits Maximum	Nothing
Directory Number Field	32 Digits Maximum	Nothing
Directory Sort	First Name, Last Name	First Name
Display First and Last Name	16 characters maximum	Nothing
Enable Auto Attendant	Scheduled, Manual, Off	Manual



Table 10. System Default Settings (Continued)

Parameter	Selection	Default
Hold message: Extension for Recording	All extensions	Nothing
Operator Extension	All extensions	200
Ring Group No Answer Target Extension	All extensions	0
Ring Group Seconds Before Forward	1 through 60 Seconds	15
System Time/Date Option	NTP Server, Custom Server, Manual	NTP Server
Timer for Forwarded and Transferred Outside Calls	15 through 120 (in 5-minute increments)	30
User Password	6 digits maximum	Nothing



Table 11. Deskset Default Settings

Parameter	Selection	Default
Backlight	Hi, Lo, Off	Hi
Call Forward All Target	Ext, Mailbox, Phone #	Mailbox
Call Forward–No Answer Delay	5 through 45 (in 5-second increments)	15
Call Forward–No Answer Target	Mailbox, Ext, Phone #, OFF	Mailbox
Call Forward/Trans to outside line	Enabled/Disabled	Enabled
Contrast	1 through 9	5
Current Greeting	Primary, Alternate, Pre-Set	Pre-Set
Current Name	Personal, Pre-Set	Pre-Set
Date and Time (when server is not available)		12:00PM, January 1, 2009
Directory List	All, Personal, System, Extension	All
First Name/Last Name toggle	First Name, Last Name	First Name
Handset	Registered, Not Registered	Not Registered
Headset	Registered, Not Registered	Not Registered
IP Configuration	Auto, Static	Auto
Key Beeps	On, Off	On
Preferred Audio Mode	Speakerphone, Headset	Speakerphone
Ring Volume	0 through 9	3
Ringtones	1 through 9	1
User Password	0 through 6 Digits	Nothing

Table 12. Cordless Handset Default Settings

Parameter	Selection	Default
Contrast	1 through 9	5
Key Beeps	On, Off	On
Ring Volume	0 though 9	3
Ringtones	1 though 9	1



Table 13. ATA Default Settings

Parameter	Selection	Default
AUX IN	Enable, Disable	Disable
AUX OUT	Enable, Disable	Disable
Fax Enable	Enable, Disable	Disable
Fax Mode	G.711, T.38	G.711
Fax Destination	FXS 1, FXS 2	None. "Select a Fax Port" appears
Fax Line	Line 1, 2, 3, 4, T1 DID numbers	None. "Select a Fax Line" appears
FXS 1	Voice, Fax, OHP	Voice
FXS 2	Voice, Fax, OHP	Voice
Group Mailbox Greeting	Pre-Set, Custom	Pre-Set
Group Mailbox Quota	Enable, Disable	Disable
IP Address	Auto (DHCP), Static	Auto (DHCP)
Music on Hold Port	AUX IN	None. "Select a Port" appears
Overhead Paging Delay	0 though 5	0
Overhead Paging Enable	Enable, Disable	Disable
Overhead Paging Port	FXS 1, FXS 2, AUX OUT	None. "Select a Port" appears
Overhead Paging System Type	Single Zone, Multi Zone	Single Zone



Appendix C: Part Lists

SB67010 PSTN Gateway Parts List

Figure 53 illustrates the PSTN Gateway parts.

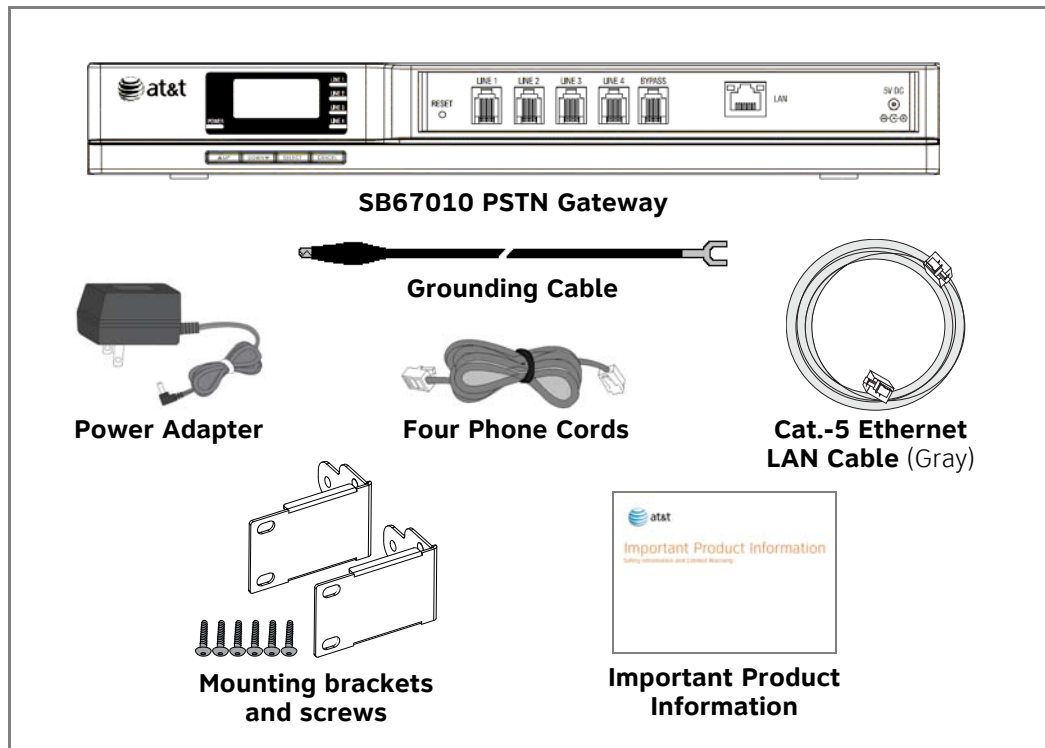

Figure 53. PSTN Gateway Parts List



SB67060 T1 Gateway Parts List

Figure 54 illustrates the T1 Gateway parts.

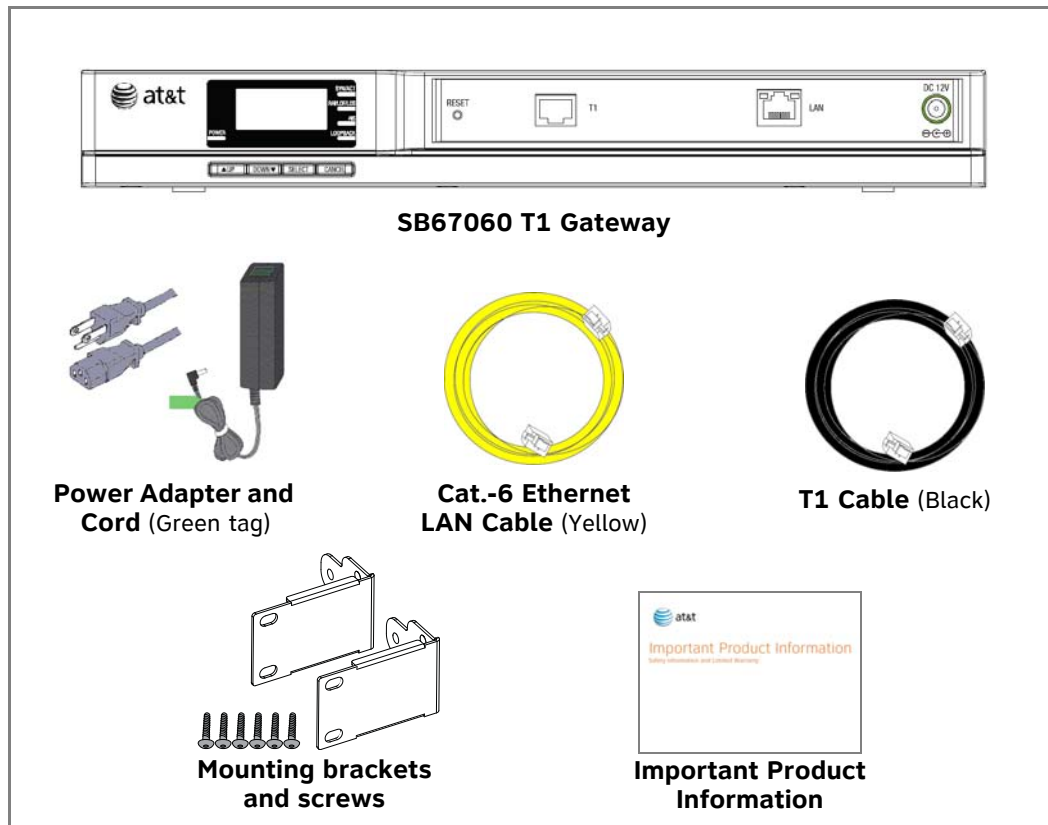

Figure 54. T1 Gateway Parts List



SB67070 SIP Gateway Parts List

Figure 55 illustrates the SIP Gateway parts.

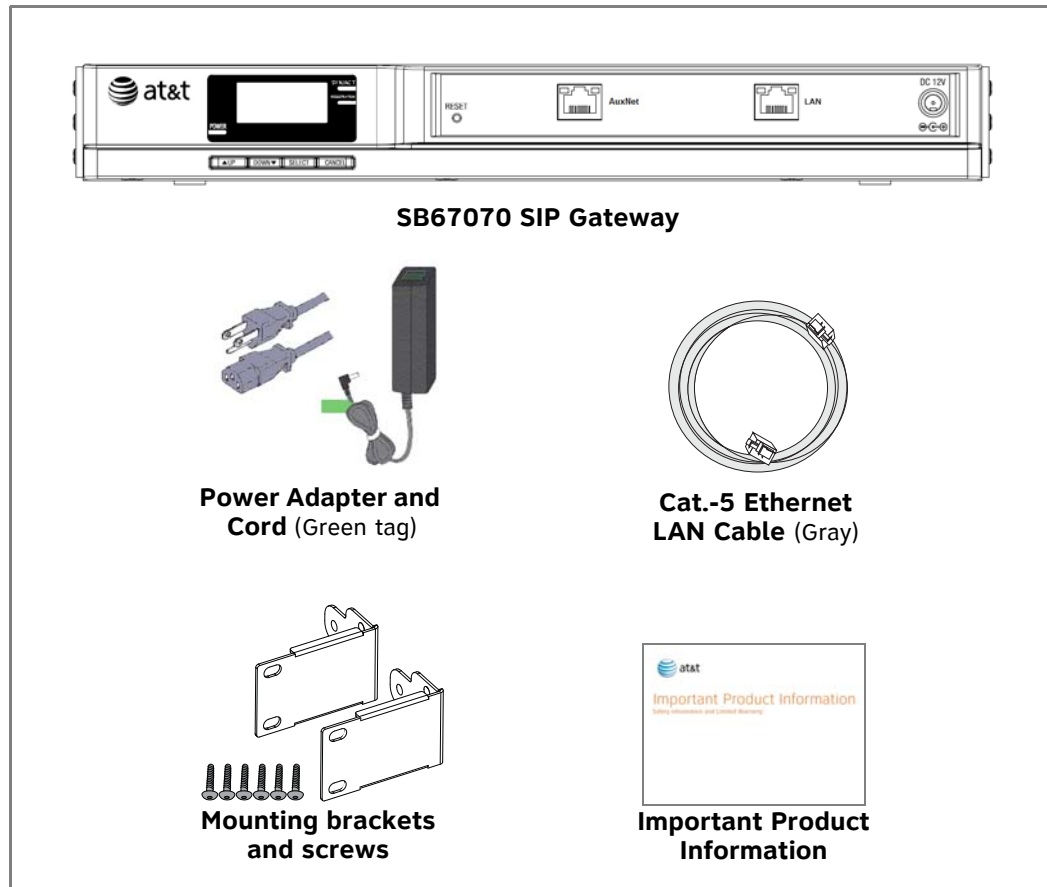

Figure 55. SIP Gateway Parts List



SB67050 Analog Terminal Adapter (ATA) Parts List

Figure 56 illustrates the ATA parts.

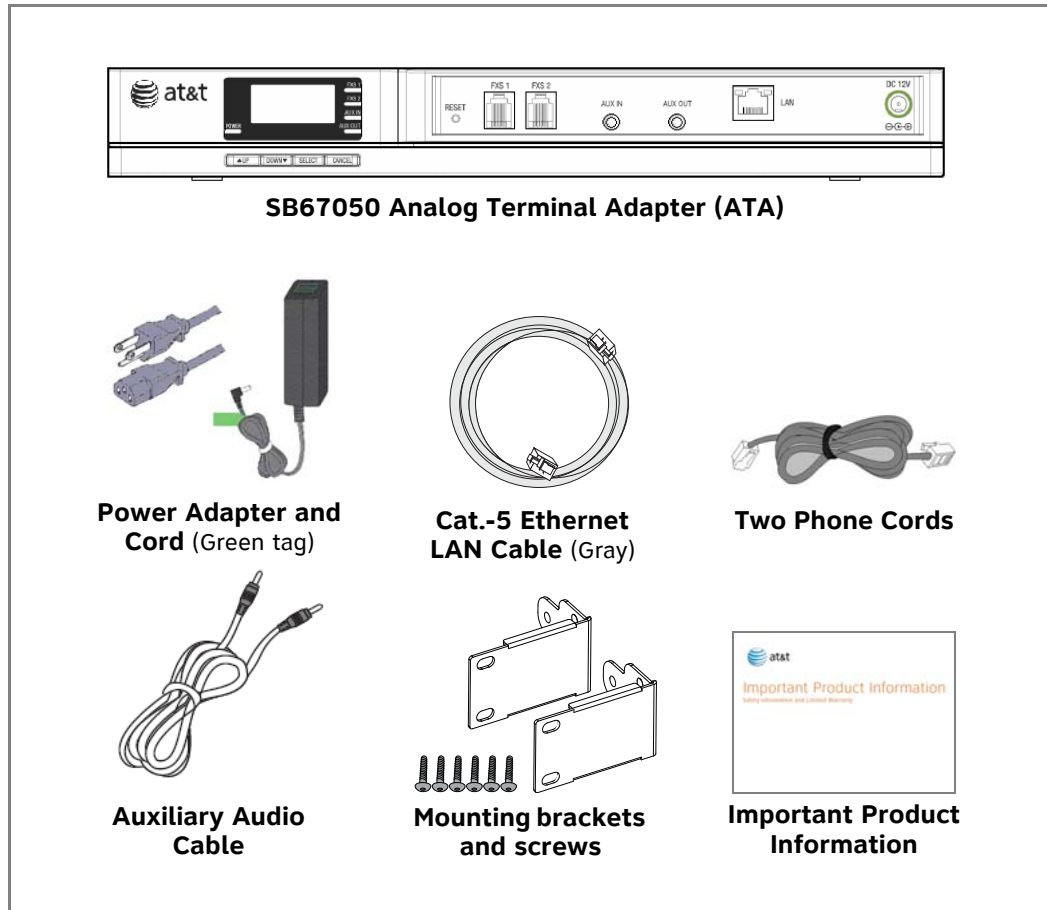

Figure 56. ATA Parts List



SB67020 Deskset Parts List

Figure 57 illustrates the Deskset parts.

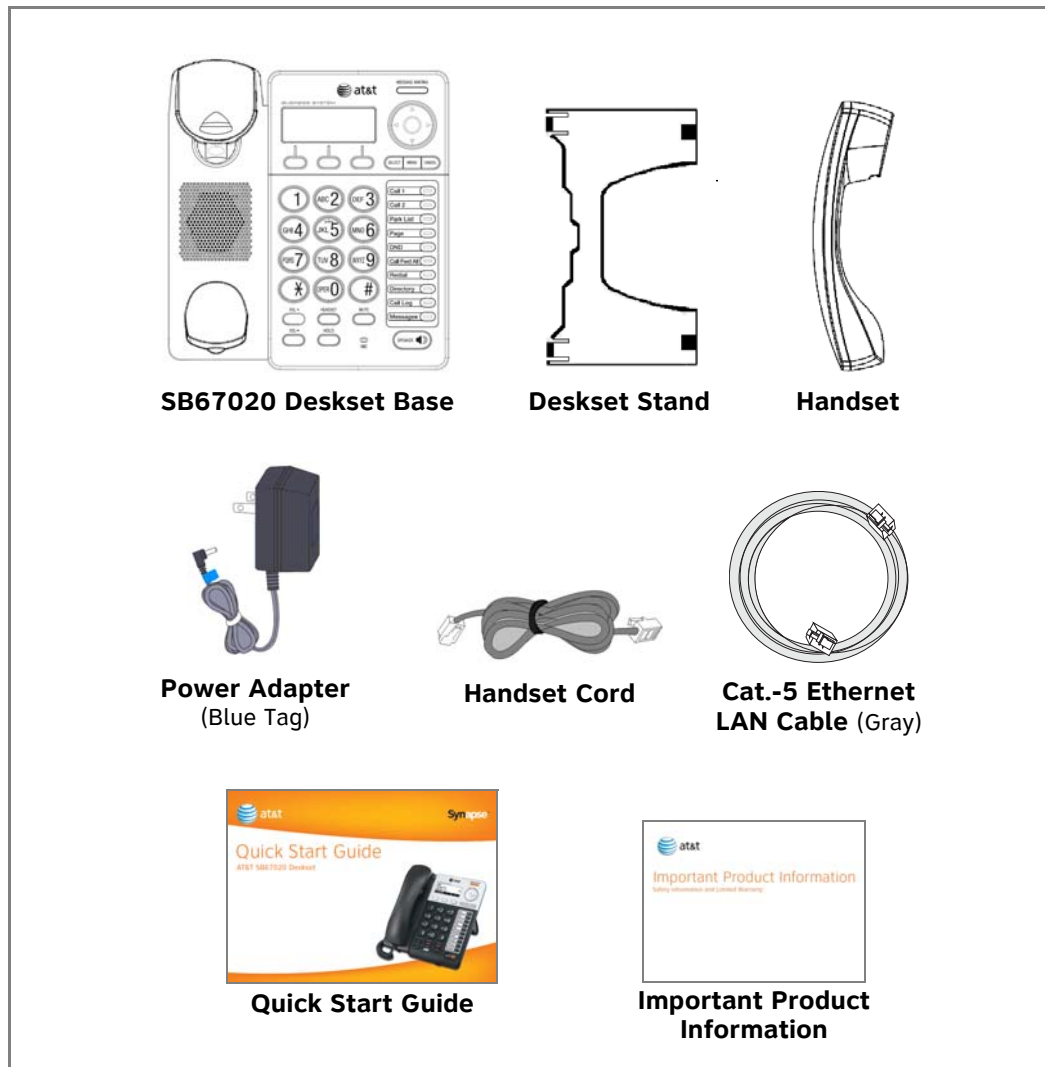

Figure 57. SB67020 Deskset Parts List



SB67030/031 Deskset Parts List

Figure 58 illustrates the Deskset parts.

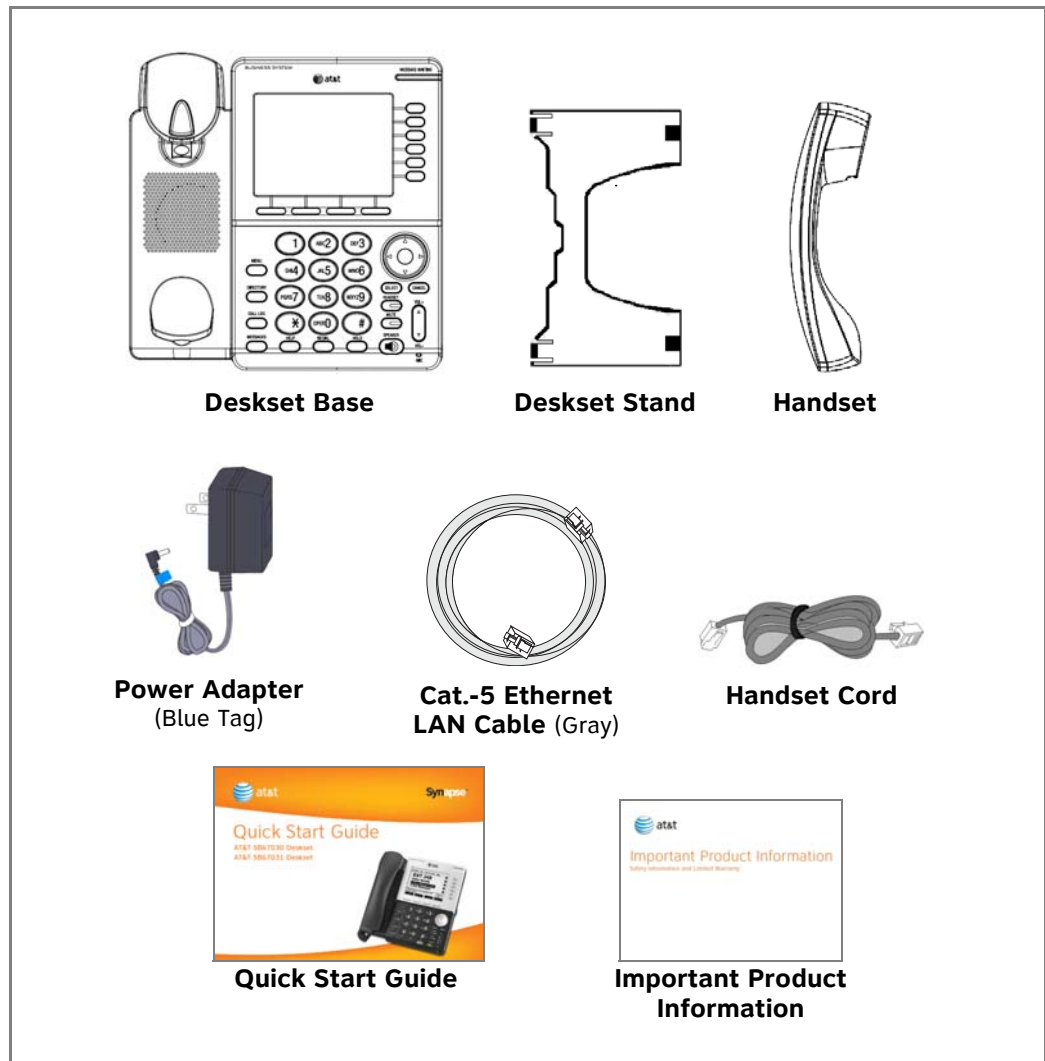

Figure 58. SB67030/031 Deskset Parts List



SB67040 Cordless Handset Parts List

Figure 59 illustrates the Cordless Handset parts.

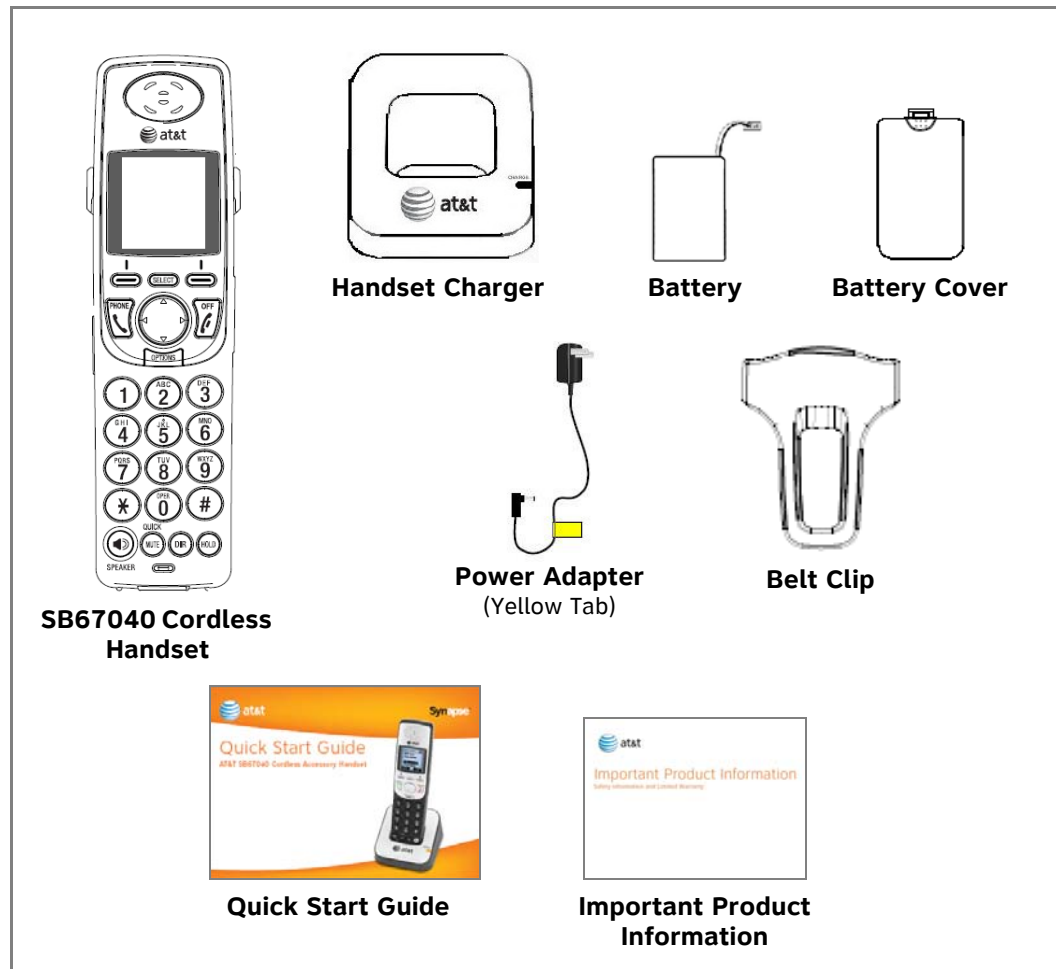

Figure 59. Cordless Handset Parts List



TL7600 Cordless Headset Parts List

Figure 60 illustrates the TL7600 Cordless Headset parts.

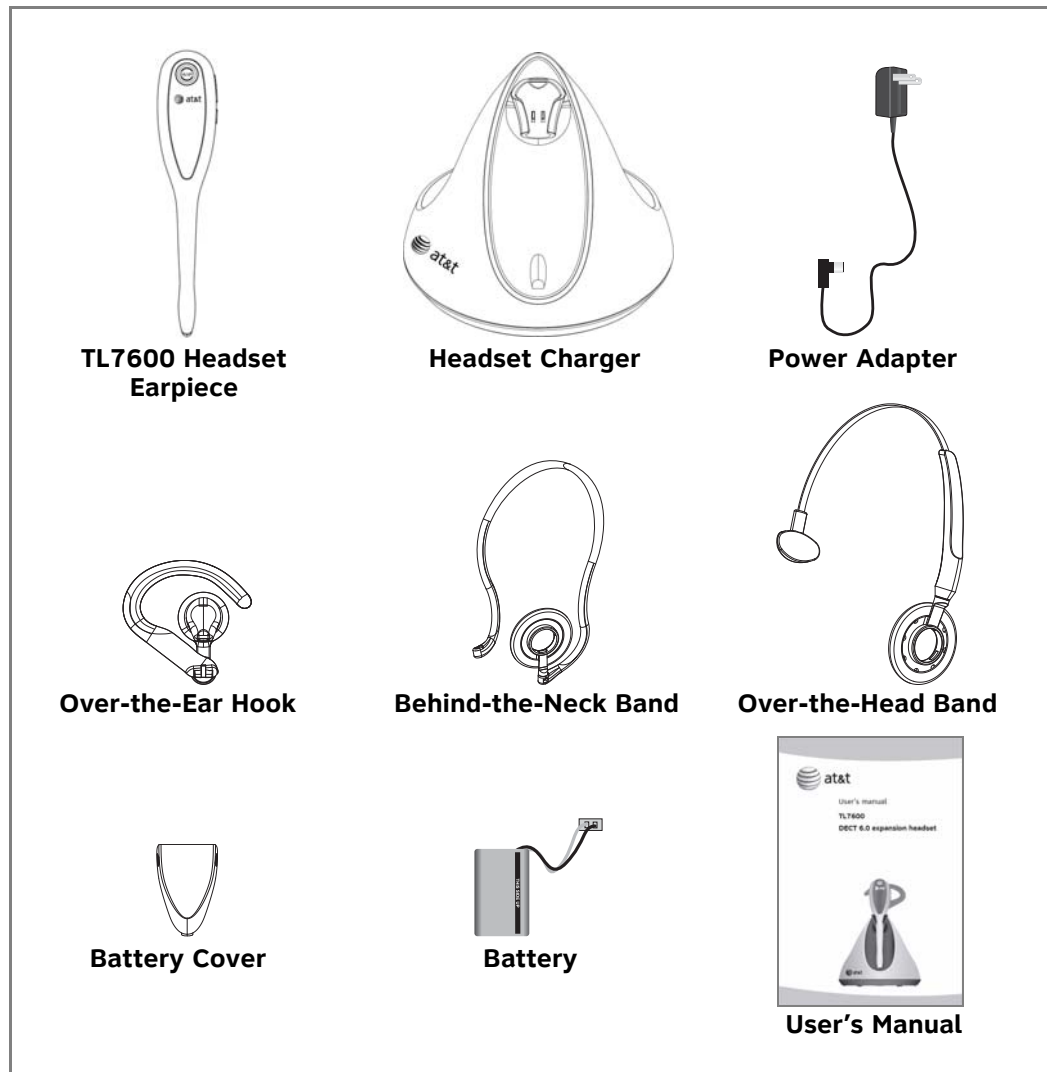

Figure 60. TL7600 Cordless Headset Parts List



The process for registering the TL7600 Cordless Headset with the SB67030/031 Deskset is different than the registration process described in the TL7600 User's manual that comes in the box with the Cordless Headset.



Use the registration process described in "Registering an Optional Cordless Headset" in the SB67030/031 Deskset and Accessories User's Guide at www.telephones.att.com/synapseguides.



Appendix D: Maintenance



CAUTION Your system contains sophisticated electronic parts, so it must be treated with care.

Avoid Rough Treatment

Handle the unit gently. Save the original packing materials to protect your equipment if you ever need to ship it.

Avoid Water

Your unit can be damaged if it gets wet. Do not use the equipment outdoors in the rain or handle it with wet hands. Do not install the equipment near a sink, bathtub, or shower.

Electrical Storms

Electrical storms can sometimes cause power surges harmful to electronic equipment. For your own safety, exercise caution when using electrical appliances during storms.

Cleaning Your Unit

Your unit has a durable plastic casing that should retain its luster for many years. Clean it only with a soft cloth slightly dampened with water or a mild soap solution. Do not use excess water or cleaning solvents of any kind.



Appendix E: Important Safety Instructions



This symbol alerts you to important operating or servicing instructions in this document. Always follow basic safety precautions when using this product to reduce the risk of injury, fire, or electric shock.

When using your telephone equipment, basic safety precautions should always be followed to reduce the risk of fire, electric shock, and injury, including the following:

- Read and understand all instructions.
- Follow all warnings and instructions marked on the product.
- Unplug this product from the wall outlet before cleaning. Do not use aerosol or liquid cleaners. Use a damp cloth for cleaning.
- Do not use this product near water (for example, near a bathtub, kitchen sink, or swimming pool).
- Do not place this product on an unstable surface.
- This product should be operated only from the type of power source indicated on the marking label. If you are not sure of the type of power supply in your home or office, consult your dealer or local power company.
- Do not allow anything to rest on the power cord. Do not install this product where the cord may be walked on.
- Never push objects of any kind into this product through the slots in the unit because they may touch dangerous voltage points or create a short circuit. Never spill liquid of any kind on the product.
- To reduce the risk of electric shock, do not disassemble this product; take it to an authorized service facility. Opening or removing parts of the unit other than specified access doors may expose you to dangerous voltages or other risks. Incorrect reassembling can cause electric shock when the product is subsequently used.
- Do not overload wall outlets and extension cords.
- The power adapter is intended to be correctly oriented in a vertical or floor mount position. The prongs are not designed to hold the plug in place if it is plugged into a ceiling or an under-the-table or cabinet outlet.

Unplug this product from the wall outlet and refer servicing to an authorized service facility under the following conditions:

- When the power supply cord or plug is damaged or frayed.
- If liquid has been spilled on the product.
- If the product has been exposed to rain or water.
- If the product does not operate normally when following the operating instructions. Adjust only those controls that are covered by the operating instructions. Improper adjustment of other controls may result in damage and often requires extensive work by an authorized technician to restore the product to normal operation.



- If the product has been dropped and the unit has been damaged.
- If the product exhibits a distinct change in performance.



GLOSSARY

This glossary provides definitions that pertain to the Synapse telephone system.

10/100 Ethernet Port: An Ethernet port that supports two different speeds of Ethernet on the same port. The two speeds supported are 10Base-T and 100Base-TX.

10Base-T/100Base-TX: An Ethernet network operating at up to 100 megabits per second

active call: An established telephone call that is not on hold

analog: A continuously variable signal

analog phone: A non-Synapse telephone that plugs directly into a normal telephone wall plug or into the Synapse PSTN Gateway BYPASS port or ATA FXS port

ATA (Analog Terminal Adapter): Allows the integration of non-Synapse analog telephones, a fax machine, overhead paging equipment, and a music-on-hold source into the Synapse system. It also provides Group Mailboxes to allow different people to access the same Mailbox.

Auto Answer: When the system is in Call Appearance mode, you can set the Deskset to automatically answer calls after a delay that you specify. Without touching the Deskset, you can speak to and be heard by people who call you.

Auto Attendant: A system that automatically answers incoming calls and provides instructions to callers

Auto-MDIX (Automatic Medium-Dependent Interface Crossover): A computer networking technology that automatically detects the required cable connection type (straight-through or crossover) and configures the connection appropriately

Aux In: A 3.5 mm jack on the ATA that allows connection to a streaming audio source, such as a radio or MP3 music player. This jack is typically used to connect a music player for Music on Hold.

Aux Out: A 3.5 mm jack on the ATA that can be used to connect some single-zone overhead paging devices.

Available (☎): An SB67030/031 Deskset screen icon that indicates that there is a Call Appearance key that is not busy with predialing, dialing, ringing, or an active or held call

BYPASS port: An RJ-11 jack on the PSTN Gateway that allows for communication during power outages. Plug an analog telephone into this jack.

Call Appearance: On the SB67020 Deskset, the Programmable Feature Keys identified as Call Appearance keys on the right side of the Deskset. On the SB67030/031 Deskset, the five icons on the right side of the Deskset display and the keys and LEDs associated with those icons. These keys access active and held calls, and calls that are being dialed or predialed. The LEDs and icons indicate the state of each call or potential call.

Call Forward All: Automatically forward calls before they ring. All calls are immediately forwarded to the specified destination.



Call Forward–No Answer: Automatically forward unanswered calls to Voicemail, an extension, or outside phone number

call screening: Listening to a Voicemail message while it is being recorded

Cat.-5 wiring: A twisted pair data cable commonly used in offices for computer communication

CO (Central Office): An office to which subscriber home and business lines are connected. The central office has switching equipment that can switch calls locally or to long-distance carrier phone offices.

CPT (Call Progress Tones): Audible tones sent from the telephone company central office to indicate the status of phone calls such as ringback and busy tones

CSU (Channel Service Unit): A line-bridging device that is part of the PSTN, that resides on the customer premises and is connected to Synapse, and is also used to perform loopback and other tests on T1 connections. This device is typically provided by the T1 phone service provider.

DECT (Digital Enhanced Cordless Telecommunication): A wireless telephone technology developed specifically for cordless telephones using frequencies between 1.8 and 1.9 Gigahertz. DECT communication is resistant to interference from other electronic equipment, has longer range, and improved battery life

default: The original product settings

deregister: To remove the association between an SB67030/031 Deskset and a Cordless Handset or Cordless Headset

DHCP (Dynamic Host Configuration Protocol): A network protocol that automatically assigns computer IP addresses

dial pad: The **0** through **9**, *****, and **#** keys on the Deskset and the SB67040 Cordless Handset

direct dial: Allows callers to directly dial users' extension numbers after the Auto Attendant answers

Directory: A list of names and phone numbers

Display Names: The names that the system administrator enters to identify each extension number. The Auto Attendant uses these names to assist callers in forwarding calls.

DID: This feature allows outside caller to directly dial an extension, bypassing the Auto Attendant and the operator

DND (Do Not Disturb): A feature that suppresses audible ringing and incoming paging at the Deskset

DND ON (DND ON): An indicator in the top right corner of the Deskset display that illuminates when you turn on the Do Not Disturb feature

DNS (Domain Name System) server: A server that stores the Domain Name System records, such as address, name server, and mail exchanger records for a domain name and responds with answers to queries against its database



DSL (Digital Subscriber Line): High-speed Internet service through your telephone line. Telephone lines with DSL service require DSL filters to separate the telephone and data signals.

DTMF (Dual-Tone Multi-Frequency): Telephone tones commonly known as “touch-tone”

dynamic IP address: An IP address that is automatically assigned by the server

Emergency Bypass Port: The fifth SB67010 PSTN Gateway jack that can provide telephone operation during a power failure when used with an analog phone

ESD (Electrostatic Discharge): A sudden and momentary electric current that flows between two objects at different electrical potentials that may cause damage to electronic equipment

ESF (Extended Super Frame): A telecommunication standard for T1 framing that includes a cyclic redundancy check and a 4000 bit/s channel capacity for the data link channel

Ethernet: A type of computer networking technology that connects devices via Local Area Networks (LANs)

Extension Directory: A private list of names and phone numbers available to only a single extension (referred to as “Personal list” on the Deskset)

Extension list: A list of names and extension numbers for the Synapse system telephones

extension number: The three-digit or four-digit number representing each individual Deskset

factory default: The original product settings

FDL (Facility Data Link): A 4-kbps channel provided by the Extended Super Frame (ESF) T1 framing format that allows a service provider to check error statistics on customer premises equipment without interfering with the customer premises

flash memory: Reprogrammable system storage used for storing software upgrades

FWD ON (FWD ON): An indicator in the top right corner of the Deskset display that appears when the Call Forward feature has been turned on. This feature causes calls to that extension number to be automatically forwarded to another extension, outside phone number, or to Voicemail.

FXO (Foreign Exchange Office): The Gateway telephone signaling interface between the PSTN telephone lines and the LAN

FXS station port: A jack on the ATA for connecting non-Synapse analog telephone equipment to the Synapse system

G.711: A digital fax protocol

Gateway: A network device equipped for interfacing with another network that uses different protocols

greeting, preset: The voice message that plays to callers if the user has not recorded an outgoing message

grounding: An electrical ground connection that minimizes interference, reduces the risk of equipment damage due to lightning, eliminates electrostatic buildup, and helps protect people who service the equipment



Group Mailbox: Provide general delivery of Voicemail messages to a group within an organization. Only subscribers can access these Voicemail messages.

hard key: Any physical key on the Deskset, Cordless Handset or Gateway. Examples include **MENU** and **1** on an SB67020 Deskset; **PHONE** and **1** on the SB67040 Handset; and **SELECT** and **CANCEL** on the SB67010 Gateway.

hard reset: An action that restores factory default settings

Hold announcement: A recorded message to play while calls are on hold. It can be combined with music on hold.

hub: A network hub or repeater hub is a device for connecting electronic devices, making them act as a single link

hunt group: A telephone company feature that allows calls to a busy phone number to roll over to the next available line or a Synapse system Ring Group feature where unanswered calls are forwarded to the next available extension in a predefined group of extensions

icon: A small picture in the display that presents status information

Idle: The mode of a device when it is not involved in call or call setup activity

interference: Electrical signals close by that cause degraded audio performance for cordless devices

internal call: A phone call placed from one of your Synapse system extensions to another extension

IP address (Internet Protocol address): An individual numeric identification assigned to devices on your LAN

ISDN (Integrated Services Digital Network): A set of communication standards for simultaneous digital transmission of voice, video, data, and other network services over the traditional circuits of the public switched telephone network.

IT Controller: Part of a computer network infrastructure that connects different parts of the network, so that different LANs and subnets can exchange information. Also known as a backbone network or a network backbone.

key beep: When enabled, pressing a key plays a tone

LAN (Local Area Network): A communications network that allows data devices to communicate with each other

LCD (Liquid Crystal Display): The screen that provides instructions and feedback

LED (Light Emitting Diode): A small light on a device that indicates status

link loss: Occurs when the connection between two RF devices fail, such as between the SB67030/031 Deskset and the optional Cordless Headset or Cordless Handset

link-local address: A local address used for network address creation when no external source of network addressing information is available

live dial: Dialing after the phone is off hook

MAC address (Media Access Control address): A unique identifier assigned to most network adapters or network interface cards that is required for registering your devices



main menu, Auto Attendant: The Auto Attendant messages and actions that are available to callers before the callers take additional actions

MDI/MDIX: (Medium-Dependent Interface Crossover): A computer networking technology

MoH (Music on Hold): Music or other audio that plays to an outside caller that has been placed on hold by a Synapse user

multi-zone paging: Paging through a multi-zone overhead paging system. The overhead loudspeakers are configured in multiple areas and transmit messages independently.

mute: Stop sending your voice to the other party during a phone call

NTP (Network Time Protocol): An Internet standard protocol that assures time synchronization in a computer network

Network Termination Unit (NTU): A device that terminates a network access point

octet: Octets are used in Internet Protocol computer network addresses. These consist of a series of four octets, usually shown in decimal and separated by dots.

off hook: Indicates that you are on a phone call, have lifted the corded handset, or have pressed **SPEAKER** or **HEADSET** to answer a call or to prepare to place a call. You are off hook from the moment that you hear a dial tone to when you hang up a call.

OHP (overhead paging) system: An amplified public address system

on hook: Indicates that no corded handset, speakerphone, Cordless Handset, or corded or Cordless Headset is active

operator: The extension that callers reach by dialing **0** (zero) when the Auto Attendant operator feature is enabled or that system users reach at any time by dialing **0** (zero)

outside call: A phone call between a phone not a part of your Synapse system and an extension within your Synapse system

P2P (Peer-to-Peer): A telecommunication system architecture in which some resources associated with a device are directly available to other similar system devices

page: Broadcasts your voice to all idle extensions that do not have Do Not Disturb turned on

page caching: Most web browsers store recently obtained web site data on a local hard drive. The browser then only asks for data that has changed since the last download. Caching helps reduce the amount of traffic on the Internet.

paging zone: A set of extensions that can be paged as a group

park: A form of hold that allows held calls to be retrieved by any Deskset or the SB67040 Cordless Handset

Park list: The list of unretrieved parked calls

pass code: Another term for password

Personal list: A private list of names and phone numbers available to only a single extension (referred to as "Extension Directory" on the WebUI)

Pilot Number: Usually the company's main telephone number



POTS (Plain Old Telephone Service): Basic telephone operation. The ability to make and receive phone calls.

predial: Enter digits before going off hook to place a call

PRI (Primary Rate Interface): A standardized telecommunications service level within the ISDN specification for carrying multiple voice and data transmissions between a telephone network and a user.

PSTN (Public Switched Telephone Network): The world's telephone network

Quick Dial: Provides two-touch dialing for frequently called phone numbers

quota: The maximum recording time for a Group Mailbox

reboot: Restart a device

Redial: Accesses the log of outgoing calls

Remote site: A Synapse site in another location that is linked to your office through a SIP Gateway. You can call remote Desksets by dialing their extension number. You can also make long-distance calls through a remote site as if you were dialing a local call. Depending on your system configuration, you may need to dial a prefix such as 9 to make Remote Site calls. Consult your system administrator.

RF (radio frequency): The communication channel for most Cordless Handsets and Cordless Headsets

Ring Group: Groups of extensions configured by the system administrator to all ring in a predetermined pattern within the group when calls come in for that group

router: An electronic device that connects two or more other electronic devices to each other, allowing them to communicate

single-zone paging: Paging to a single set of overhead loudspeakers. All speakers transmit the same announcement simultaneously.

SIP: Session Initiation Protocol, a signaling protocol used for voice and video communications over the Internet

soft key: The Synapse Desksets and Cordless Handsets feature keys below the LCD screen. The bottom of the LCD displays the appropriate label for each key as the function of the key changes.

standby time: The amount of time that a Cordless Handset or Cordless Headset can sit idle out of its charger while still capable of operating normally

static IP address: An IP address that is manually assigned to a computer by a system administrator. This type of addressing requires specific knowledge of the LAN.

subnet (subnetwork): Typically a LAN served by one router

subscriber: A user who can access messages in a Group Mailbox

supervised transfer: Occurs when you communicate with the transfer recipient before completing a transferred call

switch: A network switch links electronic devices. The switch processes and routes data flexibly, allowing more data to be handled without error.



system administrator: A person to perform functions such as setting up and modifying system configurations. This system administrator can be an employee or your telephone equipment provider.

System Directory: (see System list)

System list: This list of names and phone numbers is created and maintained by the system administrator. All system users can sort and view this list.

system operator: The extension that callers reach by dialing **0** (zero) when the Auto Attendant operator feature is enabled or that system users reach at any time by dialing **0** (zero)

T1: A digital signaling standard to transmit voice and data between devices

T.38: An analog fax protocol that encodes fax-modem codes over VoIP

trunk: A communications connection between the Synapse system and the telephone company

unsupervised transfer: Occurs when you do not communicate with the transfer recipient when transferring calls. The transfer recipient does not have to pick up the phone and talk to you before receiving the transferred call.

UPS (Uninterruptible Power Supply): A battery-powered emergency power supply device

URL (Uniform Resource Locator): An Internet address

VoIP (Voice over Internet Protocol): A transmission technology for delivery of voice communications over IP networks such as the Internet or other packet-switched networks. Other synonymous terms include IP telephony, Internet telephony, Voice Over BroadBand (VoBB), broadband telephony, and broadband phone.

WebUI (Web User Interface): A means of interacting with a product using a computer interface. Connection to the World Wide Web is not necessary.

