



at&t

User's manual

MS2085 4-Line

Small Business Main Console



Congratulations

on your purchase of this AT&T product. Before using this AT&T product, please read the **Important safety information** on pages 109-110 of this manual. Please thoroughly read this user's manual for all the feature operations and troubleshooting information necessary to install and operate your new AT&T product. You can also visit our website at **www.telephones.att.com** or call **1 (800) 222-3111**. In Canada, dial **1 (866) 288-4268**.

Model number: MS2085
Type: 4-Line Small Business Main Console
Serial number: _____
Purchase date: _____
Place of purchase: _____

Both the model and serial numbers of your AT&T product can be found on the bottom of the console.

Save your sales receipt and original packaging in case it is necessary to return your telephone for warranty service.



Telephones identified with this logo have reduced noise and interference when used with most T-coil equipped hearing aids and cochlear implants. The TIA-1083 Compliant Logo is a trademark of the Telecommunications Industry Association. Used under license.

Message Guard® is a registered trademark of Advanced American Telephones.

© 2012 Advanced American Telephones. All Rights Reserved. AT&T and the AT&T logo are trademarks of AT&T Intellectual Property licensed to Advanced American Telephones, San Antonio, TX 78219. Printed in China.

Parts checklist

Your telephone package contains the following items. Save your sales receipt and original packaging in the event warranty service is necessary

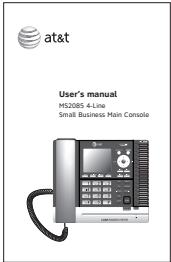

User's manual

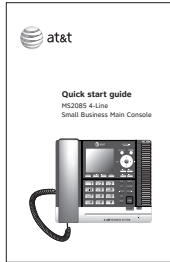

Quick start guide



Console power adapter



Handset with coiled cord installed



Console

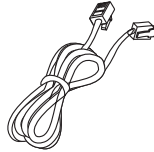

Ethernet cable

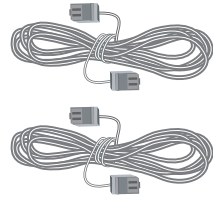

Two gray telephone line cords (2-conductor)



Two black telephone line cords (4-conductor)



Wall mount bracket



Replacement directory card

MS2085 4-Line Small Business Main Console



Table of contents

Getting started

Quick reference guide	1
Introduction.....	4
Planning your system.....	5
Installation.....	6
Console installation	7
Console installation (set static IP).....	12
Console installation (stand-alone telephone).....	13
Wall mount installation.....	14
To mount the console on the wall.....	14
Wall mount to tabletop installation.....	18
PC jack.....	19
Adding and registering desksets.....	20
To register a deskset to your MS2085 console	20
Adding and registering a cordless headset.....	21
To register a TL7600 cordless headset to your MS2085 console	21
Deregistering a cordless headset	22
To deregister the cordless headset from the MS2085 console	22
Adding a corded headset.....	23
To add a corded headset to the console	23
System setup.....	24

Menu settings.....	24
Set extension number	24
Release extension number	25
Prime line	26
Line group.....	27
Network setup	28
Network info	31

Telephone settings

Telephone setup.....	32
Ringer volume.....	32
Ringer tone.....	33
Set date/time	34
LCD language	35
Home area code.....	36
Key tone.....	37
LCD contrast	37
Dial mode.....	38
Hold reminder	38
Phone rename.....	39
Set default.....	39
Customer support	40

Telephone operation

Telephone operation.....	41
Line indicators.....	41
Making and ending a call.....	41
On hook dialing (predialing)	42
Full duplex speakerphone.....	42

Answering a call	42	One touch	57
Temporary ringer silencing.....	42	Assign a one-touch entry.....	57
Options while on calls.....	43	Review the one-touch entry.....	59
Call waiting.....	43	To dial a one-touch entry	59
Volume control.....	43	Edit the one-touch key.....	59
Mute	43	Delete an one-touch key.....	60
Temporary tone dialing	43		
Hold.....	44	Directory	
Switching between lines.....	44	About the directory.....	61
Call privacy.....	45	Capacity	61
Recording a call.....	46	Exit the directory.....	61
Chain dialing.....	47	Create directory entries.....	62
Redial.....	48	Create a new directory entry	62
To view the 10 most recently		Review directory entries.....	63
dialed numbers.....	48	Search directory.....	64
To redial a number	48	Search by name	64
To copy a redial entry to		Dial, delete or edit entries.....	65
directory.....	48	Display dial.....	65
To copy a redial entry to		Delete an entry.....	65
one-touch memory.....	49	Edit an entry	66
To delete a number.....	49	Copy a directory entry to	
Auto-redial.....	50	one touch.....	67
Conference call.....	51		
A. Inviting parties using		Caller ID	
Intercom.....	51	About the caller ID.....	68
B. Join a call in progress.....	52	Information about caller ID with	
Call scenario	53	call waiting.....	68
Intercom.....	54	Caller ID information.....	69
Make an intercom call to an		How the caller ID information	
extension.....	54	(call log) works.....	69
Answer an intercom call.....	54	Caller ID operation.....	70
End an intercom call.....	54	Memory match.....	70
Answer an incoming call during		Missed (new) calls indicator.....	70
an intercom call.....	54	Review the caller ID information..	70
Call transfer	55	View dialing options.....	71
Blind transfer.....	55	Dial a call history entry.....	71
Call transfer using intercom.....	56	Save a caller ID entry to the	
Transfer a call and speak to the		directory.....	72
receiving party.....	56	Copy a caller ID entry to	
		one touch.....	73

Delete entries.....	73
Reasons for missing caller ID information.....	74

Answering system

About the answering system.....	75
Answering system capacity.....	75
Message Guard®	75
Auto attendant setup.....	76
Auto attendant on/off	76
Auto attendant delay	76
Announcement	77
Record the auto attendant announcement.....	78
Set the start and end time of auto attendant announcement	79
Play the auto attendant announcement.....	80
Reset the auto attendant announcement.....	80
Reset auto attendant.....	81
Private mailbox setup	82
Private mailbox on/off.....	82
Private mailbox delay.....	82
Announcement	83
Call intercept.....	85
Answering system setup.....	86
Remote access code.....	86
Message alert.....	86
Message Length	87
Call screening.....	87
Recording time	88
Auto attendant operation	89
Using the auto attendant	89
Auto attendant (AA) flow chart.....	90
Answering system operation.....	91
New message indication.....	91
Call screening.....	91
Call intercept.....	91

Message playback.....	91
Options during playback.....	92
Delete all central mailbox messages.....	92
Delete all private mailbox messages.....	93
Record memo	93
Remote access.....	94

Appendix

Console screen icons	96
Alert tones and lights	97
Alert tones	97
Lights	97
Troubleshooting.....	98
Console display screen messages.....	105
Maintenance.....	108
Important safety information	109
FCC part 68 and ACTA.....	111
FCC part 15.....	112
Limited warranty.....	113
Technical specifications	115

Index

Index.....	116
------------	-----

Quick reference guide

CALL HISTORY

- Press to view caller ID information (page 70).

MENU/SELECT

- Press to enter the menu.
- While in the menu, press to select an item or save an entry or setting.

MESSAGE WAITING indicator

- Flashes when there are new messages in the central mailbox or private mailbox (page 91).

ANS SYS

- Press to enter the answering system setup menu.

LINE 1-LINE 4 keys

- Press to make or answer a call on the desired line (pages 41-42).

CANCEL

- While in a menu, press to cancel an operation and exit the menu display.

DIRECTORY

- Press to view directory information (page 63).

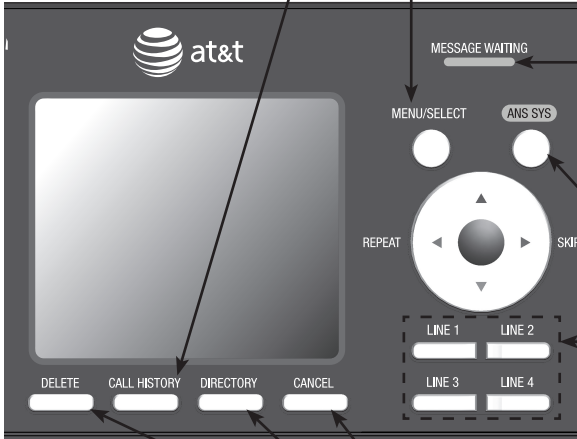

DELETE

- While playing a message, press to delete the message (page 92).
- While reviewing the caller ID information, press to delete an individual entry (page 73).
- While predialing, press to delete digits (page 42).

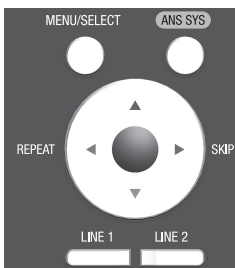

Navigation keys

- While in menus, press ▲ or ▼ to scroll through the menus, highlight items or change settings. Press ►/SKIP to enter the highlighted item, or press ◀/REPEAT to return to the previous menu.
- While entering names or numbers, press ◀/REPEAT or ►/SKIP to move the cursor to the left or right.
- While playing back messages, press ◀/REPEAT to repeat the message, or press ►/SKIP to skip to the next message.

Quick reference guide



One-touch keys

- Press to dial the desired one-touch number (page 59).

Directory card

To write names on the directory card, follow the steps below:

1. Pull out the directory card.
2. Write the information on the directory card.
3. Replace the directory card under the plastic cover.

SPEAKER

- Press to turn on the speakerphone. Press again to turn it off (page 42).

MIC

FLASH

- During a call, press to answer an incoming call when you receive a call waiting alert (page 43).

HOLD

- Press to place an outside call on hold (page 44).

INTERCOM

- When in idle mode, press to initiate an intercom call (page 54).

MUTE

- During a call, press to mute the microphone (page 43).

HEADSET

- When a corded headset is connected to the console, press to make, answer or hang up a call (page 42).

TRANSFER

- Press to transfer a call to an extension (pages 55 and 56).

CONFERENCE

- Press to add another extension or outside line to an existing call (pages 51-53).

AUTO REDIAL

- Press to view the last 10 numbers dialed (page 48 and page 50).

▲/VOLUME/▼

- During a call, press to adjust the listening volume (page 43).
- During message playback, press to adjust the playback volume (page 92).
- Press to adjust the ringer volume when in idle mode (page 32).

LOWER

- When assigning or dialing a one-touch number, press to switch to the lower location (the second 16 locations) of a one-touch key (pages 57-60).

Quick reference guide

Main menu

The > symbol highlights a menu item.

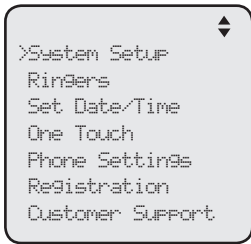

Main menu

- System Setup (pages 24-31)
- Ringers (pages 32-33)
- Set Date/Time (page 34)
- One Touch (pages 57-60)
- Phone Settings (pages 35-39)
- Registration (pages 20-22)
- Customer Support (page 40)

Using menus

- Press **MENU/SELECT** to show the main menu.
- Press **▲** or **▼** to scroll through menu items.
- Press **MENU/SELECT** or press **▶/SKIP** to select a highlighted menu item.
- Press **MENU/SELECT** to save changes.
- Press **CANCEL** to cancel an operation, exit the menu display or return to the idle screen.

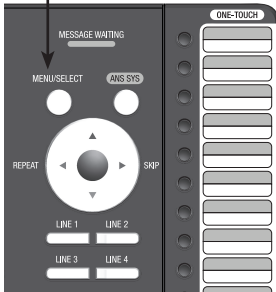

Introduction

This AT&T MS2085 is the console of a 4-line telephone system. It is expandable to a maximum of 15 AT&T MS2015 desksets and an AT&T TL7600 cordless headset. Expanding your system requires you to register each new device first (see pages 20-21). This system is not compatible with any other AT&T 4-line small business telephones, except for the MS2015 telephone.

The MS2085 telephone is hearing-aid compatible and can be connected to four telephone lines. This telephone features a speakerphone for handsfree use and a headset jack compatible with most headsets using two-band 2.5mm headset plugs (sold separately).

There are two network jacks, known as the Ethernet jack and PC jack, at the back of the console. The Ethernet jack allows the MS2085 telephone to connect with MS2015 desksets via a router. The PC jack is for another device such as a personal computer to connect to the Ethernet network through the console.

The MS2085 console supports intercom and call transfers between system extensions and is capable of connecting five parties on the same conference call.

This telephone also features a 32-number one- and two-touch memory for faster dialing and has a directory that can store up to 50 additional numbers with names. This telephone has a caller ID feature that supports caller ID with call waiting service. Caller ID services are subscriber services available from many telephone service providers for a fee. The telephone can store up to 200 caller ID entries.

Your MS2085 console also features a built-in digital answering system with a central mailbox and private mailbox. This MS2085 telephone is equipped to function as an auto attendant in a multi-telephone system. An auto attendant telephone can pick up and redirect incoming calls to other extensions in your telephone system. For details, see the **Auto attendant operation** section (pages 89-90). This user's manual contains detailed instructions for using your MS2085 console. Please read this user's manual before using this telephone.

Planning your system

The MS2085 package includes only the console. You have to purchase MS2015 deskset/TL7600 cordless headset separately to expand your system.

To order them, visit our website at **www.telephones.att.com** or call **1 (800) 222-3111**. In Canada, dial **1 (866) 288-4268**.

You must install and setup the MS2085 console first before expanding your system with MS2015 deskset/TL7600 cordless headset. Make sure your router has enough slots to accommodate all desksets.

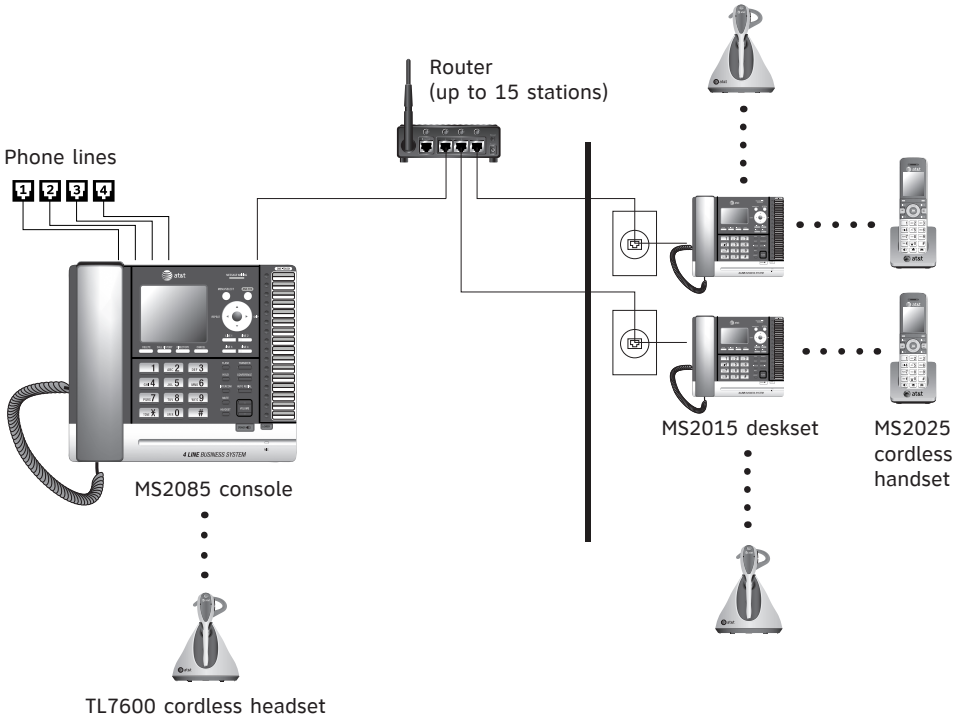

NOTES:

- You can register only one AT&T TL7600 cordless headset to the MS2085 console or an MS2015 deskset. The system allows a maximum of one console and four desksets, or five desksets to have cordless accessories. When the console or a deskset has cordless accessories, they are all part of the same extension, and only one extension device can be used at a time.
- You must have modular telephone jacks and electrical outlet not controlled by wall switch near where you install the console.
- The auto attendant function is available only on the MS2085 console.
- Every individual phone in your telephone system MUST be assigned a unique extension number for the intercom feature to work. See **Set extension number** on page 24.
- You must have a router with DHCP enabled for your system. This console does not assign any IP to the system deskset.
- This telephone system does not support other telephones connected to the same telephone lines for use.

Installation

Install the console close to the telephone jacks, a router and a power outlet not controlled by a wall switch. The telephone can be placed on a flat surface or vertically mounted on the wall (pages 14-18). For optimum range and better reception, place the console in a central and open location.

If you subscribe to high-speed Internet service (DSL - digital subscriber line) through your telephone lines, you must install DSL filters between the telephone line cords and the telephone wall jacks (see page 9 or 10). The filter prevents noise and caller ID problems caused by DSL interference. Please contact your DSL service provider for more information about DSL filters.

Your product may be shipped with a protective sticker covering the console display - remove it before use.

For customer service or product information, visit our website at **www.telephones.att.com** or call **1 (800) 222-3111**. In Canada, dial **1 (866) 288-4268**.

Avoid placing the console too close to:

- Communication devices such as television sets, VCRs, or other cordless telephones.
- Excessive heat sources.
- Noise sources such as a window with traffic outside, motors, microwave ovens, refrigerators, or fluorescent lighting.
- Excessive dust sources such as a workshop or garage.
- Excessive moisture.
- Extremely low temperature.
- Mechanical vibration or shock such as on top of a washing machine or work bench.

Console installation



Make sure you plug in all telephone lines and the Ethernet cable before powering up the console.

1. Plug the end of the coiled handset cord into the  jack on the left side of the telephone.



2. Lift the kickstand as the arrows indicate below to release it from the groove. There are seven pairs of grooves designed to hold the console at different angles for optimum visibility.

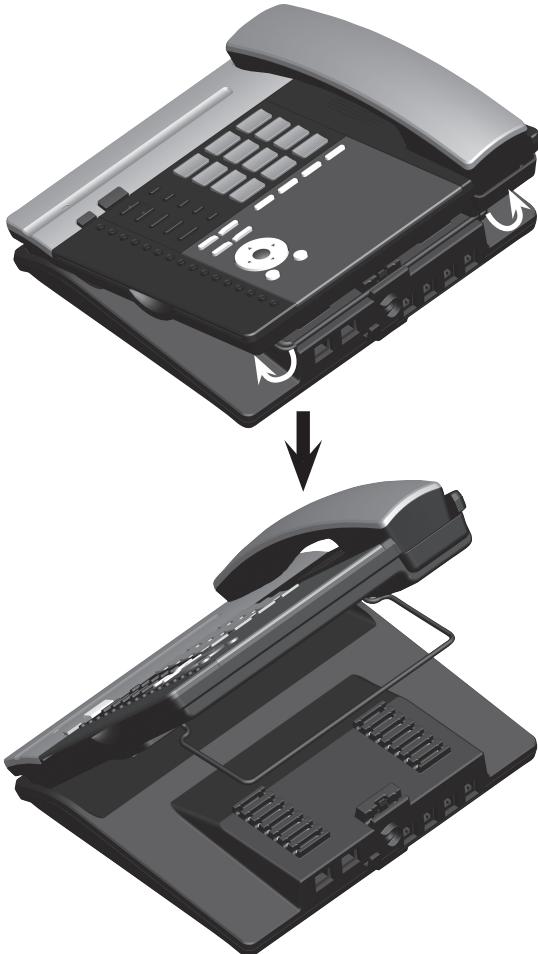

Console installation

3. Snap the kickstand into the desired grooves until it locks into place.



4. Install the telephone lines. Plug one end of the telephone line into the telephone jack at the back of the console. Plug the other end of the telephone line into the telephone wall jack. If you subscribe to high-speed Internet service (DSL - digital subscriber line) through your telephone lines, you must install a DSL filter between the telephone line cord and telephone wall jack. The filter prevents noise and caller ID problems caused by DSL interference. Please contact your DSL service provider for more information about DSL filters.
5. Make sure your router is connected to the Ethernet network. Plug one end of the Ethernet cable into the Ethernet jack (랜선) at the back of the console, and plug the other end into the router.
6. Plug the power adapter into an electrical outlet not controlled by a wall switch.

Console installation

Option 1: To connect four single line wall jacks

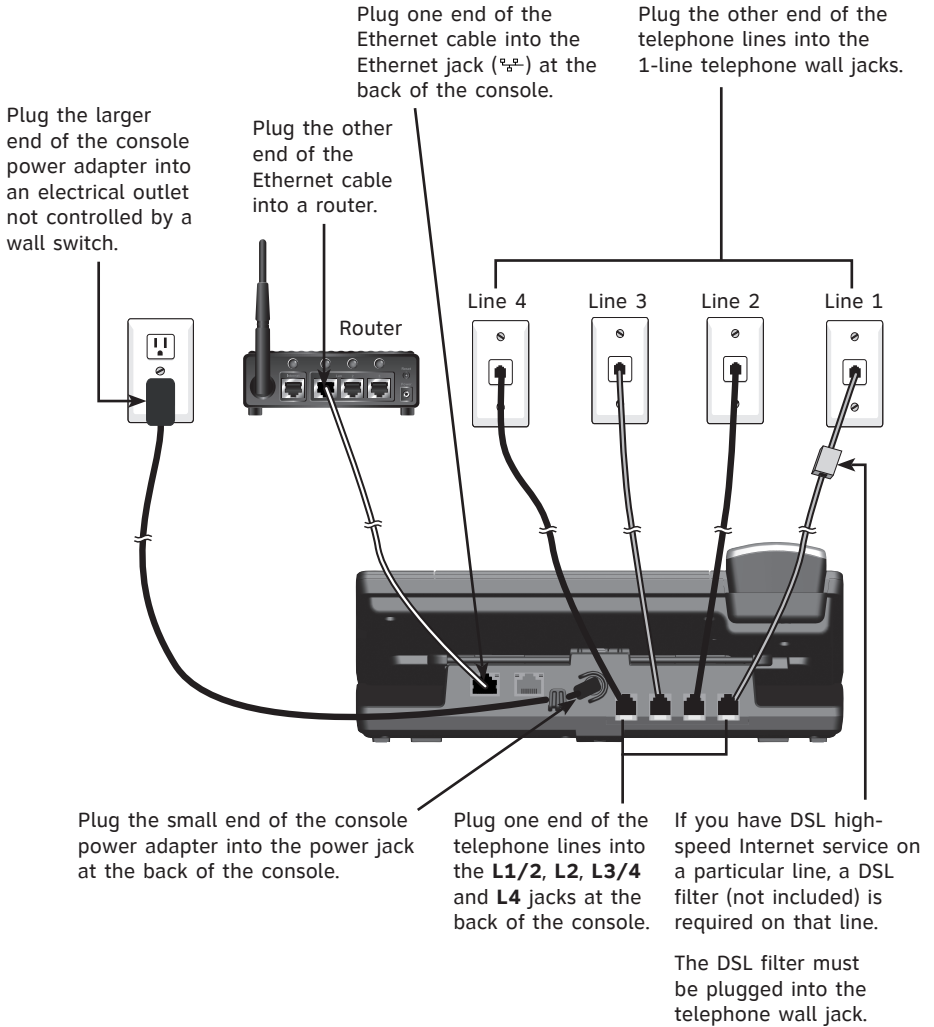

NOTE: If you are installing less than four telephone line cords to the console, plug the telephone line cords starting from the **L1/2** jack. Avoid having unoccupied telephone jack between other occupied telephone jacks.

Console installation

Option 2: To connect two 2-line wall jacks

Plug the larger end of the console power adapter into an electrical outlet not controlled by a wall switch.

Plug the other end of the Ethernet cable into a router.

Plug the other end of the telephone lines into the 2-line telephone wall jacks.

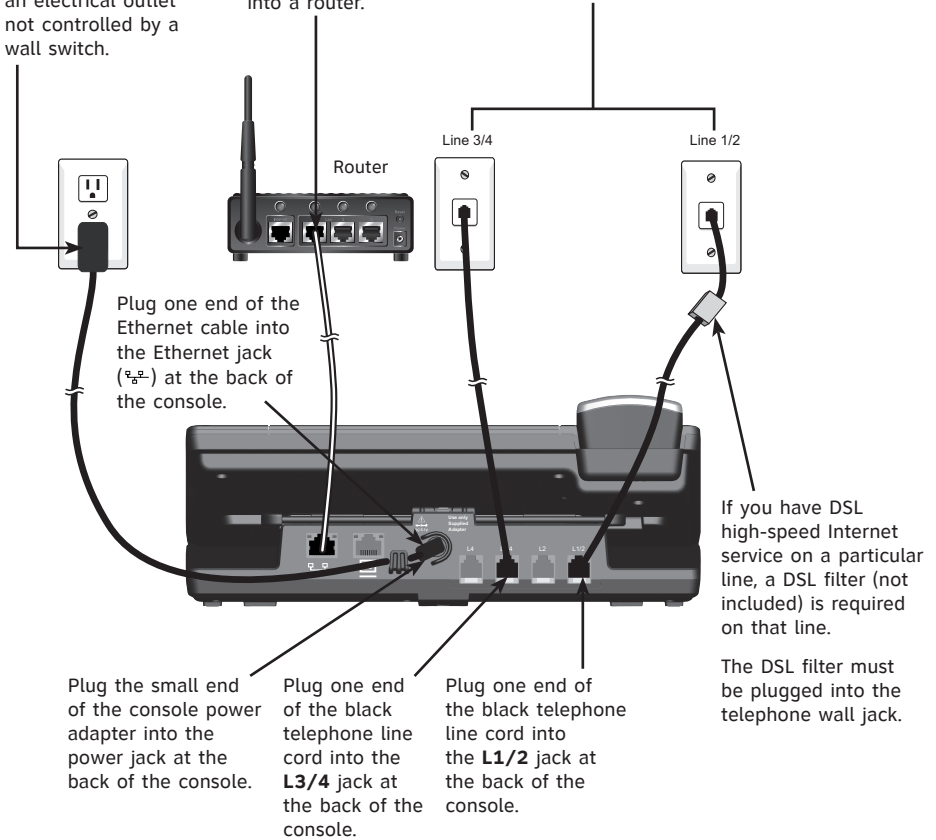

Console installation

It takes at least one minute for the console to start up the system and the screen displays **Booting...** during startup. The console is set to obtain the IP address automatically by default. The screen displays **Obtaining IP from DHCP server Please wait...** when the console is obtaining the IP from the router. When an IP is obtained, the screen displays **IP obtained: XXX.XXX.X.XXX Please set an extension number to this phone.**



If the console cannot obtain IP address automatically, it displays **No IP assigned. Check network.** and then the **Network setup** menu. You need to enter the IP address manually under the **Set static IP** menu. See **To set static IP when initially setting up the console** section (page 12) for details.



To set an extension number:

1. When the console displays **IP obtained: XXX.XXX.X.XXX Please set an extension number to this phone**, press **MENU/SELECT**.
2. Press **◀/REPEAT** or **▶/SKIP** to choose the desired extension number.
3. Press **MENU/SELECT** to save.
4. The console displays **Please wait...** and then **Starting...** It takes a while for the system to finish the startup and the console enters idle screen when the startup is done. The console is named **Console** by default.
5. Wait for approximately one minute for console to synchronize, then lift the handset. If you hear a dial tone, the installation was successful.



NOTE: This telephone provides minimal functionality during a power outage. When AC power is not available, many telephone features do not function. The telephone uses power from **L1/2** jack to enable you to make and answer calls using only the corded handset on line 1.

IMPORTANT INFORMATION

1. Use only the power adapter supplied with this product. To order a replacement power adapter, visit our website at **www.telephones.att.com**, or call **1 (800) 222-3111**. In Canada, dial **1 (866) 288-4268**.
2. The power adapter is intended to be correctly oriented in a vertical or floor mount position. The prongs are not designed to hold the plug in place if it is plugged into a ceiling, under-the-table or cabinet outlet.

Console installation (set static IP)



Instructions on this page are for users to enter static IP to set up the console, due to a failure in obtaining IP from the router automatically. If you have successfully obtained the IP from your router, you do not need to perform the steps below.

To set static IP when initially setting up the console:

1. If the console cannot obtain an IP address from the router after you power it up, the screen displays **No IP assigned. Check network.** and then displays the network setup menu.
2. Press **▲** or **▼** to scroll to **Set static IP**, then press **MENU/SELECT**.
3. The screen displays **Enter IP** Use the dialing keys to enter a specific IP.
 - Press **DELETE** to delete a character.
 - Press **#** to add a dot.
 - Press **◀/REPEAT** or **▶/SKIP** to move the cursor to the left or right.When entering a specific IP, make sure the IP range is not blocked by the administrator.
4. Press **MENU/SELECT**. The screen displays **Enter netmask** Use the dialing keys to enter a specific subnet mask.
 - Press **DELETE** to delete a character.
 - Press **#** to add a dot.
 - Press **◀/REPEAT** or **▶/SKIP** to move the cursor to the left or right.
5. Press **MENU/SELECT**. The screen displays **Enter gateway** Use the dialing keys to enter a specific gateway.
 - Press **DELETE** to delete a character.
 - Press **#** to add a dot.
 - Press **◀/REPEAT** or **▶/SKIP** to move the cursor to the left or right.
6. Press **MENU/SELECT** to save. The screen displays **IP obtained: XXX.XXX.XXX.X** Please set an extension number to this phone.
7. Press **MENU/SELECT**. Press **◀/REPEAT** or **▶/SKIP** to choose the desired extension number.
8. Press **MENU/SELECT** to save. The screen displays **Please wait...** and then **Starting...** It takes a while for the system to finish the startup. The console enters the idle screen when the startup is done.
9. Lift the handset. If you hear a dial tone, the installation was successful.

Console installation (stand-alone telephone)

This MS2085 console can be used as a stand-alone telephone without connecting to MS2015 desksets via a router.

Follow the steps below to set up the console if you do not connect it to a router.

1. When the console cannot find an IP address after you power it up, the screen displays **No IP assigned. Check network**, then displays the network setup menu.
2. Press ▲ or ▼ to scroll to **Set static IP**, then press **MENU/SELECT**.
3. The screen displays **Enter IP** Use the dialing keys to enter **192.168.1.1**.
 - Press **DELETE** to delete a character.
 - Press **#** to add a dot.
 - Press **◀/REPEAT** or **▶/SKIP** to move the cursor to the left or right.
4. Press **MENU/SELECT**. The screen displays **Enter netmask** Use the dialing keys to enter **255.255.255.0**.
 - Press **DELETE** to delete a character.
 - Press **#** to add a dot.
 - Press **◀/REPEAT** or **▶/SKIP** to move the cursor to the left or right.
5. Press **MENU/SELECT**. The screen displays **Enter gateway** Use the dialing keys to enter **192.168.1.254**.
 - Press **DELETE** to delete a character.
 - Press **#** to add a dot.
 - Press **◀/REPEAT** or **▶/SKIP** to move the cursor to the left or right.
6. Press **MENU/SELECT** to save. The screen displays **IP obtained: 192.168.1.1**
Please set an extension number to this phone.
7. Press **MENU/SELECT**. Press **◀/REPEAT** or **▶/SKIP** to choose the desired extension number.
8. Press **MENU/SELECT** to save. The screen displays **Please wait...** and then **Starting...** It takes a while for the system to finish the startup. The console enters the idle screen when the startup is done.
9. Lift the handset. If you hear a dial tone, the installation was successful.

Wall mount installation

To mount the console on the wall

1. Unplug the power adapter from the outlet, the telephone line cords from the wall jacks (or DSL filters), and the Ethernet cable from the router.
2. Put the corded handset aside. Use a coin to rotate the handset tab 180 degrees. The protruding edge holds the corded handset when the phone is mounted on the wall.

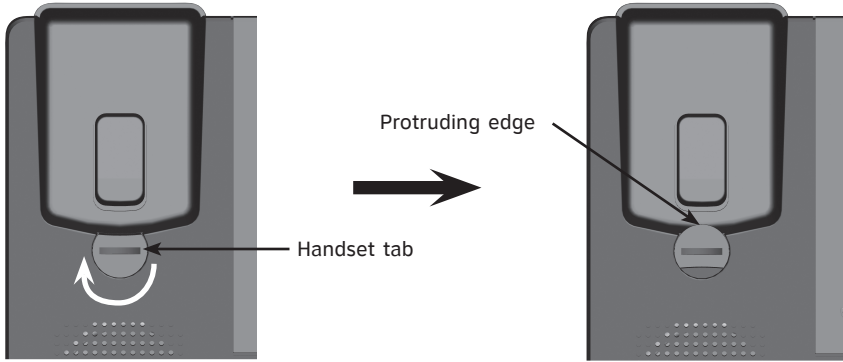

3. Lift the kickstand as indicated by the arrows below to release it from the grooves.



Wall mount installation

4. Snap the kickstand into the outermost groove until it locks into place.



Wall mount installation

5. Install the wall mount bracket to the console as shown below. Insert the upper tabs of the mounting bracket into the upper slots at the back of the console. Press the lower tabs of the mounting bracket into the lower slots at the back of the console until they lock into place.

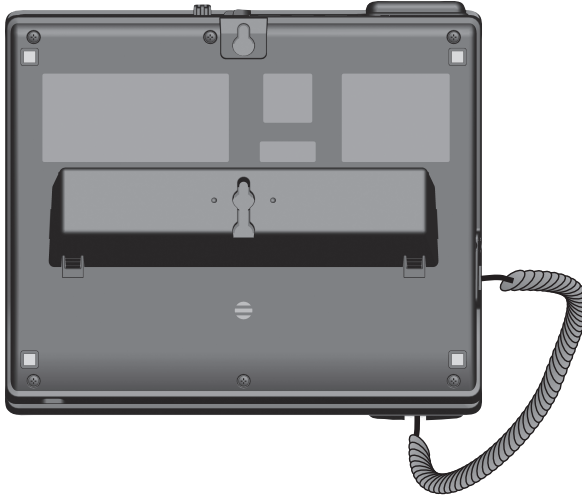

6. Install the telephone line cords and power adapter as shown below.

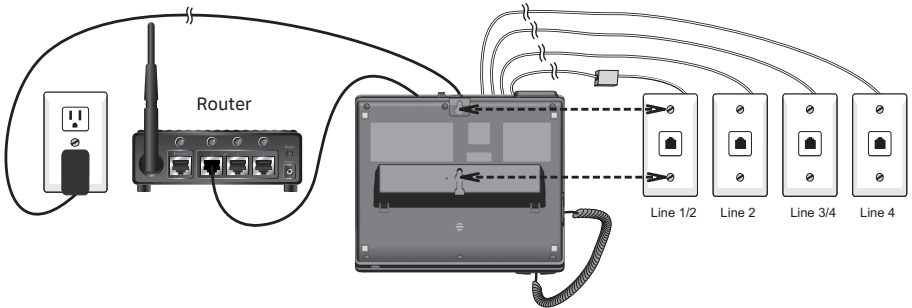

To connect two 2-line wall jacks, refer to the **Option 2: To connect two 2-line wall jacks**, illustration on page 10.

Wall mount installation

7. Align the upper wall mounting hole on the back of the console with the upper tab of the standard wall plate. Make sure the lower wall mounting hole on the mounting bracket also aligns with the lower tab of the standard wall plate. Push the console down until it clicks securely in place.

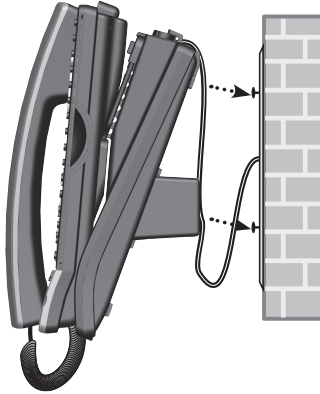

8. Bundle the telephone line cord and power adapter cord neatly with twist ties.

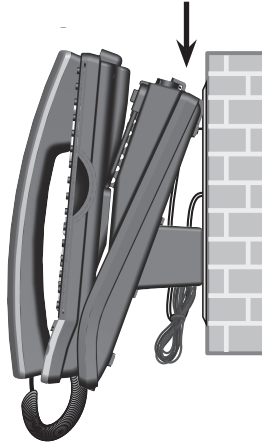

Wall mount installation

Wall mount to tabletop installation

To change the console from the wall mount position to tabletop position, follow the steps below.

1. If the telephone line cords and power adapter cord are bundled, untie them first.
2. Push the console up to remove it from wall. Unplug the telephone line cords (or DSL filters) from the wall, the power adapter from the power outlet, and the Ethernet cable from the router.
3. See **Console installation** on pages 7-8.

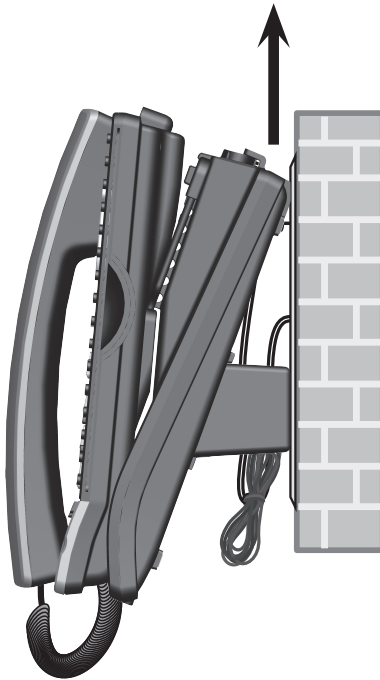

PC jack

You can connect your computer to the Ethernet network through the PC jack (PC) of this console. Plug one end of the Ethernet cable into the PC jack at the back of the console and the other end into the Ethernet jack of your computer.

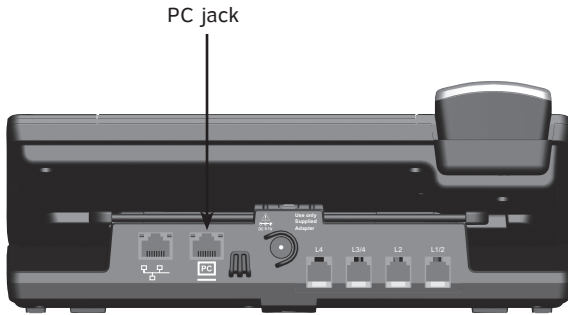

NOTES:

- The PC jack does not function when there is no power connected to this console.
- This telephone system does not support Power over Ethernet (PoE).
- If you are using the Gigabit Ethernet system, the connection speed drops to 100M.

Adding and registering desksets

Your telephone can support up to 15 MS2015 desksets. The desksets must be registered to the console before use. You must register each deskset separately.

Make sure your deskset is installed properly. Refer to the MS2015 deskset user's manual for details. Start registration when the deskset screen shows **IP obtained: XXX.XXX.X.X Press SELECT to proceed**.

To register a deskset to your MS2085 console

1. The deskset should display **IP obtained: XXX.XXX.X.X Press 'SELECT' to proceed** before you begin registration.
2. On the deskset, press **MENU/SELECT**.
3. The deskset screen displays **Enter the name of the Console that this phone is connected to**. Press **MENU/SELECT**.
4. The screen displays **Console's name**. The console's name is set as **Console** by default. If you have changed your console's name, enter the same name using dialing keys on the deskset. Otherwise, skip to step 5 to continue.
 - Press **DELETE** to delete a character.
 - Press **◀/REPEAT** or **▶/SKIP** to move the cursor to the left or right.
5. Press **MENU/SELECT** to save. The deskset screen displays **Please set an extension number to this phone**. Press **MENU/SELECT**.
6. Press **◀/REPEAT** or **▶/SKIP** to choose the desired extension number. The extension number ranges from **11** to **26**. Press **MENU/SELECT** to confirm.
7. It takes up to 60 seconds to complete the registration. The deskset screen displays **Connected to Console** when the registration is successful.
8. Lift the handset. If you hear a dial tone, the registration was successful.

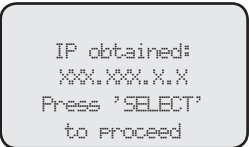

IP obtained:
XXX.XXX.X.X
Press 'SELECT'
to proceed

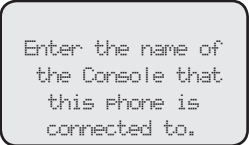

Enter the name of
the Console that
this phone is
connected to.

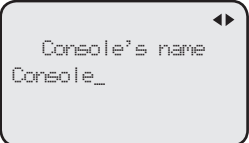

Console's name
Console_

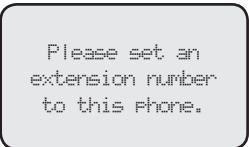

Please set an
extension number
to this phone.

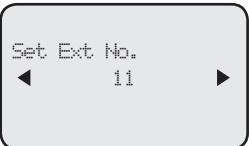

Set Ext No.
◀ 11 ▶

NOTES:

- If the registration is not successful, the deskset returns to the previous screen. Try the registration process again.
- If you want to assign an extension number that is already being used, the deskset screen displays **Extension no. is not available**. See **Release extension number** on page 25 to replace the number.

Adding and registering a cordless headset

You can use this console handsfree when you register a DECT 6.0 cordless headset (AT&T model TL7600) to the console. You can only register one cordless headset to the console. Make sure the headset battery is properly installed and charged before use. Refer to the user's manual of the cordless headset for details.

Place the headset in the headset charger and note the color of the **ON/OFF** button. If the button flashes a blue and orange light twice every five seconds, the headset is unregistered. If the button shows a constant blue light, the headset is registered. You need to deregister the headset before you can register it to the console. See the deregistration instructions in the user's manual of the telephone to which it is currently registered.

To register a TL7600 cordless headset to your MS2085 console

1. Place the headset in the headset charger and allow it to charge for at least five minutes before beginning registration. Make sure the headset is out of the headset charger before you begin registration.
2. On the MS2085 console, press **MENU/SELECT**.
3. Press **▲** or **▼** to scroll to **Registration**, then press **MENU/SELECT** or **▶/SKIP**.
4. Press **MENU/SELECT** again or press **▶/SKIP** to select **DECT Headset**. The MS2085 console shows **Registering DECT Headset...** It takes up to 60 seconds to complete the registration.
5. Place the headset into the cradle. When the registration is successful, the MS2085 console shows **DECT Headset registered**.
6. Lift the headset, then press the headset **ON/OFF** button. If you hear a dial tone, the registration was successful.

If there is no dial tone, or the **ON/OFF** light on the headset flashes twice every five seconds, the registration was not successful. Remove the headset from the headset charger and repeat the registration process again, starting with Step 2 above.

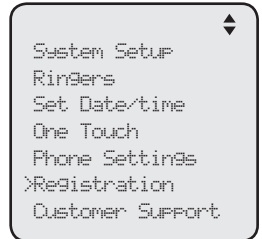

Deregistering a cordless headset

You may need to deregister your cordless headset when you have a registered headset and need to replace one. **Please read all the instructions on this page before beginning the deregistration process.**

Please make sure the telephone system is not in use before deregistration.

To deregister the cordless headset from the MS2085 console

1. On the console, press **MENU/SELECT**.
2. Press **▲** or **▼** to scroll to **Registration** and press **MENU/SELECT** or **▶/SKIP**.
3. Press **▲** or **▼** to scroll to **Deregistration** and press **MENU/SELECT** or **▶/SKIP**.
4. The console screen shows **Deregister DECT Headset? Press 'SELECT' to confirm**. Press **MENU/SELECT** to confirm.
5. The process takes up to 10 seconds to complete. The console shows **DECT Headset deregistered** when the deregistration is successful. The console returns to the **Registration** menu. To return to the idle screen, press **CANCEL** twice.
6. Enter the following code on the headset by pressing the keys in this order: **VOLUME \mathcal{D} /+, MUTE, VOLUME \mathcal{D} /-, MUTE, VOLUME \mathcal{D} /+, VOLUME \mathcal{D} /-, MUTE**. When you see the headset **ON/OFF** light flashing twice every five seconds, the deregistration is successful.

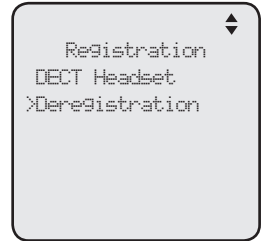

 **NOTE:** To register a cordless headset again, refer to the registration information on page 21.

Adding a corded headset

You can use this console handsfree when you install any industry-standard 2.5mm corded telephone headset (purchased separately). For best results, use an AT&T 2.5mm corded headset. To purchase a headset, visit our website at www.telephones.att.com, or call **1 (800) 222-3111**. In Canada, dial **1 (866) 288-4268**.

To add a corded headset to the console

Side view of the console



Plug a 2.5 mm headset into the **HEADSET** jack (🎧) on the side of the console.



NOTE: The **HEADSET** button on the console controls only the corded headset. For more details on the operation of the cordless headset, refer to the user's manual of the cordless headset.

System setup

Menu settings

Use this menu to change the telephone system settings.

1. Press **MENU/SELECT** when in idle mode (when the console is not in use) to enter the main menu.
2. Press **▲** or **▼** to scroll to the feature to be changed. The **>** symbol indicates the selected menu item.
3. Press **MENU/SELECT** or **▶/SKIP** to select the menu item.
4. Press **CANCEL** to exit setup without making changes.

 **NOTE:** Press **CANCEL** to cancel an operation, exit the menu display, or return to idle mode.

Set extension number

Each individual phone (console or deskset) in the telephone system **MUST** be assigned a unique extension number for the intercom feature to work. The assignment is done when the console is initially setup. If you have to set a new extension number to this console after initial setup, you are recommended to do so before registering any system desksets.

To change the extension number:

1. When the console is idle, press **MENU/SELECT**.
2. Press **MENU/SELECT** again or **▶/SKIP** to select **System Setup**.
3. Press **▲** or **▼** to scroll to **Set Ext. No.**, then press **MENU/SELECT** or **▶/SKIP**.
4. The screen displays **Set Ext No.** Press **◀/REPEAT** or **▶/SKIP** to choose the desired extension number (**11-26**).
5. Press **MENU/SELECT** to save the setting and return to the previous menu. To exit without making changes, press **CANCEL**.
6. You have to release the old extension number from the console to make it available for other desksets. See **Release extension number** on page 25 for details.

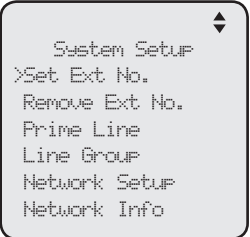
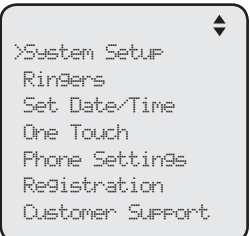

NOTES:

- If the extension number is already being used, the screen briefly displays **Extension no. already in use**.
- If you want to assign an extension number that is already being used, see **Release extension number** on page 25 to replace the number.

System setup

Release extension number

You have to release an extension number that is already being used from the telephone system to make it available for other desksets. You cannot release the console's extension number. You need to re-assign an extension number (see **Set extension number** on page 24) to any released deskset for the intercom feature to work on that deskset. After you release a deskset's extension number, its screen flashes **Set Ext No.**

To release an extension number:

1. When the console is idle, press **MENU/SELECT**.
2. Press **MENU/SELECT** again or **▶/SKIP** to select **System Setup**.
3. Press **▲** or **▼** to scroll to **Remove Ext No.**, then press **MENU/SELECT** or **▶/SKIP**.
4. The screen displays **Remove Ext No.** Press **◀/REPEAT** or **▶/SKIP** to choose the desired extension number (**11-26**), then press **MENU/SELECT**.
5. The screen displays **Remove Ext No. XX from phone: Deskset ?** (**Deskset** represents the name of the deskset) Press **MENU/SELECT** to confirm.

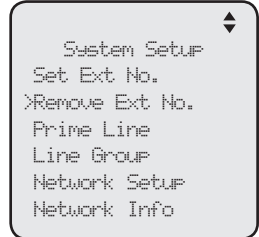

System setup

Prime line

Use this feature, also known as automatic line selection, to choose which line is automatically selected each time you lift the handset or press **SPEAKER**  or **HEADSET** (if a corded headset is connected) to make an outside call. If you select **Auto**, the console picks up any plugged telephone line starting from Line 1.

To set the prime line:

1. When the console is idle, press **MENU/SELECT**.
2. Press **MENU/SELECT** again or **▶/SKIP** to select **System Setup**.
3. Press **▲** or **▼** to scroll to **Prime Line**, then press **MENU/SELECT** or **▶/SKIP**.
4. Press **▲** or **▼** to choose the desired line, then press **MENU/SELECT** or **▶/SKIP**. To exit without making changes, press **CANCEL**.



NOTE: If you install less than four telephone line cords to the console and select **Auto** as your **Prime line** setting, make sure you plug in your telephone line cords starting from L1/2 jack. Avoid having any unoccupied telephone jack between other occupied telephone jacks.

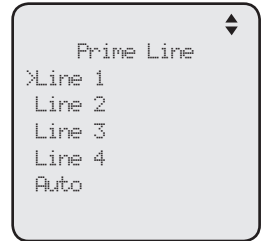
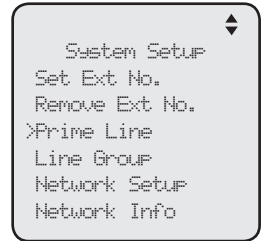

System setup

Line group

You can set an extension or several extensions to receive incoming calls from a specific telephone line. Extensions that have not been selected will not ring when there is an incoming call from that specific line. For the auto attendant to work properly, you are recommended to include this console in the line group settings of all lines.

1. When the console is idle, press **MENU/SELECT**.
2. Press **MENU/SELECT** again or **▶/SKIP** to select **System Setup**.
3. Press **▲** or **▼** to scroll to **Line Group**, then press **MENU/SELECT** or **▶/SKIP**.
4. Press **▲** or **▼** to choose the desired line, then press **MENU/SELECT** or **▶/SKIP**.
5. The screen displays **Set Ext to Ring**. Press **▲** or **▼** to scroll to the desired extension, then press **MENU/SELECT**. Repeat this step until all desired extensions are selected.
 - The extensions marked with a tick will ring when there is an incoming call from the line chosen in Step 4.
 - The extensions not marked with a tick do not ring when there is an incoming call from the line chosen in Step 4, unless the caller specifically tries to reach the extension through the auto attendant (see **Auto attendant setup** on page 76).
6. Press **▲** or **▼** to scroll to **Done**, then press **MENU/SELECT** to save the setting. To exit without making changes, press **CANCEL**.

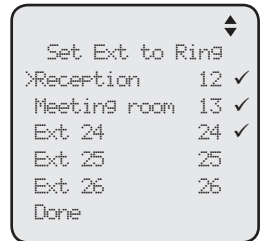
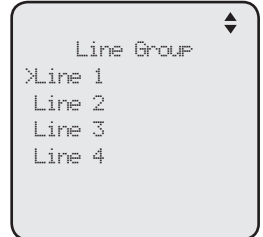
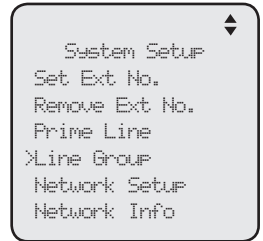

System setup

Network setup

The console must have an the IP address locating its connection with the router. You can set the console to obtain the IP from a DHCP server automatically or assign a specific IP on your own. The console obtains the IP from the router automatically by default. You are not recommended to change the IP assigned to this console after you have registered other desksets. If you do so, the entire system may need to be reset.

To enable the Auto set IP:

1. When the console is idle, press **MENU/SELECT**.
2. Press **MENU/SELECT** again or **▶/SKIP** to select **System Setup**.
3. Press **▲** or **▼** to scroll to **Network Setup**, then press **MENU/SELECT** or **▶/SKIP**.
4. Press **▲** or **▼** to scroll to **Auto set IP**, then press **MENU/SELECT** or **▶/SKIP**.
5. Press **▲** or **▼** to scroll to **Yes**, then press **MENU/SELECT** or **▶/SKIP**.
6. The screen displays **Obtain IP from DHCP server?**
Press **MENU/SELECT** to save the setting.
7. The screen displays **Obtaining IP from DHCP server Please wait...** It takes up to one minute to obtain the IP address.
8. The screen displays **IP obtained: XXX.XXX.X.XXX Check network info?** when the IP is successfully assigned. Press **MENU/SELECT** to read the network info, or press **CANCEL** to return to the previous menu.
 - If the system fails to assign an IP automatically, the screen briefly displays **Unable to obtain IP. Please check DHCP server.** and then **Set static IP to this extension?** You may press **MENU/SELECT** to enter the Static IP setting menu.
9. Reboot the console to update the IP.

```

System Setup
Set Ext No.
Remove Ext No.
Prime Line
Line Group
>Network Setup
Network Info
  
```

```

Network Setup
>Auto set IP
Set static IP
  
```

```

Auto set IP
>Yes
No
  
```

```

Obtain IP from
DHCP server?
  
```

```

IP obtained:
192.168.1.103

Check
network info?
  
```

System setup

Network setup (continued)

If you want to switch from **Auto set IP** to **Set static IP**, you have to disable the **Auto set IP** setting first.

To disable Auto set IP:

1. When the console is idle, press **MENU/SELECT**.
2. Press **MENU/SELECT** again or **▶/SKIP** to select **System Setup**.
3. Press **▲** or **▼** to scroll to **Network Setup**, then press **MENU/SELECT** or **▶/SKIP**.
4. Press **▲** or **▼** to scroll to **Auto set IP**, then press **MENU/SELECT** or **▶/SKIP**.
5. Press **▲** or **▼** to scroll to **No**, then press **MENU/SELECT** or **▶/SKIP** to save the setting. To exit without making changes, press **CANCEL**.

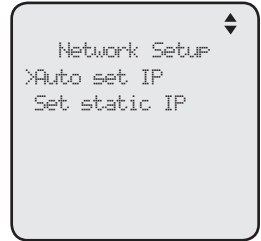

To enable Set static IP:

1. When the console is idle, press **MENU/SELECT**.
2. Press **MENU/SELECT** again or **▶/SKIP** to select **System Setup**.
3. Press **▲** or **▼** to scroll to **Network Setup**, then press **MENU/SELECT** or **▶/SKIP**.
4. Press **▲** or **▼** to scroll to **Set static IP**, then press **MENU/SELECT** or **▶/SKIP**.
5. The screen displays **Enter static IP**. Use the dialing keys to enter a specific IP.
 - Press **DELETE** to delete a character.
 - Press **#** to add a dot.
 - Press **◀/REPEAT** or **▶/SKIP** to move the cursor to the left or right.

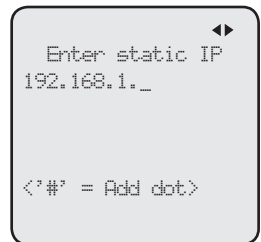
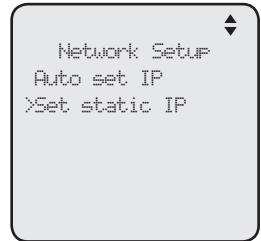

When entering a specific IP, make sure the IP range is not blocked by the administrator.

System setup

Network setup (continued)

6. Press **MENU/SELECT** to proceed. The screen displays **Subnet mask: XXX.XXX.X.X**. Use the dialing keys to enter a specific subnet mask.

- Press **DELETE** to delete a character.
- Press **#** to add a dot.
- Press **◀/REPEAT** or **▶/SKIP** to move the cursor to the left or right.



7. Press **MENU/SELECT** to proceed. The screen displays **Router/Gateway: XXX.XXX.X.XXX**. Use the dialing keys to enter a specific gateway.

- Press **DELETE** to delete a character.
- Press **#** to add a dot.
- Press **◀/REPEAT** or **▶/SKIP** to move the cursor to the left or right.

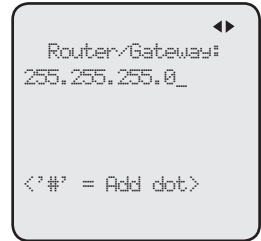

8. Press **MENU/SELECT** to save. The screen displays **IP obtained: XXX.XXX.X.XXX**. Press **MENU/SELECT** to read the network info, or press **CANCEL** to return to the main menu.

- If the IP entered is invalid, the screen displays **IP is invalid.** briefly and then returns to the **Enter static IP** screen.

9. Reboot the console to update the IP.

System setup

Network info

Use this feature to view the information of the IP address, subnet mask, router/gateway, DNS servers, and DHCP server of this console.

To check the network information:

1. When the console is idle, press **MENU/SELECT**.
2. Press **MENU/SELECT** again or **▶/SKIP** to select **System Setup**.
3. Press **▲** or **▼** to scroll to **Network Info**, then press **MENU/SELECT** or **▶/SKIP**.
4. Press **▲** or **▼** to browse through the network information.

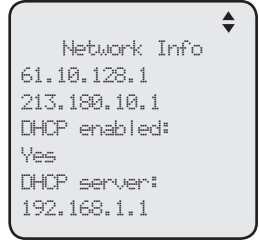
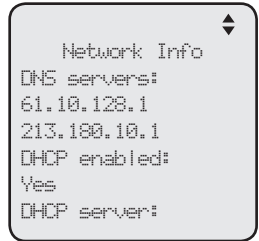
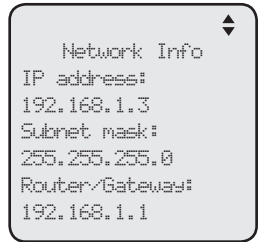
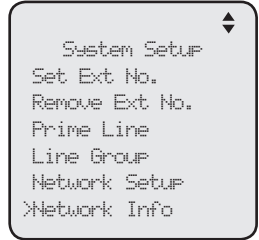

Telephone setup

Ringer volume

Use this feature to set the ringer volume to one of six levels or turn the ringer off. When the ringer is off, the  icon appears on the console screen. The MS2085 console stores the volume setting for all lines.

1. When the console is idle, press **MENU/SELECT**.
2. Press **▲** or **▼** to scroll to **Ringers**, then press **MENU/SELECT** or **▶/SKIP**.
3. Press **MENU/SELECT** again or **▶/SKIP** to select **Ringer Volume**.
4. Press **▲**, **▼**, **◀/REPEAT**, **▶/SKIP**, or **▲VOLUME▼** on the console to adjust the ringer volume.
5. Press **MENU/SELECT** to save the setting and return to the previous menu. To exit without making changes, press **CANCEL**.

-OR-

When the console is idle, press **▲VOLUME▼** to adjust the ringer volume, then press **MENU/SELECT** to save.



NOTE: The ringer volume also determines the ringer volume for intercom calls. If the console ringer volume is set to off, it is silenced for all incoming calls, including intercom calls.

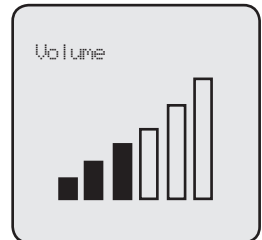
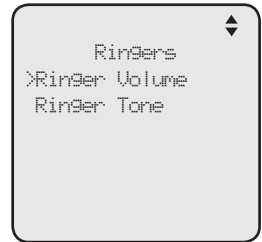
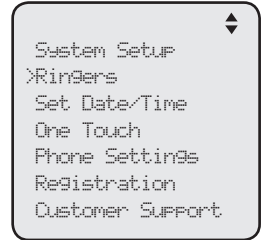

Telephone setup

Ringer tone

Use this feature to choose one of the ten ringer tones for incoming calls. You can choose different ringer tones for different lines so you can easily identify which line is calling.

1. When the console is idle, press **MENU/SELECT**.
2. Press **▲** or **▼** to scroll to **Ringers**, then press **MENU/SELECT** or **▶/SKIP**.
3. Press **▲** or **▼** to scroll to **Ringer Tone**, then press **MENU/SELECT** or **▶/SKIP**.
4. Press **▲** or **▼** to select the desired line (**Line 1**, **Line 2**, **Line 3** or **Line 4**), then press **MENU/SELECT** or **▶/SKIP**.
5. Press **▲** or **▼** to select the desired ringer tone.
6. Press **MENU/SELECT** or **▶/SKIP** to save the setting and return to the previous menu. To exit without making changes, press **CANCEL** or **◀/REPEAT**.
7. Repeat steps 4-6 above to choose ringer tones for other lines if desired.

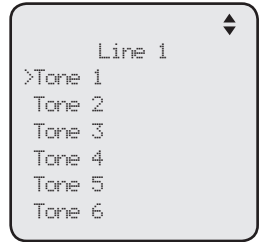
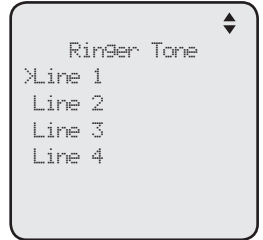
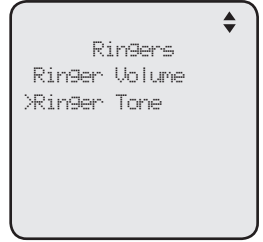

Telephone setup

Set date/time

The answering system displays the date and time of the message while playing messages. Before using the answering system, set the date and time as follows.

Follow the steps below to set the month, day, year and time:

1. When the console is idle, press **MENU/SELECT**.
2. Press **▲** or **▼** to scroll to **Set Date/Time**, then press **MENU/SELECT** or **▶/SKIP**.
3. Use the dialing keys to enter the month (MM), day (DD) and year (YY). Press **◀/REPEAT** or **▶/SKIP** to scroll between month, day and year.
4. Press **MENU/SELECT** to move to the time setting.
5. Use the dialing keys to enter the hour and minute.
6. Press **◀/REPEAT** or **▶/SKIP** to select **AM** or **PM**.
7. Press **MENU/SELECT** to save the setting and return to the previous menu. To exit without making changes, press **CANCEL**.



```

System Setup
Ringers
>Set Date/Time
One Touch
Phone Settings
Registration
Customer Support
  
```



```

Set Date
01/01/12
MM/DD/YY
  
```



```

Set Time
02:30 ◀ AM ▶
  
```

Telephone setup

LCD language

This feature allows you to change the language used for all screen displays. The language settings on the console and desksets are independent. By default, the language is set to **English**.

1. When the console is idle, press **MENU/SELECT**.
2. Press ▲ or ▼ to scroll to **Phone Settings**, then press **MENU/SELECT** or ►/SKIP.
3. Press ▲ or ▼ to scroll to **LCD Language**, then press **MENU/SELECT** or ►/SKIP.
4. Press ▲ or ▼ to select **English**, **Français** or **Español**.
5. Press **MENU/SELECT** or ►/SKIP again to save the setting and return to the previous menu. To exit without making changes, press **CANCEL**.

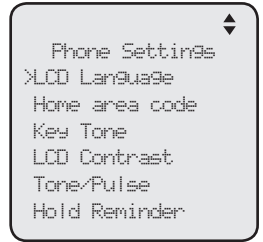

Telephone setup

Home area code

Use this feature to program this console to recognize your home area code. This feature makes it easy for you to place a call from the caller ID log.

When you receive a call from within your home area code, the caller ID information only displays the seven digits of the telephone number, and when you dial from the call log, only seven digits are dialed.

1. When the console is idle, press **MENU/SELECT**.
2. Press ▲ or ▼ to scroll to **Phone Settings**, then press **MENU/SELECT** or ►/SKIP.
3. Press ▲ or ▼ to scroll to **Home area code**, then press **MENU/SELECT** or ►/SKIP.
4. The console displays **Home area code**. Use the dialing keys to enter a three-digit area code.
 - Press ◀/REPEAT or ►/SKIP to move the cursor to the left or right.
 - Press **DELETE** to delete a digit.
5. Press **MENU/SELECT** to save the setting and return to the previous menu. To exit without making changes, press **CANCEL**.

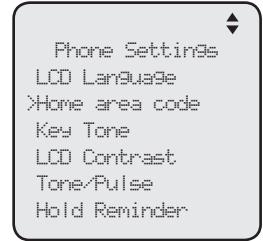

Telephone setup

Key tone

The console is set to beep with each key press. If you turn off the key tone, there are no beeps when you press keys.

1. When the console is idle, press **MENU/SELECT**.
2. Press **▲** or **▼** to scroll to **Phone Settings**, then press **MENU/SELECT** or **▶/SKIP**.
3. Press **▲** or **▼** to scroll to **Key Tone**, then press **MENU/SELECT** or **▶/SKIP**.
4. Press **▲** or **▼** to choose **On** or **Off**.
5. Press **MENU/SELECT** or **▶/SKIP** to save the setting and return to the previous menu. To exit without making changes, press **CANCEL** or **◀/REPEAT**.

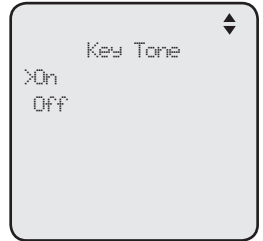
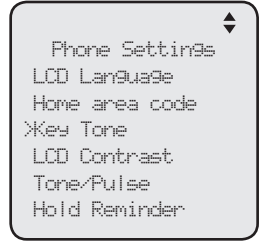

LCD contrast

Use this feature to adjust the screen contrast to one of eight levels to optimize readability in different lighting conditions.

1. When the console is idle, press **MENU/SELECT**.
2. Press **▲** or **▼** to scroll to **Phone Settings**, then press **MENU/SELECT** or **▶/SKIP**.
3. Press **▲** or **▼** to scroll to **LCD Contrast**, then press **MENU/SELECT** or **▶/SKIP**.
4. Press **▲** or **▼** to choose the desired screen contrast level (**Level 1 - Level 8**).
5. Press **MENU/SELECT** or **▶/SKIP** to save the setting and return to the previous menu. To exit without making changes, press **CANCEL** or **◀/REPEAT**.

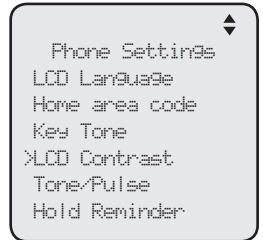

Telephone setup

Dial mode

The dial mode is preset to tone dialing. If you have pulse (rotary) service, you must change the dial mode to pulse dialing before using the telephone.

1. When the console is idle, press **MENU/SELECT**.
2. Press **▲** or **▼** to scroll to **Phone Settings**, then press **MENU/SELECT** or **▶/SKIP**.
3. Press **▲** or **▼** to scroll to **Tone/Pulse**, then press **MENU/SELECT** or **▶/SKIP**.
4. Press **▲** or **▼** to choose **Tone** or **Pulse**.
5. Press **MENU/SELECT** or **▶/SKIP** to save the setting and return to the previous menu. To exit without making changes, press **CANCEL** or **◀/REPEAT**.

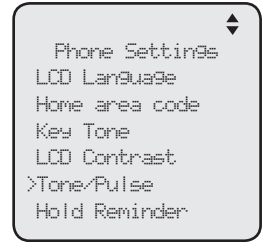

Hold reminder

When this feature is on and there is a call on hold, the console beeps once every 30 seconds.

To turn this feature on or off:

1. When the console is idle, press **MENU/SELECT**.
2. Press **▲** or **▼** to scroll to **Phone Settings**, then press **MENU/SELECT** or **▶/SKIP**.
3. Press **▲** or **▼** to scroll to **Hold Reminder**, then press **MENU/SELECT** or **▶/SKIP**.
4. Press **▲** or **▼** to scroll to **On** or **Off**.
5. Press **MENU/SELECT** or **▶/SKIP** to save the setting and return to the previous menu. To exit without making changes, press **CANCEL** or **◀/REPEAT**.

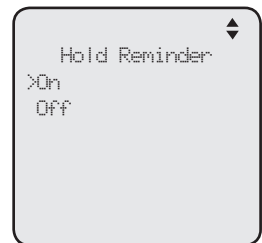
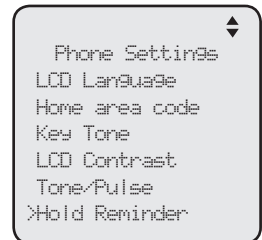

Telephone setup

Phone rename

Use this feature to rename the console. If you have to rename your console after initial setup, you are recommended to do so before registering any system desksets.

To change the name:

1. When the console is idle, press **MENU/SELECT**.
2. Press **▲** or **▼** to scroll to **Phone Settings**, then press **MENU/SELECT** or **▶/SKIP**.
3. Press **▲** or **▼** to scroll to **Phone Rename**, then press **MENU/SELECT** or **▶/SKIP**.
4. Use the dialing key keys to change the name (up to 12 characters).
 - Press **◀/REPEAT** or **▶/SKIP** to move the cursor to the left or right.
 - Press **DELETE** to delete a character.
5. Press **MENU/SELECT** to save the setting and return to the previous menu. To exit without making changes, press **CANCEL**.

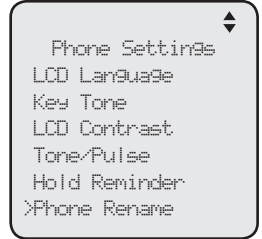

Set default

Use this feature to reset all settings of this console to their default settings. All phone settings, directory, caller ID history, redial list, one-touch memory, central and private mailbox messages will be reset.

To reset all feature settings to default:

1. When the console is idle, press **MENU/SELECT**.
2. Press **▲** or **▼** to scroll to **Phone Settings**, then press **MENU/SELECT** or **▶/SKIP**.
3. Press **▲** or **▼** to scroll to **Set Default**.
4. Press **MENU/SELECT** or **▶/SKIP**. The screen displays **Set phone to default settings? Press 'SELECT' to confirm.**
5. Press **MENU/SELECT** to confirm. The console reboots to reset all settings.

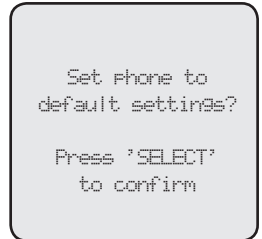
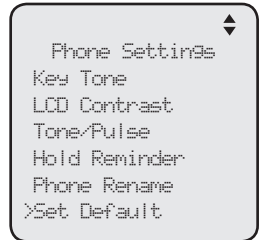

NOTE: After you reset the console to default, you will have to re-assign the extension numbers of all your system desksets. Refer to the **Set extension number** section in the MS2015 user's manual for instructions.

Telephone setup

Customer support

Use this feature to display the AT&T website.

1. When the console is idle, press **MENU/SELECT**.
2. Press ▲ or ▼ to scroll to **Customer Support**, then press **MENU/SELECT** or ►/**SKIP**.
3. Press **CANCEL** to return to the main menu.



www.
telephones.
att.com

Telephone operation

The telephone comes programmed to select a line automatically for calls when you do not press a line key. To override the automatic line selection setting, see **Prime line** on page 26 for details. When you answer a call, the telephone automatically selects the ringing line.

Line indicators

Each of the four indicators on **LINE 1-LINE 4** indicate the state of the corresponding telephone line.

- On when the corresponding line is in use.
- Flashes slowly when the line is on hold.
- Flashes rapidly when there is an incoming call on the corresponding line.

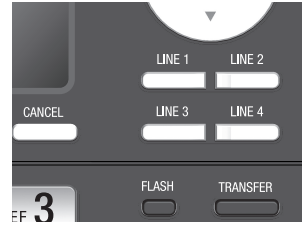

Making and ending a call

To make a call using the console:

1. Lift the handset or press **SPEAKER** .

-OR-

To override automatic line selection, press **LINE 1-LINE 4** for the desired line, then lift the handset.

2. Wait for a dial tone, then enter the telephone number. The screen displays the elapsed time as you talk (in hours, minutes and seconds).



To end a call using the console:

- Place the handset on the console to hang up.

-OR-

- Press the corresponding line key (**LINE 1-LINE 4**).

-OR-

- If you are using the speakerphone, press **SPEAKER**  to hang up.



NOTE: The elapsed time is not affected by accessing services from your telephone service provider.

Telephone operation

To make a call using a corded headset:

Make sure a corded headset is connected to the console (page 23).

1. Press **HEADSET** on the console.
2. Wait for a dial tone, then dial the number.
3. To hang up, press **HEADSET**.

To make a call using a cordless headset:

You can make a call using a registered cordless headset (see **Adding and registering a cordless headset** on page 21). For more details on the cordless headset operation, refer to the TL7600 user's manual.

1. Enter the telephone number. Press **DELETE** to make corrections.
2. Lift the handset or press **SPEAKER**  to dial.
3. Press the **ON/OFF** button on the cordless headset.
4. To hang up, press the **ON/OFF** button.



On hook dialing (predialing)

1. Enter the telephone number. Press **DELETE** to make corrections.
2. Lift the handset or press **SPEAKER**  to dial.

-OR-

To override automatic line selection, press **LINE 1-LINE 4** for the desired line, then lift the handset.

Full duplex speakerphone

During a call, press **SPEAKER**  to switch between handsfree speakerphone and normal handset use. Press **SPEAKER**  again if you are using speakerphone or place the handset on the console to hang up.

Answering a call

Lift the handset, or press the corresponding line key (**LINE 1-LINE 4**), **SPEAKER** , **HEADSET** or the **ON/OFF** button on a registered cordless headset to answer an incoming call.

Temporary ringer silencing

When the telephone is ringing, you can temporarily silence the ringer of the console without disconnecting the call. Press **MUTE** to silence the ringer. The next call rings normally at the preset volume.

Options while on calls

Call waiting

If you subscribe to call waiting service with your telephone service provider, you hear a beep if someone calls while you are in the middle of a call.

- Press **FLASH** to put your current call on hold and take the new call.
- Press **FLASH** at any time to switch back and forth between calls.

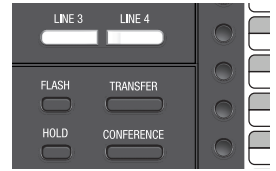

Volume control

Use this feature to set the listening volume to one of six levels for each of the listening options (corded handset, corded headset and speakerphone). All settings are independent. While on a call, press **▲VOLUME▼** to adjust the listening volume.

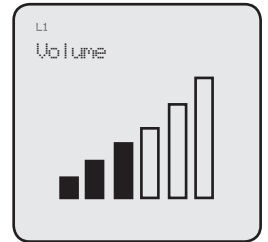

Mute

Use this feature during a telephone conversation to silence the microphone. You can hear the caller, but the caller cannot hear you.

To mute a call:

- Press **MUTE**. When mute is on, the **MUTE** button lights up; the screen also displays **MUTE**.

To take a call off mute:

- Press **MUTE** again and resume speaking.

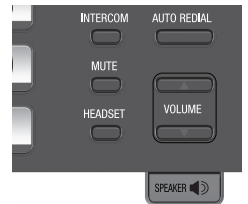

Temporary tone dialing

If you have pulse (rotary) service only, use this feature to temporarily switch pulse to touch-tone dialing during a call by pressing **TONE ✕**.

1. Press **TONE ✕** during a call.
2. Use the dialing keys to enter the desired number. The telephone sends touch-tone signals.

The telephone automatically returns to pulse dialing mode after you end the call.

Options while on calls

Hold

Use this feature to hold one line while accessing another, or as part of the conference and call transfer features.

While on a call, press **HOLD**. The corresponding line key (**LINE 1-LINE 4**) indicator for the line on hold flashes slowly. After the call has been put on hold, a beep sounds every 30 seconds. (To turn off the reminder beep, see **Hold reminder** on page 38).

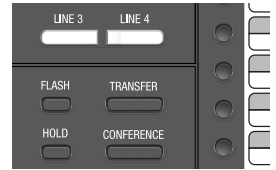

If you are using the speakerphone, the speakerphone turns off and the **SPEAKER**  key turns off automatically after you press **HOLD**. If you are using the corded headset, the headset turns off and the **HEADSET** key turns off automatically after you press **HOLD**.

To release the hold, press the line key (**LINE 1-LINE 4**) of the line being put on hold.

Music on hold (M.O.H) is available on this console. When you put a call on hold, the caller will hear the default music that comes with the console.

*Music-on Hold functionality should only be used in conjunction with music specifically licensed for on-hold use. Licensed on-hold music is available from many third party suppliers. AT&T disclaims any liability arising from the failure to obtain such a license.



NOTES:

- You cannot put an intercom call on hold.
- The call privacy setting remains unchanged after the call is put on call.
- The call ends automatically after it is put on hold for 10 minutes.

Switching between lines

Use this feature to switch between lines during an outside call:

1. Press the desired line key (**LINE 1-LINE 4**) of the telephone line you want to make or answer call. The current call is put on hold automatically.
2. To return to the first call, press the line key (**LINE 1-LINE 4**) of the original call. The second line is put on hold automatically.

Options while on calls

Call privacy

The call privacy is set to **On** by default. The console allows only one device to use a line at a time. You can turn this setting off during a call to allow other telephones to join the call. The setting automatically returns to **On** after you hang up.

To turn call privacy off during a call:

1. While on a call, press **MENU/SELECT**.
2. Press **MENU/SELECT** to select **Call Privacy**.
3. Press **▲** or **▼** to choose **Off**, then press **MENU/SELECT**. Other telephones can now join the call by pressing the corresponding line key (**LINE 1-LINE 4**).

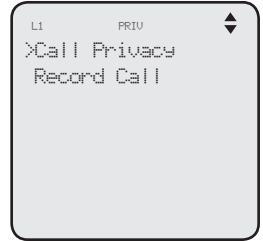

To turn call privacy back on during a call:

1. While on a call, press **MENU/SELECT**.
2. Press **MENU/SELECT** to select **Call Privacy**.
3. Press **▲** or **▼** to choose **On**, then press **MENU/SELECT**. The console displays **PRIV**. No extension can join the call now. If another extension tries to access the line you are using, it displays **Line is not available at this time**.

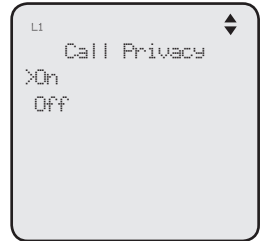

NOTE: You cannot set call privacy during intercom calls.

Options while on calls

Recording a call

Use this feature to record a phone conversation during a call. The recording is treated the same as memos and is marked as a new message in the private mailbox. You cannot record a conference call or an intercom call and you cannot use another line while you are recording a phone conversation. Listen to recorded conversation the same way as incoming messages or memos (see **Message playback** on page 91).

To record a call:

1. While on a call, press **MENU/SELECT**.
2. Press **▲** or **▼** to scroll to **Record Call**, then press **MENU/SELECT**.
3. Press **MENU/SELECT** to choose **Start recording**.
4. The recording starts and the screen shows **REC**. There is a beep sound.



NOTE: To ensure that you are in compliance with any federal or state regulations regarding recording a telephone call, you should start the recording process and then inform the other party that you are recording the call.

To stop recording:

Place the handset back to the console, or press **SPEAKER**  to hang up if you are using the speakerphone.

-OR-

1. Press **MENU/SELECT** during the recording.
2. Press **▲** or **▼** to scroll to **Record Call**, then press **MENU/SELECT**.
3. Press **MENU/SELECT** to choose **Stop recording**. The system saves the conversation into the private mailbox.



Options while on calls

Chain dialing

While you are on a call, you can initiate a dialing sequence from the numbers in the directory, caller ID history, redial list or one-touch memory.

Chain dialing can be useful if you wish to access other numbers (such as bank account numbers or access codes) from the directory, caller ID history, redial list or one-touch memory.

To access the directory while on a call:

1. Press **DIRECTORY**, then press ▲ or ▼ to scroll to the desired entry.
2. Press **MENU/SELECT** to dial the desired number. To exit without making changes, press **CANCEL** and continue with the conversation.

To access the call history while on a call:

1. Press **CALL HISTORY**, then press ▲ or ▼ to scroll to the desired entry.
2. Press **MENU/SELECT** to dial the desired number. To exit without making changes, press **CANCEL** and continue with the conversation.

To access the redial list while on a call:

1. Press **AUTO REDIAL**, then press ▲ or ▼ to scroll to the desired entry.
2. Press **MENU/SELECT** to dial the desired number. To exit without making changes, press **CANCEL** and continue with the conversation.

To access the one-touch memory while on a call:

Press the desired one-touch key for the number in the upper location.

-OR-

Press **LOWER**, then press the desired one-touch key for the number in the lower location.

Redial

The last 10 telephone numbers dialed (up to 30 digits) are stored in the console.

To view the 10 most recently dialed numbers

1. Press **AUTO REDIAL** to enter the redial list and display the most recently called number.
2. Press **▲** or **▼** to view other recently called numbers.
3. Press **CANCEL** to exit the redial list.

To redial a number

When the desired number displays on the screen:

- Lift the handset.

-OR-

- Press **SPEAKER**  or **HEADSET**.

To override automatic line selection, press **LINE 1-LINE 4** for the desired line, then lift the handset.

To copy a redial entry to directory

1. Press **AUTO REDIAL** to enter the redial list and display the most recently called number.
2. Press **▲** or **▼** to view other recently called numbers.
3. Press **◀/REPEAT** or **▶/SKIP** to choose **Copy to DIR**, then press **MENU/SELECT**.
4. The console displays **Enter Name**. Use the dialing keys to enter the name (up to 15 characters).
 - Press **◀/REPEAT** or **▶/SKIP** to move the cursor to the left or right.
 - Press **DELETE** to delete a character.
5. Press **MENU/SELECT** to save. The console displays **Enter Number**. Use the dialing keys to enter the number (up to 30 digits).
 - Press **DELETE** to delete a digit.
 - Press **◀/REPEAT** or **▶/SKIP** to move the cursor to the left or right.
 - You can include a pause while storing a dialing sequence that requires one during actual dialing. Press **▲** or **▼** to choose **◆Add pause**, then press **MENU/SELECT**. A **P** appears on the screen.
 - Store a signal for switching to temporary tone signaling. If you have dial pulse (rotary) service, this signal is required for some special services. Press **▲** or **▼** to choose **◆Send tone**, then press **MENU/SELECT**. A **T** appears on the screen. All numbers you enter after this will send touch-tone signals during dialing.

Redial

To copy a redial entry to directory (continued)

- You can store the flash signal required by some special services as part of a dialing sequence. Press ▲ or ▼ to choose **◆Add flash**, then press **MENU/SELECT**. An **F** appears on the screen.
6. Press ▲ or ▼ to choose **Done**, then press **MENU/SELECT**. To exit without making changes, press ▲ or ▼ to choose **◆Cancel** and then press **MENU/SELECT**, or press **CANCEL** to return to the previous menu.

To copy a redial entry to one-touch memory

1. Press **AUTO REDIAL** to enter the redial list and display the most recently called number.
2. Press ▲ or ▼ to view other recently called numbers.
3. Press ◀/**REPEAT** or ▶/**SKIP** to choose **Copy to 1-touch**, then press **MENU/SELECT**.
4. The console displays **Press a 1-touch key to save the number**.
 - Press the one-touch button for the destination party in the upper location (the first 16 one-touch locations).
 - OR-**
 - Press **LOWER** then the one-touch button for the destination party in the lower location (the second 16 one-touch locations).
5. The console displays **Number saved to 1-touch key**.

To delete a number

While the screen displays the desired number, press **DELETE** to delete the number from the redial memory. The screen displays **Redial deleted**.

Redial

Auto-redial

Use this feature to automatically redial a number up to ten times.

1. Press **AUTO REDIAL** to enter the redial list and display the most recently called number.
2. Press **▲** or **▼** to view other recently called numbers.
3. While the screen displays the desired number, press **◀/REPEAT** or **▶/SKIP** to choose **Auto redial**, then press **MENU/SELECT**.
4. The telephone calls the desired number using the speakerphone. The screen displays **Redial in XX sec.**
5. When the other party answers, you will need to take an action to speak with the other party and stop the auto-redial attempts. Press **MUTE** on the console, then lift the handset, press **SPEAKER** **◀▶** or **HEADSET** to speak with the other party.
 - After a call is placed, if the line is busy, you will hear a busy tone for a few seconds before the console hangs up. The call will be redialed 30 seconds later. This process repeats up to 10 times or until the called number is no longer busy. If the line is still busy after 10 attempts, no more attempts are made.
 - If the line is ringing but no party answers after two attempts, no more attempts are made.
 - If you want to turn off the auto-redial feature during the 30-second waiting time, press **CANCEL**.

Conference call

The system can support 5-way conference with a maximum of one outside call and four system extensions (including the initiating party), or two outside calls and three system extensions (including the initiating party). The outside call must be established first because an intercom call cannot be placed on hold.

There are two ways to establish a conference call.

A. Inviting parties using Intercom

The party who initiates the conference invites other system extensions to join the conference by using intercom after establishing the first outside call.

-OR-

B. Join a call in progress

Other system extensions can join the call in progress by pressing the line key which is currently in use for the conference to join the call.

A. Inviting parties using Intercom

1. Make or answer an outside call.
2. Press another available line key to make another outside call. The original outside call is put on hold. When the external party picks up, you can have a private conversation with that party.

-OR-

Press **INTERCOM**. The outside call is put on hold. Press ▲ or ▼ to scroll to the desired extension, or enter the desired extension number directly. The called extension picks up the intercom call. You can now have a private conversation with that extension.

3. Press **CONFERENCE** at any time to begin the conference call.
4. If necessary, repeat steps 2-3 above to invite another system extension to join the conference until the maximum capacity is reached.
5. Place the corded handset on the console or press **SPEAKER**  if you are using the speakerphone to hang up. If the party who initiates the conference call hangs up, the conference call will be ended. The call will also be ended when all parties hang up.

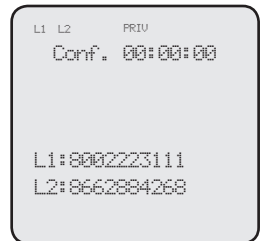

To drop an outside line:

- If you want to drop an outside line during a conference call, press the corresponding line key (**LINE 1-LINE 4**).

-OR-

- If the other end of the outside line hangs up the call, press the corresponding line key (**LINE 1-LINE 4**) to release that line for other system extension use.



NOTE: If you want to start a conference with two outside calls, make sure you have invited two outside calls before inviting any system extensions

Conference call

B. Join a call in progress

1. Make or answer an outside call on the console, then press **MENU/SELECT**.
2. Press **MENU/SELECT** to select **Call Privacy** on your console.
3. Press **▲** or **▼** to choose **Off**, then press **MENU/SELECT**.
4. Any system extension can join the call by pressing the line key currently in use to join the conference. When there is an extension joined the conference, you have to turn off the call privacy setting (steps 2-3 above) on that extension if you want another extension to join the call.
5. If necessary, repeat step 4 until the maximum capacity is reached.
6. Place the corded handset on the console or press **SPEAKER**  if you are using speakerphone to hang up. The call will be ended when all parties hang up.



NOTES:

- If the system extension who initiated the call does not turn off the call privacy setting and you try to join that call, your deskset screen displays **Line is not available at this time**.
- We recommend you to have no more than five parties in a conference call. A conference call can hold more than five parties but the performance of the call is not guaranteed.
- If you have answered another outside call during a conference and want to resume the original call, end the existing call first, then lift the corded handset, or press **SPEAKER**  or **CONFERENCE**.
- If you are experiencing difficulty in using the conference features on this telephone, please consider using AT&T's complete line of teleconference services to find a solution that best meets your needs. AT&T TeleConference Services reduces travel time and expenses while increasing productivity wherever people are located, enabling you to host truly virtual meetings and share important information in real time. To sign up for AT&T TeleConference Services, go to: **www.att.com/orderconference** for details.

Conference call

Call scenario

The table below provides you with more information on the number of outside lines available for use during a conference call under different call scenarios.

A. Inviting parties using Intercom

Device that starts a conference call	Number of outside calls in a conference	Number of system extensions in a conference	Outside lines available for other extension to use
Console	1	1	2
	1	2	1
	2	1	1
	2	2	0
Deskset	1	1	3
	1	2	3
	2	1	2
	2	2	2

B. Join a call in progress

Device that starts a conference call	Number of outside calls in a conference	Number of system extensions joined in a conference	Outside lines available for other extension to use
Console/Deskset	1	1	2
		2	1
		3	0

Intercom

You can use the intercom feature for conversations between the console and a system deskset, or between two system desksets.

The console and each deskset in the telephone system **MUST** be assigned a unique extension number for the intercom feature to work. The assignment is done when the console is initially set up.

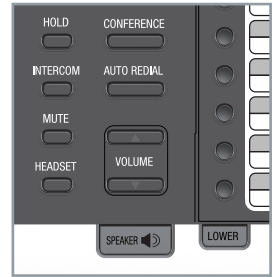

Make an intercom call to an extension

1. Press **INTERCOM** on the console when it is idle.
2. Press **▲** or **▼** to scroll to a desired extension, then press **MENU/SELECT**.

-OR-

Use the dialing keys to dial the extension number.

3. The console displays **Intercom to: XX** (**XX** represents the extension number of the destination device).

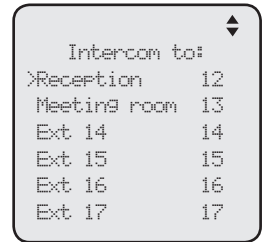

NOTES:

- Before the intercom call is answered, you can cancel the intercom by pressing **SPEAKER** or **CANCEL**.
- You cannot intercom an extension that is on a call.
- If all four telephone lines are in use, the intercom feature is not available.

Answer an intercom call

When you receive an intercom call, you hear a ringing tone and your screen displays **Intercom from: XX** (**XX** represents the extension number of the calling device). Lift the handset or press **SPEAKER** to answer.

End an intercom call

Place the handset back to the console or press **SPEAKER** if you are using the speakerphone.

Answer an incoming call during an intercom call

If you receive an incoming outside call during an intercom call, there is an alert tone.

To answer the call, press the corresponding line key (**LINE 1-LINE 4**). The intercom call ends automatically.

Call transfer

You can transfer a call to any other system telephone. Once you transfer a call, it can be answered by any system telephone, not just at the extension you called.



Blind transfer

While on a call, you can transfer a call directly without notifying the desired extension:

1. Press **TRANSFER** on the console while on a call, the call is put on hold.
2. Press **▲** or **▼** to scroll to the desired extension, then press **MENU/SELECT**.

-OR-

Use the dialing keys to dial the extension number.

3. The destination device rings. Choose either option below.
 - Answer the call by lifting the corded handset or pressing **SPEAKER** .
 - You can resume the call by pressing the corresponding flashing line key (**LINE 1-LINE 4**) on the console before the destination device answers the call.
4. Put the handset on the console or press **SPEAKER**  to hang up.

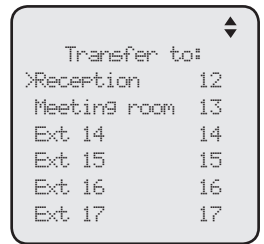
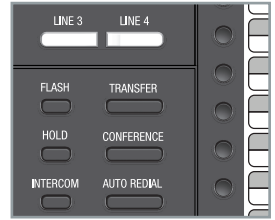

NOTES:

- If you transfer a call to an extension that does not exist, the call ends.
- The transferred call will only ring on the destination extension for three minutes.
- The extension which initiated the transfer can retrieve the call within 10 minutes after the call has been transferred by pressing the corresponding line key.
- The transferred call ends if the destination extension doesn't answer after 10 minutes.

Call transfer using intercom

Transfer a call and speak to the receiving party

You can transfer a call and speak to the receiving party before completing the transfer while on a call:

1. Press **INTERCOM** on the console while on a call. The call is put on hold.
2. Press **▲** or **▼** to scroll to a desired extension, then press **MENU/SELECT**.

-OR-

Use the dialing keys to dial the extension number.

3. The destination extension rings and the call can be answered by lifting the handset or pressing **SPEAKER** . You can now talk to the destination party privately.
4. Press **TRANSFER** to transfer the call to the destination extension. The console returns to idle.

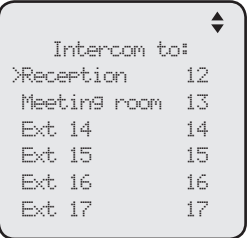

Intercom to:	
>Reception	12
Meeting room	13
Ext 14	14
Ext 15	15
Ext 16	16
Ext 17	17

One touch

This telephone has 32 one- and two-touch memory locations (speed dial locations) where you can store the phone numbers you wish to dial more quickly. You can store up to 30 digits in each location.

You can access the first 16 locations using only the one-touch buttons. To access the remaining 16 locations, press **LOWER** and then the one-touch button for the desired location. You might wish to write the names or telephone numbers of the one-touch entries on the directory card, using the light gray spaces for the upper 16 locations and the white spaces for the lower 16 locations.

Assign a one-touch entry

Use the following steps to program the one-touch keys.

1. When the console is idle, press **MENU/SELECT**.
2. Press **▲** or **▼** to scroll to **One Touch**, then press **MENU/SELECT** or **▶/SKIP**.
3. Press **▲** or **▼** to scroll to **Program**, then press **MENU/SELECT** or **▶/SKIP**.
4. The screen displays **Enter Number:**
5. Use the dialing keys to enter a telephone number (up to 30 digits).
 - Press **DELETE** to delete a digit.
 - Press **◀/REPEAT** or **▶/SKIP** to move the cursor to the left or right.
 - You can include a pause while storing a dialing sequence that requires one during actual dialing. Press **▲** or **▼** to choose **◆Add pause**, then press **MENU/SELECT**. A **P** appears on the screen.
 - Store a signal for switching to temporary tone signaling. If you have dial pulse (rotary) service, this signal is required for some special services. Press **▲** or **▼** to choose **◆Send tone**, then press **MENU/SELECT**. A **T** appears on the screen. All numbers you enter after this will send touch-tone signals during dialing.

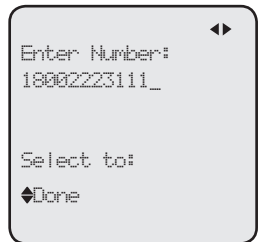
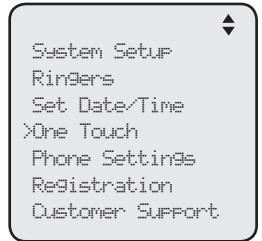

One touch

Assign a one-touch entry (continued)

- You can store the flash signal required by some special services as part of a dialing sequence. Press ▲ or ▼ to choose **◆Add flash**, then press **MENU/SELECT**. An **F** appears on the screen. Continue storing the number as usual.
6. Press ▲ or ▼ to choose **◆Done**, then press **MENU/SELECT** to save the setting and return to the previous menu. To exit without making changes, press ▲ or ▼ to choose **◆Cancel**, then press **MENU/SELECT**, or press **CANCEL** to return to the previous menu.
 7. The screen displays **Press a 1-touch key to save the number**.
 8. Press the desired one-touch key to store the telephone number in the upper location.
-OR-
Press **LOWER**, then press the desired one-touch key to store the telephone number in the lower location.
 9. The screen displays **Number saved to 1-touch key** briefly, and then **One Touch #XX** (X represents the one-touch location) and the telephone number.



NOTE: If the one-touch location already has an assigned number, the screen displays **Replace 1-touch key memory?** Press **MENU/SELECT** to replace the old number with the new one.

Press a
1-touch key
to save the
number

One Touch #18
18002223111

◀ Edit ▶

One touch

Review the one-touch entry

1. When the console is idle, press **MENU/SELECT**.
2. Press ▲ or ▼ to scroll to **One Touch**, then press **MENU/SELECT** or ►/SKIP.
3. Press ▲ or ▼ to scroll to **View**, then press **MENU/SELECT** or ►/SKIP.
4. Press ▲ or ▼ to scroll to the desired one-touch location. The screen displays the One-touch location number and the telephone number.



To dial a one-touch entry

When the console is idle, press the desired one-touch button for the destination party in the upper location.

-OR-

When the console is idle, press **LOWER** then press the one-touch button for the destination party in the lower location.

The console dials the one-touch number using the speakerphone.

Edit the one-touch key

1. When the console is idle, press **MENU/SELECT**.
2. Press ▲ or ▼ to scroll to **One Touch**, then press **MENU/SELECT** or ►/SKIP.
3. Press ▲ or ▼ to scroll to **View**, then press **MENU/SELECT** or ►/SKIP.
4. Press ▲ or ▼ to scroll to the desired one-touch location.
5. Press **MENU/SELECT** to select **Edit**.
6. The screen displays **Edit Number**: Use the dialing keys to edit the number.
 - Press **DELETE** to delete a digit.
 - Press ◀/REPEAT or ►/SKIP to move the cursor to the left or right.
 - You can include a pause while storing a dialing sequence that requires one during actual dialing. Press ▲ or ▼ to choose ♦Add pause, then press **MENU/SELECT**. A **P** appears on the screen.

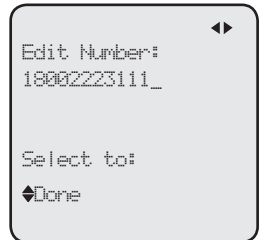

One touch

Edit the one-touch key (continued)

- Store a signal for switching to temporary tone signaling. If you have dial pulse (rotary) service, this signal is required for some special services. Press ▲ or ▼ to choose ♦**Send tone**, then press **MENU/SELECT**. A **T** appears on the screen. All numbers you enter after this will send touch-tone signals during dialing.
 - You can store the flash signal required by some special services as part of a dialing sequence. Press ▲ or ▼ to choose ♦**Add flash**, then press **MENU/SELECT**. An **F** appears on the screen. Continue storing the number as usual.
7. Press ▲ or ▼ to scroll to ♦**Done**, then press **MENU/SELECT** to save the setting.

Delete an one-touch key

1. When the console is idle, press **MENU/SELECT**.
2. Press ▲ or ▼ to scroll to **One Touch**, then press **MENU/SELECT** or ►/**SKIP**.
3. Press ▲ or ▼ to scroll to **View**, then press **MENU/SELECT** or ►/**SKIP**.
4. Press ▲ or ▼ to scroll to the desired one-touch location.
5. Press ►/**SKIP** to scroll to **Delete**, then press **MENU/SELECT**. The screen displays **Delete memory?**
6. Press **MENU/SELECT** to confirm. To exit without making changes, press **CANCEL**.



About the directory

Use the directory to store names and phone numbers. Directory entries are not shared with other extensions. The console and each deskset have their own directories.

Capacity

The directory of this console can store up to 50 entries, with a maximum of 15 alphanumeric characters (including spaces) for names and 30 digits for telephone numbers. A convenient search feature can help you quickly find and dial numbers (page 64).

If there are already 50 entries, the screen shows **Directory memory full**. You cannot store a new number until you delete one. If you try to view the directory when there are no entries, the screen displays **Directory empty**.

Exit the directory

On the console, press **CANCEL** to cancel an operation and return to previous screen.

Create directory entries

Create a new directory entry

Use the following steps to store a name and number in the directory.

1. When the console is idle, press **DIRECTORY**.
2. The console shows a summary with the number of directory entries stored. Press **MENU/SELECT** to add an entry.
3. The screen displays **Enter Name**. Use the dialing keys to enter the name (up to 15 characters). Each time you press a key, the character on that key appears. When entering a name in the directory, the first letter of each word is automatically capitalized. Additional key presses produce other characters on that key. See the chart below.



Dialing keys	Characters by number of key presses										
	1	2	3	4	5	6	7	8	9	10	11
1	1	.	-		()	*	#	&	/	,
2	a	b	c	A	B	C	2				
3	d	e	f	D	E	F	3				
4	g	h	i	G	H	I	4				
5	j	k	l	J	K	L	5				
6	m	n	o	M	N	O	6				
7	p	q	r	s	P	Q	R	S	7		
8	t	u	v	T	U	V	8				
9	w	x	y	z	W	X	Y	Z	9		
0	Space	0									
*											
#											

- Press **DELETE** to delete a character.
 - Press **◀/REPEAT** or **▶/SKIP** to move the cursor to the left or right.
 - Press **0** to add a space.
4. Press **MENU/SELECT** to save. The screen displays **Enter Number**. Use the dialing keys to enter the number (up to 30 digits).
 - Press **DELETE** to delete a digit.
 - Press **◀/REPEAT** or **▶/SKIP** to move the cursor to the left or right.



Create directory entries

Create a new directory entry (continued)

- You can include a pause while storing a dialing sequence that requires one during actual dialing. Press ▲ or ▼ to choose **◆Add pause**, then press **MENU/SELECT**. A **P** appears on the screen.
 - Store a signal for switching to temporary tone signaling. If you have dial pulse (rotary) service, this signal is required for some special services. Press ▲ or ▼ to choose **◆Send tone**, then press **MENU/SELECT**. A **T** appears on the screen. All numbers you enter after this will send touch-tone signals during dialing.
 - You can store the flash signal required by some special services as part of a dialing sequence. Press ▲ or ▼ to choose **◆Add flash**, then press **MENU/SELECT**. An **F** appears on the screen.
5. Press ▲ or ▼ to scroll to **Done**, then press **MENU/SELECT**. To exit without making changes, press **CANCEL**, or press ▲ or ▼ to scroll to **Cancel**, then press **MENU/SELECT**.



Review directory entries

1. When the console is idle, press **DIRECTORY**. The screen displays a summary with the number of directory entries stored.
2. Press ▲ or ▼ to browse through the directory. Entries appear alphabetically by the first letter in the name.
3. Press **CANCEL** to cancel an operation and return to idle mode.



Search directory

Search by name

Follow the steps below to search for directory entries on the console.

1. Press **DIRECTORY** on the console. The screen displays a summary with the number of directory entries stored.
2. Press **▲** or **▼** to **browse through the directory**.
3. When a name appears, press the dial pad keys (**2-9**) to start a name search.
 - The directory shows the first name beginning with the first letter associated with the dial pad key, if there is an entry in the directory beginning with that letter. If there is no entry matching the letter you press, it remains in the current entry.
4. To see other names starting with the letters on the same dial pad key, keep pressing the key. The names appear in alphabetical order.
For example, if you have the names **Jennifer**, **Jessie**, **Kevin** and **Linda** in your directory:
 - If you press **5 (JKL)** once, you see **Jennifer**.
 - If you press **5 (JKL)** twice, you see **Kevin**.
 - If you press **5 (JKL)** three times, you see **Linda**.
 - To view **Jessie**, press **▼** while **Jennifer** is displayed.

Dial, delete or edit entries

You can dial, delete or edit a directory entry (name and number) when it is shown on the console screen. You can use the directory review (page 63) or name search (page 64) to show an entry.

Display dial

When a number is displayed on the screen, you can dial the number by lifting the corded handset, or pressing **SPEAKER** or the desired line key (**LINE 1-LINE 4**).

Delete an entry

1. When a directory entry appears, press **MENU/SELECT**.
2. Press **▲** or **▼** to choose **Delete**, then press **MENU/SELECT**.
3. The console displays **Delete contact?** Press **MENU/SELECT** to confirm.

-OR-

When a directory entry appears, press **DELETE**, then press **MENU/SELECT** to confirm.



Dial, delete or edit entries

Edit an entry

- When a directory entry appears, press **MENU/SELECT**.
- Press **▲** or **▼** to choose **Edit**, then press **MENU/SELECT**.
- The screen displays **Enter Name**. Use the dialing keys to edit the name. If you only want to edit the number, skip to step 4.
 - Press **DELETE** to delete a character.
 - Press **◀/REPEAT** or **▶/SKIP** to move the cursor to the left or right.
- Press **MENU/SELECT** to save. The screen displays **Enter Number**. Use the dialing keys to edit the number.
 - Press **DELETE** to delete a digit.
 - Press **◀/REPEAT** or **▶/SKIP** to move the cursor to the left or right.
 - You can include a pause while storing a dialing sequence that requires one during actual dialing. Press **▲** or **▼** to choose **◆Add pause**, then press **MENU/SELECT**. A **P** appears on the screen.
 - Store a signal for switching to temporary tone signaling. If you have dial pulse (rotary) service, this signal is required for some special services. Press **▲** or **▼** to choose **◆Send tone**, then press **MENU/SELECT**. A **T** appears on the screen. All numbers you enter after this will send touch-tone signals during dialing.
 - You can store the flash signal required by some special services as part of a dialing sequence. Press **▲** or **▼** to choose **◆Add flash**, then press **MENU/SELECT**. An **F** appears on the screen. Continue storing the number as usual.
- Press **▲** or **▼** to scroll to **◆Done**, then press **MENU/SELECT**. To exit without making changes, press **CANCEL**, or press **▲** or **▼** to scroll to **Cancel**, then press **MENU/SELECT**.



Dial, delete or edit entries

Copy a directory entry to one touch

1. When a directory entry appears, press **MENU/SELECT**.
2. Press **▲** or **▼** to choose **Copy to 1-touch**, then press **MENU/SELECT**.
3. The screen displays **Enter Number**. Use the dialing keys to edit the number.
 - Press **DELETE** to delete a digit.
 - Press **◀/REPEAT** or **▶/SKIP** to move the cursor to the left or right.
 - You can include a pause while storing a dialing sequence that requires one during actual dialing. Press **▲** or **▼** to choose **◆Add pause**, then press **MENU/SELECT**. A **P** appears on the screen.
 - Store a signal for switching to temporary tone signaling. If you have dial pulse (rotary) service, this signal is required for some special services. Press **▲** or **▼** to choose **◆Send tone**, then press **MENU/SELECT**. A **T** appears on the screen. All numbers you enter after this will send touch-tone signals during dialing.
 - You can store the flash signal required by some special services as part of a dialing sequence. Press **▲** or **▼** to choose **◆Add flash**, then press **MENU/SELECT**. An **F** appears on the screen. Continue storing the number as usual.
4. Press **▲** or **▼** to scroll to **◆Done**, then press **MENU/SELECT**.
5. The console displays **Press a 1-touch key to save the number**.
 - Press the one-touch button for the destination party in the upper location.
-OR-
 - Press **LOWER**, then press the one-touch button for the destination party in the lower location.
6. The console displays **Number saved to 1-touch key**.

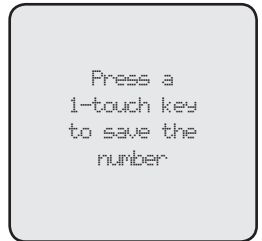

About the caller ID

This telephone supports caller ID services that most telephone service providers offer. Caller ID allows you to see the name, number, date and time of calls. Depending on your service subscription, you might see the caller's number, or the caller's name and number from the telephone service provider after the first or second ring. Caller ID information might not be available for every incoming call. Callers may intentionally block their names and/or telephone numbers.

This product can provide information only if both you and the caller are in areas offering caller ID service and if both telephone service providers use compatible equipment.

Information about caller ID with call waiting

Caller ID with call waiting lets you see the name and telephone number of the caller before answering the telephone, and while on another call.

It might be necessary to change telephone service to use this feature. Contact your telephone service provider if:

- You have both caller ID and call waiting, but as separate services (you might need to combine these services).
- You only have caller ID service, or only call waiting service.
- You do not subscribe to caller ID or call waiting services.

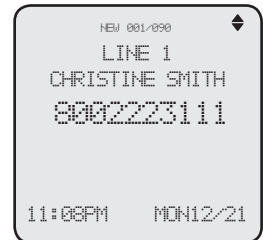

There are fees for caller ID services. In addition, services may not be available in all areas.

This product can provide information only if both you and the caller are in areas offering caller ID service and if both telephone service providers use compatible equipment. The time and date, along with the call information, are from the telephone service provider.



NOTES:

- You can use this product with regular caller ID service, or you can use this product's other features without subscribing to caller ID or combined caller ID with call waiting service.
- The format of telephone numbers displayed depends on the home area code you set (See **Home area code** on page 36 for explanations and instructions on area code settings).

Caller ID information

How the caller ID information (call log) works

The telephone stores caller ID information for the last 200 incoming calls in the console. Entries are stored in reverse chronological order. The telephone deletes the oldest entry when the log is full to make room for new calls.

Each extension has independent caller ID information. Deleting the caller ID information on any one extension does not affect the caller ID information on other extensions.

If you answer a call before the information appears on the screen, it does not show in the caller ID information.

Review the caller ID information to determine who called, to easily return the call, or to copy the caller's name and number into your directory or one-touch memory.



The time and date of the call and the caller's name and telephone number are included in the display.

Caller ID information appears on the screen as the telephone rings, or until the caller hangs up, or until the call has been answered at another extension, or until the call ends.

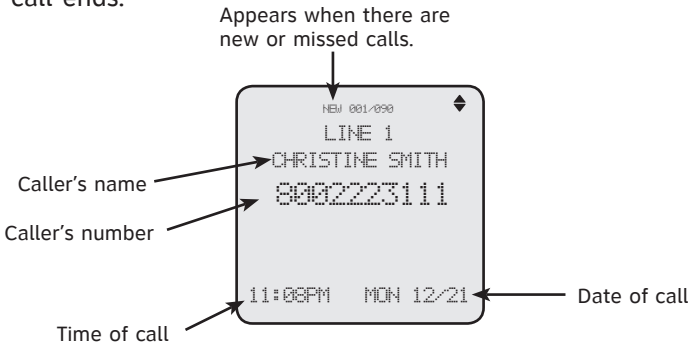

If you subscribe to caller ID service, this phone automatically resets the time and date using the caller ID information from the first incoming call after initial setup, or each time the power resumes after a power outage.

NOTES:

- The caller ID information might not be available for every incoming call. Callers might intentionally block their names and/or telephone numbers.
- Each entry can store up to 30 digits for the telephone number and 15 characters for the name.

Caller ID operation

Memory match

If the incoming telephone number is an exact match with a telephone number in your directory, the name that appears on the screen matches the corresponding name in your directory.

For example, if Christine Smith calls, her name appears as Chris if this is how you entered it into your directory.

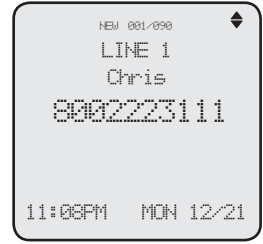

i NOTE: The number you see on your caller ID is in the format from the telephone service provider. It usually delivers 10-digit telephone numbers (area code plus telephone number). The telephone system ignores the area code when searching for a match and displays the name of the first corresponding number from the directory.

Missed (new) calls indicator

When there are new or missed calls and you try to review the caller ID log by pressing **CALL HISTORY**, the screen shows **XX New call(s)**.

All new or missed entries are counted as new calls. Each time you review a call history entry with the icon **NEW**, the number of missed calls decreases by one. When all the entries in the caller ID information become old (have been reviewed), the system removes the missed calls alert from the display, and the **NEW** indicator turns off.

Review the caller ID information

1. When the console is idle, press **CALL HISTORY**. The console displays **XX New calls** (the number of missed call) and **XX calls** (the total number of missed calls and reviewed calls).
2. Press **▲** or **▼** to review the caller ID information. The caller ID entries are stored in reverse chronological order starting with the most recent entry.
3. To exit without making changes, press **CANCEL**.



Caller ID operation

View dialing options

Although the incoming call history entries have 10 digits (the area code plus the seven-digit number), in some areas, you may need to dial the seven digits only, 1 plus the seven digits, or 1 plus the area code plus the seven digits. You can change and store the number of digits that you dial in the call history.

While reviewing the call history, press # (pound key) repeatedly on the console to show different dialing options for local and long distance numbers before dialing or saving the telephone number in the directory.

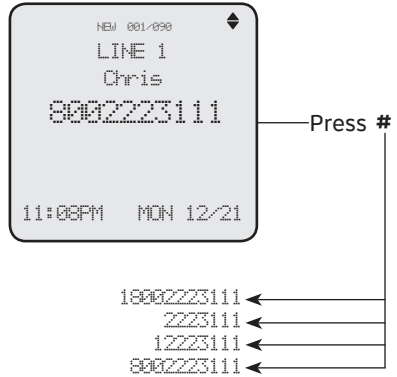

Dial a call history entry

1. When in the caller ID history, press ▲ or ▼ to browse the number you wish to call.
2. Lift the handset or press **SPEAKER** .

-OR-

To override automatic line selection, press the desired line key (**LINE 1-LINE 4**) then lift the handset to call.

Caller ID operation

Save a caller ID entry to the directory

- When in the caller ID history, press ▲ or ▼ to browse to the number you wish to save.
- Press **MENU/SELECT**, then press ▲ or ▼ to choose **Copy to DIR**.
- Press **MENU/SELECT**. The screen displays **Enter Name**. Use the dialing keys to edit the name.
 - Press **DELETE** to delete a character.
 - Press ◀/**REPEAT** or ▶/**SKIP** to move the cursor to the left or right.
- Press **MENU/SELECT** to save. The screen displays **Enter Number**. Use the dialing keys to edit the number.
 - Press **DELETE** to delete a digit.
 - Press ◀/**REPEAT** or ▶/**SKIP** to move the cursor to the left or right.
 - You can include a pause while storing a dialing sequence that requires one during actual dialing. Press ▲ or ▼ to choose **Add pause**, then press **MENU/SELECT**. A **P** appears on the screen.
 - Store a signal for switching to temporary tone signaling. If you have dial pulse (rotary) service, this signal is required for some special services. Press ▲ or ▼ to choose **Send tone**, then press **MENU/SELECT**. A **T** appears on the screen. All numbers you enter after this will send touch-tone signals during dialing.
 - You can store the flash signal required by some special services as part of a dialing sequence. Press ▲ or ▼ to choose **Add flash**, then press **MENU/SELECT**. An **F** appears on the screen. Continue storing the number as usual.
- Press ▲ or ▼ to scroll to **Done**, then press **MENU/SELECT**. To exit without making changes, press **CANCEL**, or press ▲ or ▼ to scroll to **Cancel**, then press **MENU/SELECT**.



i NOTE: You will need to change how a caller ID number is dialed if the entry does not appear in the correct format. Caller ID numbers might appear with an area code that might not be necessary for local calls, or without a 1 that may be necessary for long distance calls (see **View dialing options** on the previous page for more information).

Caller ID operation

Copy a caller ID entry to one touch

1. When the desired number appears, press **MENU/SELECT**.
2. Press **▲** or **▼** to choose **Copy to 1-touch**, then press **MENU/SELECT**.
3. The console displays **Press a 1-touch key to save the number**.
 - Press the one-touch button for the destination party in the upper location.**-OR-**
 - Press **LOWER**, then press the one-touch button for the destination party in the lower location.
4. The console displays **Number saved to 1-touch key**.



Delete entries

To delete a call history entry:

1. When in the caller ID history, press **▲** or **▼** to scroll to the number you wish to delete.
2. Press **DELETE** to delete the shown entry from the caller ID history.
3. The screen displays **Caller ID deleted**.



-OR-

1. When in the caller ID history, press **▲** or **▼** to scroll to the desired number you wish to delete.
2. Press **MENU/SELECT**, then press **▲** or **▼** to choose **Delete**.
3. Press **MENU/SELECT**, the screen displays **Caller ID deleted**.



To delete all caller ID history entries:

1. When the console is idle, press **CALL HISTORY**.
2. Press **DELETE**. The screen displays **All calls deleted**, then returns to the idle screen.

Reasons for missing caller ID information

Reasons for missing caller ID information

There are also occasions when other information or no information shows for various reasons:

On-screen message	Reason
PRIVATE NAME	The caller prefers not to show the name.
PRIVATE NUMBER	The caller prefers not to show the phone number.
PRIVATE CALLER	The caller prefers not to show the phone number and name.
UNKNOWN NAME	Your telephone service provider cannot determine the caller's name.
UNKNOWN NUMBER	Your telephone service provider cannot determine the caller's number.
UNKNOWN CALLER	No information is available about this caller.

About the answering system

The answering system of this console has two mailboxes, namely the central (auto attendant) mailbox and private mailbox.

The auto attendant can be used to answer calls, record messages, direct incoming calls to other system extensions, or enter the remote access menu. You can also leave messages in the private mailbox if the caller has diverted the call to this console but nobody picks up. The auto attendant feature must be turned on for all these features to work.

If the auto attendant feature is off, the console will not answer any incoming calls and the caller cannot leave messages in both central and private mailboxes.

Only this MS2085 console can serve as an auto attendant in the telephone system and redirect incoming call to other extensions in the system.

Answering system capacity

You can record up to four outgoing announcements and a directory announcement for the auto attendant, and one announcement for the private mailbox of this console. Each announcement can be up to 75 seconds.

The maximum message recording time of the console is 60 minutes. This includes 40 minutes for the central mailbox and 20 minutes for the private mailbox. The actual recording time depends on individual message characteristics. Messages remain available for review until you delete them.

If the system memory is full, you cannot record new messages until old ones have been deleted. Check the remaining recording time frequently to maintain availability of space for incoming messages.



NOTE: You cannot record announcement when the telephone system is out of space.

Message Guard®

The answering system protects the recorded messages from loss in the event of a power failure.

Auto attendant setup

You can set up the auto attendant to answer outside calls, provide callers with a company directory, direct calls to a specified extension, and enable callers to record voice messages. You can use the default announcement or record up to four outgoing announcements and one directory announcement. For details on how to use the auto attendant features, see the **Auto attendant operation** on page 89 of this user's manual.

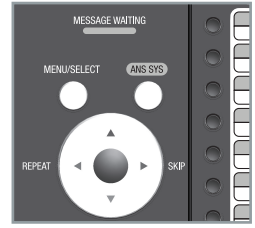

Auto attendant on/off

You can turn the auto attendant on or off. The screen displays **Auto Att: ON** when the auto attendant is turned on.

1. When the console is idle, press **ANS SYS**.
2. Press **▲** or **▼** to scroll to **Auto Attendant**, then press **MENU/SELECT** or **▶/SKIP**.
3. Press **▲** or **▼** to scroll to **Auto ATT ON/OFF**, then press **MENU/SELECT** or **▶/SKIP**.
4. Press **▲** or **▼** to choose **On** or **Off**.
5. Press **MENU/SELECT** or **▶/SKIP** to save the setting.



Auto attendant delay

Use this feature to choose how long this console rings before the auto attendant picks up a call.

1. When the console is idle, press **ANS SYS**.
2. Press **▲** or **▼** to scroll to **Auto Attendant**, then press **MENU/SELECT** or **▶/SKIP**.
3. Press **▲** or **▼** to scroll to **Auto ATT Delay**, then press **MENU/SELECT** or **▶/SKIP**.
4. Press **▲** or **▼** to choose the desired time (**6 seconds** to **30 seconds**).
5. Press **MENU/SELECT**.



Auto attendant setup

Announcement

Use this feature to record up to four new announcements so that you can have different announcements for daytime and after hours, and an announcement for the company directory. You can easily switch among the recorded announcements. Each announcement can be up to 75 seconds.

You can record three announcements for daytime recording (**Day OGM**), one announcement for after hours recording (**Night OGM**) and a directory announcement (**Directory OGM**) in which you can record an extension list of your company.

The system has three default announcements:

Day OGM - *“Thank you for calling our company. If you know your party’s extension, you may dial it at any time. For a company directory, please dial 0. To leave a message, please dial 9.”*

Night OGM - *“Thank you for calling our company. We are currently closed. If you would like to leave a message and you know your party’s extension, you may dial it now. For a company directory, please dial 0. To leave a message, please dial 9.”*

Directory OGM - *“Please enter the extension number.”*

If you have many extensions, record a separate extension list in the **Directory OGM** menu item and reference it in your auto attendant announcement as shown in **Sample announcement 1** below. If you have only a few extensions, you can list them in the auto attendant announcement as shown in **Sample announcement 2** below without the separate extension list.

Sample announcement 1: *“Hello, you have reached XYZ Corp. Please enter your party’s extension. To hear a list of extensions, dial 0.”*

Sample announcement 2: *“Hello, you have reached XYZ Corp. For sales, press 12; for service, press 13; for shipping, press 14; or press 15 for the receptionist.”*

Auto attendant setup

Record the auto attendant announcement

To record the announcement:

1. When the console is idle, press **ANS SYS**.
2. Press ▲ or ▼ to scroll to **Auto Attendant**, then press **MENU/SELECT** or ►/SKIP.
3. Press ▲ or ▼ to scroll to **Announcement**, then press **MENU/SELECT** or ►/SKIP.
4. Press ▲ or ▼ to choose **Day OGM 1**, **Day OGM 2**, **Day OGM 3**, **Night OGM** or **Directory OGM**, then press **MENU/SELECT** or ►/SKIP.
5. Press ▲ or ▼ to scroll to **Record**, then press **MENU/SELECT** or ►/SKIP.
6. Facing the console, record your announcement. The screen displays **Record OGM** and the time elapsed. Press **MENU/SELECT** to select **STOP** to stop recording.



Auto attendant setup

Set the start and end time of auto attendant announcement

To set the start and end time of announcement:

1. When the console is idle, press **ANS SYS**.
2. Press **▲** or **▼** to scroll to **Auto Attendant**, then press **MENU/SELECT** or **▶/SKIP**.
3. Press **▲** or **▼** to scroll to **Announcement**, then press **MENU/SELECT** or **▶/SKIP**.
4. Press **▲** or **▼** to choose **Day OGM 1**, **Day OGM 2**, **Day OGM 3** or **Night OGM**, then press **MENU/SELECT** or **▶/SKIP**.
5. Press **▲** or **▼** to scroll to **Start/End Time**, then press **MENU/SELECT** or **▶/SKIP**.
6. Press **▲** or **▼** to scroll to the item you want to edit, and press the dialing keys (**01-12**) to enter the correct digit.
7. Press **◀/REPEAT** or **▶/SKIP** to select **AM** or **PM**.
8. Press **MENU/SELECT** to save the setting.

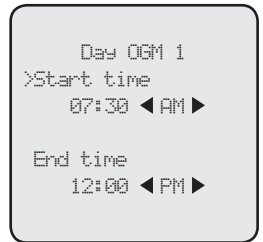

For the auto attendant to answer the call at anytime, you must make sure that you set the start time of next announcement as same as the end time of your previous announcement. For example, **Day OGM 1** is set to end at 05:00 PM, the start time of **Day OGM 2**, **Day OGM 3** or **Night OGM** should be set as 05:00 PM.

Auto attendant setup

Play the auto attendant announcement

To play the announcement:

1. When the console is idle, press **ANS SYS**.
2. Press ▲ or ▼ to scroll to **Auto Attendant**, then press **MENU/SELECT** or ►/SKIP.
3. Press ▲ or ▼ to scroll to **Announcement**, then press **MENU/SELECT** or ►/SKIP.
4. Press ▲ or ▼ to choose **Day OGM 1, Day OGM 2, Day OGM 3, Night OGM** or **Directory OGM**, then press **MENU/SELECT** or ►/SKIP.
5. Press ▲ or ▼ to scroll to **Play**, then press **MENU/SELECT** or ►/SKIP.
6. The screen displays **Play OGM** and the time elapsed. During playback, press ◀/REPEAT or ►/SKIP to choose **STOP**, then press **MENU/SELECT**.



Reset the auto attendant announcement

To reset the announcement:

1. During playback, press ◀/REPEAT or ►/SKIP to choose **RESET**, then press **MENU/SELECT**. The screen displays **Reset XXX OGM to default announcement?**
2. Press **MENU/SELECT** to confirm.

-OR-

1. When the console is idle, press **ANS SYS**.
2. Press ▲ or ▼ to scroll to **Auto Attendant**, then press **MENU/SELECT** or ►/SKIP.
3. Press ▲ or ▼ to scroll to **Announcement**, then press **MENU/SELECT** or ►/SKIP.
4. Press ▲ or ▼ to choose **Day OGM 1, Day OGM 2, Day OGM 3, Night OGM** or **Directory OGM**, then press **MENU/SELECT** or ►/SKIP.
5. Press ▲ or ▼ to scroll to **Reset**, then press **MENU/SELECT**. The screen displays **Reset XXX OGM to default announcement?**
6. Press **MENU/SELECT** to confirm.

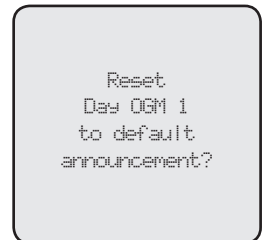

Auto attendant setup

Reset auto attendant

Use this feature to reset the auto attendant settings and announcements to default.

1. When the console is idle, press **ANS SYS**.
2. Press ▲ or ▼ to scroll to **Auto Attendant**, then press **MENU/SELECT** or ►/SKIP.
3. Press ▲ or ▼ to scroll to **Reset Auto ATT**, then press **MENU/SELECT** or ►/SKIP.
4. The screen displays **Reset Auto Attendant to default settings?** Press **MENU/SELECT** to confirm.
5. The screen displays **Auto Attendant is reset to default.**

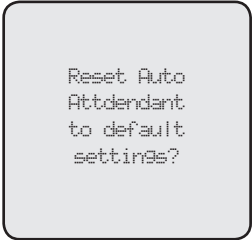

Private mailbox setup

This console has a private mailbox that can answer calls and record messages when the auto attendant and private mailbox are turned on.

When the auto attendant picks up a call, the caller has to enter the extension number of this console to access the private mailbox. The private mailbox answers the call after the ring delay time you set in the **Private mailbox delay** section below.

Private mailbox on/off

You can turn the private mailbox on or off. The console displays **MB** when the private mailbox is set to **On**.

1. When the console is idle, press **ANS SYS**.
2. Press ▲ or ▼ to scroll to **Private Mailbox**, then press **MENU/SELECT** or ►/SKIP.
3. Press ▲ or ▼ to scroll to **Priv MB ON/OFF**, then press **MENU/SELECT** or ►/SKIP.
4. Press ▲ or ▼ to choose **On** or **Off**.
5. Press **MENU/SELECT**.



Private mailbox delay

Use this feature to choose how long this phone rings before the private mailbox picks up a call.

1. When the console is idle, press **ANS SYS**.
2. Press ▲ or ▼ to scroll to **Private Mailbox**, then press **MENU/SELECT** or ►/SKIP.
3. Press ▲ or ▼ to scroll to **Priv MB Delay**, then press **MENU/SELECT** or ►/SKIP.
4. Press ▲ or ▼ to choose the desired time (**12** seconds to **40** seconds).
5. Press **MENU/SELECT**.

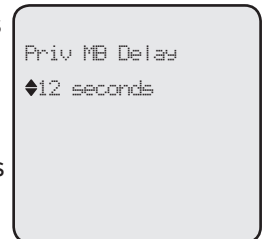

Private mailbox setup

Announcement

An announcement plays when calls are answered by the private mailbox. The system has a default announcement, *“Hello, please leave a message after the tone.”* You can use this announcement or record your own.

You can record an announcement up to 75 seconds.

To record the announcement:

1. When the console is idle, press **ANS SYS**.
2. Press **▲** or **▼** to scroll to **Private Mailbox**, then press **MENU/SELECT** or **▶/SKIP**.
3. Press **▲** or **▼** to scroll to **Announcement**, then press **MENU/SELECT** or **▶/SKIP**.
4. Press **▲** or **▼** to scroll to **Record**, then press **MENU/SELECT** or **▶/SKIP**.
5. Facing the console, record your announcement. The screen displays **Record OGM** and the time elapsed. Press **◀/REPEAT** or **▶/SKIP** to select **STOP**, then press **MENU/SELECT** to stop recording.

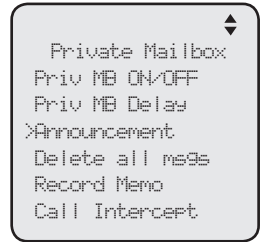

i **NOTE:** Announcements shorter than two seconds are not recorded.

To play an announcement:

1. When the console is idle, press **ANS SYS**.
2. Press **▲** or **▼** to scroll to **Private Mailbox**, then press **MENU/SELECT** or **▶/SKIP**.
3. Press **▲** or **▼** to scroll to **Announcement**, then press **MENU/SELECT** or **▶/SKIP**.
4. Press **▲** or **▼** to scroll to **Play**, then press **MENU/SELECT** or **▶/SKIP**.
5. The screen displays **Play OGM** and the time elapsed. During playback, press **◀/REPEAT** or **▶/SKIP** to select **STOP**, then press **MENU/SELECT** to stop the announcement, or select **PLAY**, then press **MENU/SELECT** to replay the announcement.



Private mailbox setup

To reset the announcement:

1. During playback, press ◀/REPEAT or ▶/SKIP to select **RESET**, then press MENU/SELECT to reset the announcement to default. The screen displays **Reset announcement to default?**
2. Press MENU/SELECT to confirm.

-OR-

1. When the console is idle, press **ANS SYS**.
2. Press ▲ or ▼ to scroll to **Private Mailbox**, then press MENU/SELECT or ▶/SKIP.
3. Press ▲ or ▼ to scroll to **Announcement**, then press MENU/SELECT or ▶/SKIP.
4. Press ▲ or ▼ to scroll to **Reset**, then press MENU/SELECT or ▶/SKIP. The screen displays **Reset announcement to default?**
5. Press MENU/SELECT to confirm.



Private mailbox setup

Call intercept

When a caller is leaving a message on your private mailbox, you can stop the recording and talk to the caller by pressing the corresponding line key (**LINE 1-LINE 4**). Choose whether private incoming messages can be intercepted by the console during recording.

1. When the console is idle, press **ANS SYS**.
2. Press ▲ or ▼ to scroll to **Private Mailbox**, then press **MENU/SELECT** or ►/SKIP.
3. Press ▲ or ▼ to scroll to **Call Intercept**, then press **MENU/SELECT** or ►/SKIP.
4. Press ▲ or ▼ to choose **On** or **Off**.
5. Press **MENU/SELECT** to save the setting and return to the previous menu. To exit without making changes, press **CANCEL**.

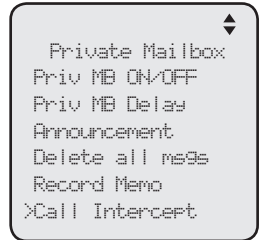

Answering system setup

All feature settings below apply to both central (auto attendant) and private mailboxes.

Remote access code

Use this code to select a three-digit number to allow remote access of the answering system from another telephone. You can change the code to any number from **000-999**. This code is **333** by default.

1. When the console is idle, press **ANS SYS**.
2. Press **▲** or **▼** to scroll to **Ans Sys Setup**, then press **MENU/SELECT** or **▶/SKIP**.
3. Press **▲** or **▼** to scroll to **Remote Code**, then press **MENU/SELECT** or **▶/SKIP**.
4. The screen displays **Remote Code**. Use the dialing keys to enter a three-digit remote code.
 - Press **DELETE** to delete a digit.
 - Press **◀/REPEAT** or **▶/SKIP** to move the cursor to the left or right.
5. Press **MENU/SELECT** to save the setting and return to the previous menu. To exit without making changes, press **CANCEL**.

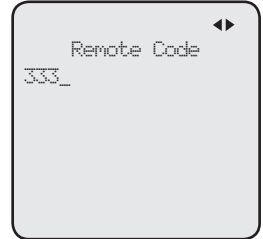
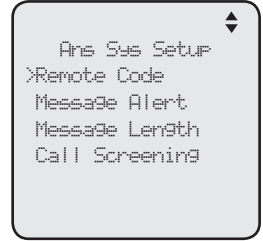

Message alert

Use this feature to turn the audible message alert on or off.

If the message alert tone is on, the console beeps every 30 seconds when there are messages in the central mailbox and/or private mailbox.

1. When the console is idle, press **ANS SYS**.
2. Press **▲** or **▼** to scroll to **Ans Sys Setup**, then press **MENU/SELECT** or **▶/SKIP**.
3. Press **▲** or **▼** to scroll to **Message Alert**, then press **MENU/SELECT** or **▶/SKIP**.
4. Press **▲** or **▼** to choose **On** or **Off**.
5. Press **MENU/SELECT** to save the setting and return to the previous menu. To exit without making changes, press **CANCEL**.

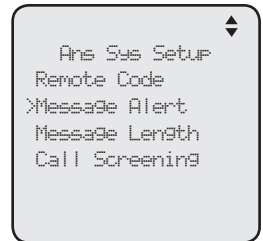

Answering system setup

Message Length

Use this feature to set the maximum length of each recorded message.

If you choose **Greeting only**, the caller hears the selected announcement but is not able to record a message. If you choose **1 minute**, **2 minutes** or **3 minutes**, the caller can record a message up to that specific time period. If you choose **Unlimited**, the caller can record a message of any length, up to the remaining time for all messages and memos.

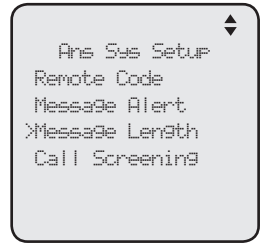

1. When the console is idle, press **ANS SYS**.
2. Press ▲ or ▼ to scroll to **Ans Sys Setup**, then press **MENU/SELECT** or ►/SKIP.
3. Press ▲ or ▼ to scroll to **Message Length**, then press **MENU/SELECT** or ►/SKIP.
4. Press ▲ or ▼ to choose **Greeting only**, **1 minute**, **2 minutes**, **3 minutes**, or **Unlimited**.
5. Press **MENU/SELECT** to save the setting and return to the previous menu. To exit without making changes, press **CANCEL**.

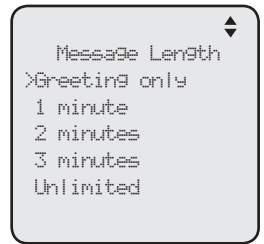

Call screening

Use this feature to choose whether incoming messages can be heard over the speaker when they are being recorded. If you turn call screening on, you hear the incoming message on your console when a call comes in.

1. When the console is idle, press **ANS SYS**.
2. Press ▲ or ▼ to scroll to **Ans Sys Setup**, then press **MENU/SELECT** or ►/SKIP.
3. Press ▲ or ▼ to scroll to **Call Screening**, then press **MENU/SELECT** or ►/SKIP.
4. Press ▲ or ▼ to choose **On** or **Off**.
5. Press **MENU/SELECT** to save the setting and return to the previous menu. To exit without making changes, press **CANCEL**.

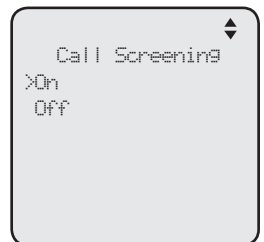
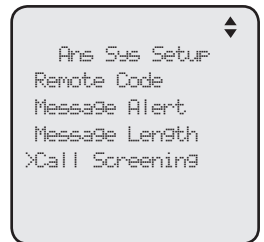

Answering system setup

Recording time

Use this feature to check the remaining recording time in the system.

1. When the console is idle, press **ANS SYS**.
2. Press ▲ or ▼ to scroll to **Record Time**, then press **MENU/SELECT** or ►/**SKIP**.
3. Press **CANCEL** to return to the previous menu.



Auto attendant operation

Using the auto attendant

When auto attendant is on, it automatically picks up the ringing line after the delay time you programmed (see **Auto attendant delay** on page 76), and plays the appropriate auto attendant announcement. You can choose from one of the following options.

- Enter the extension number you want to call after the auto attendant announcement is played. The system plays, *"Calling that extension, Please wait."*
 - ◇ If the private mailbox of the destination extension is off and it does not pick up after around 18 seconds, the system announces, *"That extension is not answering. Enter a new extension number, or, to leave a central message in the general mailbox, please dial 9."*
 - ◇ If the private mailbox on the destination extension is on and the call is not picked up after the programmed delay time (See **Private mailbox delay** on page 82), the extension announces, *"Hello, please leave a message after the tone,"* then you can record a private message in that extension mailbox.
- Press **9#** to enter the central mailbox and leave a message.
- Press **0#** to play the directory announcement. The caller can enter the desired extension number anytime during the directory announcement is being played.
- Enter the remote access code when the auto attendant announcement is being played to access the answering system remotely.

If the caller does not enter a command after around 12 seconds, the call will be directed back to the console. If the call is not picked up after 60 seconds, the auto attendant answers the call and plays the auto attendant announcement again. The console repeats this process three times. If the caller still does not enter a command after the third attempt, the auto attendant drops the call.



NOTE: Incoming messages shorter than two seconds are not recorded.

Auto attendant operation

Auto attendant (AA) flow chart

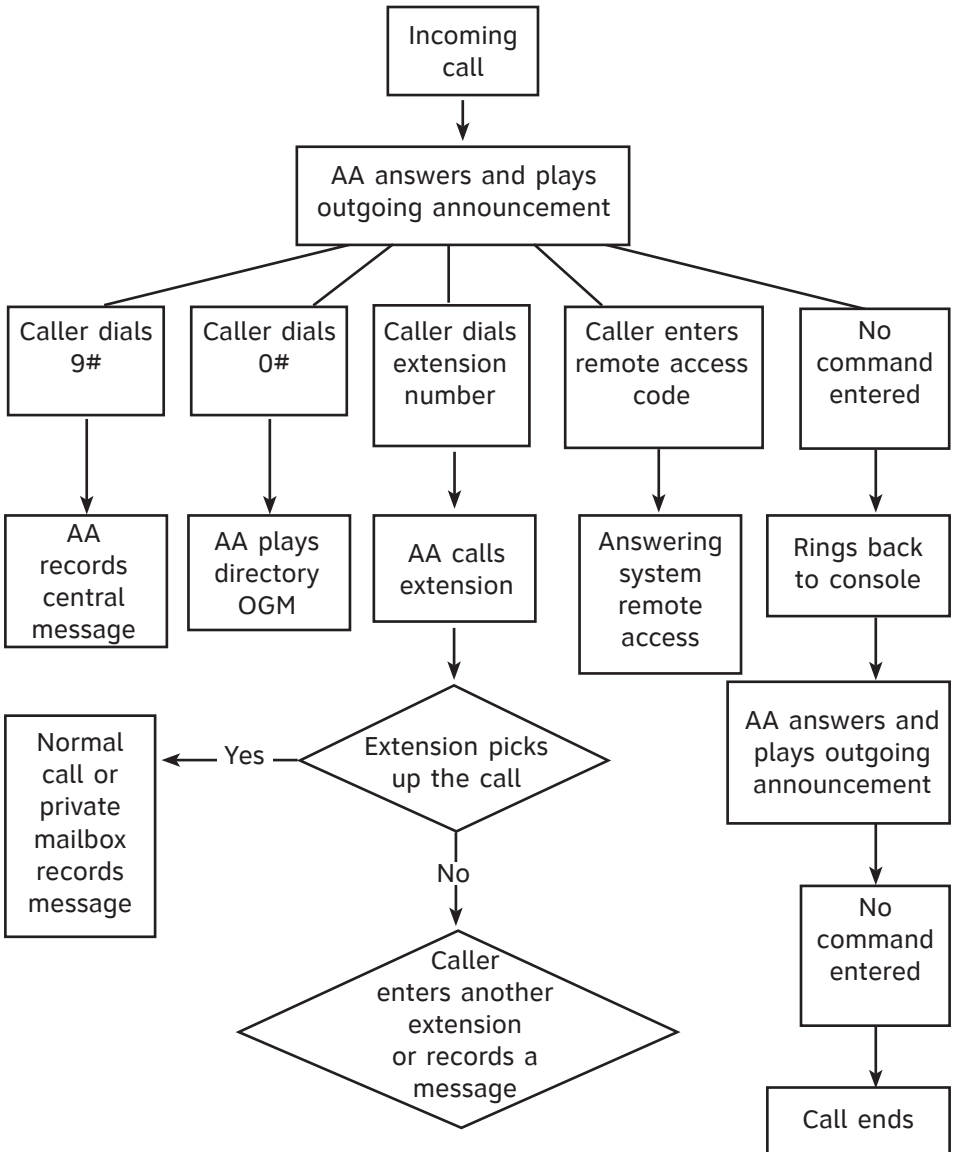

Answering system operation

New message indication

The  icon displays on the console when there are new messages in the central mailbox.

The  icon displays on the console when there are new messages and/or memos in the private mailbox.

The **MESSAGE WAITING** indicator on the console flashes when there are messages in either the central or private mailbox.

Call screening

If the answering system and call screening are turned on (see **Call screening** on page 87), the announcement and the incoming message broadcast at the console when a call arrives. During message recording, press **▲/VOLUME** or **VOLUME/▼** to adjust the volume.

Call intercept

When a caller is leaving a message on your central or private mailbox, you can stop the recording and talk to the caller by pressing the corresponding line key (**LINE 1-LINE 4**). This feature is enabled for the central mailbox by default. For the private mailbox, you can turn this feature on or off (see page 85).

Message playback

From the console, you can play the messages in both the central and private mailboxes.

You can choose to play the new messages only or play all messages (new messages and old messages).

Before playing each message, the system announces the date and time of the recording. After the last message, you hear, *"End of the messages."*

To listen to messages in the mailbox:

1. While the console is idle, press **ANS SYS**.
2. Press **▲** or **▼** to choose **Play Messages**, then press **MENU/SELECT** or **▶/SKIP**.
3. Press **▲** or **▼** to choose **Central Mailbox** or **Private Mailbox**, then press **MENU/SELECT** or **▶/SKIP**.
4. Press **▲** or **▼** to choose **Play new msgs** to play the new messages only or **Play all msgs** to play all the messages in the mailbox.
5. Press **MENU/SELECT** or **▶/SKIP** to play the messages.
6. The system announces the number of messages, date and time the message received, then starts playing the messages. If there are no messages in the mailbox, the system announces, *"No new messages."* if you have chosen **Play new msgs**, or *"No messages."* if you have chosen **Play all msgs**.

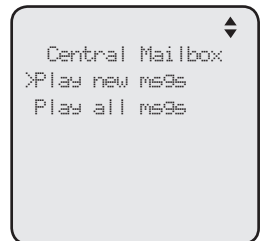

Answering system operation

Options during playback

When a message is playing, you can adjust the playback volume, skip, repeat, or delete the message.

When a message is playing on the console:

- Press ▲/**VOLUME** or **VOLUME**/▼ to adjust the message playback volume.
- Press ►/**SKIP** after the date and time announcement to skip to the next message.
- Press ◀/**REPEAT** to repeat the current message. Immediately press ◀/**REPEAT** after the date and time announcement to hear the previous message.
- Press ▲ or ▼ to scroll to **Stop**, then press **MENU/SELECT** to stop the message playback, or select **Start**, then press **MENU/SELECT** to start the message playback.
- Press **DELETE** after the date and time announcement to delete the message. The system announces "Message deleted."

Delete all central mailbox messages

Use this feature to delete all messages stored in the central mailbox.

1. When the console is idle, press **ANS SYS**.
2. Press ▲ or ▼ to scroll to **Auto Attendant**, then press **MENU/SELECT** or ►/**SKIP**.
3. Press ▲ or ▼ to scroll to **Delete all msgs**, then press **MENU/SELECT** or ►/**SKIP**.
4. The screen displays **Delete all messages?** Press **MENU/SELECT** to confirm. The screen displays **All messages are deleted**. To exit without making changes, press **CANCEL**.



Answering system operation

Delete all private mailbox messages

You can use this feature to delete all messages stored in the private mailbox.

1. When the console is idle, press **ANS SYS**.
2. Press **▲** or **▼** to scroll to **Private Mailbox**, then press **MENU/SELECT** or **▶/SKIP**.
3. Press **▲** or **▼** to scroll to **Delete all msgs**, then press **MENU/SELECT** or **▶/SKIP**.
4. The screen displays **Delete all messages?** Press **MENU/SELECT** to confirm. The screen displays **All messages are deleted**.



Record memo

Memos are messages you record as reminders for yourself. Play and delete them the same way as incoming messages.

1. When the console is idle, press **ANS SYS**.
2. Press **▲** or **▼** to scroll to **Private Mailbox**, then press **MENU/SELECT** or **▶/SKIP**.
3. Press **▲** or **▼** to scroll to **Record Memo**, then press **MENU/SELECT** or **▶/SKIP**.
4. Facing the console, record your memo. The screen displays **Record memo** and the time elapsed. Press **◀/REPEAT** or **▶/SKIP** to select **STOP**, then press **MENU/SELECT** to stop recording.



NOTE: Memos shorter than two seconds are not recorded.

Remote access

Use this feature to reach your answering system remotely by calling any telephone line connected this console from any touch-tone telephone. Make sure the auto attendant feature is turned on for this feature to work. Remote access can only play messages stored in the private mailbox.

To remotely reach the answering system:

1. Dial any telephone line connected to this console from any touch-tone telephone.
2. When the system answers, enter the three-digit remote access code (**333** is the default code; see **Remote access code** on page 86 to change it).
3. You can enter the following remote commands.

Remote commands:

1	Press to play new messages in the private mailbox.
1*	Press to play all messages in the private mailbox.
2	Press within three seconds of the message playing to go back to the previous message. Press after three seconds of the message playing to repeat the message currently playing.
3	Press to skip the current message (during playback).
41	Press to play the auto attendant announcement Day OGM 1 . <ul style="list-style-type: none"> • Press 9 to record and wait for the beep before speaking. • Press # to stop recording.
42	Press to play the auto attendant announcement Day OGM 2 . <ul style="list-style-type: none"> • Press 9 to record and wait for the beep before speaking. • Press # to stop recording.
43	Press to play the auto attendant announcement Day OGM 3 . <ul style="list-style-type: none"> • Press 9 to record and wait for the beep before speaking. • Press # to stop recording.
5	Press to play the auto attendant announcement Night OGM . <ul style="list-style-type: none"> • Press 9 to record and wait for the beep before speaking. • Press # to stop recording.
6	Press to play current auto attendant directory announcement. <ul style="list-style-type: none"> • Press 9 to record and wait for the beep before speaking. • Press # to stop recording.

Remote access

7	Press to play current private mailbox announcement. <ul style="list-style-type: none">• Press 9 to record and wait for the beep before speaking.• Press # to stop recording.
8	Press to stop the playing message.
9	Press to start recording a memo. <ul style="list-style-type: none">• Press # to stop recording.
0	Press to turn the private mailbox on or off.
#	Press during a message playback to delete current message.
X	Press to delete all messages.

4. Hang up to end the call.







Cut out the remote access wallet card at the back of this user’s manual for quick reference.



NOTES:

- If you do not enter a valid remote access code, the auto attendant announces, *“The system does not recognize that extension. Please check it, and enter it again”*.
- If you do not enter any remote access command after you enter the remote access menu successfully, the answering system announces, *“Remote operation”* after 10 seconds. The call ends when the announcement is repeated three times.
- If the memory is full, the system announces, *“Memory is full”* when you try to record a memo by pressing 9. You cannot record new memo until some old messages in the mailboxes are deleted. Check the system remaining space frequently to maintain availability of space (page 88).

Console screen icons

L1 L2 L3 L4	Telephone lines - On when this console is selected under the corresponding line group setting. Flashes when line 1, line 2, line 3, or line 4 is put on hold.
	Ringer off - On steadily when the ringer volume is set to OFF .
	Headset - On steadily when using a corded headset.
	Speakerphone - On steadily when using the speakerphone.
MUTE	Mute - Microphone is muted.
PRIV	Call privacy - On steadily when the call privacy feature is set to On .
REC	Record a call - On steadily when recording a call.
	New private mailbox message - New message in the private mailbox.
	Private mailbox on - The private mailbox is turned on.
	New central mailbox message - New message in the central mailbox.
NEW	New caller ID log - Missed and new calls.

Alert tones and lights

Alert tones

One beep	You have set the hold reminder on. -OR- You have set the message alert tone on. -OR- There is an incoming call waiting.
Two beeps	The telephone is recording a memo.

Lights

LINE 1/LINE 2/LINE 3/LINE 4

- On when the telephone line is in use.
- Flashes when the telephone line is on hold.
- Flashes quickly when there is an incoming call or a transfer call.

MESSAGE WAITING

- Flashes when there are new private or central messages.

ANS SYS

- On when the private mailbox is on.
- Flashes when the auto attendant is answering or directing calls.
- Flashes when the answering system is playing or recording announcements or messages.

INTERCOM

- On when the console is on an intercom call.
- Flashes when there is an incoming intercom call.

MUTE

- On with the microphone is muted.

HEADSET

- On when the corded headset is in use.



HOLD

- Flashes when a telephone line is on hold.

SPEAKER

- On when the speakerphone is on.

Troubleshooting

If you have difficulty with your telephone, please try the suggestions below. For customer service, visit our website at **www.telephones.att.com** or call **1 (800) 222-3111**. In Canada, dial **1 (866) 288-4268**.

The console fails to obtain an IP from the router.

- Make sure your router is properly installed and plugged into the Ethernet network.
- Make sure the DHCP server is enabled on your router, so that it can allocate IP automatically.
- You may need to enter a static IP to the console. Refer to **Network setup** on page 28 for details.

The console displays Check Network.

- Make sure your console is connected to the router properly.
- If you have set a static IP manually, you need to reboot the console to apply the new setting.
- Your router may have reassigned a new IP address to the console. Reboot the console to update.
- Your Ethernet cable may be defective. Try installing a new one.



My telephone base doesn't work at all.

- Make sure the power cord is securely plugged in.
- Make sure you plug the telephone line cords securely and firmly into the console and the telephone wall jacks.
- Make sure you plug the Ethernet cable securely and firmly into the console and a router.
- Refer to **Console installation** on pages 7-11 to reset the system. Allow at least one minute for the console to reset.
- This system is not compatible with any other AT&T 4-line small business telephones, except for the MS2015 telephone.

There is no dial tone.

- First try all the suggestions above.
- Make sure you plug the handset cord securely and firmly into the  jack on the telephone base and the corded handset.
- If the previous suggestions do not work, disconnect the telephone line from the console and connect it to a different telephone. If there is no dial tone on that telephone either, the problem is in your wiring or local service. Contact your telephone service provider.

Troubleshooting

- Your telephone line cords or Ethernet cable might be defective. Try installing new ones.
- Make sure a line is selected. Press a line key (**L1-L4**) or **SPEAKER** .
- If there is no dial tone when you press **HEADSET**, make sure the corded headset is firmly connected to the  jack.

I cannot dial out.

- First try all the suggestions above.
- Make sure you have a dial tone before dialing. The corded handset might take a second or two to connect the console and produce a dial tone. This is normal. Wait an extra second before dialing.
- Make sure the telephone is set to the correct dial mode (pulse dial or tone dial) for the service in your area. Refer to **Dial mode** on page 38 to set the dial mode.
- If the other telephones in your building are having the same problem, contact your telephone service provider.

My computer can't connect to the network after plugging the Ethernet cable through the PC jack ().

- Make sure the console is connected to power. The PC jack () does not work when the console does not have power source or during a power outage.
- Make sure you plug the Ethernet cable connecting to the router into the Ethernet jack and the Ethernet cable connecting to the computer into the PC jack.

The network connection speed on my computer drops significantly after plugging the Ethernet cable through the PC jack ().

- If you are using Gigabit Ethernet system, the connection speed drops to 100M after plugging the Ethernet cable through the PC jack ().

I cannot make intercom calls.

- Make sure you choose the correct extension.
- The destination telephone might be on an external call. Wait and try again.
- Make sure the **INTERCOM** light is off before you make an intercom call. If the light is on, the system is busy or the intercom is unavailable. Try again when the intercom light goes off.
- Check to make sure that each system extension has a unique extension number. Refer to **Set extension number** on page 24 for details.
- You cannot use intercom when all four outside lines are in use.

Troubleshooting

I cannot transfer outside calls.

- If you are on a conference call with another telephone in the same system, the call cannot be transferred.
- If the destination telephone is on an outside call or intercom call with another system telephone, the call cannot be transferred.
- Check to make sure that each system extension has a unique extension number. Refer to **Set extension number** on page 24 for details.
- The destination party is busy, try again later.

I cannot join a conversation in progress.

- The call privacy feature prevents another set on the system from interrupting a conversation. Make sure you turn off call privacy during a call. See **Call privacy** on page 45.

I hear a double-beep sound every 30 seconds.

- There is a call on hold at this extension. Press and release the **LINE** key of the call on hold to return to the call and turn off the reminder beep.

Operation during a power failure.

- This phone operates with limited features during a power failure. You are able to make and answer calls using the corded handset only. No other features available until power is restored. All feature settings and memory are retained during a power failure.

The console display screen is blank.

- Make sure the power cord is connected to both the console and an electrical outlet not controlled by a wall switch.

My calls fade in and out while I'm using my corded handset.

- If you have a corded headset plugged into the telephone, try unplugging it and firmly plugging it in again.
- Disconnect the console from the modular jack and plug in another corded telephone. If calls are still not clear, the problem is probably in the wiring or local service. Contact your local service company (charges may apply).
- If you are using the speakerphone when this problem occurs, eliminate any background noise. Noise from the television, radio, or other appliances might cause the speakerphone to cut in and out. Try engaging the **MUTE** button when you are not speaking or eliminating the background noise.

Troubleshooting

I hear other calls while using my telephone.

- Disconnect the telephone line from the console, and plug it into a different telephone. If you still hear other calls, call your telephone service provider.

My console does not ring when I receive a call.

- Make sure that the ringer is not off. Refer to **Ringer volume** on page 32 in this user's manual.
- Make sure the telephone line cords, power cord and Ethernet cable are plugged in securely.
- Make sure the system is properly set up. Refer to **Console installation** on pages 7-11 for details.
- If the other telephones in your building are having the same problem, contact your telephone service provider.
- Test a working telephone at the telephone jack. If another telephone has the same problem, contact your telephone service provider.
- The telephone line cord might be defective. Try installing a new line cord.
- Make sure that the Line group assignment is correct. See **Line group** on page 27 for more details.

My caller ID isn't working.

- Caller ID is a subscription service. You must subscribe to this service from your telephone service provider for this feature to work on your telephone base.
- The caller must be calling from an area that supports caller ID.
- Both your and your caller's telephone service providers must use caller ID compatible equipment.
- Make sure the area codes are set correctly on the console. See **Home area code** on page 36 for details.
- If you subscribe to high-speed Internet service (DSL - digital subscriber line) through your telephone lines, you must install a DSL filter between each telephone line cord and telephone wall jack. The filter prevents noise and caller ID problems resulting from DSL interference. Please contact your DSL service provider for more information about DSL filters.

System does not receive caller ID when on a call.

- Make sure you subscribe to caller ID with call waiting features from your telephone service provider. Caller ID feature works only if both you and the caller are in areas offering caller ID service, and if both telephone service providers use compatible equipment.

Troubleshooting

The outgoing announcement is not clear.

- When recording the announcement, make sure you speak in a normal tone of voice about nine inches from the console.
- Make sure there is no background noise (television, music, traffic, etc.) when recording.

The auto attendant does not record messages.

- Make sure the auto attendant is turned on (page 76).
- Make sure the memory of the answering system is not full. Please refer to the **Recording time** on page 88 in the user's manual. If the memory is full, the system announces "*Memory full*" and then hangs up. You need to delete some old messages in order to make room for new messages.
- If **Greeting only** is selected in the **Message length** menu (page 87), the answering system only plays the outgoing announcement. It does not record incoming message.

The auto attendant announcement is not correct.

- Make sure the day/night announcements are set up and recorded (page 78).
- Make sure that the DAY and NIGHT times that you entered are appropriate. See **Set the start and end time of auto attendant announcement** on page 79.

The auto attendant does not respond when callers dial an extension.

- Make sure directory announcement is recorded correctly to suit your company's needs (page 78).
- Make sure the caller is calling from a touch-tone telephone. If the caller hears clicks rather than tones, the commands are not recognized.
- The auto attendant might not detect the callers' commands when the announcement plays. Wait until the announcement is over before entering the code.
- There might be interference on the telephone line callers are using. Press the dial pad keys firmly when dialing.

Troubleshooting

The answering system is recording incomplete messages.

- If the message length is not set to unlimited and a caller leaves a very long message, part of it may be lost when the system disconnects the call after the set message length. See **Message Length** on page 87 for details.
- If the caller pauses for longer than seven seconds, the system stops recording and disconnects the call.
- If the system's memory becomes full during message recording, the system stops recording and disconnects the call.
- If the caller's voice is very soft, the system may stop recording and disconnect the call.

I have difficulty hearing messages.

- Press **▲/VOLUME** to increase the speaker volume on the console.

The answering system does not respond to remote access commands.

- Make sure you are using the correct remote access code (page 86).
- Make sure you are calling from a touch-tone telephone (away from home). When dialing a number, you should hear tones. If you hear clicks, then it is not a touch-tone telephone and cannot activate the answering system.
- The answering system might not detect the remote access code when your announcement is playing. Wait until the announcement is over before entering the code.
- There might be interference on the telephone line you are using. Press the dial pad keys firmly when dialing.

I subscribe to a nontraditional telephone service that uses my computer to establish connections, and my telephone doesn't work.

- Make sure your computer is powered on.
- Make sure your Internet connection is working properly.
- Make sure that the software is installed and running for your nontraditional telephone service.
- Make sure to plug your USB telephone adapter into a dedicated USB port on your computer. Do not plug it into a multiple port USB hub (USB splitter) that is not powered.
- In a few rare instances, the USB port on your computer may not have enough power. Try using a USB hub with its own external power supply.
- If you are using a firewall, it may prevent access to your nontraditional telephone service provider. Contact your service provider for more information.

Troubleshooting

Common cure for electronic equipment.

If the telephone base does not seem to be responding normally, do the following (in the order listed):

1. Disconnect the power from the console.
2. Wait a few minutes.
3. Connect power to the console.
4. Wait for the console to synchronize its connection. This will take at least one minute to finish.

Console display screen messages

All messages are deleted	All messages in the central mailbox are erased. All messages in the private mailbox are erased.
Auto Att: ON	The auto attendant is on.
Auto Attendant is reset to default	The auto attendant settings are reset to default settings.
Call History EMPTY	There are no entries in the caller ID history.
Caller ID deleted	A caller ID history is deleted.
Check network	The console or deskset is not connected to the network.
Contact saved to Directory	A number is saved to the directory.
DECT Headset registered	The cordless headset registration was successful.
DECT Headset deregistered	The cordless headset is deregistered from the telephone system.
Directory empty	There are no directory entries.
Directory memory full	The directory is full. You cannot save new entries unless you delete some current entries.
Ended	You have just ended a call.
Extension busy. Please try again later	The deskset extension is on a call.
Intercom	The console is on an intercom call.
Intercom from:	There is an intercom call coming in.
Intercom to:	The console is making an intercom call.

Console display screen messages

Line is not available at this time	The telephone line cord is not plugged into the console. The line you are trying to reach is on a conference call. Call privacy is turned on on the line you are trying to reach.
Line X	The telephone line X is in use.
Line X Incoming call	There is an incoming call from Line X.
No answer. Please try again later	The destination extension does not answer the intercom call.
No IP assigned. Check network.	There is no IP assigned to the console.
Number already saved	The telephone number you have entered is already stored in the directory.
Number saved to 1-touch key	The number is saved to the one-touch memory.
Obtain IP from DHCP server?	The console will obtain an IP address from the DHCP server.
Phone is set to default	All settings in the console are reset to default settings.
Redial deleted	A redial list entry is deleted.
Redial empty	The redial list is empty.
Registering DECT Headset...	The console is registering a cordless headset.
System busy. Please try again later	All telephone lines are in use.

Console display screen messages

Transfer from:	There is a transferred call from a deskset extension.
Transfer Line X to:	The console is transferring a call to a deskset extension.
Unable to obtain IP, Please check DHCP server.	The console is unable to obtain an IP address. You may need to check the DHCP server.
XX New calls	There are new calls in the caller ID history.

Maintenance

Taking care of your telephone

- Your telephone base contains sophisticated electronic parts, so you must treat it with care.
- Avoid rough treatment.
- Place the corded handset down gently.
- Save the original packing materials to protect your telephone base if you ever need to ship it.

Avoid water

- You can damage your telephone base if it gets wet. Do not use the corded handset in the rain, or handle it with wet hands. Do not install the telephone base near a sink, bathtub or shower.

Electrical storms

- Electrical storms can sometimes cause power surges harmful to electronic equipment. For your own safety, take caution when using electric appliances during storms.

Cleaning your telephone

- Your telephone base has a durable plastic casing that should retain its luster for many years. Clean it only with a soft cloth slightly dampened with water or a mild soap.
- Do not use excess water or cleaning solvents of any kind.

Remember that electrical appliances can cause serious injury if used when you are wet or standing in water. If the telephone base should fall into water, **DO NOT RETRIEVE IT UNTIL YOU UNPLUG THE POWER CORD AND TELEPHONE LINE CORDS FROM THE WALL**, then pull the unit out by the unplugged cords.

Important safety information



This symbol is to alert you to important operating or servicing instructions that may appear in this user's manual. Always follow basic safety precautions when using this product to reduce the risk of injury, fire, or electric shock.

Safety information

- Read and understand all instructions in the user's manual. Observe all markings on the product.
- Avoid using a telephone during a thunderstorm. There may be a slight chance of electric shock from lightning.
- Do not use the telephone to report a gas leak in the vicinity of the leak. Under certain circumstances, a spark may be created when the adapter is plugged into the power outlet, or when the handset is replaced in its cradle. This is a common event associated with the closing of any electrical circuit. The user should not plug the phone into a power outlet, and should not put a charged handset into the cradle, if the phone is located in an environment containing concentrations of flammable or flame-supporting gases, unless there is adequate ventilation. A spark in such an environment could create a fire or explosion. Such environments might include: medical use of oxygen without adequate ventilation; industrial gases (cleaning solvents; gasoline vapors; etc.); a leak of natural gas; etc.
- Do not use this product near water, or when you are wet. For example, do not use it in a wet basement or shower, or next to a swimming pool, bathtub, kitchen sink, or laundry tub. Do not use liquids or aerosol sprays for cleaning. If the product comes in contact with any liquid, unplug any line or power cord immediately. Do not plug the product back in until it has dried thoroughly.
- Install this product in a protected location where no one can trip over any line or power cords. Protect cords from damage or abrasion.
- If this product does not operate normally, see the **Troubleshooting** section on pages 98-104 of this user's manual. If you cannot solve the problem, or if the product is damaged, refer to the **Limited warranty** section on pages 113-114. Do not open this product except as directed in your user's manual. Opening the product or reassembling it incorrectly may expose you to hazardous voltages or other risks.
- Replace backup battery only as described in your user's manual. Do not burn or puncture batteries — they contain caustic chemicals.
- This power adapter is intended to be correctly oriented in a vertical or floor mount position. The prongs are not designed to hold the plug in place if it is plugged into a ceiling, an under-the-table or cabinet outlet.



Caution: Use only the power adapter provided with this product. To obtain a replacement, visit our website at www.telephones.att.com or call **1 (800) 222-3111**. In Canada, dial **1 (866) 288-4268**.

Important safety information

Especially about cordless telephones

- **Electrical power:** The telephone base must be connected to a working electrical outlet. The electrical outlet should not be controlled by a wall switch. Calls cannot be made from the handset if the telephone base is unplugged, switched off or if the electrical power is interrupted.
- **Power adapter:** The power adapter is intended to be correctly oriented in a vertical or floor mount position. The prongs are not designed to hold the plug in place if it is plugged into a ceiling, under-the-table or cabinet outlet.

Precautions for users of implanted cardiac pacemakers

Cardiac pacemakers (applies only to digital cordless telephones):

Wireless Technology Research, LLC (WTR), an independent research entity, led a multidisciplinary evaluation of the interference between portable wireless telephones and implanted cardiac pacemakers. Supported by the U.S. Food and Drug Administration, WTR recommends to physicians that:

Pacemaker patients

- Should keep wireless telephones at least six inches from the pacemaker.
- Should NOT place wireless telephones directly over the pacemaker, such as in a breast pocket, when it is turned ON.
- Should use the wireless telephone at the ear opposite the pacemaker.

WTR's evaluation did not identify any risk to bystanders with pacemakers from other persons using wireless telephones.

Especially about telephone answering systems

Two-way recording: This unit does not sound warning beeps to inform the other party that the call is being recorded. To ensure that you are in compliance with any federal or state regulations regarding recording a telephone call, you should start the recording process and then inform the other party that you are recording the conversation.

SAVE THESE INSTRUCTIONS

FCC part 68 and ACTA

This equipment complies with Part 68 of the FCC rules and with technical requirements adopted by the Administrative Council for Terminal Attachments (ACTA). The label on the back or bottom of this equipment contains, among other things, a product identifier in the format US: AAAEQ##TXXXX. This identifier must be provided to your telephone service provider upon request.

The plug and jack used to connect this equipment to premises wiring and the telephone network must comply with the applicable Part 68 rules and technical requirements adopted by ACTA. A compliant telephone cord and modular plug is provided with this product. It is designed to be connected to a compatible modular jack that is also compliant. An RJ11 jack should normally be used for connecting to a single line and an RJ14 jack for two lines. See Installation Instructions in the user's manual.

The Ringer Equivalence Number (REN) is used to determine how many devices you may connect to your telephone line and still have them ring when you are called. The REN for this product is encoded as the 6th and 7th characters following the US: in the product identifier (e.g., if ## is 03, the REN is 0.3). In most, but not all areas, the sum of all RENs should be five (5.0) or less. For more information, please contact your telephone service provider.

This equipment may not be used with Party Lines. If you have specially wired alarm dialing equipment connected to telephone line, ensure the connection of this equipment does not disable your alarm equipment. If you have questions about what will disable the alarm equipment, consult your telephone service provider or a qualified installer.

If this equipment is malfunctioning, it must be unplugged from the modular jack until the problem has been corrected. Repairs to this telephone equipment can only be made by the manufacturer or its authorized agents. For repair procedures, follow the instructions outlined under the Limited Warranty.

If this equipment is causing harm to the telephone network, the telephone service provider may temporarily discontinue your telephone service. The telephone service provider is required to notify you before interrupting service. If advance notice is not practical, you will be notified as soon as possible. You will be given the opportunity to correct the problem and the telephone service provider is required to inform you of your right to file a complaint with the FCC. Your telephone service provider may make changes in its facilities, equipment, operation, or procedures that could affect the proper functioning of this product. The telephone service provider is required to notify you if such changes are planned.

If this product is equipped with a corded or cordless handset, it is hearing aid compatible.

If this product has memory dialing locations, you may choose to store emergency telephone numbers (e.g., police, fire, medical) in these locations. If you do store or test emergency numbers, please:

Remain on the line and briefly explain the reason for the call before hanging up.

Perform such activities in off-peak hours, such as early morning or late evening.

Industry Canada

Operation is subject to the following two conditions: (1) this device may not cause harmful interference, and (2) this device must accept any interference, including interference that may cause undesired operation.

The term "IC:" before the certification/registration number only signifies that the Industry Canada technical specifications were met.

The Ringer Equivalence Number (REN) for this terminal equipment is 0.1. The REN is an indication of the maximum number of devices allowed to be connected to a telephone interface. The termination on an interface may consist of any combination of devices subject only to the requirement that the sum of the RENs of all the devices does not exceed five.

This product meets the applicable Industry Canada technical specifications.

FCC part 15

This equipment has been tested and found to comply with the limits for a Class A digital device, pursuant to Part 15 of the FCC Rules. These limits are designed to provide reasonable protection against harmful interference when the equipment is operated in a commercial environment. This equipment generates, uses, and can radiate radio frequency energy and, if not installed and used in accordance with the instruction manual, may cause harmful interference to radio communications. Operation of this equipment in a residential area is likely to cause harmful interference in which case the user will be required to correct the interference at his own expense.

This Class A digital apparatus complies with Canadian ICES-003.

Cet appareil numérique de la classe A est conforme à la norme NMB-003 du Canada.

Limited warranty

The AT&T brand is used under license - any repair, replacement or warranty service, and all questions about this product should be directed to: In the United States of America, visit **www.telephones.att.com** or call **1 (800) 222-3111**. In Canada, call **1 (866) 288-4268**.

1. What does this limited warranty cover?

The manufacturer of this AT&T-branded product warrants to the holder of a valid proof of purchase (“CONSUMER” or “you”) that the product and all accessories provided in the sales package (“PRODUCT”) are free from defects in material and workmanship, pursuant to the following terms and conditions, when installed and used normally and in accordance with the PRODUCT operating instructions. This limited warranty extends only to the CONSUMER for products purchased and used in the United States of America and Canada.

2. What will be done if the PRODUCT is not free from defects in materials and workmanship during the limited warranty period (“materially defective PRODUCT”)?

During the limited warranty period, the manufacturer’s authorized service representative will repair or replace at the manufacturer’s option, without charge, a materially defective PRODUCT. If the manufacturer repairs the PRODUCT, they may use new or refurbished replacement parts. If the manufacturer chooses to replace the PRODUCT, they may replace it with a new or refurbished PRODUCT of the same or similar design. The manufacturer will retain defective parts, modules, or equipment. Repair or replacement of the PRODUCT, at the manufacturer’s option, is your exclusive remedy. The manufacturer will return repaired or replacement products to you in working condition. You should expect the repair or replacement to take approximately 30 days.

3. How long is the limited warranty period?

The limited warranty period for the PRODUCT extends for TWO (2) YEARS from the date of purchase. If the manufacturer repairs or replaces a materially defective PRODUCT under the terms of this limited warranty, this limited warranty also applies to repaired or replacement PRODUCT for a period of either (a) 90 days from the date the repaired or replacement PRODUCT is shipped to you or (b) the time remaining on the original two-year limited warranty; whichever is longer.

4. What is not covered by this limited warranty?

This limited warranty does not cover:

- PRODUCT that has been subjected to misuse, accident, shipping or other physical damage, improper installation, abnormal operation or handling, neglect, inundation, fire, water, or other liquid intrusion; or
- PRODUCT that has been damaged due to repair, alteration, or modification by anyone other than an authorized service representative of the manufacturer; or
- PRODUCT to the extent that the problem experienced is caused by signal conditions, network reliability or cable or antenna systems; or
- PRODUCT to the extent that the problem is caused by use with non-AT&T accessories; or
- PRODUCT whose warranty/quality stickers, PRODUCT serial number plates or electronic serial numbers have been removed, altered or rendered illegible; or
- PRODUCT purchased, used, serviced, or shipped for repair from outside the United States of America or Canada, or used for commercial or institutional purposes (including but not limited to products used for rental purposes); or
- PRODUCT returned without a valid proof of purchase (see item 6 below); or
- Charges for installation or setup, adjustment of customer controls, and installation or repair of systems outside the unit.

Limited warranty

5. How do you get warranty service?

To obtain warranty service in the United States of America, visit

www.telephones.att.com or call **1 (800) 222-3111**. In Canada, call **1 (866) 288-4268**. NOTE: Before calling for service, please review the user's manual; a check of the PRODUCT's controls and features may save you a service call.

Except as provided by applicable law, you assume the risk of loss or damage during transit and transportation and are responsible for delivery or handling charges incurred in the transport of the PRODUCT(s) to the service location. The manufacturer will return repaired or replaced PRODUCT under this limited warranty to you. Transportation, delivery or handling charges are prepaid. The manufacturer assumes no risk for damage or loss of the PRODUCT in transit. If the PRODUCT failure is not covered by this limited warranty, or proof of purchase does not meet the terms of this limited warranty, the manufacturer will notify you and will request that you authorize the cost of repair prior to any further repair activity. You must pay for the cost of repair and return shipping costs for the repair of products that are not covered by this limited warranty.

6. What must you return with the PRODUCT to get warranty service?

You must:

- Return the entire original package and contents including the PRODUCT to the service location along with a description of the malfunction or difficulty; and
- Include a "valid proof of purchase" (sales receipt) identifying the PRODUCT purchased (PRODUCT model) and the date of purchase or receipt; and
- Provide your name, complete and correct mailing address, and telephone number.

7. Other limitations

This warranty is the complete and exclusive agreement between you and the manufacturer of this AT&T branded PRODUCT. It supersedes all other written or oral communications related to this PRODUCT. The manufacturer provides no other warranties for this PRODUCT. The warranty exclusively describes all of the manufacturer's responsibilities regarding the PRODUCT. There are no other express warranties. No one is authorized to make modifications to this limited warranty and you should not rely on any such modification.

State/Provincial Law rights: This warranty gives you specific legal rights, and you may also have other rights which vary from state to state or province to province.

Limitations: Implied warranties, including those of fitness for a particular purpose and merchantability (an unwritten warranty that the PRODUCT is fit for ordinary use) are limited to one year from date of purchase. Some states/provinces do not allow limitations on how long an implied warranty lasts, so the above limitation may not apply to you. In no event shall the manufacturer be liable for any indirect, special, incidental, consequential, or similar damages (including, but not limited to lost profits or revenue, inability to use the PRODUCT or other associated equipment, the cost of substitute equipment, and claims by third parties) resulting from the use of this PRODUCT. Some states/provinces do not allow the exclusion or limitation of incidental or consequential damages, so the above limitation or exclusion may not apply to you.

Please retain your original sales receipt as proof of purchase.

Technical specifications

RF frequency band	1921.536MHz - 1928.448MHz
Channels	5
Operating temperature	32°F - 122°F 0°C - 50°C
Telephone base voltage (AC adapter output)	5.1VDC @1200mA
Ethernet Network Ports	10/100 Mbps RJ-45 Port
PSTN Jacks	1-4 (FXO ports)

Index

A

Add a deskset 20
 Add a headset 21, 23
 Alert tones 97
 Announcement 77–80, 83
 Answer a call 42
 Answer an intercom call 54
 Auto-redial 50
 Auto attendant 89–90
 Auto set IP 28

B

Blind transfer 55

C

Caller ID 68–74
 Call history 70
 Call intercept 85, 91
 Call privacy 45
 Call screening 87, 91
 Call transfer 55, 56
 Call waiting 43, 68
 Capacity 61, 75
 Cardiac pacemakers 110
 Chain dialing 47
 Change the extension number 24
 Conference call 51
 Contrast 37

D

Date 34
 Default settings 39
 Delay 76, 82
 Deregister a headset 22
 Deskset registration 20
 Dialing options 71
 Dial mode 38
 Directory 61–67

Directory card 2

Display dial 65

E

End a call 41
 End a conference call 51, 52
 End an intercom call 54

F

FCC, ACTA and IC regulations 111
 Flash 43

H

Handsfree use 42
 Hold 44
 Hold reminder 38
 Home area code 36

I

Icons 96
 Important safety information 109–110
 Indication 41, 91, 96, 97
 Installation 7–13
 Intercom 54, 56

J

Join a call 52

K

Key tone 37

L

Language 35
 Lights 97
 Limited warranty 113–114
 Line group 27
 Line indicators 41
 Listening volume 43

Index

M

- Maintenance 108
- Make a call 41
- Make an intercom call 54
- Memo 93
- Memory match 70
- Menu settings 24
- Message indication 91
- Message playback 91
- Missed (new) calls indicator 70
- Mute 43

N

- Navigation keys 1
- Network information 31
- New message indication 91

O

- One-touch 57
- One-touch keys 2
- On hook dialing (predialing) 42
- Operation 41–60

P

- Pacemaker patients 110
- PC jack 19
- Phonebook (directory) 61–67
- Predialing 42
- Prime line 26
- Privacy 45
- Private mailbox 82–85
- Pulse dialing 38

Q

- Quick reference guide 1–3

R

- Record a call 46
- Recording time 88
- Redial 48

- Register a deskset 20
- Register a headset 21
- Remote access 94–95
- Rename console 39
- Review call history 70
- Review directory 63
- Ringer tone 33
- Ringer Volume 32

S

- Search by name 64
- Search for a contact 64
- Set Date/Time 34
- Set default 39
- Set static IP 12, 29–30
- Settings 32–40
- Share a call 52
- Speakerphone 42
- Switch between lines 44
- System setup 24–31

T

- Technical specifications 115
- Telephone operation 41–60
- Temporary tone dialing 43
- Time 34
- Transfer a call 55, 56
- Troubleshooting 98–104
- Two-way recording 110

V

- Volume 32, 43
- Volume control 43

W

- Wall mount 14–18
- Warranty 113–114
- Website 40

Remote access wallet card

Use the wallet card below to help you remember commands to control your answering system from any touch-tone telephone.

Cut along dotted line.



Call your telephone number, then enter your three-digit access code (preset to **333**).

Action	Remote command
--------	----------------

Play all messages	1X
Play new messages	1
Repeat the message	2
Skip the message	3
Play Day OGM 1.....	41
Play Day OGM 2	42
Play Day OGM 3	43
Play Night OGM	5
Play directory OGM	6
Play private mailbox announcement	7

Fold here.

Stop	8
Record a memo.....	9
Turn system off or on	0
Delete a message	#
Delete all messages.....	X
End remote access call	Hang up

Model name: MS2085

Type: 4-Line Small Business Main Console

© 2012 Advanced American Telephones. All Rights Reserved. AT&T and the AT&T logo are trademarks of AT&T Intellectual Property licensed to Advanced American Telephones, San Antonio, TX 78219. Printed in China.



www.telephones.att.com

Message Guard® is a registered trademark of Advanced American Telephones.

© 2012 Advanced American Telephones. All Rights Reserved.

AT&T and the AT&T logo are trademarks of AT&T Intellectual Property licensed to
Advanced American Telephones, San Antonio, TX 78219.

Printed in China. Issue 7 AT&T 10/12.