



at&t

User's manual

MS2025 4-line

Small Business Cordless Handset



Congratulations

on your purchase of this AT&T product. Before using this AT&T product, please read the **Important safety information** on pages 56-58 of this manual. Please thoroughly read this user's manual for all the feature operations and troubleshooting information necessary to install and operate your new AT&T product. You can also visit our website at **www.telephones.att.com** or call **1 (800) 222-3111**. In Canada, dial **1 (866) 288-4268**.

Model number: MS2025

Type: 4-Line Small Business Cordless Handset

Serial number: _____

Purchase date: _____

Place of purchase: _____

Both the model and serial numbers of your AT&T product can be found on the bottom of the telephone base.

Save your sales receipt and original packaging in case it is necessary to return your telephone for warranty service.



Telephones identified with this logo have reduced noise and interference when used with most T-coil equipped hearing aids and cochlear implants. The TIA-1083 Compliant Logo is a trademark of the Telecommunications Industry Association. Used under license.

Parts checklist

Your telephone package contains the following items. Save your sales receipt and original packaging in the event warranty service is necessary.

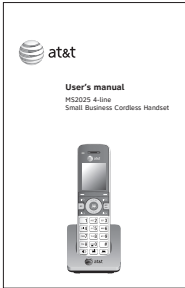

MS2025
User's manual

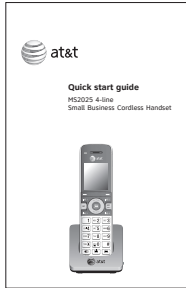

MS2025
Quick start guide



Cordless handset



Battery compartment
cover



Battery for cordless
handset



Charger for cordless
handset with power
adapter installed

User's manual

MS2025 4-Line

Small Business Cordless Handset



Table of contents

Getting started

Installation.....	1
Quick reference guide	2
Charger installation.....	5
Battery installation and charging.....	6
Wall mount installation.....	8
To mount the charger on the wall	8
Adding and registering a handset.....	10
To register a handset to your MS2015 deskset.....	11
Deregistering a handset.....	12
To deregister the cordless handset from the MS2015 deskset	12
Adding a corded headset.....	13

Telephone settings

Telephone setup	14
Menu settings.....	14
Ringer volume.....	15

Ringer tone.....	16
Language.....	17
Home area code.....	18
Key tone.....	19
LCD contrast	19
Hold reminder	20
Extension number	20
Phone rename.....	21
Reset handset	21

Telephone operation

Telephone operation.....	22
Line indicators.....	22
Making and ending a call...22	
On hook dialing (predialing).....	22
Using the speakerphone.....	23
Answering a call	23
Temporary ringer silencing.....	23
Redial.....	23
Options while on calls.....	25

Call waiting.....	25
Volume control.....	25
Mute.....	25
Hold.....	26
Chain dialing.....	27
Conference call.....	28
Conference calls.....	28
A. Join a call by answering an intercom call.....	28
B. Inviting parties using Intercom.....	29
Intercom.....	30
Make an intercom call to an extension.....	30
Answer an intercom call.....	30
End an intercom call.....	30
Answer an incoming call during an intercom call.....	30

Directory

About the directory.....	31
Capacity.....	31
Exit the directory.....	31
Create directory entries.....	32
Create a new directory entry.....	32
Review directory entries.....	32
Search directory.....	33
Search by name.....	33
Dial, delete or edit entries.....	34
Display dial.....	34
Delete an entry.....	34
Edit an entry.....	34

Caller ID

About the caller ID.....	35
Information about caller ID with call waiting.....	35
Caller ID information.....	37
How the caller ID information (call log) works.....	37
Review the caller ID information.....	38
View dialing options.....	38
Dial a call history entry.....	39
Save a caller ID entry to the directory.....	39
Delete all caller ID entries.....	39
Reasons for missing caller ID information.....	40

Answering system

Private mailbox setup.....	41
Announcement.....	41
Answering system operation.....	42
Visual message waiting indicator.....	42
Message playback.....	42

Appendix

Handset screen icons.....	43
Alert tones and lights.....	44
Handset alert tones.....	44
Handset indicator lights.....	44

Handset display screen	
messages.....	45
Troubleshooting	46
Maintenance.....	55
Important safety	
information.....	56
FCC part 15.....	59
FCC part 68 and ACTA.....	61
Limited warranty.....	62
Technical specifications	65
DECT 6.0 digital	
technology.....	65
Telephone operating	
range	65
Index	
Index	66

Installation

You must install and charge the handset battery before using the cordless handset.



See pages 5-7 for easy instructions.

Your product may be shipped with a protective sticker covering the handset display - remove it before use.

For customer service or product information, visit our website at **www.telephones.att.com** or call **1 (800) 222-3111**. In Canada, dial **1 (866) 288-4268**.

Avoid placing the telephone base too close to:

- Communication devices such as television sets, VCRs, or other cordless telephones.
- Excessive heat sources.
- Noise sources such as a window with traffic outside, motors, microwave ovens, refrigerators, or fluorescent lighting.
- Excessive dust sources such as a workshop or garage.
- Excessive moisture.
- Extremely low temperature.
- Mechanical vibration or shock such as on top of a washing machine or work bench.

Quick reference guide

Charge light

- On when the handset is charging in the charger (page 7).

Softkeys (2)

- Press to select a menu item displayed above the key.

LINE 1/LINE 2/LINE 3/LINE 4

- Press to make a call on the desired line (pages 22).
- Press to answer a call (page 23).

INT

- Press to make an intercom call when in idle (page 30).

REDIAL/PAUSE

- Press to view the last 10 numbers dialed (page 23).

🔊)/SPEAKER

- Press to turn on the handset speakerphone. Press again to resume normal handset use (page 23).

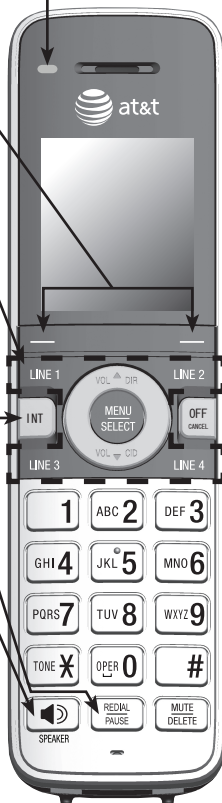

Quick reference guide



VOL/▲DIR

- Press to scroll up while in menus.
- During a call, press to increase the listening volume (page 25).
- Press to show directory entries when the telephone is not in use (page 32).

MENU/SELECT

- Press to enter the menu.
- While in a menu, press to select an item or save an entry or setting.

OFF/CANCEL

- While using menus, press to return to idle mode.
- During a call, press to hang up.

VOL/▼CID

- Press to scroll down while in menus.
- During a call, press to decrease the listening volume (page 25).
- Press to show the caller ID history when the telephone is not in use (page 38).

MUTE/DELETE

- During a call, press to mute the microphone (page 25).
- While redialing, press to delete digits (page 22).
- While reviewing the directory entry, press to delete an individual entry (page 34).
- While entering or editing a directory entry, press to erase a digit or character (pages 32 and 34).

Quick reference guide



Belt clip

Main menu



Main menu

- Ringers (pages 15-16)
- Phone Settings (pages 17-21)

Using menus

- Press **MENU/SELECT** or **MENU** to show the first menu item, **Ringers**.
- Press **▲** or **▼** to scroll through menu items.
- Press **MENU/SELECT** or **SELECT** to select or save changes to a highlighted menu item.
- Press **OFF/CANCEL** or **BACK** to cancel an operation, exit the menu display or return to the idle screen.

Charger installation

Install the charger as shown below.

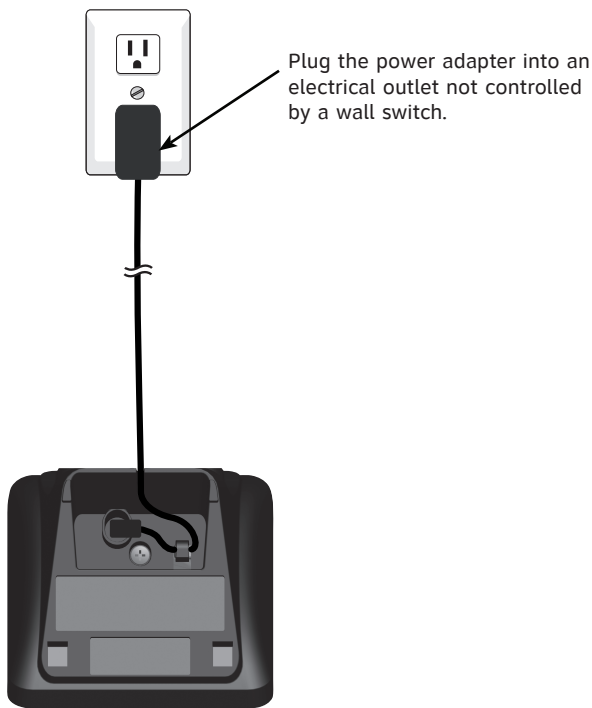



IMPORTANT INFORMATION

1. Use only the power adapter supplied with this product. To order a replacement power adapter, visit our website at **www.telephones.att.com**, or call **1 (800) 222-3111**. In Canada, dial **1 (866) 288-4268**.
2. The power adapter is intended to be correctly oriented in a vertical or floor mount position. The prongs are not designed to hold the plug in place if it is plugged into a ceiling, under-the-table or cabinet outlet.

Battery installation and charging

Install the battery as shown on the following page. Once you have installed the battery, the screen indicates the battery status (see the table below). If necessary, place the handset in the charger to charge the battery. For best performance, keep the handset in the charger when not in use. The battery is fully charged after 11 hours of continuous charging. See the table on page 65 for battery operating times.

If the screen is blank, you need to charge the handset without interruption for at least 30 minutes to give the handset enough charge to use the telephone for a short time. When the battery is low, the handset shows **Low battery** and a flashing .

Battery indicators	Battery status	Action
The screen is blank or shows Place in charger and  flashes.	The battery has no or very little charge. The handset cannot be used.	Charge without interruption (at least 30 minutes).
The screen shows Low battery and  flashes.	Battery has enough charge to be used for a short time.	Charge without interruption (at least 30 minutes).
The screen shows EXT XX . (XX represents the extension number of the device the handset is registered to).	Battery is charged.	To keep the battery charged, place it in the or charger when not in use.

Battery installation and charging

Install the battery as shown below.

1. Plug the battery connector securely into the socket inside the handset battery compartment. Insert the supplied battery with the label **THIS SIDE UP** facing up as indicated.
2. Align the cover flat against the battery compartment, then slide it upwards until it clicks into place.
3. Charge the handset by placing it face forward in the charger. The charge light is on when charging.

①



②



③

The charge light



IMPORTANT INFORMATION

- Use only the supplied rechargeable battery or replacement battery (model BT164392). To order a replacement battery, visit our website at **www.telephones.att.com**, or call **1 (800) 222-3111**. In Canada, dial **1 (866) 288-4268**.
- If you do not use the handset for a long time, disconnect and remove the battery to prevent possible leakage.

Wall mount installation

The charger is ready for tabletop use. If you want to mount the charger on a wall, use two 10mm screws and wall anchors (not provided) to hold the charger in place. The screws and wall anchors are available for purchase in many hardware or consumer electronics retailers. You might need a professional to install the charger.

To mount the charger on the wall

1. Use a pencil to mark the desired positions of the two holes on the wall, make sure the space between the two holes is 30mm. Drill two holes in the wall according to the marks.

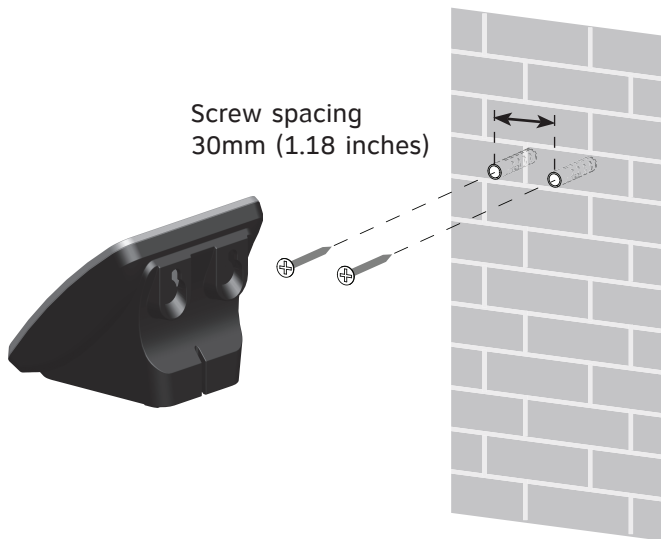

2. If you drill the holes into a stud, go to step 3.

-OR-

If you drill the holes into an object other than a stud, insert the wall anchors (not provided) into the holes and tap gently on the ends with a hammer until the wall anchors are flush with the wall.

Wall mount installation

3. Insert the screws (not provided) into the holes and tighten them until only 1/4 inch of the screws are exposed.

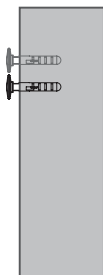

4. Align the holes at the back of the charger with the screws on the wall and slide the charger down until it locks into place.

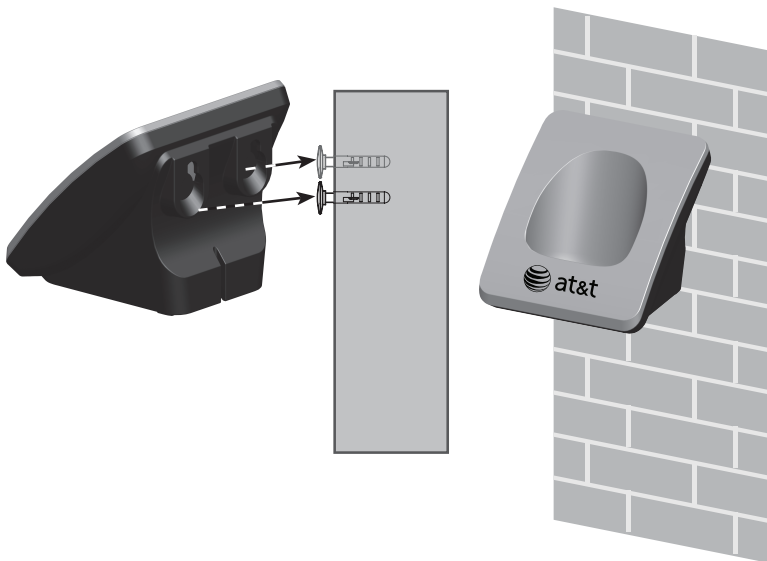

Adding and registering a handset

You must register this MS2025 cordless handset with the MS2015 deskset before use. Each MS2015 supports only one cordless handset. When first purchased, the handset shows **Choose Handset in Registration at base menu. And put handset on cradle to register.**

If the handset does not have enough power to proceed with the registration, you need to charge the new handset for at least five minutes (see **Battery installation and charging** on pages 6-7). Start registration when the handset screen shows **Choose Handset in Registration at base menu. And put handset on cradle to register.**

Adding and registering a handset

To register a handset to your MS2015 deskset

1. Make sure the cordless handset is out of the charger and the screen shows **Choose Handset in Registration at base menu. And put handset on cradle to register.**
2. On the MS2015 deskset, press **MENU/SELECT**.
3. Press **▲** or **▼** to scroll to **Registration**, then press **MENU/SELECT** or **▶/SKIP**.
4. Press **MENU/SELECT** again or **▶/SKIP** to select **Handset**. The MS2015 deskset screen shows **Registering handset... (Put handset on cradle to start)**.
5. Place the unregistered handset into the charger. The handset screen displays **Registering... Please wait** during registration. The handset beeps once and begins registering to the MS2015 deskset. It takes up to 60 seconds to complete the registration. When the registration is successful, the MS2015 deskset shows **Handset registered.** and then the handset shows **Ext Handset**. To change the handset name and the extension number shown on the handset screen, refer to the **Phone rename** on page 21 and **Extension number** on page 20 for details.

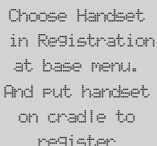

Choose Handset
in Registration
at base menu.
And put handset
on cradle to
register

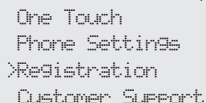

One Touch
Phone Settings
>Registration
Customer Support

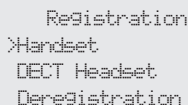

Registration
>Handset
DECT Headset
Deregistration

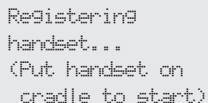

Registering
handset...
(Put handset on
cradle to start)



NOTES:

- If the registration is not successful, the deskset returns to the previous screen. To reset the handset, remove the handset from the charger. Try the registration process again.
- We recommend you avoid using the deskset and the cordless handset at the same time.

Deregistering a handset

You may need to deregister your cordless handset when you have a registered handset and need to replace one. **Please read all the instructions on this page before beginning the deregistration process.**

Please make sure the telephone system is not in use before deregistration.

To deregister the cordless handset from the MS2015 deskset

1. On the deskset, press **MENU/SELECT**.
2. Press **▲** or **▼** to scroll to **Registration** and press **MENU/SELECT** or **▶/SKIP**.
3. Press **▲** or **▼** to scroll to **Deregistration** and press **MENU/SELECT** or **▶/SKIP**.
4. The screen shows **Deregister all devices? Press 'SELECT' to confirm.** Press **MENU/SELECT** to confirm.
5. The process up to 10 seconds to complete the deregistration. The deskset shows **Handset deregistered. DECT Headset deregistered.** and there is a confirmation tone when the deregistration is successful.

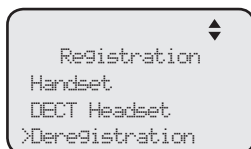
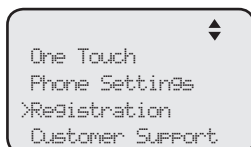

NOTES:

- If the deregistration process is not successful, you might need to reset the system and try again. To reset, you can press **CANCEL** on the deskset. You can also reset the deskset by unplugging the power from the deskset and plugging it back in.
- To register a cordless handset again, refer to the registration information on page 11.

Adding a corded headset

You can use this handset handsfree when you install any industry-standard 2.5mm corded telephone headset (purchased separately). For best results, use an AT&T 2.5mm corded headset. To purchase a corded headset, visit our website at **www.telephones.att.com**, or call **1 (800) 222-3111**. In Canada, dial **1 (866) 288-4268**.

Side view of the handset

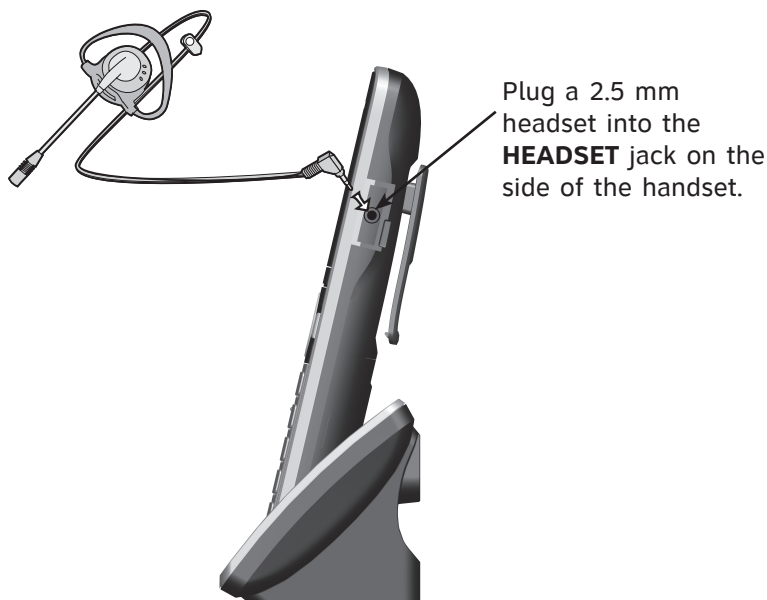

Telephone setup

Menu settings

Use this menu to change the handset settings.

1. Press **MENU/SELECT** or **MENU** when in idle mode (when the handset is not in use) to enter the main menu.
2. Press **▲DIR** or **▼CID** to scroll to the feature to be changed. The highlighted indicates the selected menu item.
3. Press **MENU/SELECT** or the **SELECT** softkey to select the menu item.
4. Press **BACK** to exit setup without making changes.
5. Press **OFF/CANCEL** to back to the idle mode.



NOTE: Press **OFF/CANCEL** to cancel an operation, exit the menu display, or return to idle mode.

Telephone setup

Ringer volume

Use this feature to set the ringer volume to one of six levels or turn the ringer off. When the ringer is off, the  icon appears on the handset screen. The handset stores the volume setting for all lines.

1. When the handset is idle, press **MENU/SELECT** or **MENU**.
2. Press **▲DIR** or **▼CID** to scroll to **Ringers**, then press **MENU/SELECT** or **SELECT**.
3. Press **MENU/SELECT** or **SELECT** again to select **Ringer volume**.
4. Press **▲DIR** or **▼CID** on the handset to adjust the ringer volume, or press **OFF** to turn the ringer off.
5. Press **MENU/SELECT** or **SET** to save the setting and return to the previous menu. There is a confirmation tone. To exit without making changes, press **OFF/CANCEL**.



NOTE: The ringer volume also determines the ringer volume for intercom calls. If the handset ringer volume is set to off, that handset is silenced for all incoming calls, including intercom calls.

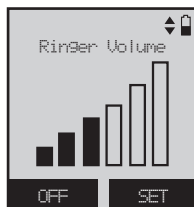
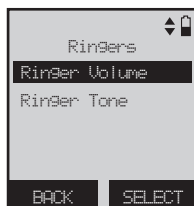
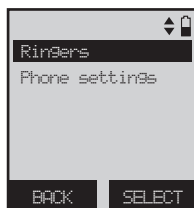

Telephone setup

Ringer tone

Use this feature to choose one of the ten ringer tones. You can choose different ringer tones for different lines so you can easily identify which line is calling.

1. When the handset is idle, press **MENU/SELECT** or **MENU**.
2. Press **▲DIR** or **▼CID** to scroll to **Ringers**, then press **MENU/SELECT** or **SELECT**.
3. Press **▲DIR** or **▼CID** to scroll to **Ringer tone**, then press **MENU/SELECT** or **SELECT**.
4. Press **▲DIR** or **▼CID** to select the desired line (**Line 1**, **Line 2**, **Line 3** or **Line 4**), then press **MENU/SELECT** or **SELECT**.
5. Press **▲DIR** or **▼CID** to select a desired ringer tone.
6. Press **MENU/SELECT** or **SELECT** to save the setting and return to the previous menu. There is a confirmation tone. To exit without making changes, press **OFF/CANCEL** or **BACK**.
7. Repeat steps 4-6 above to choose ringer tones for other lines if desired.

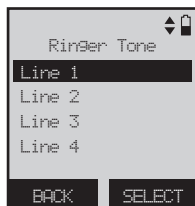

Telephone setup

Language

This feature allows you to change the language used for handset displays. By default, the language is set to **English**.

1. When the handset is idle, press **MENU/SELECT** or **MENU**.
2. Press **▲DIR** or **▼CID** to scroll to **Phone Settings**, then press **MENU/SELECT** or **SELECT**.
3. Press **▲DIR** or **▼CID** to scroll to **Language**, then press **MENU/SELECT** or **SELECT**.
4. Press **▲DIR** or **▼CID** to scroll to **English**, **Français** or **Español**.
5. Press **MENU/SELECT** or **SELECT** to save the setting and return to the previous menu. You hear a confirmation tone. To exit without making changes, press **OFF/CANCEL** or **BACK**.

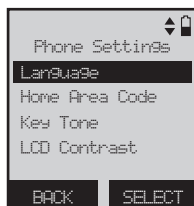
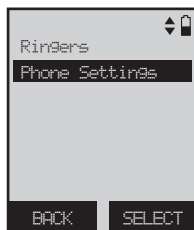

Telephone setup

Home area code

Use this feature to program this system to recognize your home area code. This feature makes it easy for you to place a call from the caller ID log.

When you receive a call from within your home area code, the caller ID information only displays the seven digits of the telephone number, and when you dial from the call log, only seven digits are dialed.

1. When the handset is idle, press **MENU/SELECT** or **MENU**.
2. Press **▲DIR** or **▼CID** to scroll to **Phone Settings**, then press **MENU/SELECT** or **SELECT**.
3. Press **▲DIR** or **▼CID** to scroll to **Home area code**, then press **MENU/SELECT** or **SELECT**.
4. The screen displays **Home area code**. Use the dialing keys to enter a three-digit area code.
 - Press **MUTE/DELETE** or **CLEAR** to delete a digit.
5. Press **MENU/SELECT** or **SET** to save the setting and return to the previous menu. You hear a confirmation tone. To exit without making changes, press **OFF/CANCEL**.

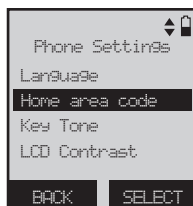

Telephone setup

Key tone

The handset is set to beep with each key press. If you turn off the key tone, there are no beeps when you press keys.

1. When the handset is idle, press **MENU/SELECT** or **MENU**.
2. Press **▲DIR** or **▼CID** to scroll to **Phone Settings**, then press **MENU/SELECT** or **SELECT**.
3. Press **▲DIR** or **▼CID** to scroll to **Key Tone**, then press **MENU/SELECT** or **SELECT**.
4. Press **▲DIR** or **▼CID** to scroll to **On** or **Off**.
5. Press **MENU/SELECT** or **SELECT** to save the setting and return to the previous menu. You hear a confirmation tone. To exit without making changes, press **OFF/CANCEL** or **BACK**.

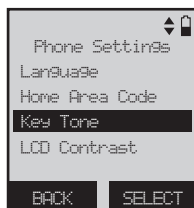

LCD contrast

Use this feature to adjust the screen contrast to one of eight levels to optimize readability in different lighting conditions.

1. When the handset is idle, press **MENU/SELECT** or **MENU**.
2. Press **▲DIR** or **▼CID** to scroll to **Phone Settings**, then press **MENU/SELECT** or **SELECT**.
3. Press **▲DIR** or **▼CID** to scroll to **LCD Contrast**, then press **MENU/SELECT** or **SELECT**.
4. Press **▲DIR** or **▼CID** to scroll to the desired screen contrast level (**Level 1 - Level 8**).
5. Press **MENU/SELECT** or **SELECT** to save the setting. You hear a confirmation tone. To exit without making changes, press **OFF/CANCEL** or **BACK**.

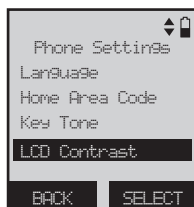

Telephone setup

Hold reminder

When this feature is on and there is a call on hold, the handset beeps once every 30 seconds.

To turn this feature on or off:

1. When the handset is idle, press **MENU/SELECT** or **MENU**.
2. Press **▲DIR** or **▼CID** to scroll to **Phone Settings** then press **MENU/SELECT** or **SELECT**.
3. Press **▲DIR** or **▼CID** to scroll to **Hold Reminder** then press **MENU/SELECT** or **SELECT**.
4. Press **▲DIR** or **▼CID** to scroll to **On** or **Off**.
5. Press **MENU/SELECT** or **SELECT** to save the setting and return to the previous menu. You hear a confirmation tone. To exit without making changes, press **OFF/CANCEL** or **BACK**.

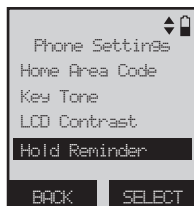

Extension number

You can change the extension number displays on the handset. The handset shares the same extension as the deskset it is registered to. The handset displays **Ext Handset** on the screen by default.

1. When the handset is idle, press **MENU/SELECT** or **MENU**.
2. Press **▲DIR** or **▼CID** to scroll to **Phone Settings**, then press **MENU/SELECT** or **SELECT**.
3. Press **▲DIR** or **▼CID** to scroll to **Extension No.**, then press **MENU/SELECT** or **SELECT**.
4. The handset displays **Extension No.** Use the dialing keys to enter the extension number.
 - Press **MUTE/DELETE** or **CLEAR** to delete a digit.
5. Press **MENU/SELECT** or **SET** to save the setting and then return to the previous menu. You hear a confirmation tone. To exit without making changes, press **OFF/CANCEL**.

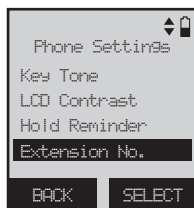

Telephone setup

Phone rename

Use this feature to rename the handset (up to 12 characters).

To change the setting:

1. When the handset is idle, press **MENU/SELECT** or **MENU**.
2. Press **▲DIR** or **▼CID** to scroll to **Phone Settings**, then press **MENU/SELECT** or **SELECT**.
3. Press **▲DIR** or **▼CID** to scroll to **Phone Rename**, then press **MENU/SELECT** or **SELECT**.
4. Use the dialing keys to change the name.
 - Press **MUTE/DELETE** or **CLEAR** to delete a character.
5. Press **MENU/SELECT** or **SET** to save the setting. The screen shows **Saved**, then return to the previous menu. You hear a confirmation tone. To exit without making changes, press **OFF/CANCEL**.

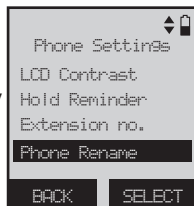

Reset handset

Use this feature to reset all phone settings of this handset to their default settings. The handset registration will not be reset.

1. When the handset is idle, press **MENU/SELECT** or **MENU**.
2. Press **▲DIR** or **▼CID** to scroll to **Phone Settings**, then press **MENU/SELECT** or **SELECT**.
3. Press **▲DIR** or **▼CID** to scroll to **Set HS Default**, then press **MENU/SELECT** or **SELECT**.
4. The handset displays **Confirm?** Press **SET** to confirm and then return to the previous menu.

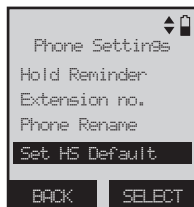

Telephone operation

Line indicators

Each of the four indicators on **LINE 1-LINE 4** indicate the state of the corresponding telephone line.

- On when the corresponding line is in use on this handset.
- On when there is an incoming call on the corresponding line.



Making and ending a call

To make a call:

1. Press the desired line key (**LINE 1-LINE 4**).
2. Wait for a dial tone, then enter the telephone number. The screen displays the elapsed time as you talk (in hours, minutes and seconds).

To end a call:

- Press **OFF/CANCEL** or return the handset to the charger to hang up.
- OR-
- Press the corresponding line key (**LINE 1-LINE 4**) to hang up.



NOTE: The elapsed time is not affected by accessing services from your telephone service provider.

On hook dialing (predialing)

1. Enter the telephone number. Press **MUTE/DELETE** to make corrections.
2. Press the desired line key **LINE 1-LINE 4** to dial the call.

Telephone operation

Using the speakerphone

During a call, press **📞/SPEAKER** to switch between handsfree speakerphone and normal handset use. Press **OFF/CANCEL** to hang up.

Answering a call

To answer a call:

Press any line key (**LINE 1-LINE 4**).

-OR-

Press **📞/SPEAKER** on the cordless handset to answer using the speakerphone.

Temporary ringer silencing

Press **SILENCE** while the telephone is ringing to silence the ringer temporarily on the handset only. This turns off the ringer without disconnecting the call. The next incoming call rings normally at the preset volume.

Redial

The handset shares the same redial memory with the deskset it is registered to. The memory can hold the last 10 telephone numbers dialed (up to 30 digits) from the handset and its registered deskset.

To view and dial the 10 most recently dialed numbers:

1. Press **REDIAL/PAUSE** to enter the redial list and display the summary with the total number of redial numbers.
2. Press **REVIEW**, then press **▲DIR** or **▼CID** to view the last 10 called numbers.
3. Press **OFF/CANCEL** to exit the redial list.

To redial a number:

When the desired number displays on the screen, press the desired line key (**LINE 1-LINE 4**) to dial on the desired line.

Telephone operation

To copy a redial entry to directory:

1. Press **REDIAL/PAUSE** to enter the redial list and display the summary with the total number of redial numbers.
2. Press **REVIEW**, then press **▲DIR** or **▼CID** to scroll to the desired redial number.
3. Press **COPY**. The handset displays **Enter Name**. Use the dialing keys to enter the name.
 - Press **MUTE/DELETE** or **CLEAR** to delete a character.
4. Press **MENU/SELECT** or **NEXT** to proceed. The handset displays **Enter Number**. Use the dialing keys to edit the number.
 - Press **MUTE/DELETE** or **CLEAR** to delete a digit.
5. Press **MENU/SELECT** to save. The handset displays **Saved**.

To delete all redial number:

1. Press **REDIAL/PAUSE** to enter the redial list and display the summary with the total number of redial numbers.
2. Press **DEL ALL** to delete all redial numbers.

Options while on calls

Call waiting

If you subscribe to call waiting service with your telephone service provider, you hear a beep if someone calls while you are on a call.

- Press **FLASH** to put your current call on hold and take the new call.
- Press **FLASH** at any time to switch back and forth between calls.

Volume control

Use this feature to set the listening volume to one of six levels for the handset and speakerphone. While on a call, press **VOL▲** or **VOL▼** to adjust the listening volume.



NOTE: Handset and speakerphone volume settings are independent.

Mute

Use this feature during a telephone conversation to silence the microphone. You can hear the caller, but the caller cannot hear you.

To mute a call:

- Press **MUTE/DELETE**. When mute is on, the screen displays **MUTE**.

To take a call off mute:

- Press **MUTE/DELETE** again and resume speaking.

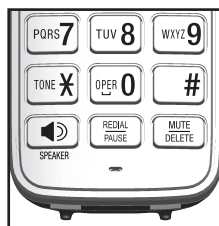

Options while on calls

Hold

Use this feature to hold one line while accessing another, or as part of the conference and call transfer features.

While on a call, press **HOLD**. If you are using the speakerphone, the speakerphone turns off automatically when you press **HOLD**.

To release the hold, press the corresponding line key.

Music on hold (M.O.H) is available on this deskset. When you put a call on hold, the caller will hear the default music that comes with the deskset.



NOTE:

- You cannot put an intercom call on hold.
- The call ends automatically after it is put on hold for 10 minutes.

Options while on calls

Chain dialing

While you are on a call, you can initiate a dialing sequence from the numbers in the directory, caller ID history or redial list.

Chain dialing can be useful if you wish to access other numbers (such as bank account numbers or access codes) from the directory, caller ID history or redial list

To access the directory while on a call:

1. Press **MENU/SELECT**, then press ▲ or ▼ to scroll to **Directory**.
2. Press **MENU/SELECT**, then press ▲ or ▼ to scroll to the desired entry.
3. Press **MENU/SELECT** to dial the desired number. To exit without making changes, press **OFF/CANCEL** and continue with the conversation.

To access the call history while on a call:

1. Press **MENU/SELECT**, then press ▲ or ▼ to scroll to **Call history**.
2. Press **MENU/SELECT**, then press ▲ or ▼ to scroll to the desired entry.
3. Press **MENU/SELECT** to dial the desired number. To exit without making changes, press **OFF/CANCEL** and continue with the conversation.

To access the redial list while on a call:

1. Press **REDIAL/PAUSE**, then press ▲ or ▼ to scroll to the desired entry.
2. Press **MENU/SELECT** to dial the desired number. To exit without making changes, press **OFF/CANCEL** and continue with the conversation.

Conference call

Conference calls

The system can support 5-way conference with a maximum of one outside call and four system extensions (including the initiating party), or two outside calls and three system extensions (including the initiating party). The outside call must be established first because an intercom call cannot be placed on hold.

There are two ways to establish a conference call.

A. Join a call by answering an intercom call

You can join a conference by answering an intercom call from the initiating party of the conference. This calling method supports 5-way conference.

-OR-

B. Inviting parties using Intercom

You can also use this handset to initiate a conference call by calling another outside line.

A. Join a call by answering an intercom call

When you receive an intercom call from the initiating party of the conference, press **INT** or **🔊/SPEAKER** to join the conference call.

When there is an extension joining the conference, you have to turn off the call privacy setting on that extension if you want another extension to join the call. To turn off the call privacy, refer to **Call Privacy** in the user's manual of your MS2015 deskset for more details.

Conference call

B. Inviting parties using Intercom

1. Make or answer an outside call.
2. Press another available line key to make another outside call. The original outside call is put on hold. When the external party picks up, you can have a private conversation with that party.
3. Press **MENU/SELECT**, then press **MENU/SELECT** again or **SELECT** to select **Conference** at any time to begin the conference call.
4. Press **OFF/CANCEL** to hang up. If the party who initiates the conference call hangs up, the call will be ended. The call will also be ended when all parties hang up.



NOTES:

- We recommend you to have no more than five parties in a conference call. A conference call can hold more than five parties but the performance of the call is not guaranteed.
- If you are experiencing difficulty in using the conference features on this telephone, please consider using AT&T's complete line of teleconference services to find a solution that best meets your needs. AT&T TeleConference Services reduces travel time and expenses while increasing productivity wherever people are located, enabling you to host truly virtual meetings and share important information in real time. To sign up for AT&T TeleConference Services, go to: **www.att.com/orderconference** for details.

Intercom

You can use the intercom feature for conversations between the handset and a deskset.

The console and each deskset in the telephone system **MUST** be assigned a unique extension number for the intercom feature to work. The assignment is done when the deskset is initially set up. The cordless handset shares the same extension as the deskset it is registered to.

Make an intercom call to an extension

1. Press **INT** on the handset when it is idle.
2. Press **▲DIR** or **▼CID** to scroll to a desired extension, then press **MENU/SELECT** or **SELECT**.
3. The handset displays **Intercom to: XX** (**XX** represents the extension number of destination device).

Answer an intercom call

When you receive an intercom call, you hear a ringing tone and the handset displays **Intercom from: XX** (**XX** represents the extension number of the calling device). Press **INT** or **🔊/SPEAKER** to answer.

End an intercom call

Press **OFF/CANCEL** to hang up.

Answer an incoming call during an intercom call

If you receive an incoming outside call during an intercom call, there is an alert tone.

To answer the call, press the corresponding line key (**LINE 1-LINE 4**).

About the directory

Use the directory to store names and phone numbers. Directory entries are not shared with other extensions. The console and each deskset have their own directories. The cordless handset shares the directory with the deskset it is registered to.

Capacity

This cordless handset shares the directory memory with the deskset it is registered to. The MS2015 deskset directory can store up to 50 entries, with a maximum of 15 alphanumeric characters (including spaces) for names and 30 digits for telephone numbers.

If there are already 50 entries, the handset shows **Directory memory full** when you try to store a new number. You cannot store a new number until you delete one. If you try to view the directory when there are no entries, the screen displays **Directory empty**.

Exit the directory

On the cordless handset, press **OFF/CANCEL** to cancel an operation and return to idle mode.

Create directory entries

Create a new directory entry

Use the following steps to store a name and number in the directory.

1. When the handset is idle, press **VOL/▲DIR**.
2. The handset displays **Directory XXX entries**. Press **ADD NEW** to add an entry.
3. The screen displays **Enter Name**. Use the dialing keys to enter the name (up to 15 characters).
 - Press **MUTE/DELETE** or **CLEAR** to delete a character.
 - Press **0** to add a space.
4. Press **MENU/SELECT** to save. The screen displays **Enter Number**. Use the dialing keys to enter the number (up to 30 digits).
 - Press **MUTE/DELETE** to delete a digit.
5. Press **MENU/SELECT** to save. The handset displays **Saved**. To exit without making changes, press **OFF/CANCEL**.



Review directory entries

1. When the handset is idle, press **▲DIR**.
2. The handset displays **Directory XXX entries**. Press **REVIEW**.
3. Press **▲DIR** or **▼CID** to browse through the directory. Entries appear alphabetically by the first letter in the name.
4. Press **OFF/CANCEL** to cancel an operation and return to idle mode.

Search directory

Search by name

Follow the steps below to search for directory entries on the handset.

1. When the handset is idle, press **vol/▲DIR**.
2. Press **REVIEW**, then press **▲DIR** or **▼CID** to browse through the directory.
3. When a name appears, press the dial pad keys (**2-9**) to start a name search. The directory shows the first name beginning with the first letter associated with the dial pad key, if there is an entry in the directory beginning with that letter. If there is no entry matching the letter you press, it remains in the current entry.
4. To see other names starting with the letters on the same dial pad key, keep pressing the key. The names appear in alphabetical order.

For example, if you have the names **Jennifer**, **Jessie**, **Kevin** and **Linda** in your directory:

- If you press **5 (JKL)** once, you see **Jennifer**.
- If you press **5 (JKL)** twice, you see **Kevin**.
- If you press **5 (JKL)** three times, you see **Linda**.
- To view **Jessie**, press **▼CID** while **Jennifer** is displayed.

Dial, delete or edit entries

You can dial, delete or edit a directory entry (name and number) when it is shown on the handset. You can use the directory review (page 32) or name search (page 33) to show an entry.

Display dial

When a number is displayed on the screen, you can dial the number by pressing the desired line key (**LINE 1-LINE 4**).

Delete an entry

When a directory entry appears, press **MUTE/DELETE**. You hear a confirmation tone.

-OR-

When a directory entry appears, press **DELETE**. You hear a confirmation tone.

Edit an entry

1. When a directory entry appears, press **EDIT**.
2. The screen displays **Enter Name**. Use the dialing keys to edit the name.
 - Press **MUTE/DELETE** or **CLEAR** to delete a character.
3. Press **MENU/SELECT** to save. The screen displays **Enter Number**. Use the dialing keys to edit the number.
 - Press **MUTE/DELETE** to delete a digit.
4. Press **MENU/SELECT** to save. The handset displays **Saved**. To exit without making changes, press **OFF/CANCEL**.

About the caller ID

This telephone supports caller ID services that most telephone service providers offer. Caller ID allows you to see the name, number, date and time of calls. Depending on your service subscription, you might see the caller's number, or the caller's name and number from the telephone service provider after the first or second ring. Caller ID information might not be available for every incoming call. Callers may intentionally block their names and/or telephone numbers.

This product can provide information only if both you and the caller are in areas offering caller ID service and if both telephone service providers use compatible equipment.

Information about caller ID with call waiting

Caller ID with call waiting lets you see the name and telephone number of the caller before answering the telephone, and while on another call.

It might be necessary to change telephone service to use this feature. Contact your telephone service provider if:

- You have both caller ID and call waiting, but as separate services (you might need to combine these services).
- You only have caller ID service, or only call waiting service.
- You do not subscribe to caller ID or call waiting services.



About the caller ID

There are fees for caller ID services. In addition, services may not be available in all areas.

This product can provide information only if both you and the caller are in areas offering caller ID service and if both telephone service providers use compatible equipment. The time and date, along with the call information, are from the telephone service provider.

If you subscribe to caller ID service, this phone automatically resets the time and date using the caller ID information from the first incoming call after initial setup, or each time the power resumes after a power outage.

If you have manually set the date and time of the deskset this cordless handset is registered to before the first incoming call, they will become the local date and time of the cordless handset. The date and time won't be updated by the caller ID information of any incoming call afterward.



NOTE: You can use this product with regular caller ID service, or you can use this product's other features without subscribing to caller ID or combined caller ID with call waiting service.

Caller ID information

How the caller ID information (call log) works

This cordless handset shares the caller ID memory with the deskset it is registered to. The MS2015 deskset stores caller ID information for the last 200 incoming calls in the handset. Entries are stored in reverse chronological order. The telephone deletes the oldest entry when the log is full to make room for new calls.

Each extension has independent caller ID information. Deleting the caller ID information on any one extension does not affect the caller ID information on other extensions.

If you answer a call before the information appears on the screen, it does not show in the caller ID information.

Review the caller ID information to determine who called, to easily return the call, or to copy the caller's name and number into your directory.

The caller ID information includes the date, time, caller's name and telephone number.

Caller ID information appears on the screen as the telephone rings, or until the caller hangs up, or until the call has been answered at another extension, or until the call ends.

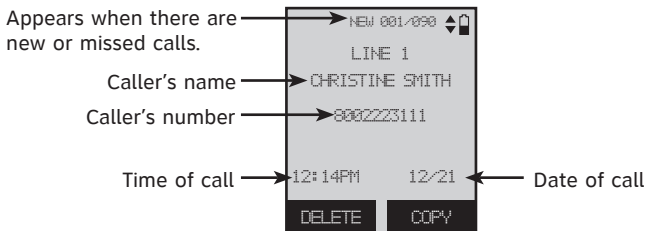

NOTES:

- The caller ID information might not be available for every incoming call. Callers might intentionally block their names and/or telephone numbers.
- Each entry can store up to 30 digits for the telephone number and 15 characters for the name.

Caller ID operation

Review the caller ID information

1. When the handset is idle, press **VOL/▼CID**.
2. The handset displays **Call History**
New Calls: XX and **Total Calls: XX**.
Press **REVIEW**.
3. Press **▲DIR** or **▼CID** to review the caller ID information. The caller ID history entries are stored in reverse chronological order, starting with the most recent entry.
4. To exit without making changes, press **OFF/CANCEL**.



View dialing options

Although the incoming call history entries have 10 digits (the area code plus the seven-digit number), in some areas, you may need to dial the seven digits only, 1 plus the seven digits, or 1 plus the area code plus the seven digits. You can change and store the number of digits that you dial in the call history.

While reviewing the call history, press **#** (pound key) repeatedly on the console to show different dialing options for local and long distance numbers before dialing or saving the telephone number in the directory.

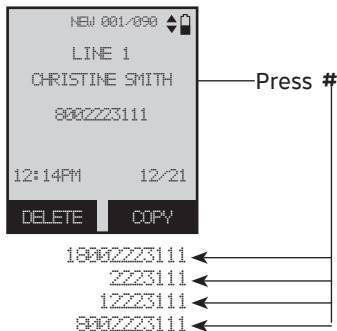

Caller ID operation

Dial a call history entry

1. When in the caller ID history, press **▲DIR** or **▼CID** to browse the number you wish to call.
2. Press the desired line key (**LINE 1-LINE 4**).

Save a caller ID entry to the directory

1. When in the caller ID history, press **▲DIR** or **▼CID** to browse the desired number to save.
2. Press **COPY**. The screen displays **Enter Name**. Use the dialing keys to edit the name.
 - Press **MUTE/DELETE** to delete a character.
3. Press **MENU/SELECT** to save. The screen displays **Enter Number**. Use the dialing keys to edit the number.
 - Press **MUTE/DELETE** or **CLEAR** to delete a digit.
4. Press **MENU/SELECT** to save. To exit without making changes, press **OFF/CANCEL**.



NOTE: You will need to change how a caller ID number is dialed if the entry does not appear in the correct format. Caller ID numbers might appear with an area code that might not be necessary for local calls, or without a 1 that might be necessary for long distance calls (see **View dialing options** on the previous page for more information).

Delete all caller ID entries

1. When the handset is idle, press **vol/▼CID**.
2. Press **DEL ALL**. There is a confirmation tone, then returns to the idle screen.

Reasons for missing caller ID information

Reasons for missing caller ID information

There are also occasions when other information or no information shows for various reasons:

On-screen message	Reason
PRIVATE NAME	The caller prefers not to show the name.
PRIVATE NUMBER	The caller prefers not to show the phone number.
PRIVATE CALLER	The caller prefers not to show the phone number and name.
UNKNOWN NAME	Your telephone service provider cannot determine the caller's name.
UNKNOWN NUMBER	Your telephone service provider cannot determine the caller's number.
UNKNOWN CALLER	No information is available about this caller.

Private mailbox setup

Announcement

The system plays an outgoing announcement to the caller when the call is answered by the private mailbox. The system has a default announcement, *"Hello, please leave a message after the tone."* This handset allows you to play the current announcement only. Use the deskset this handset is registered to for recording and resetting announcement. For more details, refer to the user's manual of the MS2015 deskset.

You can record an announcement up to 75 seconds.

To play the announcement:

1. When the handset is idle, press **ANS SYS**.
2. Press **▲DIR** or **▼CID** to scroll to **Private Mailbox**, then press **MENU/SELECT** or **SELECT**.
3. Press **MENU/SELECT** or **SELECT** to select **Announcement**.
4. Press **MENU/SELECT** or **SELECT** to select **Play**.

Answering system operation

Visual message waiting indicator

The handset displays **XX New message(s)** when there are new messages and/or memos in the private mailbox of the deskset this handset is registered to.

Message playback

From the handset, you can play the messages in the private mailbox.

You can choose to listen to the new messages or all messages recorded in the private mailbox. All messages are played in chronological order.

When playback begins, the total number of messages is announced. Before each message, you hear the date and time of the recording. After the last message, you hear, "*End of the messages.*"

To listen to messages in the mailbox:





1. While the telephone is idle, press **ANS SYS** on the handset.
2. Press **MENU/SELECT** or **SELECT** to select **Play Messages**.
3. Press **▲DIR** or **▼CID** to choose **Play new msgs** to play the new message only or **Play all msgs** to play all the messages in the mailbox.
4. Press **MENU/SELECT** to play the messages.
5. The system announces the number of new or missed messages in the mailbox.

Options during playback

When a message is playing on the handset:

- Press **SKIP** to skip to the next message.
- Press **REPEAT** to repeat the current message. Immediately press **REPEAT** after the date and time announcement to hear the previous message.
- Press **OFF/CANCEL** to stop.

Handset screen icons

L1 L2 L3 L4	Telephone lines - On steadily when line 1, line 2, line 3, or line 4 is in use on this handset, or when there is an incoming call.
	Ringer off - On steadily when the ringer volume is set to OFF .
	Headset - On steadily when using a corded headset.
	Speakerphone - On steadily when using the speakerphone.
MUTE	Mute - Microphone is muted.
	New caller ID log - Missed and new calls.

Alert tones and lights

Handset alert tones

One beep

There is an incoming call waiting.

Five beeps

The telephone has completed the command successfully.

Handset indicator lights



Charge light

- On when the handset is charging in the charger.

Large Lighted Display

LINE 1/LINE 2/LINE 3/LINE 4

- On when the telephone line is in use or when there is an incoming call.

Backlight (lighted display and dial pad)

- On when the handset is lifted from the charger.
- On when a key is pressed.

Speaker/SPEAKER light

- On when the speakerphone is in use.

Handset display screen messages

Choose Handset in Registration at base menu. And put handset on cradle to register.	Your handset is not registered to the deskset.
Directory empty	There are no directory entries.
Directory memory full	The directory is full. You cannot save new entries unless you delete some current entries.
Incoming call	There is a call coming in.
Intercom from:	There is an intercom call coming in.
Intercom to:	The handset is making an intercom call.
No battery	The battery is not properly installed and the handset is in the charger.
Out of range OR No Power at base	The handset has lost communication with the deskset. There is no power connected to the deskset.
Phone is set to default	The handset telephone settings are reset to default settings.
Redial empty	The redial list is empty.
Registering... Please wait	The handset is registering to a deskset.
Registration failed	The handset fails to register to a deskset.

Troubleshooting

If you have difficulty with your telephone, please try the suggestions below. For customer service, visit our website at **www.telephones.att.com** or call **1 (800) 222-3111**. In Canada, dial **1 (866) 288-4268**.

The handset registration is unsuccessful.

- Follow the handset registration instructions to register the handset again (see **To register a handset to your MS2015 deskset** on page 11).

My telephone doesn't work at all.

- Make sure the power cord is securely plugged in.
- Make sure you plug the battery connector securely into the cordless handset.
- Make sure you plug the telephone line cords securely and firmly into the console and the telephone wall jacks.
- Make sure you plug the Ethernet cable securely and firmly into the console and a router.
- Charge the battery in the cordless handset for at least 11 hours. For optimum daily performance, return the cordless handset to the charger when not in use.
- If the battery is depleted, charge the handset for at least 30 minutes before you use it. See page 6 for details.
- You may need to purchase a new battery. Refer to **Battery installation and charging** on pages 6-7.

Troubleshooting

There is no dial tone.

- Try all the suggestions above.
- Move the cordless handset closer to the deskset. You may have moved out of range.
- If the previous suggestions do not work, disconnect the telephone line from the console and connect it to a different phone. If there is no dial tone on that phone either, the problem is in your wiring or telephone service. Contact your telephone service provider.
- Your line cord may be defective. Try installing a new line cord.

I cannot dial out.

- Try all the suggestions above.
- Make sure you have a dial tone before dialing. The cordless handset may take a second or two to find the deskset and produce a dial tone. This is normal. Wait an extra second before dialing.
- Eliminate any background noise. Noise from a television, radio or other appliances may cause the phone to not dial out properly. If you cannot eliminate the background noise, try muting the cordless handset before dialing, or dialing from another room with less background noise.
- If other phones in your home are having the same problem, contact your telephone service provider (charges may apply).

I cannot switch a call from the cordless handset to the deskset.

- Make sure the system has only one line operating. You cannot switch the call from the cordless handset to the deskset if there is more than one telephone line in operation.

Troubleshooting

My cordless handset isn't performing normally.

- Move the cordless handset closer to the deskset. You may have moved out of range.
- Reset the deskset. Unplug the electrical power. Wait for 15 seconds, then plug it back in. Allow at least one minute for the deskset to reset.
- Other electronic products such as HAM radios and other DECT phones can cause interference with your cordless phone. Try installing your phone as far away as possible from these types of electronic devices.

Out of range OR No power at base appears on my cordless handset.

- Ensure you plug the power into the deskset properly.
- Move the cordless handset closer to the deskset. You may have moved out of range.
- Reset the deskset. Unplug the electrical power. Wait for 15 seconds then plug it back in. Allow at least one minute for the cordless handset and telephone base to reset.
- Other electronic products such as HAM radios and other DECT phones can cause interference with your cordless phone. Try installing your phone as far away as possible from these types of electronic devices.

Troubleshooting

The batteries do not hold a charge.

- If the cordless handset is in the charger and the charge light is not on, refer to **The charge light is off** (page 53).
- Charge the battery in the cordless handset for at least 11 hours. For optimum daily performance, return the cordless handset to the charger when not in use.
- If the battery is depleted, it may take approximately 30 minutes to charge the handset before it shows **Low battery**. Refer to the table on page 6 for details.
- You may need to purchase a new battery. Refer to **Battery installation and charging** on pages 6-7.

I get noise, static, or weak signals on my cordless handset even when I'm near the deskset.

- If you subscribe to high-speed Internet service (DSL - digital subscriber line) through your telephone lines, you must install a DSL filter between each telephone line cord and telephone wall jack. The filter prevents noise and caller ID problems as a result of DSL interference. Please contact your DSL service provider for more information about DSL filters.
- You may be able to improve the performance by installing your deskset as far as possible from any other existing corded or cordless telephone system that may already be installed.
- Other electronic products such as HAM radios and other DECT phones can cause interference with your cordless phone. Try installing your phone as far away as possible from these types of electronic devices.
- Do not install this handset near a microwave oven or on the same electrical outlet. You might experience decreased performance while the microwave oven is operating.

Troubleshooting

- If you plug your telephone in with a modem or a surge protector, plug the phone (or modem/surge protector) into a different location. If this does not solve the problem, relocate your console or modem farther apart from one another, or use a different surge protector.
- Relocate your telephone to a higher location. The telephone might have better reception in a high area.
- If the other telephones in your building are having the same problem, contact your telephone service provider.

I experience poor sound quality when using the speakerphone.

- For increased sound quality while using the speakerphone, place the handset on a flat surface with the dialing keys facing up.
- When using a speakerphone, controlling background noise in your environment is essential. While you are listening to your party, press **MUTE/DELETE** to temporarily turn your microphone off. When it is your turn to speak, remember to press **MUTE/DELETE** again to turn the microphone on.
- Excessive background noise will cause a speakerphone to fade in and out. Try controlling the background noise by turning off any audio devices near the speakerphone. Also, try to avoid interrupting the person at the other end of the conversation while they are speaking. If background noise cannot be controlled, you should terminate speakerphone operation and return to normal handset mode.

Troubleshooting

My cordless handset does not ring when I receive a call.

- Make sure that the ringer is not off (page 15).
- Make sure you plug the telephone line cords securely and firmly into the console and the telephone wall jacks.
- Make sure you plug the Ethernet cable securely and firmly into the console and a router.
- The cordless handset may be too far from the deskset.
- Charge the battery in the cordless handset for at least 11 hours. For optimum daily performance, return the cordless handset to the charger when not in use.
- The layout of your home or office may be limiting the operating range. Try moving the deskset to another location, preferably on an upper floor.
- If other phones in your home are having the same problem, contact your telephone service provider (charges may apply).
- Test a working phone at the phone jack. If another phone has the same problem, contact your telephone service provider (charges may apply).
- Other electronic products such as HAM radios and other DECT phones can cause interference with your cordless phone. Try installing your phone as far away as possible from these types of electronic devices.
- Remove the battery. Replace it and place the cordless handset into the charger. Allow up to one minute for the handset to reestablish its connection with the deskset.

Troubleshooting

My calls cut in and out while I'm using my cordless handset.

- Other electronic products such as HAM radios and other DECT phones can cause interference to your cordless telephone. Try installing your telephone as far away as possible from these types of electronic devices.
- Do not install this phone near a microwave oven or on the same electrical outlet. You may experience decreased performance while the microwave oven is operating.
- If you plug your phone in with a modem or surge protector, plug the phone (or modem/surge protector) into a different location. If this doesn't solve the problem, relocate your phone or modem farther apart from one another, or use a different surge protector.
- Relocate your deskset to a higher location. The phone may have better reception when installed in a high area.
- Disconnect the console from the telephone wall jack and plug in a working telephone. If the other phones in your home are having the same problem, the problem is in your wiring or telephone service. Contact your telephone service provider (charges may apply).
- Excessive background noise will cause a speakerphone to fade in and out. Try controlling the background noise by turning off any audio devices near the speakerphone. Also, try to avoid interrupting the person at the other end of the conversation while they are speaking. If background noise cannot be controlled, you should stop speakerphone operation and return to normal handset mode.
- When using a speakerphone, controlling background noise in your environment is essential. While you are listening to your party, press **MUTE/DELETE** to temporarily turn your microphone off. When it is your turn to speak, remember to press **MUTE/DELETE** to turn the microphone on.

Troubleshooting

My caller ID isn't working.

- Caller ID is a subscription service. You must subscribe to this service from your telephone service provider for this feature to work on your cordless handset.
- The caller must be calling from an area that supports caller ID.
- Both your and your caller's telephone service providers must use caller ID compatible equipment.
- Make sure the area codes are set correctly on the deskset. See **Home area code** on page 18.
- If you subscribe to high-speed Internet service (DSL - digital subscriber line) through your telephone lines, you must install a DSL filter between each telephone line cord and telephone wall jack. The filter prevents noise and caller ID problems resulting from DSL interference. Please contact your DSL service provider for more information about DSL filters.

System does not receive caller ID when on a call.

- Make sure you subscribe to caller ID with call waiting features from your telephone service provider. Caller ID features work only if both you and the caller are in areas offering caller ID service, and if both telephone service providers use compatible equipment.

The charge light is off.

- Make sure you plug the power adapter into an electrical outlet correctly and securely.
- Unplug the electrical power. Wait for 15 seconds, then plug it back in. Allow up to one minute for the cordless handset to reset.
- Clean the cordless handset and charger charging contacts each month with a pencil eraser or cloth.

Troubleshooting

Common cure for electronic equipment.

- If the telephone does not seem to be responding normally, try putting the cordless handset in the charger. If it does not fix the problem, do the following (in the order listed):
 1. Disconnect the power from the deskset.
 2. Remove the cordless handset battery.
 3. Wait a few minutes.
 4. Connect the power to the deskset.
 5. Replace the battery and place the cordless handset into the charger.
 6. Wait for the cordless handset to reestablish its connection with the deskset. This will take at least one minute to finish.

Maintenance

Taking care of your telephone

- Your cordless telephone contains sophisticated electronic parts, so you must treat it with care.
- Avoid rough treatment.
- Place the corded handset down gently.
- Save the original packing materials to protect your cordless telephone if you ever need to ship it.

Avoid water

- You can damage your cordless telephone if it gets wet. Do not use the corded handset in the rain, or handle it with wet hands. Do not install the cordless telephone near a sink, bathtub or shower.

Electrical storms

- Electrical storms can sometimes cause power surges harmful to electronic equipment. For your own safety, take caution when using electric appliances during storms.

Cleaning your telephone

- Your cordless telephone has a durable plastic casing that should retain its luster for many years. Clean it only with a soft cloth slightly dampened with water or a mild soap.
- Do not use excess water or cleaning solvents of any kind.

Remember that electrical appliances can cause serious injury if used when you are wet or standing in water. If the telephone base should fall into water, DO NOT RETRIEVE IT UNTIL YOU UNPLUG THE POWER CORD AND TELEPHONE LINE CORDS FROM THE WALL, then pull the unit out by the unplugged cords.

Important safety information



This symbol is to alert you to important operating or servicing instructions that may appear in this user's manual. Always follow basic safety precautions when using this product to reduce the risk of injury, fire, or electric shock.

Safety information

- Read and understand all instructions in the user's manual. Observe all markings on the product.
- Avoid using a telephone during a thunderstorm. There may be a slight chance of electric shock from lightning.
- Do not use the telephone to report a gas leak in the vicinity of the leak. Under certain circumstances, a spark may be created when the adapter is plugged into the power outlet, or when the handset is replaced in its cradle. This is a common event associated with the closing of any electrical circuit. The user should not plug the phone into a power outlet, and should not put a charged handset into the cradle, if the phone is located in an environment containing concentrations of flammable or flame-supporting gases, unless there is adequate ventilation. A spark in such an environment could create a fire or explosion. Such environments might include: medical use of oxygen without adequate ventilation; industrial gases (cleaning solvents; gasoline vapors; etc.); a leak of natural gas; etc.
- Do not use this product near water, or when you are wet. For example, do not use it in a wet basement or shower, or next to a swimming pool, bathtub, kitchen sink, or laundry tub. Do not use liquids or aerosol sprays for cleaning. If the product comes in contact with any liquid, unplug any line or power cord immediately. Do not plug the product back in until it has dried thoroughly.
- Install this product in a protected location where no one can trip over any line or power cords. Protect cords from damage or abrasion.
- If this product does not operate normally, see the **Troubleshooting** section on pages 46-54 of this user's manual. If you cannot solve the problem, or if the product is damaged, refer to the **Limited warranty** section on pages 62-64. Do not open this product except as directed in your user's manual. Opening the product or reassembling it incorrectly may expose you to hazardous voltages or other risks.
- Replace backup battery only as described in your user's manual (see pages 6-7). Do not burn or puncture batteries — they contain caustic chemicals.
- This power adapter is intended to be correctly oriented in a vertical or floor mount position. The prongs are not designed to hold the plug in place if it is plugged into a ceiling, an under-the-table or cabinet outlet.



Caution: Use only the power adapter provided with this product. To obtain a replacement, visit our website at

www.telephones.att.com or call

1 (800) 222-3111. In Canada, dial **1 (866) 288-4268**.

Important safety information

Especially about cordless telephones

- **Privacy:** The same features that make a cordless telephone convenient create some limitations. Telephone calls are transmitted between the telephone base and the handset by radio waves, so there is a possibility that your cordless telephone conversations could be intercepted by radio receiving equipment within range of the cordless handset. For this reason, you should not think of cordless telephone conversations as being as private as those on corded telephones.
- **Electrical power:** The telephone base of this cordless telephone must be connected to a working electrical outlet which is not controlled by a wall switch. Calls cannot be made from the handset if the telephone base is unplugged, switched off or if the electrical power is interrupted.
- **Potential TV interference:** Some cordless telephones operate at frequencies that may cause interference to TVs and VCRs. To minimize or prevent such interference, do not place the telephone base of the cordless telephone near or on top of a TV or VCR. If interference is experienced, moving the cordless telephone farther away from the TV or VCR will often reduce or eliminate the interference.
- **Rechargeable batteries:** This product contains nickel-metal hydride rechargeable batteries. Exercise care in handling batteries in order not to create a short circuit with conductive material such as rings, bracelets, and keys. The battery or conductor may overheat and cause harm. Observe proper polarity between the battery and the battery charger.
- **Nickel-metal hydride rechargeable batteries:** Dispose of these batteries in a safe manner. Do not burn or puncture. Like other batteries of this type, if burned or punctured, they could release caustic material which could cause injury.



The RBRC™ Seal means that the manufacturer is voluntarily participating in an industry program to collect and recycle nickel-metal hydride rechargeable batteries when taken out of service within the United States. These batteries may be taken to a participating local retailer of replacement batteries or recycling center. Or you may call 1 (800) 8-BATTERY for locations accepting spent Ni-MH batteries.

Important safety information

Precautions for users of implanted cardiac pacemakers

Cardiac pacemakers (applies only to digital cordless telephones):

Wireless Technology Research, LLC (WTR), an independent research entity, led a multidisciplinary evaluation of the interference between portable wireless telephones and implanted cardiac pacemakers. Supported by the U.S. Food and Drug Administration, WTR recommends to physicians that:

Pacemaker patients

- Should keep wireless telephones at least six inches from the pacemaker.
- Should NOT place wireless telephones directly over the pacemaker, such as in a breast pocket, when it is turned ON.
- Should use the wireless telephone at the ear opposite the pacemaker.

WTR's evaluation did not identify any risk to bystanders with pacemakers from other persons using wireless telephones.

Especially about telephone answering systems

Two-way recording: This unit does not sound warning beeps to inform the other party that the call is being recorded. To ensure that you are in compliance with any federal or state regulations regarding recording a telephone call, you should start the recording process and then inform the other party that you are recording the conversation.

SAVE THESE INSTRUCTIONS

FCC part 15

This equipment complies with Part 68 of the FCC rules and with technical requirements adopted by the Administrative Council for Terminal Attachments (ACTA). The label on the back or bottom of this equipment contains, among other things, a product identifier in the format US:AAAEQ##TXXXX. This identifier must be provided to your telephone service provider upon request.

The plug and jack used to connect this equipment to premises wiring and the telephone network must comply with the applicable Part 68 rules and technical requirements adopted by ACTA. A compliant telephone cord and modular plug is provided with this product. It is designed to be connected to a compatible modular jack that is also compliant. An RJ11 jack should normally be used for connecting to a single line and an RJ14 jack for two lines. See Installation Instructions in the user's manual.

The Ringer Equivalence Number (REN) is used to determine how many devices you may connect to your telephone line and still have them ring when you are called. The REN for this product is encoded as the 6th and 7th characters following the US: in the product identifier (e.g., if ## is 03, the REN is 0.3). In most, but not all areas, the sum of all RENs should be five (5.0) or less. For more information, please contact your telephone service provider.

This equipment may not be used with Party Lines. If you have specially wired alarm dialing equipment connected to telephone line, ensure the connection of this equipment does not disable your alarm equipment. If you have questions about what will disable the alarm equipment, consult your telephone service provider or a qualified installer.

If this equipment is malfunctioning, it must be unplugged from the modular jack until the problem has been corrected. Repairs to this telephone equipment can only be made by the manufacturer or its authorized agents. For repair procedures, follow the instructions outlined under the Limited Warranty.

If this equipment is causing harm to the telephone network, the telephone service provider may temporarily discontinue your telephone service. The telephone service provider is required to notify you before interrupting service. If advance notice is not practical, you will be notified as soon as possible. You will be given the opportunity to correct the problem and the telephone service provider is required to inform you of your right to file a complaint with the FCC. Your telephone service provider may make changes in its facilities, equipment, operation, or procedures that could affect the proper functioning of this product. The telephone service provider is required to notify you if such changes are planned.

FCC part 15

If this product is equipped with a corded or cordless handset, it is hearing aid compatible.

If this product has memory dialing locations, you may choose to store emergency telephone numbers (e.g., police, fire, medical) in these locations. If you do store or test emergency numbers, please:

Remain on the line and briefly explain the reason for the call before hanging up.
Perform such activities in off-peak hours, such as early morning or late evening.

Industry Canada

Operation is subject to the following two conditions: (1) this device may not cause harmful interference, and (2) this device must accept any interference, including interference that may cause undesired operation.

The term "IC:" before the certification/registration number only signifies that the Industry Canada technical specifications were met.

The Ringer Equivalence Number (REN) for this terminal equipment is 0.1. The REN is an indication of the maximum number of devices allowed to be connected to a telephone interface. The termination on an interface may consist of any combination of devices subject only to the requirement that the sum of the RENs of all the devices does not exceed five.

This product meets the applicable Industry Canada technical specifications.

FCC part 68 and ACTA

This equipment has been tested and found to comply with the requirements for a Class B digital device under Part 15 of the Federal Communications Commission (FCC) rules. These requirements are intended to provide reasonable protection against harmful interference in a residential installation. This equipment generates, uses and can radiate radio frequency energy and, if not installed and used in accordance with the instructions, may cause harmful interference to radio communications. However, there is no guarantee that interference will not occur in a particular installation. If this equipment does cause harmful interference to radio or television reception, which can be determined by turning the equipment off and on, the user is encouraged to try to correct the interference by one or more of the following measures:

- Reorient or relocate the receiving antenna.
- Increase the separation between the equipment and receiver.
- Connect the equipment into an outlet on a circuit different from that to which the receiver is connected.
- Consult the dealer or an experienced radio/TV technician for help.

Changes or modifications to this equipment not expressly approved by the party responsible for compliance could void the user's authority to operate the equipment.

This device complies with Part 15 of the FCC Rules. Operation is subject to the following two conditions: (1) this device may not cause harmful interference, and (2) this device must accept any interference received, including interference that may cause undesired operation. Privacy of communications may not be ensured when using this telephone.

To ensure safety of users, the FCC has established criteria for the amount of radio frequency energy that can be safely absorbed by a user or bystander according to the intended usage of the product. This product has been tested and found to comply with the FCC criteria. The handset may be safely held against the ear of the user. The telephone base shall be installed and used such that parts of the user's body other than the hands are maintained at a distance of approximately 20 cm (8 inches) or more. If you choose to use a clipping device, please make sure to only use the supplied AT&T belt clip.

For body worn operation, this handset has been tested and meets the FCC RF exposure guidelines when used with the belt clip supplied or designated for this product. Use of other accessories may not ensure compliance with FCC RF exposure guidelines.

This Class B digital apparatus complies with Canadian ICES-003.

Limited warranty

The AT&T brand is used under license - any repair, replacement or warranty service, and all questions about this product should be directed to: In the United States of America, visit **www.telephones.att.com** or call **1 (800) 222-3111**. In Canada, call **1 (866) 288-4268**.

1. What does this limited warranty cover?

The manufacturer of this AT&T-branded product warrants to the holder of a valid proof of purchase (“CONSUMER” or “you”) that the product and all accessories provided in the sales package (“PRODUCT”) are free from defects in material and workmanship, pursuant to the following terms and conditions, when installed and used normally and in accordance with the PRODUCT operating instructions. This limited warranty extends only to the CONSUMER for products purchased and used in the United States of America and Canada.

2. What will be done if the PRODUCT is not free from defects in materials and workmanship during the limited warranty period (“materially defective PRODUCT”)?

During the limited warranty period, the manufacturer’s authorized service representative will repair or replace at the manufacturer’s option, without charge, a materially defective PRODUCT. If the manufacturer repairs the PRODUCT, they may use new or refurbished replacement parts. If the manufacturer chooses to replace the PRODUCT, they may replace it with a new or refurbished PRODUCT of the same or similar design. The manufacturer will retain defective parts, modules, or equipment. Repair or replacement of the PRODUCT, at the manufacturer’s option, is your exclusive remedy. The manufacturer will return repaired or replacement products to you in working condition. You should expect the repair or replacement to take approximately 30 days.

3. How long is the limited warranty period?

The limited warranty period for the PRODUCT extends for TWO (2) YEARS from the date of purchase. If the manufacturer repairs or replaces a materially defective PRODUCT under the terms of this limited warranty, this limited warranty also applies to repaired or replacement PRODUCT for a period of either (a) 90 days from the date the repaired or replacement PRODUCT is shipped to you or (b) the time remaining on the original two-year limited warranty; whichever is longer.

Limited warranty

4. What is not covered by this limited warranty?

This limited warranty does not cover:

- PRODUCT that has been subjected to misuse, accident, shipping or other physical damage, improper installation, abnormal operation or handling, neglect, inundation, fire, water, or other liquid intrusion; or
- PRODUCT that has been damaged due to repair, alteration, or modification by anyone other than an authorized service representative of the manufacturer; or
- PRODUCT to the extent that the problem experienced is caused by signal conditions, network reliability or cable or antenna systems; or
- PRODUCT to the extent that the problem is caused by use with non-AT&T accessories; or
- PRODUCT whose warranty/quality stickers, PRODUCT serial number plates or electronic serial numbers have been removed, altered or rendered illegible; or
- PRODUCT purchased, used, serviced, or shipped for repair from outside the United States of America or Canada, or used for commercial or institutional purposes (including but not limited to products used for rental purposes); or
- PRODUCT returned without a valid proof of purchase (see item 6 below); or
- Charges for installation or setup, adjustment of customer controls, and installation or repair of systems outside the unit.

5. How do you get warranty service?

To obtain warranty service in the United States of America, visit

www.telephones.att.com or call **1 (800) 222-3111**. In Canada, call **1 (866) 288-4268**.

NOTE: Before calling for service, please review the user's manual; a check of the PRODUCT's controls and features may save you a service call.

Except as provided by applicable law, you assume the risk of loss or damage during transit and transportation and are responsible for delivery or handling charges incurred in the transport of the PRODUCT(s) to the service location. The manufacturer will return repaired or replaced PRODUCT under this limited warranty to you. Transportation, delivery or handling charges are prepaid. The manufacturer assumes no risk for damage or loss of the PRODUCT in transit. If the PRODUCT failure is not covered by this limited warranty, or proof of purchase does not meet the terms of this limited warranty, the manufacturer will notify you and will request that you authorize the cost of repair prior to any further repair activity. You must pay for the cost of repair and return shipping costs for the repair of products that are not covered by this limited warranty.

Limited warranty

6. What must you return with the PRODUCT to get warranty service?

You must:

- Return the entire original package and contents including the PRODUCT to the service location along with a description of the malfunction or difficulty; and
- Include a “valid proof of purchase” (sales receipt) identifying the PRODUCT purchased (PRODUCT model) and the date of purchase or receipt; and
- Provide your name, complete and correct mailing address, and telephone number.

7. Other limitations

This warranty is the complete and exclusive agreement between you and the manufacturer of this AT&T branded PRODUCT. It supersedes all other written or oral communications related to this PRODUCT. The manufacturer provides no other warranties for this PRODUCT. The warranty exclusively describes all of the manufacturer’s responsibilities regarding the PRODUCT. There are no other express warranties. No one is authorized to make modifications to this limited warranty and you should not rely on any such modification.

State/Provincial Law rights: This warranty gives you specific legal rights, and you may also have other rights which vary from state to state or province to province.

Limitations: Implied warranties, including those of fitness for a particular purpose and merchantability (an unwritten warranty that the PRODUCT is fit for ordinary use) are limited to one year from date of purchase. Some states/provinces do not allow limitations on how long an implied warranty lasts, so the above limitation may not apply to you. In no event shall the manufacturer be liable for any indirect, special, incidental, consequential, or similar damages (including, but not limited to lost profits or revenue, inability to use the PRODUCT or other associated equipment, the cost of substitute equipment, and claims by third parties) resulting from the use of this PRODUCT. Some states/provinces do not allow the exclusion or limitation of incidental or consequential damages, so the above limitation or exclusion may not apply to you.

Please retain your original sales receipt as proof of purchase.

Technical specifications

RF frequency band	1921.536MHz - 1928.448MHz
Channels	5
Operating temperature	32°F - 122°F 0°C - 50°C
Handset voltage	2.4V 550mAh Ni-MH battery
Charger voltage (AC adapter output)	6VAC @300mA

Operation	Operating time*
Talk time (cordless handset)	Up to seven hours
Talk time (cordless handset speakerphone)	Up to five hours
Standby	Up to seven days

* Operating times vary depending on your actual use and the age of the battery.

DECT 6.0 digital technology

Digital Enhanced Cordless Telecommunications (DECT) 6.0 is a new frequency band that transmits your voice across multiple channels. This technology provides superior quality of voice and sound, high protection against wiretapping and excellent range, while not interfering with wireless routers.

Telephone operating range

This cordless telephone operates within the maximum power allowed by the Federal Communications Commission (FCC). Even so, this handset and telephone base can communicate over only a certain distance — which can vary with the locations of the telephone base and handset, the weather, and the construction of your home or office.

Index

A

- Add a corded headset 13
- Alert tones 44
- Announcement 41
- Answer a call 23

B

- Battery charging 6–7
- Battery installation 7

C

- Caller ID 35–40
- Call waiting 25
- Capacity 31
- Cardiac pacemakers 58
- Chain dialing 27
- Contrast 19

D

- Deregister a handset 12
- Directory 31–34
- Display dial 34

E

- Edit directory 34
- End a call 22
- End a conference call 29

F

- Flash 25

H

- Handset rename 21
- Handsfree use 23
- Hold 26
- Hold reminder 20
- Home area code 18

I

- Icons 43
- Important safety information 56–58

K

- Key tone 19

L

- Language 17
- Layout 2–3
- Lights 44
- Limited warranty 62–64
- Line indicators 22
- Listening volume 25

M

- Maintenance 55
- Make a call 22
- Make an intercom call 30
- Menu settings 14
- Message playback 42
- Mute 25

Index

N <hr/>	V <hr/>
Name search 33	Volume 15, 25
O <hr/>	W <hr/>
On hook dialing (predialing) 22	Warranty 62–64
Operating range 65	
P <hr/>	
Pacemaker patients 58	
Phonebook (directory) 31–34	
Predialing 22	
R <hr/>	
Redial 23–24	
Registration 10–11	
Review directory 32	
Ringer tone 16	
Ringer volume 15	
S <hr/>	
Screen contrast 19	
Search by name 33	
Speakerphone 23	
T <hr/>	
Technical specifications 65	
Telephone operating range 65	
Temporary ringer silencing 23	



www.telephones.att.com