



User's manual

**5.8 GHz Cordless
Telephone/Answering
System E5926/E5927B/
E5937B/E5947B/EI 937B**

with Caller ID/Call Waiting



Congratulations on your purchase
of this AT&T product.

Before using this telephone system, please read
Important safety instructions
on pages 51 to 53 of this manual.

NEED HELP?

Our representatives are here
to help you with any questions concerning the
operation of this product, available accessories,
or any other related issues.

Call toll free

1 (800) 222-3111

In Canada, call

1 (866) 288-4268

or visit our web site at

www.telephones.att.com

Model #: E5926/E5927B/E5937B/E5947B/EI 937B

Product name: 5.8GHz cordless telephone/answering system

Serial #: _____

(found on the bottom of the telephone base)

Purchase date: _____

Place of purchase: _____

IMPORTANT

Information about caller ID with call waiting

This product has a caller ID with call waiting feature that works with service from your local telephone service provider.

Caller ID with call waiting lets you see who is calling before answering the phone, even when you're on another call.

You may need to change your telephone service to use this feature. Contact your telephone service provider if:

- You have both caller ID and call waiting, but as separate services (you may need combined service).
- You have only caller ID service, or only call waiting service.
- You don't subscribe to any caller ID or call waiting services.

You can use this product with regular caller ID service, or you can use this product's other features without subscribing to either caller ID or combined caller ID with call waiting service.

There are fees for caller ID services, and they may not be available in all areas.

Depending on your service, you may see the caller's number, or the caller's name and number. This product can provide information only if both you and the caller are in areas offering caller ID service, and if both telephone companies use compatible equipment. The time and date are sent by the service provider along with the call information.

You must install and charge the battery before using the telephone.

STOP!

See page 10 for easy instructions.

For customer service or product information, visit our web site at

www.telephones.att.com

or call **1 (800) 222-3111**.

In Canada, call **1 (866) 288-4268**.

Add new handsets to make your phone more versatile (see page 43)

Your telephone can accommodate up to four cordless handsets. You can add new handsets (model E597-I, sold separately) at any time, but each must be registered with the base before use.

The handset provided with your E5926 is automatically registered as handset 1. Additional handsets will be assigned numbers in the order they are registered (handset 2, handset 3, or handset 4). You can register a maximum of four handsets.

The E5927B has two handsets automatically registered as handsets 1 and 2. You can register two additional handsets, which will then be assigned as numbers 3 and 4.

The E5937B/E1937B has three handsets automatically registered as handsets 1, 2 and 3. You can register one additional handset, which will then be assigned as number 4.

The E5947B has four pre-registered handsets. You cannot register any additional handset with the base of E5947B.



Handset 1



Handset 2



Handset 3



Handset 4



i **NOTE:** A maximum of two handsets can be used on an outside call, and the other two handsets can be used on an intercom call.

5.8 GHz Cordless Telephone/Answering System E5926/E5927B/E5937B/E5947B/E1937B

with caller ID/call waiting



Table of contents

Getting started

Quick reference guide	2
Parts checklist.....	4
Before you begin	8
Telephone base installation.....	9
Battery installation & charging	10
Wall mounting	11
Belt clip & optional headset.....	12

Telephone operation

Basic operation.....	13
Options while on calls	15
Intercom calls.....	17
Call forward	18
Call transfer.....	19
Handset settings.....	20

Directory

Directory	22
New directory entries.....	23
Directory search.....	25
To dial, delete or change entries.....	26

Caller ID operation

Caller ID log.....	27
To review the call log.....	29

Answering system operation

Answering system operation.....	30
Day and time announcements.....	31
Outgoing announcements.....	32
Announcement only mode	33
Changing feature options	34
Message playback	35
Recording and playing memos.....	36
Message counter displays.....	37
Remote access.....	38

Appendix

Screen icons, indicator lights & tones	40
Handset display screen messages	41
Adding new handsets	43
Replacing a handset.....	44
Troubleshooting	45
Important safety instructions	51
FCC Part 68 and ACTA.....	54
FCC Part 15	55
Limited warranty.....	56
Technical specifications	59
Index	60
Remote access wallet card	61

Quick reference guide

Cordless handset

▼ CID

Press to scroll down while in menus. Press to display caller ID information (see page 29). While entering names or numbers, press to move the cursor to the left.

PHONE/FLASH

Press to make or answer a call. During a call, press to receive an incoming call if call waiting is activated (see page 15).

MUTE/DELETE

While on a call, press to mute microphone (see page 16). While reviewing the call log, press to delete an individual entry, or press and hold to clear the caller ID log (see page 29). While pre-dialing, press to delete digits from a string (see page 13).

▶ SPEAKER

Press to activate handset speakerphone. Press again to resume normal handset use (see page 13).

SELECT/MENU

Press to display menu, or to select a highlighted item from menu or save an entry.

▲ DIR

Press to scroll up while in menus. Press to display directory entries (see page 25). While entering names, press to move the cursor to the right.

OFF/CLEAR

During a call, press to hang up. While using menus, press to cancel an operation, back up to the previous menu, or exit the menu display.

REDIAL/PAUSE

Press to view redial memory (see page 13). While entering numbers, press and hold to insert a dialing pause (see page 23).

INTERCOM

Press to initiate an intercom conversation, transfer or forward a call (see pages 17-19).

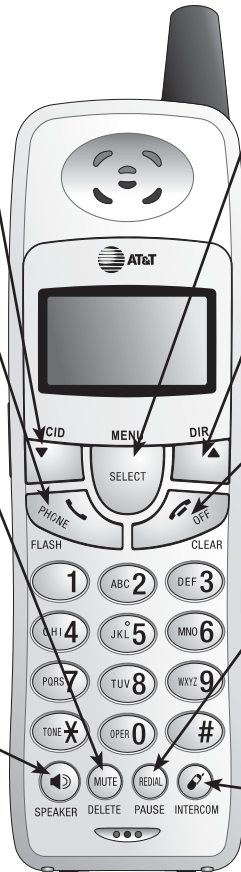

Feature menu

> shows a highlighted item

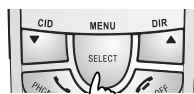
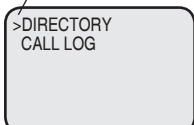

Menu

Feature menu

- DIRECTORY See page 23
- CALL LOG See page 27
- RINGER VOLUME . See page 20
- RINGER TONE..... See page 20
- KEY TONE See page 20
- LANGUAGE..... See page 21
- CLR VOICE MAIL... See page 21
- DIAL TYPE See page 21

Press ▼ or ▲ to scroll through menu items.

Press **SELECT** to select or modify a highlighted item.

Press **OFF/CLEAR** to cancel an operation, back up to the previous menu, or exit the menu display.

Quick reference guide

Telephone base



CHARGE

On when the cordless handset is properly positioned to charge in the telephone base.

IN USE

On when handset is in use or you are registering a handset. Flashes when another phone is in use on the same line, or the answering system is answering an incoming call, or you are de-registering a handset from the base.

VOLUME

Press to adjust message playback volume.

HANDSET LOCATOR

Press to make handset(s) beep (see page 14).

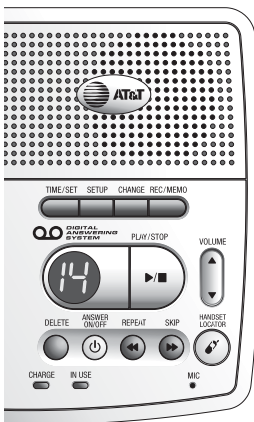

Answering system controls (see pages 30-39)

Press to play or stop playing messages.

Press to repeat message.
Hold to slow playback.
Press twice to hear previous message.



Press to skip to next message. Hold to speed up playback.

- ANSWER ON/OFF** Press to turn answering system on or off.
- DELETE** Press to delete a message during playback. Hold to delete all old messages when set is idle.
- TIME/SET** Press to review or set the answering system clock.
- SETUP** Press to review or change answering system options.
- CHANGE** Press to change a menu option.
- REC/MEMO** Press to record a memo, or after pressing SETUP, to record an outgoing announcement.

Parts checklist for E5926

Save your sales receipt and original packaging in case you need to ship your telephone for warranty service.

Check to make sure the telephone package includes the following:



Telephone base



Cordless handset



Belt clip for cordless handset



Battery pack for cordless handset



Battery compartment cover



Power adapter for telephone base

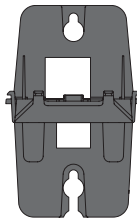

Wall mount bracket for telephone base



Telephone line cord

Parts checklist for E5927B

Save your sales receipt and original packaging in case you need to ship your telephone for warranty service.

Check to make sure the telephone package includes the following:



Telephone base



Cordless handsets

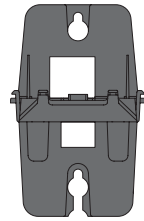

Wall mount bracket for telephone base



Charger for cordless handset

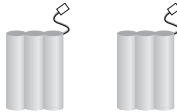

Battery packs for cordless handsets

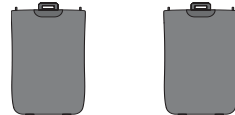

Battery compartment covers



Power adapter for telephone base



Power adapter for handset charger



Belt clips for cordless handsets



Telephone line cord

Parts checklist for E5937B/E1937B

Save your sales receipt and original packaging in case you need to ship your telephone for warranty service.

Check to make sure the telephone package includes the following:



Telephone base



Cordless handsets

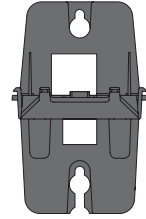

Wall mount bracket for telephone base



Belt clips for cordless handsets

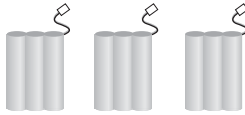

Battery packs for cordless handsets



Battery compartment covers



Chargers for cordless handsets



Power adapter for telephone base

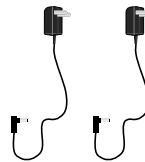

Power adapters for handset chargers



Telephone line cord

Parts checklist for E5947B

Save your sales receipt and original packaging in case you need to ship your telephone for warranty service.

Check to make sure the telephone package includes the following:



Telephone base

Cordless handsets

Wall mount bracket for telephone base



Belt clips for cordless handsets



Chargers for cordless handsets

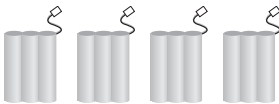

Battery packs for cordless handsets



Telephone line cord



Battery compartment covers



Power adapter for telephone base



Power adapters for handset chargers

Before you begin

About caller identification

Caller ID with call waiting features in this telephone let you see who's calling before you answer the phone, even when you're on another call. These features require services provided by your local telephone company.

Contact your telephone service provider if:

- You have both caller ID and call waiting, but as separate services (you may need combined service).
- You have only caller ID service, or only call waiting service.
- You don't subscribe to any caller ID or call waiting services.

You can use this telephone with regular caller ID service, or you can use its other features without subscribing to either caller ID or combined caller ID with call waiting service. There may be fees for these services, and they may not be available in all areas.

Caller ID features will work only if both you and the caller are in areas offering caller ID service, and if both telephone companies use compatible equipment.

See caller ID operation, beginning on page 27, for more details about how these features work.

Telephone operating range

This cordless telephone operates with the maximum power allowed by the Federal Communications Commission (FCC). Even so, the handset(s) and base can communicate over only a certain distance — which can vary with the locations of the telephone base and handset(s), the weather, the layout, and the construction of your home or office.

If you receive a call while you are out of range, the handset might not ring — or if it does ring, the call might not connect when you press **PHONE/FLASH**. Move closer to the base, then press **PHONE/FLASH** to answer the call.

If you move out of range during a telephone conversation, you might hear noise or interference. To improve reception, move closer to the base.

If you move out of range without pressing **OFF/CLEAR**, your telephone will be left off the hook. To hang up properly, walk back toward the telephone base, periodically pressing **OFF/CLEAR** until the call is disconnected.

Telephone base installation

Install the telephone base as shown below. Choose a location in a central location within the home and:

- Away from any other cordless (wireless) device such as cordless telephones, 802.11 wireless router (such as WiFi).
- Away from other electronic equipment, microwave oven, television, computer, etc. Avoid excessive heat, cold, dust or moisture.
- If you need to install your phone within the same room as other cordless phones or wireless products, you may need to select different channel(s) for your router and/or other cordless phones.

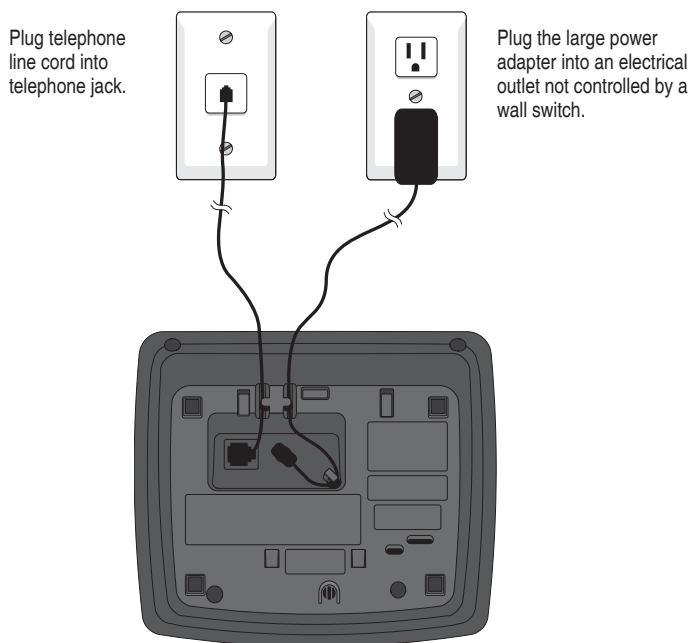

NOTES:

1. Use only the power cord supplied with this product. If you need a replacement, call 1 (800) 222-3111. In Canada, call 1 (866) 288-4268.
2. Be sure to use an electrical outlet not controlled by a wall switch.

Battery installation & charging

After battery installation, place each handset in the telephone base or a charger and allow to charge for 16 hours before use. You can keep the battery packs charged by returning the handsets to the telephone base or chargers after each use. When the battery is fully depleted, a recharge takes about 12 hours. The average talk time on a fully charged battery is about eight hours depending on environmental conditions, and the standby time is approximately four days.

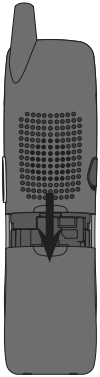

Press in and downward on the tab to open the battery compartment cover.

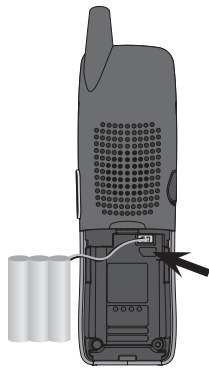

Plug the battery pack connector into handset.

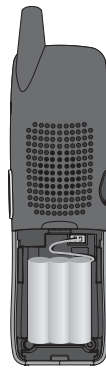

Place the battery pack and wires in the compartment.

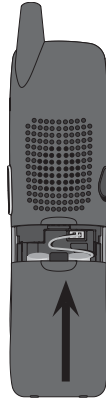

Slide battery compartment cover up until it clicks closed.

Plug power adapter into the jack on the underside of charger as shown, then plug into an electrical outlet.

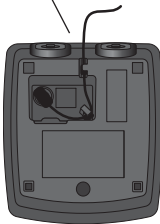

Place handset in base or charger to charge for 16 hours before first use.

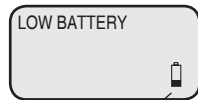

Low battery indicator
Return handset to base or charger to recharge when this symbol flashes. (Handset will beep when battery is low.)



Caution: Use only the supplied rechargeable battery or replacement battery pack (part number 80-5848-00-00).



NOTES:

1. Use only the power cord supplied with this product. If you need a replacement, call 1 (800) 222-3111. In Canada, call 1 (866) 288-4268.
2. Be sure to use an electrical outlet not controlled by a wall switch.

Wall mounting

The base can be installed on any standard wall-phone outlet as shown below. Choose a location away from electronic equipment, such as personal computers, computer routers, television sets or microwave ovens. Avoid excessive heat, cold, dust or moisture.

- 1) Connect telephone line cord and AC power cord to telephone jacks and wall jacks, as shown on page 9.
- 2) Install wall mount bracket onto set. First put the two front wall mount bracket tabs into the front notches **a** on bottom of telephone base, then squeeze the rear tabs of the wall mount bracket as you insert them into the rear notches **b** on the bottom of the telephone base.

i **NOTE:** To disassemble the wall mount bracket, squeeze the rear notches **b** while lifting up the wall mount bracket back and away from the telephone base.

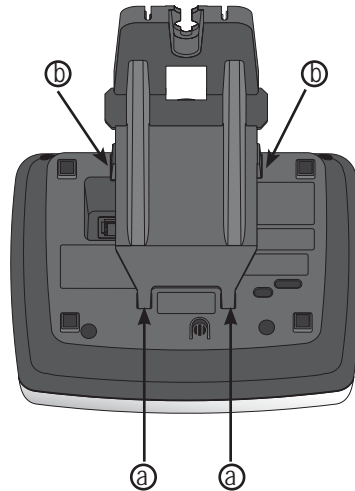

- 3) Plug power adapter into electrical outlet.
- 4) Plug telephone line cord into telephone cord wall jack.
- 5) Position the wall mount bracket over the wall outlet mounting pegs, and press and slide the wall mount bracket down firmly so it is held securely on the outlet mounting pegs.

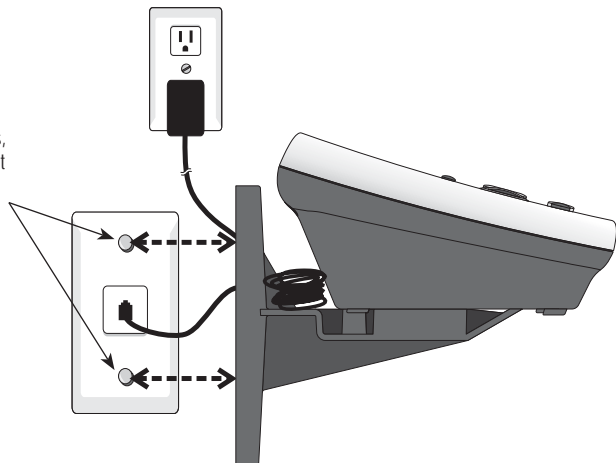

Belt clip & optional headset

Install belt clip as shown below if desired.

For hands-free telephone conversations, you can use any industry standard 2.5 mm headset (purchased separately). For best results, use an AT&T 2.5 mm headset.

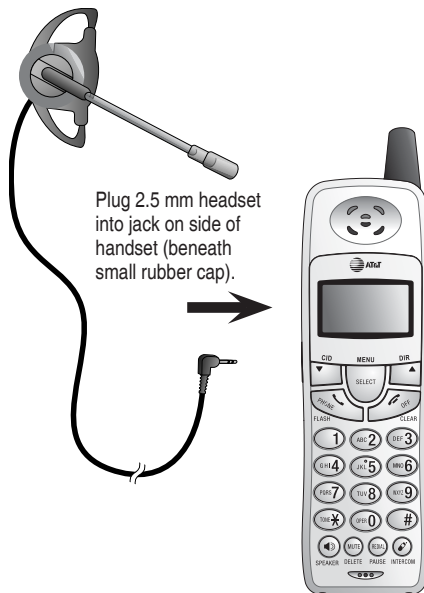
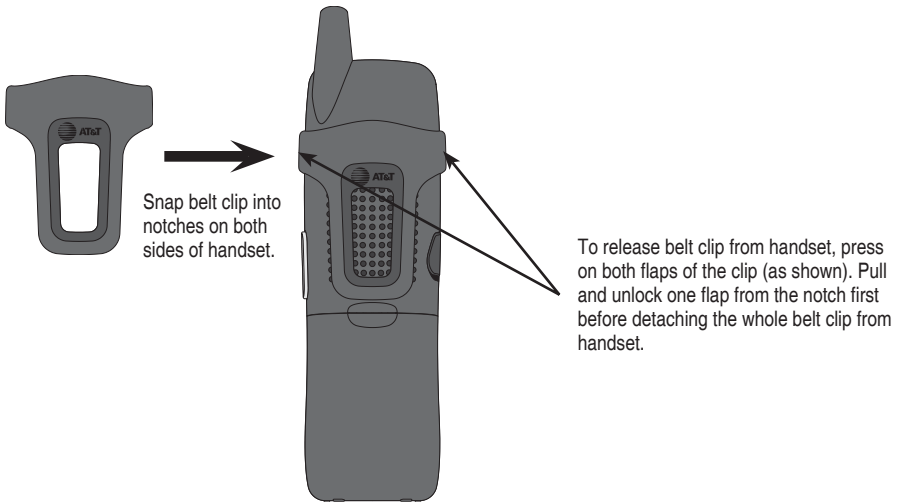

Basic operation

Making and answering calls

To answer an incoming call, press **PHONE/FLASH** or **SPEAKER**, or any dial pad key (0-9, * or #). To make a call, press **PHONE/FLASH** or **SPEAKER**, then dial a number. Press **OFF/CLEAR** to hang up.

To preview numbers before dialing, enter numbers first, then press **PHONE/FLASH** or **SPEAKER** to dial. Press **MUTE/DELETE** or **OFF/CLEAR** at any time to make corrections as you are entering numbers.

The screen displays the elapsed time as you talk (in hours, minutes and seconds).

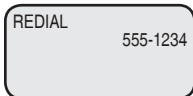
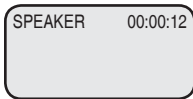
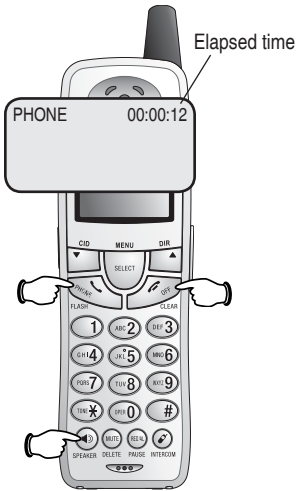

Hands-free speakerphone calls

To answer a call, press **SPEAKER**. To make a call, press **SPEAKER**, then dial a number. During a call you can press **SPEAKER** to toggle between hands-free speakerphone and normal handset use. Press **OFF/CLEAR** to hang up.

Last number redial

Before pressing **PHONE/FLASH**, press **REDIAL/PAUSE** to display the most recently called numbers (up to 32 digits). Use the **▼ ▲** buttons or **REDIAL/PAUSE** repeatedly to view up to five recently called numbers. The handset will beep twice at the beginning or end of the list.





Press **PHONE/FLASH** or **SPEAKER** to redial any displayed number or press **PHONE/FLASH** then **REDIAL/PAUSE** to call the most recently called number (up to 32 digits).

Press **MUTE/DELETE** to delete the number from the redial memory.



Basic operation

Handset locator

If you misplace the handset(s), press  **HANDSET LOCATOR** at the base. This starts the paging tone at the handset(s) for 60 seconds to help you locate it. To stop the paging tone, press  **PHONE/FLASH**,  **SPEAKER**, or any dial pad key (0-9, *, or #) at the handset(s), or press  **HANDSET LOCATOR** at the base.



NOTES:

1. The handset ringer volume also determines the level of the paging tone. If the handset ringer volume level is set to off (0), that handset will be silenced for all calls and paging (see page 20).
2. During a page, if you press  **OFF/CLEAR** on a handset, the ringer of that handset will be silenced. But the page will not be cancelled.

Options while on calls

Volume control

Press ▼ or ▲ on the **VOLUME** button on the side of the handset to adjust listening volume. Each button press raises or lowers volume by one level.

When you change the volume level, the new setting is saved.

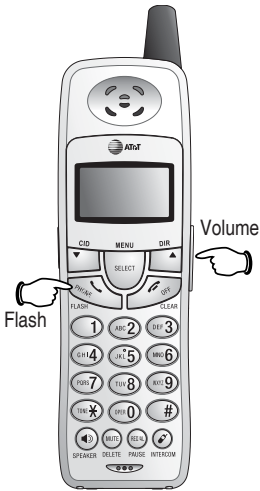

Call waiting

If you subscribe to call waiting service with your local telephone service provider, you will hear a beep if someone calls while you are already on a call. Press **PHONE/FLASH** to put your current call on hold and take the new call. You can press **PHONE/FLASH** at any time to switch back and forth between calls.

Three-way conference calls

While a call is in progress, a person at another handset can press **PHONE/FLASH** or **SPEAKER** to join the call.

A person at either handset can press **OFF/CLEAR**, or place the handset in the base or charger, to drop out of the conference call, but the call will not be terminated until all handsets hang up.

Only two handsets are allowed to connect to an outside call.

Options while on calls

Mute

Press **MUTE/DELETE** to silence the microphone. You will be able to hear the person at the other end, but they will not be able to hear you until you press **MUTE/DELETE** again and resume speaking.



Temporary ring silencing

Press **OFF/CLEAR** or **MUTE/DELETE** while the phone is ringing to silence the ringer temporarily.

The next phone call will ring normally.



NOTE: If you have more than one handset in use, all handsets ring with an incoming call. Press OFF or MUTE on one handset will only silence the ringer of that particular handset but the other handset(s) will continue to ring.

Temporary tone dialing

If you have dial pulse (rotary) service, you can switch to touch tone dialing during a call by pressing **TONES** (marked with a star icon). This can be useful if you need to send tone signals for access to answering systems or long-distance services.



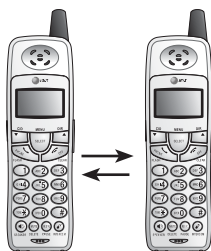

After you hang up or press **PHONE/FLASH** (to receive a call waiting call), the phone automatically returns to dial pulse (rotary) service.





Intercom calls

Intercom calls

If you have more than one handset, you can use the intercom feature to have conversations between the handsets.

- Press the  **INTERCOM** button on a handset.
- You will see INTERCOM TO:
- Enter the handset number of the handset you want to call. The display will show CALLING HANDSET X.
- The called handset will ring and the display will show HANDSET X IS CALLING.
- Press  **INTERCOM**,  **PHONE/FLASH**,  **SPEAKER** or any dial pad key (0-9, *, or #) on the handset being called to answer the call.

To end the intercom call:



- Press  **OFF/CLEAR** OR  **INTERCOM** at the handset.
- OR-**
- Place the handset in the charger or base.



NOTE: The intercom feature cannot be used while a handset is in the directory or call log. Pressing  **INTERCOM** while on an outside call will initiate call transfer (see page 19).

Handling incoming calls

The phone will beep if you receive an outside call during an intercom conversation. You can either:

- Press  **PHONE/FLASH** to end the intercom call and answer the incoming call.
- OR-**
- Press  **INTERCOM** OR  **OFF/CLEAR** to disconnect the intercom connection without answering the incoming call. The incoming call will continue to ring.

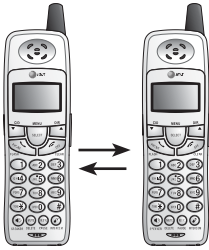

FORWARD TO:

Call forward

Call forward

If you have more than one handset, during a conversation, you can forward an external call from one handset to another handset.

- Press and hold **INTERCOM**. You will see FORWARD TO:
- Enter the handset number (1, 2, 3, or 4) to which you want to forward the call. The display will show CALL FORWARDED.
- The destination set will ring and the display will show INCOMING CALL.
- Press **PHONE/FLASH**, **SPEAKER** or any dial pad key (0-9, * or #) on the destination handset to answer the call.



NOTE: If the forwarded call is not answered within 30 seconds, the external call will be returned to the handset that originated the forward, and its display will show CALL BACK. If the returned call is not answered within an additional 30 seconds, the external call will end automatically.

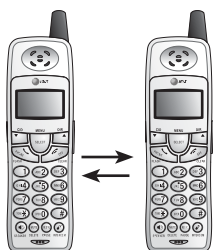

TRANSFER TO:

Call transfer

Call transfer

If you have more than one handset, during a conversation you can transfer a call to another handset.

- Press **INTERCOM** (the external call is put on hold). You will see TRANSFER TO:
- Enter the handset number (1, 2, 3, or 4) to which you want to transfer the call. The display will show CALLING HANDSET X.
- The destination set will ring, showing an intercom call. The display will show HANDSET X IS CALLING.
- Press **PHONE/FLASH**, **INTERCOM**, **SPEAKER** or any dial pad key (0-9, * or #) on the destination handset to answer the intercom call.
- When the recipient answers the intercom call, you can talk privately without the outside caller hearing the conversation.
- On the originating handset, press **OFF/CLEAR** to transfer the call. The display will show CALL TRANSFERRED.



NOTE: When the recipient answers the intercom call, the originating party can toggle between the intercom and external calls by pressing **INTERCOM**. The display will toggle between **INTERCOM** and **OUTSIDE** to indicate which party (external or intercom call) the originating party is connected to.

Telephone operation

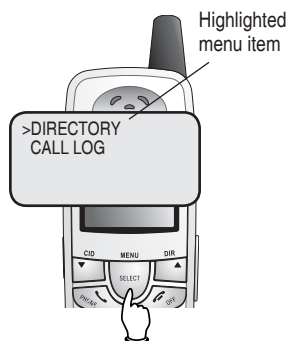

Handset settings

Using the feature menu you can change settings to customize how the telephone works.

Press **MENU**, then use the **▼▲** buttons to scroll to the feature you want to change. As you scroll through the menu, the top menu item is always highlighted with a **>** symbol. Press **SELECT** to select the highlighted item.

Press **OFF/CLEAR** at any time to cancel an operation, back up to the previous menu, or exit the menu display.

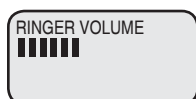

Ringer volume

Using this menu you can set a ring volume level (1-6), or turn the ringer off (0). Use the **▼▲** buttons to hear a sample of each volume level, then press **SELECT** to select the one you prefer.

-OR-

When the handset is in idle mode, press **VOLUME ▼▲** buttons on the right side of the handset to change ringer volume directly.



NOTE: The ringer volume level also determines the levels of ringing for intercom calls (see page 17) and the paging tone when initiating the handset locator feature (see page 14). If the handset ringer volume level is set to off (0), that handset is silenced for all calls and paging.



Ringer tone

This feature allows you to choose one of 10 ringing tones. Use the **▼▲** buttons to hear a sample of each ringer tone, then press **SELECT** to select the one you prefer.

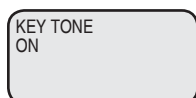

Key tone

The handset is factory programmed to beep at each key press. Use the **▼▲** buttons to select **ON** or **OFF**, then press **SELECT** to save your preference.



NOTE: If you select **OFF/CLEAR**, you will not hear the beep tone when you press keys.

Handset settings

LANGUAGE
ENGLISH

>DIRECTORY
CALL LOG

>CLR VOICE MAIL
DIAL TYPE

TURN INDICATOR
OFF?

>CLR VOICE MAIL
DIAL TYPE

DIAL TYPE
TONE

Language

At this menu, you can select the language used in all menus and screen displays. Use the ▼▲ buttons to select ENGLISH, ESPANOL or FRANCAIS, then press **SELECT** to save your preference.

Clear voice mail indication

If you subscribe to voice mail services provided by your local telephone company, you will receive a text message NEW VOICE MAIL on the handset when you have new voice mail. To manually remove the voice mail message on the display:

- Press **MENU**.
- Press the ▼ or ▲ button to highlight CLR VOICE MAIL.
- Press **SELECT**.
- Press **SELECT** again to remove the displayed message, or press **OFF/CLEAR** to exit.



NOTE: This only turns off the displayed message, it does not delete your voice mail message(s). Use this feature when the phone indicates there is voice mail when you have none. If there actually is a new voice mail message, your local telephone company will continue to send the message which turns the display message back on.

Dial type

Using this menu, you can choose TONE or PULSE dialing. The factory default setting is TONE. Change this to PULSE only if you do not have touch-tone dialing service.

Use the ▼▲ buttons to select TONE or PULSE, then press **SELECT** to save your preference.

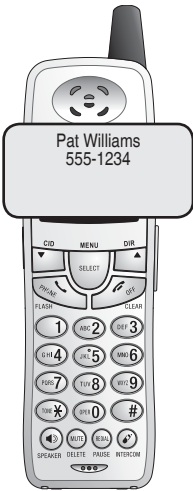

Directory

Shared directory

The directory is stored in the base, and is shared by all handsets. Changes made at any one handset will be reflected in all.



NOTE: Only one handset can review the directory at a time. If another handset attempts to enter the directory, it will display NOT AVAILABLE AT THIS TIME.

Memory capacity

The directory can store up to 50 entries. Each entry can contain a number up to 32 digits, and a name up to 16 letters long. A convenient search feature can help you find and dial numbers quickly (see page 25).

Timeouts and error messages

If you pause for too long while making an entry, the procedure will time out and you will have to begin again.

If all memory locations are in use, the screen will display LIST FULL. You will not be able to store a new number until you delete an existing one.

New directory entries

To create a new directory entry

Press **MENU**, then press **SELECT** to choose **DIRECTORY**. Press **▼** to highlight **STORE**. Press **SELECT**, then enter the telephone number when prompted.

Use the dial pad to enter up to 32 digits, or, copy a number from redial by pressing **REDIAL/PAUSE** and using **▼▲** to locate the number to copy, and then pressing **SELECT** to copy the number. Press **SELECT** to save the number in the display. The display will show **ALREADY SAVED** if the number is already in your directory.

- Press **MUTE/DELETE** to erase numbers if you make a mistake.
- Press and hold **REDIAL/PAUSE** to enter a three-second dialing pause.

To enter a name

Use the dial pad and the chart below to enter a name (up to 16 characters). Each press of a particular key will cause characters to be displayed in the following order:

Dial key	Characters by number of key presses								
	1	2	3	4	5	6	7	8	9
1	1	#	'	,	-	.	&		
2	A	B	C	2	a	b	c		
3	D	E	F	3	d	e	f		
4	G	H	I	4	g	h	i		
5	J	K	L	5	j	k	l		
6	M	N	O	6	m	n	o		
7	P	Q	R	S	7	p	q	r	s
8	T	U	V	8	t	u	v		
9	W	X	Y	Z	9	w	x	y	z
0	0								
*	*	?	!	/	()	@		
#	space								

The cursor moves to the right when you press another dial pad key or the **▲** button. Press **▼** to move the cursor to the left. Press **MUTE/DELETE** to erase letters if you make a mistake.

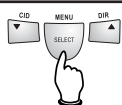
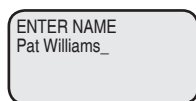
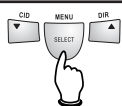
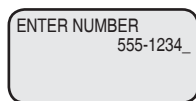
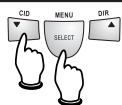
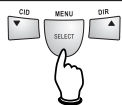
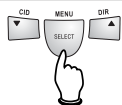

New directory entries

Storing the entry

Press **SELECT** to store your new directory entry. To change it later, see page 26.

Directory search

To browse through the directory

Press **▲/DIR** to display the first listing in the directory. You can then use the **▼** or **▲** to browse through the directory, or search to find a specific entry. Entries will be displayed alphabetically by the first letter in the name. Press **OFF/CLEAR** at any time to exit the directory.



NOTE: You can also display the first listing in the directory by first pressing **MENU**, then **SELECT** to choose DIRECTORY, and then **SELECT** again to choose REVIEW.

To search by name

While an entry is displayed in the directory, you can press a dial pad key (2-9) to start a quick name search. The directory will display the first name beginning with the first letter associated with a certain key (if there is such a name entry).



NOTES:

1. Of the dial pad or quick search keys (2-9), each key is associated with three letters, please refer to page 23 for details.
2. If there is no name entry matching the first letter of the key, the directory will display a name entry that matches the second letter of the key. If you have more than one name entry that begins with the same first letter, only by scrolling through the entire first letter entries then you can access the name entries which start with the second letter of the same key. For example, if you have name entries Jennifer, Jessie, Kevin and Linda in the directory, pressing the dial pad key 5 (JKL) once will show Jennifer, twice for Jessie, three times Kevin and four times Linda. If you press 4 (GHI), if there is no name entry which matches those letters, the directory will show Jennifer because it is the name entry which matches the next available letter (J) in the directory.

Viewing long numbers

The screen can display only 16 digits at a time. To view numbers longer than this, press ***#** or **#** to display the remaining digits.

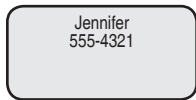
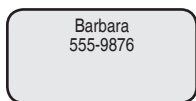
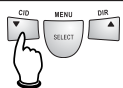
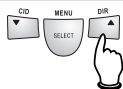

To dial, delete or change entries

To dial a displayed number

When any directory entry is displayed, press **PHONE/FLASH** (or **SPEAKER**) to dial the displayed number.

To delete an entry

When any directory entry is displayed, press **MUTE/DELETE** to delete the displayed entry from the directory. Once deleted, an entry cannot be recovered.

To change an entry

When any directory entry is displayed, press **SELECT** to modify the entry:

- You are prompted to **EDIT NUMBER**. Press **MUTE/DELETE** to erase digits. Then you can enter the correct telephone number. You can use the button to move the cursor to the left and the **▲** button to move the cursor to the right. Press and hold **REDIAL/PAUSE** to add a three-second pause if necessary. You can also press **REDIAL/PAUSE**, then **▼▲** to scroll to the previously dialed number from the redial list you want to store in the directory, then press **SELECT**.
- Press **SELECT**.
- You are now prompted to **EDIT NAME**. Press **MUTE/DELETE** to erase characters, then use the dial pad keys to enter the correct name (see page 23). You can also use the **▼** button to move the cursor to the left and the **▲** button to move the cursor to the right.
- Then press **SELECT**.

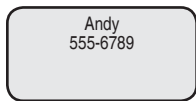
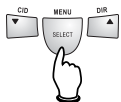
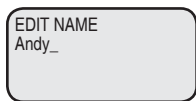
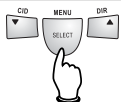
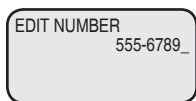
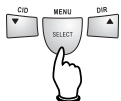
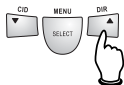



Caller ID log

Shared caller ID log

The caller ID log is stored in the base, and is shared by all handsets. Changes made at any one handset will be reflected in all.

How caller ID works

If you subscribe to caller ID service provided by your local telephone company, information about each caller will be displayed between the first and second ring.

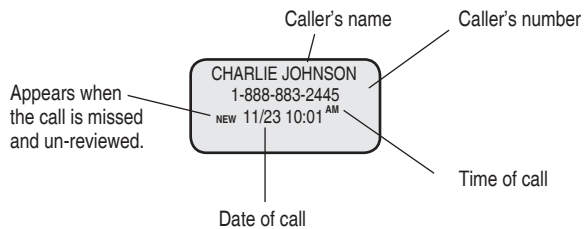

Information about the last 50 incoming calls is stored in the call log. You can review the call log to find out who has called, easily return the call, or copy the caller's name and number into your directory.

When the call log is full, the earliest entry is deleted to make room for new incoming call information.

If you answer a call before the information appears on the screen, it will not be saved in the call log.



NOTES:

1. Only one handset can review the call log at a time. If another handset attempts to enter the call log, it will display NOT AVAILABLE AT THIS TIME.
2. Caller ID features will work only if both you and the caller are in areas offering caller ID service, and if both telephone companies use compatible equipment.
3. When in idle mode, the cordless handset screen will show XX MISSED CALLS. The call log review displays the caller ID numbers in reverse chronological order, with the latest one first.

Each time a call log entry marked NEW is displayed, the number of new calls decreases by one. Any entries which have not been reviewed will be counted as MISSED CALLS when the phone is idle.

Caller ID log

About names

Names of callers will be displayed only if the information is provided by your local telephone company.

If the telephone number of the person calling matches an exact number in your directory, the name that appears on screen will match the name as you entered it into your directory.

(Example: If Christine Smith calls, her name will appear as Chris if this is how you entered it into your directory.)

HANDSET 1
6 MISSED CALLS

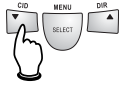

Pat Williams
555-1234
NEW 11/23 10:31 AM

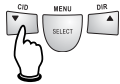

Chris Thompson
908-555-0100
NEW 11/23 10:21 AM

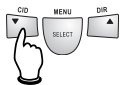

Jeffrey Adams
555-9876
NEW 11/23 10:11 AM

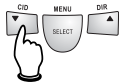

NOTE: If both the name and number are not provided, **UNABLE TO SAVE** will be displayed.

Caller ID operation

To review the call log

To review the call log

Press **CID/▼** to review the call log. The most recent call is displayed first. Use the arrow buttons to scroll through the list as shown at left.

To return a call

Press **PHONE/FLASH** (or **SPEAKER**) to call the number as displayed.

Caller ID numbers may appear with an area code that may not be required for local calls, or without a **1** that may be needed for long distance calls. If the number displayed is not in the correct format, you can change how it is dialed.

To change the number before calling, press **#** repeatedly to see different dialing options (you can choose to dial with or without an area code, and with or without the **1**), then press **PHONE/FLASH** (or **SPEAKER**) to place the call.

Example:

CID.....Number displayed as **908-555-0100**

(three times)Number changes to **555-0100** (drops **1** + area code)

PHONE/

SPEAKER.....Dials **555-0100**

Other options

- Press **MUTE/DELETE** to delete this entry from the call log.
- Press and hold **MUTE/DELETE** to delete all entries from the call log. When asked to confirm, press **SELECT** to clear the call log of all entries, or press **OFF/CLEAR** to exit and leave all call log entries intact.
- Press **SELECT** to copy this entry into your directory. If the name or number is not provided, you will be prompted to enter them (see page 23).

Answering system operation

Message capacity

The answering system can record up to 99 messages, depending on the length of each message. Individual messages can be up to four minutes long, and total maximum recording time is 15 minutes. Messages will remain available for replay until you delete them.

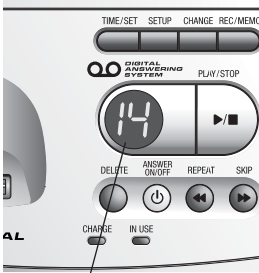

Message counter

Number of messages (or, during playback, message number currently playing).

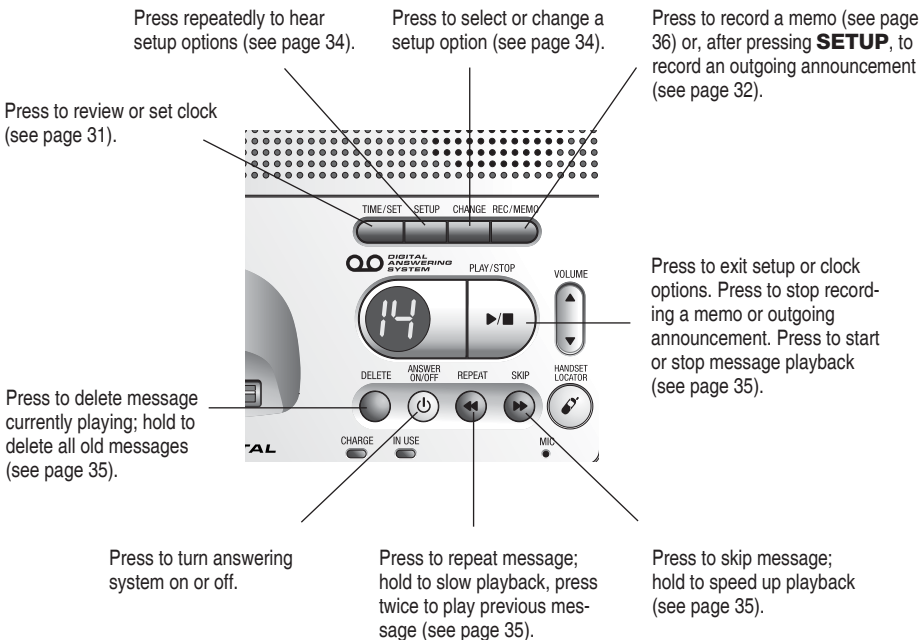

Day and time announcements

To set day and time

Before playing each message, the answering system announces the day and time the message was received.

Before using the answering system, you should follow the steps at left to set the day and time, so messages are dated correctly.

The system uses voice prompts to guide you. Each time you press **CHANGE**, the day, hour, minute or year advances by one. When you hear the correct setting, press **TIME/SET** to move to the next setting.

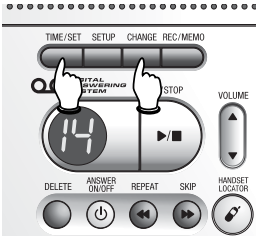

1.  Press **TIME/SET**

The system will announce the current clock setting, then announce *“To begin setting the clock, press TIME/SET, then press CHANGE to change the setting or press TIME/SET to continue.”*

2.  Press **TIME/SET**

3.  Press **CHANGE**

until the system announces the correct day, then press **TIME/SET**.

4.  Press **CHANGE**

until the system announces the correct hour, then press **TIME/SET**.

5.  Press **CHANGE**

until the system announces the correct minutes, then press **TIME/SET**.

6.  Press **CHANGE**

until the system announces the correct year, then press **TIME/SET**. The system announces the current clock setting.

To check day and time

You can press **TIME/SET** at any time to hear the current day and time without changing it.



NOTES:

1. Press and hold **CHANGE** to advance the minute or year by increments of 10 (the year can be set from 2000 to 2039).
2. Caller ID provides the time and date. Set the year so that the day of the week can be calculated from the caller ID information. After you set the time once, it will thereafter be set automatically with incoming caller ID information. The time will be set automatically only if you subscribe to caller ID service provided by your local telephone company (see page 8).

Outgoing announcements

Outgoing announcements are the messages callers hear when calls are answered by the answering system.

The phone is pre-programmed with announcements for normal (answer and record) mode and for announcement only mode (see page 33). If the phone is set up to record messages, the phone answers calls with **“Hello. Please leave a message after the tone.”** You can use this announcement, or replace it with a recording of your own voice.

To record your outgoing announcement

Press **SETUP** until you hear **“Announcement. Press PLAY or press RECORD. To continue setup, press SETUP.”** Then press **REC/MEMO** and begin speaking after you hear **“Record after the tone.”** Press **STOP** when you are done. Press **PLAY/STOP** when you are done.

Elapsed time (in seconds) will be shown in the message window as you record. You can record an announcement up to 90 seconds long. Announcements less than three seconds long will not be recorded.

To delete your outgoing announcement

Press **SETUP** until you hear **“Announcement. Press PLAY or press RECORD. To continue setup, press SETUP.”** Then press **PLAY/STOP** to begin playback. Press **DELETE** during playback to delete your announcement.

When your announcement is deleted, calls will be answered with the pre-programmed announcement described above.

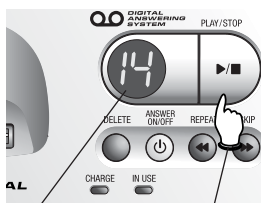

Elapsed recording time (in seconds).

Press to stop recording.

1. **SETUP**

“Announcement. Press PLAY or ...”

2. **(Play/Stop)**

(Plays announcement previously recorded).

-OR-

2. **REC/MEMO**

“Record after the tone...”

3. Speak into microphone.

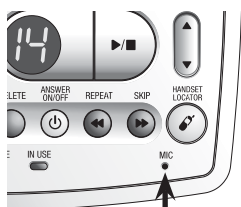

Microphone

4. **(Play/Stop)**

(Announcement is played back).

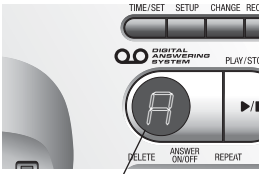

A is displayed when Announcement Only is activated.

1. SETUP



"Announcement only, record no messages. To change the setting press CHANGE."

2. CHANGE



"Off"

3. CHANGE



"On"

4. (Play/Stop)



Beep
(Option selected).

Announcement only mode

In announcement only mode, callers hear an announcement but cannot leave messages.

To turn announcement only on or off

Press **SETUP** repeatedly until you hear **"Announcement only, record no messages. To change the setting press CHANGE."** Then press **CHANGE** until you hear the option you want (on or off). Press **PLAY/STOP** to store your selection and exit, or press **SETUP** again to modify other features (see page 34).

To record your outgoing announcement

When announcement only is turned on, calls are answered with a pre-recorded announcement that says **"We're sorry, messages to this number cannot be accepted."** You can use this announcement, or replace it with a recording of your own voice.

After turning on the announcement only feature, follow the steps on page 32 to record your announcement. Callers will hear this announcement only when the announcement only feature is turned on. Otherwise they will hear the pre-programmed announcement asking them to leave a message.

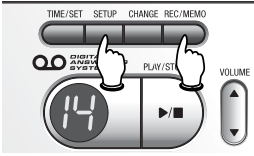

Answering system operation

Changing feature options

You can change how the answering system operates. Press **SETUP** repeatedly to hear each feature. Press **CHANGE** when you hear the feature you want to modify.

1. **SETUP**

Press until desired feature is heard (see list at right).

2. **CHANGE**

Press until desired selection is heard.

3. **SETUP**

Press to set selection and move to next menu option.

-OR-



(Play/Stop)

Press to set selection and exit setup.



NOTE: To switch off the message alert tone for all incoming messages, read the section on disabling the message alert function in the list on the right.

Feature options (Default settings underlined>)

System announces:	Feature description:
<p>"Announcement. Press PLAY or press RECORD. To continue setup, press SETUP." Options: [record announcement]</p>	<p>Press REC/MEMO to record outgoing announcement (see page 32). Press STOP to stop recording.</p>
<p>"Remote access code. To change the setting press CHANGE." Options: [enter 2-digit code] <u>19</u></p>	<p>Enter a two-digit number (10-99) for remote access from another phone (see page 38).</p>
<p>"Message alert. To change the setting press CHANGE." Options: On / <u>Off</u></p>	<p>When the answering system is turned on (the ANSWER ON/OFF light is lit) and the message alert function is activated, any new incoming message will increase the flashing number in the message window by one, and a beep tone will sound every ten seconds as a reminder that there are unreviewed messages on the answering system.</p>
<p>"Announcement only, record no messages. To change the setting press CHANGE." Options: On / <u>Off</u></p>	<p>When on, callers hear an announcement but cannot leave messages (see page 33).</p>
<p>"Base ringer. To change the setting press CHANGE." Options: <u>On</u> / Off</p>	<p>Choose this option to turn the base ringer on or off (does not affect handset).</p>
<p>"Number of rings. To change the setting press CHANGE." Options: 2 / <u>4</u> / 6 / toll saver</p>	<p>Choose number of rings before the system answers a call. When toll saver is active, the system answers after two rings if you have new messages, and after four rings if you have no new messages.</p>



NOTES:

1. Press and hold **CHANGE** to advance the remote access code number by 10.
2. To temporarily disable the message alert tone, press any answering machine key (**TIME/SET**, **SETUP**, **CHANGE**, **REC/MEMO**, **PLAY/STOP**, **DELETE**, **REPEAT** and **SKIP**) or the **VOLUME** key on the base. This turns off the audio message alert tone but the number in the message window will continue to flash as a reminder that there are unreviewed messages on the answering system. The message alert tone will be re-activated with the next incoming message.

Number of messages (or, during playback, message number currently playing).

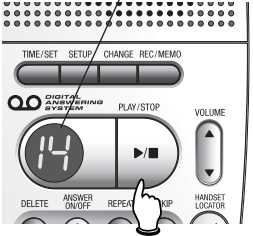

Press **PLAY/STOP** to begin or end message playback.

1. **PLAY/STOP** (Play/Stop)

"You have [xx] new messages and [xx] old messages."

Message playback begins. See options at right.

2. **PLAY/STOP** (Play/Stop)

Message playback ends.



NOTES:

1. If **F** is flashing in the message window, memory is full. You will have to delete some messages before new ones can be recorded.
2. New (unheard) messages cannot be deleted.

Answering system operation

Message playback

Press **PLAY/STOP** to hear messages. The system announces the number of messages, then begins playback.

If you have new messages, you will hear only the new messages (earliest first). If there are no new messages, the system will play back all messages (earliest first).

Announcements

- When playback begins, you will hear the total number of messages.
- Before each message, you will hear the day and time it was received.
- After the last message, you will hear "**End of messages.**" If the system has less than five minutes of recording time left, it will announce the remaining time.

Options during playback

- Press the **VOLUME** button to adjust speaker volume.
- Press **SKIP** to skip to next message (or hold down to speed up message playback).
- Press **REPEAT** to repeat message currently playing. Press twice to hear previous message (or hold down to slow message playback).
- Press **DELETE** to delete message being played back.
- Press **PLAY/STOP** to stop playback.

To delete all old messages

To delete all old messages, press and hold **DELETE** while the phone is idle (not during a call, or during message playback). New or unheard messages cannot be deleted.

Recording and playing memos

Memos are messages you record yourself. They are saved, played back and deleted exactly like incoming messages. You can record a memo as a reminder to yourself, or leave a message for someone else if others in your household use the answering system.

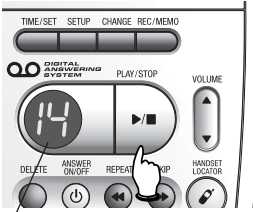

Elapsed recording time (in seconds). Press to stop recording.

1. **REC/MEMO**



“Record after the tone. Press STOP when you are done.”

2. Speak into microphone.

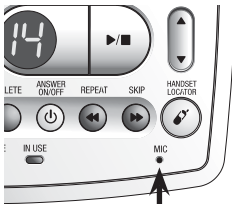

Microphone

3. **(Play/Stop)**



“Recorded” then beep (Memo has been recorded).

To record a memo

Press **REC/MEMO**. Elapsed time (in seconds) is shown in the message window as you record. You can record a memo up to four minutes long. Memos less than one second long will not be recorded.

Press  **PLAY/STOP** to stop recording.

To play back a memo

Press  **PLAY/STOP** to hear messages and memos (see page 35 for other options).

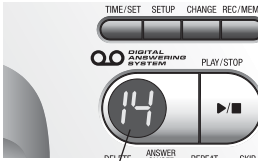

Message counter

Answering system operation

Message counter displays

The message counter usually displays the total number of memos and incoming messages. See the list below for explanations of other displays in this counter.

Message counter displays

□	No messages.
1-99	Number of messages/memos, or message number currently playing (flashes if you have new messages).
10-99	Current remote access code while setting (see page 34).
1-8	Current volume level while adjusting.
1-99 (counting)	Elapsed time while recording a memo (see page 36) or announcement up to 90 seconds (page 32).
99 (flashing)	Memo recording exceeded 99 seconds.
F (flashing)	Memory is full. Messages must be deleted before new messages can be received.
CL (flashing)	Clock needs to be set (see page 31).
A	Announcement only mode is on (see page 33).
--	System is answering a call, or being accessed remotely.
-- (flashing)	System is being programmed or initialized.
□n (or) □F	Displayed for one second when any answering system setting is turned on or off.
02, 04, 06, 85	Current number of rings while setting (see page 34).

Remote access

1. Dial your telephone number from any touch-tone phone.
2. When system answers, enter a two-digit remote access code (19 unless you have changed it).
3. Enter remote commands (see list at right).
4. Hang up to end call and save all undeleted messages.



NOTE: If you pause for more than 10 seconds during remote access, you will hear a help menu listing all features & commands. If you issue no command for another 20 seconds, the call will end automatically.

A two-digit security code is required to access your answering system from any touch-tone phone. This code is **19** by default; see page 34 to change it.

Play all messages 	Press to hear all messages.
Play new messages 	Press to hear new messages.
Delete the message 	Press during playback to delete current message. Press 3 twice to delete all old messages while in remote access idle mode (message not being played).
Repeat or go back 	Press during the caller's message to repeat the message. Press during the beginning of the day and time announcement to go back to the previous caller's message.
Stop 	Press to stop any operation (stop playback, stop recording).
Skip to next message 	Press to skip current message and advance to next message.
Review announcement 	Press to review current outgoing announcement.
Record announcement 	Press * 7 , wait for beep, then begin speaking. Press 5 to stop recording and hear playback of the new announcement.
Record memo 	Press 8 , wait for beep, then begin speaking. Press 5 to stop recording.
Review remote access code 	Press # 9 to review remote access code.
Change remote access code 	Press * 9 to change remote access code, then enter desired remote access code from 10-99.

Remote access

Help menu



Press to hear list of features & commands.

Turn system off



Press to turn off answering system. Incoming calls will no longer be answered.

Turn system on





If off, system will answer after 10 rings. Enter your access code, then press 0 to turn it on.

Screen icons, indicator lights & tones

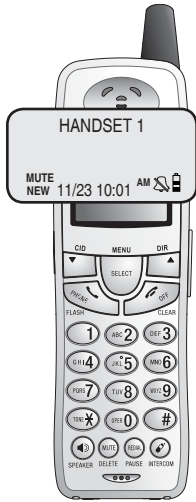
Screen icons & alert tones



Screen icons

-  Ringer off.
-  Battery charging (animated display).
-  Low battery (flashing); place handset in base or charger to recharge.
- MUTE** Microphone is muted.
- NEW** Missed and un-reviewed calls.

Handset alert tones

- Two short beeps** Press **▲ VOLUME** keys while the volume levels are already at limits.
- Four short beeps** Low battery warning.
- Two beeps** Out of range during off-hook.
- Confirmation tone** Programming command completed successfully.

Base tones

- One beep every 10 seconds** Message alert.
- A series of beeps** Press **▲ VOLUME** keys while the volume levels are already at limits.

Indicator lights

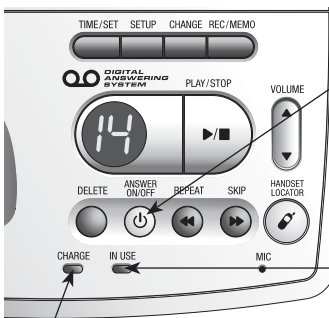

CHARGE

On when handset is in the cradle of the telephone base and charging.

ANSWER ON/OFF

On when answering system is on and ready to receive calls.

IN USE

On when handset is in use or you are registering a handset. Flashes when another phone is in use on the same line, or answering system is answering an incoming call, or you are de-registering a handset from the base.

SPEAKER

On when speakerphone is in use.



Handset display screen messages



Screen display messages

<i>PHONE</i>	The handset is in use.
<i>ENDED</i>	You have just ended a call.
<i>CALL LOG EMPTY</i>	You are accessing an empty call log.
<i>DIRECTORY EMPTY</i>	You are accessing an empty directory.
<i>LIST FULL</i>	You are saving to a full directory.
<i>MUTED</i>	The call is on mute.
<i>SPEAKER</i>	The handset speakerphone is in use.
<i>LOW BATTERY</i>	The battery needs to be recharged.
<i>INCOMING CALL</i>	There is a call coming in.
<i>NEW VOICE MAIL</i>	There are new voice mail messages.
<i>XX MISSED CALLS</i>	There are new calls in the caller ID log.
<i>CONNECTING ...</i>	The handset has lost communication with the base.
<i>** PAGING **</i>	The base is paging handset(s).
<i>HANDSET X IS CALLING</i>	Another handset is calling.
<i>LINE IN USE</i>	An extension phone is in use.
<i>NO LINE</i>	There is no telephone line connected.
<i>ALREADY SAVED</i>	The telephone number you have entered is already stored in the directory.
<i>SAVED</i>	The call log entry is saved to the directory successfully.
<i>WARNING CHECK BATTERY!</i>	<ul style="list-style-type: none"> • The battery is not installed or not installed properly in the handset. -OR- • The battery needs to be replaced. -OR- • An incorrect battery has been installed by mistake. Use only supplied battery or AT&T replacement battery pack (part number 80-5848-00-00).
<i>PLACE IN CHARGER</i>	The battery is very low. The handset should be placed in the telephone base or charger.

Handset display screen messages



Screen display messages

<i>CHARGING</i>	A handset with a low battery has been placed in the telephone base or charger.
<i>UNABLE TO CALL TRY AGAIN</i>	Failed intercom or conference call (there are already two handsets being used).
<i>NOT AVAILABLE AT THIS TIME</i>	Someone else is already using the directory or call log when you try to do so.
<i>MICROPHONE ON</i>	The call switches from being on mute to normal call.
<i>INTERCOM TO</i>	The handset is to initiate an intercom call to another handset. (You have to press the handset number of the destination handset.)
<i>INTERCOM ENDED</i>	The intercom call has just been ended by you or the receiver of the call.
<i>CALLING HANDSET X</i>	The handset is calling another handset (for intercom calls).
<i>FORWARD TO</i>	The handset is to forward an external call to another handset.
<i>TRANSFER TO</i>	The handset is to transfer a put-on-hold external call to another handset.
<i>NO SIGNAL, CALL ENDED</i>	The handset is out of range while on a call.

Adding new handsets

Your telephone can accommodate up to four cordless handsets. You can add new handsets (E597-I, sold separately) to the E5926, E5927B, E5937B and E1937B at any time, but each handset must be registered with the base before use.

The handset provided with your E5926 is automatically registered as handset 1. Additional handsets will be assigned numbers in the order they are registered (handset 2, handset 3, or handset 4). You can register a maximum of four handsets.

The E5927B has two handsets automatically registered as handset 1 and 2. You can register two additional handsets, which will be assigned number 3 and 4.

The E5937B/E1937B has three handsets automatically registered as handset 1, 2 and 3. You can register one additional handset, which will be assigned number 4.

The E5947B has four pre-registered handsets, so you cannot register any additional handset to it.

NOT REGISTERED

PRESS HNDST LOC
4 SEC ON BASE

HS X REGISTERED



Handset 1 Handset 2 Handset 3



Handset 4

Before using a new E597-I handset, you must register it with the base.

To add a new handset:

- When first purchased, all optional accessory handsets show NOT REGISTERED on the screen.
- Make sure your handset battery is properly installed and charged.
- Put the handset in its charger which is plugged into AC power. After a few seconds **PRESS HNDST LOC 4 SEC ON BASE** will be shown on the screen.
- Press and hold  **HANDSET LOCATOR** on the main telephone base until the **IN USE** light comes on (about four seconds), then release the button.
- The handset will show PLEASE WAIT... for a while.
- The handset will show HS X REGISTERED and beep once if registration was successful.





NOTES:

1. You can register only one handset to the base at a time.
2. If you are on a call, using the call log or directory, or another phone is on the same line, you cannot register a handset.
3. If the registration is not successful, the display will show NOT REGISTERED. Reset the handset by lifting the handset out of the cradle and then place the handset back in the cradle. Now try the registration process again.

Replacing a handset

If you are replacing a handset on a system that has the maximum number of registered handsets (four) or wish to change the assigned handset number of your registered handsets, you must first de-register the handsets, then de-registration all handsets.

To de-register all handsets



- Press and hold  **HANDSET LOCATOR** on the main telephone base until the **IN USE** light starts to turn on then flash (about 10 seconds), then release the  **HANDSET LOCATOR** button.
- Press and release  **HANDSET LOCATOR** again. The **IN USE** light will turn off and in a few seconds, all handsets will be de-registered.
- All handsets will show NOT REGISTERED if de-registration was successful.



NOT REGISTERED



NOTES:

1. If the de-registration process was not successful, you may need to reset the system and try again. To reset: pick up the handset and press the  **PHONE/FLASH** button, then press the  **OFF/CLEAR** button and place the handset back into the cradle.
2. You can only de-register handsets when the handsets and the base are not being used.
3. To re-register the handset to the telephone base, follow the registration instructions on page 43.

Troubleshooting

If you have difficulty with your phone, please try the suggestions below. For Customer Service, visit our web site at www.telephones.att.com, or call 1 (800) 222-3111. In Canada, call 1 (866) 288-4268.

My phone doesn't work at all

- Make sure the power cord is securely plugged in.
- Make sure that the battery pack connector is securely plugged into the cordless handset.
- Make sure the telephone line cord is securely and firmly plugged into the telephone base and the telephone wall jack.
- Charge the battery pack in the cordless handset for at least 16 hours. For optimum daily performance, return the cordless handset to its base when not in use.
- Reset the base. Unplug the unit's electrical power. Wait for approximately 15 seconds, then plug it back in. Allow up to one minute for the cordless handset and base to reset.
- You may need to purchase a new battery pack, please refer to page 10 of this user's manual.

I cannot get a dial tone

- First try all the suggestions above.
- Move the cordless handset closer to the base. You might have moved out of range.
- Your line cord might be malfunctioning. Try installing a new line cord.
- If the previous suggestions don't work, disconnect the base unit from the telephone jack and connect to a different phone. If there is no dial tone on that phone either, the problem is in your wiring or local service. Contact your local telephone company.

I cannot dial out

- First try all the suggestions above.
- Make sure you have a dial tone before dialing. The cordless handset may take a second or two to find the base and produce a dial tone. This is normal. Wait an extra second before dialing.
- Make sure your phone is set to the correct dial mode for the type of service that you have (pulse or touch tone). Refer to the **Telephone operation** section of this user's manual (page 21) to set the dial mode.
- If the other phones in your home are having the same problem, the problem is in your wiring or local service. Contact your local telephone company (charges may apply).
- Eliminate any background noise. Noise from a television, radio or other appliances may cause the phone to not dial out properly. If you cannot eliminate the background noise, first try muting the cordless handset before dialing, or dialing from another room in your home with less background noise.

Troubleshooting

My cordless handset isn't performing normally

- Make sure the power cord is securely plugged into the base. Plug the unit into a different, working electrical outlet not controlled by a wall switch.
- Move the cordless handset closer to the base. You might have moved out of range.
- Reset the base. Unplug the unit's electrical power. Wait for 15 seconds then plug it back in. Allow up to one minute for the cordless handset and base to reset.
- Other electronic products can cause interference to your cordless phone. Try installing your phone as far away from these types of electronic devices as possible: wireless routers, radios, radio towers, pager towers, cell phones, intercoms, room monitors, televisions, personal computers, kitchen appliances and other cordless phones.

CONNECTING... displays on my cordless handset

- Ensure that the base is powered up.
- Place the cordless handset in the base for one minute to allow the cordless handset and base to resynchronize channels.
- Move the cordless handset closer to the base. You might have moved out of range.
- If the cordless handset is in its base and the charging light does not come on, refer to **The charge light is off** in this troubleshooting guide.
- Reset the base. Unplug the unit's electrical power. Wait for 15 seconds then plug it back in. Allow up to one minute for the cordless handset and base to reset.
- Other electronic products can cause interference with your cordless phone. Try installing your phone as far away from these types of electronic devices as possible: wireless routers, radios, radio towers, page towers, cell phones, intercoms, room monitors, televisions, personal computers, kitchen appliances and cordless phones.

The batteries will not hold a charge

- Charge the battery in the cordless handset for at least 16 hours. For optimum daily performance, return the cordless handset to its base when not in use.
- You may need to purchase a new battery, please refer to the battery section of this user's manual.
- Your phone might be malfunctioning. Please refer to the Limited warranty section of this user's manual for further instruction.
- If the cordless handset is in its base and the charging light does not come on, refer to **The charge light is off** in this troubleshooting guide.

Troubleshooting

I get noise, static, or weak signal even when I'm near the base

- Other cordless phones and 802.11 wireless routers that are used for home computer networks both use internal radios to communicate. The radios may interfere with one another. You can improve the performance of your cordless phones and your router by:
 - a. Positioning your new phone as far away as possible from any other existing cordless telephone system that is already installed in your home to avoid the two systems from interfering with each other.
 - b. Positioning your telephone base as far as possible from your router, computer or any other computer devices.
 - c. Selecting channels 4 through 10 for your router (refer to your router's user manual for more information).
- Other electronic products can cause interference to your cordless phone. Try installing your phone as far away from the following electronic devices as possible: wireless routers, radios, radio towers, pager towers, cell phones, intercoms, room monitors, televisions, personal computers, kitchen appliances and other cordless phones.
- Microwaves operate on the same frequency as your phone. It is normal to experience static on your phone while the microwave oven is operating. Do not install this phone in the same outlet or near a microwave oven.
- If your phone is plugged in with a modem or a surge protector, plug the phone (or modem/surge protector) into a different location. If this solves the problem, re-locate your phone or modem farther apart from one another, or use a different surge protector.
- Relocate your phone to a higher location. The phone will likely have better reception when not installed in a low area.
- If the other phones in your home are having the same problem, the problem is in your wiring or local service. Contact your local telephone company (charges may apply).
- If you subscribe to DSL service and if you hear noise during conversations and/or your caller ID features are not functioning properly, install a DSL filter to the telephone line between the telephone base and the telephone line jack. Contact your DSL provider to obtain a DSL filter.

I hear other calls while using my phone

- Disconnect the telephone base from the telephone jack, and plug in a different telephone. If you still hear other calls, the problem is probably in your wiring or local service. Call your local telephone company.

I hear noise in the cordless handset, and none of the keys or buttons work

- Make sure the power cord is plugged in securely.

Troubleshooting

My cordless handset does not ring when I receive a call

- Make sure that the ringer is not turned off. Refer to the section(s) on ringer selection in this user's manual.
- Make sure the telephone line cord is plugged securely into the telephone base and the telephone jack. Make sure the power cord is securely plugged in.
- The cordless handset may be too far from the telephone base.
- Charge the battery in the cordless handset for at least 16 hours. For optimum daily performance, return the cordless handset to its base when not in use.
- You may have too many extension phones on your telephone line to allow all of them to ring simultaneously. Try unplugging some of the other phones.
- The layout of your home or office might be limiting the operating range. Try moving the base to another location, preferably on an upper floor.
- If the other phones in your home are having the same problem, the problem is in your wiring or local service. Contact your local telephone company (charges may apply).
- Test a working phone at the phone jack. If another phone has the same problem, the problem is the phone jack. Contact your local telephone company (charges may apply).
- Other electronic products can cause interference with your cordless phone. Try installing your phone as far away as possible from electronic devices like wireless routers, radios, radio towers, pager towers, cell phones, intercoms, room monitors, televisions, personal computers, kitchen appliances and other cordless phones.
- Your line cord might be malfunctioning. Try installing a new line cord.
- Re-install the battery pack, and place cordless handset in base cradle.
- Wait for the cordless handset to re-establish its connection with the base. To be safe, allow up to one minute for this to take place.

My calls fade out or cut in and out while I'm using my cordless handset

- Other electronic products can cause interference with your cordless phone. Try installing your phone as far away from the following electronic devices as possible: wireless routers, radios, radio towers, pager towers, cell phones, intercoms, room monitors, televisions, personal computers, kitchen appliances and other cordless phones.
- Microwaves operate on the same frequency as your phone. It is normal to experience static on your phone while the microwave oven is operating. Do not install this phone in the same outlet or near the microwave oven.
- If your phone is plugged in with a modem or surge protector, plug the phone (or modem/surge protector) into a different location. If this solves the problem, re-locate your phone or modem farther apart from one another, or use a different surge protector.

Troubleshooting

- Relocate your telephone base to a higher location. The phone will have better reception when not installed in a low area.
- If the other phones in your home are having the same problem, the problem is in your wiring or local service. Contact your local telephone company (charges may apply).

The charge light is off

- Clean the cordless handset and base charging contacts each month using a pencil eraser or cloth.
- Make sure the power and line cords are plugged in correctly and securely.
- Unplug the unit's electrical power. Wait for 15 seconds, then plug it back in. Allow up to one minute for the cordless handset and base to reset.
- Your phone might be malfunctioning. Please refer to the Limited warranty section of this user's manual for further instruction.

My caller ID isn't working

- Caller ID is a subscription service. You must subscribe to this service from your local telephone company for this feature to work on your phone.
- Your caller must be calling from an area that supports caller ID.
- Both you and your caller's telephone companies must use caller ID compatible equipment.

System does not receive caller ID or system does not display caller ID during call waiting

- Make sure you subscribe to caller ID with call waiting features services provided by your local telephone company. Caller ID features will work only if both you and the caller are in areas offering caller ID service, and if both telephone companies use compatible equipment.

Common cure for electronic equipment

If the unit does not seem to be responding normally, try putting the cordless handset in its base. If it does not seem to respond, do the following (in the order listed):

- Disconnect the power to the base.
- Disconnect the cordless handset battery, and spare battery, if applicable.
- Wait a few minutes.
- Connect power to the base.
- Re-install the battery pack, and place the cordless handset into the base.
- Wait for the cordless handset to re-establish its connection with the base. To be safe, allow up to one minute for this to take place.

Troubleshooting

Incomplete messages

- If a caller leaves a very long message, part of it may be lost when the system disconnects the call after four minutes.
- If the caller pauses for more than seven seconds, the system stops recording and disconnects the call.
- If the system's memory becomes full during a message, the system stops recording and disconnects the call.
- If the caller's voice is very soft, the system may stop recording and disconnects the call.

Difficulty hearing messages

- Press **VOLUME**  to increase speaker volume.

System does not answer after correct number of rings

- Make sure that the answering system is on (see page 30).
- If toll saver is activated, the number of rings changes to two when you have new messages waiting (see page 34).
- In some cases, the system may be affected by the ringing system used by the local telephone company.
- If the memory is full or the system is off, the system will answer after 10 rings.

CL flashes in message window

- You need to reset the answering system clock (see page 31).

System does not respond to remote commands

- Make sure to enter your remote access code correctly (see page 38).
- Make sure you are calling from a touch-tone phone. When you dial a number, you should hear tones. If you hear clicks, the phone is not a touch-tone telephone and cannot activate the answering system.
- The answering system may not detect the remote access code while your announcement is playing. Try waiting until the announcement is over before entering the code.
- There may be noise or interference on the phone line you are using. Press dial pad keys firmly.

System does not record message

- Make sure answering system is on (see page 30).
- Make sure announcement only is off.

Announcement message is not clear

- When you record your announcement, make sure you speak in a normal tone of voice, about nine inches from the base.
- Make sure there is no background noise (TV, music, etc.) while you are recording.

Important safety instructions



This symbol is to alert you to important operating or servicing instructions that may appear in this user's manual. Always follow basic safety precautions when using this product to reduce the risk of injury, fire, or electric shock.

Safety information

- **Read and understand all instructions in the user's manual. Observe all markings on the product.**
- **Avoid using a telephone during a thunderstorm.** There may be a slight chance of electric shock from lightning.
- **Do not use a telephone in the vicinity of a gas leak.**
If you suspect a gas leak, report it immediately, but use a telephone away from the area where gas is leaking. If this product is a cordless model, make sure the base is also away from the area.
- **Do not use this product near water, or when you are wet.** For example, do not use it in a wet basement or shower, or next to a swimming pool, bathtub, kitchen sink, or laundry tub. Do not use liquids or aerosol sprays for cleaning. If the product comes in contact with any liquids, unplug any line or power cord immediately. Do not plug the product back in until it has dried thoroughly.
- **Install this product in a protected location** where no one can trip over any line or power cords. Protect cords from damage or abrasion.
- **If this product does not operate normally, read Troubleshooting in this user's manual.** If you cannot solve the problem, or if the product is damaged, refer to the limited warranty. Do not open this product except as may be directed in your user's manual. Opening the product or reassembling it incorrectly may expose you to hazardous voltages or other risks.
- **If this product has user-replaceable batteries, replace batteries only as described in your user's manual.** Do not burn or puncture batteries — they contain caustic chemicals.
- **If this product has a three-prong (grounding) plug or a polarized plug with one wide prong,** it may not fit in non-polarized outlets. Do not defeat the purpose of these plugs. If they do not fit in your outlet, the outlet should be replaced by an electrician.



CAUTION: Use only the power adapter provided with this product. To obtain a replacement, call 1 (800) 222-3111. In Canada, call 1 (866) 288-4268.

Important safety instructions

Especially about cordless telephones

- **Privacy:** The same features that make a cordless phone convenient create some limitations. Telephone calls are transmitted between the base and the handset by radio waves, so there is a possibility that your cordless phone conversations could be intercepted by radio receiving equipment within range of the cordless handset. **For this reason, you should not think of cordless phone conversations as being as private as those on corded phones.**
- **Electrical power:** The base unit of this cordless telephone must be connected to a working electrical outlet. The electrical outlet should not be controlled by a wall switch. **Calls cannot be made from the handset if the base unit is unplugged or switched off, or if the electrical power is interrupted.**
- **Potential TV interference:** Some cordless telephones operate at frequencies that may cause interference to TVs and VCRs. To minimize or prevent such interference, do not place the base unit of the cordless telephone near or on top of a TV or VCR. If interference is experienced, moving the cordless telephone farther away from the TV or VCR will often reduce or eliminate the interference.
- **Rechargeable batteries:** This product contains either nickel-cadmium or nickel-metal hydride rechargeable batteries. Exercise care in handling batteries in order not to short the battery with conducting material such as rings, bracelets, and keys. The battery or conductor may overheat and cause harm. Observe proper polarity between the battery and the battery charger.
- **Nickel-cadmium rechargeable batteries:** Must be recycled or disposed of properly. Do not dispose of in household garbage. Do not burn or puncture. Like other batteries of this type, if burned or punctured, they could release caustic material which could cause injury.



The RBRC™ Seal means that the manufacturer is voluntarily participating in an industry program to collect and recycle nickel-cadmium rechargeable batteries when taken out of service within the United States.

These batteries may be taken to a participating local retailer of replacement batteries or recycling center. Or you may call 1 (800) 8 BATTERY for locations accepting spent nickel-cadmium Batteries. **Nickel-metal hydride rechargeable batteries:** Dispose of these batteries in a safe manner. Do not burn or puncture. Like other batteries of this type, if burned or punctured, they could release caustic material which could cause injury.

- **Nickel-metal hydride rechargeable batteries:** Dispose of these batteries in a safe manner. Do not burn or puncture. Like other batteries of this type, if burned or punctured, they could release caustic material which could cause injury.

Important safety instructions

Precautions for users of implanted cardiac pacemakers

Cardiac pacemakers (applies only to 900 MHz digital cordless telephones):

Wireless Technology Research, LLC (WTR), an independent research entity, led a multidisciplinary evaluation of the interference between portable wireless telephones and implanted cardiac pacemakers. Supported by the U.S. Food and Drug Administration, WTR had recommended to physicians that:

Pacemaker patients

- Should keep wireless phones at least six inches from the pacemaker.
- Should NOT place wireless phones directly over the pacemaker, such as in a breast pocket, when it is turned ON.
- Should use the wireless phone at the ear opposite the pacemaker.

WTR's evaluation did not identify any risk to bystanders with pacemakers from other persons using wireless phones.

Especially about telephones answering systems

Two-way recording: This unit does not sound warning beeps to let the other party know that the call is being recorded. To ensure that you are in compliance with any federal or state regulations regarding recording a telephone call, you should start the recording process and then inform the other party that you are recording the call.

SAVE THESE INSTRUCTIONS

FCC Part 68 and ACTA

This equipment complies with Part 68 of the FCC rules and with technical requirements adopted by the Administrative Council for Terminal Attachments (ACTA). The label on the back or bottom of this equipment contains, among other things, a product identifier in the format US:AAAEQ##TXXXX. This identifier must be provided to your local telephone company upon request.

The plug and jack used to connect this equipment to premises wiring and the telephone network must comply with applicable Part 68 rules and technical requirements adopted by ACTA. A compliant telephone cord and modular plug is provided with this product. It is designed to be connected to a compatible modular jack that is also compliant. An RJ11 jack should normally be used for connecting to a single line and an RJ14 jack for two lines. See Installation Instructions in the user's manual.

The Ringer Equivalence Number (REN) is used to determine how many devices you may connect to your telephone line and still have them ring when you are called. The REN for this product is encoded as the 6th and 7th characters following the US: in the product identifier (e.g., if ## is 03, the REN is 0.3). In most, but not all areas, the sum of all RENs should be five (5.0) or less. For more information, please contact your local telephone company.

This equipment may not be used with Party Lines. If you have specially wired alarm dialing equipment connected to your telephone line, ensure the connection of this equipment does not disable your alarm equipment. If you have questions about what will disable alarm equipment, consult your telephone company or a qualified installer.

If this equipment is malfunctioning, it must be unplugged from the modular jack until the problem has been corrected. Repairs to this telephone equipment can only be made by the manufacturer or its authorized agents. For repair procedures, follow the instructions outlined under the Limited Warranty.

If this equipment is causing harm to the telephone network, the telephone company may temporarily discontinue your telephone service. The telephone company is required to notify you before interrupting service. If advance notice is not practical, you will be notified as soon as possible. You will be given the opportunity to correct the problem and the telephone company is required to inform you of your right to file a complaint with the FCC. Your telephone company may make changes in its facilities, equipment, operation, or procedures that could affect the proper functioning of this product. The telephone company is required to notify you if such changes are planned. If this product is equipped with a corded or cordless handset, it is hearing aid compatible.

If this product has memory dialing locations, you may choose to store emergency telephone numbers (e.g., police, fire, medical) in these locations. If you do store or test emergency numbers, please:

- Remain on the line and briefly explain the reason for the call before hanging up.
- Perform such activities in off-peak hours, such as early morning or late evening.

FCC Part 15

This equipment has been tested and found to comply with the requirements for a Class B digital device under Part 15 of the Federal Communications Commission (FCC) rules. These requirements are intended to provide reasonable protection against harmful interference in a residential installation. This equipment generates, uses and can radiate radio frequency energy and, if not installed and used in accordance with the instructions, may cause harmful interference to radio communications. However, there is no guarantee that interference will not occur in a particular installation. If this equipment does cause harmful interference to radio or television reception, which can be determined by turning the equipment off and on, the user is encouraged to try to correct the interference by one or more of the following measures:

- Increase the separation between the equipment and receiver.
- Connect the equipment into an outlet on a circuit different from that to which the receiver is connected.
- Consult the dealer or an experienced radio/TV technician for help.

Changes or modifications to this equipment not expressly approved by the party responsible for compliance could void the user's authority to operate the equipment. To ensure safety of users, the FCC has established criteria for the amount of radio frequency energy that can be safely absorbed by a user or bystander according to the intended usage of the product. This product has been tested and found to comply with the FCC criteria. The handset may be safely held against the ear of the user. The base unit shall be installed and used such that parts of the user's body other than the hands are maintained at a distance of approximately 20 cm (8 inches) or more. If you choose to use a clipping device, please make sure to only use the supplied AT&T belt clip.

Limited warranty

The AT&T brands are used under license. Any repair, replacement or warranty service, and all questions about this product should be directed to: Advanced American Telephones, **1 (800) 222-3111** or **www.telephones.att.com**. In Canada, call **1 (866) 288-4268**.

1. What does this limited warranty cover?

The manufacturer of this AT&T-branded product, Advanced American Telephones (“AAT”), warrants to the holder of a valid proof of purchase (“CONSUMER” or “YOU”) that the product and all accessories provided by AAT in the sales package (“PRODUCT”) are free from material defects in material and workmanship, pursuant to the following terms and conditions, when installed and used normally and in accordance with operation instructions. This limited warranty extends only to the consumer for products purchased and used in the United States of America.

2. What will AAT do if the product is not free from material defects in materials and workmanship during the limited warranty period (“MATERIALLY DEFECTIVE PRODUCT”)?

During the limited warranty period, AAT’s authorized service representative will repair or replace, at AAT’s option, without charge, a materially defective product. If AAT repairs this product, AAT may use new or refurbished replacement parts. If AAT chooses to replace this product, AAT may replace it with a new or refurbished product of the same or similar design. AAT will return repaired or replacement products to you in working condition.

AAT will retain defective parts, modules, or equipment. Repair or replacement of product, at AAT’s option, is your exclusive remedy. You should expect the repair or replacement to take approximately 30 days.

3. How long is the limited warranty period?

The limited warranty period for the product extends for ONE (1) YEAR from the date of purchase.

If AAT repairs or replaces a materially defective product under the terms of this limited warranty, this limited warranty also applies to repaired or replacement products for a period of either (a) 90 days from the date the repaired or replacement product is shipped to you or (b) the time remaining on the original one-year limited warranty, whichever is longer.

Limited warranty

4. What is not covered by this limited warranty?

This limited warranty does not cover:

- product that has been subjected to misuse, accident, shipping or other physical damage, improper installation, abnormal operation or handling, neglect, inundation, fire, water, or other liquid intrusion; or
- product that has been damaged due to repair, alteration, or modification by anyone other than an authorized service representative of AAT; or
- product to the extent that the problem experienced is caused by signal conditions, network reliability or cable or antenna systems; or
- product to the extent that the problem is caused by use with non-AAT accessories; or
- product whose warranty/quality stickers, product serial number plates or electronic serial numbers have been removed, altered or rendered illegible; or
- product purchased, used, serviced, or shipped for repair from outside the United States, or used for commercial or institutional purposes (including but not limited to products used for rental purposes); or
- product returned without valid proof of purchase (see 6 below); or
- charges for installation or setup, adjustment of customer controls, and installation or repair of systems outside the unit.

5. How do you get warranty service?

To obtain warranty service in the United States of America, call **1-800-222-3111** (In Canada, please dial **1-866-288-4268**) for instructions regarding where to return the product. Before calling for service, please check the user's manual. A check of the product controls and features may save you a service call.

Except as provided by applicable law, you assume the risk of loss or damage during transit and transportation and are responsible for delivery or handling charges incurred in the transport of product(s) to the service location. AAT will return repaired or replaced product under this limited warranty to you, transportation, delivery or handling charges prepaid. AAT assumes no risk for damage or loss of the product in transit.

If the product failure is not covered by this limited warranty, or proof of purchase does not meet the terms of this limited warranty, AAT will notify you and will request that you authorize the cost of repair prior to any further repair activity. You must pay for the cost of repair and return shipping costs for the repair of products that are not covered by this limited warranty.

Limited warranty

6. What must you return with the product to get warranty service?

You must:

- a return the entire original package and contents including the product to the AAT service location along with a description of the malfunction or difficulty;
- b include “valid proof of purchase” (sales receipt) identifying the product purchased (product model) and the date of purchase or receipt (keep a copy for your records); and
- c provide your name, complete and correct mailing address, and telephone number.

7. Other limitations

This warranty is the complete and exclusive agreement between you and AAT. It supersedes all other written or oral communications related to this product. AAT provides no other warranties for this product. The warranty exclusively describes all of AAT’s responsibilities regarding the product. There are no other express warranties. No one is authorized to make modifications to this limited warranty and you should not rely on any such modification.

State Law Rights: This warranty gives you specific legal rights, and you may also have other rights which vary from state to state.

Limitations:

Implied warranties, including those of fitness for a particular purpose and merchantability (an unwritten warranty that the product is fit for ordinary use) are limited to one year from date of purchase.

Some states do not allow limitations on how long an implied warranty lasts, so the above limitation may not apply to you.

In no event shall AAT be liable for any indirect, special, incidental, consequential, or similar damages (including, but not limited to lost profits or revenue, inability to use the product, or other associated equipment, the cost of substitute equipment, and claims by third parties) resulting from the use of this product.

Some states do not allow the exclusion or limitation of incidental or consequential damages, so the above limitation or exclusion may not apply to you.

Please retain your receipt as your proof of purchase.

Technical specifications

RF frequency band (handset to base)	2400 MHz — 2483.5 MHz
RF frequency band (base to handset)	5725 MHz — 5850 MHz
Channels	95
Operating temperature	32°F — 122°F 0°C — 50°C
Base unit voltage (AC voltage, 60Hz)	96 — 130 Vrms
Base unit voltage (AC adapter output)	9VDC @600mA
Handset voltage	3.2 — 4.7 VDC 700mAh
Charger voltage (AC adapter output)	9VDC @200mA
Replacement battery	Battery pack (80-5848-00-00) 3.6V 700mAh

Index

A

AC adapter, 9
Adding new handsets, 43
Alert tones, 40
Answering calls, 13
Answering system, 30-39

B

Battery charging, 10
Battery installation, 10
Belt clip, 12

C

Call waiting, 15
Call transfer, 19
Caller ID, 27
 add entries to phone directory, 29
 delete entries, 29
 dial entries, 29
CID, 27
Clear voice mail indication, 21

D

Delete call log entries, 29
Delete redial entries, 13
Dialing,
 from a CID record, 29
 directory dialing, 26
Directory, 22
 dial number, 26
 edit entries, 26
 name search, 25
 new entries, 23

E

Elapsed time, 13
Ending calls, 13

F

Flash (switchhook flash), 15

H

Hands-free use, 13
Handset locator, 14
Headset, 12

I

Intercom, 17
Incoming call log, 27
Incoming calls, answering, 13
Indicator lights, 40

L

Last number redial, 13
Low battery, 10

M

Making calls, 13
Menus, 20
Messages, 30-39
Mute, 16

N

Names,
 enter into directory, 23
 search for, 25

O

Operating range, 8

Q

Quick reference guide, 2-3

R

Receiving calls, 13
Recharging, 10
Redial, 13
Replacing a handset, 44
Ring silencing, 16
Ring tone options, 20

S

Search for names, 25
Speakerphone, 13
Switchhook flash, 15

T

Technical specifications, 59
Troubleshooting, 45

V

Volume controls, 15

Remote access wallet card

Use the wallet card below to help you remember commands to control your answering system from any touch tone telephone.

Cut along dotted line.



Call your phone number, then enter your two-digit access code (preset to 19).

Action	Remote command
--------	----------------

Play all messages	1
Play new messages	2
Delete the message	3
Delete all old messages	3 3
Repeat or go back.....	4
Stop	5
Help menu	* 5

Fold here.

Skip the message	6
Review announcement.....	# 7
Record announcement.....	* 7
Record memo	8
Review remote access code..	# 9
Change remote access code..	* 9
Answer machine ON/OFF ...	0

5.8 GHz Cordless Telephone/Answering System E5926/E5927B/E5937B/EI937B/E5947B

Copyright © 2006 Advanced American Telephones. All rights reserved. AT&T and the Globe Design are trademarks of AT&T Corp., licensed to Advanced American Telephones. Printed in China.



www.telephones.att.com

Copyright © 2006 Advanced American Telephones. All rights reserved.
AT&T and the Globe Design are trademarks of AT&T Corp.,
licensed to Advanced American Telephones. Printed in China. Issue 4 AT&T 06/06.
91-000648-040-000