



USER'S MANUAL  
Part 2

# AT&T Small Business System Speakerphone with Digital Answering System and Caller ID Call Waiting 984

---



For Customer Service Or Product  
Information, Visit Our Website At  
[www.telephones.att.com](http://www.telephones.att.com)

Please also read  
**Part 1 — Important  
Product Information**



In case of difficulty, visit our Service Center at  
**[www.telephones.att.com](http://www.telephones.att.com)** or call **1 800 222-3111**.

# CONTENTS

<b>PRODUCT OVERVIEW</b> .....	1	Program Home and Local Area Codes .....	40
<b>BEFORE YOU BEGIN</b> .....	2	Assign the Line Group for this Phone .....	41
Parts List .....	2	Erase All Settings and Return the Phone to Default Settings .....	42
Tools Needed .....	2	Set Answering System Status .....	43
DSL Users .....	4	Set Your Phone for Single Phone Operation .....	44
Glossary .....	5	Set Answer Delay .....	45
Programmable Features List .....	8	Set Auto-Attendant Pickup Delay .....	46
Audible Signals .....	12	Set Auto-Attendant Day and Night Times .....	47
<b>INSTALLATION</b> .....	13	Turn Toll Saver On or Off .....	49
Battery Installation .....	13	Program the Remote Code .....	50
Table/Desk Installation .....	15	Set Message Length .....	51
Wall Installation .....	17	Turn Audible Message Alert On or Off .....	52
Convenience Ports .....	21	Turn Monitor On or Off .....	53
<b>MENU OPERATION</b> .....	22	Turn D-TAD Intercept On or Off .....	54
Menu Structure .....	23	Set This Phone to be the Centrex Console Phone .....	55
Shortcut to Language Menu .....	24	Set the Centrex Console Delayed Ring Time .....	56
Rapid Scroll .....	24	Set the Display Language .....	56
<b>FEATURE SETUP</b> .....	25	<b>TELEPHONE</b> <b>OPERATION</b> .....	57
Set One Touch Preference .....	25	Make or Answer a Call .....	57
Assign an Extension Number to Your Phone .....	26	Switch Between Handset, Headset and Speakerphone .....	59
Turn the Ringer On or Off for Each Line .....	27	Timer .....	59
Select the Ringer Type .....	28	Call Privacy .....	60
Set Delay Ring .....	29	Do Not Disturb .....	60
Turn Auto-Mute On or Off .....	30	Volume .....	61
Set Dial Mode .....	31	Redial .....	61
Turn Hold Reminder On or Off .....	31	Redial Stack .....	62
Set the Time and Date .....	32	Auto Redial .....	62
Turn Line Usage On or Off for Each Line .....	33	Hold .....	63
Assign the Prime Line (Line Preference) .....	34	Switch Between Lines .....	63
Set Automatic Mode .....	35	Mute .....	64
Set the Scroll Rate .....	36	Flash .....	64
Turn Screen Backlight On or Off .....	37	Temporary Tone Dialing .....	64
Turn COVM Indicators On or Off for Each Line .....	38		
Reset COVM Indicator .....	39		

Conference Calls .....65  
 Transfer a Call .....66  
 Low Battery Indicator .....67  
 Lights and What They Mean .....68

**ONE TOUCH OPERATION** .....70

Store a Number in a One Touch Location .....71  
 Review a One Touch Entry .....73  
 Dial a One Touch Number .....74

**DIRECTORY OPERATION** .....75

Menu Structure .....75  
 Store a Name and Number in the Directory .....76  
 Review Directory Entries .....79  
 Edit a Directory Entry .....80  
 Dial a Number from the Directory .....81  
 Remove a Name and Number from the Directory .....81  
 Remove All Entries from the Directory .....82

**INTERCOM OPERATION** .....83

Basic Intercom Operations .....84  
 Make an Intercom Call with the Handset .....85  
 Make an Intercom Call with the Speakerphone or Headset .....86  
 Answer an Intercom Call .....87  
 End an Intercom or Page Call .....87  
 Page a Specific Extension (Single-phone Page) .....88  
 Answer a Single-phone Page .....88  
 Page All System Phones .....89  
 Answer a System-wide Page .....89  
 Make an Intercom Conference Call .....90  
 Room Monitor .....90

**CALLER ID OPERATION** .....91

Menu Structure .....92  
 Caller ID Display .....92  
 Call Waiting .....93

Calls Received on Two or More Lines Simultaneously .....93  
 Display Screen Messages .....94  
 Message Waiting and NEW CALL Light .....95  
 Call History .....95  
 Remove Calls from Call History .....97  
 Dial a Number from Call History .....98  
 Save a Name and Number from Call History to the Directory ..99  
 Save a Number from Call History to a One Touch Location .....100

**ANSWERING SYSTEM**

**(D-TAD) OPERATION** .....101

Turn Answering System On/Off .....101  
 Enter D-TAD Mode .....101  
 Menu Structure .....102  
 Record an Outgoing Announcement .....103  
 Review an Outgoing Announcement .....104  
 Remove an Outgoing Announcement .....105  
 Monitor Incoming Calls .....105  
 Intercept an Incoming Message .....105  
 Listen to Your Messages .....106  
 Remove Messages .....108  
 Record a Memo .....108  
 Record a Phone Conversation ..109  
 Audible Message Alert .....109

**ANSWERING SYSTEM**

**AUTO-ATTENDANT OPERATION** | 10

Auto-Attendant Sequence for Callers .....111  
 Review an Auto-Attendant Outgoing Announcement .....112  
 Record an Auto-Attendant Outgoing Announcement .....113

Remove an Auto-Attendant Outgoing Announcement .....	114
Using Multiple Auto-Attendants .....	115

## **ANSWERING SYSTEM**

<b>REMOTE OPERATION</b> .....	116
Connect with the Answering System .....	116
Remote Commands .....	117

## **ADDING A**

<b>FAX MACHINE</b> .....	118
Using a Fax Switch .....	118

## **GENERAL PRODUCT**

<b>CARE</b> .....	119
-------------------	-----

## **TECHNICAL**

<b>SPECIFICATIONS</b> .....	120
-----------------------------	-----

<b>IN CASE OF DIFFICULTY</b> ..	121
---------------------------------	-----

## **EXPANDING THE PHONE**

<b>SYSTEM</b> .....	128
Line Groups .....	128
Private Lines .....	129

<b>CENTREX OPERATION</b> .....	130
--------------------------------	-----

Setup Checklist .....	130
Enable the Console Phone .....	130
Console Operation .....	130
Set Ring Delay Duration .....	131
Answer a Delayed Ring .....	131
Pick Up Another Station's Line ..	131

<b>INDEX</b> .....	132
--------------------	-----

# PRODUCT OVERVIEW

This AT&T Small Business System Speakerphone with Digital Answering System and Caller ID Call Waiting 984 is expandable to a 16-extension telephone system. The 984 is compatible with AT&T 945, 974, 944, 955 and 964 telephones. (See BEFORE YOU BEGIN starting on page 2 and EXPANDING THE PHONE SYSTEM beginning on page 128 for details.)

The 984 is hearing-aid compatible and can be connected to up to four incoming telephone lines. This phone features a speakerphone for hands-free use and a headset jack compatible with most two-band 2.5mm headsets (sold separately). The 984 allows paging, intercom and call transfers between system phones and is capable of connecting three parties in a conference call. This phone also features a 32-number memory for faster dialing and has a directory which can store up to 200 additional numbers with names. This phone has a Caller ID feature which supports Caller ID with Call Waiting service. (Caller ID services are subscriber services available from many local telephone companies for a fee.) There are two convenience ports available for connecting the phone to another device such as a fax machine or modem.

Your 984 also features a built-in digital answering system able to store approximately 20 minutes of messages, memos, phone calls and announcements for a total of up to 99 messages. You can access the answering system from a remote, non-system touch tone phone or from another system phone. This 984 telephone is equipped to function as an Auto-Attendant in a multi-phone system. An Auto-Attendant phone can pick up and redirect incoming calls to other extensions in your phone system. You may designate more than one Auto-Attendant for your phone system. (See ANSWERING SYSTEM AUTO-ATTENDANT OPERATION beginning on page 110 for details.)

The 984 is compatible with Centrex service. Centrex is a special subscriber service which may be available from your local telephone company for a fee. If you subscribe to Centrex service, refer to the CENTREX OPERATION section of this manual, beginning on page 130.

This User's Manual contains detailed instructions for installing, programming and operating your AT&T Small Business System Speakerphone with Digital Answering System and Caller ID Call Waiting 984. Please be sure to read BEFORE YOU BEGIN starting on page 2 before installing this phone.

# BEFORE YOU BEGIN

## Parts List

Your box should include:

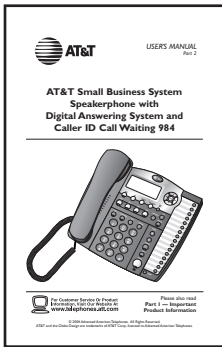

This User's Manual

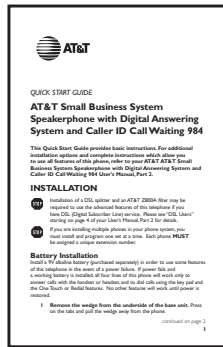

Quick Start Guide

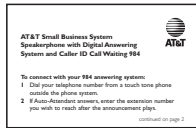

Wallet Card



Eight-inch line cord

Two seven-foot twisted pair line cords

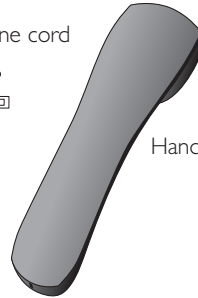
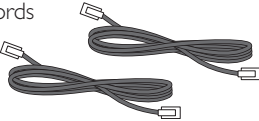

Handset

Base unit with wedge attached



Coiled handset cord



Power adapter

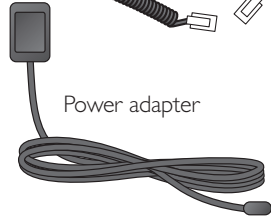

## Tools Needed

You will also need a small Phillips head screw driver to install your phone.

This 984 telephone is fully compatible with any AT&T Four-Line Intercom Speakerphone 945 or 974 units you may have installed. You can use a total of 16 945/974/984 units together as extensions in your phone system.

This 984 telephone is also compatible with any AT&T 964/955/944 phones you have previously installed. This 984 telephone is **NOT** compatible with any 843, 853, 854, 874, or 954 telephones you may have previously installed.

 **NOTE:** If you have one or more 964, 955, or 944 phone(s) installed in the same phone system with this 984 telephone, you can have only 12 extensions and 15 telephone lines in the phone system.

- You must have a modular telephone jack and an electrical outlet not controlled by a wall switch near where you're installing the phone.



The total length of telephone wiring used in this system **MUST NOT** be more than 600 feet. In some cases a Z800A filter can be used in a phone system with more than 600 feet of wire.

**AT&T highly recommends that a Z800A filter be installed by a professional. AT&T CANNOT guarantee that this telephone will work with such a filter, and IS NOT responsible for the cost of such installations or for arranging the installation. A Z800A filter can be obtained by calling 1 800 222-3111.**

- Identify the number of phone lines you'll use.
- Plan the layout of your phone system.
- All connected phones must have the same Line 1 phone number for the Intercom and Page features to work.



Every individual phone in your telephone system **MUST** be assigned a unique extension number for the Intercom feature to work. If you try to assign the same extension number to a second phone, you will hear a repeating short ring and the the screen display will include EXT XX is already used Assign new EXT #. See "Assign an Extension Number to Your Phone" on page 26 of this manual for directions.

- Decide if you want a private line. A private line does not appear on all connected phones.
- Choose your setting for each feature. You will need to program the features after installation. See "Programmable Features List" beginning on page 8 for a brief description of the features. See the FEATURE SETUP section beginning on page 25 for programming instructions.



## DSL Users



Installation of a DSL splitter and an AT&T Z800A filter is required to use the advanced features of this telephone if you have DSL (Digital Subscriber Line) service.

### Set-Up for DSL Users

If you are a DSL (Digital Subscriber Line) customer, you may experience interference with the advanced features of this telephone. Certain features of this phone (e.g., intercom, hold, line privacy, etc.) work by sending a data signal using Line 1. This data signal is sent at some of the same frequencies as those used by your DSL service. Microfilters are used to block the high frequency DSL signals from being transmitted through and interfering with your telephones. These same microfilters that may have been installed for your DSL service will also block the data signals between your system phones. Therefore, some features of this phone may not work properly when DSL filters are installed in your building. This problem can occur even if the DSL line is not one of the lines used by the phone system. If you use the microfilters that your DSL service provider may have supplied when you activated DSL service with this phone, some of the phone features will not work. Once the DSL splitter (described below) is installed, you should no longer experience interference.

Installation, by your DSL service provider or other professional, of a DSL splitter (not a “microfilter”) **AND** an AT&T Z800A Isolation filter as close as possible to the “protection block” or “network interface” (where the telephone line enters the house) may resolve DSL interference. (It may be necessary to use a DSL splitter intended for outdoor use.) A DSL splitter allows the data and voice signals to use the same telephone line without interfering with each other. An AT&T Z800A filter isolates the splitter from your phone system and reduces interference with the signals used by the system phones to communicate with each other.

You can obtain an AT&T Z800A filter at no charge by calling **1 800 222-3111**. You will also receive a diagram showing the proper installation of the AT&T Z800A filter with a DSL splitter, DSL modem and your system phones. AT&T cannot supply the DSL splitter.

Please contact your DSL service provider or professional contractor for details about obtaining and installing a DSL splitter. Your DSL service provider may require you to bear any installation costs. AT&T and the manufacturer of this product have no affiliation with your DSL provider and the type or quality of services they offer. Installation must be performed at your own expense and AT&T cannot troubleshoot or provide installation support.

**NOTE:** If your DSL service provider cannot supply a DSL splitter, it is possible to purchase an outdoor DSL splitter (such as a Corning or Allen Tel brand DSL splitter) over the Internet.

If you are a new DSL customer, your DSL service provider will likely ask you if you have more than one telephone line in your home or business. If you answer yes, your DSL service provider will probably advise you that you need a splitter. Your DSL service provider may also ask if you are installing a phone system. If you answer yes, your DSL service provider will most likely advise you that you need a splitter. In most cases, your DSL service provider will supply you with the proper splitter for your specific situation. The DSL splitter, installed properly and in conjunction with a Z800A filter, should help overcome any interference between the DSL signal and the signals sent by your phone system.

AT&T shall not be responsible for the cost of installation, any damages, lost business, direct or indirect expenses accrued or associated with installation, or other compatibility issues which may arise as a result of using this product while you subscribe to DSL service.

## Glossary

**Auto-Attendant:** A 984 phone in your multi-phone system designated to pick up a ringing line automatically after a selected number of rings. The Auto-Attendant plays the selected outgoing announcement and redirects the call if the caller enters an extension number. You can designate up to 16 Auto-Attendants in your phone system.

**Caller ID:** Caller Identification is a subscriber service available from most local telephone companies for a fee. When you subscribe to Caller Identification, you can see who's calling before you answer the phone if you and the caller are both in areas offering Caller ID service with compatible equipment.

**Caller ID with Call Waiting:** This is a single, combined subscriber service which may be available from your local telephone company. If you subscribe to this service, you can use your 984 telephone to see who's calling even while you are on another call (as long as your caller is in an area with Caller ID service and both telephone companies use compatible equipment).

**Centrex Service:** A special subscriber service which may be available from your local telephone company for a fee. This 984 telephone can be used with Centrex Service.

**COVM:** Central Office Voice Mail is a subscriber voice message service which may be available from your local telephone company. This service may be called by another name in your area (e.g., Call Answering).

## Glossary

continued from page 5

**DND:** When activated, the Do Not Disturb (DND) feature prevents audible interruptions during a call.

**D-TAD:** Digital Telephone Answering Device is the sophisticated, tapeless answering system built into the 984 telephone.

**Home Area Code:** This is the area code for your telephone number. Most users simply dial the seven digits of a phone number to make a call within their own area code and 11 digits outside of their area code. If this applies to you, you should enter your own area code into the unit as the Home Area Code. After programming, if you receive a call from within your Home Area Code, the screen will display the seven digits of the phone number.

You may, however, live in a region where for calls within your own area code, you must dial 10 digits (that is, the area code and phone number). If this applies to you, enter "000" for the Home Area Code and enter your area code as a Local Area Code. After programming, if you receive a call from within your area code, the screen displays the 10 digits of the phone number.

Be sure to follow the directions under "Program Home and Local Area Codes" on page 40 during Feature Setup.

**Line Group:** A group of system phones sharing some lines within a multi-phone system.

**Local Area Code:** Most users dial 11 digits to make calls outside their Home Area Codes. If this applies to you, you do not need to program any Local Area Codes.

However, if you dial only 10 digits to make calls to some areas outside your Home Area Code (without dialing "1"), then program these Local Area Codes into the phone. Up to five Local Area Codes can be programmed. See "Program Home and Local Area Codes" on page 40 during Feature Setup for instructions.

After programming, if you receive a call from one of these Local Area Codes, the screen displays the 10 digits of the phone number.

**Navigation buttons:** These are the buttons used when programming your 984 phone and for scrolling through feature options (**ENTER**, **▲**, **▼**, **▶**, **◀**).

**NOTE:** If you have one or more 964, 955, or 944 phone(s) installed in the same phone system with this 984 telephone, you can have only 12 extensions in the phone system.

**Phone System:** Two or more system phones combined to form an interacting system of shared lines. You can have up to 16 system phones in the system.

**Prime Line:** This is the line on your phone you designate to be selected automatically when you lift the handset, press **[SPEAKER]**, or press **[HEADSET]**.

**System Phone:** Any 944, 945, 955, 964, 974 or 984 phone in your phone system (also called an extension).

Ⓢ **NOTE:** If you have one or more 964, 955, or 944 phone(s) installed in the same phone system with this 984 telephone, you can have only 12 extensions in the phone system.

## Programmable Features List

Default settings indicated by \*.

FEATURE:	FUNCTION:	OPTIONS:
<b>ONE TOUCH PREFERENCE</b>	Choose default mode for One Touch (EXT) buttons.	Intercom* or Telephone
<b>EXTENSION NO</b>	Assign an extension number to this phone.	11*-26
<b>RINGER ON /OFF</b>	Turn the ringer on or off for each line.	On* or Off
<b>RINGER TYPE</b>	Select a ring pattern for this phone.	Type 1*, 2, 3, 4
<b>DELAY RING</b>	Select desired time to delay Central Office ring.	Off*, 2, 4, 6, up to 30 seconds
<b>AUTO-MUTE</b>	Turn Auto-Mute on or off (sounds at this extension will be heard automatically when paged).	On* or Off
<b>TONE/PULSE</b>	Set the dial mode for touch tone or dial pulse (rotary) dialing.	Tone* or Pulse
<b>HOLD REMINDER</b>	Turn on or off the audible reminder that a call at this extension is on hold.	On* or Off
<b>TIME/DATE</b>	Set the time and date.	01:00 AM 01/01 Sunday*
<b>LINE USAGE</b>	Turn Line Usage on or off for each line.	On* or Off

 **NOTE:** One ring is equal to about six seconds, two rings equals twelve seconds, and so on.

## Programmable Features List

Default settings indicated by \*.

FEATURE:	FUNCTION:	OPTIONS:
<b>PRIME LINE</b>	Assign a line on this phone to be selected automatically when you lift the handset, press <b>[SPEAKER]</b> , or press <b>[HEADSET]</b> .	Line 1*, 2, 3, 4
<b>AUTOMATIC MODE</b>	Choose default mode for calls connected with the handset in the cradle.	Speakerphone* or Headset
<b>SCROLL RATE</b>	Set the scrolling speed for Rapid Scroll.	Very Slow, Slow, Medium*, Fast, or Very Fast
<b>LCD BACKLIGHT</b>	Turn the screen display backlight on or off.	On* or Off
<b>COVM ON/OFF</b>	Turn COVM (message/voice mail) indicators on or off for each line.	On or Off*
<b>COVM RESET</b>	Clear COVM indicators when they are lit but no new messages are waiting.	N/A
<b>AREA CODES</b>	Program one Home and up to five Local Area Codes for use with Caller ID features.	1-3 digits, Empty*
<b>LINE GROUP</b>	Assign your phone to a Line Group.	Line Group 4*-15 or PRV (private)

 **NOTE:** One ring is equal to about six seconds, two rings equals twelve seconds, and so on.

continued on page 10

continued from page 9

## Programmable Features List

Default settings indicated by \*.

<b>FEATURE:</b>	<b>FUNCTION:</b>	<b>OPTIONS:</b>
<b>RESET ALL</b>	Return all features to default settings.	N/A
<b>ANSWER STATUS</b>	Turn the answering system on or off, or set this phone to be an Auto-Attendant. Set Answer Status to On to activate answering system in a single phone system. Set Answer Status to Auto-Attendant to activate answering system and Auto-Attendant functions for a multi-phone system.	On*, Off, or Auto-Attendant
<b>SINGLE PHONE</b>	Specify whether this phone is single (On) or part of a multi-phone system (Off).	On or Off*
<b>ANSWER DELAY</b>	Set the length of time this phone rings before the answering system picks up the call.	02–60 seconds. 15 seconds*
<b>AUTO ATT DELAY</b>	Specify how long an Auto-Attendant waits before picking up incoming calls.	6*–30 seconds
<b>DAY/NIGHT TIMES</b>	Specify times to be considered Day or Night for Auto-Attendant features.	Day: 09:00 AM* Night: 06:00 PM*

 **NOTE:** One ring is equal to about six seconds, two rings equals twelve seconds, and so on.

## Programmable Features List

Default settings indicated by \*.

FEATURE:	FUNCTION:	OPTIONS:
<b>TOLL SAVER</b>	Turn Toll Saver on or off.	On or Off*
<b>REMOTE CODE</b>	Program the code (password) needed for remote access to some features of your phone.	Three digits, 111*
<b>MESS. LENGTH</b>	Set maximum length of recorded messages.	Unlimited*, 1 minute, or Greeting Only
<b>MESS.ALERT</b>	Turn the Audible Message Alert on or off.	On or Off*
<b>MONITOR</b>	Choose whether incoming messages can be heard over the speaker as they are recorded.	On* or Off
<b>DTAD INTERCEPT</b>	Choose whether messages can be intercepted by other phones during recording.	On or Off*
<b>CONSOLE</b>	Specify whether your phone is the Centrex Console phone for your phone system.	On or Off*
<b>CSL DELAY RING</b>	Set the time to delay ring for Centrex Console phone.	Off*, 2, 4, 6, up to 30 seconds
<b>LANGUAGE</b>	Select the language for screen displays.	English*, Espanol, or Français

 **NOTE:** One ring is equal to about six seconds, two rings equals twelve seconds, and so on.



## Audible Signals

<b>WHEN YOU HEAR:</b>	<b>IT MEANS:</b>
<b>A RAPID DOUBLE-RING PATTERN, REPEATING</b>	You have an incoming intercom call.
<b>A LONG SINGLE RING, REPEATING</b>	You have an incoming transferred call.
<b>A SHORT SINGLE RING, REPEATING</b>	The extension number you just programmed has already been assigned. Choose another number for this extension.
<b>A SHORT SINGLE TONE, REPEATING</b>	The extension you are paging is in DND mode.
<b>A LONG SINGLE TONE, REPEATING</b>	The extension you are calling is busy.
<b>A VERY LONG SINGLE TONE, REPEATING</b>	The extension you are calling is ringing or in DND mode.

# INSTALLATION



If you are installing multiple phones in your telephone system, you must install and program one set at a time. If more than one extension is assigned the same extension number, a repeating short ring (error ring) sounds at the extension you are programming and the screen display includes EXT XX is already used Assign new EXT #. Assign a different extension number from 11 to 26 (see "Assign an Extension Number to Your Phone" on page 26).

## Battery Installation

Install a 9V alkaline battery (purchased separately) in order to use some features of this telephone in the event of a power failure. If power fails and a working battery is installed, all four lines of this phone will work only to answer calls with the handset or headset, and to dial calls using the key pad and the One Touch or Redial features. No other features will work until power is restored.

- 1 Remove the wedge from the underside of the base unit.**  
Press on the tabs and pull the wedge away from the phone.

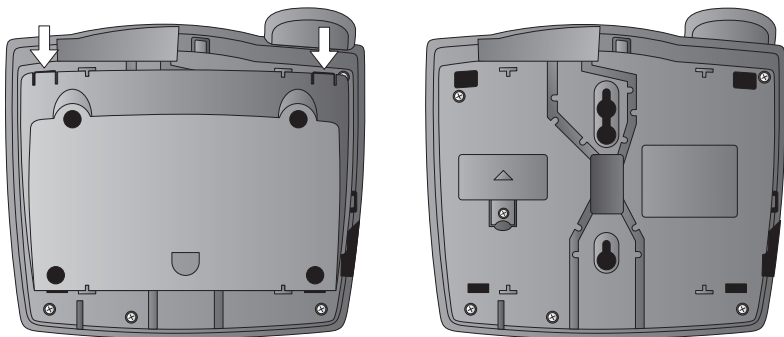

- 2 Remove the battery compartment screw with a small Phillips head screwdriver.**

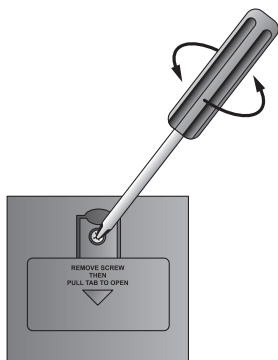

continued on page 14

**Battery Installation**

continued from page 13

- 3 Pull on the tab to remove the battery compartment cover.**

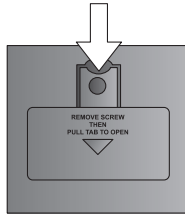

- 4 Insert a 9V battery (purchased separately) following the polarity markings in the battery compartment.**

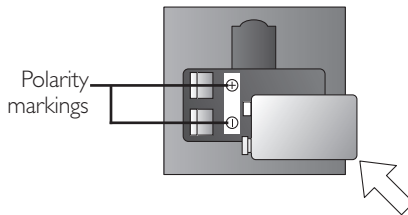

- 5 Replace the battery compartment cover and the screw.**
- 6 If you are wall mounting the phone,** turn to “Wall Installation” beginning on page 17. (You will not need the wedge; store it in case you use the phone on a table or desk in the future.)

— OR —

**If you are using the phone on a table or desk,** reattach the wedge to the base unit by sliding the tabs into the holes as shown. Snap the wedge onto the base. Then, turn to “Table/Desk Installation” beginning on page 15.

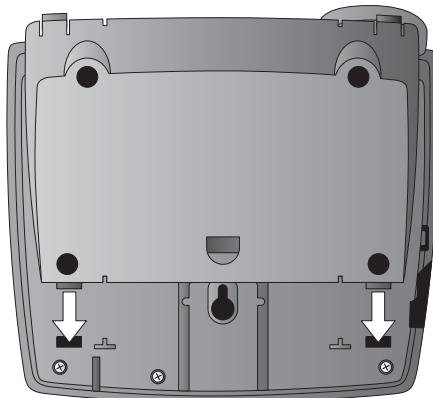

## Table/Desk Installation

For best results, follow the directions in “Battery Installation” on page 13 before installing the phone.

- I **Connect the telephone line cords to the telephone and wall jacks as shown in the appropriate illustration below.** Use only the line cords that came with this phone.
  - **Four One-Line Jacks** (To use this installation option, you’ll need to purchase two two-line adapters. Adapters are available at retail stores or by calling **1 800 222-3111**.)

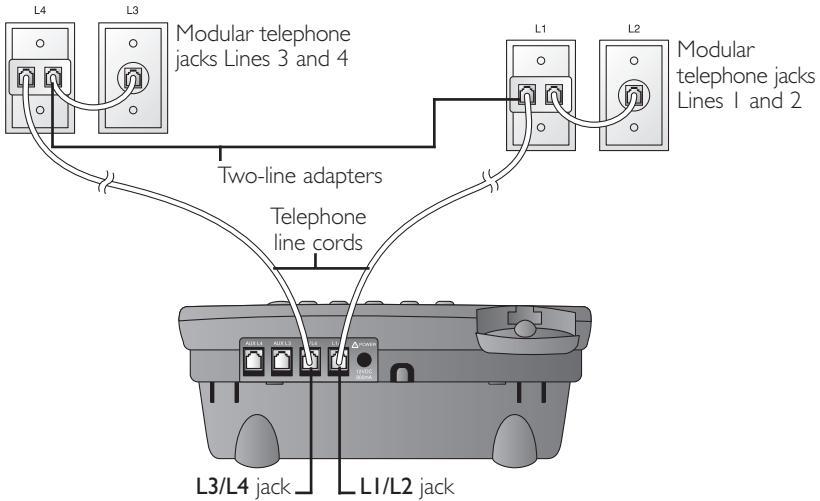

- **Two Two-Line Jacks**

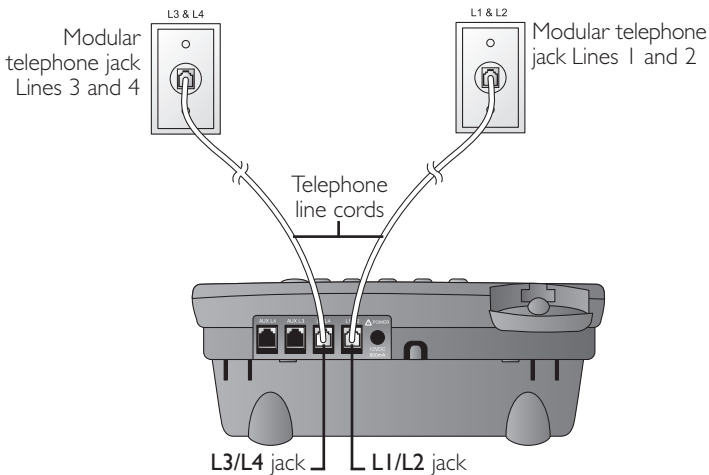

continued on page 16

## Table/Desk Installation

continued from page 15

### 2 Connect the handset cord.

Plug one end of the coiled handset cord into the jack on the left side of the phone. Plug the other end into the handset and hang up.

### 3 Connect the power adapter to the telephone.



Use only the power adapter provided with this product.

To obtain a replacement, call **1 800 222-3111**.

Plug one end of the power adapter into the jack labeled **POWER** on the back of the phone. Plug the other end into a standard electrical outlet not controlled by a wall switch.

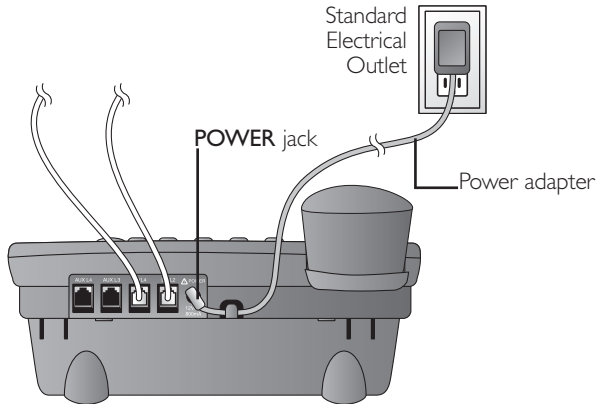

### 4 Check for dial tone.

Lift the handset and listen for a dial tone. If you cannot hear a dial tone, turn to **IN CASE OF DIFFICULTY** beginning on page 121.

### 5 Initialization.

If no battery is installed when you connect the power cord, the phone runs a quick self-test and the screen displays **Initializing...** for about three seconds.

**NOTE:** The phone will run through this same initialization any time it is reconnected to AC power if a working battery is not installed (for example, after a power failure or when the unit has been unplugged).

## Wall Installation

For best results, follow the directions in “Battery Installation” on page 13 before installing the phone.

- 1 If the wedge is still attached to the underside of the base unit,** follow **Step 1** in “Battery Installation” on page 11 to remove the wedge.
- 2 Reverse the handset tab.**  
Hold down the switchhook, then pull out the handset tab and rotate it 180 degrees. Push the handset tab down into the grooves so it settles into position.



- 3 Connect the telephone line cords to the telephone as shown.**

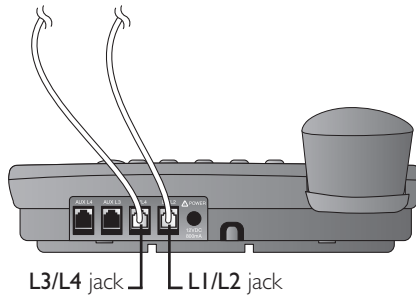

- 4 Connect the handset cord.**  
Plug one end of the coiled handset cord into the jack on the left side of the phone. Plug the other end into the handset and hang up.

continued on page 18

## Wall Installation

continued from page 17

### 5 Connect the power adapter to the telephone.



Use only the power adapter provided with this product.

To obtain a replacement, call **1 800 222-3111**.

Plug one end of the power adapter into the jack labeled **POWER** on the back of the phone. Plug the power adapter into a standard electrical outlet not controlled by a wall switch.

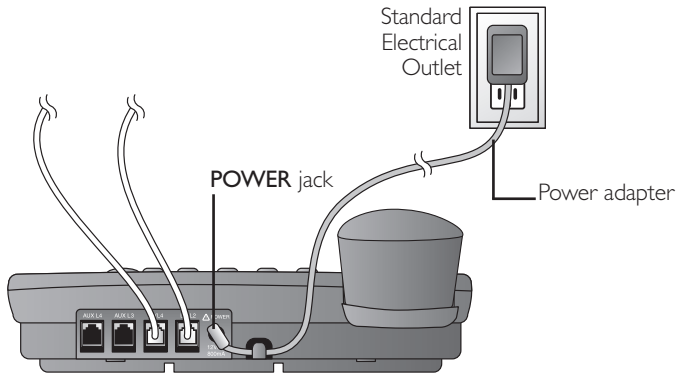

### 6 Check for dial tone.

Lift the handset and listen for a dial tone. If you cannot hear a dial tone, turn to **IN CASE OF DIFFICULTY** beginning on page 121.

**7 Mount the phone on the wall.**

- **Four One-Line Jacks** (To use this installation option, you'll need to purchase and install a blank wall plate.)

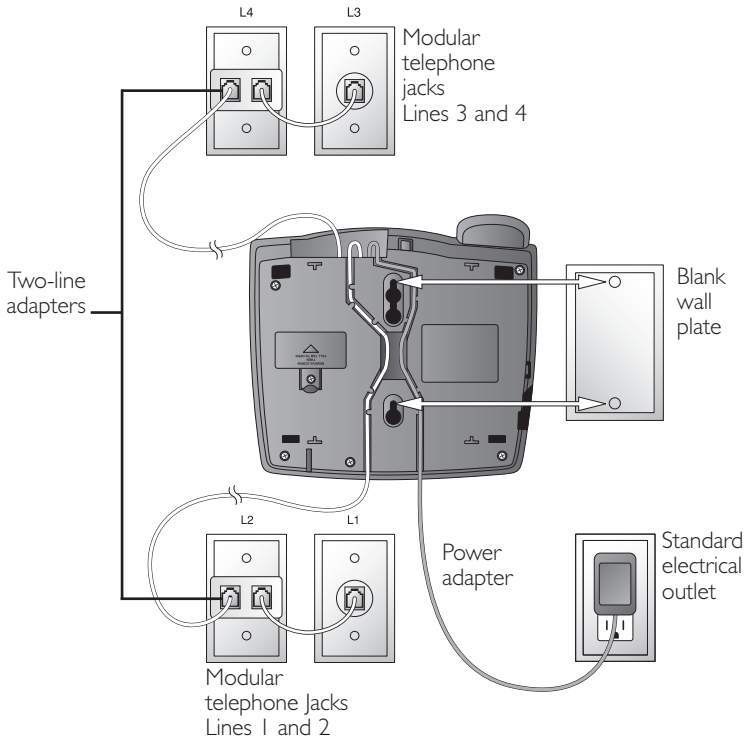

continued on page 20



**Wall Installation**

continued from page 19

- **Two Two-Line Jacks**

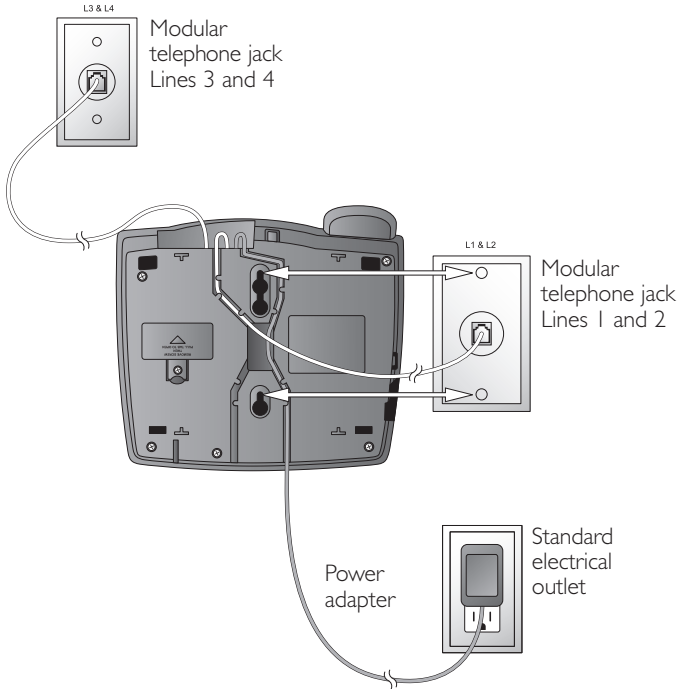

**8 Initialization.**

If no battery is installed when you connect the power cord, the phone runs a quick self-test and the screen displays `Initializing..` for about three seconds.

Ⓢ **NOTE:** The phone will run through this same initialization any time it is reconnected to AC power if a working battery is not installed (for example, after a power failure or when the unit has been unplugged).

## Convenience Ports

If you want to connect another device (such as a modem or fax machine) to the wall jack, you can use the jacks on the phone labeled **AUX**. These convenience ports use Lines 3 and 4; a call picked up on Line 3 or 4 at another extension may interrupt fax, modem, or message transmission.

- **Four One-Line Jacks**

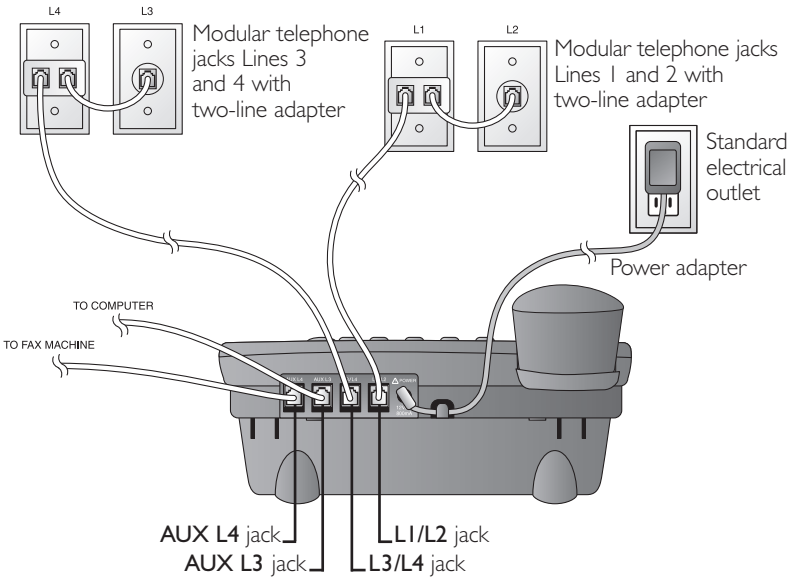

- **Two Two-Line Jacks**

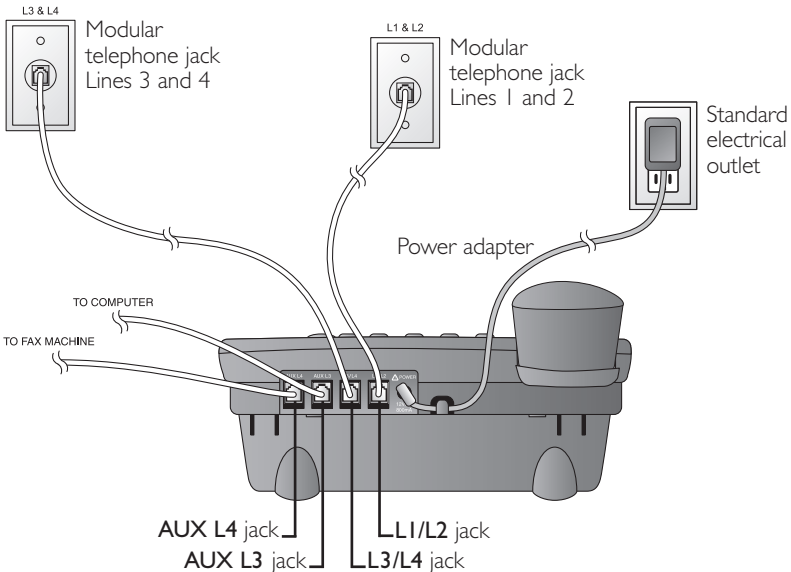

# MENU OPERATION

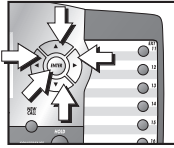

All of the feature setup, memory programming and some individual feature operations for the 984 use menus shown in the screen display. Use the navigation buttons (◀, ▶, ▲, ▼, **ENTER**) to begin, end and move through menu operations (for example, feature setup).

- Press **ENTER** to activate a menu operation. The first menu item for this topic or data will appear in line four of the screen. For example, the screen displays:

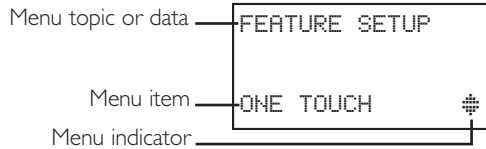

**NOTE:** If you do not press a key to continue menu operations within 30 seconds, the telephone automatically exits the menu.

- When **☰** is displayed, you can press the ▼ or ▲ button repeatedly to move through the menu.
- Press **ENTER** to choose the menu item currently displayed. This may be a lower level menu, an action, or a feature settings screen. For example:

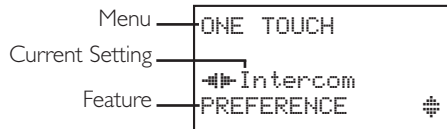

- When **☰** is displayed, you can press the ▶ or ◀ button to scroll through setting choices.
- Press **ENTER** to store the setting, or press ▼ to store the setting and show the next option for the feature currently displayed.
- To return to the main menu, press the ▼ or ▲ button until the screen display includes MAIN MENU or EXIT. Then, press **ENTER**.
- To exit programming mode, press and hold **ENTER**.

**NOTE:** If the phone beeps twice, repeat the steps to program the feature.

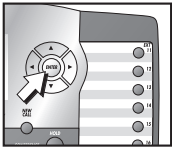

## Menu Structure

Use the menu operation to set up the values for the 984 features. Access the menu by pressing **ENTER** when the phone is idle. The menu structure for the feature setup menu is below.

- ONE TOUCH
  - PREFERENCE
  - INTERCOM
  - TELEPHONE
  - PROGRAM
  - PAUSE
  - tone
  - FLASH
  - CANCEL
  - VIEW
  - DONE
- MAIN MENU
  - PHONE SETTINGS
    - EXTENSION NO
    - RINGER ON/OFF
    - RINGER TYPE
    - DELAY RING
    - AUTO-MUTE
    - tone/PULSE
    - HOLD REMINDER
  - MAIN MENU
  - TIME/DATE
- SPECIAL OPTIONS
  - LINE USAGE
  - PRIME LINE
  - AUTOMATIC MODE
  - SCROLL RATE
  - LCD BACKLIGHT
  - COVM ON/OFF
  - COVM RESET
  - AREA CODES
  - LINE GROUP
  - RESET ALL
  - MAIN MENU
- DTAD/AA
  - ANSWER STATUS
  - SINGLE PHONE
  - ANSWER DELAY
  - AUTO ATT DELAY
  - DAY/NIGHT TIMES
  - TOLL SAVER
  - REMOTE CODE
  - MESS. LENGTH
  - MESS.ALERT
  - MONITOR
  - DTAD INTERCEPT
- CENTREX
  - CONSOLE
  - CSL DELAY RING
  - MAIN MENU
- LANGUAGE

## Shortcut to Language Menu

This phone comes programmed for English screen displays. If you need to change the screen language to Spanish or French, you can use these steps to reach the LANGUAGE menu more quickly.

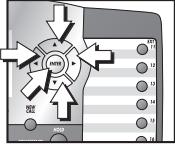

- 1 Press **ENTER** to begin feature setup.
- 2 Press **▲** twice. The screen display includes LANGUAGE and the current setting.
- 3 Press **◀** or **▶** to scroll through the language choices (English, Espanol, or Français). When the language you want to use is displayed, press **▼** to save your choice. The screen display includes EXIT.
- 4 Press **ENTER** to return to the idle screen.

**NOTE:** You can exit feature setup and return to the idle screen any time. Simply press and hold **ENTER**.

## Rapid Scroll

You can scroll through menu items or setting choices more quickly using this feature. Press and hold the desired scroll button (**▲**, **▼**, **▶** or **◀**). The screen will scroll through your choices at the rate you program during Feature Setup. See “Set the Scroll Rate” on page 36 for programming instructions.

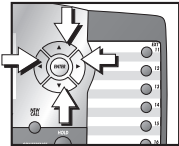

# FEATURE SETUP

## Set One Touch Preference

Choose whether pressing an EXT button automatically initiates an intercom or One Touch call. If you want to place One Touch calls using only one button, set this feature to TELEPHONE. If you want to place intercom calls using only one button, set this feature to INTERCOM. See ONE TOUCH OPERATION beginning on page 70 and INTERCOM OPERATION beginning on page 83 for details about One Touch and intercom calls.

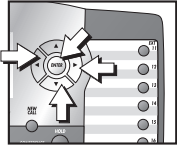

- 1 Press **ENTER** to begin feature setup.
- 2 Press **ENTER**. The screen display includes PREFERENCE and the current setting.
- 3 Press **◀** or **▶** to toggle between INTERCOM and TELEPHONE.
- 4 When the correct setting is shown, press **▼** to save your choice. The screen display includes PROGRAM.
- 5 Press and hold **ENTER** to return to the idle screen.

**🎯 NOTE:** You can exit feature setup and return to the idle screen any time. Simply press and hold **ENTER**.

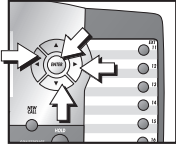

## Assign an Extension Number to Your Phone

Every individual phone in your telephone system **MUST** be assigned a unique extension number for the intercom feature to work.

- 1 Press **ENTER** to begin feature setup.
- 2 Press **▼** until the screen display includes **PHONE SETTINGS**.
- 3 Press **ENTER**. The screen display includes **EXTENSION NO** and the current setting.
- 4 Press **◀** or **▶** to change the extension number (11...26).
- 5 When the desired extension number is shown press **▼** to save your choice. The screen display includes **RINGER ON/OFF**.

**⊙ NOTE:** If you duplicate an extension number already in use, you will hear a repeating short ring and the screen display will include **EXT XX is already used Assign new EXT #**. Repeat **Steps 1–5** at the ringing phone to assign a different extension number (from 11 – 26).

- 6 Proceed to **Step 5** on page 27 to set the next feature (Ringer On or Off)  
— OR —  
Press and hold **ENTER** to return to the idle screen.

**⊙ NOTE:** You can exit feature setup and return to the idle screen any time. Simply press and hold **ENTER**.

## Turn the Ringer On or Off for Each Line

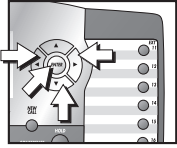

- 1 Press **ENTER** to begin feature setup.
- 2 Press **▼** until the screen display includes **PHONE SETTINGS**.
- 3 Press **ENTER**. The screen display includes **EXTENSION NO.**
- 4 Press **▼** until the screen display includes **RINGER ON/OFF**.
- 5 Press **ENTER**. The screen display includes **L1 RINGER** and the current setting.
- 6 Press **◀** or **▶** to toggle between **On** and **Off** for the line shown.
- 7 When the desired setting for this line is shown, press **▼** to save your choice. The screen display will include the current ringer setting for the next line (**L1 . . . L4**).
- 8 Repeat **Steps 6** and **7** to turn the ringer on or off for other lines at this phone.
- 9 When you are finished setting the ringer, press **▼** until the screen display includes **DONE**.
- 10 Press **ENTER**. The screen display includes **RINGER ON/OFF**.
- 11 Proceed to **Step 4** on page 28 to set the next feature (Ringer Type)  
— **OR** —  
Press and hold **ENTER** to return to the idle screen.

**NOTE:** You can exit feature setup and return to the idle screen any time. Simply press and hold **ENTER**.



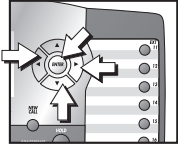

## Select the Ringer Type

You can choose a ring pattern for incoming phone calls.

**NOTE:** Incoming intercom calls use Ringer Type 1 and cannot be changed.

- 1 Press **ENTER** to begin feature setup.
- 2 Press **▼** until the screen display includes PHONE SETTINGS.
- 3 Press **ENTER**. The screen display includes EXTENSION NO.
- 4 Press **▼** until the screen display includes RINGER TYPE.
- 5 Press **ENTER**. The screen display includes L1 RINGER TYPE and the current setting.
- 6 Press **◀** or **▶** to change the ringer type (Type 1 ...Type 4) for the line shown.
- 7 When the desired setting for this line is shown, press **▼** to save the your choice and move to the next line with its ringer type.
- 8 Repeat **Steps 6** and **7** to set ringer types for other lines on this phone (L1...L4).
- 9 When you are finished setting the ringer type, press **▼** until the screen display includes DONE.
- 10 Press **ENTER**. The screen display includes RINGER TYPE.
- 11 Proceed to **Step 4** on page 29 to set the next feature (Delay Ring)  
— OR —  
Press and hold **ENTER** to return to the idle screen.

**NOTE:** You can exit feature setup and return to the idle screen any time. Simply press and hold **ENTER**.

## Set Delay Ring

Set the length of time before incoming calls will ring at this extension.

**NOTE:** If you choose to set a delayed ring on a phone with Voice Mail service, the phone may not ring at all before Voice Mail picks up the call.

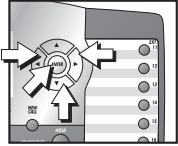

- 1 Press **ENTER** to begin feature setup.
- 2 Press **▼** until the screen display includes **PHONE SETTINGS**.
- 3 Press **ENTER**. The screen display includes **EXTENSION NO.**
- 4 Press **▼** until the screen display includes **DELAY RING** and the current setting.
- 5 Press **◀** or **▶** to change the delay ring setting (Off, 2 sec...30 sec).
- 6 When the correct delay setting is shown, press **▼** to save your choice. The screen display includes **Auto-Mute**.
- 7 Proceed to **Step 5** on page 30 to set the next feature (Auto-Mute)  
— **OR** —  
Press and hold **ENTER** to return to the idle screen.

**NOTE:** You can exit feature setup and return to the idle screen any time. Simply press and hold **ENTER**.

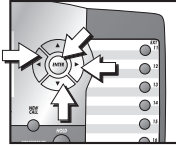

## Turn Auto-Mute On or Off

Choose whether sounds at this extension will be heard automatically in response to a page (Auto-Mute Off) or only when **MUTE** is pressed. Auto-Mute Off permits hands-free conversation and room monitoring; Auto-Mute On protects privacy.

- 1 Press **ENTER** to begin feature setup.
- 2 Press **▼** until the screen display includes **PHONE SETTINGS**.
- 3 Press **ENTER**. The screen display includes **EXTENSION NO.**
- 4 Press **▼** until the screen display includes **Auto-Mute** and the current setting.
- 5 Press **◀** or **▶** to toggle between **On** and **Off**.
- 6 When the correct setting is shown, press **▼** to save your choice. The screen display includes **PHONE/PULSE**.
- 7 Proceed to **Step 5** of “Set Dial Mode” on page 31 to set the next feature (Tone/Pulse)  
— **OR** —  
Press and hold **ENTER** to return to the idle screen.

**NOTE:** You can exit feature setup and return to the idle screen any time. Simply press and hold **ENTER**.

## Set Dial Mode

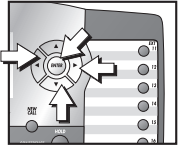

- 1 Press **ENTER** to begin feature setup.
- 2 Press **▼** until the screen display includes **PHONE SETTINGS**.
- 3 Press **ENTER**. The screen display includes **EXTENSION NO.**
- 4 Press **▼** until the screen display includes **TONE/PULSE** and the current setting.
- 5 Press **◀** or **▶** to toggle between **Tone** and **Pulse**.
- 6 When the correct setting is shown, press **▼** to save your choice. The screen display includes **HOLD REMINDER**.
- 7 Proceed to **Step 5** below to set the next feature (Hold Reminder)  
— OR —  
Press and hold **ENTER** to return to the idle screen.

**NOTE:** You can exit feature setup and return to the idle screen any time. Simply press and hold **ENTER**.

## Turn Hold Reminder On or Off

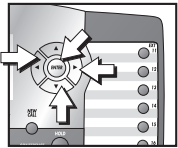

- 1 Press **ENTER** to begin feature setup.
- 2 Press **▼** until the screen display includes **PHONE SETTINGS**.
- 3 Press **ENTER**. The screen display includes **EXTENSION NO.**
- 4 Press **▼** until the screen display includes **HOLD REMINDER** and the current setting.
- 5 Press **◀** or **▶** to toggle between **On** and **Off**.
- 6 When the correct setting is shown, press **▼** to save your choice. The screen display includes **MAIN MENU**.
- 7 Press and hold **ENTER** to return to the idle screen.

**NOTE:** You can exit feature setup and return to the idle screen any time. Simply press and hold **ENTER**.

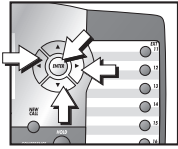

## Set the Time and Date

- 1 Press **ENTER** to begin feature setup.
- 2 Press **▼** until the screen display includes **TIME/DATE**.
- 3 Press **ENTER**. The screen display includes **HOUR** and the current hour setting.
- 4 Press **◀** or **▶** until the correct hour is shown.
- 5 Press **▼** to save the hour setting. The screen display includes **MINUTE** and the current minute setting.
- 6 Press **◀** or **▶** until the correct minute is shown.
- 7 Press **▼** to save the minute setting. The screen display includes **AM/PM** and the current setting.
- 8 Press **◀** or **▶** to toggle between **AM** and **PM**.
- 9 Press **▼** to save the AM/PM setting. The screen display includes **MONTH** and the number of the current month setting.
- 10 Press **◀** or **▶** until the number of the correct month is shown.
- 11 Press **▼** to save the correct month setting. The screen display includes **DATE** and the current day of the month setting.
- 12 Press **◀** or **▶** until the correct day of the month is shown.
- 13 Press **▼** to save the day of the month. The screen display includes **DAY OF WEEK** and the current setting.
- 14 Press **◀** or **▶** until the correct day of the week is shown.
- 15 Press **▼** to save the Time/Date setting. The screen display includes **MAIN MENU**.
- 16 Press and hold **ENTER** to return to the idle screen.

**Ⓞ NOTE:** You can exit feature setup and return to the idle screen any time. Simply press and hold **ENTER**.

## Turn Line Usage On or Off for Each Line

If you are not using all four phone lines at this extension, you need to turn off Line Usage for the unused lines. If you expand to a second, third or fourth line, turn Line Usage back on. Line 1 must be turned on for the intercom to work.

**NOTE:** You may use any combination of lines. Lines used do not need to be in order. For example, Line Usage can be turned on for Lines 1 and 3 and turned off for Lines 2 and 4.

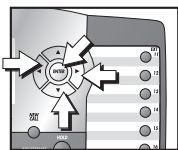

You may also restrict the use of certain lines on this phone to intercom and paging only, by turning off Line Usage for each line you want restricted. When Line Usage is turned off, that line cannot be used to answer incoming calls or to make outgoing or transfer calls.

- 1 Press **ENTER** to begin feature setup.
- 2 Press **▼** until the screen display includes **SPECIAL OPTIONS**.
- 3 Press **ENTER**. The screen display includes **LINE USAGE**.
- 4 Press **ENTER**. The screen display includes **L1 USAGE** and the current setting for this line.
- 5 Press **◀** or **▶** to toggle between **On** and **Off** for the line shown.
- 6 Press **▼** to save the current setting for this line and move to the next line with its current Line Usage setting.
- 7 Repeat **Steps 5** and **6** to set Line Usage for other lines at this extension.
- 8 When you are finished setting Line Usage, press **▼** until the screen display includes **DONE**.
- 9 Press **ENTER**. The screen display includes **LINE USAGE**.
- 10 Proceed to **Step 4** on page 34 to set up the next feature (Prime Line)  
— **OR** —  
Press and hold **ENTER** to return to the idle screen.

**NOTE:** You can exit feature setup and return to the idle screen any time. Simply press and hold **ENTER**. **33**

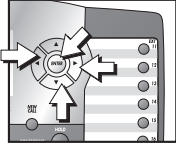

## Assign the Prime Line (Line Preference)

- 1 Press **ENTER** to begin feature setup.
- 2 Press **▼** until the screen display includes SPECIAL OPTIONS.
- 3 Press **ENTER**. The screen display includes LINE USAGE.
- 4 Press **▼** until the screen display includes PRIME LINE and the current setting.
- 5 Press **◀** or **▶** to scroll through the line choices (Line 1...Line 4).
- 6 When the line you wish to set as prime is displayed, press **▼** to save your choice. The screen display includes AUTOMATIC MODE.
- 7 Proceed to **Step 5** on page 35 to set the next feature (Automatic Mode)

— OR —

Press and hold **ENTER** to return to the idle screen.

**Ⓢ NOTE:** You can exit feature setup and return to the idle screen any time. Simply press and hold **ENTER**.

## Set Automatic Mode

Choose the mode (headset or speakerphone) to be used automatically when you press a LINE button with the handset in the cradle.

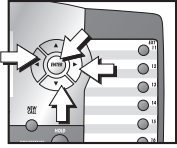

- 1 Press **ENTER** to begin feature setup.
- 2 Press **▼** until the screen display includes **SPECIAL OPTIONS**.
- 3 Press **ENTER**. The screen display includes **LINE USAGE**.
- 4 Press **▼** until the screen display includes **AUTOMATIC MODE** and the current setting.
- 5 Press **◀** or **▶** to toggle between **SpeakerPhone** and **Headset**.
- 6 When the desired mode is displayed, press **▼** to save your choice. The screen display includes **SCROLL RATE**.
- 7 Proceed to **Step 5** on page 36 to set the next feature (**Scroll Rate**)  
**— OR —**  
 Press and hold **ENTER** to return to the idle screen.

**NOTE:** You can exit feature setup and return to the idle screen any time. Simply press and hold **ENTER**.



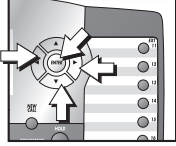

## Set the Scroll Rate

You can choose the speed for the Rapid Scroll feature. (See “Rapid Scroll” on page 24 for details.)

- 1 Press **ENTER** to begin feature setup.
- 2 Press **▼** until the screen display includes **SPECIAL OPTIONS**.
- 3 Press **ENTER**. The screen display includes **LINE USAGE**.
- 4 Press **▼** until the screen display includes **SCROLL RATE** and the current setting.
- 5 Press **◀** or **▶** to change the setting (Very Slow, Slow, Medium, Fast, or Very Fast).
- 6 When the correct scroll rate is shown, press **▼** to save your choice. The screen display includes **LCD BACKLIGHT**.
- 7 Proceed to **Step 5** on page 37 to set the next feature (LCD Backlight)

— OR —

Press and hold **ENTER** to return to the idle screen.

**NOTE:** You can exit feature setup and return to the idle screen any time. Simply press and hold **ENTER**.

## Turn Screen Backlight On or Off

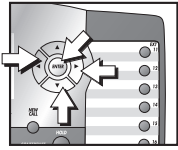

- 1 Press **ENTER** to begin feature setup.
- 2 Press **▼** until the screen display includes **SPECIAL OPTIONS**.
- 3 Press **ENTER**. The screen display includes **LINE USAGE**.
- 4 Press **▼** until the screen display includes **LCD BACKLIGHT** and the current setting.
- 5 Press **◀** or **▶** to toggle between **On** and **Off**.
- 6 When the correct setting is shown, press **▼** to save your choice. The screen display includes **COVM ON/OFF**.
- 7 Proceed to **Step 5** on page 38 to set the next feature (**COVM ON/OFF**)  
**— OR —**  
 Press and hold **ENTER** to return to the idle screen.

**Ⓢ NOTE:** You can exit feature setup and return to the idle screen any time. Simply press and hold **ENTER**.

## Turn COVM Indicators On or Off for Each Line

If you subscribe to Voice Mail service with your local telephone service provider, turn the COVM indicator on to have the screen display the appropriate line numbers when there are messages waiting. If you do not subscribe to Voice Mail service, turn the COVM indicators off for each line.

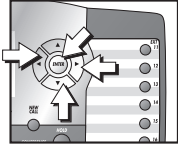

- 1 Press **ENTER** to begin feature setup.
  - 2 Press **▼** until the screen display includes SPECIAL OPTIONS.
  - 3 Press **ENTER**. The screen display includes LINE USAGE.
  - 4 Press **▼** until the screen display includes COVM ON/OFF.
  - 5 Press **ENTER**. The screen display includes L1 COVM ON/OFF and the current setting.
  - 6 Press **◀** or **▶** to toggle between On and Off for the line shown.
  - 7 When the correct setting is shown, press **▼** to save your choice. The screen display includes COVM ON/OFF for the next line and the current setting.
  - 8 Repeat **Steps 6** and **7** to turn the COVM indicator on or off for other lines at this extension.
  - 9 When you are finished setting the COVM indicators, press **▼** until the screen display includes DONE.
  - 10 Press **ENTER**. The screen display includes COVM ON/OFF.
  - 11 Press **▼** until the screen display includes COVM RESET, then proceed to **Step 5** on page 39 to clear the COVM indicators
- OR —
- Press and hold **ENTER** to return to the idle screen.

**NOTE:** You can exit feature setup and return to the idle screen any time. Simply press and hold **ENTER**.

## Reset COVM Indicator

If a COVM indicator remains on when there are no messages on that line, you may have received a false signal from your local telephone service provider. You can clear the indicator manually.

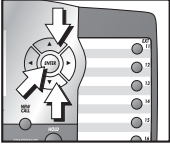

- 1 Press **ENTER** to begin feature setup.
- 2 Press **▼** until the screen display includes SPECIAL OPTIONS.
- 3 Press **ENTER**. The screen display includes LINE USAGE.
- 4 Press **▼** until the screen display includes COVM RESET.
- 5 Press **ENTER**. The screen display includes L1 COVM RESET.
- 6 Press **▲** or **▼** to scroll through the COVM Reset menu (L1 COVM RESET...L4 COVM RESET, or ALL COVM RESET).
- 7 When the line you want to reset is displayed, press **ENTER** to remove the message waiting indicator. You can clear all the lines at once by choosing ALL COVM RESET. The screen display includes Reset!.
- 8 Press **▼** until the screen display includes DONE.
- 9 Press **ENTER**. The screen display includes COVM RESET.
- 10 Press **▼** until the screen display includes AREA CODES, then proceed to **Step 5** on page 40 to program the Home or Local Area Codes.

— OR —

Press and hold **ENTER** to return to the idle screen.

**NOTE:** You can exit feature setup and return to the idle screen any time. Simply press and hold **ENTER**.

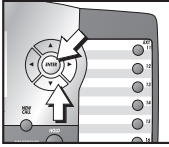

## Program Home and Local Area Codes

You can program this phone to recognize one Home and up to five Local Area Codes. See “Home Area Code” and “Local Area Codes” on page 6 for definitions.

- 1 Press **ENTER** to begin feature setup.
- 2 Press **▼** until the screen display includes **SPECIAL OPTIONS**.
- 3 Press **ENTER**. The screen display includes **LINE USAGE**.
- 4 Press **▼** until the screen display includes **AREA CODES**.
- 5 Press **ENTER**. The screen display includes **HOME AC** and the current setting.
- 6 Use the dial pad keys to enter your Home Area Code, then press **▼**. The screen display includes **LOCAL AC1** and the current setting.

If you need to enter any Local Area Codes, use the dial pad keys and then press **▼** to scroll to the next screen (**LOCAL AC2**, **LOCAL AC3**, **LOCAL AC4**, and **LOCAL AC5**).

**NOTE:** If you must dial the area code to place calls within your own area code, enter “000” for the Home Area Code and enter your area code as a Local Area Code.

- 7 When you are finished entering all of the area codes you need to program, press **▼** until the screen display includes **DONE**.
- 8 Press **ENTER**. The screen display includes **AREA CODES**.
- 9 Press **▼** until the screen display includes **LINE GROUP**, then proceed to **Step 5** on page 41 to assign the line group  
— OR —  
Press and hold **ENTER** to return to the idle screen.

**NOTE:** You can exit feature setup and return to the idle screen any time. Simply press and hold **ENTER**.

## Assign the Line Group for this Phone

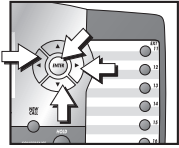

- 1 Press **ENTER** to begin feature setup.
- 2 Press **▼** until the screen display includes **SPECIAL OPTIONS**.
- 3 Press **ENTER**. The screen display includes **LINE USAGE**.
- 4 Press **▼** until the screen display includes **LINE GROUP** and the current setting.
- 5 Press **▶** or **◀** to scroll through the Line Group choices (Line 04...Line15, or PRV).
- 6 When the Line Group you want is shown, press **▼** to save your choice. The screen display includes **RESET ALL**.
- 7 Proceed to **Step 5** on page 42 to reset all feature settings to default values  
**— OR —**  
 Press and hold **ENTER** to return to the idle screen.

**NOTE:** You can exit feature setup and return to the idle screen any time. Simply press and hold **ENTER**.

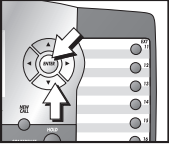

## Erase All Settings and Return the Phone to Default Settings



If you reset all features to the default settings, all previous feature programming and One Touch entries will be erased. You will need to program your preferences for every feature again and re-enter numbers in One Touch locations. You cannot undo the `RESET ALL` command.

- 1 Press `ENTER` to begin feature setup.
- 2 Press `▼` until the screen display includes `SPECIAL OPTIONS`.
- 3 Press `ENTER`. The screen display includes `LINE USAGE`.
- 4 Press `▼` until the screen display includes `RESET ALL`.
- 5 Press `ENTER`. The screen display includes `ENTER:Reset all?`.
- 6 Press `ENTER` to confirm the command. The screen displays `Reset!`. A tone sounds and the screen returns to showing `RESET ALL`.
- 7 Press and hold `ENTER` to return to the idle screen.

**Ⓢ NOTE:** You can exit feature setup and return to the idle screen any time. Simply press and hold `ENTER`.

## Set Answering System Status

Turn the answering function on or off, or set this phone to be an Auto-Attendant for your multi-phone system.

Set Answer Status to On to activate the answering system in a single phone system. Set Answer Status to Auto-Attendant to activate the answering system and Auto-Attendant functions for a multi-phone system.

**NOTE:** The Auto-Attendant feature only works with a multi-phone system. If this phone is the only telephone in your system, do **NOT** select Auto-Attendant for the Answer Status.

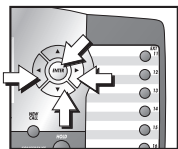

- 1 Press **ENTER** to begin feature setup.
- 2 Press **▼** until the screen display includes DTAD/AA.
- 3 Press **ENTER**. The screen display includes ANSWER STATUS and the current setting.
- 4 Press **◀** or **▶** to scroll through the choices (On, Off, or Auto-Attendant). When the correct setting is shown, press **▼** to save your choice. The screen display includes SINGLE PHONE.
- 5 Proceed to **Step 5** on page 44 to set the next feature (Single Phone)  
—OR—  
Press and hold **ENTER** to return to the idle screen.

**NOTE:** You can exit feature setup and return to the idle screen any time. Simply press and hold **ENTER**.



## Set Your Phone for Single Phone Operation



If this phone is the only telephone in your phone system (single phone), you **MUST** turn this feature on for the answering system to work. If you are using this phone as part of a multi-phone system, leave Single Phone off (default setting).

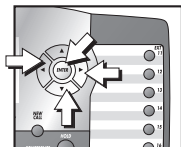

- 1 Press **ENTER** to begin feature setup.
- 2 Press **▼** until the screen display includes DTAD/AA.
- 3 Press **ENTER**. The screen display includes ANSWER STATUS.
- 4 Press **▼** until the screen display includes SINGLE PHONE and the current setting.
- 5 Press **◀** or **▶** to toggle between Off and On. When the correct setting is shown, press **▼** to save your choice. The screen display includes ANSWER DELAY.
- 6 Proceed to **Step 5** on page 45 to set the next feature (Answer Delay)  
**—OR—**  
 Press and hold **ENTER** to return to the idle screen.

**NOTE:** You can exit feature setup and return to the idle screen any time. Simply press and hold **ENTER**.

## Set Answer Delay

Choose how long this phone rings before the answering system picks up a call. One ring is about six seconds.

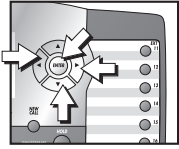

- 1 Press **ENTER** to begin feature setup.
- 2 Press **▼** until the screen display includes DTAD/AA.
- 3 Press **ENTER**. The screen display includes ANSWER STATUS.
- 4 Press **▼** until the screen display includes ANSWER DELAY and the current setting.
- 5 Press **◀** or **▶** to scroll through the choices (02 sec...60 sec). When the correct setting is shown, press **▼** to save your choice. The screen display includes AUTO ATT DELAY.
- 6 Proceed to **Step 5** on page 46 to set the next feature (Auto-Attendant Delay)

—OR—

Press and hold **ENTER** to return to the idle screen.

**NOTE:** You can exit feature setup and return to the idle screen any time. Simply press and hold **ENTER**.

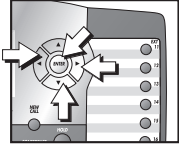

## Set Auto-Attendant Pickup Delay

If this phone is a designated Auto-Attendant, you can choose how long the Auto-Attendant waits before picking up incoming calls. One ring is about six seconds.

- 1 Press **ENTER** to begin feature setup.
  - 2 Press **▼** until the screen display includes DTAD/AA.
  - 3 Press **ENTER**. The screen display includes ANSWER STATUS.
  - 4 Press **▼** until the screen display includes AUTO ATT DELAY.
  - 5 Press **◀** or **▶** to scroll through the choices (06 sec...30 sec). When the correct setting is shown, press **▼** to save your choice. The screen display includes DAY/NIGHT TIMES.
  - 6 Proceed to **Step 5** on page 47 to set the next feature (Day and Night Times)
- OR—**
- Press and hold **ENTER** to return to the idle screen.

**🎯 NOTE:** You can exit feature setup and return to the idle screen any time. Simply press and hold **ENTER**.

## Set Auto-Attendant Day and Night Times



The Auto-Attendant feature only works with a multi-phone system. If you have more than one phone in your system, you **MUST** program the hours for Day and Night Time so the answering system plays the correct outgoing announcement. Please see ANSWERING SYSTEM AUTO-ATTENDANT OPERATION beginning on page 110 for a detailed description of this feature.

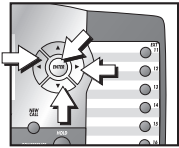

- 1 Press **ENTER** to begin feature setup.
- 2 Press **▼** until the screen display includes DTAD/AA.
- 3 Press **ENTER**. The screen display includes ANSWER STATUS.
- 4 Press **▼** until the screen display includes DAY/NIGHT TIMES.
- 5 Press **ENTER**. The screen display includes DAY TIME and the current setting.
- 6 Press **ENTER** to start to change the Day Time setting. The screen display includes HOUR and the current setting.

### —OR—

Press **▼** and skip to **Step 11** on page 48 to leave the Day Time setting as is and begin to change the Night Time setting.

- 7 Press **◀** or **▶** until the correct Day Time hour is shown. Then, press **▼** to save the Day Time hour setting. The screen display includes MINUTE and the current setting.
- 8 Press **◀** or **▶** until the correct Day Time minute is shown. Then, press **▼** to save the Day Time minute setting. The screen display includes AM/PM the current setting.

continued on page 48

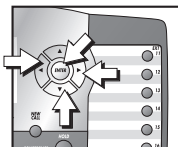

## Set Auto-Attendant Day and Night Times

continued from page 47

- 9 Press **◀** or **▶** to toggle between AM and PM. When the correct setting is shown, press **▼** to save the Day Time setting. The screen display includes DAY TIME and DONE.
- 10 Press **ENTER**. The screen display includes NIGHT TIME and the current setting.
- 11 Press **ENTER** to change the Night Time setting. The screen display includes HOUR and the current setting.
- 12 Press **◀** or **▶** until the correct Night Time hour is shown. Then, press **▼** to save the Night Time hour setting. The screen display includes MINUTE and the current setting.
- 13 Press **◀** or **▶** until the correct Night Time minute is shown. Then, press **▼** to save the Night Time minute setting. The screen display includes AM/PM and the current setting.
- 14 Press **◀** or **▶** to toggle between PM and AM. When the correct setting is shown, press **▼** to save the Night Time setting. The screen display includes NIGHT TIME and DONE.
- 15 Press **▼** until the screen display includes TOLL SAVER, then proceed to **Step 5** on page 49 to set the toll saver

—OR—

Press and hold **ENTER** to return to the idle screen.

**🎯 NOTE:** You can exit feature setup and return to the idle screen any time. Simply press and hold **ENTER**.

## Turn Toll Saver On or Off

When Toll Saver is turned on, the answering system picks up incoming calls within eight seconds if there is at least one new message. When there are no new messages, the answering system picks up the incoming call in the time you set as the Answer Delay (see “Set Answer Delay” on page 45 for details).

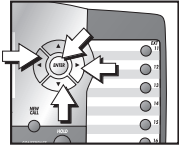

- 1 Press **ENTER** to begin feature setup.
- 2 Press **▼** until the screen display includes DTAD/AA.
- 3 Press **ENTER**. The screen display includes ANSWER STATUS.
- 4 Press **▼** until the screen displays includes TOLL SAVER and the current setting.
- 5 Press **◀** or **▶** to toggle between Off and On.
- 6 When the desired setting is shown, press **▼** to save your choice. The screen display includes REMOTE CODE.
- 7 Proceed to **Step 5** on page 50 to set the next feature (Remote Code)

—OR—

Press and hold **ENTER** to return to the idle screen.

**NOTE:** You can exit feature setup and return to the idle screen any time. Simply press and hold **ENTER**.

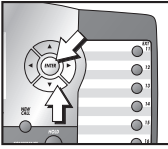

## Program the Remote Code

You can change the Remote Code (password) used to access your phone remotely.

- 1 Press **ENTER** to begin feature setup.
  - 2 Press **▼** until the screen display includes DTAD/AA.
  - 3 Press **ENTER**. The screen display includes ANSWER STATUS.
  - 4 Press **▼** until the screen display includes REMOTE CODE.
  - 5 Press **ENTER**. The screen display includes REMOTE CODE and the current code.
  - 6 Use the dial pad to enter a three-digit Remote Code, then press **▼** to save the new code. The screen display includes MESS. LENGTH.
  - 7 Proceed to **Step 5** on page 51 to set the next feature (Message Length)
- OR—**
- Press and hold **ENTER** to return to the idle screen.

**🎯 NOTE:** You can exit feature setup and return to the idle screen any time. Simply press and hold **ENTER**.

## Set Message Length

You can select the maximum length for the messages callers can record when the answering function is on. If you choose **Unlimited**, the caller can record a message of any length, up to the amount of time remaining for all messages, memos and announcements. If you choose **Greeting Only**, the caller will hear the selected outgoing announcement but will not be able to record a message. If you choose **1 minute**, the caller can record a message up to one minute long.

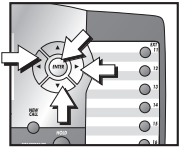

- 1 Press **ENTER** to begin feature setup.
- 2 Press **▼** until the screen display includes **DTAD/AA**.
- 3 Press **ENTER**. The screen display includes **ANSWER STATUS**.
- 4 Press **▼** until the screen display includes **MESS. LENGTH** and the current setting.
- 5 Press **◀** or **▶** to scroll through the choices (**Unlimited**, **1 minute**, or **Greeting Only**). When the desired message length is displayed, press **▼** to save your choice. The screen display includes **MESS. ALERT**.
- 6 Proceed to **Step 5** on page 52 to set the next feature (**Audible Message Alert**)  
**—OR—**  
 Press and hold **ENTER** to return to the idle screen.

**⊙ NOTE:** You can exit feature setup and return to the idle screen any time. Simply press and hold **ENTER**.



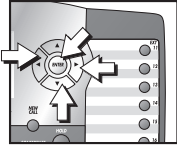

## Turn Audible Message Alert On or Off

- 1 Press **ENTER** to begin feature setup.
  - 2 Press **▼** until the screen display includes DTAD/AA.
  - 3 Press **ENTER**. The screen display includes ANSWER STATUS.
  - 4 Press **▼** until the screen display includes MESS. ALERT and the current setting.
  - 5 Press **◀** or **▶** to toggle between Off and On. When the correct setting is shown, press **▼** to save your choice. The screen display includes MONITOR.
  - 6 Proceed to **Step 5** on page 53 to set the next feature (Monitor)
- OR—**
- Press and hold **ENTER** to return to the idles screen.

**🎯 NOTE:** You can exit feature setup and return to the idle screen any time. Simply press and hold **ENTER**.

## Turn Monitor On or Off

If you wish to hear incoming messages as they are recorded, turn the Monitor feature on.

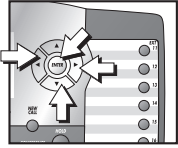

- 1 Press **ENTER** to begin feature setup.
  - 2 Press **▼** until the screen display includes DTAD/AA.
  - 3 Press **ENTER**. The screen display includes ANSWER STATUS.
  - 4 Press **▼** until the screen display includes MONITOR and the current setting.
  - 5 Press **◀** or **▶** to toggle between On and Off. When the correct setting is shown, press **▼** to save your choice. The screen display includes DTAD INTERCEPT.
  - 6 Proceed to **Step 5** on page 54 to set the next feature (D-TAD Intercept)
- OR—**
- Press and hold **ENTER** to return to the idle screen.

**🎯 NOTE:** You can exit feature setup and return to the idle screen any time. Simply press and hold **ENTER**.

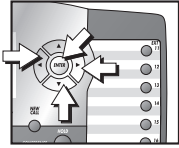

## Turn D-TAD Intercept On or Off

If you want other phones connected to Line 1 on this extension to be able to pick up a call while the caller is recording a message, turn D-TAD Intercept on. For instructions to use this feature, see “Intercept an Incoming Message” on page 105.

- 1 Press **ENTER** to begin feature setup.
- 2 Press **▼** until the screen display includes DTAD/AA.
- 3 Press **ENTER**. The screen display includes ANSWER STATUS.
- 4 Press **▼** until the screen display includes DTAD INTERCEPT and the current setting.
- 5 Press **◀** or **▶** to toggle between Off and On. When the correct setting is shown, press **▼** to save your choice. The screen display includes MAIN MENU .
- 6 Press and hold **ENTER** to return to the idle screen.

**Ⓞ NOTE:** You can exit feature setup and return to the idle screen any time. Simply press and hold **ENTER**.

You will need to program the next two features if this phone is the designated Console Phone for your Centrex system.

## Set This Phone to be the Centrex Console Phone

**NOTE:** This feature is for use with Centrex systems only.

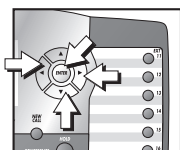

- 1 Press **ENTER** to begin feature setup.
- 2 Press **▼** until the screen display includes CENTREX.
- 3 Press **ENTER**. The screen display includes CONSOLE and the current setting.
- 4 Press **◀** or **▶** to toggle between On and Off.
- 5 Press **▼** to save your choice. The screen display includes CSL DELAY RING.
- 6 Proceed to **Step 5** of “Set the Centrex Console Delayed Ring Time” on page 56 to change the next feature (Console Delay Ring)  
— **OR** —  
Press and hold **ENTER** to return to the idle screen.

**NOTE:** You can exit feature setup and return to the idle screen any time. Simply press and hold **ENTER**.

## Set the Centrex Console Delayed Ring Time

**NOTE:** This feature is for use with Centrex systems only.

Set the length of time the phone will route your calls to the Centrex Console phone. One ring is about six seconds.

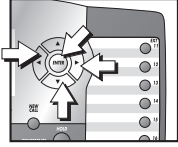

- 1 Press **ENTER** to begin feature setup.
- 2 Press **▼** until the screen display includes **CENTREX**.
- 3 Press **ENTER**. The screen display includes **CONSOLE**.
- 4 Press **▼** until the screen display includes **DSL DELAY RING** and the current setting.
- 5 Press **◀** or **▶** to scroll through the choices (**Off, 02 sec...30 sec**).
- 6 Press **▼** to save your choice. The screen display includes **MAIN MENU**.
- 7 Press and hold **ENTER** to return to the idle screen.

**NOTE:** You can exit feature setup and return to the idle screen any time. Simply press and hold **ENTER**.

## Set the Display Language

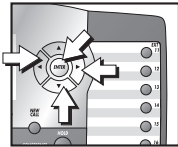

- 1 Press **ENTER** to begin feature setup.
- 2 Press **▼** until the screen display includes **LANGUAGE** and the current setting.
- 3 Press **◀** or **▶** to scroll through the language choices (**English, Espanol, or Français**). When the language you want to use is displayed, press **▼** to save your choice. The screen display includes **EXIT**.
- 4 Press **ENTER** to return to the idle screen.

**NOTE:** You can exit feature setup and return to the idle screen any time. Simply press and hold **ENTER**.

# TELEPHONE OPERATION

**NOTE:** When you make a call, the phone selects the Prime Line you programmed (See “Assign the Prime Line” on page 34). When you answer a call, the phone automatically selects the ringing line.

## Make or Answer a Call

**NOTE:** This phone will automatically make and answer calls in the mode (speakerphone or headset) you programmed (see “Set Automatic Mode” on page 35). Follow the directions below to choose a mode manually. If the phone is in use on one line, any other calls made or answered will use the same mode already in use.

**NOTE:** If you dial a phone number longer than 15 digits, the screen will display only the last 13 digits.

### Handset

**To make a call, lift the handset and dial the call.**

**To answer a call, lift the handset. Replace the handset to end the call.**

**To override automatic line selection, press the LINE button for the line you wish to select, then lift the handset.**

continued on page 58

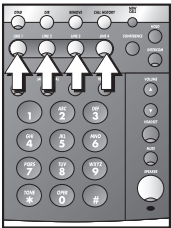

## Make or Answer a Call

continued from page 57

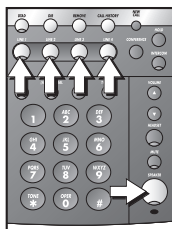

### Speakerphone

**To make a call,** press and release the desired LINE button or **[SPEAKER]**. The SPEAKER light goes on. Wait for a dial tone, then dial the call. Press **[SPEAKER]** to end the call.

**To answer a call,** press **[SPEAKER]** or press the LINE button of the incoming call. Press **[SPEAKER]** again to end the call.

**NOTE:** If headset is programmed as the default mode (see “Set Automatic Mode” on page 35), you must press **[SPEAKER]** to activate the speakerphone.

### Headset

You can use this phone hands-free when you install any industry standard two-band 2.5mm headset (purchased separately). For best results use an AT&T two-band 2.5mm headset.

Make sure the headset is plugged into the headset jack. You will hear a double-beep if you press **[HEADSET]** when the headset is not plugged in.

**NOTE:** If headset is programmed as the default mode, (see “Set Automatic Mode” on page 35) but the headset is not plugged in, the phone will switch to speakerphone.

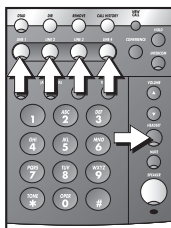
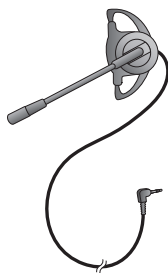

**To make a call,** press and release **[HEADSET]** or press the desired LINE button and then press **[HEADSET]**. The HEADSET light goes on. Wait for a dial tone, then dial the call. Press **[HEADSET]** to end the call.

**To answer a call,** press **[HEADSET]**. Press **[HEADSET]** again to end the call.

**NOTE:** If speakerphone is programmed as the default mode (See “Set Automatic Mode” on page 35), you must press **[HEADSET]** to activate the headset.





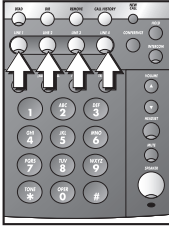

## Call Privacy

To ensure call privacy, this phone allows only one set at a time to use a line.

### Cancel Call Privacy

During the call, press the LINE button for the call. You'll hear a short beep. Others can now join the call.

### Restore Call Privacy

Press the LINE button again during the call. You'll hear a double-beep. The other phones will be dropped from the call.

**NOTE:** Call privacy is automatically restored when you end the call.

**NOTE:** When a non-system phone answers a call, any other system phone can pick up the call by pressing the LINE button. Once a system phone picks up the call, Call Privacy is activated and no other system phones can listen to the call unless Call Privacy is canceled, but non-system phones which share that line can still join the call.

## Do Not Disturb

When you activate Do Not Disturb (DND), you will not hear paging tones, voice paging, or incoming call rings. Instead, the LINE light flashes and the INTERCOM light goes on to signal an incoming call or page. If you receive an intercom call, the INTERCOM light flashes, and the number of the intercom extension calling you appears on the display.

- 1 Press **[DND]** to prevent interruptions. The DND light goes on and the screen display includes **DND**.
- 2 Press **[DND]** again to resume normal call alerts. The DND light goes off and the screen no longer shows **DND**.



When this feature is activated, callers from within your phone system will hear long beeps.

## Volume

### Handset/Speakerphone/Headset Volume Control

When you are on a call, press VOLUME ▲ to increase call volume. Press VOLUME ▼ to decrease volume. You will hear a beep when you reach the minimum or maximum level.



### Ringer Volume

When the phone is ringing, press VOLUME ▲ or VOLUME ▼ to adjust the ringer volume. This phone has four ringer volume levels. As you adjust the ringer, you will hear the ring change.

### Turning Ringer Off

You may turn the ringer for each line on or off. For detailed instructions see “Turn the Ringer On/Off for Each Line” on page 27.

## Redial

The last number dialed from this extension (up to 32 digits) is stored in redial memory until you dial another number.

### Handset

To dial the same number again, lift the handset, listen for the dial tone, then press **(AUTO) REDIAL**.

### Speakerphone or Headset

To dial the same number again, press a LINE button, then press **(AUTO) REDIAL**. The phone automatically dials the last number.

⊙ **NOTE:** You must go off hook (lift handset or press a LINE button for speakerphone or headset) before you press **(AUTO) REDIAL**. If you press **(AUTO) REDIAL** without going off hook, the screen displays the redial memory stack. (See “Redial Stack” on page 62.)

⊙ **NOTE:** You will experience a delay before the call is dialed when using the Redial feature. This is normal.



## Redial Stack

The last six numbers dialed from this extension are automatically stored in the redial memory stack. You can review the numbers in the redial memory and dial one if you wish.

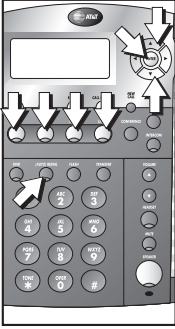

- 1 When the phone is not on a call, press **[AUTO REDIAL]**.
- 2 Press **[▲]** or **[▼]** to scroll through the last six numbers dialed at this extension.
- 3 When the number you want to call is displayed, press **[ENTER]** or a **LINE** button. The call is dialed automatically using the mode (headset or speakerphone) you programmed as the Automatic Mode. (See “Set Automatic Mode” on page 35.)

**NOTE:** If you do not place a call within 30 seconds, the screen returns to idle.

## Auto Redial

This phone can automatically redial a number every 60 seconds up to ten times, or until the other line rings or you cancel Auto Redial. When the phone automatically redials the number, it always uses the line you originally used to dial the call.

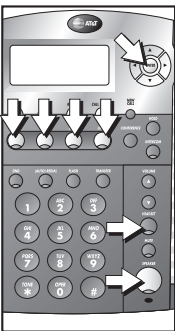

- 1 Follow the instructions under “Redial Stack” above to find the number you want to call.
- 2 Press a **LINE** button  
— **OR** —  
Press **[ENTER]**. The phone will dial the call.
- 3 When the other line rings or the other party answers, lift the handset  
— **OR** —  
Press **[SPEAKER]**  
— **OR** —  
Press **[HEADSET]** and speak with the other party.

**NOTE:** You will hear a double-beep if you press **[HEADSET]** when the headset is not plugged in.

To cancel Auto Redial, press any button except **VOLUME [▲]** or **VOLUME [▼]**.

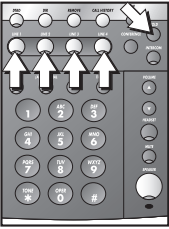

## Hold

While on a call, press and release **HOLD**. The LINE light for the line on hold flashes slowly in green, and a double-beep sounds every 30 seconds to remind you the call is on hold. (To turn off the reminder beep, see “Turn Hold Reminder On or Off” on page 31.) If you were using the handset, you can replace the handset in the cradle without disconnecting the call. If you were using the speakerphone, the speakerphone is automatically turned off when you press **HOLD**.

To release Hold, press and release the LINE button of the call on hold.

**NOTE:** The phone automatically disconnects a call on hold after 20 minutes. To keep a call on hold longer than 20 minutes, release Hold before 20 minutes and then place the call on hold again.

**NOTE:** You cannot put an intercom call on hold.

**NOTE:** If a line is in use, pressing **INTERCOM** will place the line on hold and activate the intercom.



## Switch Between Lines

- 1 Press and release **HOLD** to keep a call on the first line.
- 2 Press and release the LINE button of another line to make or answer another call.

**NOTE:** If you switch lines without pressing **HOLD** first, you will drop the call.

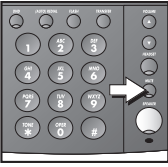

## Mute

Mute allows you to hear the other party, but the other party can't hear you.

**To activate this feature,** press and release **MUTE**. The MUTE light goes on.

**To return to the conversation,** press and release **MUTE** again.

**NOTE:** Switching from handset to speakerphone or headset, or from speakerphone or headset to handset, changing lines, and putting a call on hold also cancels Mute.

## Flash

Use **FLASH** instead of the switchhook to activate telephone company subscriber services such as Call Waiting or Three-Way Calling.



## Temporary Tone Dialing

If you have dial pulse (rotary) service, you can change from dial pulse to touch tone dialing during a call by pressing **X-TONE**.

- 1 Dial the number.
- 2 Press and release **X-TONE**. Buttons pressed after this send touch tone signals.
- 3 After you hang up, the phone automatically returns to pulse service.



## Conference Calls

This feature lets you set up a three-party call by using two lines at the same time. You can also join an intercom call with a call on an outside line. The outside line call must be established first because an intercom call cannot be placed on hold.

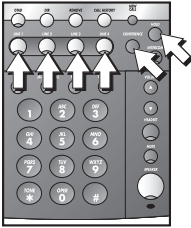

- 1 Make or answer a call.
- 2 Press and release **HOLD**.
- 3 Call someone on another line.
- 4 When this call is answered, press **CONFERENCE**. The three-party conference begins immediately.
- 5 To end a conference call, hang up. All parties will disconnect.

### To talk privately with one party:

- 1 Press **HOLD** to place both lines on hold.
- 2 Press a **LINE** button to talk privately with the person on that line.
- 3 Press **CONFERENCE** to resume the conference call.

**NOTE:** An intercom call cannot be placed on hold. If one party is on the intercom, that party will be dropped from the call if you press **HOLD**.

### To drop one line:

Press the **LINE** button of the party you want to keep. The other line will be dropped.

**NOTE:** Occasionally, the far-end parties on a conference call might not hear one another.

## Transfer a Call

You can transfer a call you answer to any other system phone. Once you transfer a call, it can be picked up at any other system phone, not just at the extension you called. For information about using the display screen menus, see MENU OPERATION beginning on page 22.

**NOTE:** If a transferred call is not picked up within 20 minutes, the phone will automatically disconnect the call.

### Blind Transfer

While on a call:

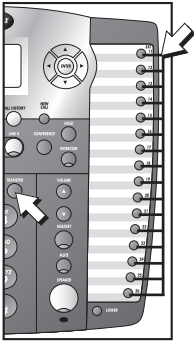

- 1 Press **TRANSFER**. The screen displays:

```
12:08 PM  12/26
EXT 11
Transfer
```

- 2 Press the **EXT** button for the extension where you're transferring the call  
— **OR** —  
Dial the extension number where you're transferring the call. The screen displays:

```
12:08 PM  12/26
EXT 11
Transfer 12
```

- 3 Hang up.

Your phone reminds you with a double-beep every 30 seconds when a transferred call has not been answered.

**NOTE:** If you do not dial an extension within 10 seconds, the transfer is automatically cancelled.

## Transfer a Call and Speak to the Receiving Party

While on a call:

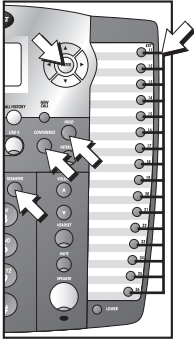

- 1 Press **HOLD**.
- 2 Press **INTERCOM**. The screen displays:

```
12:08 PM  12/26
EXT 11
INTERCOM TO_
PAGE
```

- 3 Press **ENTER**. The screen displays

```
12:08 PM  12/26
EXT 11
Paging
PAGE
```

- 4 Press the **EXT** button for the extension where you're transferring the call. The screen displays:

```
12:08 PM  12/26
EXT 11
PAGE 12
```

When the other party answers you can announce the call.

- 5 Press **TRANSFER**, then press the **EXT** button for the extension where you're transferring the call.

**NOTE:** If you do not dial an extension within 10 seconds, the transfer is automatically cancelled.

## Answer a Transferred Call

When you hear a long transfer ring, pick up the handset or press the **LINE** button of the call to use the speakerphone or headset.

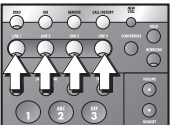

## Low Battery Indicator

The screen displays **LOW BATT** when the battery needs to be replaced, or when no battery is installed.



## Lights and What They Mean

LIGHT:	STATUS:	MEANS:
<b>LINE</b>	On steadily, green	This line is in use at this extension.
	On steadily, red	This line is in use at another extension.
	Flashing slowly, green	This line is on hold at this extension.
	Flashing slowly, red	This line is on hold at another extension.
	Flashing quickly, green	This line is ringing. — <b>OR</b> — You are transferring a call from this extension.
	Triple flash, red	A call on this line is being transferred at another extension.
<b>INTERCOM</b>	Flashing slowly	This intercom is in use at another extension.
	Flashing quickly	You have an incoming intercom call.
	On steadily	You are on an intercom call.
<b>MUTE</b>	On	This phone is muted.
<b>SPEAKER</b>	On	You are on a speakerphone call.
	Flashing slowly	This phone is dialing an Auto Redial call.
<b>HEADSET</b>	On	You are on a headset call.
<b>DND</b>	On	Do Not Disturb is turned on.

## Lights and What They Mean

<b>LIGHT:</b>	<b>STATUS:</b>	<b>MEANS:</b>
<b>(AUTO)REDIAL</b>	On steadily	The phone is waiting to redial an Auto Redial call.
	Flashing slowly	This phone is dialing an Auto Redial call.
<b>DTAD</b>	On steadily	Answering function is turned on.
	Flashing slowly	Answering function is turned on and you have new messages.
<b>NEW CALL</b>	On steadily	There is a new call in call history.
	Flashing slowly	There is a message waiting.

# ONE TOUCH OPERATION

This telephone has 32 One Touch locations where you can store phone numbers you wish to dial using fewer keys than usual. You can store up to 24 digits in each location. The steps used to dial numbers stored in One Touch locations vary according to how you programmed the One Touch Preference. See “Set One Touch Preference” on page 25 and “Dial a One Touch Number” on page 74 for more details.

The first 16 locations can be accessed using only the EXT buttons. To access the remaining 16 locations, press **LOWER** and then the EXT button for the desired location.

**NOTE:** The EXT buttons are also used to place intercom calls. See INTERCOM OPERATION beginning on page 83 for details.

You may wish to write the names or telephone numbers of One Touch entries on the directory card, using the light gray spaces for the first 16 locations and the dark gray spaces for the second 16 locations.

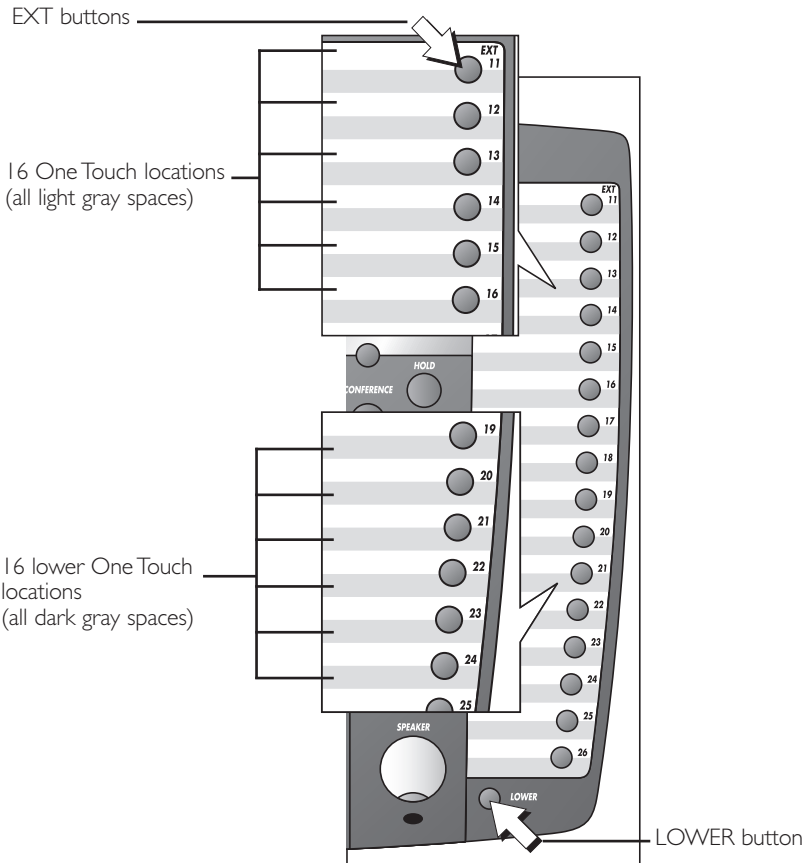

## Store a Number in a One Touch Location

For information about using the display screen menus, see MENU OPERATION on page 22.

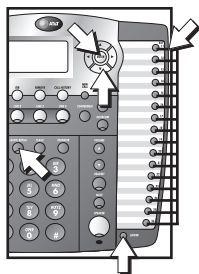

- 1 Press **ENTER** to enter the feature menu. The screen displays ONE TOUCH.
- 2 Press **ENTER**. The screen display includes PREFERENCE and the current setting.
- 3 Press **▼** until the screen display includes PROGRAM.
- 4 Press **ENTER**. The screen display includes Enter Number.
- 5 Enter the phone number using the dial pad  
— **OR** —  
Press **(AUTO) REDIAL** to copy the last number dialed from this extension to this location. The screen will show the number as you enter it. You can press **◀** to backspace.
- 6 When you are finished entering the number, choose a One Touch location:  
Press the EXT button  
— **OR** —  
Press **LOWER**, then press the EXT button. The screen displays the number entered and Stored!.

**NOTE:** Only the last number dialed from this extension can be copied to a One Touch location. The other numbers in the redial stack cannot be copied.

**NOTE:** You can exit storing a number at any time. Press **▼** until the screen shows CANCEL, then press **ENTER**.  
— **OR** —  
Press and hold **ENTER**.

continued on page 72

## Store a Number in a One Touch Location

continued from page 71

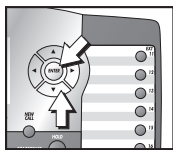

### Store a Pause in a One Touch Entry

You can include a pause while storing a dialing sequence which requires one during actual dialing.

While you are entering the number to be stored, the screen display includes PAUSE.

Press **ENTER** where you want to store a pause. Each pause counts as one digit. Continue storing the number as usual.

### Store Temporary Touch Tone Signals in a One Touch Entry

If you have dial pulse (rotary) service, you can store a dialing sequence which includes the touch tone signals required for some special services.

While you are entering the number to be stored, the screen display includes PAUSE.

When you want to begin storing temporary tone signals, press **▼** until the screen display includes TONE, then press **ENTER**. All numbers you enter after this will send touch tone signals during dialing.

### Store a Flash in a One Touch Entry

You can store the flash signal required by some special services as part of a dialing sequence.

While you are entering the number to be stored, the screen display includes PAUSE.

When you want to enter a flash signal, press **▼** until the screen display includes FLASH, then press **ENTER**. Continue storing the number as usual.

## Review a One Touch Entry

For more information using the display screen menus, see MENU OPERATION on page 22.

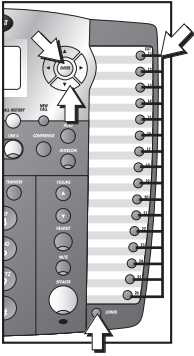

- 1 Press **ENTER** to enter the feature menu. The screen displays ONE TOUCH.
- 2 Press **ENTER**. The screen display includes PREFERENCE.
- 3 Press **▼** until the screen display includes VIEW.
- 4 Press **ENTER**.
- 5 Press the EXT button  
— OR —  
Press **LOWER**, then the EXT button for the entry you want to review. The screen displays the number stored in that location.  
If there is no number stored in this location, the screen display includes (empty).
- 6 Press and hold **ENTER** to return to the idle screen.

**NOTE:** You can exit One Touch review at any time. Simply press and hold **ENTER**.

## Dial a One Touch Number

The steps used to call a One Touch number depend on how you programmed the One Touch Preference (see “Set One Touch Preference” on page 25).

### If One Touch Preference is set to INTERCOM:

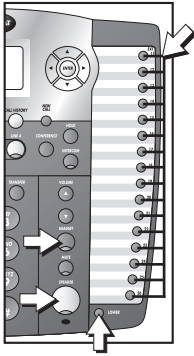

- 1 Lift the handset  
— OR —  
Press **SPEAKER**  
— OR —  
Press **HEADSET** and listen for the dial tone.
- 2 Press the EXT button  
— OR —  
Press **LOWER**, then press the EXT button for the number you want to call.  
The screen displays the number as it is dialed.

If One Touch Preference is set to TELEPHONE, you do not need to go off hook and listen for a dial tone before you dial a One Touch number. You can simply:

- 1 Press the EXT button  
— OR —  
Press **LOWER**, then press the EXT button for the number you want to call.  
The screen displays the number as it is dialed using the speakerphone or headset as programmed for Automatic Mode. (See “Set Automatic Mode” on page 35.)

# DIRECTORY OPERATION

This phone can store up to 200 names and phone numbers in the directory. Names can be up to 16 characters long and numbers can be 24 digits long. Because directory entries are stored in alphabetical order, you may wish to enter names with the last name first in order to maintain consistency with the information stored automatically through the Caller ID function of this system.

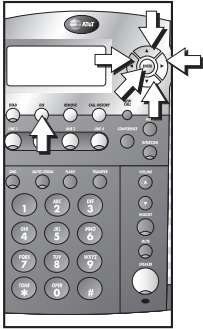

To enter directory mode, press **[DIR]**. The screen displays:

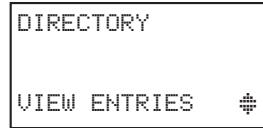

If there are already 200 stored entries, the screen display includes **DIRECTORY FULL!**. If you try to view directory entries when there are no entries, the screen displays **No Entries**.

To work with the directory, press **[ENTER]**. The screen will display menu choices on the bottom line.

To exit directory mode at any time, press **[DIR]**

—OR—

Press and hold **[ENTER]**.

## Menu Structure

Use the navigation buttons (**[Left]**, **[Right]**, **[Up]**, **[Down]**, **[ENTER]**) to move through menu operations. See **MENU OPERATION** on page 22 for information about moving through menus in the screen display. The menu structure for the directory is below.

VIEW ENTRIES	ADD ENTRY
DIAL	ENTER NUMBER
EDIT NAME	DONE
DONE	PAUSE
CANCEL	tone
EDIT NUMBER	FLASH
DONE	CANCEL
PAUSE	CANCEL
tone	
FLASH	
CANCEL	
MAIN MENU	



## Store a Name and Number in the Directory

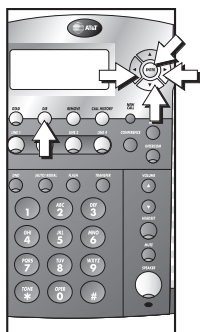

- 1 Press **DIR** to begin working with the directory.
- 2 Press **▼** until the screen display includes **ADD ENTRY**.
- 3 Press **ENTER**. The screen display includes **<Enter Name>**.
- 4 Use the dial pad keys and the chart below to enter the letters, digits or symbols you wish to store. Press the key repeatedly until the character you want is shown on the screen. For example, press **2** once for "A," twice for "B," three times for "C," and four times for "2." Press **▶** to move to the next character or space. Press **◀** to backspace. The name will appear on screen as you enter it.

PRESS:	ONCE	TWICE	3 TIMES	4 TIMES	5 TIMES	6 TIMES	7 TIMES	8 TIMES
<b>1</b>	,	-	'	&	.	(	)	!
<b>2</b>	<b>A</b>	<b>B</b>	<b>C</b>	<b>2</b>				
<b>3</b>	<b>D</b>	<b>E</b>	<b>F</b>	<b>3</b>				
<b>4</b>	<b>G</b>	<b>H</b>	<b>I</b>	<b>4</b>				
<b>5</b>	<b>J</b>	<b>K</b>	<b>L</b>	<b>5</b>				
<b>6</b>	<b>M</b>	<b>N</b>	<b>O</b>	<b>6</b>				
<b>7</b>	<b>P</b>	<b>Q</b>	<b>R</b>	<b>S</b>	<b>7</b>			
<b>8</b>	<b>T</b>	<b>U</b>	<b>V</b>	<b>8</b>				
<b>9</b>	<b>W</b>	<b>X</b>	<b>Y</b>	<b>Z</b>	<b>9</b>			
<b>*</b>	*							
<b>0</b>	<b>0</b>							
<b>#</b>	<b>#</b>							

- 5 When you are finished entering the name, press **ENTER** to move on to enter the phone number. The screen displays the name you entered and **<Enter Number>**.

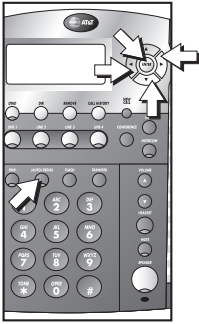

- 6 Use the dial pad keys to enter the phone number you wish to store

— OR —

Press **(AUTO) REDIAL** to copy the last number dialed at this extension onto the screen.

Press **◀** to backspace. The number will appear on the second line of the screen as you enter it.

- 7 When you are finished entering the number, press **(ENTER)** to store the name and number in the directory. The screen briefly displays the name and number you stored and **Saved!**. Then the screen will automatically return to include **ADD ENTRY**.

**NOTE:** You can exit the directory at any time without storing the entry, simply press **(DIR)**.

### Store a Pause in a Directory Number

You can include a pause in a number stored in the directory. When you reach the place in the dialing sequence where you wish to enter a pause, press **▼** until the screen displays:

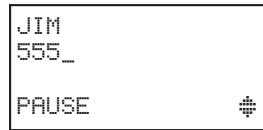

Press **(ENTER)** to store a two second pause. Then continue entering the number. Each pause counts as one digit.

continued on page 78

## Store a Name and Number in the Directory

continued from page 77

### Store a Temporary Tone Signal in a Directory Number

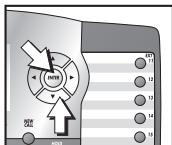

If you have dial pulse (rotary) service, you can store tone signals in a directory number. When you reach the place in the dialing sequence where you wish tone dialing to begin, press  until the screen displays:



Press **ENTER**. All digits entered after this will send tone signals.

### Store a Flash in a Directory Number

You can store the switchhook flash needed to access some custom-calling services in a directory number. When you reach the place in the dialing sequence where you wish to enter a flash, press  until the screen displays:

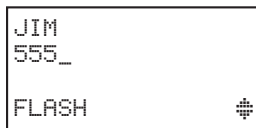

Press **ENTER** to store the flash, then continue entering the number. Each flash counts as one digit.

## Review Directory Entries



- 1 Press **DIR** to begin working with the directory.
- 2 Press **▲** or **▼** to scroll through the directory entries

— **OR** —

Press the dial pad key for the first character of the entry you wish to review until the character you are looking for is displayed. Then press **▲** or **▼** to scroll through the entries beginning with this character. If there is no entry for the character you chose, the screen will display `No Entries for "X"`.

**NOTE:** You can exit the directory at any time without storing the entry; simply press **DIR**.



## Dial a Number from the Directory

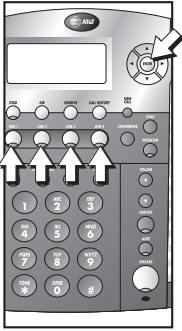

- 1 Find the entry for the number you wish to call by following the directions under “Review Directory Entries” on page 79.
- 2 Press the **LINE** button for the line you wish to use. The displayed number will be dialed in the mode (speakerphone or headset) you programmed (see “Set Automatic Mode” on page 35).

— OR —

Press **ENTER**. The screen display includes the number and **DIAL**. Press **ENTER** again, the phone will dial the call on the Prime Line in the mode (speakerphone or headset) you programmed (see “Set Automatic Mode” on page 35).

## Remove a Name and Number from the Directory



- 1 Find the entry for the number you wish to call by following the directions under “Review Directory Entries” on page 79.
- 2 When the entry you wish to delete is displayed, press **REMOVE**. The screen display includes **Removed!**. The screen automatically advances to the next directory entry.

**NOTE:** Once an entry is removed from the directory, it cannot be removed.



## Remove All Entries from the Directory

- 1 Press **DIR** to begin working with the directory.
- 2 Press **REMOVE**. The screen display includes Remove all?.
- 3 Press **REMOVE** again within three seconds to confirm the command and remove all directory entries. The screen briefly displays Removing ... and then All Removed!. The screen automatically returns to:

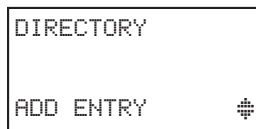

**NOTE:** Once an entry is removed from the directory, it cannot be removed.

# INTERCOM OPERATION

This 984 telephone is fully compatible with any AT&T Small Business System Speakerphone 945 or 974 units you may have installed. You can use a total of 16 945/974/984 units together as extensions in your phone system.

This 984 telephone is also compatible with any AT&T 964/955/944 phones you have previously installed. This 984 telephone is **NOT** compatible with any 843, 853, 854, 874, or 954 telephones you may have previously installed.

 **NOTE:** If you have one or more 964, 955, or 944 phone(s) installed in the same phone system with this 984 telephone, you can only have 12 extensions in the phone system.



Each individual phone in your telephone system **MUST** be assigned a unique extension number for the intercom feature to work. See “Assign an Extension Number to Your Phone” on page 26 for instructions.

 **NOTE:** If you subscribe to DSL service, please read “DSL Users” beginning on page 4 for information about minimizing problems with this phone caused by DSL signals.

This intercom features both a single-phone page and a system-wide page. A single-phone page alerts only one phone. A system-wide page alerts all system phones. Any phone with the Do Not Disturb (DND) feature activated will not receive a page.

An intercom call rings at the extension called with a repeating double-ring pattern.

A single-phone page automatically activates the speakerphone on the receiving phone. You can deactivate the speakerphone by lifting the handset.

 **NOTE:** If a line is in use, pressing **INTERCOM** will place the line on hold and activate the intercom.



## Basic Intercom Operations

<b>OPERATION:</b>	<b>FUNCTION:</b>
<b>INTERCOM</b>	Any two extensions connected to Line 1 can ring each other.
<b>PAGE</b>	Lets you “announce” over the speaker of the phone you’re calling. The person you’ve called can respond just by talking.
<b>PAGE ALL</b>	Lets you “announce” to all phones in the system at the same time (system-wide page).
<b>CONFERENCE</b>	Lets you connect another intercom call with an outside line.



## Make an Intercom Call with the Speakerphone or Headset

With the handset in the cradle:

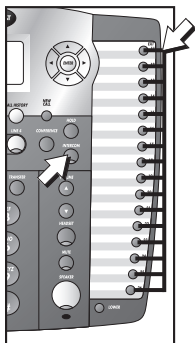

- 1 If One Touch Preference is set to INTERCOM, Skip to **Step 2**

— OR —

If One Touch Preference is set to TELEPHONE, press **INTERCOM**. The phone will automatically activate the line in the mode (headset or speakerphone) of the last call made.

- 2 Press the EXT button of the party you wish to reach. The screen display is similar to:

Extension called 12:08 PM 12/26  
INTERCOM TO 15

If the extension you called is idle or set to Do Not Disturb, you will hear long beeps. If the other extension is busy, you will hear a busy signal.

🎯 **NOTE:** The intercom call is automatically cancelled if you do not press an EXT button within 10 seconds.

🎯 **NOTE:** When you direct an intercom call to one extension, any extension in the system can answer the call by pressing **INTERCOM**.



## Page a Specific Extension (Single-phone Page)

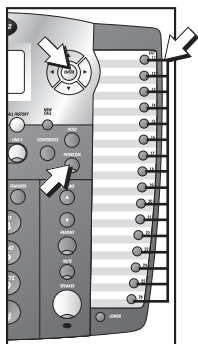

- 1 Press **INTERCOM**. The screen displays:

```
12:08 PM  12/26
EXT 11
INTERCOM TO_
PAGE
```

- 2 Press **ENTER**. The screen displays:

```
12:08 PM  12/26
EXT 11
Paging
PAGE
```

- 3 Press the EXT button for the party you wish to page. The screen display is similar to:

```
12:08 PM  12/26
EXT 11
PAGE 15
```

Extension paged

## Answer a Single-phone Page Auto-Mute Off

When your extension receives a page, the phone beeps and the speakerphone is automatically activated. Answer the call by simply speaking.

If you are on the headset, you can answer the page by pressing **HEADSET** and speaking through the headset.

## Auto-Mute On

The MUTE light will be on. Lift the handset or press **MUTE** to temporarily deactivate Auto-Mute and answer the page.

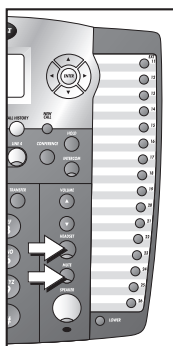

## Page All System Phones

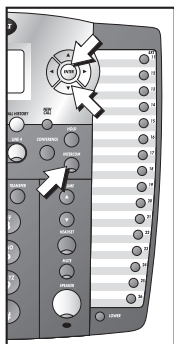

- 1 Press **INTERCOM**. The screen displays:

```
12:08 PM 12/26
EXT 11
INTERCOM TO_
PAGE
```

- 2 Press **▼** until the screen displays:

```
12:08 PM 12/26
EXT 11
INTERCOM TO_
PAGE ALL
```

- 3 Press **ENTER**. The screen displays:

```
12:08 PM 12/26
EXT 11
PAGE ALL
```

Once the page is answered at another extension, speak and your voice will be heard at all idle extensions in your phone system.

## Answer a System-wide Page

**NOTE:** Only one extension can answer a system-wide page.

When you receive a system-wide page, your phone beeps and the screen shows the paging extension with a display similar to:

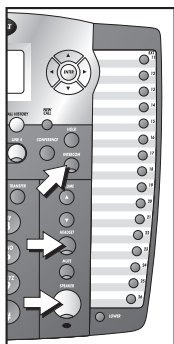

```
12:08 PM 12/26
PAGE ALL FROM 12
```

- 1 Press **INTERCOM** to answer the page. The screen display is similar to:

```
12:08 PM 12/26
INTERCOM FROM 12
```

- 2 To end, press and release **SPEAKER** or **HEADSET**.

## Make an Intercom Conference Call

A system phone on a two-way conversation on an outside line can invite a third party at an intercom extension into the conversation. Follow the directions under “Conference Calls” on page 65, making sure to establish the non-intercom call first.

**NOTE:** You cannot put an intercom conference call on hold.

## Room Monitor

You can activate the speaker of another phone to monitor sounds in that room. The Auto-Mute feature must be turned off at the phone you want to monitor. (See “Turn Auto-Mute On or Off” on page 30 for instructions.)

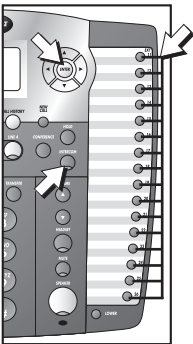

- 1 Press **INTERCOM**. The screen displays:

```

12:08 PM  12/26
EXT 11
INTERCOM TO_
PAGE
    
```

- 2 Press **ENTER**. The screen displays:

```

12:08 PM  12/26
EXT 11
Paging
PAGE
    
```

- 3 Press the **EXT** button for the telephone you want to monitor. The screen display is similar to:

```

12:08 PM  12/26
EXT 11
PAGE 15
    
```

The party at the extension being monitored will hear the intercom ring as with any page call, signaling that the speakerphone has been activated.

# CALLER ID OPERATION

This telephone has a Caller ID feature that works with Caller Identification service provided by your local telephone company. There is a fee for this service, and it may not be available in all areas. This phone can provide information only if both you and the caller are in areas offering Caller Identification service, and if both telephone companies use compatible equipment.

When you use this phone with Caller ID service, you can see who's calling before you answer the phone. If you subscribe to Caller ID with Call Waiting, a **combined** service available through many local telephone companies, you can see who's trying to reach you even when you're on another call. This service may be called by different names (such as Caller ID with Visual Call Waiting) by different local telephone companies and may not be available in all areas.

 **NOTE:** You must subscribe to combined Caller ID with Call Waiting as a single service to see Caller ID information for a Call Waiting call. Check with your telephone company for availability.

This phone assigns each incoming call a number from 1 to 200. The most recent call will have the highest number. (For example, if two calls have been received, call number 002 is the most recent.) When the call history is full, the oldest call information is automatically deleted to make room for new incoming call information.

The format of phone numbers displayed will depend on the Home and Local Area Codes you programmed. (See "Home Area Code" and "Local Area Codes" on page 6 for explanations of area codes. See "Program Home and Local Area Codes" on page 40 for programming instructions.) If the call came from within your Home Area Code, the screen displays only the seven digit number (without an area code). If the call came from one of your Local Area Codes, the screen displays 10 digits (area code plus the seven digit number). If the call did not come from any of the area codes you programmed, 1) phone numbers with 10 or more digits will automatically have a "1" inserted and displayed before the number and, 2) phone numbers with fewer than 10 digits will be displayed without a "1."



## Menu Structure

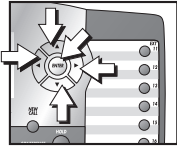

Use the navigation buttons (◀, ▶, ▲, ▼, **ENTER**) to move through menu operations. See **MENU OPERATION** on page 22 for information about moving through menus in the screen display. The menu structure for call history is below.

DIAL  
DIAL ALTERNATE  
COPY TO DIR  
COPY TO I-TOUCH

## Caller ID Display

When you receive incoming Caller ID information, the screen display is similar to:

```
12:08PM 12/26 L2  
SMITH, JOHN  
5550123
```

The time and date of the call, the caller's name and phone number are included in the display if sent by the caller's telephone company. The incoming line number of the call also appears on screen (L2 in the above example). Other messages may appear on screen. See "Display Screen Messages" on page 94 for more information.

Caller ID information will appear on the screen for 30 seconds or until the caller hangs up, the call is answered at another extension in your phone system, or another extension which answered the call hangs up.

If you subscribe to Caller ID service, this phone automatically resets the time and date each time new call information is received. You can set the time and date yourself if you wish. (See "Set the Time and Date" on page 32.)

## Call Waiting

If you subscribe to Caller ID with Call Waiting service and you receive a Call Waiting call, the screen displays call information for the call similar to:



```
L2 (CallWaiting)
SMITH, JOHN
5550123
```

- 1 Press **FLASH** to access the Call Waiting call.
- 2 To switch back to the original call, press **FLASH** again.

## Calls Received on Two or More Lines Simultaneously

Your screen can display the Caller ID information for only one call at a time, but you can switch between the information for two or more ringing lines by pressing **◀** or **▶**.

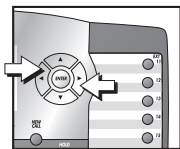

For example, if Line 3 of the phone is ringing, the screen displays the Caller ID information for Line 3:

```
12:08PM 12/26 L3
SMITH, JOHN
5551234
```

If the phone begins to ring on Line 1, the screen will display the new caller's information after it is received:

```
12:08PM 12/26 L1
BROWN, MARY
5550127
```

Press **◀** or **▶** to review the Caller ID information for the first call and the screen displays:

```
12:08PM 12/26 L3
SMITH, JOHN
5551234
```

Pressing **◀** or **▶** repeatedly will allow you to switch between all of the incoming call information. See "Display Screen Messages" on page 94 for information about other possible messages.

## Display Screen Messages

DISPLAY:	MEANS:
PRIVATE NAME	The other party is blocking name information.
PRIVATE NUMBER	The other party is blocking telephone number information.
UNKNOWN NAME	Your phone company is unable to receive information about this caller's name.
UNKNOWN NUMBER	Your phone company is unable to receive information about this caller's number.
OUT OF AREA	The call information is unavailable.

## Message Waiting and NEW CALL Light

This light stays on when you have received call information but have not yet reviewed it. If you subscribe to a Voice Mail service, this light flashes when you have unretrieved messages waiting. The screen also displays information about the number of new calls and voice mail messages waiting.

```
12:08PM    12/26
EXT 22
CID:100/198 COUM
           1 34
```

CID:100/198      Indicates 100 **new** Caller ID messages  
and 198 **total** Caller ID messages.

COUM  
1 34              There is Voice Mail “message waiting”  
information on Lines 1, 3 and 4.

## Call History

### View Call History Summary

- 1 Press **CALL HISTORY**. The screen displays the numbers of total calls and new calls in call history:

```
CALL HISTORY
198 CALLS
115 NEW
```

- 2 Press **CALL HISTORY** again to exit call history mode.

continued on page 96



## Call History

continued from page 95

### Review Records in Call History

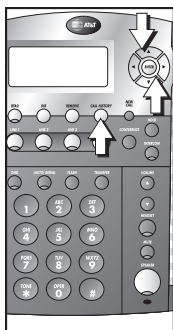

- 1 Press **CALL HISTORY**. The screen displays the numbers of total calls and new calls in call history:

```
CALL HISTORY
198 CALLS
115 NEW
```

- 2 Press **▼** to view the previous (most recent) caller's information

— OR —

Press **▲** to view the earliest caller's information.  
The screen displays the caller information:

```
10:27AM 11/12 L3
SMITH, JOHN
5550123
CL#001 NEW
```

10:27AM	11/12	Time and date of the call
L3		The call came in on Line 3
SMITH, JOHN		Caller's name
5550123		Caller's phone number
CL#001		This is the first (earliest) record in call history
NEW		This is new, previously unreviewed call information

See "Display Screen Messages" on page 94 for information about other possible messages.

**NOTE:** To exit call history at any time without saving changes, press **CALL HISTORY**.

## Remove Calls from Call History

### Remove a Specific Call Record from Call History



- 1 Locate the call record you wish to delete following the instructions under “Review Records in Call History” on page 96.

- 2 Press **REMOVE**. The screen display includes Removed!.

Then the screen displays the previous record in call history. If there are no records in call history, the screen displays:

```
CALL HISTORY
000 CALLS
000 NEW
```

### Remove All Calls from Call History

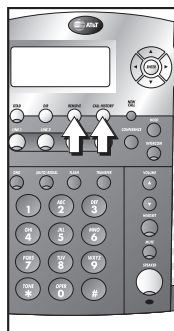

- 1 Press **CALL HISTORY**. The screen displays the numbers of total calls and new calls in call history.
- 2 Press **REMOVE**. The screen display includes Remove all?.
- 3 Press **REMOVE** again within three seconds to confirm the command and delete all records from call history. The screen display includes Removing... then ALL Removed!.

The screen automatically returns to the call history summary.

**NOTE:** To exit call history at any time without saving changes, press **CALL HISTORY**.

## Dial a Number from Call History

As you review call history records you can dial a displayed phone number.

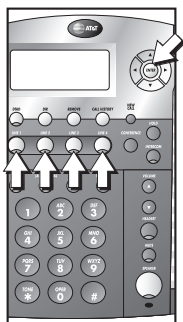

- 1 Locate the number you wish to call in call history (see “Review Records in Call History” on page 96). The screen display is similar to:

```
10:27AM 11/12 L3
SMITH, JOHN
5550123
CL#001 NEW
```

- 2 Press **ENTER**. The screen display includes DIAL.
- 3 Press **ENTER**. The phone will automatically select an idle line and dial the call

— OR —

Press the LINE button for the line you wish to use. The call will be dialed in the mode (speakerphone or headset) you programmed (see “Set Automatic Mode” on page 35).

## Dial Options

You can change the format of a number in call history before you dial.

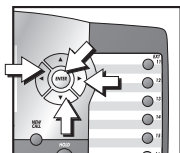

- 1 Follow the directions in **Steps 1 and 2** of “Dial a Number from Call History” above. The screen display includes DIAL.
- 2 Press **▼** until the screen display includes DIAL ALTERNATE.
- 3 Press **◀** or **▶** to scroll through the alternate dialing formats (seven digit number, area code + seven digit number, 1 + area code + seven digit number, or 1 + seven digit number). The screen displays the alternate formats on the third line.
- 4 When the format you want to use is displayed, dial the call as described in **Step 3** of “Dial a Number from Call History” above.

## Save a Name and Number from Call History to the Directory

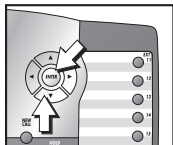

- 1 Locate the call history record number you wish to save (see “Review Records in Call History” on page 96). The screen display is similar to:

```
10:27AM 11/12 L3  
SMITH, JOHN  
5550123  
CL#001 NEW
```

- 2 Press **ENTER**. The screen display includes DIAL.
  - 3 Press **▼** until the screen display includes COPY TO DIR.
  - 4 Press **ENTER** to save the name and number to the directory. The screen displays the name, number and added to DIR!. The screen automatically returns to the call record just reviewed.
- NOTE:** If a call history record does not include a phone number, it cannot be saved to the directory.
- NOTE:** To exit call history at any time without saving changes, press **CALL HISTORY**.



## Save a Number from Call History to a One Touch Location

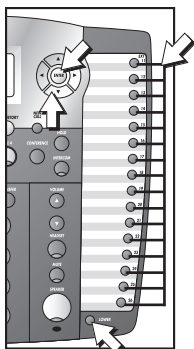

- 1 Locate the call history record you wish to save (see “Review Records in Call History” on page 96). The screen display is similar to:

```
10:27AM 11/12 L3
SMITH, JOHN
5550123
CL#001          NEW
```

⊙ **NOTE:** If a call history record does not include a phone number, it cannot be saved to a One Touch location.

- 2 Press **ENTER**. The screen display includes DIAL.
- 3 Press **▼** until the screen display includes COPY TO 1-TOUCH.
- 4 Press **ENTER** to begin to save the number. The screen display includes Press 1-TOUCH.
- 5 Press the EXT button where you want to save the number

— OR —

Press **LOWER**, then press the EXT button. The screen displays the number and saved to 1-TOUCH.

The screen automatically returns to the call record just reviewed.

⊙ **NOTE:** To exit call history at any time without saving changes, press **CALL HISTORY**.

# ANSWERING SYSTEM (D-TAD) OPERATION

The answering system can store approximately 20 minutes of messages, memos and announcements, for a total of up to 99 messages.

## Turn Answering System On/Off

The answering function of this phone is programmable. See "Set Answering System Status" on page 43 of FEATURE SETUP for programming instructions.

## Enter D-TAD Mode

Press **[DTAD]** to access answering system features whether the answering function is turned on or off. The screen display is similar to:

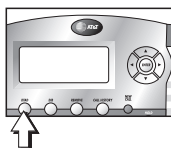

```
DTAD
21 Messages
PLAY NEW MSGS  #
```

If D-TAD memory is full and the system cannot store additional messages, the screen display is similar to:

```
DTAD FULL!
21 Messages
PLAY NEW MSGS  #
```

When the answering system is on and there are new messages, the DTAD light flashes.

When the answering system is active (programming, message playback or taking a call), the dial pad keys are disabled.

To exit D-TAD and return to idle screen, press **[DTAD]**.

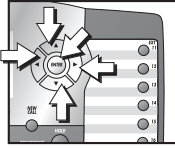

## Menu Structure

Use the navigation buttons (◀, ▶, ▲, ▼, **ENTER**) to move through menu operations. See MENU OPERATION on page 22 for information about moving through menus in the screen display. The menu structure for D-TAD operation is:

- PLAY NEW MSGS
- PLAY ALL MSGS
- RECORD CALL
- RECORD MEMO
- OGM PLAY&RECORD
  - PLAY
  - RECORD
  - EXIT
- REMOVE ALL MSGS

## Record an Outgoing Announcement

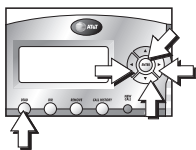

**NOTE:** If you choose not to record an outgoing announcement, the answering system plays a pre-recorded announcement. The pre-recorded announcement for **ANS-OGM** is, "HELLO, PLEASE LEAVE YOUR MESSAGE AFTER THE TONE." The pre-recorded Auto-Attendant outgoing announcements are described in the **ANSWERING SYSTEM AUTO-ATTENDANT OPERATION** section of this manual, beginning on page 110.

- 1 Press **DTAD** to access the answering system.
- 2 Press **▼** until the screen display includes **OGM PLAY&RECORD**.
- 3 Press **ENTER**. The screen display includes **PLAY** and the current announcement setting.
- 4 Press **◀** or **▶** to choose the outgoing announcement you want to record (**ANS-OGM**, **AA Day-OGM**, **AA Night-OGM**, or **AA AUX-OGM**).
- 5 When the desired announcement is shown, press **▼** until the screen display includes **RECORD** and the selected announcement.
- 6 Press **ENTER**. After the system beeps, speak toward the phone in a normal tone of voice without any background noise. While you are recording the screen display includes **Recording** and the selected announcement.
- 7 To stop recording, press **ENTER**. The system automatically plays back your announcement.

**NOTE:** To exit D-TAD and return to the idle screen at any time, press **DTAD**.

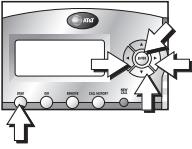

## Review an Outgoing Announcement

- 1 Press **[DTAD]** to access the answering system.
  - 2 Press **[▼]** until the screen display includes OGM PLAY&RECORD.
  - 3 Press **[ENTER]**. The screen display includes PLAY and the current announcement setting.
  - 4 Press **[◀]** or **[▶]** to choose the outgoing announcement you want to review (ANS-OGM, AA Day-OGM, AA Night-OGM, or AA AUX-OGM).
  - 5 When the desired announcement is shown, press **[ENTER]**. The announcement starts to play and the screen display includes Playing and the selected announcement.
  - 6 Press **[ENTER]** to stop playback. The screen display includes PLAY.
  - 7 Repeat **Steps 4-6** to review another outgoing announcement.
- OR—**
- Press **[DTAD]** to exit and return to the idle screen.

**🎯 NOTE:** To exit D-TAD and return to the idle screen at any time, press **[DTAD]**.

## Remove an Outgoing Announcement

**NOTE:** When you erase your announcement, the system returns to the pre-recorded announcement until you record a new one.

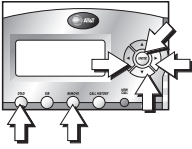

- 1 Press **[DTAD]** to access the answering system.
- 2 Press **[▼]** until the screen display includes OGM PLAY&RECORD.
- 3 Press **[ENTER]**. The screen display includes PLAY and the current announcement setting.
- 4 Press **[◀]** or **[▶]** to choose the outgoing announcement you want to record (ANS-OGM, AA Day-OGM, AA Night-OGM, or AA AUX-OGM).
- 5 When the desired announcement is shown, press **[ENTER]**. The announcement starts to play and the screen display includes Playing and the selected announcement.
- 6 While the outgoing announcement plays, press **[REMOVE]** twice to erase the announcement.

**NOTE:** To exit D-TAD and return to the idle screen at any time, press **[DTAD]**.

## Monitor Incoming Calls

When a caller is recording an incoming message, you can hear it through the speaker if you have programmed the Monitor to be on (see "Turn Monitor On or Off" on page 53).

## Intercept an Incoming Message

If D-TAD Intercept is turned on (see "Turn D-TAD Intercept On or Off" on page 54), you can pick up a call while the caller is recording a message. You must use a phone connected to the same incoming line as the caller is using. At a system phone, answer the call as usual. To answer the call at a non-system phone, press **#[7]**. The D-TAD stops recording when you pick up the call.

## Listen to Your Messages

The idle screen displays the numbers of total and new messages on the answering system. For example, this screen display:

```
12:08PM    12/26
EXT22

DTAD: 11/21
```

indicates that you have 11 new and a total of 21 messages stored on the answering system.

### Play new messages

- 1 Press **[DTAD]**. The screen display includes PLAY NEW MSGS.
- 2 Press **[ENTER]**. The answering system plays back only new messages in the order they were received. The D-TAD announces the time and date each message was received. The screen shows the number of the current message during playback.
- 3 Press **[ENTER]** at any time to stop message playback. The screen display includes PLAY and the current message number.
- 4 Press **[ENTER]** to resume message playback  
—OR—  
Press **[▽]** until the screen display includes EXIT MSG PLAY.  
Then, press **[ENTER]** to exit message playback.  
The screen returns to:

```
DTAD

21 Messages
PLAY NEW MSGS  ☎
```

### Play all messages

- 1 Press **[DTAD]**. The screen display includes PLAY NEW MSGS.
- 2 Press **[▽]** until the screen displays includes PLAY ALL MSGS.

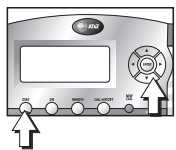
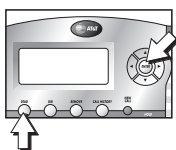

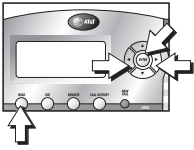

- 3 Press **ENTER**. The answering system plays back all messages in the order they were received. The D-TAD announces the time and date each message was received. The screen shows the number of the current message during playback.
- 4 Press **ENTER** at any time to stop message playback. The screen display includes **PLAY** and the current message number.
- 5 Press **ENTER** to resume message playback  
—OR—  
Press **▼** until the screen display includes **EXIT MSG PLAY**. Then, press **ENTER** to exit message playback. The screen returns to:

```
DTAD
21 Messages
PLAY ALL MSGS
```

### Repeat a message

During message playback, press **◀** to return to the previous message. The screen displays the current message number so you can see which message you've chosen. After you press **◀**, the the D-TAD plays only the previous message and message playback ends.

### Skip to next message

During message playback, press **▶** to skip to the next message. The screen displays the current message number so you can see which message you've chosen. After you press **▶**, the the D-TAD plays only the next message and message playback ends.

### Save messages

The D-TAD automatically saves your messages until you remove them. The answering system can store approximately 20 minutes of messages, memos and announcements, for a total of up to 99 messages. If D-TAD memory is full and the answering system cannot store additional messages, the screen display includes **DTAD FULL!**. You need to remove messages to make room for new ones.

**NOTE:** To exit D-TAD and return to the idle screen at any time, press **DTAD**.



## Remove Messages

### Remove a Selected Message

You can remove a message as you listen to it. Press **[REMOVE]** while the message you want to erase is playing. The screen display includes **Removed!** and the message number you erased.

The answering system immediately plays the next message.

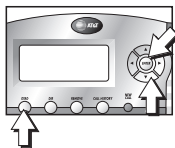

### Remove all messages

- 1 Press **[DTAD]** to access the answering system.
- 2 Press **[▼]** until the screen display includes **REMOVE ALL MSGS.**
- 3 Press **[ENTER]**. The screen display includes **Remove all?**
- 4 Press **[ENTER]** again within three seconds to confirm the command. The screen display briefly includes **All Removed!** then, quickly changes to include **RECORD MEMO.**

**⊙ NOTE:** If you try to remove all messages when you have new (unreviewed) messages, you will hear an error tone. The D-TAD will not remove any messages.

**⊙ NOTE:** To exit D-TAD and return to the idle screen at any time, press **[DTAD]**.

## Record a Memo

You can record a memo to be played back later with the incoming messages.

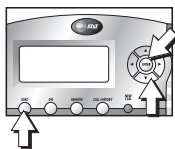

- 1 Press **[DTAD]** to access the answering system.
- 2 Press **[▼]** until the screen displays includes **RECORD MEMO.**
- 3 Press **[ENTER]**. After the beep, begin to record your memo. The screen displays includes **Memo Recording.**
- 4 Press **[ENTER]** to stop recording. The screen displays the number of messages and **RECORD MEMO.**

**⊙ NOTE:** To exit D-TAD and return to the idle screen at any time, press **[DTAD]**.

## Record a Phone Conversation

You can record both parties on a phone conversation to play back later with incoming messages.

**NOTE:** This phone does not sound warning beeps to let the other party know that the call is being recorded. To ensure that you are in compliance with any state and federal regulations that concern recording a telephone call, you should start the recording process and then inform the caller that you are recording the call.

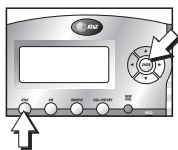

- 1 While on a call, press **DTAD**. The screen includes **RECORD CALL**.
- 2 Press **ENTER** to begin recording the conversation. The screen display includes a timer which counts the length of your recording.
- 3 Press **ENTER** to stop recording.

**NOTE:** To exit D-TAD and return to the idle screen at any time, press **DTAD**.

## Audible Message Alert

Program the Audible Message Alert to **On** if you want the phone to beep every 30 seconds to notify you that you have new messages. (See "Turn Audible Message Alert On or Off" on page 52.) The Audible Message Alert does not sound while you are on a call.

# ANSWERING SYSTEM

## AUTO-ATTENDANT OPERATION

**NOTE:** The Auto-Attendant feature only works with a multi-phone system. If this phone is the only telephone in your system, do NOT select Auto-Attendant for the Answer Status.

You can set this phone to function as an Auto-Attendant for a multi-phone system. A phone designated as an Auto-Attendant will pick up and redirect incoming calls to other extensions in the system. To set this phone to be an Auto-Attendant, follow the instructions to “Set Answering System Status” on page 43 of FEATURE SETUP and choose Auto-Attendant in **Step 4**.

Each Auto-Attendant can pick up only one line at a time, so you may wish to have more than one Auto-Attendant within your telephone system. You can designate up to 16 Auto-Attendants in your system. (See “Using Multiple Auto-Attendants” on page 115 for further information.)

When you designate a phone to be an Auto-Attendant, you will need to program the Day and Night Times (see “Set Auto-Attendant Day and Night Times” on page 47 in FEATURE SETUP). The Auto-Attendant will use the times you program to determine which outgoing announcement to play.

There are three different Auto-Attendant outgoing announcements available. You can choose to record your own Auto-Attendant outgoing announcements or use the pre-recorded Announcements listed here.

The Auto-Attendant Day Outgoing Announcement (AA Day-OGM), plays during the Day Time you program. The pre-recorded announcement is: “THANK YOU FOR CALLING OUR COMPANY. IF YOU KNOW YOUR PARTY’S EXTENSION, YOU MAY DIAL IT AT ANY TIME. FOR A COMPANY DIRECTORY, PLEASE DIAL ZERO.”

The Auto-Attendant Night Outgoing Announcement (AA Night-OGM), plays during the Night Time you program. The pre-recorded announcement is: “THANK YOU FOR CALLING OUR COMPANY. WE ARE CURRENTLY CLOSED. IF YOU WOULD LIKE TO LEAVE A MESSAGE AND YOU KNOW YOUR PARTY’S EXTENSION, YOU MAY DIAL IT NOW. FOR A COMPANY DIRECTORY, PLEASE DIAL ZERO.”

The Auto-Attendant Auxiliary Outgoing Announcement (AA Aux-OGM), plays when an outside caller presses [0] on their phone after hearing the Day or Night Announcement. The pre-recorded announcement is: “PLEASE ENTER THE EXTENSION NUMBER.”

**NOTE:** If you will be retaining the pre-recorded Auto-Attendant Day and Night outgoing announcements, you **MUST** record your directory of extension assignments as the Auto-Attendant Auxiliary outgoing announcements (See “Record an Auto-Attendant Outgoing Announcement” on page 113 for instructions.)

## Auto-Attendant Sequence for Callers

When you set this phone to be an Auto-Attendant, it automatically picks up a ringing line after the pickup time you programmed (see “Set Auto-Attendant Pickup Delay” on page 46 in FEATURE SETUP), and plays the appropriate Auto-Attendant outgoing announcement.

**When a caller enters an extension number after hearing the announcements**, the Auto-Attendant transfers the call to that extension and announces to the caller, “CALLING THAT EXTENSION, PLEASE WAIT.”

The Auto-Attendant continues to monitor the call after it is transferred. If the requested extension doesn’t pick up within 66 seconds, the unit announces, “THAT EXTENSION IS NOT ANSWERING. PLEASE ENTER THE EXTENSION NUMBER.” The Auto-Attendant will try to transfer the call up to three times. If the call is not picked up by any extension during those attempts, the call is dropped.

**NOTE:** If someone at the requested extension picks up the call and subsequently places the call on hold again, that extension must pick up the call again within 20 minutes or the call will be dropped. This is true each time the same call is placed on hold.

**If the caller does not enter an extension number after hearing the announcement**, the Auto-Attendant waits about 12 seconds, then transfers the call to Extension 11. If the call is not picked up after 66 seconds, the Auto-Attendant will answer the call again, play “PLEASE ENTER THE EXTENSION NUMBER,” and wait 12 seconds for the entry. If the caller still doesn’t enter an extension number, the Auto-Attendant announces, “THAT EXTENSION IS NOT ANSWERING,” and drops the call.

**If the caller presses [0] after hearing the message**, the Auto-Attendant Auxiliary Outgoing Message plays. The caller can then enter an extension number or not and the Auto-Attendant responds as described above.

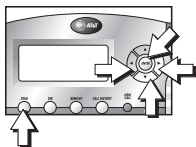

## Review an Auto-Attendant Outgoing Announcement

- 1 Press **[DTAD]** to access the answering system.
- 2 Press **[▼]** until the screen display includes OGM PLAY&RECORD.
- 3 Press **[ENTER]**. The screen display includes PLAY and the current announcement setting.
- 4 Press **[◀]** or **[▶]** to choose the outgoing announcement you want to review (ANS-OGM, AA Day-OGM, AA Night-OGM, or AA AUX-OGM).
- 5 When the desired announcement is shown, press **[ENTER]**. The announcement starts to play and the screen display includes Playing and the elected announcement.
- 6 Press **[ENTER]** to stop playback.

**🎯 NOTE:** To exit D-TAD and return to the idle screen at any time, press **[DTAD]**.

## Record an Auto-Attendant Outgoing Announcement

**NOTE:** If you choose not to record an outgoing announcement, the answering system plays a pre-recorded announcement. The pre-recorded Auto-Attendant outgoing announcements are described on page 110.

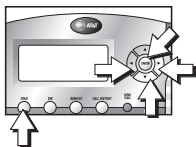

- 1 Press **[DTAD]** to access the answering system.
- 2 Press **[▼]** until the screen display includes: OGM PLAY&RECORD.
- 3 Press **[ENTER]**. The screen display includes PLAY and the current announcement setting.
- 4 Press **[◀]** or **[▶]** to choose the outgoing announcement you want to review (ANS-OGM, AA Day-OGM, AA Night-OGM, or AA AUX-OGM).
- 5 When the desired announcement is shown, press **[▼]** until the screen display includes RECORD and the selected announcement.
- 6 Press **[ENTER]**. After the system beeps, speak toward the phone in a normal tone of voice without any background noise. While you are recording the screen display includes Recording and the selected announcement.
- 7 To stop recording, press **[ENTER]**. The system automatically plays back your announcement.

**NOTE:** To exit D-TAD and return to the idle screen at any time, press **[DTAD]**.

## Remove an Auto-Attendant Outgoing Announcement

**NOTE:** When you erase your announcement, the system returns to the pre-recorded announcement until you record a new one.

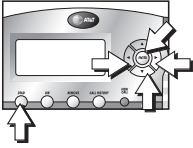

- 1 Press **[DTAD]** to access the answering system.
- 2 Press **[▼]** until the screen display includes OGM PLAY&RECORD.
- 3 Press **[ENTER]**. The screen display includes PLAY and the current announcement setting.
- 4 Press **[◀]** or **[▶]** to choose the outgoing announcement you want to review (ANS-OGM, AA Day-OGM, AA Night-OGM, or AA AUX-OGM).
- 5 When the desired announcement is shown, press **[ENTER]**. The announcement starts to play and the screen display includes Playing and the selected announcement.
- 6 While the outgoing announcement plays, press **[REMOVE]** twice to erase the announcement.

**NOTE:** To exit D-TAD and return to the idle screen at any time, press **[DTAD]**.

## Using Multiple Auto-Attendants

You may wish to set one or more additional phones to act as Auto-Attendant for when the primary Auto-Attendant is turned off or busy.

An Auto-Attendant is busy when someone at that extension is:

- programming the phone, or
- accessing messages, or
- on an intercom call, or
- dialing from the Directory or Call History, or
- using any of the lines to make or answer a call, or
- when the D-TAD is recording a message at that extension.

You can choose a particular extension to always be the primary Auto-Attendant by setting that extension to have the shortest Auto-Attendant Pickup Delay and setting the pickup delays of other Auto-Attendants in the order you choose. Otherwise, the primary Auto-Attendant could change as the system automatically assigns incoming calls among active Auto-Attendants.

**Ⓢ NOTE:** When multiple Auto-Attendants are used, program the pickup times with at least three seconds between them to avoid more than one Auto-Attendant trying to pick up a single call at the same time. To program pickup times see “Set Auto-Attendant Pickup Delay” on page 46 in FEATURE SETUP.



# ANSWERING SYSTEM

## REMOTE OPERATION

You can access many features of this answering system when you are away from your phone. The remote commands are the same whether you are calling from a remote, non-system touch tone phone or from another extension in the phone system. Only the method for connecting with the answering system differs.

## Connect with the Answering System

### From a touch tone phone outside the telephone system

- 1 Dial your telephone number.
- 2 When the D-TAD outgoing announcement begins to play, enter your remote code (see “Program the Remote Code” on page 50 in FEATURE SETUP).
- 3 Enter the remote commands (see “Remote Commands” on page 117).
- 4 To exit remote operation, hang up. The answering system will automatically disconnect your call if you do not enter a command within 20 seconds.

### From another extension within the telephone system

- 1 Page the extension of the answering system you wish to reach (see “Page a Specific Extension” on page 88 in INTERCOM OPERATION).
- 2 Enter your remote code within 20 seconds. (See “Program the Remote Code” on page 50 in FEATURE SETUP).
- 3 Enter the remote commands (see “Remote Commands” on page 117).
- 4 To exit remote operation, hang up. The answering system will automatically disconnect your call if you do not enter a command within 20 seconds.

## Remote Commands

### Play messages

- 1 Press **7** to play new messages  
— OR —  
Press **7** **✗TONE** to play all messages.
- 2 To replay the previous message, press **2**.  
To skip to the next message, press **3**.  
To stop message playback, press **8**.  
To save messages, hang up.

### Remove messages

- To remove a selected message, press **#****#** while the message is playing  
— OR —  
To remove all messages, press **#** **✗TONE**.

### Record a memo

- Press **9** to record a memo to be played back with other incoming messages.

### Review outgoing announcements

- 1 Press **4** to hear the Auto-Attendant Day Outgoing Announcement  
— OR —  
Press **5** to hear the Auto-Attendant Night Outgoing Announcement  
— OR —  
Press **6** to hear the Auto-Attendant Auxiliary Outgoing Announcement  
— OR —  
Press **7** to hear the D-TAD outgoing announcement.
- 2 Press **8** to stop message playback.

### Turn off the answering function

- Press **0**.

To exit remote operation hang up.

# ADDING A FAX MACHINE

**NOTE:** Do not connect a fax machine to Line 1. Doing so will interrupt the telephone's intercom data channel.

You may wish to use a fax machine with your phone. Choose Line 2, 3 or 4 for the fax machine, and connect it according to the manufacturer's instructions for installation and use.

- That line's telephone number is your fax number.
- The same line can be used for outgoing calls (incoming faxes will get a busy signal when the line is in use).
- Set your fax machine to answer on the first ring (follow manufacturer's instructions).
- To prevent the fax line from ringing at all the extensions, turn the ringer off for that line at other extensions (see "Turn the Ringer On or Off for Each Line" on page 27).

**NOTE:** If you are using a fax switch, or a fax machine with a built-in fax switch, see "Using a Fax Switch" below.

## Using a Fax Switch

A fax switch lets the telephone know, before the phone rings, whether an incoming call is a voice call or a fax call. Some fax machines have a built-in fax switch. Using a fax switch may affect the operation of the LINE lights or other system features.

# GENERAL PRODUCT CARE

To keep your phone working and looking good, follow these guidelines:

- Avoid putting it near heating appliances and devices that generate electrical noise (for example, motors or fluorescent lamps).
- DO NOT expose it to direct sunlight or moisture.
- Avoid dropping the phone and/or other rough treatment.
- Clean with a soft cloth.
- Never use a strong cleaning agent or abrasive powder because this will damage the finish.
- Retain the original packaging in case you need to ship it at a later date.

# TECHNICAL SPECIFICATIONS

## TECHNICAL SPECIFICATIONS

<b>REN</b>	0.3B
<b>Power Adapter</b>	Input: AC 120V, 60Hz Output: DC 12V, 500mA
<b>Battery</b>	One 9V alkaline battery required
<b>Intercom Signal Frequency</b>	Data 455 KHz

# TECHNICAL SPECIFICATIONS

# IN CASE OF DIFFICULTY

If you have difficulty operating this phone, try the suggestions below. For Customer Service, visit our website at [www.telephones.att.com](http://www.telephones.att.com) or call **1 800 222-3111**. **Have the serial number, found on the underside of your phone available when contacting Customer Service. Please retain your receipt as your proof of purchase.**

To purchase accessories or replacement parts contact Customer Service. Visit our website at [www.telephones.att.com](http://www.telephones.att.com) or call **1 800 222-3111**.

## TELEPHONE OPERATION

### PROBLEM

**Telephone Does Not Work Properly**

### SOLUTION

- This 974 telephone is not compatible with any 843, 853, 854, 874, or 954 telephones you may have previously installed.

### PROBLEM

**No Dial Tone**

### SOLUTION

- Make sure all plugs are connected properly. Inspect the line cord connections at the modular jack(s) and at the telephone. Also inspect the coiled handset cord connection at both ends.
- Make sure a line is selected.
- Make sure Hold is not activated.
- If you do not hear a dial tone when you press **HEADSET**, make sure the headset is firmly connected at the jack.

### PROBLEM

**Telephone Does Not Ring**

### SOLUTION

- Make sure the Do Not Disturb (DND) feature is not activated.
- Make sure the ringers are turned on.
- If there are several non-system phones on the line that doesn't ring, disconnect some of them. Having too many phones connected can also result in low ringer volume for non-system telephones.
- If the INTERCOM light flashes but you don't hear a paging signal, make sure the Do Not Disturb feature is not activated.

## TELEPHONE OPERATION

### PROBLEM

**A Repeating Short Ring (Error Ring) Sounds at All Extensions When You Assign an Extension Number to Your Phone**

### SOLUTION

The extension number you chose is already assigned. Begin again and choose a different extension number from 11 to 26 (see “Assign an Extension Number to Your Phone” on page 26). You **MUST** assign a different extension number to every phone in your system.

### PROBLEM

**Intercom Paging Signal Not Received**

### SOLUTION

Make sure you have programmed your intercom extension number correctly. Line 1 must be connected at all extensions, and must be the same telephone number/line for Page and Intercom to work properly.

### PROBLEM

**Cannot Join a Conversation in Progress**

### SOLUTION

The privacy feature prevents another set on the system from interrupting a conversation. Make sure you press the LINE button to release privacy.

### PROBLEM

**Error Tone (Fast Busy Signal) Heard When Making an Page Call**

### SOLUTION

The Do Not Disturb feature is activated at the extension you are calling.

### PROBLEM

**A Double Beep Sounds Every 30 Seconds**

### SOLUTION

There is a call on hold at this extension. Press and release the LINE button of the call to return to the call and turn off the reminder beep.

## TELEPHONE OPERATION

### PROBLEM

**LINE Lights Remain On When No Line is Connected**

### SOLUTION

- Make sure the phone is programmed for that line to be absent. (See “Turn Line Usage On or Off for Each Line” on page 33.)
- Make sure that your Line Groups are programmed properly. (See “Assign the Line Group for this Phone” on page 41.)
- Disconnect all other devices (fax, modem, credit card reader, etc.) from any lines connected to your 984 phone. These devices can interfere with the telephone’s data links.
- Make sure the total length of telephone wiring used in your phone system is less than 600 feet. In some cases a Z800A filter can be used in a phone system with more than 600 feet of wire. AT&T highly recommends that a Z800A filter be installed by a professional. AT&T **CANNOT** guarantee that this telephone will work with such a filter; and **IS NOT** responsible for such installations. A Z800A filter can be obtained by calling **800 222-3111**. (See “DSL Users” beginning on page 4 for details.)

---

### PROBLEM

**Tone Signals Do Not Activate a Remote Device**

### SOLUTION

Tone signaling does not work during conference calls.

---



## TELEPHONE OPERATION

### PROBLEM

**Operation During a Power Failure**

### SOLUTION

This phone will operate during a power failure if a working battery has been installed. You will be able to answer calls with the handset or headset, and dial calls using the keypad and the One Touch or Redial features. No other features will work until power is restored. All programming, directory entries, and Caller ID information are retained during a power failure.

### PROBLEM

**The Screen Displays Powerfail**

### SOLUTION

The phone has been disconnected from AC power. When power is restored, a key is pressed, or the phone is taken off the hook, the screen will return to the usual display. One Touch and Redial numbers are retained until power is restored.

### PROBLEM

**Display Screen is Blank**

### SOLUTION

Make sure the power cord is connected to both the phone and an electrical outlet not controlled by a wall switch.

### PROBLEM

**Intercom, Hold, Line Privacy or Other Advanced Features Do Not Work Properly**

### SOLUTION

- The total length of telephone wiring in your phone system **MUST** not be more than 600 feet.
- If you are a DSL customer, you may need to arrange for installation of a splitter and an AT&T Z800A filter. See "DSL Users" beginning on page 4 for details.
- Another device connected to Line 1 may be causing interference. Try disconnecting the device.

## CALLER ID OPERATION

### PROBLEM

No Caller ID Information While on a Call

### SOLUTION

- You must subscribe to **combined** Caller ID with Call Waiting as a **single** service to see Call Waiting information.
- You may need to press ◀ or ▶ to see the incoming Caller ID information for another line.

### PROBLEM

No Caller ID Information is Received

### SOLUTION

Caller ID information is transmitted by the telephone company between the first and second rings. Allow your phone to ring at least twice to receive Caller ID information.

### PROBLEM

NEW CALL Light Flashes

### SOLUTION

- Make sure you have reviewed all messages on all lines.
- You may have received a false signal from the Central Office. To clear, see “Reset COVM Indicator” on page 39 in FEATURE SETUP.

### PROBLEM

Screen Displays COVM

### SOLUTION

The screen displays COVM when the COVM indicator is turned on for at least one line, whether or not there are messages waiting, and whether or not you have Voice Mail service.

If you subscribe to Voice Mail service with your local telephone company, but prefer not to display COVM on the screen, turn off the COVM indicator for each line.

If you do not subscribe to Voice Mail service, turn off the COVM indicator for all lines.

See “Turn COVM Indicator On or Off for Each Line” on page 38 in FEATURE SETUP for detailed instructions.

## CALLER ID OPERATION

### PROBLEM

**COVM Line Indicator Remains On**

### SOLUTION

- Make sure you have reviewed all messages on that line.
- You may have received a false signal from the Central Office. To clear, see “Reset COVM Indicator” on page 39 in FEATURE SETUP.

## ANSWERING SYSTEM OPERATION

### PROBLEM

**Messages Are Incomplete**

### SOLUTION

If message length is programmed to one minute, messages longer than this will be cut off. See “Set Message Length” beginning on page 51 in FEATURE SETUP to change message length to *Unlimited*.

### PROBLEM

**Answering System Does Not Answer After Correct Number of Rings**

### SOLUTION

- See “Set Answer Delay” beginning on page 45 in FEATURE SETUP to change how long the phone rings before the answering system picks up a call.
- D-TAD features only work when the answering function is turned on. See “Set Answering System Status” on page 43 in FEATURE SETUP.
- If a fax machine shares a line with the answering function turned on, the Answer Delay must be programmed to allow the fax machine to answer calls first.

### PROBLEM

**Answering System Will Not Record Messages**

### SOLUTION

- When D-TAD memory is full, saved messages must be deleted before new messages recorded.
- Make sure Message Length is NOT set to *Greeting Only*. (See “Set Message Length” on page 51 and choose *Unlimited* or *1 minute*.)

## ANSWERING SYSTEM OPERATION

### PROBLEM

**Answering System Does Not Respond to Remote Commands**

### SOLUTION

- Make sure you are calling from a touch tone phone. When you dial a number, you should hear tones. If you hear clicks instead, the phone is not a touch tone telephone.
- There may be noise or interference on the phone line you are using. Press dial buttons firmly.
- You might be calling from a phone that sends tones too short for the 984 to detect.

---

### PROBLEM

**Incoming Calls Are Dropped By Auto-Attendant**

### SOLUTION

Make sure you have recorded the Auto-Attendant Outgoing Announcements and your directory of extension assignments. (See ANSWERING SYSTEM AUTO-ATTENDANT OPERATION beginning on page 110)

---

### PROBLEM

**Difficulty Intercepting a Call During Message Recording**

### SOLUTION

- D-TAD Intercept must be turned on. See “Turn D-TAD Intercept On or Off” on page 54.
  - You must use a phone connected to the line of the incoming call.
  - If you are using a non-system phone, press **#1** to intercept the incoming call.
-

# EXPANDING THE PHONE SYSTEM

When you combine two or more 945/974/984/944/955/964 phones you create an interacting system where phones share lines. If you have only 945/974/984 phones on your phone system, you can have up to 16 phones and up to 19 telephone lines. If you have one or more 944/955/964 phones in your phone system, you can have up to 12 phones and up to 15 telephone lines. The system can be expanded with or without Centrex service.

**NOTE:** All 984 features work as described earlier in this manual.

## Line Groups

When phones share lines, the LINE lights let users at different extensions know when a specific line is in use. For accurate LINE lights, the same lines must be connected to each extension in the Line Group, and they must have the same incoming telephone number at each extension.

The chart below shows 16 extensions, each sharing the first three lines, but being assigned to different Line Groups based on other shared or private lines.

		Lines in System						
		L1	L2	L3	L4	L5	L6	L7
Intercom Extensions	EXT 11	✓	✓	✓	✓			
	EXT 12	✓	✓	✓		✓		
	EXT 13	✓	✓	✓	✓		✓	
	EXT 14	✓	✓	✓		✓		
	EXT 15	✓	✓	✓	✓		✓	
	EXT 16	✓	✓	✓		✓		
	EXT 17	✓	✓	✓	✓		✓	
	EXT 18	✓	✓	✓		✓		
	EXT 19	✓	✓	✓	✓		✓	
	EXT 20	✓	✓	✓		✓		
	EXT 21	✓	✓	✓	✓		✓	
	EXT 22	✓	✓	✓		✓		
	EXT 23	✓	✓	✓	✓		✓	
	EXT 24	✓	✓	✓		✓		
	EXT 25	✓	✓	✓	✓		✓	
	EXT 26	✓	✓	✓				✓

## Private Lines

You can use the fourth line on each extension as a private line. A private line is a telephone number assigned to just one extension.

- NOTE:** You must program the lines you are using at each extension so that the phone knows which lines are shared and which are private. (You can physically wire lines with different telephone numbers into each unit for Line 4.)

The chart below shows 16 extensions, each sharing the first three lines.

		Lines in System																		
		L1	L2	L3	L4	L5	L6	L7	L8	L9	L10	L11	L12	L13	L14	L15	L16	L17	L18	L19
Intercom Extensions	EXT 11	✓	✓	✓	✓															
	EXT 12	✓	✓	✓		✓														
	EXT 13	✓	✓	✓			✓													
	EXT 14	✓	✓	✓				✓												
	EXT 15	✓	✓	✓					✓											
	EXT 16	✓	✓	✓						✓										
	EXT 17	✓	✓	✓							✓									
	EXT 18	✓	✓	✓								✓								
	EXT 19	✓	✓	✓									✓							
	EXT 20	✓	✓	✓										✓						
	EXT 21	✓	✓	✓											✓					
	EXT 22	✓	✓	✓												✓				
	EXT 23	✓	✓	✓													✓			
	EXT 24	✓	✓	✓														✓		
	EXT 25	✓	✓	✓															✓	
	EXT 26	✓	✓	✓																✓

# CENTREX OPERATION

## Setup Checklist

Before expanding your system or installing for Centrex, review the installation checklist. If you have Centrex, contact your local telephone company for further information about Centrex service.

- The phone number for Line 1 must be the same on all phones in order for the Intercom and Page features to work.
- Determine the number of phones that will be on the system.
- Identify the phone that will be the Console phone.
- Identify the private line for the Console phone. The Console phone must have its own private line. This line is not shared with any other phone.
- Follow the regular installation instructions in this manual.
- Enable the Console phone.
- Store the Centrex pickup codes and the seven-digit phone numbers in One Touch locations. (See ONE TOUCH OPERATION beginning on page 70.)

## Enable the Console Phone

Determine which phone will be the Console phone for your system and program the Console following the directions to “Set This Phone to be the Centrex Console Phone” on page 55. It is recommended that Line 4 of the Console be programmed as a private line, to be sure a line is available for Centrex access.

## Console Operation

Once another system phone has enabled its delayed ring, the Console phone will receive those calls. All the 984 features work in the same manner as described in this manual.

The Console phone can pick up other Centrex lines through Centrex switching. You can store the Centrex pickup codes and the seven-digit phone number of each station, except for the Console phone, in the One Touch locations.

## Set Ring Delay Duration

This feature allows other system telephones' calls to ring at the Console phone. After a specified ring delay, the calls will ring at the Console phone. (See "Set the Centrex Console Delayed Ring Time" on page 56.)

## Answer a Delayed Ring

The Console phone rings and the screen displays the extension number of the intercom sending the delayed ring.

- 1 Select a free line.
- 2 Enter the Centrex pickup code.
- 3 Enter the seven-digit phone number of the extension sending the delayed ring.

 **NOTE:** If the Console is using another line and receives a delayed ring, the Console phone can put the other line on hold and follow **Steps 1–3**. If the Console is on an intercom call, the intercom call should be ended before picking up the ringing phone.

## Pick Up Another Station's Line

- 1 Choose a free Centrex line.
- 2 Enter the Centrex pickup code.
- 3 Enter the seven-digit phone number of the line you want.



- ▲ [945] 6, 22, 24, 62, 75, 92, 102
- ▼ [945] 6, 22, 24, 62, 75, 92, 102
- ◀ [945] 6, 22, 24, 75, 92, 102
- ▶ [945] 6, 22, 24, 75, 92, 102
- ☰ [945] 22
- ☷ [945] 22
- 1 minute 51

## A

- AA AUX-OGM 103, 110
- AA Day-OGM 103, 110
- AA Night-OGM 103, 110
- AM/PM 32
- announcements 51, 101
- ANS-OGM 103
- answer a call 57–58, 87
- Answer Delay 10, 45, 49, 126
- Answer Status 10, 43, 110
- answering function 43, 51, 69, 101, 117, 126
- answering system 6, 10, 43–45, 47, 49, 101, 103–108, 112–114, 116
- Answering System Does Not Answer After Correct Number of Rings 126
- Answering System Does Not Respond to Remote Commands 127
- Answering System Will Not Record Messages 126
- AREA CODES 9, 40
- Audible Message Alert 11, 52, 109
- AUTO ATT DELAY 10, 45

## 132

- Auto Redial 62, 68
  - (AUTO REDIAL) 62, 71, 77
  - Auto-Attendant 5, 10, 43, 46–47, 110, 111, 115
  - Auto-Attendant Auxiliary Outgoing Announcement 110, 111
  - Auto-Attendant Day Outgoing Announcement 110
  - Auto-Attendant Night Outgoing Announcement 110
  - Auto-Attendant Outgoing Announcement 110, 112, 113, 114
  - Auto-Attendant Pickup Delay 46, 111, 115
  - Auto-Mute 8, 30, 88, 90
  - automatic line selection 57, 59
  - Automatic Mode 9, 35, 62, 74, 87
  - Aux L3 jack 21
  - Aux L4 jack 21
- ## B
- Base 13–14
  - battery 13–14, 16, 20, 67, 124
  - battery compartment 13–14
  - Blind Transfer 66
- ## C
- call history 69, 91, 95–99, 100
  - call information 91
  - call privacy 60
  - call record 97, 99, 100
  - call volume 61
  - Call Waiting 64, 93

Caller ID 5, 9, 75, 91, 95  
 Caller ID information 92, 93  
 Caller ID with Call Waiting 5, 91, 93  
 Caller Identification 5, 91  
 caller information 96  
 CANCEL 71  
 Cannot Join a Conversation in Progress 122  
 Central Office Voice Mail 5  
 Centrex 5, 55–56, 128, 130  
 Centrex Console  
     Delayed Ring 56  
 Centrex Console Phone 11, 55  
 Centrex pickup code 130, 131  
**CONFERENCE** 65  
 conference call 65, 123  
 CONSOLE 11  
 Console phone 130, 131. See also  
     Centrex Console Phone  
 Convenience Ports 21  
 COVM 5  
 COVM RESET 39  
 COVM indicator 9, 38–39  
 COVM ON/OFF 9  
 CSL DELAY RING 11  
**D**  
 D-TAD 6, 101–109, 112–114, 126  
 D-TAD Intercept 11, 54, 105, 127  
 D-TAD memory 101, 107, 126  
 D-TAD outgoing  
     announcement 116  
     date 32  
     day of the month 32  
     day of the week 32  
     Day Time 47, 110  
 DAY/NIGHT TIMES 10, 47  
 default mode 58, 59  
 default settings 42  
 DELAY RING 8, 29  
 delayed ring 29, 130, 131  
 DIAL ALTERNATE 98  
 dial mode 31  
 dial options 98  
 dial pad keys 76–77, 79, 80  
 dial pulse (rotary) 64, 72, 78  
 dial tone 16, 18, 58  
 dialing sequence 72, 77–78  
 Difficulty Intercepting a Call  
     During Message Recording 127  
 Digital Subscriber Line 4  
 directory 75–82, 99  
 directory card 70  
 DIRECTORY FULL! 75  
 directory of extension  
     assignments 111, 127  
 Display Screen is Blank 124  
 DND 6, 12, 60, 68  
 DND light 60  
 Do Not Disturb 6, 68, 122  
 Do Not Disturb (DND) 83, 121  
 Double Beep Sounds  
     Every 30 Seconds 122  
 DSL 4, 124

DSL filters 4  
 DSL service 4–5, 83  
 DSL service provider 4–5  
 DSL splitter 4, 5  
 DTAD FULL! 107  
 DTAD light 69, 101

## E

English 24, 56  
**ENTER** 6, 22, 62, 67, 75, 88–90  
 erase all settings 42  
 error ring 13  
 Error Tone (Fast Busy Signal)  
   Heard When Making  
   a Intercom Call 122  
 Español 24, 56  
 EXT button 25, 66–67, 70, 71, 73,  
 74, 85–86, 88, 90, 100  
 extension 3, 6, 13, 33, 60, 66, 67,  
 68, 83, 85–90, 118, 122, 128–129  
 extension no 8  
 extension number 3, 8, 12–13, 66,  
 83, 87, 118, 122, 131

## F

fax 123  
 fax machine 21, 118, 126  
 fax switch 118  
 feature setup menu 22–23  
 flash 64, 72, 78  
**FLASH** 64  
 Français 24, 56

## G

Greeting Only 51

## H

hands-free 30, 58, 87  
 handset 2, 16, 17, 35, 57, 59,  
 61–64, 67, 83, 85–87, 124  
 handset cord 2, 16, 17  
 handset tab 17  
 headset 9, 35, 57–59, 61, 62, 64,  
 67, 68, 74, 87, 88, 98, 124  
**HEADSET** 7, 9, 58, 62, 74, 87–89  
 headset jack 1, 58  
 HEADSET light 58, 68  
 hearing-aid 1  
 hold 59, 63–65, 68, 90, 122, 124  
**HOLD** 63, 65, 67  
 hold reminder 31, 63  
 Home Area Code 6, 9, 91  
 hour 32

## I

idle screen 106  
 incoming call 33, 46, 49, 58, 60,  
 110, 115, 127  
 Incoming Calls Are Dropped By  
   Auto-Attendant 127  
 incoming intercom call 12, 68  
 incoming messages 11, 53, 105,  
 108, 109  
 Initializing.. 16, 20  
 Intercom 12, 25–26, 33, 83, 84,  
 85–87, 90, 122, 124, 130. See also  
   Centrex Console Phone  
**INTERCOM** 63, 67, 85–90  
 intercom call 28, 63, 65, 68, 70,  
 85–87

intercom conference call 90  
INTERCOM light 60, 68, 121  
Intercom Paging Signal  
Not Received 122

**L**

L1/L2 jack 15  
L3/L4 jack 15  
Language 11, 24, 56  
LCD Backlight 9, 37  
Lights 68  
Line 1 phone number 3  
LINE button 35, 57–60, 62–63,  
65, 67, 122  
line cords 2, 15  
Line Group 6, 41, 123, 128  
LINE light 60, 63, 68, 118, 128  
Line Lights Remain On 123  
Line Preference 34. See also  
Prime Line  
Line Privacy 124. See also  
private line  
line usage 33, 123  
Local Area Code 6, 9, 91  
LOW BATT 67  
**LOWER** 70, 71, 73, 74

**M**

make a call 57–58  
memo 51, 101, 108, 117  
Menu item 22  
menu operation 22, 23, 75, 92,  
102  
MESS. ALERT 11, 52

MESS. LENGTH 11, 51  
Message Length 51, 126  
message playback 107  
Message Waiting light 95  
messages 11, 49, 51, 54, 69, 101,  
105–108, 117, 126  
Messages Are Incomplete 126  
microfilters 4  
minute 32  
Monitor 11, 53, 105  
month 32  
multi-phone system 6, 10, 43–44,  
47, 110  
Mute 64, 68  
**MUTE** 64, 88  
MUTE light 64, 68, 88

**N**

Navigation buttons 6, 22, 75, 92,  
102  
NEW CALL light 69, 95  
Night Time 47, 110  
non-system phone 60, 105, 121,  
127

**O**

One Touch 13, 25, 70–74, 100,  
124  
One Touch (EXT) buttons 8  
One Touch locations 70, 71, 100,  
130  
One Touch number 74  
One Touch Preference 8, 25, 70,  
74, 85–86

outgoing announcement 5, 47, 51,  
103–105, 110–111, 113, 117

outgoing calls 118

outgoing or transfer calls 33

outside line 65

## P

Page 3, 84, 88–89, 116, 122, 130

page all 84

page call 90

paging only 33

password 11, 50

pause 72, 77

phone system 3–4, 6, 11, 44, 60,  
83, 87, 89, 123, 128

power adapter 2, 16

power cord 16, 124

power failure 13, 16, 20, 124

POWER jack 16, 18

pre-recorded announcement 103,  
105, 110, 113–114

primary Auto-Attendant 115

Prime Line 7, 9, 34, 57

privacy 30, 122

private line 128

Private Name 94

Private Number 94

PRV 41

Pulse 31

## R

Rapid Scroll 9, 24, 36

Redial 13, 61, 62, 124

redial memory 61, 62

reminder beep 122

Remote Code 11, 50, 116

remote commands 116, 117

Remove all? 82, 97

Removed! 97

Repeating Short Ring (Error Ring)  
Sounds at All Extensions 122

RESET ALL 10

Reset! 39

return to the conversation 64

ring delay 131

ring pattern 8, 28

ringer 27, 118, 121

RINGER ON /OFF 8

RINGER TYPE 8

Ringer Volume 61

Room Monitor 30, 90

## S

save messages 107

Screen Backlight 37

screen display 22

Screen Displays Powerfail  
124

scroll button 24

Scroll Rate 9, 36

SINGLE PHONE 10, 44

single phone system 10, 43

single-phone page 83, 88

speaker 11, 90, 105

**SPEAKER** 7, 9, 58–59, 62, 74, 87, 89

SPEAKER light 58

speakerphone 9, 35, 57,–59,  
62–64, 67–68, 74, 83, 86–88,  
90, 98

splitter 4

Stored! 71

switch lines 63

Switchhook 17, 64

system phone 60, 66, 90, 105

system-wide page 83, 89

**T**

Telephone Does Not Ring 121

telephone lines 3

telephone system 13, 26, 83

telephone wiring 3, 123

Temporary Tone 64, 72

temporary tone signal 78

three-party Call 65

Three-Way Calling 64

Time 32

timer 59

Toll Saver 11, 49

**X-TONE** 64

Tone Signals Do Not  
Activate a Remote Device 123

Tone 31

touch tone 64, 72, 116

transfer 66–68

**TRANSFER** 66–67

transfer ring 67

two-line adapter 15

## U

Unknown Name 94

Unknown Number 94

Unlimited 51, 126

unused lines 33

## V

Voice Mail 38, 95

Voice Mail service 29, 38, 95

VOLUME ▲ 61

VOLUME ▼ 61

## Z

Z800A filter 3, 4, 5, 123