



Two-Line Speakerphone 982



For Customer Service Or Product
Information, Visit Our Website At
www.telephones.att.com

Please also read
**Part 1 — Important
Product Information**

CONTENTS

PRODUCT OVERVIEW	1
BEFORE YOU BEGIN	2
Parts List	2
Tools Needed	2
INSTALLATION	3
Before You Install	3
Battery Installation	3
Table/Desk Installation	5
Wall Installation	8
Switchable Data Port	10
Headset Jack	10
TELEPHONE OPERATION	11
Make a Call	11
Answer a Call	11
End a Call	11
Switch Between Handset, Headset, and Speakerphone	12
RINGER Volume	12
Handset/Speakerphone/ Headset Volume	12
Redial	13
Automatic Redial	13
Hold	14
Switch Between Lines During a Call	14
Mute	15
Flash	15
Temporary Tone	15
Conference Calls	16
Lights and What They Mean	17
TELEPHONE MEMORY	18
One-Touch Dialing	18
Two-Touch Dialing	18
Directory Card	18
Store a Memory Number	19
Dial a Memory Number	19
Erase a Memory Number	19
GENERAL PRODUCT CARE	20
TECHNICAL SPECIFICATIONS	21
IN CASE OF DIFFICULTY	22
INDEX	25

PRODUCT OVERVIEW

This AT&T Two-Line Speakerphone 982 can be used with one or two incoming telephone lines and features a speakerphone for hands-free use. It is hearing-aid compatible and can also be used hands-free with a two-band 2.5mm headset (purchased separately). This phone can be used on a table or desk or mounted on a wall and does not require AC power for operation. (Four AA batteries are required to power the LINE lights and the Auto Redial feature, and for the headset to work correctly in all conditions.) The 982 has 24 memory locations for faster dialing of commonly called numbers.

This User's Manual contains detailed instructions for installing and operating your AT&T Two-Line Speakerphone 982. Please be sure to follow the directions carefully.

BEFORE YOU BEGIN

Parts List

Your box should include:

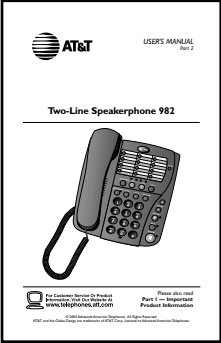

This User's Manual



Quick Start Guide



Telephone base with wedge attached

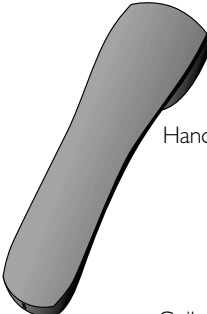

Handset

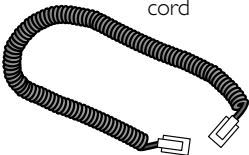

Coiled handset cord

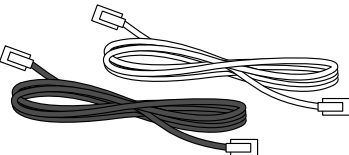

Seven-foot black line cord (4-connector)

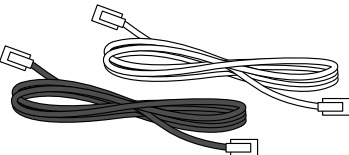

Seven-foot clear line cord (2connector)

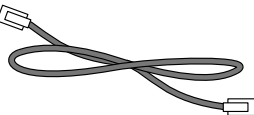

Eight-inch line cord

Tools Needed

You will also need the following to install your phone:

- Four AA batteries

INSTALLATION

Before You Install

To use this product as a two-line phone, you must have a two-line modular wall jack or two separate one-line modular wall jacks. To use both lines of a two-line telephone, your local telephone company must provide two telephone numbers.

Battery Installation

Before using the telephone, you should install four AA batteries (purchased separately). You can use the phone without the batteries to dial and receive calls using the handset, but four AA batteries are required to power the LINE lights and the Automatic Redial feature, and for the headset to work correctly in all conditions.

NOTE: If you do not install batteries, you will hear a low battery warning tone every time you lift the handset or press **[SPEAKER]**. The headset feature will not work at all without batteries.



CAUTION: Always unplug the line cord(s), before installing new batteries.

- 1 Turn the telephone upside down.
- 2 If the base wedge is attached, remove the wedge by pressing the tabs as shown and then pulling the wedge away from the base.

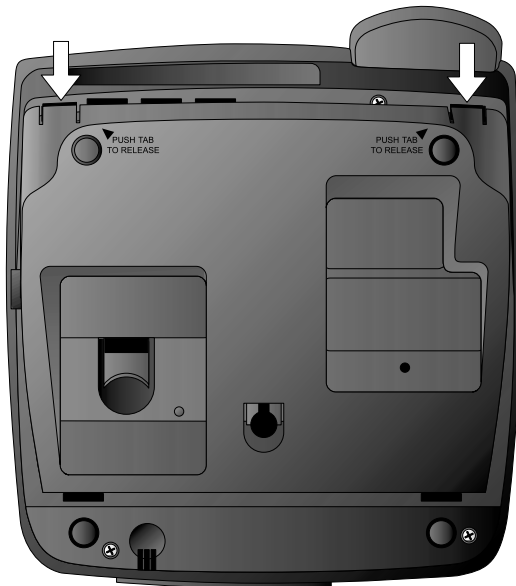

- 3 Press the tab as shown and pull to remove the battery cover. Insert four new AA batteries (purchased separately) following the polarity markings in the battery compartment.

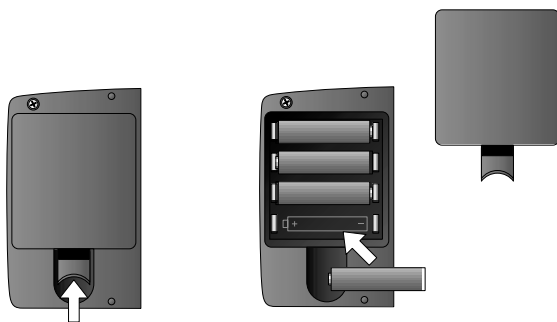

- 4 Replace the battery cover.

Table/Desk Installation

1 Attach the wedge.

Insert the bottom tabs into the slots as shown. Push gently on the tabs at the large end of the base while locking them into place against the base.

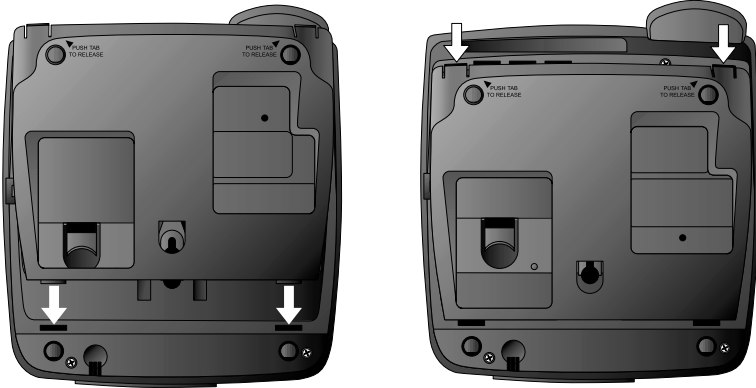

2 Connect the line cord(s) to the telephone and your modular jack(s).

- **If you have a single two-line wall jack**, use only the black (4-connector) line cord. Plug one end into the jack labeled **L1** **OR L1/L2** on the back of the telephone. Plug the other end into the wall jack. Make sure the cord snaps firmly into place at both ends.

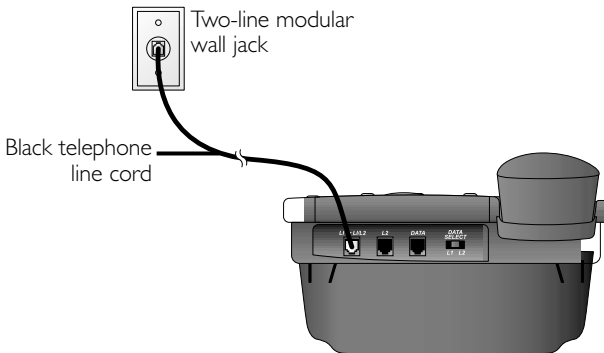

continued on page 6

Table/Desk Installation

continued from page 5

- **If you have two one-line wall jacks**, use both long line cords. Insert one end of the first cord into the jack labeled **L1 OR L1/L2** on the back of the phone. Then, plug the other end into the wall jack for Line 1. Insert one end of the other cord into the jack on the back of the phone labeled **L2**. Then, plug the other end into the wall jack for Line 2. Make sure the cords snap firmly into place at both ends.

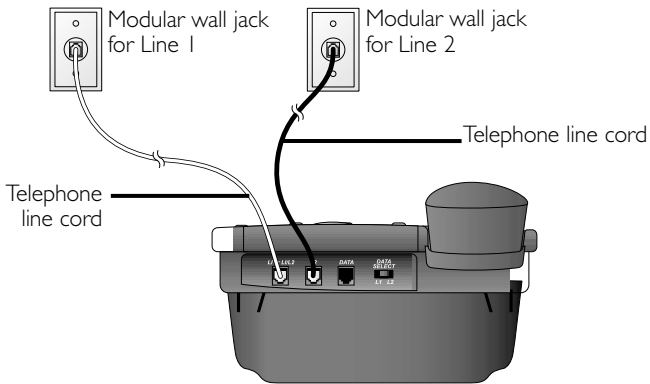

3 Connect the handset to the telephone.

Plug one end of the coiled handset cord into the handset, then plug the other end into the jack on the left side of the telephone base.

4 Set Dial Mode.

This product comes set for touch tone dialing. Make sure you choose the correct dialing method (TONE or PULSE); dial pulse dialing will not work if you have touch tone service.

To set your telephone for dial pulse (rotary) service, lift the handset and press a LINE button, then press **PROGRAM**, **#**, **#**, **#**, **3**. To change back to touch tone service, press **PROGRAM**, **#**, **#**, **#**, **8**.

To switch from pulse to tone dialing during a phone call, see “Temporary Tone” on page 15.

5 Check for dial tone.

Press **LINE 1**, lift the handset, press **SPEAKER** or press **HEADSET** (with a headset connected and batteries installed), and listen for a dial tone. Then press **LINE 2**, lift the handset, press **SPEAKER** or press **HEADSET** (with a headset connected and batteries installed), and listen for a dial tone. If you cannot hear a dial tone, turn to **IN CASE OF DIFFICULTY** beginning on page 22.

NOTE: If you press **HEADSET** when there is no headset connected to the phone but charged batteries are properly installed, you will hear a warning tone. If you did not install batteries, the headset feature will not work at all.

6 Confirm Lines 1 and 2.

To determine which line is which, press **LINE 1** and call one of your telephone numbers. If you hear a busy signal, Line 1 is the number you called. If Line 2 rings, it is the number you called.

Wall Installation

1 Remove the base wedge.

If the base wedge is attached, remove it following the directions in “Battery Installation” beginning on page 3.

2 Reverse handset tab.

To mount the telephone on a wall, you must reverse the handset tab. This tab holds the handset when you hang up.

Hold down the switchhook, and slide the tab up and out of its slot. Turn the tab so that the end with the lip is up. Insert the tab back into its slot.

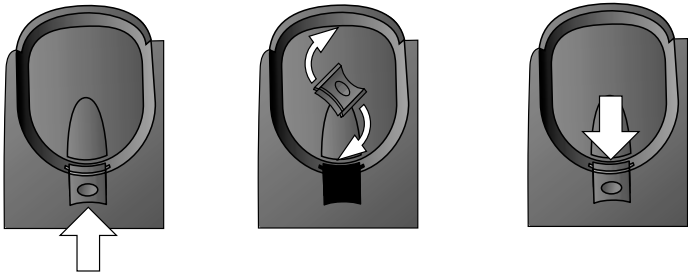

3 Connect the line cord(s) to the telephone and your modular wall jack(s).

- **If you have a single two-line wall jack**, use only the short line cord. Plug one end into the jack labeled **LI OR LI/L2** on the back of the telephone. Place the cord in the channel under the phone as shown. Plug the other end into the wall jack. Make sure the cord snaps firmly into place. Then, place the phone on the wall jack mounting studs and pull down until it is held securely.

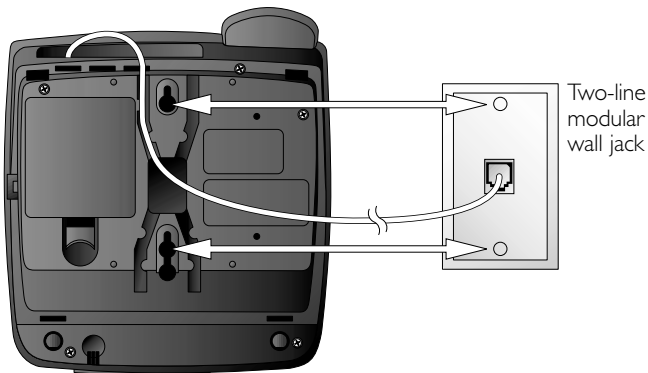

- If you have two separate one-line wall jacks**, use two line cords (the short cord and one of the long cords). Plug one end of the short cord into the jack labeled **L1 OR L1/L2** on the back of the telephone. Plug one end of a long cord into the jack labeled **L2** on the back of the phone. Place the cords in the channels under the phone as shown. Plug the free end of the the line cord for Line 1 into the Line 1 wall jack. Plug the free end of the line cord for Line 2 into the Line 2 wall jack. Make sure the cords snap firmly into place at both ends. Then, place the phone on the Line 1 wall jack mounting studs and pull until it is held securely.

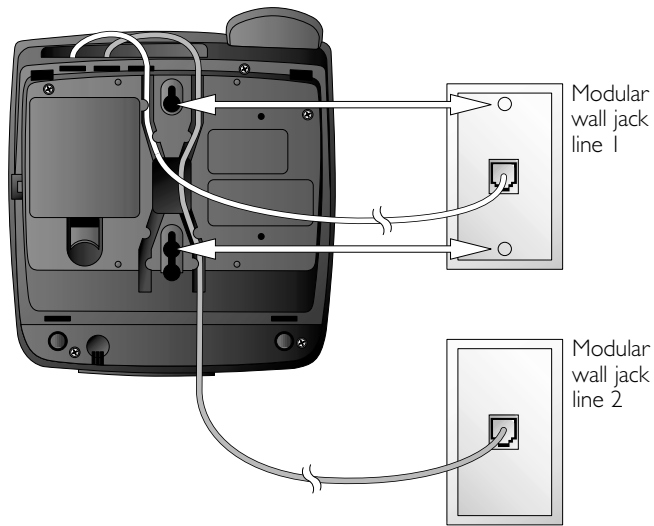

- Follow **Steps 3** through **6** of “Table Installation” beginning on page 5.

Switchable Data Port

If you want to connect another device (such as a modem or fax machine) to the wall jack, you can use the jack on the phone labeled **DATA**. You can set the data port to use Line 1 or 2. Set the **DATA SELECT** switch located on the back of the phone to **L1** or **L2**. A call picked up at another extension on the line used by the data port may interrupt a fax, modem or message transmission.

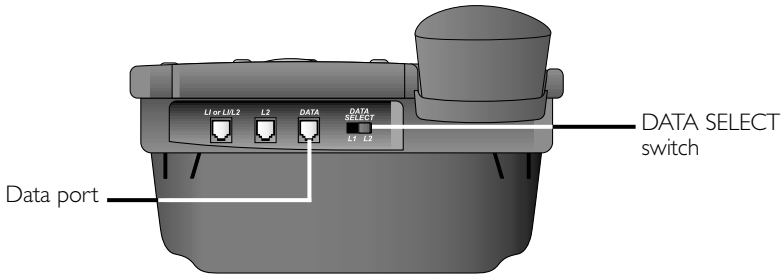

Headset Jack

NOTE: Four charged AA batteries **MUST** be installed for the headset to work correctly in all conditions.

You can use this phone hands-free when you install any industry standard two-band 2.5mm headset (purchased separately). For best results use an AT&T two-band 2.5mm headset.

Make sure the headset is plugged into the headset jack on the right side of the phone. You will hear an error tone if you press **HEADSET** when the headset is not plugged in.



TELEPHONE OPERATION

Make a Call

Press a **LINE** button and lift the handset

— **OR** —

Press **[SPEAKER]**

— **OR** —

Press **[HEADSET]**, then dial the call.

NOTE: If you did not install batteries, you will hear a low battery warning tone when you lift the handset or press **[SPEAKER]**.

Answer a Call

Press a **LINE** button and lift the handset

— **OR** —

Press **[SPEAKER]**

— **OR** —

Press **[HEADSET]**.

End a Call

Replace the handset

— **OR** —

Press the other **LINE** button

— **OR** —

Press **[SPEAKER]** (if on speakerphone call)

— **OR** —

Press **[HEADSET]** (if on headset call).

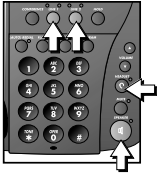
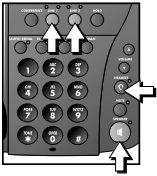
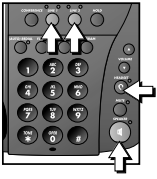



Switch Between Handset, Headset, and Speakerphone

To switch from handset to headset or speakerphone, press **HEADSET** or **SPEAKER**.

To switch from headset or speakerphone to handset, lift the handset. The headset or speakerphone are automatically turned off.

To switch between speakerphone and headset, press the button (**HEADSET** or **SPEAKER**) for the mode you wish to use.

NOTE: In order to use the headset you must have properly installed batteries and an industry standard 2.5 mm headset must be plugged into the phone. See "Headset Jack" on page 10 for instructions.

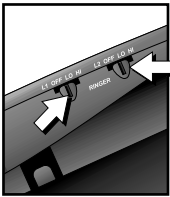

RINGER Volume

There is a RINGER switch for each line on the right side of the telephone base.

Set each switch to OFF, LO or HI. You can dial and answer calls normally with one or both switches set to OFF.

NOTE: Each line has its own distinctive ring.

Handset/Speakerphone/Headset Volume

While on a call press **VOLUME ▲** to increase, or **VOLUME ▼** to decrease volume.

You will hear a triple-beep when you reach the maximum or minimum volume setting.



Redial

Press **LINE 1** or **LINE 2**, then lift the handset

— OR —

Press **SPEAKER**

— OR —

Press **HEADSET**, then press **(AUTO) REDIAL** to call the the last number (up to 24 digits) dialed on the line.

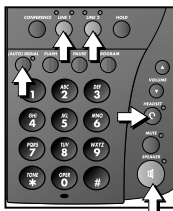

Erase Redial Memory

Press a **LINE** button, **SPEAKER** or **HEADSET**, then press **PROGRAM**, **(AUTO) REDIAL**, **PROGRAM**.



Automatic Redial

This phone can automatically and repeatedly redial the last number you called. While the phone is on hook press **LINE 1** or **LINE 2**, then press **(AUTO) REDIAL**. You will hear the numbers being dialed. When the call is answered, you must either lift the handset or press **SPEAKER** or **HEADSET** to speak with the other party.

If the number you called is busy, the phone will redial every 40 seconds up to 10 times (timing begins when the phone is on hook).

To stop automatic redialing before the call is connected, press **(AUTO) REDIAL** again. Lifting the handset or pressing **SPEAKER** or **HEADSET** will also cancel Automatic Redial.

To stop automatic redialing after the call is connected, press **(AUTO) REDIAL**, then press **SPEAKER** or **HEADSET** twice, or lift the handset and hang up.

NOTE: This feature will not work if **CONFERENCE** or **HOLD** is pressed. This feature works only when the handset is in the cradle and charged batteries are installed.



Hold

Press **HOLD** to put a line on hold. You can hang up the handset.

To return to the call, press the appropriate **LINE** button and lift the handset

— OR —

Press **HEADSET**

— OR —

Press **SPEAKER**

— OR —

Lift the handset of an extension phone on the same line.

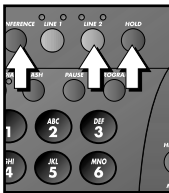

Switch Between Lines During a Call

During a call on one line, you can make or answer a call on the other line by pressing **HOLD**. You can use the **HOLD** and **LINE** buttons to switch back and forth between calls as often as necessary.

Example: While using Line 1, Line 2 rings:

- 1 Press **HOLD** to hold Line 1.
- 2 Press **LINE 2** to answer the other call.
- 3 To hang up Line 2 and return to your first call, press **LINE 1**, then lift the handset, or press **SPEAKER** or **HEADSET**.

— OR —

Press **HOLD** to hold Line 2, and press **LINE 1** and lift the handset, or press **SPEAKER** or **HEADSET** to return to your first call.



Mute

Mute allows you to hear the other party, but the other party can't hear you.

To turn Mute on, press **MUTE**. The MUTE light goes on.

To return to the conversation, press and release **MUTE** again.



Flash

Press **FLASH** instead of pressing the switchhook to activate services such as Call Waiting or 3-Way Calling. You may have to press other buttons before or after **FLASH** as explained in the custom-calling instructions provided by your local telephone company.



Temporary Tone

If you have dial pulse (rotary) service you can change from pulse to tone dialing during a call by pressing **TONE**.

- 1 Dial the telephone number.
- 2 Press **TONE**. All buttons pressed after this send tone signals.
- 3 After you hang up, the phone returns to pulse dialing.

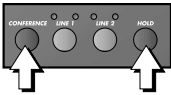

Conference Calls

You can use both lines at the same time to set up a three-way conference call.

- 1 Make or answer a call and press **HOLD**.
- 2 Establish a call on the other line.
- 3 Press **CONFERENCE**.

To end a conference call, hang up

If one caller hangs up during a conference call, you might hear a dial tone. Press the **LINE** button of the remaining call to disconnect the other line and eliminate the dial tone.

NOTE: Under certain circumstances, the far-end parties on a conference call may not hear one another clearly.

Place a conference call on Hold

- 1 Press **HOLD** to hold both lines.
- 2 Press **CONFERENCE** to release Hold, then lift the handset or press **SPEAKER** or **HEADSET** and continue your conference call.

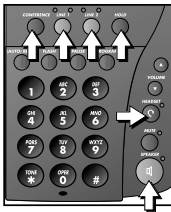

Talk privately with one caller during a conference call

- 1 Press **HOLD**. Both lines are put on Hold.
- 2 Press the **LINE** button of the person with whom you want to speak privately then lift the handset or press **SPEAKER** or **HEADSET**.
- 3 Press **CONFERENCE** to release Hold and continue your conference call.

Drop one party from a conference call

To disconnect one party from a conference call and keep the other on the line, press the **LINE** button of the call you want to continue.

NOTE: If you leave the **CONFERENCE** button down after a conference call, then dial another number, your call might be completed, but you might hear a busy signal from the other line. Press **HOLD**, then press each **LINE** button until you identify the line being used for your completed call.

Lights and What They Mean

LIGHT:	STATUS:	MEANS:
LINE (RED)	On steadily	This line is in use. —OR— This line is not connected to the wall jack.
	Flashing	This line is on hold.
LINE (GREEN)	Flashing	This line is ringing.
SPEAKER	On	The speakerphone is in use.
	Flashing	The phone is attempting an Auto Redial call.
HEADSET	On	The headset is in use.
(AUTO)REDIAL	On	The AutoRedial feature has been activated.
MUTE	On	This Mute feature has been activated

TELEPHONE MEMORY

This telephone has 24 memory locations where you can store phone numbers you wish to dial with only one or two key presses. Each location can store up to 24 digits.

One-Touch Dialing

The 12 white spaces on the directory card are one-touch memory locations. You can dial one of these numbers by starting to make a call as usual and pressing the memory button next to the number instead of using the dial pad keys.

Two-Touch Dialing

The 12 gray spaces on the directory card are two-touch memory locations. To dial one of these numbers you must press **LOWER**, then the memory button next to the number when you would usually press the dial pad keys.

Directory Card

Remove the plastic cover and the directory card. Write your telephone numbers in the spaces provided, and write the telephone numbers (or names) that you want to store in each memory location. Replace the card and plastic cover in the space provided.

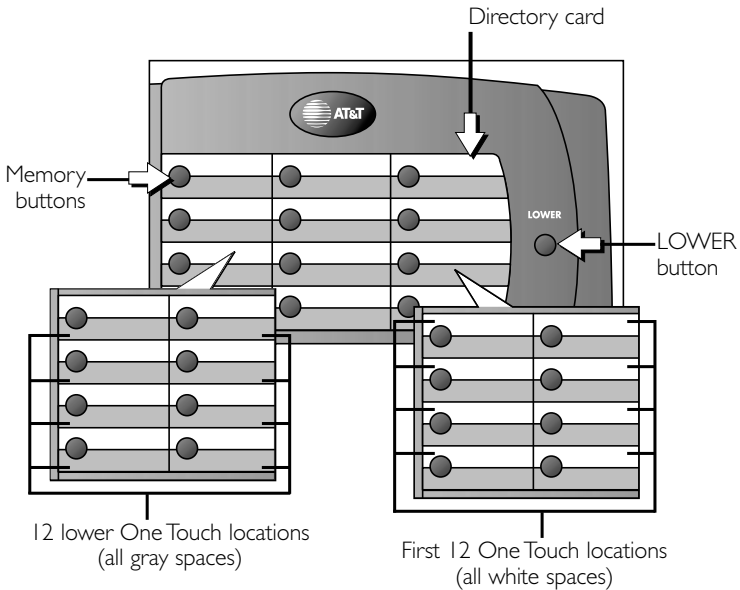

Store a Memory Number

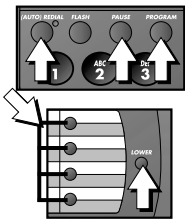

- 1 Press **SPEAKER**, press **HEADSET** or lift the handset.
- 2 Press and release **PROGRAM**. You will hear a beep.
- 3 Enter the telephone number you want to store (up to 24 digits) or press **AUTO REDIAL** to store the last number dialed. You will hear a beep each time you press a button. Press **PAUSE** to store a three-second dialing delay.
- 4 Press and release a memory button
— **OR** —
Press and release **LOWER**, then a memory button. You will hear a two-beep confirmation tone.
- 5 Hang up.
Repeat Steps 1-5 to store another number.

If you hear a series of five beeps, an error was made. Repeat **Steps 1-5** in order to repeat the number you wish to store.

NOTE: You cannot store a pause as the first digit of a memory number.

Dial a Memory Number

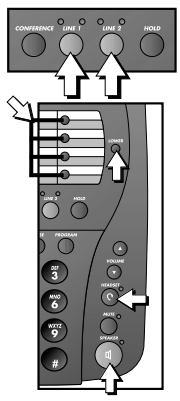

- 1 Press **LINE 1** or **LINE 2**.
- 2 Lift the handset
— **OR** —
Press **SPEAKER**
— **OR** —
Press **HEADSET** and listen for dial tone.
- 3 Press and release a memory button
— **OR** —
Press and release **LOWER** then a memory button.

Erase a Memory Number

To remove a number from memory, enter another number in the same location. To clear a memory location and leave it empty,

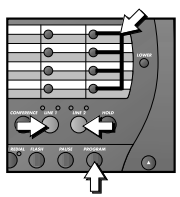

- 1 Press **LINE 1** or **LINE 2**, then lift the handset.
- 2 Press **PROGRAM**.
- 3 Press the button of the memory location you want to clear.

GENERAL PRODUCT CARE

To keep your phone working and looking good, follow these guidelines:

- Avoid putting it near heating appliances and devices that generate electrical noise (for example, motors or fluorescent lamps).
- DO NOT expose it to direct sunlight or moisture.
- Avoid dropping the phone and/or other rough treatment.
- Clean with a soft cloth.
- Never use a strong cleaning agent or abrasive powder because this will damage the finish.
- Retain the original packaging in case you need to ship it at a later date.

TECHNICAL SPECIFICATIONS

TECHNICAL SPECIFICATIONS

REN	1.0B
Battery Power	4 AA
Product Weight	2.06 pounds
Product Dimensions (unpacked)	8.15 inches long x 7.68 inches wide x 5 inches high

IN CASE OF DIFFICULTY

If you have difficulty operating this phone, try the suggestions below.

For Customer Service, visit our website at **www.telephones.att.com** or call **1 800 222-3111**. **Have the serial number, found on the underside of your phone available when contacting Customer Service. Please retain your receipt as your proof of purchase.**

To purchase accessories or replacement parts contact Customer Service. Visit our website at **www.telephones.att.com** or call **1 800 222-3111**.

TELEPHONE OPERATION

PROBLEM

No Dial Tone

SOLUTION

- Make sure all plugs are connected properly. Inspect the line cord connections at the modular jack(s) and at the telephone. Also inspect the coiled handset cord connection at both ends.
- Make sure a line is selected (Line 1 or Line 2).
- Make sure Hold is not activated.
- If you do not hear a dial tone when you press **HEADSET**, make sure the headset is firmly connected at the jack.

PROBLEM

Call Cannot Be Dialed Or Is Dialed Slowly

SOLUTION

- This product comes set for touch tone dialing. Make sure you choose the correct dialing mode, touch tone dialing will not work if you have dial pulse (rotary) service. (See "Set Dial Mode" **Step 4** of TABLE/DESK INSTALLATION on page 6.)
- If you just used Temporary Tone, leave the handset on the base for a few seconds before making another call.

TELEPHONE OPERATION

PROBLEM

Automatic Redial Interrupted

SOLUTION

- If the phone rings during the Automatic Redial sequence, you will cancel it if you lift the handset, press **SPEAKER** or press **HEADSET** to take the call.
- Lifting the handset, pressing **SPEAKER** or pressing **HEADSET** will cancel Automatic Redial.
- Low battery power can affect Automatic Redial. For information about changing batteries, see “Battery Installation” on page 3.

PROBLEM

Speakerphone Doesn't Work While an Extension Phone is In Use

SOLUTION

The 982 speakerphone is powered by the current in the telephone line cord connected to your wall jack. The 982 speakerphone might not work if you are on a call on a line-powered extension phone and try to use the 982 speakerphone at the same time. There may not be enough power in the line current to support both the speakerphone and the extension phone. Try using the 982 handset for calls like this.

PROBLEM

Telephone Does Not Work with Headset

SOLUTION

- Make sure four AA batteries are properly installed. (see “Battery Installation” beginning on page 3.)
- Use only an industry standard two-band 2.5 mm headset (purchased separately). For best results use an AT&T two-band 2.5 mm headset.

PROBLEM

Warning Tone Sounds When You Lift the Handset or Press **SPEAKER**

SOLUTION

Install four charged AA batteries. (See “Battery Installation” beginning on page 3.)

TELEPHONE MEMORY

PROBLEM

Difficulty Storing Numbers in Memory

SOLUTION

- Review “Store a Memory Number” on page 19 to make sure you are pressing the correct sequence of buttons.
 - If you are interrupted by a recorded announcement telling you to hang up (or a loud buzzing noise), hang up and try to enter the number more quickly.
 - Try calling the number you want to enter into memory. When the call is ended, press **PROGRAM**, **(AUTO) REDIAL** and a memory button.
 - If someone lifts an extension phone while you are storing numbers in memory, programming might be interrupted. Make sure all extensions are on hook while storing numbers in memory.
 - You might not hear the confirmation beep if the handset volume is set too low, or if you are in a noisy location.
 - Do not put the phone on hold while storing numbers.
-

3-Way Calling 15

A

(AUTO REDIAL) 13, 19, 24

Automatic Redial 3, 13, 23

B

batteries 2–4, 7, 10–13, 23

battery cover 4

C

Call Waiting 15

(CONFERENCE) 16

conference call 16

D

data port 10

DATA SELECT switch 10

dial mode 6, 22

dial pulse 6, 15, 22

dial tone 7, 16, 19, 22

directory card 18

F

fax machine 10

(FLASH) 15

H

hands-free 10

handset 2–3, 6, 7, 11–14, 19

handset cord 2, 6

handset tab 8

headset 3, 7, 10, 12, 23

(HEADSET) 11, 13, 14, 16

hold 14, 22

(HOLD) 14, 16

L

LINE button 6, 11, 13–14, 16

line cord 2, 5–6, 8–9, 23

LINE lights 3

low battery warning tone 3, 11

(LOWER) 18, 19

M

memory 18, 24

memory button 18–19, 24

memory location 18–19

modem 10

modular jack 5

modular wall jack 3, 8

mute 15

(MUTE) 15

MUTE light 15

O

one-touch memory 18

P

(PROGRAM) 13, 19, 24

R

Redial 13

RINGER switch 12

S

(SPEAKER) 3, 11, 13, 14, 16

speakerphone 12, 23

switchhook 15

T

temporary tone 22

touch tone 6, 22

two-touch memory 18

V

volume 12

W

warning tone 23

wedge 2–3, 5



In case of difficulty, visit our Service Center at
www.telephones.att.com or call **1 800 222-3111**.

© 2004 Advanced American Telephones.

All Rights Reserved.

AT&T and the Globe Design are
trademarks of AT&T Corp., licensed to
Advanced American Telephones.

Printed in China. Issue 1AT&T 06/04



QUICK START GUIDE

Two-Line Speakerphone 982

This Quick Start Guide provides basic instructions. For additional installation options and complete instructions which allow you to use all features of this phone, refer to your Two-Line Speakerphone 982 User's Manual, Part 2.

INSTALLATION

Battery Installation

Before using the telephone, you should install four AA batteries (purchased separately). You can use the phone without the batteries to dial and receive calls using the handset, but four AA batteries are required to power the LINE lights and the Automatic Redial feature, and for the headset to work correctly in all conditions.

 **NOTE:** If you do not install batteries, you will hear a low battery warning tone every time you lift the handset or press SPEAKER. The headset feature will not work at all without batteries.



CAUTION: Always unplug the line cord(s), before installing new batteries.

- 1 Turn the telephone upside down.

continued on page 2

Battery Installation

continued from page 1

- 2 If the base wedge is attached, remove the wedge by pressing the tabs as shown and then pulling the wedge away from the base.**



- 3 Press the tab as shown and pull to remove the battery cover. Insert four new AA batteries (purchased separately) following the polarity markings in the battery compartment.**

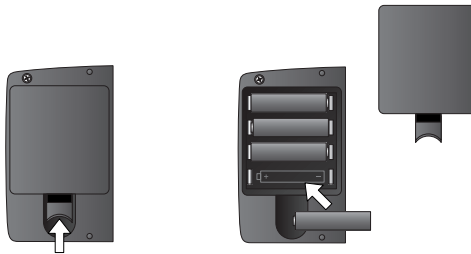

- 4 Replace the battery cover.**

Table/Desk Installation

1 Attach the wedge.

Insert the bottom tabs into the slots as shown. Push gently on the tabs at the large end of the base while locking them into place against the base.



2 Connect the line cord(s) to the telephone and your modular jack(s).

- **If you have a single two-line wall jack**, use only the black (4-conductor) line cord. Plug one end into the jack labeled **L1 OR L1/L2** on the back of the telephone. Plug the other end into the wall jack. Make sure the cord snaps firmly into place at both ends.

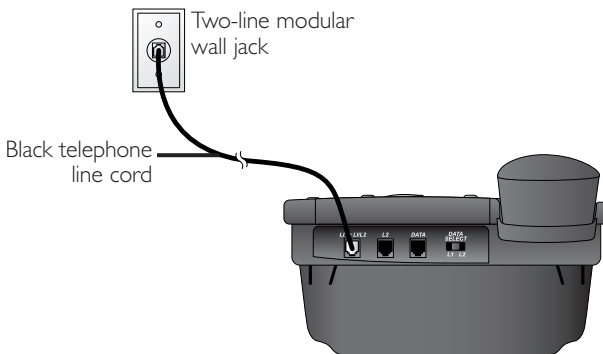

continued on page 4

Table/Desk Installation

continued from page 3

- **If you have two one-line wall jacks**, use both long line cords. Insert one end of the first cord into the jack labeled **L1 OR L1/L2** on the back of the phone. Then, plug the other end into the wall jack for Line 1. Insert one end of the other cord into the jack on the back of the phone labeled **L2**. Then, plug the other end into the wall jack for Line 2. Make sure the cords snap firmly into place at both ends.

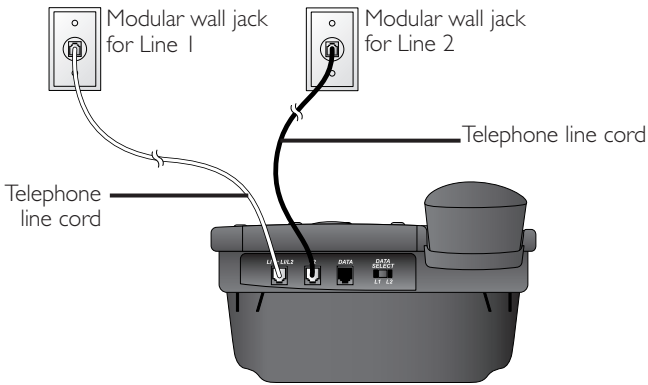

3 Connect the handset to the telephone.

Plug one end of the coiled handset cord into the handset, then plug the other end into the jack on the left side of the telephone base.

4 Set Dial Mode.

This product comes set for touch tone dialing. Make sure you choose the correct dialing method (TONE or PULSE); dial pulse dialing will not work if you have touch tone service.

To set your telephone for dial pulse (rotary) service, lift the handset and press a LINE button, then press **[PROGRAM]**, **[#]**, **[#]**, **[#]**, **[3]**. To change back to touch tone service, press **[PROGRAM]**, **[#]**, **[#]**, **[#]**, **[8]**.

To switch from pulse to tone dialing during a phone call, see “Temporary Tone” on page 15 of your User’s Manual, Part 2

5 Check for dial tone.

Press **[LINE 1]**, lift the handset, press **[SPEAKER]** or press **[HEADSET]** (with a headset connected and batteries installed), and listen for a dial tone. Then press **[LINE 2]**, lift the handset, press **[SPEAKER]** or press **[HEADSET]** (with a headset connected and batteries installed), and listen for a dial tone. If you cannot hear a dial tone, turn to IN CASE OF DIFFICULTY beginning on page 22 of your User’s Manual, Part 2.

NOTE: If you press **HEADSET** when there is no headset connected to the phone but charged batteries are properly installed, you will hear a warning tone. If you did not install batteries, the headset feature will not work at all.

6 Confirm Lines 1 and 2.

To determine which line is which, press **LINE 1** and call one of your telephone numbers. If you hear a busy signal, Line 1 is the number you called. If Line 2 rings, it is the number you called.

TELEPHONE OPERATION

Make a Call

Press a LINE button and lift the handset

— OR —

Press **SPEAKER**

— OR —

Press **HEADSET**, then dial the call.

NOTE: If you did not install batteries, you will hear a low battery warning tone when you lift the handset or press **SPEAKER**.

Answer a Call

Press a LINE button and lift the handset

— OR —

Press **SPEAKER**

— OR —

Press **HEADSET**.

End a Call

Replace the handset

— OR —

Press the other LINE button

— OR —

Press **SPEAKER** (if on speakerphone call)

— OR —

Press **HEADSET** (if on headset call).

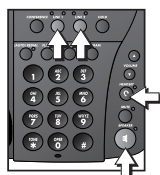
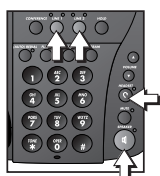
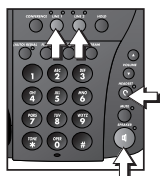



In case of difficulty, visit our Service Center at
www.telephones.att.com or call **1 800 222-3111**.

© 2004 Advanced American Telephones.

All Rights Reserved.

AT&T and the Globe Design are
trademarks of AT&T Corp., licensed to
Advanced American Telephones.

Printed in China. Issue 1AT&T 06/04