

CONTENTS

BEFORE YOU BEGIN3	Redial.....26
Glossary.....4	Auto Redial.....26
Features List.....6	Hold.....27
Audible Signals.....7	Switch Between Lines.....27
INSTALLATION.....8	Mute.....27
Table/Desk Installation.....8	Flash.....27
Wall Installation.....10	Temporary Tone Dialing.....28
Convenience Ports.....14	Conference Calls.....28
SET UP SYSTEM FEATURES15	Transfer a Call.....29
Change Display Language.....16	Low Battery Indicator.....29
Set the Time/Date.....16	SPEED DIAL OPERATION.....30
Assign an Extension Number to Your Phone.....16	Storing a Name and a Number in a Speed Dial Location.....31
Turn COVM Indicator On or Off for Each Line.....17	Reviewing Information Stored in a Speed Dial Location.....32
Turn the Ringer On or Off for Each Line.....17	Editing Information Stored in a Speed Dial Location.....32
Select the Ringer Type.....17	Making a Speed Dial Call.....32
Set Delay Ring.....18	Removing Information from a Speed Dial Location.....32
Turn Line Usage On or Off for Each Line.....18	DIRECTORY OPERATION.....33
Assign the Prime Line (Line Preference).....18	Storing Names and Numbers in the Directory.....34
Assign the Line Group for this Phone.....19	Storing a Pause in a Directory Number.....35
Turn Auto-Mute On or Off.....19	Storing a Temporary Tone Signal in a Directory Number.....35
Set the Dial Mode.....19	Storing a Flash in a Directory Number.....35
Set the Flash Time.....19	Reviewing Information Stored in the Directory.....36
Turn Hold Reminder On or Off.....20	Changing Directory Entries.....37
Program Home and Local Area Codes.....20	Dialing a Number from the Directory.....37
Set Your Phone to be the Centrex Console Phone.....20	Removing a Name and Number from the Directory.....38
Program the Centrex Console Delayed Ring Time.....21	Removing All Entries from the Directory.....38
Erase All Settings and Return the Phone to Default Settings.....21	INTERCOM OPERATION.....39
TELEPHONE OPERATION.....22	Basic Intercom Operations.....40
Making or Answering a Call.....23	Making an Intercom Call with the Handset.....40
Timer.....24	Making an Intercom Call with the Speakerphone or Headset.....41
Call Privacy.....24	
Do Not Disturb.....25	
Line-In-Use Lights.....25	
Volume.....25	

CONTENTS

Answering an Intercom Call.....	41
Making a Single-phone Page.....	41
Answering a Single-phone Page.....	41
Switching Between an Intercom Call and a Single-phone Page.....	42
Ending an Intercom or Page Call.....	42
Paging All Phones.....	42
Answering a System-wide Page.....	42
Making an Intercom Conference Call.....	43
Room Monitor.....	43
CALLER ID OPERATION.....	44
Call Waiting.....	46
Calls Received on Two or More Lines Simultaneously.....	46
Message Waiting and NEW CALL Light.....	47
Call List.....	48
Display Messages.....	49
Removing Calls from Call List.....	49
Dialing a Number from Call List.....	50
Saving a Number from Call List to the Directory.....	51
Time/Date.....	51
Reset COVM Indicator.....	51
ADDING A FAX MACHINE.....	52
Using a Fax Switch.....	52
IN CASE OF DIFFICULTY.....	53
EXPANDING THE 955 SYSTEM.....	56
Line Groups.....	56
Private Lines.....	57
CENTREX OPERATION.....	58
Setup Checklist.....	58
Enabling the Console Phone.....	58
Console Operation.....	58
Setting Ring Delay Duration.....	59
Answering a Delayed Ring.....	59
Picking Up Another Station's Line.....	59
INDEX.....	60

BEFORE YOU BEGIN

- Check to be sure your box contains:
 - 1 Telephone
 - 1 Handset
 - 1 Handset cord
 - 1 Mounting base
 - 2 Seven-foot line cords
 - 1 Eight-inch line cord
 - 1 Power adapter
 - 1 Warranty insert
 - 1 9V battery
 - 1 User's Manual
- You must have a modular telephone jack and an electrical outlet not controlled by a wall switch near where you're installing the phone.
- The total length of telephone wiring used in this system is important. If the total length of telephone wiring is more than 600 feet, you may need to use a special filter device. You can call 1 800 222-3111 for information about this filter. You'll need to contact a professional to install this filter.
- Identify the number of phone lines you'll use.
- Plan the layout of your phone system.
- All connected phones must have the same Line 1 phone number for the Intercom and Page features to work.
- Assign a different Intercom Extension Number (11 through 22) to each 955 telephone. You'll need to do this individually at each telephone.
- Decide if you want a private line. A private line does not appear on all connected phones.
- You must subscribe to **combined** Caller ID with Call Waiting as a **single** service to see Caller ID information for Call Waiting calls. Check with your local telephone company for availability.
- Choose your setting for each system feature. You will need to program the features during installation (see "Features List").

BEFORE YOU BEGIN

Glossary

CID: This stands for Caller Identification, which is a subscriber service, available from most local telephone companies for a fee. When you subscribe to Caller Identification, you can see who's calling before you answer the phone if you and the caller are both in areas offering Caller ID service with compatible equipment.

Caller ID with Call Waiting: This is a single combined subscriber service which may be available from your local telephone company. If you subscribe to this service you can use your 955 telephone system to see who's calling even while you are on another call (as long as your caller is in an area with Caller ID service and both telephone companies use compatible equipment).

Centrex Service: A special subscriber service which may be available from your local telephone company for a fee. The 955 telephone system can be used with Centrex Service.

COVM: Central Office Voice Mail is a subscriber voice message service which may be available from your local telephone company. This service may be called by another name in your area (e.g., Call Answering).

DND: When activated the Do Not Disturb feature prevents interruptions during a call.

Home Area Code: This is the area code for your telephone number. Most users simply dial the seven digits of a phone number to make a call within their own area code and 11 digits outside of their area code. If this applies to you, you should enter your own area code into the unit as the Home Area Code. After programming, if you receive a call from within your Home Area Code, the screen will display the seven digits of the phone number. When you use Display Dial, the unit will know to ignore the Home Area Code, and dial only the seven digits of the phone number.

BEFORE YOU BEGIN

You may, however, live in a region where for calls within your own area code, you must dial 10 digits (that is, the three-digit area code and phone number). If this applies to you, enter "000" for the Home Area Code and enter your area code as a Local Area Code. After programming, if you receive a call from within your area code, the screen displays the 10 digits of the phone number. When you use Display Dial, the unit will know to dial your area code along with the seven digits of the telephone number (and "1" if appropriate).







Be sure to follow the directions on page 20 for programming the Home Area Code.



Local Area Code: Most users dial 11 digits to make calls outside their Home Area Code. These users do not need to program any Local Area Codes.

However, if you dial only 10 digits to make calls to some areas outside your Home Area Code (without dialing "1"), then program these Local Area Codes into the unit (up to five Local Area Codes can be programmed). See page 20 for directions.

After programming, if you receive a call from one of these Local Area Codes, the screen displays the 10 digits of the phone number. When you use Display Dial, the unit will dial the 10 digits, without inserting a "1" before the area code.

Line Group: A group of 955 phones sharing some lines within a multi-phone system.

Navigation buttons: These are the buttons used when programming your 955 system and for scrolling through feature options (, , , , , ).

Prime Line: This is the line on your phone you designate to be selected automatically when you lift the handset, press , or press .

BEFORE YOU BEGIN

Features List

NOTE: An * indicates the default setting for each system feature.

NOTE: One ring is equal to about six seconds, two rings equals twelve seconds, and so on.

Feature	Function	Setting Option(s)
LANGUAGE	Select language for screen displays	English* or Spanish
TIME/DATE	Manually set time and date	01:00AM 01/01 Sunday*
EXTENSION NO	Assign extension number for this phone	11-22*
COVM ON/OFF	Turn COVM (message/voice mail) indicators on or off for each line	On or Off*
COVM RESET	Clear COVM indicators when they are lit but no new messages are waiting	NA
RINGER ON/OFF	Turn ringer on or off for each line	On* or Off
RINGER TYPE	Select ring pattern for this phone	Type 1*, 2, 3, 4
DELAY RING	Select desired time to delay Central Office ring	Off*, 2, 4, 6, ... 30 seconds
LINE USAGE	Turn line usage on or off for each line	On* or Off
PRIME LINE	Assign a line on this phone to be selected automatically when you lift the handset, press [SPEAKER] , or press [HEADSET]	Line 1*, 2, 3, 4
LINE GROUP	Assign your phone to a Line Group	Line Group 4*-15 or PRV (private)
AUTO-MUTE	Turn Auto-Mute on or off (sounds at this extension will be heard automatically when paged)	On* or Off
TONE/PULSE	Set dial mode for touch-tone or dial pulse (rotary) dialing	Tone* or Pulse
FLASH TIME	Set length of signal sent when you press [FLASH]	0.3 seconds - 0.9 seconds 0.7 seconds*
HOLD REMINDER	Turn audible reminder that a call at this extension is on hold on or off	On* or Off

BEFORE YOU BEGIN

Feature	Function	Setting Option(s)
AREA CODES	Program one Home and up to five Local Area Codes for use with Caller ID features	1-3 digits, Empty*
CONSOLE	Specify whether your phone is the Centrex Console phone for your system	On or Off*
CSL DELAY RING	Set time to delay ring for Centrex Console phone	Off*, 2, 4, 6, ... 30 seconds
RESET ALL!!!	Return all settings to default settings	(Defaults)

Audible Signals

When you hear:	It means:
A rapid double-ring pattern, repeating	You have an incoming intercom call.
Long single ring, repeating	You have an incoming transferred call.
Short single ring, repeating	The extension number you just programmed has already been assigned. Choose another number for this extension.
Short single tone, repeating	The extension you are calling is in DND mode.
Long single tone, repeating	The extension you are calling is busy.

INSTALLATION

NOTE: If you are installing multiple phones in your 955 system, you must install and program one set at a time. If more than one extension is assigned the same extension number, a repeating short ring (error ring) will sound at all extensions. Reassign extension numbers, being sure that each extension has a different number from 11 to 22 (see "Assign an Extension Number to Your Phone" in SET UP SYSTEM FEATURES).

Table/Desk Installation

1 Install one 9V battery.

- Press in on the tabs and remove the telephone base.
- Use a small Phillips head screwdriver to remove the screw and open the battery door.
- Insert the 9V battery (included), and replace the screw to close the battery door.
- Replace the telephone base.

NOTE: The battery retains telephone memory in the event of a power failure. If power fails and a working battery is installed, this phone will work only to dial and answer calls with the handset or headset. No other features will work until power is restored.

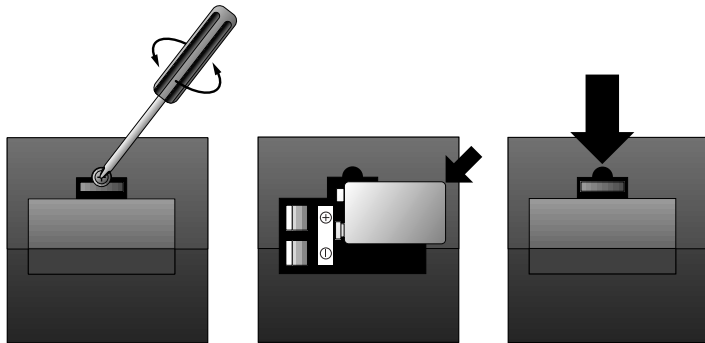

INSTALLATION

2 Connect the telephone line cords to the telephone.

- **Four One-Line Jacks** (To use this installation option, you'll need to purchase two two-line adapters. Adapters are available at retail stores or by calling 1 800 222-3111.)

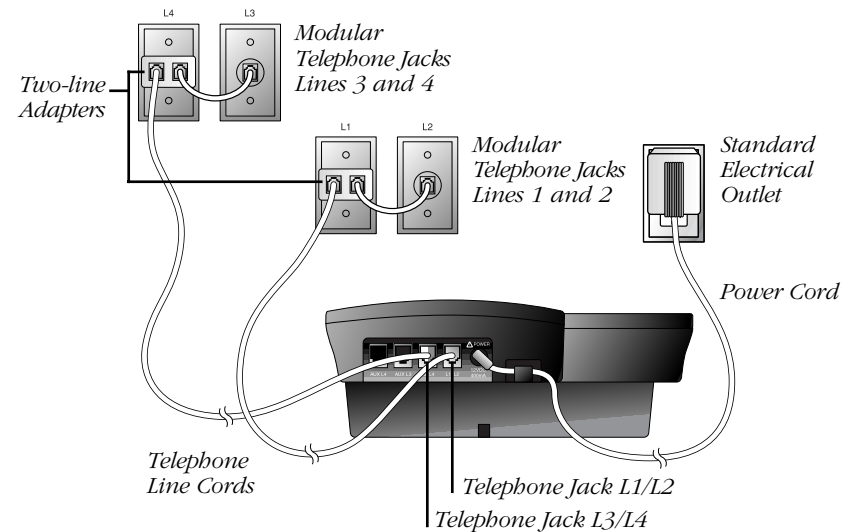

- **Two Two-Line Jacks**

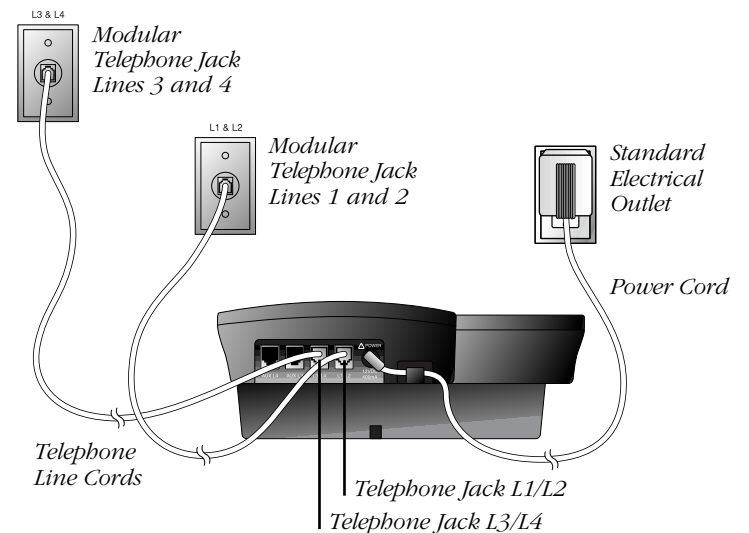

INSTALLATION

3 Connect the handset cord.

Plug one end of the coiled handset cord into the jack on the left side of the phone. Plug the other end into the handset, and hang up.

4 Connect the power adapter.



Use only the power adapter provided with this product. To obtain a replacement, call 1 800 222-3111.

Plug one end of the power adapter into the jack labeled ADAPTER on the back of the phone. Plug the other end into a standard electrical outlet not controlled by a wall switch.

NOTE: If the screen displays POWERFAIL the first time you plug in the phone, press any key to clear the screen.

5 Check for dial tone.

Lift the handset and listen for a dial tone. If you cannot hear a dial tone, turn to IN CASE OF DIFFICULTY.

6 Initialization.

As soon as you connect the power cord, the system runs a quick self-test and the screen displays Initializing for about seven seconds. When the test is complete, the system enters an initial setup mode (this happens the first time you plug in the unit only) and the screen displays press PROG to setup your phone. See SET UP SYSTEM FEATURES beginning on page 15.

Wall Installation

1 Reverse the handset tab.

Hold down the switchhook, then pull the tab out and rotate it 180 degrees. Push the tab down into the grooves so it settles into position.

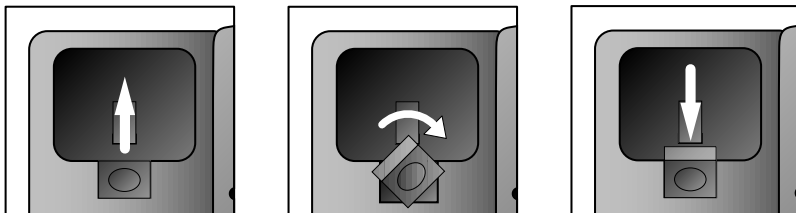

INSTALLATION

2 Install one 9V battery.

- Press in on the tabs and remove the telephone base.
- Use a small Phillips head screwdriver to remove the screw and open the battery door.
- Insert the 9V battery (included), and replace the screw to close the battery door.
- Replace the telephone base.

NOTE: The battery retains telephone memory in the event of a power failure. If power fails and a working battery is installed, this phone will work only to dial and answer calls with the handset or headset. No other features will work until power is restored.

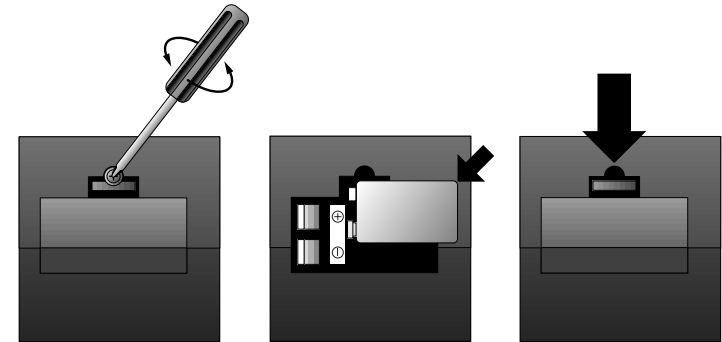

3 Connect the telephone line cords to the telephone.

Please refer to line cord connection instructions in Step 2 of "Table/Desk Installation" on page 9.

4 Turn the base, as shown, and attach it to the bottom of the phone.

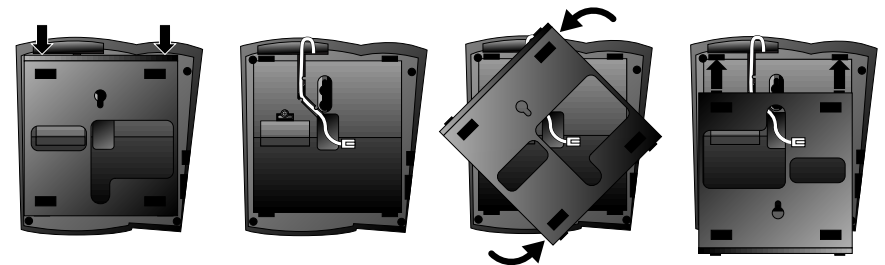

INSTALLATION

5 Connect the handset cord.

Plug one end of the coiled handset cord into the jack on the left side of the phone. Plug the other end into the handset, and hang up.

6 Connect the power adapter to the telephone.



Use only the power adapter provided with this product. To obtain a replacement, call 1 800 222-3111.

Plug one end of the power adapter into the jack labeled **ADAPTER** on the back of the phone.

NOTE: If the screen displays **POWERFAIL** the first time you plug in the phone, press any key to clear the screen.

7 Check for dial tone.

Lift the handset and listen for a dial tone. If you cannot hear a dial tone, turn to **IN CASE OF DIFFICULTY**.

8 Mount the phone on the wall

• Four One-Line Jacks

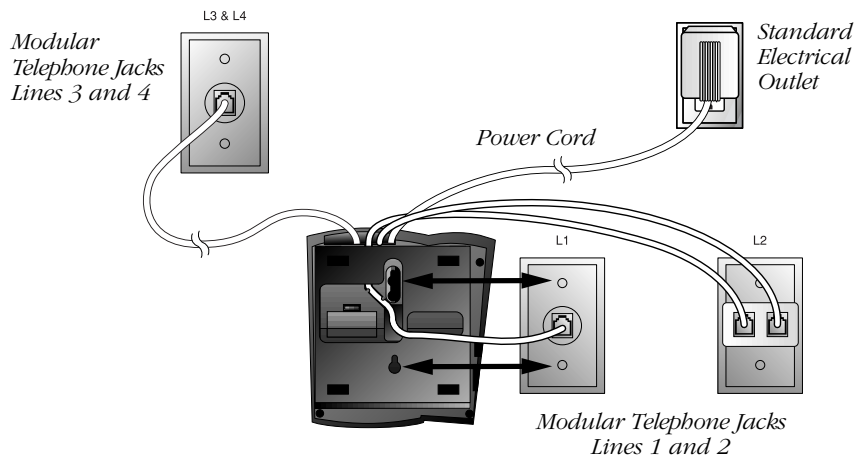

INSTALLATION

• Two Two-Line Jacks

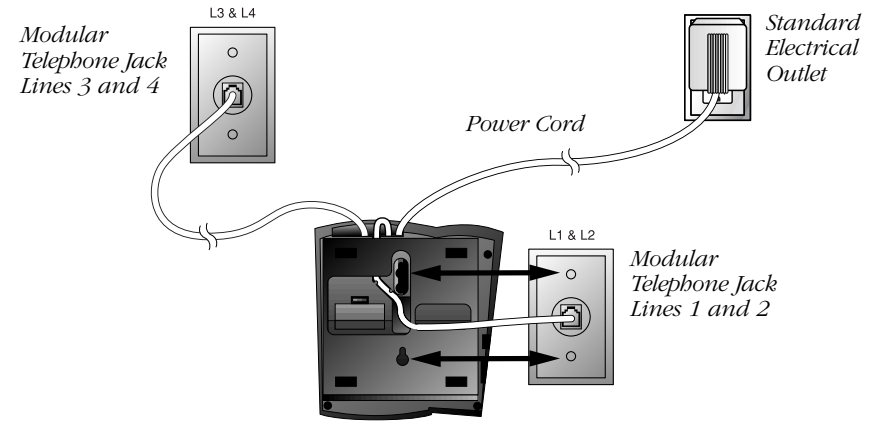

9 Plug the power adapter into a standard electrical outlet not controlled by a wall switch.

10 Initialization.

As soon as you connect the power cord, the system runs a quick self-test and the screen displays **Initializing** for about seven seconds. When the test is complete, the system enters an initial setup mode (this happens the first time you plug in the unit only) and the screen displays **press PROG** to setup your phone. See **SET UP SYSTEM FEATURES** beginning on page 15.

INSTALLATION

Convenience Ports

If you want to connect another device (such as a modem or fax machine) to the wall jack, you can use the jacks on the phone labeled AUX. These convenience ports use Lines 3 and 4; a call picked up on Line 3 or 4 at another extension may interrupt a fax, modem, or message transmission.

• Four One-Line Jacks

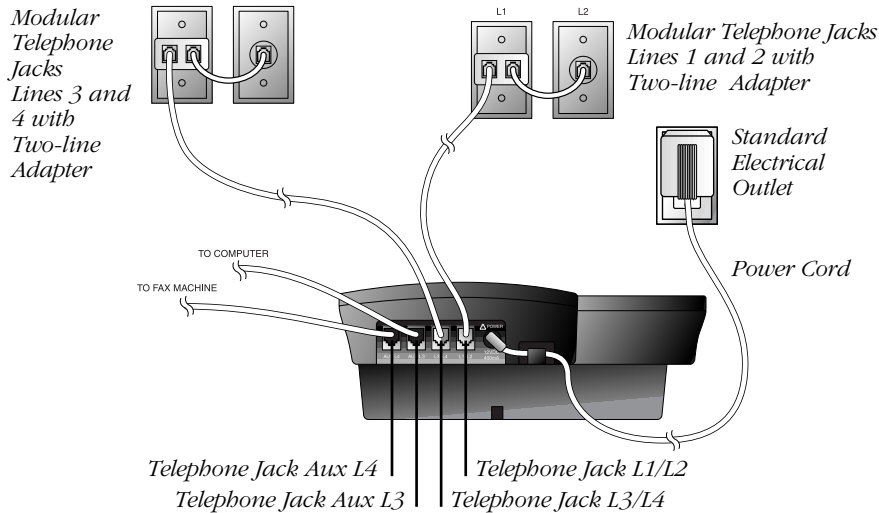

• Two Two-Line Jacks

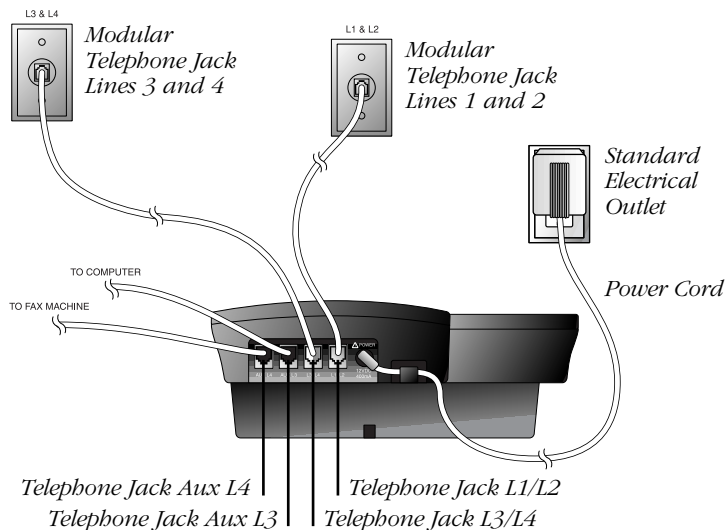

SET UP SYSTEM FEATURES

Use the Navigation buttons to program or change the system features setup.

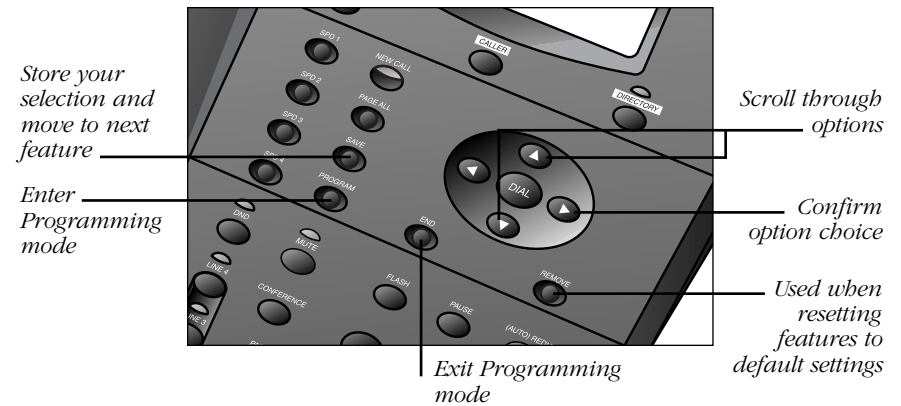

- Press **PROGRAM** to enter the Programming mode. The screen displays:

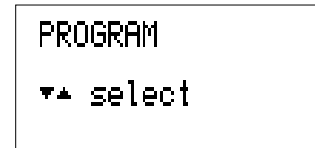

NOTE: If you do not press a key to continue programming within 20 seconds, the system automatically exits the Programming mode.

- Press **▼** or **▲** repeatedly to move through the list of options.
- Press **▶** to choose the option currently displayed.
- Press **SAVE** to store your selections and return to the 'home screen' for the feature currently displayed.

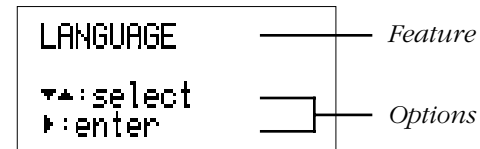

You can set up one feature at a time or you can set up a feature and then move on to set up another feature. After you change one feature, press **▲** or **▼** to select another feature. When you are finished with features setup, press **END** to exit Programming mode.

NOTE: After a feature is successfully programmed, the system beeps once. If the system beeps twice, repeat the steps to set up the feature.

SET UP SYSTEM FEATURES

Change Display Language

- 1 Press **PROGRAM**.
- 2 Press **▼** until the screen displays LANGUAGE, then press **►**.
- 3 Press **▼** or **▲** until the screen displays your language selection.
- 4 Press **SAVE** to store your selection.

Set the Time/Date

NOTE: The time and date are automatically set with incoming call information. Follow the steps below to set manually.

- 1 Press **PROGRAM**.
- 2 Press **▼** until the screen displays TIME/DATE.
- 3 Press **►** until screen displays HOUR.
- 4 Press **▼** or **▲** to select the correct hour setting.
- 5 Press **SAVE** to store the hour setting. The screen displays MINUTES.
- 6 Press **▼** or **▲** to select the correct minutes setting.
- 7 Press **SAVE** to store the minutes setting. The screen displays AM/PM.
- 8 Press **▼** or **▲** to select AM or PM.
- 9 Press **SAVE** to store the setting. The screen displays MONTH.
- 10 Press **▼** or **▲** to select the correct month.
- 11 Press **SAVE** to store the setting. The screen displays DATE.
- 12 Press **▼** or **▲** to select the correct day of the month.
- 13 Press **SAVE** to store the setting. The screen displays DAY OF WEEK.
- 14 Press **▼** or **▲** to select the correct day of the week.
- 15 Press **SAVE** to store the setting.

Assign an Extension Number to Your Phone

- 1 Press **PROGRAM**.
- 2 Press **▼** until the screen displays EXTENSION NO, then press **►**.
- 3 Press **▼** or **▲** to select the desired extension number (from 11 to 22).
- 4 Press **SAVE** to store your selection.

NOTE: If you duplicate an extension number, you will hear a repeating short ring. Repeat **Steps 1-4** and assign a different number (from 11 to 22).

SET UP SYSTEM FEATURES

Turn COVM Indicator On or Off for Each Line

If you subscribe to Voice Mail service with your local telephone service provider, turn the COVM indicator on to have the screen display the appropriate line numbers when there are messages waiting. You can turn the COVM indicator on or off for each line individually or for all lines at once. If you do not subscribe to Voice Mail service, turn the COVM indicator off for each line.

- 1 Press **PROGRAM**.
- 2 Press **▼** until the screen displays COVM ON/OFF, then press **►**.
- 3 Press **▼** or **▲** until the screen displays the desired line number, then press **►**.
- 4 Press **▼** or **▲** to select the desired setting.
- 5 Press **SAVE** to store your selection.
- 6 Repeat **Steps 1-5** to change the indicator setting for additional lines.

Turn the Ringer On or Off for Each Line

- 1 Press **PROGRAM**.
- 2 Press **▼** until the screen displays RINGER ON/OFF, then press **►**.
- 3 Press **▼** or **▲** until the screen displays the desired line number, then press **►**.
- 4 Press **▼** or **▲** to select the desired setting.
- 5 Press **SAVE** to store your selection.
- 6 Repeat **Steps 1-5** to change the ringer setting for additional lines.

Select the Ringer Type

- 1 Press **PROGRAM**.
- 2 Press **▼** until the screen displays RINGER TYPE, then press **►**.
- 3 Press **▼** or **▲** to select the desired setting. You will hear a sample of each ringer type as you move through the settings.
- 4 Press **SAVE** to store your selection.

SET UP SYSTEM FEATURES

Set Delay Ring

NOTE: This feature is for use with Centrex systems only.

NOTE: If you choose to set a delayed ring on a phone with COVM service, the phone may not ring at all before COVM picks up the call.

- 1 Press **PROGRAM**.
- 2 Press **▼** until the screen displays **DELAY RING**, then press **▶**.
- 3 Press **▼** or **▲** to select the desired setting. (One ring is about six seconds.)
- 4 Press **SAVE** to store your selection.

Turn Line Usage On or Off for Each Line

If you are not using all four phone lines, you need to turn off Line Usage for the unused lines. If you expand to a third or fourth line, turn Line Usage back on.

You may also restrict the use of certain lines on this phone to intercom and paging only, by turning off Line Usage for each line to be restricted. When Line Usage is turned off, that line cannot be used to answer incoming calls or to make outgoing or transfer calls.

- 1 Press **PROGRAM**.
- 2 Press **▼** until the screen displays **LINE USAGE**, then press **▶**.
- 3 Press **▼** or **▲** until the screen displays the desired line number, then press **▶**.
- 4 Press **▼** or **▲** to select the desired setting.
- 5 Press **SAVE** to store your selection.
- 6 Repeat **Steps 1-5** to change the Line Usage status for additional lines.

Assign the Prime Line (Line Preference)

- 1 Press **PROGRAM**.
- 2 Press **▼** until the screen displays **PRIME LINE**, then press **▶**.
- 3 Press **▼** or **▲** to select the desired setting.
- 4 Press **SAVE** to store your selection.

SET UP SYSTEM FEATURES

Assign the Line Group for this Phone

- 1 Press **PROGRAM**.
- 2 Press **▼** until the screen displays **LINE GROUP**, then press **▶**.
- 3 Press **▼** or **▲** to select the desired setting.
- 4 Press **SAVE** to store your selection.

Turn Auto-Mute On or Off

Choose whether sounds at this extension will be heard automatically in response to a page (Auto-Mute Off) or only when **MUTE** is pressed. Auto-Mute Off permits hands-free conversation and room monitoring; Auto-Mute On protects privacy.

- 1 Press **PROGRAM**.
- 2 Press **▼** until the screen displays **AUTO MUTE**, then press **▶**.
- 3 Press **▼** or **▲** to select the desired setting.
- 4 Press **SAVE** to store your selection.

Set the Dial Mode

- 1 Press **PROGRAM**.
- 2 Press **▼** until the screen displays **TONE/PULSE**, then press **▶**.
- 3 Press **▼** or **▲** to select the desired setting.
- 4 Press **SAVE** to store your selection.

Set the Flash Time

NOTE: If you are using this phone within the United States, there is no need to change the Flash Time from the default setting (0.7 seconds).

- 1 Press **PROGRAM**.
- 2 Press **▼** until the screen displays **FLASH TIME**, then press **▶**.
- 3 Press **▼** or **▲** to select the desired setting.
- 4 Press **SAVE** to store your selection.

SET UP SYSTEM FEATURES

Turn Hold Reminder On or Off

- 1 Press **PROGRAM**.
- 2 Press **▼** until the screen displays HOLD REMINDER, then press **▶**.
- 3 Press **▼** or **▲** to select the desired setting.
- 4 Press **SAVE** to store your selection.

Program Home and Local Area Codes

One Home and up to five Local Area Codes can be programmed into the unit. The Home Area Code must be programmed in order for you to dial numbers stored in the directory and the Caller ID Call List and so that you can transfer numbers from the Call List to the directory. By programming these specific area codes, the unit will be able to distinguish a local call from a long distance call, and will thereby dial the appropriate number of digits.

- 1 Press **PROGRAM**.
- 2 Press **▼** until the screen displays AREA CODES, then press **▶**.
- 3 Press **▼** or **▲** to select type of area code you wish to set.
- 4 Press **▶** to confirm your choice, then use the keypad to enter the digits of the area code.
- 5 Press **SAVE** to store the setting.
- 6 Repeat **Steps 1-5** to program additional area codes.

NOTE: If you must dial the area code to place calls within your own area code, enter "000" for the Home Area Code and enter your area code as a Local Area Code.

You will need to program the following two features if this phone is the designated Console Phone for your Centrex system:

Set Your Phone to be the Centrex Console Phone

NOTE: This feature is for use with Centrex systems only.

- 1 Press **PROGRAM**.
- 2 Press **▼** until the screen displays CONSOLE, then press **▶**.
- 3 Press **▼** or **▲** to select a setting.
- 4 Press **SAVE** to confirm your selection.

SET UP SYSTEM FEATURES

Program the Centrex Console Delayed Ring Time

NOTE: This feature is for use with Centrex systems only.

Set the length of time the phone will ring before the Centrex Console phone picks up calls to your phone. One ring is about six seconds.

- 1 Press **PROGRAM**.
- 2 Press **▼** until the screen displays CSL DELAY RING, then press **▶**.
- 3 Press **▼** or **▲** to select a setting.
- 4 Press **SAVE** to confirm your selection.

Erase All Settings and Return the Phone to Default Settings

- 1 Press **PROGRAM**.
- 2 Press **▼** until the screen displays RESET ALL?.
- 3 Press **▶**. The screen displays:

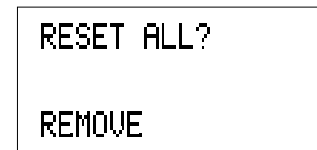

- 4 Press **REMOVE** within three seconds to confirm the RESET ALL command. The screen displays:



TELEPHONE OPERATION

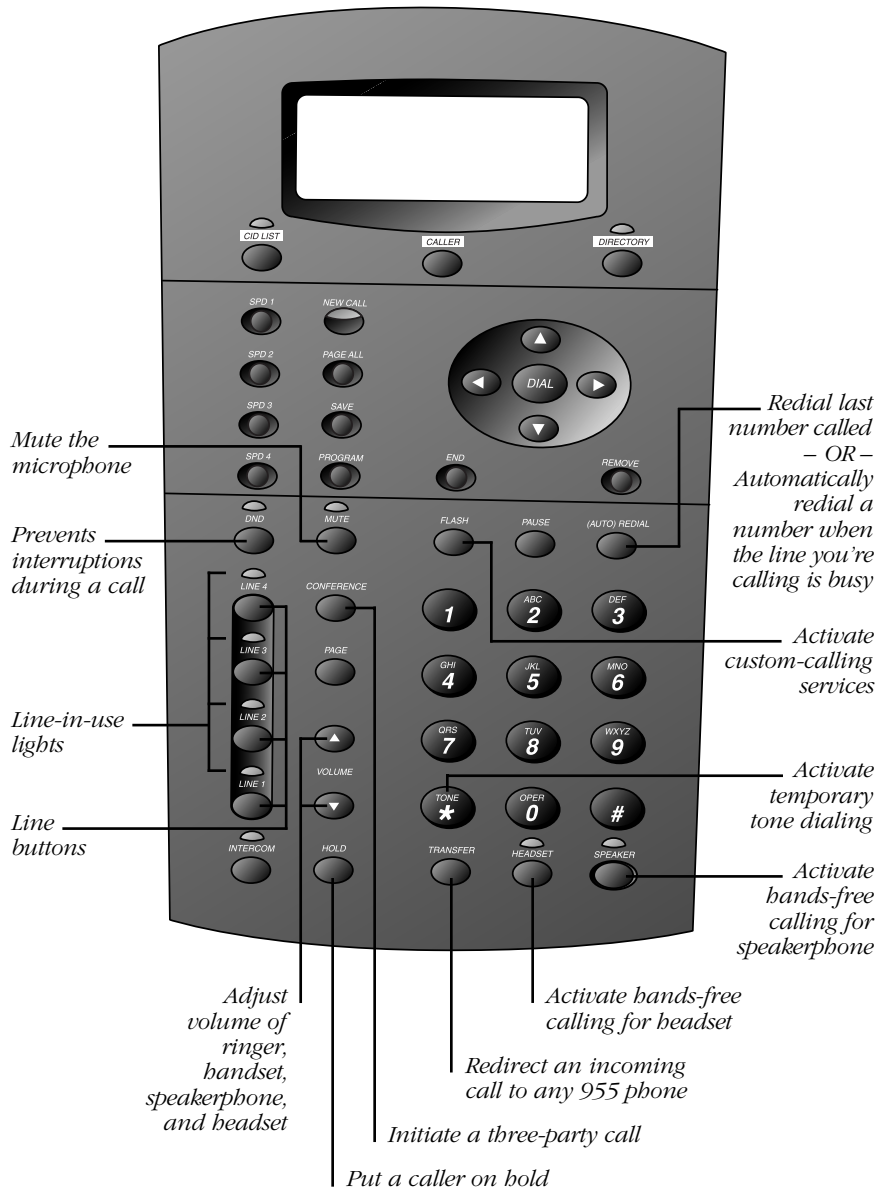

TELEPHONE OPERATION

NOTE: When you make a call, the phone selects the Prime Line you programmed. When you answer a call, the phone automatically selects the ringing line. If you have a private line, the phone automatically selects that line.

Making or Answering a Call

NOTE: This phone will automatically make and answer calls in the mode last used (handset, speakerphone or headset). Follow the directions below to switch modes.

Handset

To make a call, lift the handset. You can dial your call manually or dial a number from the directory (see DIRECTORY OPERATION).

To answer a call, lift the handset. Replace the handset to end the call.

To override automatic line selection, lift the handset, then press and release a LINE button

— OR —

Press the LINE button for the line you wish to select, then lift the handset.

Speakerphone

To make a call, press and release the desired LINE button or **[SPEAKER]**.

The SPEAKER light goes on. Wait for a dial tone, then dial the call manually or by dialing a number from the directory (see DIRECTORY OPERATION).

NOTE: If the most recent call was handled with the headset, you must press **[SPEAKER]** to activate the speakerphone.

To answer a call, press **[SPEAKER]** or press the LINE button of the incoming call. Press **[SPEAKER]** again to end the call.

Headset

You can use this phone hands-free when you install a 2.5mm headset. Headsets are available for purchase in retail stores (comcode #108041732) or by calling 1 800 222-3111.

Make sure the headset is plugged into the headset jack located to the left of the handset jack on the left side of the telephone base. You will hear a double-beep if you press **[HEADSET]** and the headset is not plugged in.

To make a call, press and release **[HEADSET]** or press the desired LINE button and then press **[HEADSET]**. The HEADSET light goes on. Wait for a dial tone, then dial the call manually or by dialing a number from the directory (see DIRECTORY OPERATION).

TELEPHONE OPERATION

To answer a call, press **HEADSET**. Press **HEADSET** again to end the call.

To switch from handset to headset or speakerphone, press **HEADSET** or **SPEAKER**, then replace the handset (for headset, headset must be plugged in).

To switch from speakerphone to handset, lift the handset. (Do not press **SPEAKER** or the call will be disconnected.)

To switch from headset to speakerphone (when handset is in the cradle), press **SPEAKER**.

To switch from headset to speakerphone (when handset is off-hook), press **SPEAKER** and replace the handset.

To switch from speakerphone to headset, insert the headset plug into the jack, and press **HEADSET**.

To override automatic line selection, press and release a LINE button (this activates the speakerphone or headset).

Timer

When you make or answer a call, the timer automatically starts. The screen displays the elapsed time in minutes and seconds for the first hour (up to 59:59) and then begins again. The timer stops automatically when you hang up and the recorded time is displayed for about 10 seconds.

The timer also stops when you place a call on hold and resets when you release hold.

Call Privacy

To ensure call privacy, the phone allows only one set at a time to use a line.

Canceling Call Privacy

During the call, press the LINE button for the call. You'll hear a short beep. Others can now join the call.

Restoring Call Privacy

Press the LINE button again during the call. You'll hear a double-beep. The other phones will be dropped from the call.

NOTE: Call privacy is automatically restored when you end the call.

NOTE: When a non-system phone answers a call, any other system phone can pick up the call by pressing the LINE button. Once a system phone picks up the call, Call Privacy is activated and no other system phones can listen to the call unless Call Privacy is canceled, but non-system phones which share that line can still join the call.

TELEPHONE OPERATION

Do Not Disturb

When your phone is off-hook (i.e., you are on a call) you will hear a low volume ring when you receive an intercom call. In order to prevent even this audible signal, activate the Do Not Disturb feature. When you activate this feature you will not hear paging tones, voice paging, or incoming call rings. Instead, the LINE light flashes and the INTERCOM light goes on to signal an incoming call or page. If you receive an intercom call, the INTERCOM light flashes, and the intercom number calling you appears on the display. Caller ID information will be displayed for incoming calls from outside.

- 1 Press **DND** to prevent interruptions. The DND light goes on and the screen display includes **DND**.
- 2 Press **DND** again to resume normal call alerts. The DND light goes off and the screen no longer shows **DND**.

When this feature is activated, callers from within your 955 system will hear a short repeating tone (like a fast busy signal).

Line-in-Use Lights

Whenever a line is in use, the Line light will be on. Use the following chart to determine the exact status of a line.

A Line light shows:	To show that:
On steadily	The line is in use at another extension
Slow, even blinks	You have an incoming direct call
Rapid, even blinks	You have an incoming transfer call
Flashing pattern long on, brief off	You are talking on the line
Alternating one long and one short flash	The line is on hold at your extension
Two short and one long flash, repeating	The line is on hold at another extension

Volume

Handset/Speakerphone/Headset Volume Control

When you are on a call, press Volume **▲** to increase call volume. Press Volume **▼** to decrease volume. You will hear a beep when you reach the minimum or maximum level.

TELEPHONE OPERATION

Ringer Volume

You can adjust the ringer volume while the phone is ringing. While the line is ringing, press Volume ▲ or Volume ▼ to reach the desired level.

This phone has four ringer volume levels. Each time you adjust the ringer, you will hear a sample indicating the volume level.

Turning Ringer Off

You may turn the ringer for each line on or off. See “Turn the Ringer On/Off for Each Line” in SET UP SYSTEM FEATURES.

Redial

The last number dialed on this phone (up to 32 digits) is stored in redial memory until you dial another number.

Handset

To dial the same number again, lift the handset, listen for the dial tone, then press (AUTO) REDIAL.

Speakerphone or Headset

To dial the same number again, press (AUTO) REDIAL. The phone automatically selects an available line and dials the last number.

NOTE: You will experience a delay before the call is dialed when using the Redial feature. This is normal.

Auto Redial

Press (AUTO) REDIAL twice and the phone automatically selects an available line — OR —

Press a line button to select a line, then press (AUTO) REDIAL twice.

The phone redials the number you just called, and continues up to 10 times until the other line rings, or until you cancel Auto Redial.

When you hear the line ringing or the other party answers, lift the handset or press (SPEAKER) or (HEADSET) to complete the call and speak with the other party. If you don't complete the call, the phone disconnects after 30 seconds.

To cancel Auto Redial, press any button (except Volume ▲ or ▼).

TELEPHONE OPERATION

Hold

Press and release (HOLD). The light of the line on hold flashes, and a double-beep sounds every 30 seconds to remind you the call is on hold. (To turn off the reminder beep, see “Turn Hold Reminder On or Off” in SET UP SYSTEM FEATURES.) You can replace the handset in the cradle without disconnecting the call. The speakerphone is automatically turned off.

To release Hold, press and release the LINE button of the call on hold.

NOTE: The system automatically disconnects a call on hold after 20 minutes. To keep a call on hold longer than 20 minutes, release Hold before 20 minutes and then place the call on hold again.

NOTE: You cannot put an intercom call on hold.

NOTE: If a line is in use, pressing (INTERCOM) or (PAGE) will place the line on hold and activate the intercom.

Switch Between Lines

- 1 Press and release (HOLD) to keep a call on the first line.
- 2 Press and release the LINE button of another line to make or answer another call.

NOTE: If you switch lines without pressing (HOLD) first, you will drop the call.

Mute

This feature lets you mute the telephone so that you can hear the other party, but the other party can't hear you.

To activate this feature, press and release (MUTE). The MUTE light goes on.

To return to the conversation, press and release (MUTE) again.

NOTE: Switching from handset to speakerphone or headset, or from speakerphone or headset to handset, changing lines, and putting a call on hold also cancel Mute.

Flash

Use (FLASH) instead of the switchhook to activate telephone company subscriber services such as Call Waiting or Three-Way Calling.

To adjust the length of the Flash signal, see “Set the Flash Time” in SET UP SYSTEM FEATURES.

TELEPHONE OPERATION

Temporary Tone Dialing

If you have dial pulse (rotary) service, you can change from dial pulse to touch tone dialing during a call by pressing **[XTONE]**. This is useful if you need to send touch tone signals for access to telephone banking or long-distance services.

- 1 Dial the number.
- 2 Press and release **[XTONE]**. Buttons pressed after this send touch tone signals.
- 3 After you hang up, the phone automatically returns to rotary service.

Conference Calls

This feature lets you set up a three-party call by using two lines at the same time. You can also join an intercom call with a call on an outside line.

- 1 Make or answer a call.
- 2 Press and release **[HOLD]**.
- 3 Call someone on another line.
- 4 When this call is answered, press **[CONFERENCE]**. The three-party conference begins immediately.
- 5 To end a conference call, hang up. All parties will disconnect.

To talk privately with one party:

- 1 Press **[HOLD]** to place both lines on hold.
- 2 Press a **LINE** button to talk privately with the person on that line.
- 3 Press **[CONFERENCE]** to resume the conference call.

To drop one line:

Press the **LINE** button of the party you want to keep. The other line will be dropped.

NOTE: Occasionally, the far-end parties on a conference call might not hear one another.

TELEPHONE OPERATION

Transfer a Call

You can transfer a call you answer to any other 955 phone. Once you transfer a call, it can be picked up at any other 955 phone, not just at the extension you called.

- 1 Press **[TRANSFER]**.
- 2 Enter the extension number where you're transferring the call.
- 3 Hang up.

Your phone reminds you with a double-beep every 30 seconds when a transferred call has not been answered.

To answer a transferred call, pick up the handset or press the **LINE** button of the call to use the speakerphone or headset. You will know an incoming call is a transferred call by the distinctive long rings.

NOTE: If you do not dial an extension within 10 seconds, the transfer is automatically cancelled.

NOTE: If a transferred call is not picked up within three minutes, the system will automatically disconnect the call.

Low Battery Indicator

The screen displays **LOW BATT** when the battery needs to be replaced.

SPEED DIAL OPERATION

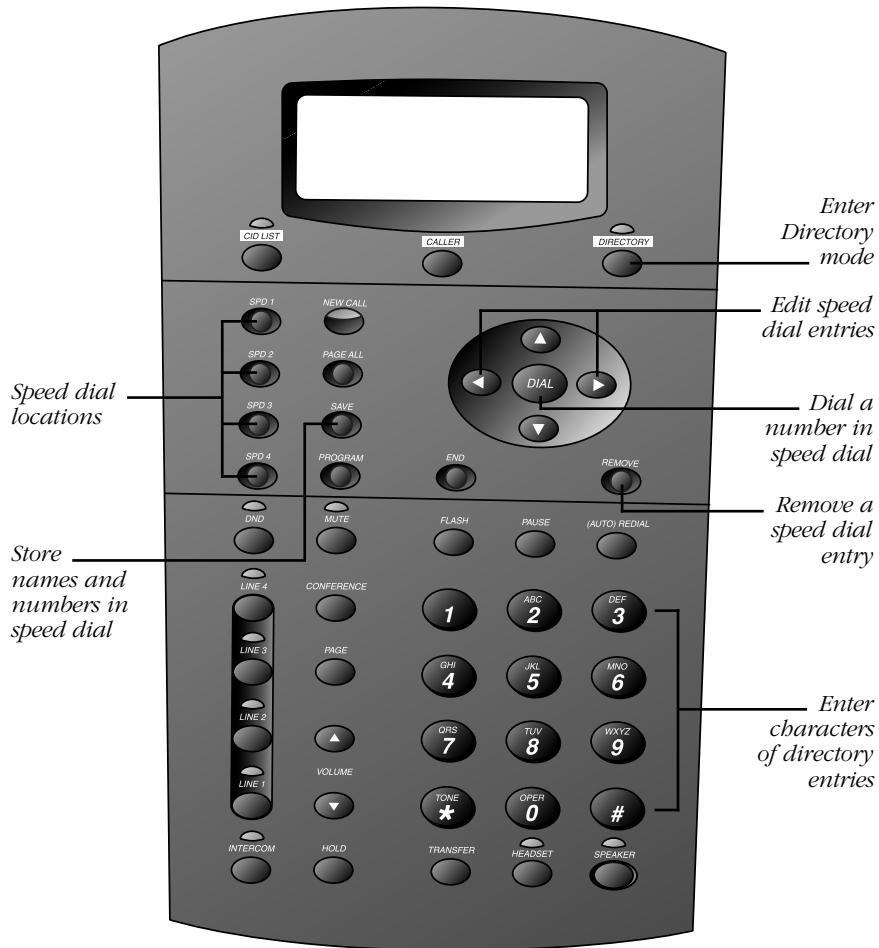

SPEED DIAL OPERATION

This telephone has four Speed Dial locations where you can store phone numbers and names you wish to dial by pressing only two buttons. Names can be up to 16 characters long and numbers can be up to 32 digits long.

Storing a Name and a Number in a Speed Dial Location

- 1 Press **[DIRECTORY]**. The screen displays **DIRECTORY**.
- 2 Press **[SAVE]**. The screen displays:

```

■ (Enter name)

SAVE: save?
    
```

- 3 Use the dial pad keys to enter the letters, digits or symbols you wish to store. Refer to **Step 3** “Storing Names and Numbers in the Directory” in **DIRECTORY OPERATION** on page 34 for detailed directions.

NOTE: To store a number without storing a name, press **[SAVE]** and go on to **Step 5**.

- 4 Press **[SAVE]** to store the name and move on to enter the phone number. The screen displays:

```

JIM
■ (Enter number)

SAVE: save?
    
```

- 5 Use the dial pad keys to enter the phone number you wish to store — **OR** —

Press **[AUTO REDIAL]** to copy the last number you dialed onto the screen. (To edit a number stored from redial you must first finish storing the number, then follow the directions under “Editing Information Stored in a Speed Dial Location.”)

NOTE: Do not press **[SAVE]** at this point or the entry will be saved in the directory instead of a speed dial location.

SPEED DIAL OPERATION

- Press the SPD button where you wish to store this entry. A confirmation tone sounds and the screen displays:

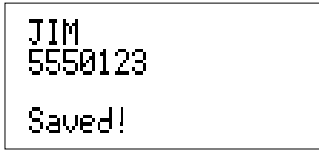

Reviewing Information Stored in a Speed Dial Location

Press the SPD button for the location you wish to review. The screen displays any information stored in that location.

Editing Information Stored in a Speed Dial Location

- Press the SPD button for the location you wish to review.
- Press **[X-TONE]**, then use **[◀]**, **[▶]** and the dial keypad to edit the name.
- Press **[SAVE]** to save the name and move on to edit the phone number.
- Press the SPD button for the location where you wish to save this entry. The screen displays your new entry and **Saved!**.

Making a Speed Dial Call

- Press the SPD button for the number you wish to call.
- When the entry is displayed on the screen, press **[DIAL]** to place the call (the line is selected automatically)
— OR —
Press the LINE button you wish to select, then press **[DIAL]** to place the call.

Removing Information from a Speed Dial Location

- Press the SPD button for the number you wish to remove.
- Press **[REMOVE]**. The screen prompts **REMOVE: remove?**.
- Press **[REMOVE]** again within three seconds to remove the entry. The screen displays:

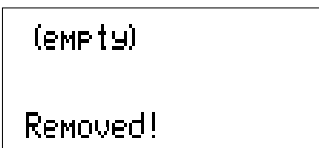

DIRECTORY OPERATION

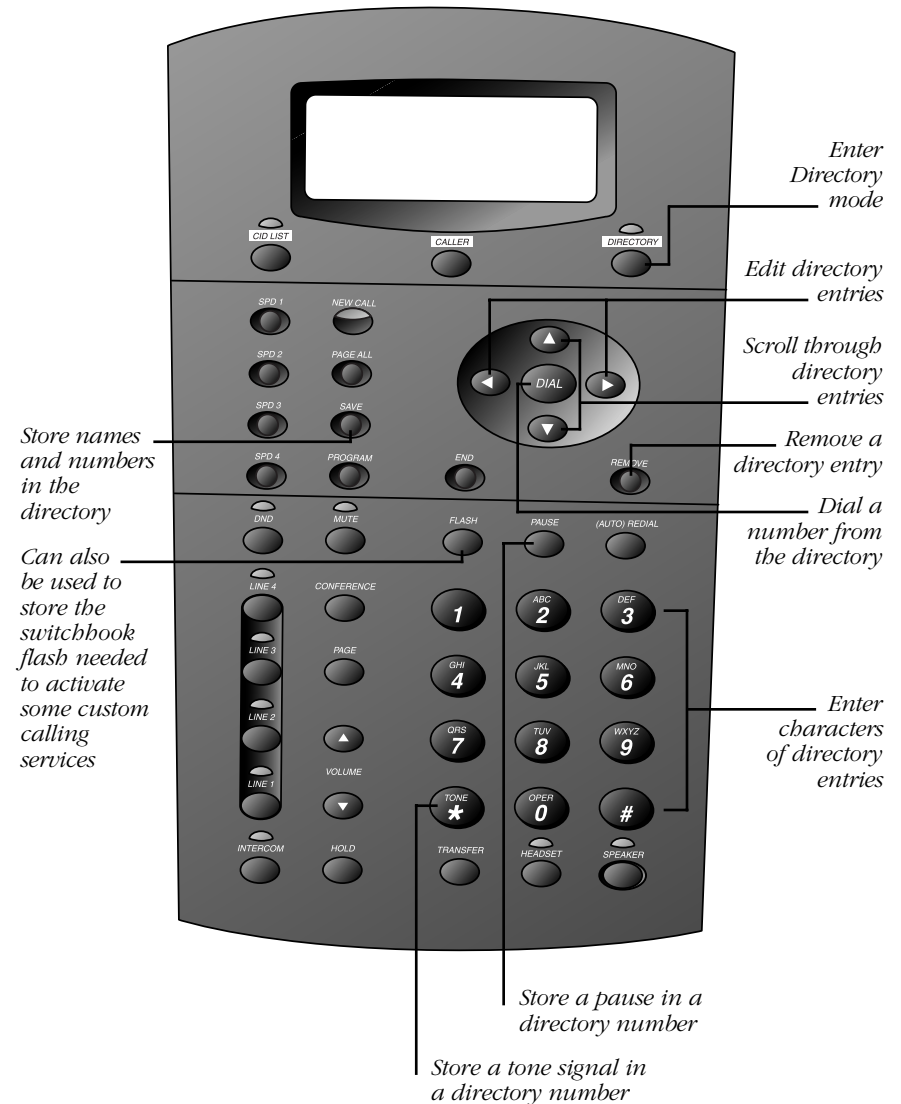

DIRECTORY OPERATION

This phone can store up to 200 names and phone numbers in the directory. Names can be up to 16 characters long and numbers can be 32 digits long. Because directory entries are stored in alphabetical order, you may wish to enter names with the last name first in order to maintain consistency with the information stored automatically through the Caller ID function of this system.

Enter Directory mode by pressing **[DIRECTORY]**. The screen displays DIRECTORY. If the directory is full, the screen displays DIRECTORY FULL!

Storing Names and Numbers in the Directory

- 1 Enter Directory mode.
- 2 Press **[SAVE]**. The screen displays:

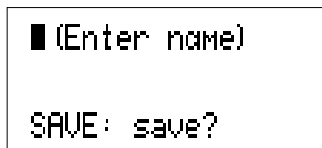

- 3 Use the dial pad keys to enter the letters, digits or symbols you wish to store. Press the key repeatedly until your desired character is displayed. For example, press **[2]** once for "A," twice for "B," three times for "C," and four times for "2." Press **[▶]** to move to the next character or **[◀]** to backspace. Press **[▶]** twice to insert a space.

PRESS:	ONCE	TWICE	3 TIMES	4 TIMES	5 TIMES	6 TIMES	7 TIMES	8 TIMES
[1]	,	-	'	&	.	()	!
[2]	A	B	C	2				
[3]	D	E	F	3				
[4]	G	H	I	4				
[5]	J	K	L	5				
[6]	M	N	O	6				
[7]	P	Q	R	S	7			
[8]	T	U	V	8				
[9]	W	X	Y	Z	9			
[*]	*							
[0]	0							
[#]	#							

DIRECTORY OPERATION

NOTE: To store a number without storing a name, press **[SAVE]** and go on to **Step 5**.

- 4 Press **[SAVE]** to store the name and move on to enter the phone number. The screen displays:

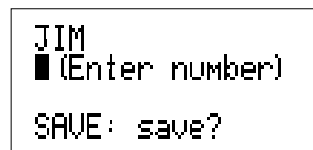

- 5 Use the dial pad keys to enter the phone number you wish to store — OR —

Press **[AUTO REDIAL]** to copy the last number you dialed onto the screen. (To edit a number stored from redial you must first finish storing the number, then follow the directions under "Changing Directory Entries.")

- 6 Press **[SAVE]** to store the name and number in the directory. The screen displays:

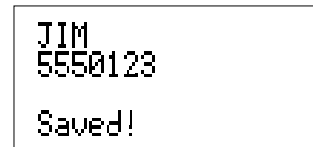

Storing a Pause in a Directory Number

To store a dialing pause in a directory number, press and release **[PAUSE]** where you want the dialing pause to occur. Each time you press **[PAUSE]** you enter a three-second pause in the dialing sequence.

Storing a Temporary Tone Signal in a Directory Number



To store a tone signal, press and release **[XTONE]** where you want tone dialing to begin. All digits entered after this will send tone signals.

Storing a Flash in a Directory Number



You can store the switchhook flash needed to access some custom-calling services in a directory number. Press and release **[FLASH]** where you want the switchhook flash to occur in the dialing sequence.

DIRECTORY OPERATION

Reviewing Information Stored in the Directory

- 1 Enter the Directory mode.
- 2 Press  or  to scroll through the directory entries

— OR —

Repeatedly press the dial pad key that has the first character of the entries you wish to review until the character you are looking for is displayed. Then press  or  to move through the entries beginning with this character.

For example, to find the entry you stored for Jim in a directory beginning with an entry for “Aaron,” press . The screen displays:

```
AARON
9085550127
*:EDIT
```







Then press the button for “J,” the screen displays:

```
JIM
5550123
*:EDIT
```

NOTE: If there is no entry with the first letter “J,” the screen will display No Entries for “J”.



DIRECTORY OPERATION

Changing Directory Entries

- 1 Find the directory entry you wish to change by following the directions under “Reviewing Information Stored in the Directory.”
- 2 Press , then use ,  and the dial keypad to edit the name.
- 3 Press  to save the name and move on to edit the phone number.
- 4 Use ,  and the dial keypad to edit the number.
- 5 Press  to store the name and number in the directory. The screen displays your new entry and Saved!.

```
JIM
5550123
Saved!
```

Dialing a Number from the Directory

- 1 Enter Directory mode and use the dial pad or Navigation buttons to find the entry for the number you wish to call (see “Reviewing Information Stored in the Directory”).
 - 2 When the desired directory entry is displayed on the screen, press  to place the call (the line is selected automatically)
- OR —
- Press the LINE button for the line you wish to select, then press  to place the call.

DIRECTORY OPERATION

Removing a Name and Number from the Directory

- 1 Enter Directory mode and use the dial pad or Navigation buttons to find the entry for the number you wish to remove from the directory (see “Reviewing Information Stored in the Directory”).
- 2 Press **[REMOVE]**. The screen prompts REMOVE: remove?.
- 3 Press **[REMOVE]** again within three seconds to remove the entry. The screen displays:

```
(empty)

Removed!
```

Removing All Entries from the Directory

- 1 Enter Directory mode.
- 2 Press **[REMOVE]**. The screen prompts DIRECTORY REMOVE: all?.
- 3 Press **[REMOVE]** again within three seconds to remove all entries. The screen displays:

```
(empty)

All Removed!
```

INTERCOM OPERATION

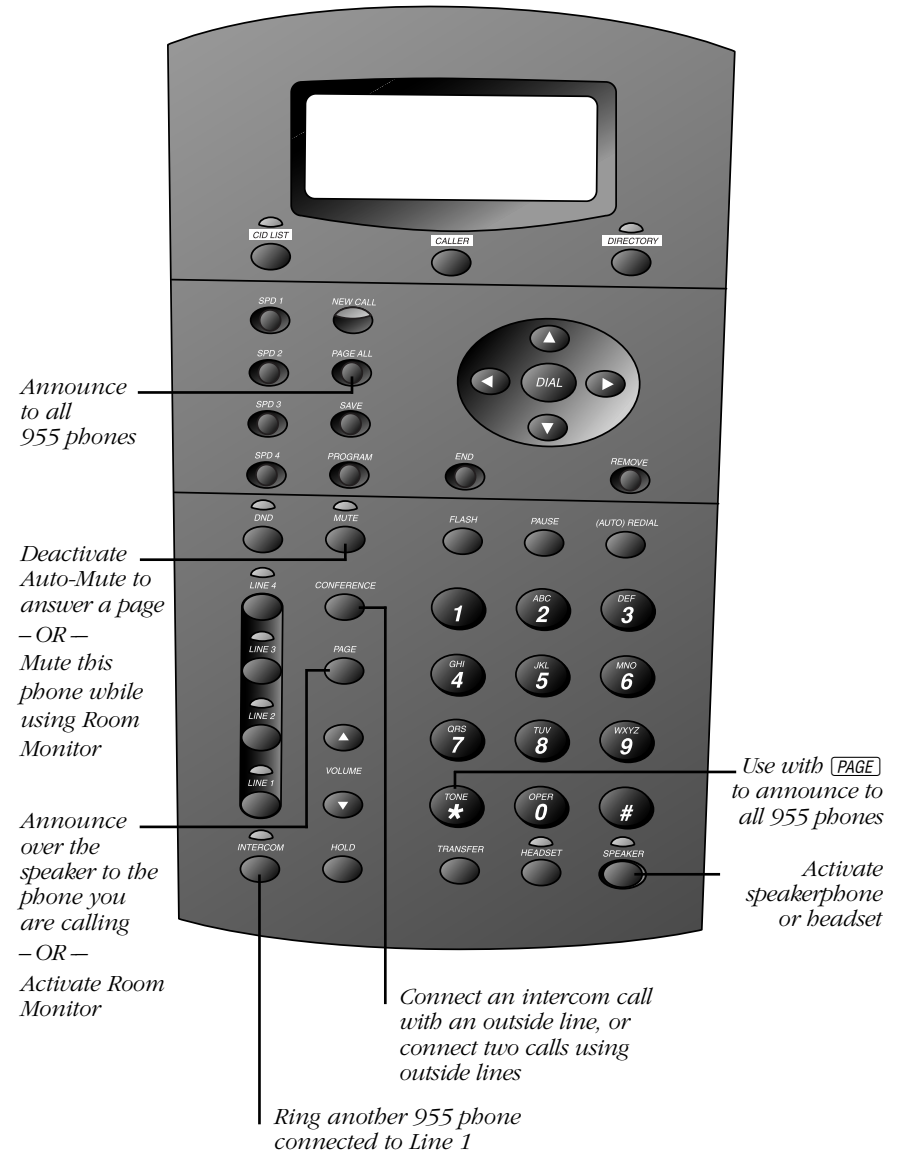

INTERCOM OPERATION

This intercom features both a single-phone page and a system-wide page. A single-phone page alerts only one phone; a system-wide page alerts all phones. Any phone with the Do Not Disturb (DND) feature activated will not receive a page.

An intercom call or single-phone page automatically activates the speakerphone on the receiving phone. You can deactivate the speakerphone by lifting the handset.

NOTE: If a line is in use, pressing **INTERCOM** or **PAGE** will place the line on hold and activate the intercom.

Basic Intercom Operations

- INTERCOM** Any two stations connected to Line 1 can ring each other.
- PAGE** Lets you “announce” over the speaker of the phone you’re calling. The person you’ve called can respond just by talking.
- PAGE ALL** Lets you “announce” to all 955 phones in the system at the same time (system-wide page).
- CONFERENCE** Lets you connect another intercom call with an outside line.

Making an Intercom Call with the Handset

- 1 Press **INTERCOM** and lift the handset. The screen displays:

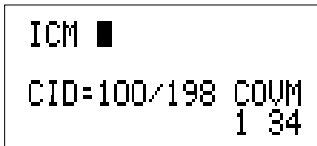

ICM ■
CID=100/198 COUM
1 34

- 2 Dial the extension number of the party you wish to reach. If that extension is idle, you will hear long beeps. If that extension is busy, you will hear a busy signal. If that extension is set to Do Not Disturb, you will hear short beeps.

NOTE: The intercom call is automatically cancelled if you do not dial an extension within 10 seconds.

NOTE: When you direct an intercom call to one extension, any extension in the system can answer the call.

INTERCOM OPERATION

Making an Intercom Call with the Speakerphone or Headset

- 1 Press **INTERCOM**.
- 2 Refer to the screen display and follow **Step 2** under “Making an Intercom Call with the Handset.”

Answering an Intercom Call

When you receive an intercom call you will hear a repeating double-ring pattern and your screen displays **ICM** with the extension number of the caller. Answer the intercom call by lifting the handset, or by pressing **INTERCOM**, **SPEAKER** or **HEADSET** to take the call hands-free.

Making a Single-phone Page

- 1 Press **PAGE**. The screen displays:

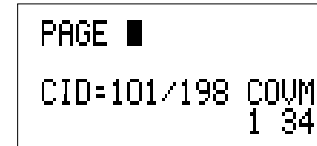

PAGE ■
CID=101/198 COUM
1 34

- 2 Dial the extension number of the party you wish to reach.

Answering a Single-phone Page

Auto-Mute Off

When your extension receives a page, the phone beeps and the speakerphone is automatically activated. Answer the call by simply speaking.

If you are on the headset, you can answer the page by simply speaking through the headset.

Auto-Mute On

The MUTE light will be on. Lift the handset or press **MUTE** to temporarily deactivate Auto-Mute and answer the page.

INTERCOM OPERATION

Switching Between an Intercom Call and a Single-phone Page

When making an intercom call, press **PAGE** to switch the call to a single-phone page.

When making a single-phone page, press **INTERCOM** to switch the call to the intercom.

Ending an Intercom or Page Call

Hang up or press **SPEAKER** or **HEADSET** again.

Paging All Phones

- 1 Press **PAGE ALL**.

— OR —

Press **PAGE** **X-TONE**.

The screen displays:

```
PAGE ALL
CID=101/198 COUM
1 34
```

- 2 Speak toward the telephone or into the headset microphone.
- 3 Press and release **SPEAKER** or **HEADSET** to disconnect.

Answering a System-wide Page

NOTE: Only one extension can answer a system-wide page.

When you receive a system-wide page, your phone beeps and the screen shows the paging extension:

```
PAGE ALL BY 12
CID=101/198 COUM
1 34
```

- 1 Press **PAGE** to answer.
- 2 To end, press and release **SPEAKER** or **HEADSET**.

INTERCOM OPERATION

Making an Intercom Conference Call

- 1 Make or answer a call.
- 2 Press and release **INTERCOM** and enter the extension number of the third party. The line is automatically put on hold.
- 3 After the third party answers, press and release **CONFERENCE**.
- 4 To end an intercom conference call, hang up.

NOTE: You cannot put an intercom conference call on hold.

Room Monitor

You can activate the speaker of another phone to monitor sounds in that room.

- 1 Press and release **PAGE**.
- 2 Enter the extension number of the telephone to be monitored.
- 3 Press and release **MUTE** if you don't want sounds on your end to be heard.
- 4 To end monitoring, press and release **SPEAKER**.

The party at the extension being monitored will hear a beep as with any page, signaling that the speakerphone has been activated.

NOTE: An extension cannot be monitored when Auto-Mute is turned On at that extension.

CALLER ID OPERATION

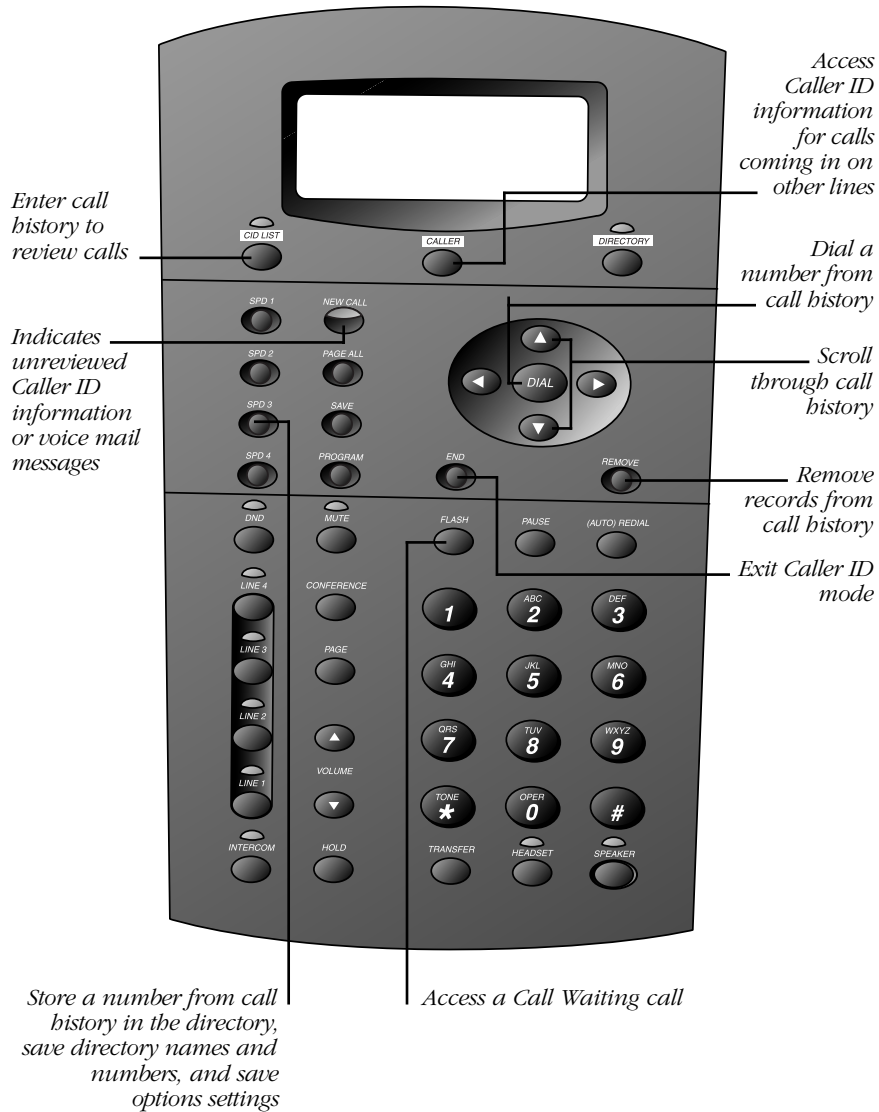

CALLER ID OPERATION

This telephone has a Caller ID feature that works with Caller Identification service provided by your local telephone company; there is a fee for this service, and it may not be available in all areas. This phone can provide information only if both you and the caller are in areas offering Caller Identification service, and if both telephone companies use compatible equipment.

When you use this phone with Caller ID service, you can see who's calling before you answer the phone. If you subscribe to Caller ID with Call Waiting a **combined** service available through many local telephone companies, you can see who's trying to reach you even when you're on another call. This service may be called by different names (such as Caller ID with Visual Call Waiting) by different local telephone companies and may not be available in all areas.

NOTE: You must subscribe to **combined** Caller ID with Call Waiting as a **single** service to see Caller ID information for a Call Waiting call. Check with your local telephone company for availability.

This phone assigns each incoming call a number from 1 to 200. The most recent call will have the highest number. (For example, if two calls have been received, call number 002 is the most recent.) When the call history is full, the oldest call information is automatically deleted to make room for the new incoming call information.

CALLER ID OPERATION

Call Waiting

If you subscribe to Caller ID with Call Waiting service and you receive a Call Waiting call, the screen will display call information for the call.

```
12:08PM 12/26
L2 (CallWaiting)
Smith, John
5550128
```

- 1 Press **FLASH** to access the Call Waiting call.
- 2 To switch back to the original call, press **FLASH** again.

Calls Received on Two or More Lines Simultaneously

Your screen can display the Caller ID information for only one call at a time, but you can switch between the information for two or more ringing lines by pressing **CALLER**.

For example, if Line 3 of the phone is ringing, the screen displays the Caller ID information for Line 3:

```
12:08PM 12/26
L3
Smith, John
5550128
```

If the phone begins to ring on Line 1, the screen will display the new caller's information after it is received:

```
12:08PM 12/26
L1
Brown, Mary
5550127
```

CALLER ID OPERATION

Press **CALLER** to review the Caller ID information for the first call and the screen displays:

```
12:08PM 12/26
L3
Smith, John
5550128
```

Pressing **CALLER** repeatedly will allow you to go back and forth between the general screen display

```
12:08PM 12/26
EXT 22
CID=100/198 COVM
1 34
```

and the Caller ID screens for each of the ringing lines.

Message Waiting and NEW CALL Light

This light stays on steadily when you have received call information but have not yet reviewed it. If you subscribe to a voice mail service, this light flashes when you have unretrieved messages waiting. The screen also displays information about the number of new calls and voice mail messages waiting.

```
12:08PM 12/26
EXT 22
CID=100/198 COVM
1 34
```

CID=100/198 100 **new** Caller ID messages, and 198 **total** Caller ID messages

COVM Voice mail "message-waiting" information on Lines 1, 3, and 4
1 34

CALLER ID OPERATION

Call List

View Call List Summary

- 1 Press **[CID LIST]**. The screen displays the numbers of total calls and new calls in call history.

```
CID LIST
198 Calls
115 New
```

- 2 Press **[▲]** to view the latest or **[▼]** to view the earliest caller's information. Then, use **[▲]** or **[▼]** to scroll through call history. See "Review Call List" for a description of the information provided on the call history screen.

Review Call List

Press **[▲]** to view the previous caller's information
— OR —

Press **[▼]** to view the next caller's information.

The screen displays the caller information:

```
10:27AM 11/12
CL#001 NEW L3
Smith, John
5550128
```

10:27AM 11/12	The time and date call was received
CL#001	This call is the first call (#001) in call history
NEW	This is new, previously unreviewed call information
L3	The call came in on Line 3
Smith, John	Caller's name
5550128	Caller's phone number

CALLER ID OPERATION

Display Messages

Private Name	The other party is blocking name information.
Private Number	The other party is blocking telephone number information.
Unknown Name	Your phone company is unable to receive information about this caller's name.
Unknown Number	Your phone company is unable to receive information about this caller's number.
Error	The Caller ID information received from the phone company was not recognizable.

Removing Calls from Call List

Removing a Specific Call Record from Call List

- 1 Locate the record you wish to delete in call history.
- 2 Press **[REMOVE]**. The screen prompts REMOVE: remove?.
- 3 Press **[REMOVE]** again within three seconds to confirm your decision. The screen displays

```
CL#002
Removed!
```

for two seconds and then displays the next call record in call history.

CALLER ID OPERATION

Removing All Calls from Call List

- 1 Press **[CID LIST]**. The screen displays the numbers of total calls and new calls in the call history.
- 2 Press **[REMOVE]**. The screen prompts REMOVE: all?.
- 3 Press **[REMOVE]** again within three seconds to confirm your decision. The screen displays for two seconds:

```
(empty)

All Removed!
```

and then displays:

```
CID LIST

000 Calls
000 New
```

Dialing a Number from Call List

As you review calls in history, you can dial a displayed phone number. If the call information came from your Home Area Code (the one you programmed during features set up), the screen displays only the seven-digit number you are calling (without an area code). If the call information came from one of your Local Area Codes (the ones you programmed during features set up), the screen displays 10 digits (area code plus the seven-digit phone number). If the call information did not come from any of the area codes you programmed, 1) phone numbers with 10 or more digits will automatically have a "1" inserted and displayed before the number and, 2) phone numbers with fewer than 10 digits will be displayed and dialed without a "1."

- 1 Locate the number you wish to call in call history.
- 2 Press and release **[DIAL]**. The phone will automatically choose an available line and dial the call

— OR —

Press the LINE button for the line you wish to use, then press **[DIAL]** to place the call.

CALLER ID OPERATION

Saving a Number from Call List to the Directory

- 1 Locate the number you wish to store in call history.
- 2 Press **[END]**.
- 3 Press **[DIRECTORY]**. The screen displays DIRECTORY.
- 4 Press **[SAVE]**. The screen prompts (Enter name).
- 5 Press **[CID LIST]** to copy the name and phone number from the call history to the screen.
- 6 Edit the name (See "Changing Directory Entries" in DIRECTORY OPERATION.)
— OR —
Press **[SAVE]** to store the name and move on to edit the number.
- 7 When the name and number appear as you would like to store them, press **[SAVE]** to store the information in the directory. The screen displays Saved!.

Time/Date

If you subscribe to Caller ID service, this phone automatically resets the time and date each time new information is received. You can set the time and date yourself if you wish. (See "Set the Time/Date" in SET UP SYSTEM FEATURES.)

Reset COVM Indicator

This feature is useful in case you get a false COVM signal from the Central Office. If a COVM indicator lights when there are no messages on that line, clear the indicators.

- 1 Press **[PROGRAM]**.
- 2 Press **[▼]** until the screen displays COVM RESET, then press **[▶]**.
- 3 Press **[▼]** or **[▲]** until the screen displays the desired line number, then press **[▶]**. The screen displays:

```
L3 COVM RESET

REMOVE
```

- 4 Press **[REMOVE]** to reset. The screen displays RESET!.
- 5 Repeat **Steps 1-4** to reset the COVM for additional lines.

ADDING A FAX MACHINE

NOTE: Do not connect a fax machine to Line 1. Doing so will interrupt the system's intercom data channel.

You may wish to use a fax machine with your phone. Choose Line 2, 3 or 4 for the fax machine, and connect it according to the manufacturer's instructions for installation and use.

- That line's telephone number is your fax number.
- The same line can be used for outgoing calls (incoming faxes will get a busy signal).
- Set your fax machine to answer on the first ring (follow manufacturer's instructions).
- To prevent the fax line from ringing at all the extensions, turn the ringer off for that line (see "Turn Ringer On or Off" in SET UP SYSTEM FEATURES).

NOTE: If you are using a fax switch, or a fax machine with a built-in fax switch, see "Using a Fax Switch."

Using a Fax Switch

A fax switch lets the system know, before the phone rings, whether an incoming call is a voice call or a fax call. Some fax machines have a built-in fax switch. Using a fax switch may affect the operation of Line-in-use lights and the display of Caller ID information.

IN CASE OF DIFFICULTY

If you have difficulty operating this phone, try the suggestions below. For Customer Service, visit our website at www.telephones.att.com or call 1 800 223-3111. **Please retain your receipt as your proof of purchase.**

Telephone Does Not Ring

- Make sure the Do Not Disturb (DND) feature is not activated.
- Make sure ringers are turned on.
- If there are several non-system phones on the line that don't ring, disconnect some of them. Having too many phones connected can also result in low ringer volume for non-system telephones.
- If the INTERCOM light flashes but you don't hear a paging signal, make sure the Do Not Disturb feature is not activated.

Intercom Paging Signal Not Received

Make sure you have programmed your intercom extension number correctly. Line 1 must be connected at all extensions, and must be the same telephone number/line for Page and Intercom to work properly.

Cannot Join a Conversation in Progress

The privacy feature prevents another set on the system from interrupting a conversation. Make sure you press the LINE button to release privacy.

Error Tone (Fast Busy Signal) Heard When Making an Intercom Call

The Do Not Disturb feature is activated at the extension you are calling. The other party's INTERCOM light will flash and your extension number will be displayed on their screen to alert them of your call.

Line Lights Remain On When No Line is Connected

- Make sure the system is programmed for that line to be absent. (See "Set Line Usage for Each Line" in SET UP SYSTEM FEATURES.)
- Make sure that your Line Groups are programmed properly. (See "Assign the Line Group for this Phone" in SET UP SYSTEM FEATURES.)
- Disconnect all other devices (fax, modem, credit card reader, etc.) from any lines connected to your 955 phone. These devices can interfere with the system's data links.
- Make sure the total length of telephone wiring used in your 955 system is less than 600 feet. If the wiring is longer, you may need to use a special filter device. Call 1 800 222-3111 for information about this filter. You'll need to contact a professional to install this filter.

IN CASE OF DIFFICULTY

Tone Signals Do Not Activate a Remote Device

- Tone signaling does not work during conference calls.
- The phone generates tones of fixed duration, which may not be long enough to activate some devices such as answering machines.

Operation During a Power Failure

This phone will operate during a power failure if a charged battery has been installed. You will be able to dial and answer calls with the handset or headset, but no other features will work until power is restored.

No Caller ID Information While on a Call

- You must subscribe to **combined** Caller ID with Call Waiting as a **single** service to see Call Waiting information.
- Make sure the TEL SET and TEL LINE cords are not reversed.

Display Screen is Blank

Make sure the power cord is connected to both the phone and an electrical outlet not controlled by a wall switch.

No Caller ID Information Received

Caller ID information is transmitted by the telephone company between the first and second rings. Allow your phone to ring at least twice to receive Caller ID information.

NEW CALL Light Flashes

- Make sure you have reviewed all messages on all lines.
- It may be a false indicator from the Central Office. To clear, see “Reset COVM Indicator” in CALLER ID OPERATION.

IN CASE OF DIFFICULTY

Screen Displays COVM

The screen displays COVM when the COVM indicator is turned on for at least one line, whether or not there are messages waiting, and whether or not you have the service.

- If you subscribe to Voice Mail service with your local telephone service provider, but prefer not to display COVM on the screen, turn off the COVM indicator for each line.
- If you do not subscribe to Voice Mail service, turn off the COVM indicator for each line.

See “Turning COVM Indicators On and Off” in SET UP SYSTEM FEATURES.

COVM Line Indicator Remains On

- Make sure you have reviewed all messages on that line.
- You may have received a false signal from the Central Office. To clear, see “Reset COVM Indicator” in CALLER ID OPERATION.

EXPANDING THE 955 SYSTEM

When you combine two or more 955 phones you create an interacting system where phones share lines. You can have up to twelve phones and up to 15 telephone lines. The 955 can be expanded with or without Centrex service.

NOTE: All 955 features work as described earlier in this manual.

Line Groups

When phones share lines, Line-in-use lights let users at different extensions know when a specific line is in use. For accurate Line-in-use lights, the same lines must be connected to each extension in the Line Group, and they must have the same incoming telephone number at each extension.

The chart below shows 12 extensions, each sharing the first three lines, but being assigned to different Line Groups based on other shared or private lines.

		Lines in System					
		L1	L2	L3	L4	L5	L6
Intercom Stations	ICM 11	✓	✓	✓	✓		
	ICM 12	✓	✓	✓		✓	
	ICM 13	✓	✓	✓	✓		
	ICM 14	✓	✓	✓		✓	
	ICM 15	✓	✓	✓	✓		
	ICM 16	✓	✓	✓		✓	
	ICM 17	✓	✓	✓	✓		
	ICM 18	✓	✓	✓		✓	
	ICM 19	✓	✓	✓	✓		
	ICM 20	✓	✓	✓		✓	
	ICM 21	✓	✓	✓	✓		
	ICM 22	✓	✓	✓			✓

EXPANDING THE 955 SYSTEM

Private Lines

You can use the fourth line on each station as a private line. A private line is a telephone number assigned to just one extension.

NOTE: You must program the lines you are using at each extension so that the system knows which lines are shared and which are private (you cannot physically wire lines with different telephone numbers into each unit for Line 4).

The chart below shows 12 extensions, each sharing the first three lines and having its own private line.

		Lines in System														
		L1	L2	L3	L4	L5	L6	L7	L8	L9	L10	L11	L12	L13	L14	L15
Intercom Stations	ICM 11	✓	✓	✓	✓											
	ICM 12	✓	✓	✓		✓										
	ICM 13	✓	✓	✓			✓									
	ICM 14	✓	✓	✓				✓								
	ICM 15	✓	✓	✓					✓							
	ICM 16	✓	✓	✓						✓						
	ICM 17	✓	✓	✓							✓					
	ICM 18	✓	✓	✓								✓				
	ICM 19	✓	✓	✓									✓			
	ICM 20	✓	✓	✓										✓		
	ICM 21	✓	✓	✓											✓	
	ICM 22	✓	✓	✓												✓

CENTREX OPERATION

Setup Checklist

Before expanding your system or installing for Centrex, review the installation checklist. If you have Centrex, contact your local telephone company for further information about Centrex service.

- The phone number for Line 1 must be the same on all phones in order for the Intercom and Page features to work.
- Determine the number of phones that will be on the system.
- Identify the phone that will be the Console phone.
- Identify the private line for the Console phone. The Console phone must have its own private line. This line is not shared with any other phone.
- Follow the regular installation instructions in this manual.
- Enable the Console phone.
- Store the Centrex pickup codes and the seven-digit phone numbers in the directory. See DIRECTORY OPERATION in this manual.

Enabling the Console Phone

Determine which phone will be the Console phone for your system and program the Console following the directions to “Set Your Phone to be the Centrex Console Phone” in SET UP SYSTEM FEATURES. It is recommended that Line 4 of the Console be programmed as a private line, to be sure a line is available for Centrex access.

Console Operation

Once another 955 phone has enabled its delayed ring, the Console phone will receive those calls. All the 955 features work in the same manner as described in this manual.

The Console phone can pick up other Centrex lines through Centrex switching. The Console can store the Centrex pickup codes and the seven-digit phone number of each station, except for the Console phone, in the directory.

CENTREX OPERATION

Setting Ring Delay Duration

This feature allows other 955 telephones' calls to ring at the Console phone. After a specified ring delay, the calls will ring at the Console phone. See “Program the Centrex Console Delayed Ring Time” in SET UP SYSTEM FEATURES for directions.

Answering a Delayed Ring

The Console phone rings and the screen displays the station number of the intercom sending the delayed ring.

- 1 Select a free line.
- 2 Enter the Centrex pickup code.
- 3 Enter the seven-digit phone number of the station sending the delayed ring.

*NOTE: If the Console is using another line and receives a delayed ring, the Console phone can put the other line on hold and follow **Steps 1–3**. If the Console is on an intercom call, the intercom call should be ended before picking up the ringing phone.*

Picking Up Another Station's Line

- 1 Choose a free Centrex line.
- 2 Enter the Centrex pickup code.
- 3 Enter the seven-digit phone number of the line you want.

- ▲ 5, 15-17, 19, 36, 48
- ▼ 5, 15-17, 19, 36, 48
- ◀ 5, 32, 34, 37
- ▶ 5, 15-17, 19, 32, 34, 37
- All Removed! 38, 50
- AM/PM 16
- AREA CODEs 7, 20
- (AUTO REDIAL)** 26, 31, 35
- Auto Redial 26
- Auto-Mute 6, 19, 39, 41, 43
- Call history 44, 45, 48-51
- Call List 20, 48-51
- Call Privacy 24
- Call Waiting 3, 4, 44-46
- (CALLER)** 46, 47
- Caller ID 3, 4, 7, 19, 34, 45-47, 49, 51
- Caller ID with Call Waiting 3, 4, 45, 46
- Caller ID with Visual Call Waiting 45
- Caller Identification 4, 45
- Central Office Voice Mail 4
(see also COVM)
- Centrex 4, 7, 18, 56, 58, 59
- Centrex Console Delayed Ring Time
21, 59
- Centrex pickup codes 58
- Centrex service 4, 56, 58
- CID 4, 47, 48, 50
- (CID LIST)** 48, 50, 51
- (CONFERENCE)** 28, 43
- Conference calls 28, 54
- CONSOLE 20
- Console phone 7, 20, 21, 58, 59
- COVM 4, 6, 17, 18, 47, 51, 55
- COVM indicator 6, 17, 51, 55
- COVM ON/OFF 6, 17
- COVM RESET 6, 51
- CSL DELAY RING 7, 21
- DATE 16
- DAY OF WEEK 16
- Default settings 7, 15, 21
- DELAY RING 6, 18
- (DIAL)** 32, 37, 50
- Dial mode 6, 19
- (DIRECTORY)** 31, 34, 51
- Directory 19, 23, 30, 31, 33-37, 44,
51, 58
- DIRECTORY 31, 34, 51
- DIRECTORY FULL! 34
- Display Language 16
- (DND)** 25
- DND 4, 7, 25, 40, 53
- DND light 25
- Do Not Disturb (see DND)
- (END)** 5, 15, 51
- <Enter name> 31, 51
- <Enter number> 31
- Error 49
- EXTENSION NO 6, 16
- Extension number 3, 6-8, 16, 29, 40, 41,
43, 53
- (FLASH)** 6, 27, 35, 46
- Flash 27, 33, 35
- FLASH TIME 6, 19
- Handset/Speakerphone/Headset
Volume 25
- (HEADSET)** 5, 6, 23, 24, 26, 41, 42
- Headset 22-27, 29, 39, 41, 42
- (HOLD)** 27, 28
- Hold 6, 22, 24, 25, 27, 28, 40, 43, 59
- HOLD REMINDER 6, 20

- Home Area Code 4, 5, 20, 50
- HOURL 16
- ICM 40, 41
- Initializing 10, 13
- (INTERCOM)** 27, 40-43
- Intercom 3, 7, 18, 25, 27, 28, 39-43, 52,
53, 56-59
- Intercom conference call 43
- INTERCOM light 25, 53
- LANGUAGE 6, 15, 16
- LINE GROUP 6, 19
- Line Group 5, 6, 19, 53, 56
- LINE light 25
- LINE USAGE 6, 18, 53
- Line-In-Use lights 22, 25, 52, 56
- Local Area Code 5, 7, 20, 50
- Memory (see Directory)
- Message Waiting and NEW CALL
Light 47
- MINUTES 16
- MONTH 16
- (MUTE)** 19, 27, 41, 43
- Mute (see also Auto-Mute) 22, 27, 39
- MUTE light 27, 41
- Navigation buttons 5, 15, 37, 38
- NEW CALL light 47, 54
- No Entries for 36
- (PAGE)** 27, 39-43
- Page 3, 19, 25, 39-43, 53, 58
- (PAGE ALL)** 40, 42
- PAGE ALL 42
- (PAUSE)** 35
- Pause 33, 35
- POWERFAIL 10, 12
- PRIME LINE 6, 18
- Prime Line 5, 6, 18, 23
- Private Line 3, 23, 57, 58
- Private Name 49
- Private Number 49
- (PROGRAM)** 15-21, 51
- Redial 22, 26
- (REMOVE)** 21, 32, 38, 49-51
- Remove 30, 32, 33, 38, 44, 49, 50
- REMOVE 21, 51
- REMOVE: remove? 32, 38, 49
- Removed! 38, 49
- RESET ALL!!! 7
- RESET ALL? 21
- RESET! 21, 51
- Ring Time 21, 59
- Ringer 6, 17, 22, 26, 52
- RINGER ON/OFF 6, 17
- RINGER TYPE 6, 17
- Ringer volume 26, 53
- Room Monitor 39, 43
- (SAVE)** 5, 15-21, 31, 32, 34, 35, 37, 51
- SAVE? 34, 35
- Saved! 31, 35, 37
- Single-phone Page 40, 41, 42
- SPD button 31, 32
- (SPEAKER)** 5, 6, 23, 24, 26, 41-43
- SPEAKER light 23
- Speakerphone 22-27, 29, 39-41, 43
- Speed Dial locations 30, 31
- Switchhook flash 33, 35
- System-wide page 40, 42
- (XTONE)** 28, 32, 35, 37
- Temporary Tone 22, 28, 35
- Three-Way Calling 27

INDEX

TIME/DATE 6, 16, 51

Timer 24

TO NE/PULSE 6, 19

TRANSFER 29

Transfer 29

Transferred call 7, 29

Unknown Name 49

Unknown Number 49

Voice Mail (see also COVM) 4, 6, 17, 44,
47, 55

Volume ▲ 25, 26

Volume ▼ 25, 26

Activate Room Monitor

Press and release **[PAGE]**, then dial the extension of the phone to be monitored.

End Monitoring

Press and release **[SPEAKER]**.

CALLER ID OPERATION (pages 44-51)

Access a Call Waiting Call

Press **[FLASH]**. Press **[FLASH]** again to return to the original call.

Alternately Display Caller ID Information for More than One Call

Press **[CALLER]**.

View the Call List

Press **[CID LIST]**. Use **▲** and **▼** to scroll through call history.

Remove a Specific Call Record from Call List

Locate the record in call history. Then press **[REMOVE]** twice.

Remove All Calls from Call List

Press **[CID LIST]**. Then press **[REMOVE]** twice.

Dial a Number from Call List

Locate the number in call history. Then press and release **[DIAL]**.



Four-Line Intercom Speakerphone 955

Quick Reference Card

TELEPHONE OPERATION (pages 22-29)

Make/Answer a Call

Lift handset or press **[SPEAKER]** or **[HEADSET]**.

Handset/Headset/Speakerphone Volume

Press VOLUME **▲** or **▼** while on a call.

Adjust Ringer Volume

Press VOLUME **▲** or **▼** while line is ringing.

Redial

Lift the handset and listen for the dial tone, then press **[AUTO REDIAL]**

–OR–

Press **[AUTO REDIAL]** to use the speakerphone or headset.

Auto Redial

Press **[AUTO REDIAL]** twice to activate. When you hear the other line ring or the other party answers, lift the handset or press **[SPEAKER]** or **[HEADSET]** to complete the call. To cancel Auto Redial, press any key on the phone (except Volume **▲** or **▼**).

Hold

Press and release **[HOLD]**. To release hold, press and release the LINE button of the call on hold.

Switch Between Lines

Press and release **[HOLD]** on first line, then press another LINE button to make or answer another call.

Mute

Press and release **[MUTE]**. To return to the conversation, press and release **[MUTE]** again.

Telephone Subscriber Services

Press **[FLASH]** instead of the switchhook.

Temporary Tone Dialing

Dial the number. Press and release **[X-TONE]**. Buttons pressed after this send touch tone signals.

Make a Conference Call

Place the first call on hold, then dial the third party. When this call is answered, press **[CONFERENCE]** to begin the conference call.

Transfer a Call to Another System Phone

Press **[TRANSFER]**, dial the extension where you're transferring the call, then hang up.

SPEED DIAL OPERATION (pages 30-32)

Store Names/Numbers

Press **[DIRECTORY]**, **[SAVE]**, then follow screen prompts. Use dial pad keys to enter the name and number. Press **[▶]** to move to the next character and **[◀]** to backspace. Press **[▶]** twice to insert a space. Press **[PAUSE]** to enter a three-second pause in the dialing sequence. Press **[FLASH]** to store a switchhook flash. Press the SPD button where you wish to store the name or number.

Review Speed Dial Entries

Press a SPD button to see the entry displayed on screen. To change the entry press **[X-TONE]** and use **[◀]**, **[▶]** and the dial keypad to edit the name. Press **[SAVE]** to save the name and move on to edit the number. Press the SPD button where you wish to save the entry.

Make a Speed Dial Call

Press the SPD button for the desired number. Press **[DIAL]** to place the call.

Remove a Speed Dial Entry

Press the SPD button of the number you wish to remove and press **[REMOVE]** twice.

DIRECTORY OPERATION (pages 33-38)

Enter Directory Mode

Press **[DIRECTORY]**.

Store Names/Numbers

Press **[SAVE]**, then follow the screen prompts. Use dial pad keys to enter the name and number. Press **[▶]** to move to the next character and **[◀]** to backspace. Press **[▶]** twice to insert a space. Press **[PAUSE]** to enter a three-second pause in the dialing sequence. Press **[FLASH]** to store a switchhook flash.

Review Directory Entries

Press **[▲]** or **[▼]** to scroll through entries.

To change a directory entry, locate the entry, then press **[X-TONE]** and use **[◀]**, **[▶]** and the dial key pad to edit the name. Press **[SAVE]** to save the name and move on to edit the number. Press **[SAVE]** to store the name and number.

Dial a Directory Number:

Locate the desired entry, then press **[DIAL]**.

Remove a Directory Entry

Locate the entry and press **[REMOVE]** twice.

Remove All Directory Entries

Press **[REMOVE]** twice after entering Directory mode.

INTERCOM OPERATION (pages 39-43)

Make an Intercom Call

Press **[INTERCOM]** and lift the handset

– OR –

press **[SPEAKER]** or **[HEADSET]**. Dial the extension number you wish to reach.

Answer an Intercom Call

Lift the handset

– OR –

press **[INTERCOM]**, **[SPEAKER]** or **[HEADSET]** when you hear the double-ring.

Make a Single-phone Page

Press **[PAGE]** and dial the extension you wish to reach.

Answer a Single-phone Page

Speak after the beep. (If the MUTE light is on, you must lift the handset or press **[MUTE]** first.)

Page All Phones

Press **[PAGE ALL]** or **[PAGE]** **[X-TONE]** and speak toward the telephone.

Answer a System-wide Page

Press **[PAGE]** when you hear the beep.

Make an Intercom Conference Call

Make or answer a call to the first party. Then press and release **[INTERCOM]** and dial the next party's extension. When this call is answered, press and release **[CONFERENCE]** to begin the three way conversation.