

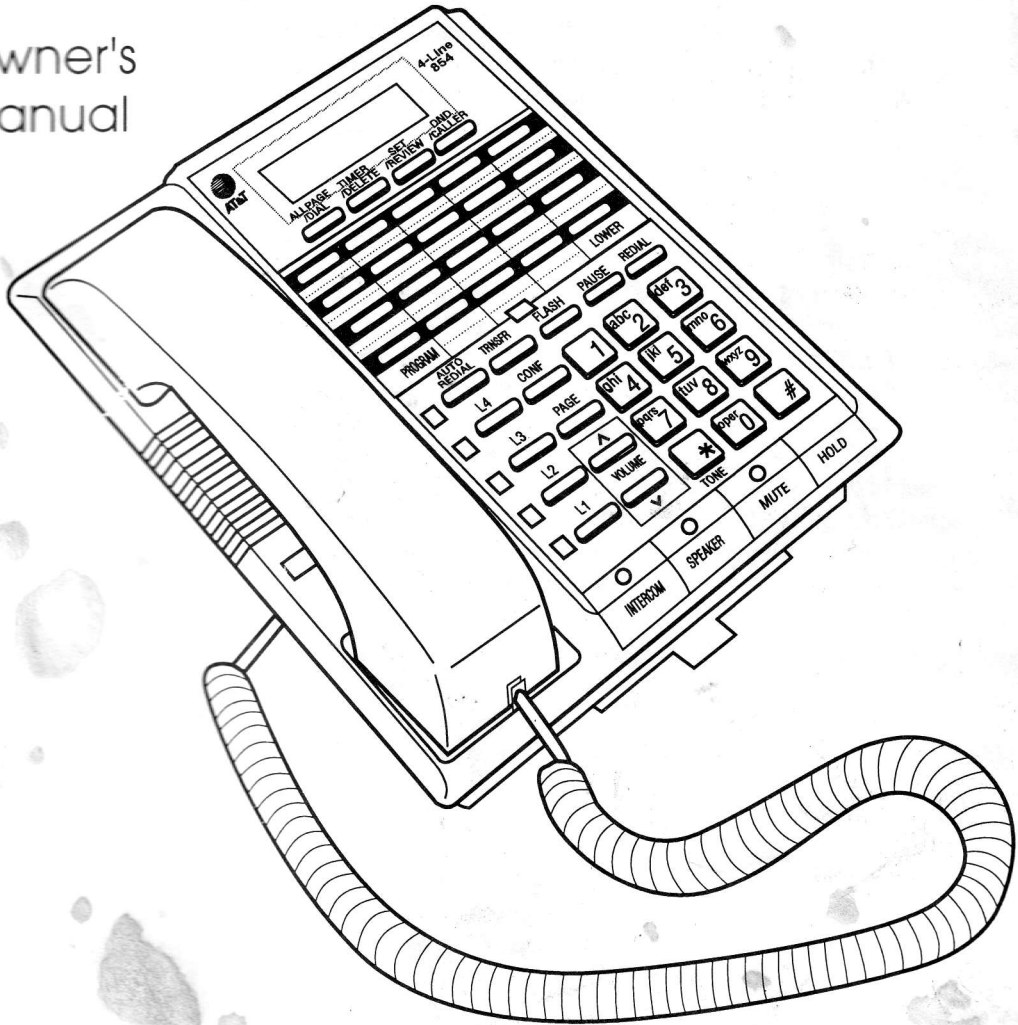

# 854 4-Line Intercom/Speakerphone

Owner's  
Manual



# 4-Line 854 Features

## Introducing the 4-Line Intercom/Speakerphone 854

We've designed the 854 to be simple to install and easy to use. It provides many of the same advanced features of much larger systems, but without the expense of a controller, and without the need for extensive rewiring.

The 854, when used with the 843A Call Display Server, has features designed to make using Call Identification Service convenient to use. The 843A server allows display of incoming caller's telephone number, as well as review, storage and dialing of past numbers.

## Expandability

Your 854 telephone offers a variety of communication possibilities for both home and office. When you combine two or more 854 telephones you create an interacting system. In this system each 854 phone is called a station. You can have up to twelve 854 phones with up to eight telephone lines.

## Features

### The 854 provides you with the following features:

4-Line capability	36 Number Memory Dialing
Display	18 One-Touch dialing
Redial and Auto Redial	18 Two-Touch dialing
Hold	Do Not Disturb
Ability to Switch Between Lines	Mute
3-Party Conference Calling	Desk/Wall Mount
Speakerphone for hands-free talking	Hearing Aid Compatibility
Speakerphone, Handset and Ringer	Volume Control
Line Status for non-system phones	

### *Intercom capabilities when you combine two or more 854 phones.*

Intercom Ring	Room Monitor
Intercom Voice (Page)	Call Transfer
Intercom All Page	Intercom Conference Call

## Line Privacy

To assure the privacy of your telephone conversations, only one 854 at a time can be used on each line, unless you easily override Line Privacy with the press of a button.

Line Privacy applies only to 854 telephones. If you have other telephones connected to Line 1, Line 2, Line 3, or Line 4 those phones can use those lines anytime.

# Safety Information



## Important Safety Instructions

Always follow basic safety precautions when using this product to reduce risk of injury, fire, or electric shock.

- 1 **Read and understand all instructions** in this manual.
- 2 **Follow all warnings** and instructions marked on the product.
- 3 **Unplug this product from the wall outlet before cleaning.** Do not use liquid cleaners or aerosol cleaners, use a damp cloth for cleaning.
- 4 **Do not use this product near water**, for example, near a bath tub, wash bowl, kitchen sink, or laundry tub, in a wet basement, or near a swimming pool.
- 5 **Do not place this product on an unstable cart, stand, or table.** The product may fall, causing serious damage to the product.
- 6 **Slots and openings in the cabinet and the back or bottom are provided for ventilation**, to protect it from overheating, these openings must not be blocked or covered. The openings should **never be blocked** by placing the product on the bed, sofa, rug, or other similar surface. This product should never be placed near or over a radiator or heat register. This product should not be placed in a built-in installation unless proper ventilation is provided.
- 7 **This product should be operated** only from the type of power source indicated on the marking label. If you are not sure of the type of power supply to your home, consult your dealer or local power company.
- 8 **Do not allow anything to rest on the power cord.** Do not locate this product where the cord will be abused by persons walking on it.
- 9 **Do not overload wall outlets** and extension cords as this can result in the risk of fire or electric shock.
- 10 **Never push objects of any kind into this product through cabinet slots** as they may touch dangerous voltage points or short out parts that could result in a risk of fire or electric shock. **Never spill** liquid of any kind on the product.
- 11 **To reduce the risk of electric shock, do not disassemble this product, but take it to a qualified service man** when some service or repair work is required. Opening or removing covers may expose you to dangerous voltages or other risks. Incorrect reassembly can cause electric shock when the appliance is subsequently used.
- 12 **Unplug this product from the wall outlet and refer servicing to qualified service personnel under the following conditions:**
  - A. When the power supply cord or plug is damaged or frayed.
  - B. If liquid has been spilled into the product.
  - C. If the product has been exposed to rain or water.
  - D. If the product does not operate normally by following the operating instructions. Adjust only those controls, that are covered by the operating instructions because improper adjustment of other controls may result in damage and will often require extensive work by a qualified technician to restore the product to normal operation.
  - E. If the product has been dropped or the cabinet has been damaged.
  - F. If the product exhibits a distinct change in performance.
- 13 **Avoid using a telephone (other than a cordless type) during an electrical storm.** There may be a remote risk of electric shock from lightning.
- 14 **Do not use the telephone to report a gas leak** in the vicinity of the leak.

**SAVE THESE INSTRUCTIONS**

# Features

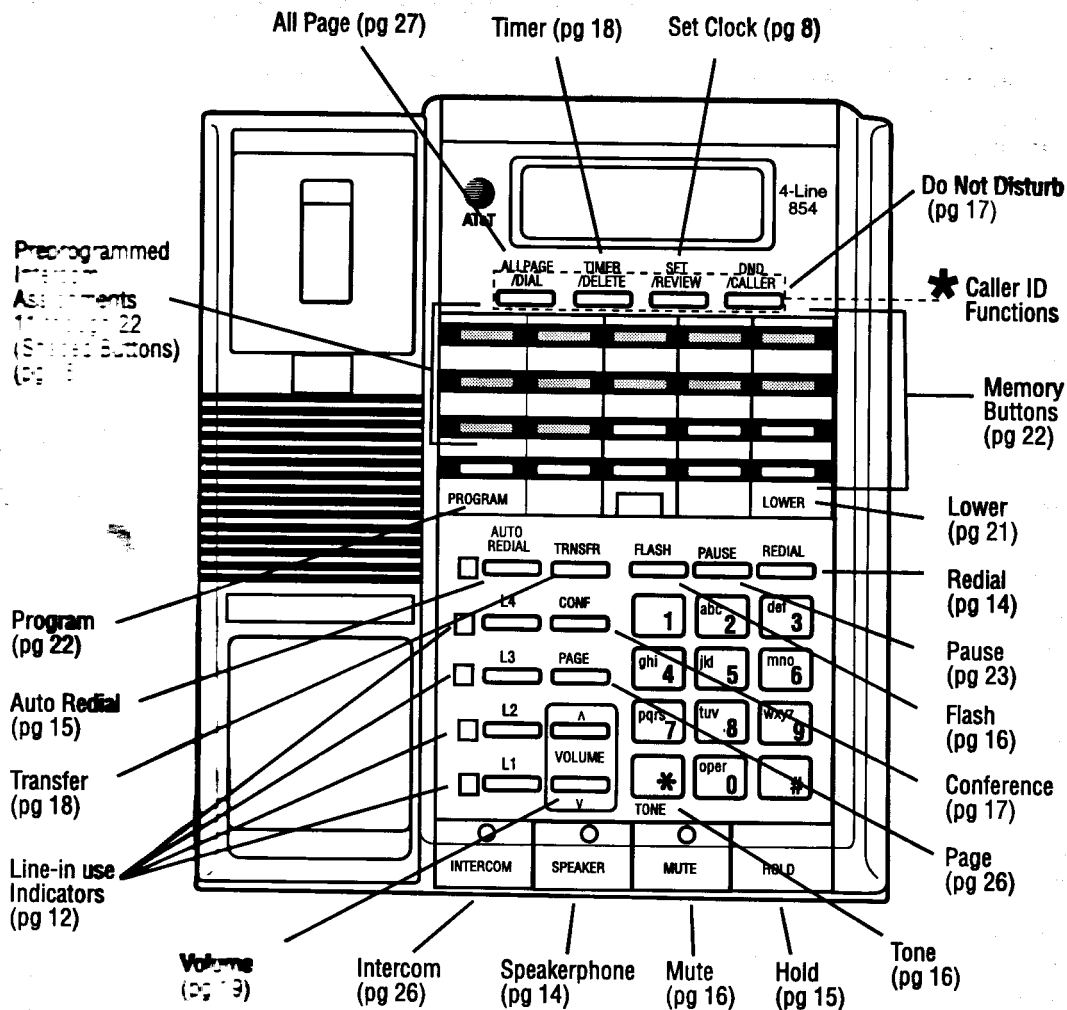

\* These buttons are used with the 843A Call Display Server and Call Identification Services

# Table of Contents

<b>Important Safety Information</b>	
<b>Features top and side</b>	
<b>Setting up your system</b> .....	<b>1</b>
Parts checklist .....	2
Setting up your new system .....	3
Desk/Table installation .....	4
Wall mount installation .....	6
Assigning intercom numbers .....	7
Setting clock and calendar .....	8
Setting dial mode .....	9
Setting up for only two or three lines .....	9
Setting up a private line .....	10
Changing BATTERY Display .....	10
<b>Operation</b> .....	<b>11</b>
Indicator lights and display messages .....	12
Making and answering a call .....	13
Call Privacy .....	13
Using the Speakerphone .....	14
Using Redial .....	14
Auto Redial .....	15
Using Hold .....	15
Switching between lines .....	15
Using Mute .....	16
Using Flash .....	16
Using Tone .....	16
Making a 3-party conference call .....	17
Using Do Not Disturb .....	17
Transferring a call .....	18
Answering a transferred call .....	18
Monitoring the length of a call .....	18
Adjusting Ringer Volume .....	19
Adjusting Volume .....	19
<b>Memory Dialing</b> .....	<b>20</b>
Memory features .....	21
One-Touch Dialing .....	22
Store in <b>memory</b> .....	22
Dial .....	22
Two-Touch Dialing .....	22
Store in <b>memory</b> .....	22
Dial .....	22
Special Memory Features .....	23
Dialing long phone numbers ....	23
Erasing a stored number .....	23
Entering a <b>dialing</b> delay .....	23
Storing <b>temporary</b> tone signal in <b>memory</b> .....	23
Storing a switchhook Flash in <b>memory</b> .....	23
<b>Intercom Operation</b> .....	<b>24</b>
What you <b>should</b> know about the intercom .....	25
Making and answering an intercom call or page .....	26
Paging a <b>line</b> .....	27
Answering an ALLPAGE .....	27
Monitoring a room .....	27
Making an intercom conference call .....	28
Determining your intercom number ..	28
<b>Appendices</b> .....	<b>29</b>
In Case of Difficulty .....	30
Using <b>other</b> telephones with your 854 .....	32
Expanding your 854 system .....	33
Centrex operation .....	34
<b>AT&amp;T Limited Warranty and Maintenance Information</b> ....	<b>37</b>
<b>FCC Information</b> .....	<b>38</b>
<b>Index</b> .....	<b>39</b>
<b>Service Return Form</b> .....	<b>40</b>
<b>Quick Reference</b> .....	<b>back cover</b>

# Setting Up Your System

## Page

## SECTION

# 1

# 1

2	Parts checklist
3	Setting up your new system
4	Desk/Table installation
6	Wall-mount installation
7	Assigning intercom numbers
7	Installing intercom number card
8	Setting clock and calendar (12 or 24 hour display)
9	Setting dial mode
9	Setting up for two or three lines
10	Setting up a private line
10	Changing BATTERY display

**C**ongratulations on your purchase of the new 4-Line 854 Telephone. This design meets the exacting standards of AT&T for convenient, reliable service. To get the most from your system, take time to read through this manual carefully. It explains in simple steps how to install, use and care for your 4-Line 854.

### *Installation at a Glance*

- Be sure to read page 7 if you are installing this system for the first time.
- Installing for Desk or Wall Mount.
- Setting the Clock and Calendar.
- Assigning Intercom Numbers.
- Setting Up for Two or Three Lines.
- Creating Private Lines.
- Changing BATTERY message.

# Parts Checklist

**1**

Every 4-Line 854 telephone should include the following components:

- 1 Telephone
- 2 Handset
- 3 Coiled handset cord
- 4 (1) 8" Black telephone line cord  
(2) 7' Black telephone line cord
- 5 AC adapter
- 6 Quick Reference Card (installed)  
The Quick Reference Card Cover holds a two-sided Quick Reference Card. Be sure to leave it in the phone.
- 7 4 AA Heavy Duty Batteries

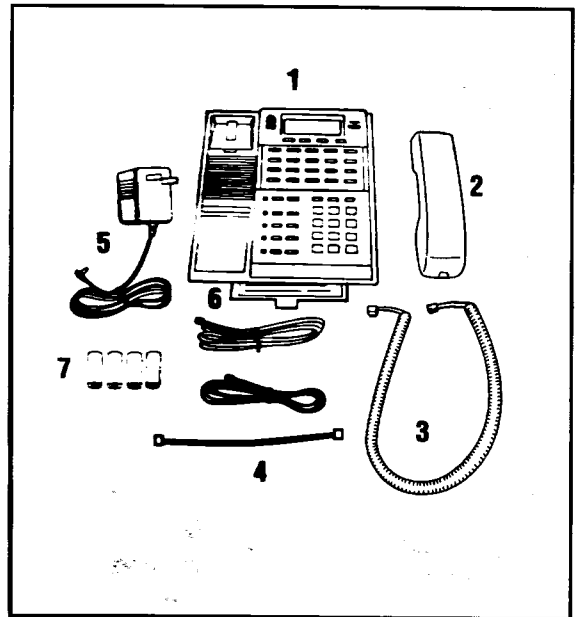

**C**heck the list to **make sure** you have all the correct **parts** included with the telephone you purchased. **You should** save your protective packaging materials to reuse if you move or need to ship a telephone.

We have provided all necessary parts. However, if you **need** additional parts to modernize or expand your telephone wiring, AT&T offers a complete line of do-it-yourself **products** - including jacks, cords and adapters - to **make any** job quick, safe and inexpensive. Ask for them where you purchased your 4-Line 854, or call 1 800 222-3111.

## DIAL MODE

This telephone has a selectable push-button dial and will work with either tone or rotary telephone service. You can set it to work directly with long distance or certain other services that require tone signaling, including some tone activated computer systems.

This telephone is hearing-aid compatible.

# Setting Up Your New System

## Installation Checklist

- Line 1's phone number must be **the same** on all phones in order for the Intercom and Paging features to work.
- Make sure you have an **electrical outlet** and a modular telephone jack near the place where you've chosen to install your phone.
- Avoid installing your phone in **locations exposed to** excessive heat or moisture, which may cause **deterioration** of the unit's electronic circuitry.
- Identify the number of **phone lines you will use**.
- Assign a different Intercom Extension Number, from **11** through **22**, to each 854 telephone. This must be done at **each** telephone individually.
- Decide if you want a private line. A **private line** is a line that doesn't appear on all phones.

## Caution

- Your telephone will not work during an electrical power failure, but will retain memory. It is recommended you have available a non-854 telephone to use.
- Total length of telephone wire used in your system is important. If the total length of telephone wire is over 600 feet, you may need to use a special filter device. This device is available through the National Service Center, 1 800 222-3111. Professional installation is required. AT&T is not responsible for installing the device.
- Never install telephone wiring during a lightning storm.
- Never install a telephone jack in a wet location unless you have a jack specifically designed for wet locations.
- Never touch uninsulated telephone wire or terminals unless you disconnect the incoming telephone line at the network interface.
- Use caution when installing or modifying telephone lines.
- **DO NOT** attach (staple, etc.) the AC power adapter to the building wall.



# Desk/Table Installation

1

## 1 Install Batteries

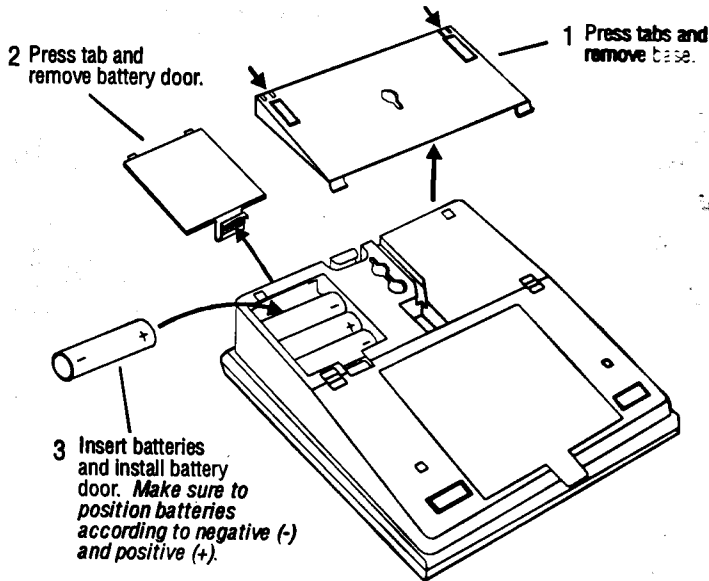

Replace the heavy duty batteries once a year. When the Low Battery Indicator is on and the batteries are low, BATTERY flashes in the display.

**NOTE:** The batteries retain memory during an electrical power failure. If a power failure occurs your phone will not work. It is recommended you have a non-854 phone available to use.

## 2 Connect Line Cords

Follow one of the three options below and on the next page.

Four wall jacks for four phone lines.

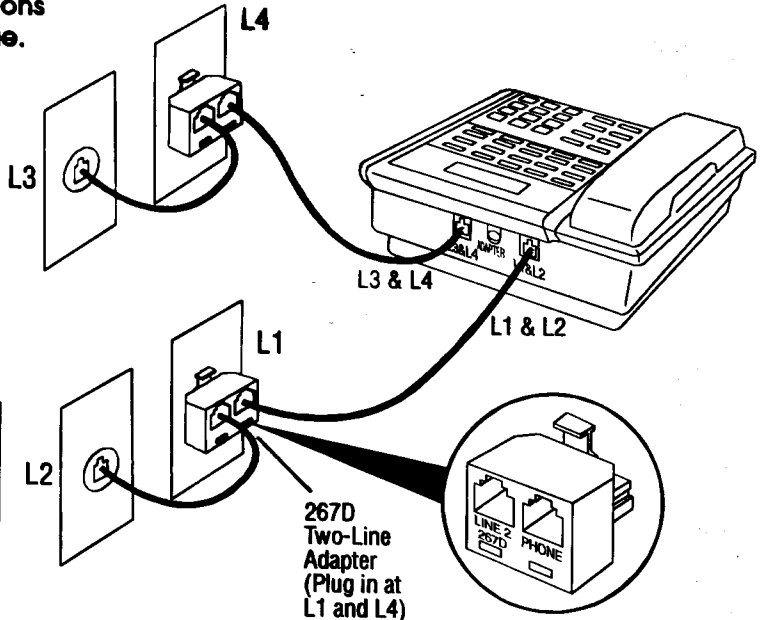

**NOTE:** If your phone rings when first plugged in, you need to set the intercom number for the phone.

See page 7 to assign an intercom number.

# Desk/Table Installation

1

Two wall jacks with four phone lines.

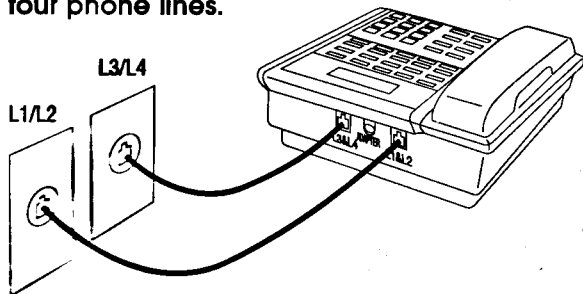

Three wall jacks with four phone lines.

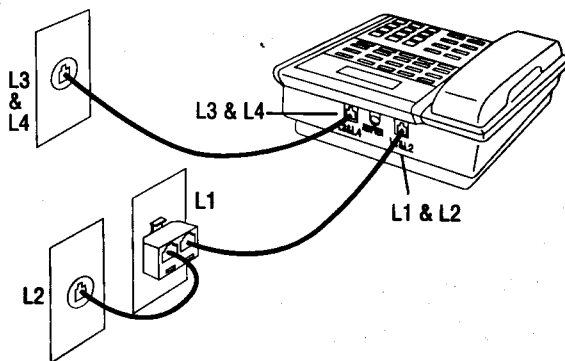

## 3 Connect AC and Handset Cords

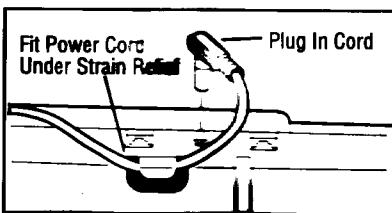

2 Connect A.C. power cord to phone and wall outlet.

3 Check for dial tone.

1 Connect coiled cord to phone and handset.

4 Check Display.



You should use only the power cord supplied with your phone. If you need a replacement call the AT&T National Sales and Service Center at 1 800 222-3111.

# Wall Mount Installation

1

## 1 Reverse Handset Tab and Connect Cords

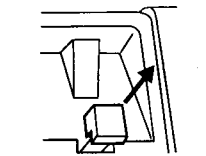

Pull tab away and hold.

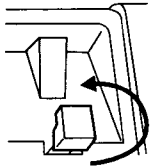

Rotate tab 180 degrees.

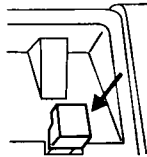

Release tab.

1 Reinstall base for wall mount.

1 Press Tabs and remove base.

2 Rotate base 180 degrees.

3 Install base.

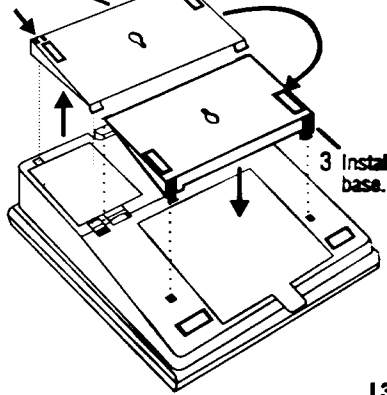

2 Connect line cords and AC adapter to phone. See pages 4 and 5 to connect cords to wall.

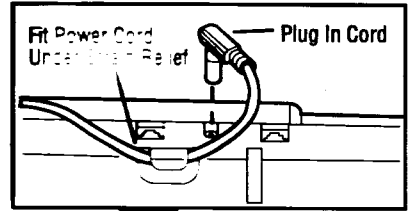

Fit Power Cord Under the Panel

Plug In Cord

L3 & L4

L1 & L2

## 2 Mount Phone to Wall

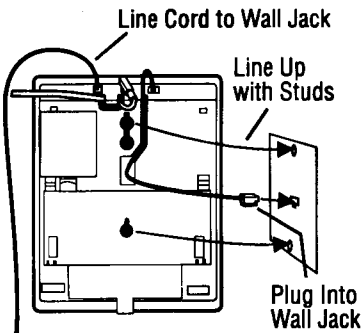

If you have **THREE** wall jacks, mount the phone on to a wall jack not using an adapter. (See page 5.)

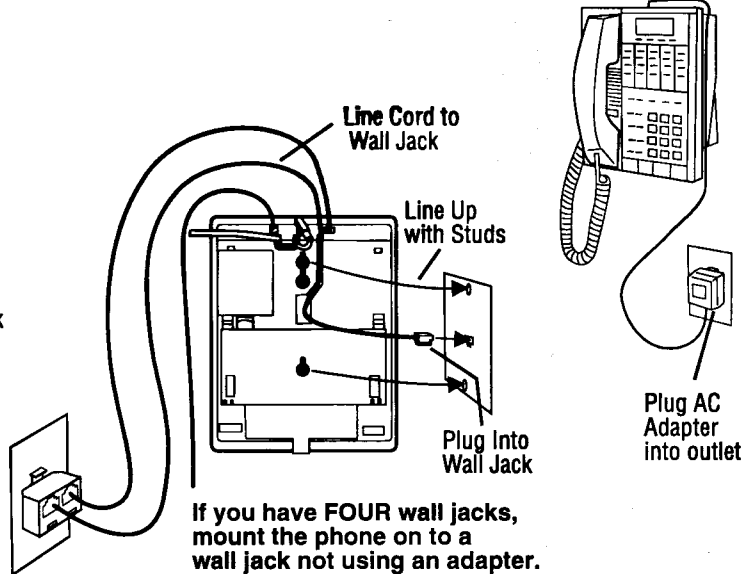

If you have **FOUR** wall jacks, mount the phone on to a wall jack not using an adapter. (See drawing above and page 4.)

# Setting Up Your Phone

## Assigning Intercom Numbers

- 1 Press **PROGRAM**.
- 2 Press **\***.
- 3 Press **#**.
- 4 Enter 2 digits (11 through 22).
- 5 Press **INTERCOM**. After a successful assignment you will hear a confirmation ring.

**NOTE:** If you duplicate an intercom number a continuous warning tone occurs. Repeat steps 1-5 and select a different number.

## Do Not Lift Handset

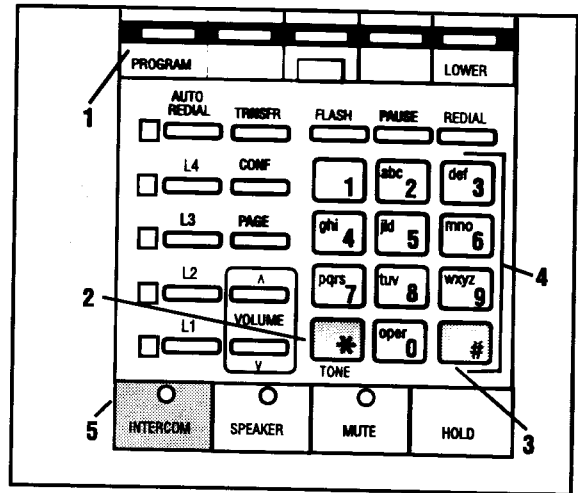

1

## Install Intercom Number Card

- 1 Insert an open end of a paper clip into the hole of the intercom number card cover.
- 2 Pry the cover **up** and remove.
- 3 Write the intercom number on the card and replace the card.
- 4 Replace the **number** card and cover.

## Do Not Lift Handset

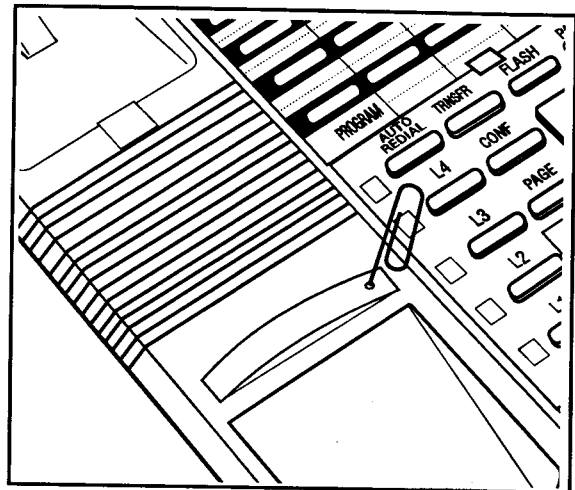

# Setting Up Your Phone

1

## Setting Clock and Calendar

The time and date appear on the display screen when the phone is not in use. You can reset the clock and calendar at any time. You can set the clock to display time in a 12 or 24 hour format.

### 12 hour AM/PM

- 1 Press **SET/REVIEW**  
zeroes appear on the display.
- 2 Set AM or PM  
Press \* for AM  
Press # for PM
- 3 Set the Month (2 digits)  
Press 01 for January  
Press 12 for December
- 4 Set Day of Month (2 digits)  
Press 01 for the first day  
Press 31 for the last day
- 5 Set the week day (1 digit)  
1 = SUN 4 = WED 7 = SAT  
2 = MON 5 = THU  
3 = TU 6 = FRI
- 6 Set the Hour (2 digits)  
Press 01 for 1 O'clock  
Press 12 for 12 O'clock
- 7 Set the Minute (2 digits)  
Press 00 to 59 for minutes

### 24 Hour (European/Military)

- 1 Press **SET/REVIEW**
- 2 Set Day of Month
- 3 Set Month
- 4 Set day of week
- 5 Enter 2 digits for hour
- 6 Enter 2 digits for minutes

**NOTE:** You will hear a confirmation tone if you entered the data correctly. If you make a mistake, press **SET /REVIEW** again and start over.

### Do Not Lift Handset

4-Line 854

ALL/PAGE /CALL TIMER /DELETE SET /REVIEW DND /CALLER

Press to set clock and calendar

---

### 12 hour display

8 indicates August 31 indicates minutes

14 indicates 14th day 2 indicates 2 o'clock

FR indicates day of week R indicates AM

---

### 24 hour display

8 indicates August 31 indicates minutes

14 indicates 14th day 2 indicates 2 o'clock

FR indicates day of week

# Setting Up Your Phone

## Setting Dial Mode

- 1 Press **PROGRAM**.
- 2 Press **\***.
- 3 Press **#**.
- 4 Press **\***.
- 5 Enter one digit.  
2 = TONE  
3 = PULSE
- 6 Press **MUTE**. You will hear a confirmation ring if you entered the data correctly.

## Do Not Lift Handset

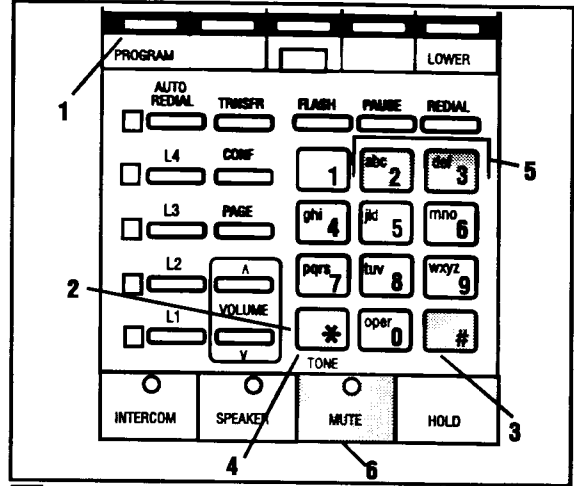

To set the dial mode, you need to program the phone to either touch tone (2) or rotary (3). Make sure you choose the correct dialing method. Touch tone dialing will not work if you have dial pulse (rotary) service.

## Setting Up for Only Two or Three Lines

- 1 Press **PROGRAM**.
- 2 Press **\***.
- 3 Press **#**.
- 4 Enter one digit for the line number.  
2 = L2  
3 = L3  
4 = L4
- 5 Enter one digit.  
0 = turn OFF line status  
1 = turn ON line status
- 6 Press **TRANSFER**. You will hear a confirmation ring if you entered the data correctly.

## Do Not Lift Handset

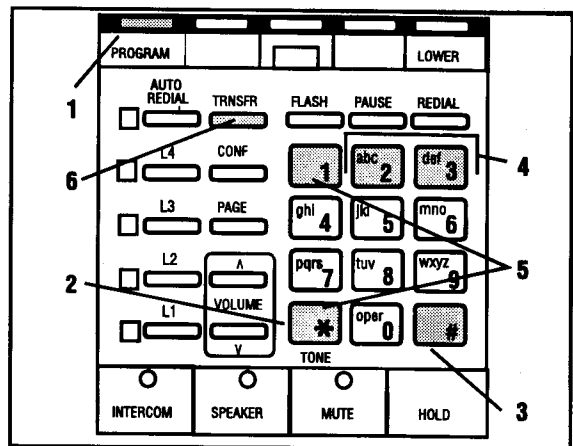

You may not be using all three phone lines, if you purchased your system with expandability in mind. For the line status to work properly, you need to turn the line status OFF for the unused line. After you expand the phone to a third line, turn the line status ON, for it to work properly. You can not turn off the line status for Line 1.

# Setting Up Your Phone

## 1

### Setting Up a Private Line

- 1 Press **PROGRAM**.
- 2 Press **\***.
- 3 Press **#**.
- 4 Enter a different line number (05-08) for each private line.
- 5 Press **HOLD**. You will hear a confirmation ring after a successful assignment.

**NOTE:** A private line, installed as Line 4, can only be used at those phones where it is installed.

Line 1's phone number must be the same on all phones for the intercom and paging features to work.

### Do Not Lift Handset

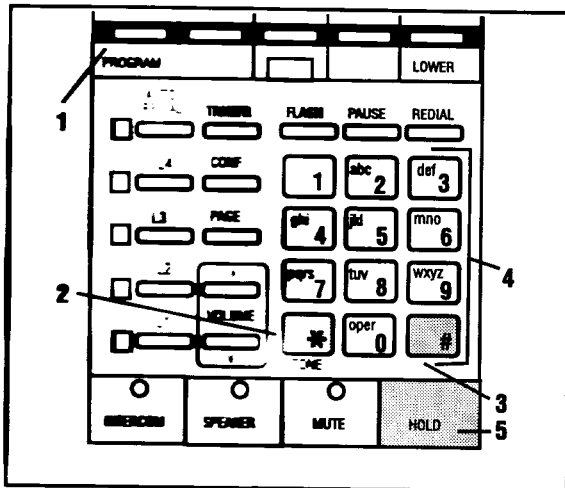

This feature only works if you have three phone lines **connected** to your telephone. Line 4 may vary from phone to phone. This line can be considered a private line, which other 854 phones cannot access.

### Changing BATTERY Display

- 1 Press **PROGRAM**.
- 2 Press **\***.
- 3 Press **#**.
- 4 Press **\***.
- 5 Enter one digit.  
0 = don't display BATTERY.  
1 = display BATTERY.
- 6 Press **CONF**. You will hear a confirmation ring if you entered the data correctly.

### Do Not Lift Handset

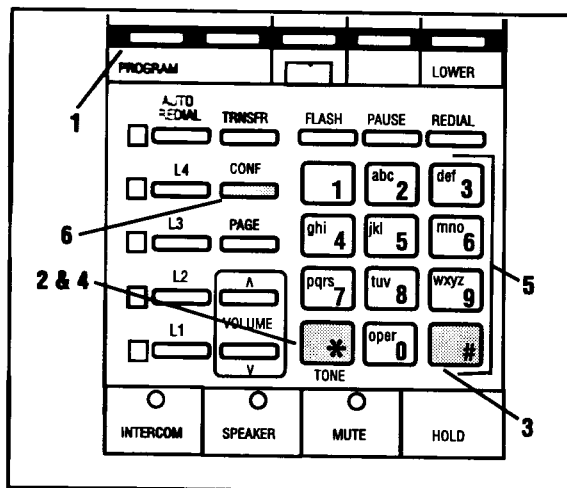

When battery power is low, BATTERY flashes on the display. Replace the batteries promptly to prevent the possibility of memory loss. To change the batteries, see page 4. You can turn off the BATTERY message by programming the phone.

## Page

- 12 Indicator lights and display messages
- 13 Making and answering a call
- 13 Call Privacy
- 14 Using the Speakerphone
- 14 Using Redial
- 15 Auto Redial
- 15 Using Hold
- 15 Switching between lines
- 16 Using Mute
- 16 Using Flash
- 16 Using Tone
- 17 Making a 3-Party conference call
- 17 Using Do Not Disturb
- 18 Transferring calls
- 18 Monitoring the length of a call
- 19 Adjusting Ringer Volume
- 19 Adjusting Volume

## SECTION

# 2

2

**Y**our new system may operate differently from other telephone systems you have used. Read this section carefully to become familiar with the many unique features of the 4-Line 854.







### *Operation at a Glance*

- Meaning of display messages and the indicator lights.
- Using speakerphone, conference calling, hold and redial.
- Turning call privacy off and on.
- Turning Do Not Disturb on and off.
- Memory features are in a separate section on page 20.
- Intercom features are in a separate section beginning on page 24.
- For summary of operation and programming, see Quick Reference card enclosed or Quick Reference on back cover.



# Operation

## Indicator Light Description

Light	Status	Pattern Over 2 Seconds
L1, L2, L3, L4 INTERCOM SPEAKER MUTE LOWER AUTO REDIAL	NOT IN USE	OFF 
L1, L2, L3, L4 INTERCOM SPEAKER MUTE LOWER	In use at another phone.  IN USE	ON 
L1, L2, L3, L4 AUTO REDIAL	Receiving a call.  Phone is redialing the number.	
L1, L2, L3, L4 INTERCOM	You are using a phone line.  Paging or making an intercom call.	
L1, L2, L3, L4 INTERCOM	You placed a phone line on hold.  Receiving an intercom call.	
L1, L2, L3, L4	Someone else placed a phone line on hold.	

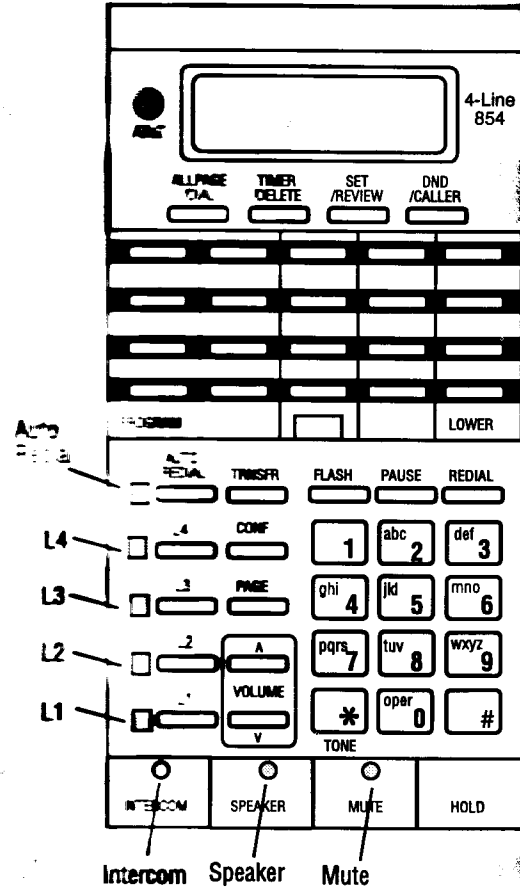

## Display Messages

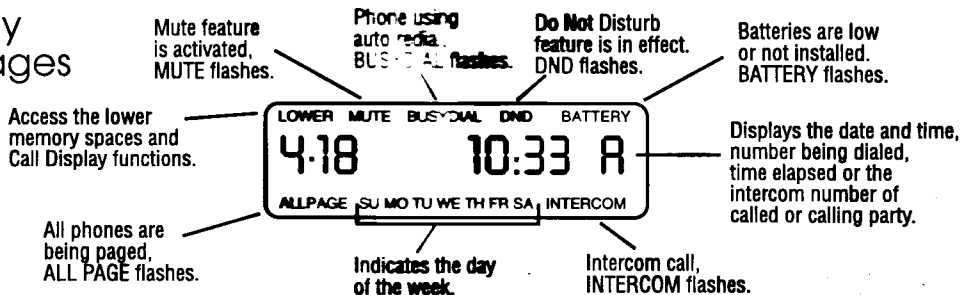

## Making and Answering a Call

- Lift handset.

OR

Press **SPEAKER**.

To override automatic line selection, press **L1, L2, L3** or **L4** **before** you lift the handset.

OR

Press the line you want to use or answer.

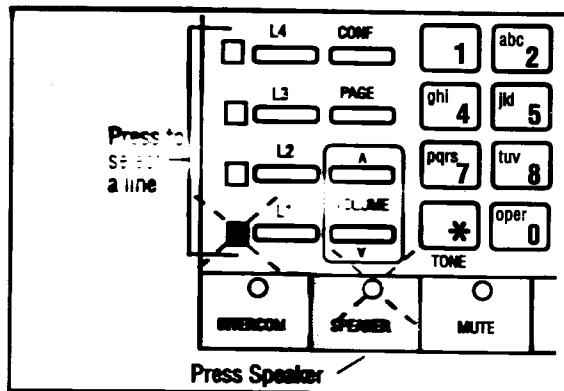

### Call Privacy:

To insure privacy, the phone allows only one person at a time to use a line.

### Cancel Call Privacy:

Press the line button for that call. You will hear a short ring tone. Others can now join your call.

### Restore Call Privacy:

During the call, press the line button again. You will hear a double ring. The other phones will be dropped from the call.

The phone restores privacy automatically when you end the call.

**W**hen you make a call, the phone selects the first available line. When you answer a call, the phone automatically selects the ringing line. To override automatic line selection, press **L1, L2, L3** or **L4** **before** you lift the handset. If you have a private line the phone automatically selects that line.

### Line-In-Use Indicators:

Whenever a line is in use, the light flashes slowly on the phone using the line. On the other phones, the light remains on, indicating someone else is using that line.

**NOTE:** When you press either **L1, L2, L3** or **L4** you automatically use the speaker-phone. If you want to use the handset, pick up the handset **after** selecting a line.

# Operation

## Using the Speakerphone for Hands-free Conversation

- 1 Press **SPEAKER**, or a line button, to activate the speakerphone.
- 2 Press **SPEAKER** again to hang up.

2

### Adjust The Speaker Volume:

Press the **VOLUME** buttons to **increase** or **decrease** volume while using the speakerphone.

**NOTE:** Whenever the speakerphone light is on, you can hang up the handset without disconnecting your call.

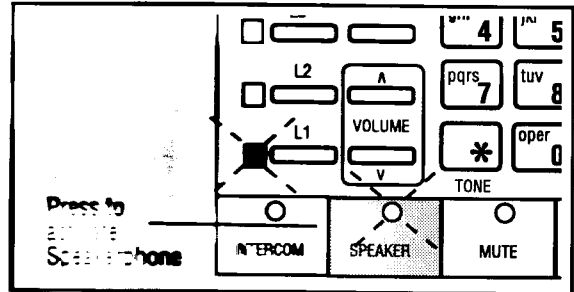

**Y**ou can use the speakerphone to make or answer a call or an intercom page. Press **SPEAKER** instead of **lifting the handset**. The **SPEAKER** light is on when the speakerphone is in use. All features of the phone work the **same** when you use the speakerphone.

During a call you can switch back and forth from handset to speakerphone as often as you like. You press **SPEAKER** to activate the speakerphone while using the handset. To cancel the speakerphone, lift the handset.

## Using Redial

- Press **REDIAL** to redial the last phone number you dialed.  
The **SPEAKER** light and the first available line light will turn on.

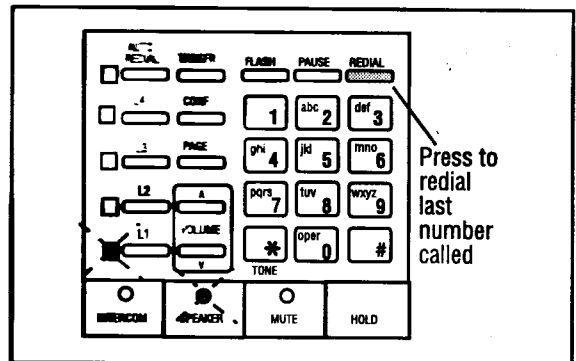

**T**he telephone always remembers the last number dialed. Each time you dial, the phone automatically stores in memory the number you called.

When you use **REDIAL**, you hear the number being dialed and whether the number is busy or unanswered.

# Operation

## Using Auto Redial

- 1 Press **AUTO REDIAL** to redial the last phone number you dialed.
- 2 When the call is answered, lift the handset or press **SPEAKER**.

### To Cancel AUTO REDIAL

- Press **SPEAKER** twice.

## Using Hold

- Press **HOLD** to keep a call on the line.  
Once a call is on hold any 854 phone can take the call off hold.

### To Cancel Hold

- Press the line button of the line on hold.

**NOTE:** You can not put an intercom call on hold.

The **auto redial** feature is useful when you are trying to reach a busy number. The phone will continually dial up to **10** times, the number until the other line is free. On the display, the number being dialed appears and **BUSYDIAL** flashes. If you want to select the line that is used to redial a number, first select the **desired** line THEN press **AUTO REDIAL**.

2

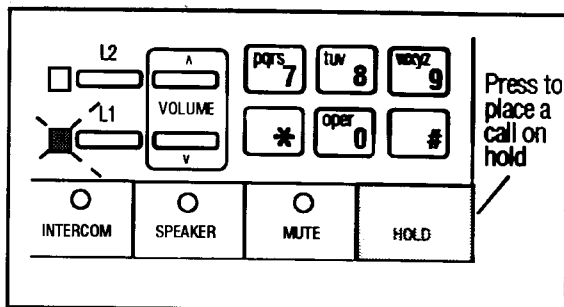

While a call is on hold, you can replace the handset without disconnecting your call. Press the line button to return to your call.

The light of the line on hold flashes. While the light flashes, you and your caller cannot hear one another.

As a reminder, a double beep sounds every 30 seconds to alert you a call is still on hold.

## Switching Between Lines

- 1 Press **HOLD** to keep a call on the line.
- 2 Press another line button to make or answer another call.

### To Hold second call:

Press **HOLD**, then press **first line** button to return to your original call.

OR

### To Drop second call:

Press the line button of **the first call**. The call on the second line is dropped.

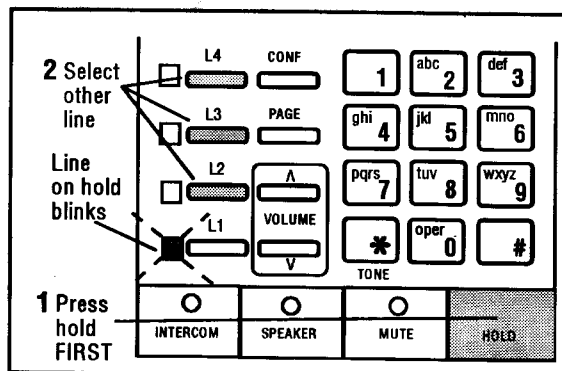

Whether you use the handset or the speaker-phone, use the **HOLD** feature to switch back and forth between lines as necessary.

# Operation

## Using Mute

- 1 Press **MUTE** for privacy so the other person can't hear you.
- 2 Press **MUTE** again to resume your telephone conversation.

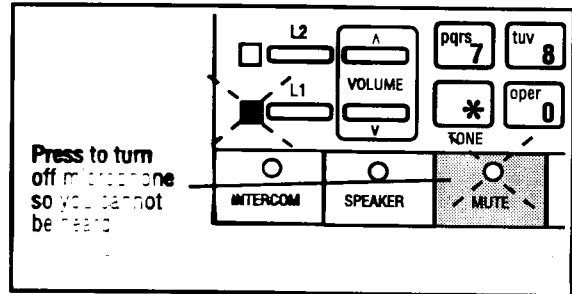

**T**he Mute feature turns off the microphone so the person at the other phone cannot hear you. When you use the mute feature, the Mute light turns on.

The Mute button works whether you are using the handset or the speakerphone. It silences only your voice; you will still be able to hear the other person on the telephone.

The Mute feature automatically cancels when you hang up, change lines, put a call on Hold, or switch from handset to speakerphone during a call.

## Using Flash

Press **FLASH** instead of the switchhook when using custom calling services.

**T**he Flash feature is useful if you have subscribed to custom calling services from your local telephone company. You press **FLASH** instead of pressing the switchhook to activate services such as call waiting or 3-way calling.

You may have to press other buttons before or after the Flash button, as explained in custom calling instructions provided by your local telephone company. You may store the Flash function and an associated custom calling sequence in a memory location (see page 23). Use the Flash button only as a substitute for pressing the switchhook.

## Using Tone

- 1 Dial a number.
- 2 Press **TONE** or **\***; all keys pressed after this will send tone signals.
- 3 After you hang up, the phone returns to rotary service.

**T**he Tone feature lets you change from pulse to tone dialing during a call if you have rotary service.

# Operation

## Making a 3-Party Conference Call

- 1 Make or answer a call.
- 2 Press **HOLD**.
- 3 Call someone on another line.
- 4 After the third party answers, press **CONF**. The three party conference begins immediately.
- 5 To end a conference call, hang up. All parties will disconnect.

### To Talk Privately With One Party:

- 1 Press **HOLD** to place both lines on hold.
- 2 Press a line button to talk privately with the person on that line.
- 3 Press **CONF** to resume conference call.

### To Drop One Line:

Press the **line** button of the party with whom you wish to remain talking. The other line will drop.

## Using Do Not Disturb

- 1 Press **DND** to prevent interruptions by incoming calls or by intercom pages.
- 2 Press **DND** again to resume your normal call alerting.

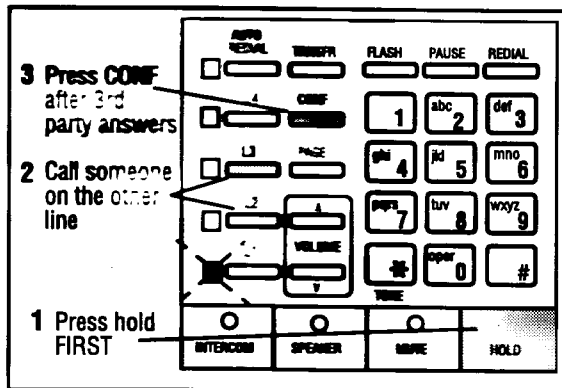

**T**he Conference Call feature lets you set up a three-party call by using two lines at the same time. You can also join an intercom call with a call on an outside line. See page 26.

### Conference Call Hold:

Press **HOLD**. Both lines are on hold. As in the regular hold feature, no one will be able to hear the others.

### To Release Conference Call Hold:

- 1 Press one line button.
- 2 Press **CONF**.



**T**he Do Not Disturb feature is useful to temporarily prevent interruptions during meetings or telephone conversations.

When you activate the Do Not Disturb feature, DND flashes on the display. You will not hear paging tones, voice paging, or incoming call rings. The line light flashes and the INTERCOM light turns on to signal a call or page. If you receive an intercom call, the INTERCOM light flashes and the intercom number calling you appears on the display.

# Operation

## Transferring a Call

Unannounced	Announced
<ol style="list-style-type: none"> <li>1 Answer or make a call by using the handset or speakerphone.</li> <li>2 Press <b>TRNSFR</b>.</li> <li>3 Enter the ICM number.</li> <li>4 Hang up.</li> </ol>	<ol style="list-style-type: none"> <li>1 Answer or make a call by using the handset or speakerphone.</li> <li>2 Press <b>PAGE</b> or <b>INTERCOM</b>.</li> <li>3 Enter the ICM number.</li> <li>4 Announce the call.</li> <li>5 Return the handset to the cradle. If you used the speakerphone, press <b>SPEAKER</b> to end your call.</li> </ol>

2

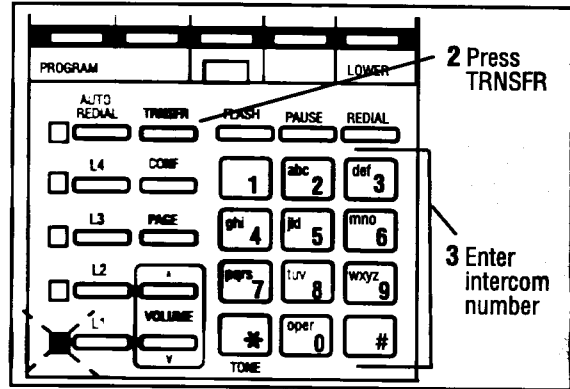

The Transfer feature lets you receive an incoming call and redirect it to any 854 phone. You can transfer a call in two ways, unannounced or announced. An unannounced call alerts the other person by ringing. An announced call lets you verbally alert the other person that they have a transferred call.

## Answering a Transferred Call

Unannounced	Announced
Pickup handset or press line button to use speakerphone.	After you receive the page, press the line button the call is on.

Until the other person picks up the call, your phone will remind you every 30 seconds that the call has not been answered. Once you transfer a call, any 854 phone can answer the call. It doesn't have to be the intercom number you called.

To transfer an unannounced call, press **TRNSFR**, enter the intercom number and hang up. The phone receiving the transfer rings. To transfer an announced call, press either **PAGE** or **INTERCOM**, and enter the intercom number to receive the call. Begin talking to let the other person know they have a transferred call.

## Monitoring the Length of a Call

Press **TIMER** to start the timer.  
Press **TIMER** to stop the timer.

The built-in timer allows you to measure elapsed time. The telephone displays time in minutes and seconds. The timer automatically stops when you hang up. The recorded time remains on the screen for about six seconds.

# Operation

## Adjusting Ringer Volume

- 1 Press **CONF**, then using the dialpad, press either **1**, **2**, **3** or **4** to indicate which line you want to adjust.
- 2 Press one of the **VOLUME** buttons to increase or decrease the ringer volume.

## Turning Ringer Off

- 1 Press **CONF**.
- 2 Using the dialpad, press either **1**, **2**, **3**, or **4** to indicate which line you want to adjust.
- 3 Press the down **VOLUME** button until you no longer hear a tone.

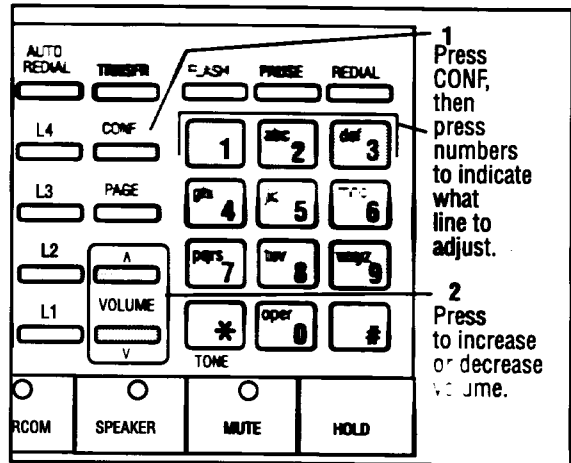

**W**hen you adjust the ringer volume you will hear a tone indicating the volume level. **There are four volume levels.**

You can adjust the ringer volume while the phone is ringing. During an incoming call, while the line is ringing, press the volume buttons to reach the desired volume level. If more than one line ringing at the same time, the ringing volume of all ringing lines will be adjusted.

## Adjusting Volume

- While using the handset, press the **VOLUME** buttons to adjust the handset volume.
- While using the **speakerphone**, press the **VOLUME** buttons to adjust the speakerphone volume.



## Page

- 21 Memory features
- 22 One-touch dialing
- 22 Two-touch dialing
- 23 Special memory features

*Dialing long phone numbers*

*Erasing a stored number*

*Entering a dialing delay*

*Storing a temporary tone signal in memory*

*Storing a switchhook flash in memory*

## SECTION

# 3

This section **describes** how to store telephone numbers into memory. You can dial these numbers by pressing one or two buttons.

### ***Memory Features at a Glance***

- Store up to 36 numbers in memory.
- Press one button to dial numbers stored in the **upper spaces**.
- Press two buttons to dial numbers stored in the **lower spaces**.
- Remove numbers no longer necessary.
- Divide long numbers and store in two memory locations.
- Insert automatic dialing delay into numbers stored in memory.
- Insert temporary touch-tone signal into stored numbers.
- Insert switchhook flash into stored numbers.

# Memory Dialing

## Memory Features

**CAPACITY:** The 854 can store 36 phone numbers, each up to 16 digits long.

**ONE-TOUCH DIALING:** The upper spaces are one-touch locations. To dial one of these numbers, press the memory button above the number or name.

**TWO-TOUCH DIALING:** The lower spaces are two-touch locations. To dial one of these numbers, press **LOWER**, then the memory button above the number or name. **LOWER** appears in the display.

**DIRECTORY CARD:** Remove the directory card and write in the numbers (or names) you want to store in each memory location.

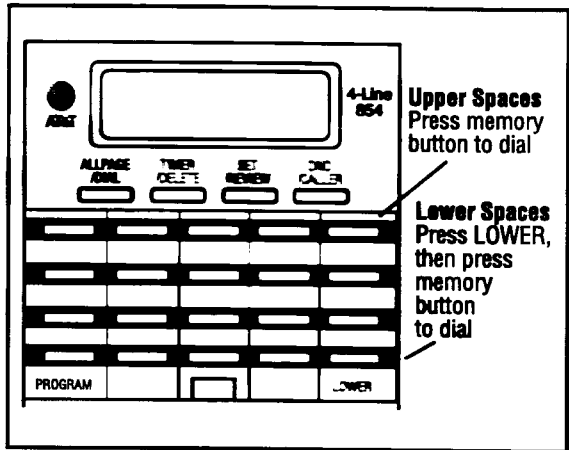

3

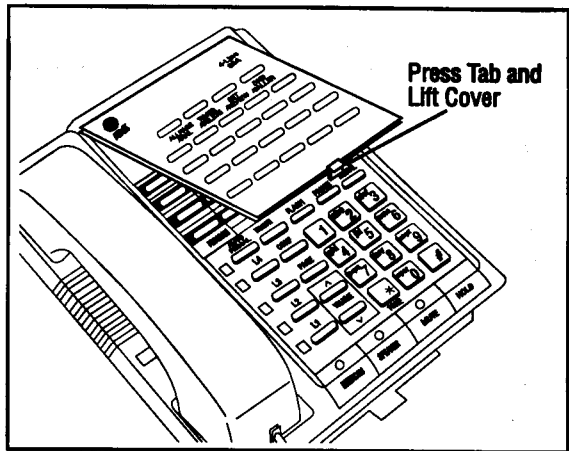

**NOTE:** You may choose to store emergency phone numbers in memory locations. AT&T provides memory dialing only as a convenience. AT&T assumes no responsibility for customer reliance on this memory feature.

# Memory Dialing

## One-Touch Dialing

(Upper Spaces)

### To Store In Memory

1 Press **PROGRAM**.

2 <i>Manual</i>	<i>Redial Number</i>
Enter the number from the dial pad.	Press <b>REDIAL</b> .

3 Press memory button where you want the number stored.

### To Dial

- Press Memory button.

OR

1 Lift handset or press **SPEAKER**.

2 Press Memory button.

**To Dial**  
Press memory button to dial numbers in upper spaces.  
Press LOWER then press memory button to dial numbers in lower spaces.

**To Store**  
Press **PROGRAM**, enter phone number, (if storing in a lower space, press **LOWER**), then press a memory button.

The upper locations on the directory card are One-Touch memory locations. Press the button above the number to dial the number stored in these locations.

The lower locations on the directory card are Two-Touch memory locations. Press **LOWER**, then the button above the number to dial the number stored in these locations.

While you program, the display clears and the numbers you enter appear on the display. You can enter up to 16 digits. If you need to store more than 16 digits see 'Dialing Long Phone Numbers' on the opposite page.

**NOTE:** You will hear one beep after you enter a number into a memory location. This means you stored the number correctly.

## Two-Touch Dialing

(Lower Spaces)

### To Store In Memory

1 Press **PROGRAM**.

2 <i>Manual</i>	<i>Redial Number</i>
Enter the number from the dial pad.	Press <b>REDIAL</b> .

3 Press **LOWER**. 'LOWER' appears on the display.

4 Press Memory button where you want the number stored.

5 Press **LOWER** to cancel 'LOWER'.

### To Dial

- Press Memory button.

OR

1 Lift handset or press **SPEAKER**.

2 Press **LOWER**. 'LOWER' appears on the display.

3 Press Memory button.

4 Press **LOWER** to cancel 'LOWER'.

## Special Memory Features

### Dialing Long Phone Numbers

You can store numbers longer than 16 digits in different memory locations. When you store a number, it can be in both upper and lower spaces of a memory location. See page 22 to store. To dial, press the memory button and wait for dialing to stop. Press the other memory button. Be sure to press **LOWER** if necessary.

### Erasing a Stored Number

To remove a number from memory, you can simply store another number in its place. To clear a memory location and leave it empty:

- 1 Press **PROGRAM**
- 2 Press **PAUSE**.
  - For Two-Touch memory locations, press **LOWER**.
- 3 Press memory button to be erased.

### Entering a Dialing Delay

You can program a pause/delay into a memory dialing position for use with certain banking and long-distance services, or to obtain an outside line when using a business telephone system. To insert a dialing delay in a phone number you are storing, press **PAUSE**.

Each time you press **PAUSE**, a 2.3 second delay occurs in the dialing sequence. For example, if your telephone is connected to a switchboard (PBX), you would enter the access number, dialing delay, and then telephone number into memory. See page 22 for storing and dialing instructions.

### Storing a Temporary Tone Signal in Memory

If you have selected the pulse dialing mode, you may store the **TONE** signal as part of the stored number. For example, you may store a dialing sequence that includes the phone number you will dial in pulse mode followed by the **TONE** signal and any additional numbers you will dial in touch-tone mode.

As you store the dialing sequence in the phone (see page 22), press **TONE** at the appropriate point in the sequence.

### Storing a Switchhook Flash in Memory

You can use the switchhook flash to activate custom-calling services, such as call waiting or 3-way calling. You may store a switchhook flash as part of a custom-calling dialing sequence. Press **FLASH** at the appropriate point in the sequence.

# Intercom Operation

## Page

- 25 What you should know about the intercom
- 26 Making and answering an Intercom call or page
- 27 Paging all phones
- 27 Monitoring a room
- 28 Making an intercom conference call
- 28 Determining your Intercom number

## SECTION

# 4

**T**his section describes how to program and use the intercom. Remember that the intercom channel is private; while you are talking with someone on the intercom, no one else can join your conversation.

### *Intercom Features at a Glance*

- To **page** another phone.
- To **page** all intercom phones.
- To **set up** a conference call.
- To use **the** intercom to monitor sounds in **another** room.

# Intercom Operation

## What You Should Know About The Intercom

**B**efore you use the Intercom features take a moment to read through this section. During a single-phone page, only one phone receives the voice announcement. During a system-wide page, all phones receive the voice announcement.

When you receive a system-wide page, you will hear a voice announcement unless your telephone is in use. If you activate the Do Not Disturb (DND) feature, you will not hear paging signals or intercom calls.

An intercom call or a single-phone page automatically activates the speakerphone unless you lift the handset.

You can use the first 12 memory buttons to make intercom and page calls. The first 12 memory locations correspond to stations 11 through 22.

## Basic Intercom Operations

- INTERCOM** any two stations connected to Line 1 can ring each other.
- PAGE** lets you "announce" over the built-in speaker of the person you are calling. Lets the person you've called respond just by talking.
- ALLPAGE** lets you "announce" to all 854 phones in the system at once.
- CONF** lets you connect another intercom call with an outside call.
- TRNSFR** lets you receive an incoming call and redirect it to any 854 phone on the system. (see page 18).

4

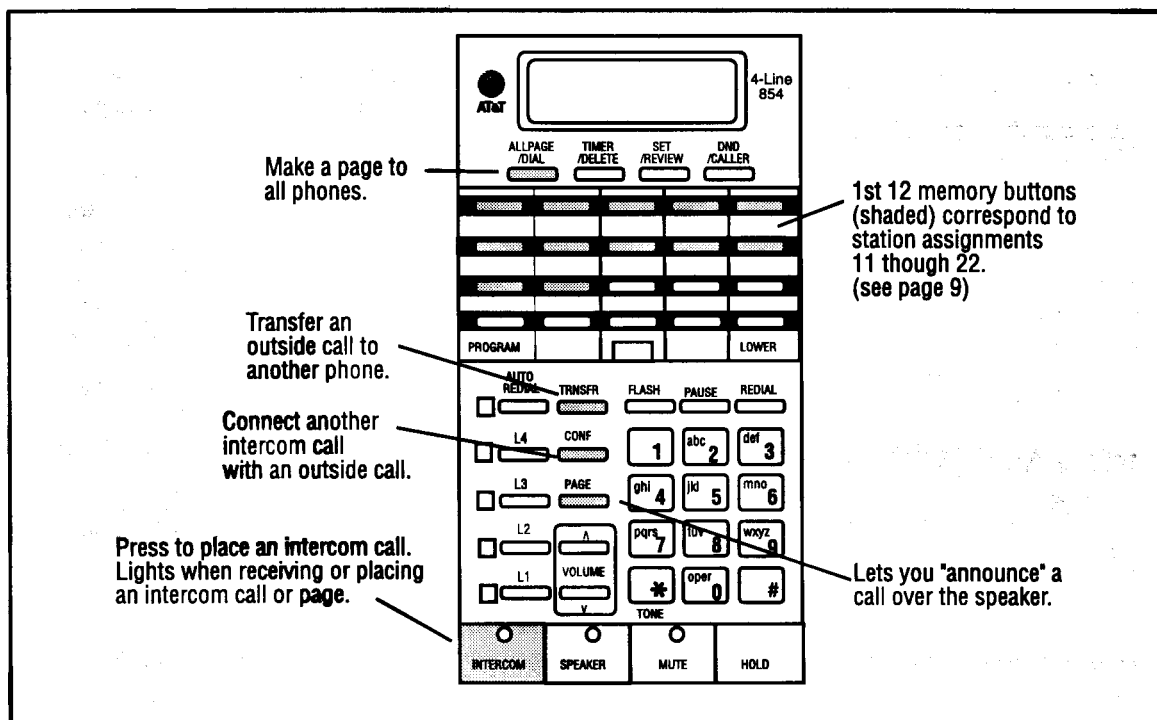

# Intercom Operation

## Making an Intercom Call or Page

- 1 Lift the handset and press **INTERCOM** or press **PAGE**. You will hear a tone.
- 2 Enter the desired station number.

OR

Press the corresponding memory button.

INTERCOM CALL	PAGE
On the display the station number of the phone receiving the call appears. INTERCOM flashes and the phone beeps until someone answers. After someone answers, begin talking or pick up the handset.	Begin talking. On the display, the station number of the phone being paged appears. PAGE flashes and the INTERCOM light flashes.

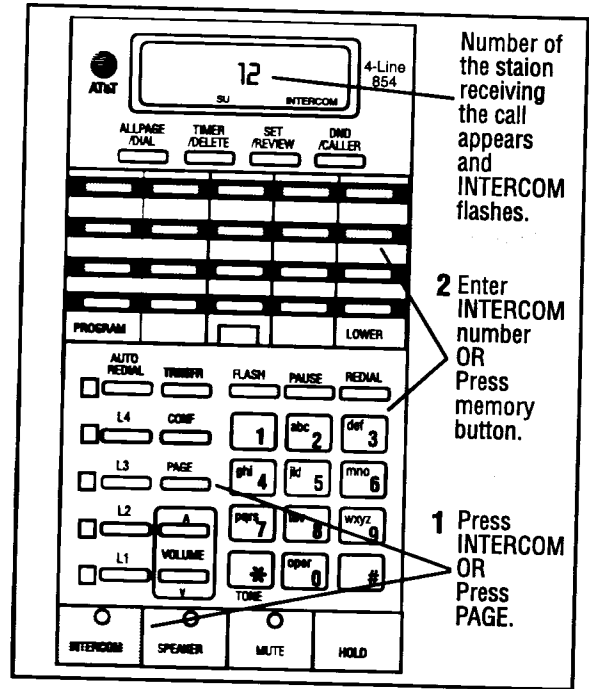

Number of the station receiving the call appears and INTERCOM flashes.

2 Enter INTERCOM number OR Press memory button.

1 Press INTERCOM OR Press PAGE.

4

## Answering an Intercom Call or Page

INTERCOM CALL	PAGE
Press <b>SPEAKER</b> or <b>INTERCOM</b> . OR Lift handset and begin talking. The station calling you appears on the display.	You will hear a beep tone to let you know a voice call is coming. The station calling you appears on the display. Begin talking or pick up the handset.

## Ending An INTERCOM Call or Page

- Press **SPEAKER**.

When you press **INTERCOM** or **PAGE**, your speakerphone automatically turns on. During an **INTERCOM** call, the phone being called rings twice. During a **PAGE** you immediately begin talking. Once someone answers your intercom call, you can talk immediately using the speakerphone or the handset.

You will hear a slow busy signal if the other phone is busy. If the other phone is in Do Not Disturb mode, you will hear a fast busy signal. The other person will hear a double ring and see your **INTERCOM** number on the display. This lets them know they were called and who called them.

If you activate Do Not Disturb (DND), the station number of the phone sending the **INTERCOM** call appears on the display, **INTERCOM** flashes and no sounds occurs.

While on a call, **INTERCOM**, **PAGE**, and **ALLPAGE** automatically put the call on hold.

**NOTE:** When you direct an intercom call to one station, any station in the system can answer the call.

# Intercom Operation

## Paging All Phones

- 1 Press **ALLPAGE** or **PAGE \***.
- 2 Speak toward telephone and announce your message.
- 3 Press **SPEAKER** to hang up.  
If you prefer, you can lift the handset and talk after you hear the paging tone. **ALLPAGE** flashes on the display.

## Answering an All Page

- 1 Press **ALLPAGE** or **PAGE**.
- 2 Begin to converse or lift handset and begin talking.
- 3 To end, return the handset to the cradle or press **SPEAKER**.

## Monitoring a Room

- 1 Press **PAGE**.
- 2 Enter the station number of the telephone to be monitored.
- 3 Press **MUTE** if you want to prevent sounds in your room from being heard at the monitored phone.
- 4 To end monitoring, hang up or press **SPEAKER**. The remote phone will disconnect immediately.

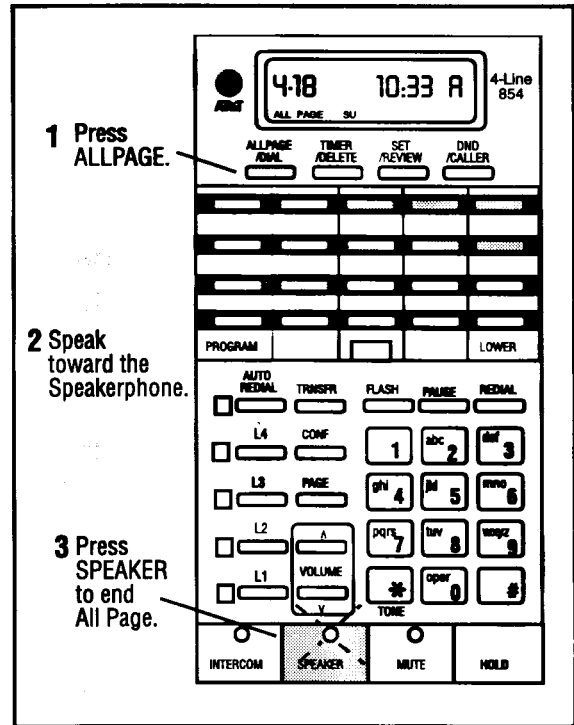

**W**hen you press **ALLPAGE**, the speakerphone automatically activates. A short tone sounds at each telephone. On other displays, the **INTERCOM** number of the phone making the page appears. The phones in Do Not Disturb mode are silent.

On every telephone, **ALLPAGE** flashes on the display and the **INTERCOM** light remains on until someone answers. When answered, **ALLPAGE** disappears from the display and the **INTERCOM** light flashes slowly.

**Y**ou can activate the speakerphone of another phone to monitor sounds in that room.

When you page the other phone in a remote location, it sounds a warning tone, and its speakerphone activates. It remains on, allowing you to hear sounds in the room until you hang up.

To prevent sounds from being transmitted to the monitored room you must press **MUTE** on your phone.



# Intercom Operation

## Making an Intercom Conference Call

- 1 Make or answer an outside call.
- 2 Press **INTERCOM** and enter the intercom number.
- 3 After the 3rd party answers, press **CONF**.
- 4 To end an Intercom Conference call, hang up.

**NOTE:** An Intercom Conference call cannot be put on hold.

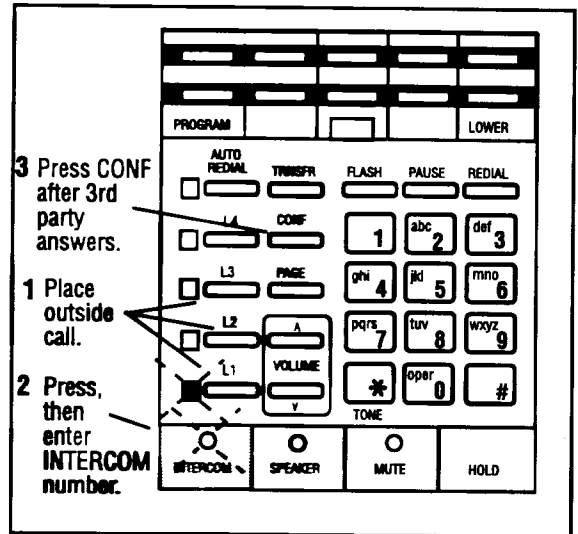

**T**he Intercom Conference Call feature lets you bridge an outside call **with** an intercom call. The remaining 854 stays connected to the outside. The person at either 854 phone can leave the conference call by hanging up.

4

## Determining Your Intercom Number

- 1 Press **INTERCOM**.
- 2 Use the dial pad to enter an intercom number (11 to 22).
- 3 Press **SPEAKER** to hang up.
- 4 Repeat steps 1-3 until the intercom light goes off. The last number entered is your intercom number.

**NOTE:** If the LED remains on after entering the numbers 11 through 22, your phone does not have an Intercom number. See page 9 for assigning intercom numbers.

## Page

## SECTION

# 5

- 30** In Case of Difficulty
- 32** Using other telephones with your 854
- 33** Expanding your 854 system
- 34** Centrex operation
  - Setting up your phone for Centrex use*
  - Using Centrex*
- 37** AT&T limited warranty and maintenance
- 38** FCC information
- 39** Index

# In Case of Difficulty

## Problem

## Actions

No dial tone

Make sure all **plugs are connected** properly. Inspect the line cord connections at **the modular jack** and at the telephone. Inspect the handset **cord connections** at both ends. Also the line may need to be enabled, **see page 9**.

If possible, check **your jack wiring** by testing a non-System telephone at **the jack** in question. If it doesn't work, local telephone company lines or your own wiring may be causing the problem. If you cannot resolve the problem, call 1 800 222-3111 for assistance.

Calls cannot be dialed

If you cannot **dial any number successfully** using the tone dialing method, your **home may have dial pulse** (rotary) service. See **page 9** to set the dial mode to PULSE.

Interfering noise is heard on intercom or phone calls

The 854 **uses sensitive circuitry** (for easier installation) that may pick up interference in environments with excessive electrical noise (e.g., near arc welding equipment). To minimize interference, keep **electrical noise sources away** from telephone wiring and sets.

Telephone lights flutter continuously

- If **telephone lights flutter**, power may have been interrupted.
- If the AC outlets is controlled by a wall switch, be sure the wall switch is **turned on**.
- Check the **power cord on the system phones**, and check the **fuse or circuit breaker on the circuit** that serves the phones.
- Make sure the jack is working by connecting a non-System telephone to the **jack**.
- Make sure **line assignments are correct** on all phones and all 854 telephones are connected to the line designated as L1.

Difficulty entering numbers into memory

- Make sure **you are pressing** the correct sequence of buttons.
- Make sure the telephone is idle while you are entering numbers.

A number **may not be entered** into memory, or may be entered **incorrectly**, if you lift the handset or press **SPEAKER** while entering a number.

Telephone does not ring

- Check to make sure **Do Not Disturb** feature is not activated.
- Check to make sure **ringers are turned on**.
- If there are several non-System telephones on the line that doesn't ring, disconnect some of them. Having many telephones **connected** can also create problems such as low ringer volume for non-System telephones.
- If **INTERCOM** light flashes but you hear no paging signal, check to make sure **Do Not Disturb** feature is not activated.

# In Case of Difficulty

Problem	Actions
Intercom paging signals not received	<ul style="list-style-type: none"><li>• Check to make sure you have programmed your intercom number correctly.</li></ul>
Cannot join a conversation in progress	The 854 Privacy feature prevents another 854 set from interrupting a conversation. Make sure you press the line button to release privacy.
Line lights are on even though no line is connected	Make sure the system is programmed for that line being absent (see page 9).
Tone signals do not activate a remote device	<ul style="list-style-type: none"><li>• Tone signaling does not work during conference calls.</li><li>• The phone generates tones of fixed duration, which may not be long enough to activate some devices such as answering machines.</li></ul>
Answering machine does not answer on line	Telephone answering machines must connect directly to the line. If you have a two-line answering machine, it must connect to a two-line jack, or to two jacks on different lines.
Operation during a power failure	The 854 does not operate during a power failure. You should have a non-854 telephone to use during a power failure
Numbers stored in a memory location not dialed correctly	You can store up to 16 digits in a memory location. If the number stored did not dial correctly, you may have stored more than 16 digits. See page 23 'Special Memory Features, Dialing Long Phone Numbers'.
Cannot use DND, TIMER, ALLPAGE or SET	Make sure "LOWER is NOT on. If LOWER appears in the display press LOWER to turn it off.
Difficulty dialing long distance Caller ID numbers	You do not need to add a "1" before dialing the number. The 854 adds a "1" before dialing.
Other problems	Make sure you have followed all the instructions in this booklet. If you continue to have problems, call the AT&T National Sales and Service Center at 1 800 222-3111. If you cannot correct the problem, disconnect the telephone and refer to the AT&T Limited Warranty section on page 37.

## Using other telephones with the 854

Using other telephones with your 854

Most standard modular telephones can be used with the 854 telephones. All features of the non-system telephones will operate normally. They may not share many features of the 854.

Line use

Single-line phones connected to a one-line jack can use only that line. Only two-line phones, if connected to both lines, can use both lines.

Line Privacy

Line privacy is not observed by non-system telephones. A non-system phone on any line has access to that line at all times, whether or not it is being used by another telephone.

Intercom

Non-system phones cannot use the intercom feature to communicate with other telephones.

Calls on Hold

Calls placed on hold at a 854 phone can be retrieved by non-system phones. However, the call is still on hold on the 854 phone. You will have to release the call from hold at an 854 phone.

R.E.N. numbers

To make sure you do not install too many telephones, check the Ringer Equivalence Number (REN) usually printed on the back or underside of telephones. Some telephone labels may include two RENs (A and B). Check with your local telephone company to determine whether they use an A or B ringer. Then, using the appropriate REN for each phone, add up the REN numbers of all phones you'll be using on each line. If the total is more than five, you may experience problems with some phones.

# Expanding Your 854 System

## Expanding your 854 telephone system

**NOTE:** All the 854 features work in the same manner as described in the beginning of the manual.

Your 854 telephone offers a wide variety of communication possibilities. When you combine two or more 854 phones you create an interacting system. You can have up to twelve 854 phones and up to eight telephone lines. The 854 can also be used with Centrex service.

You can use the fourth line on each station as a private line. The diagram below illustrates each station having access to three lines. Notice the fourth line is not the same on every station. See "Setting Up a Fourth Line for Each Station" on the next page. This diagram also applies to Centrex users.

Lines in System

	L1	L2	L3	L4	L5	L6	L7	L8
ICM11	✓	✓	✓					✓
ICM12	✓	✓	✓			✓		
ICM13	✓	✓	✓				✓	
ICM14	✓	✓	✓	✓				
ICM15	✓	✓	✓	✓				
ICM16	✓	✓	✓		✓			
ICM17	✓	✓	✓			✓		
ICM18	✓	✓	✓				✓	
ICM19	✓	✓	✓		✓			
ICM20	✓	✓	✓		✓			
ICM21	✓	✓	✓	✓				
ICM22	✓	✓	✓					✓

## Setting up your phone for Centrex use

### Setup Checklist

Before expanding your system or installing for Centrex, review the installation checklist. If you have Centrex contact your local telephone company for further information about Centrex service.

- Line 1's phone number must be the same on all phones in order for the Intercom and Paging features to work.
- Determine the number of phones that will be on the system.
- Identify the phone that will be the attendant phone.
- Identify the private line for the attendant phone. The attendant phone must have its own private line. This line is not shared with any other phone.
- Follow the regular installation instructions pp. 4-10.
- Enable attendant phone.
- Store the Centrex pick-up codes and the seven-digit phone numbers into memory locations. See "One-Touch and Two-Touch Dialing" p 22.

### Setting Up a Fourth Line for Each Station

5

- 1 Press **PROGRAM**.
- 2 Press **\***.
- 3 Press **#**.
- 4 Enter the line number, **05-08**, you want as your fourth line; for example stations 16, 19 and 20 share Line 5. Those stations would enter 05.
- 5 Press **HOLD**. You will hear a confirmation ring.

Repeat steps 1-5 for each station on the system that will have a private line.

### Enabling/Disabling Attendant Station

This feature lets you have an attendant phone on the system. An attendant phone can pick up other Centrex lines through Centrex switching. Identify which station you want as the attendant. The attendant phone should also have a private line. Notice in the sample, on the opposite page, intercom station 11 uses Line 8 as its private line.

- 1 Make sure you are on hook.
- 2 Press **PROGRAM**.
- 3 Press **\***.
- 4 Press **#**.
- 5 Press **\***.
- 6 Press **1** to enable. Press **0** to disable.
- 7 Press **MUTE**. You will hear a confirmation ring after you press MUTE.

## Using Centrex

### Attendant Operation

Once another 854 phone has enabled its delayed ring, the attendant phone will receive those calls. All the 854 features work in the same manner as described in the beginning of the manual.

The attendant phone can pick up other Centrex lines through Centrex switching. The attendant can store the Centrex pick-up codes and the seven-digit phone number of each station, except for the attendant phone, into memory locations.

### Setting the Ring Delay Duration

This feature allows other 854 telephones' calls to ring at the attendant phone. After a specified ring delay, the calls will ring at the attendant phone. For a 10 second delay before the calls ring at the attendant phone, enter 10.

- 1 Press **PROGRAM**.
- 2 Press **\***.
- 3 Press **#**.
- 4 Enter the duration in the number of seconds (01-30).
- 5 Press **MUTE**. After a successful completion, you will hear a confirmation ring.

### Canceling the Ring Delay

- 1 Press **PROGRAM**.
- 2 Press **\***.
- 3 Press **#**.
- 4 Enter **00** from the dial pad.
- 5 Press **MUTE**. After a successful completion, you will hear a confirmation ring.



# Centrex Operation

## Answering a Delayed Ring

Attendant phone rings and on the display appears the intercom number of the station sending the delayed ring.

- 1 Select a free line
- 2 Enter the Centrex pick-up code.
- 3 Enter the seven-digit phone number for the station sending the delayed ring.

**OR**

*Press the corresponding memory locations for the Centrex pick-up code and the seven-digit phone number for the station sending the delayed ring.*

**NOTE:** If the attendant is using another line and receives a delayed ring, the attendant phone can put the other line on hold and follow steps 1 through 3. If the attendant is on an intercom call, the intercom call should be ended before picking up the ringing phone.

## Pick Up Another Station's Line

- 1 Choose a free Centrex line.
- 2 Enter the Centrex pick-up code.
- 3 Enter the seven-digit phone number of the line you want.

**OR**

*Press the corresponding memory locations for the Centrex pick-up code and the seven-digit phone number for Line 4 of that station.*

# AT&T Limited Warranty and Maintenance

## AT&T Limited Warranty

*This warranty applies only to AT&T products purchased and used in the United States.*

### What is covered:

Any defect in materials or workmanship.

### For how long:

One year.

### What we will do:

If your AT&T product is defective and returned within 30 days of the date it was purchased, we will replace it at no charge to you. If returned after 30 days but within one year of the date of purchase, we will repair it or, at our option, replace it at no charge to you.

If we repair your AT&T product, we may use new or reconditioned parts. If we choose to replace your AT&T product, we may replace it with a new or reconditioned one of the same or similar design. The repair or replacement will be warranted for either (a) 90 days or (b) the remainder of the original one-year warranty period, whichever is longer.

### Limitations:

**Implied warranties, including those of fitness for a particular purpose and merchantability (an unwritten warranty that the product is fit for ordinary use), are limited to one year from date of purchase. We will not pay for loss of time, inconvenience, loss of use of your AT&T product, or property damage caused by your AT&T product or its failure to work, or any incidental or consequential damages.**

Some states do not allow limitations on how long an implied warranty lasts or the exclusion of incidental or consequential damages, so the above exclusions or limitations may not apply to you.

### What we ask you to do:

To get warranty service for your AT&T product, you must provide proof of the date of purchase. Within 30 days of the date it was purchased, return your AT&T product to your place of purchase for immediate replacement. After 30 days, call us toll free at 1 800 222-3111 for the address of an authorized service location. If you ship your AT&T product to the authorized service location, you must pay shipping costs. We suggest you retain your original packing material in the event you need to ship your AT&T product. When sending your AT&T product to a service location, include your name, address, phone number, proof of date of purchase, and a description of the operating problem. After repairing or replacing your AT&T product, we will ship it to your home in the United States at no cost to you. Repair or replacement of your AT&T product at an authorized service location is your exclusive remedy.

### What this warranty does not cover:

This warranty **does not** cover defects resulting from accidents, damage while in transit to our service location, alterations, unauthorized repair, failure to follow instructions, misuse, use outside the United States, fire, flood, and acts of God. Nor do we warrant your AT&T product to be compatible with any particular telephone equipment or party line, key telephone systems or more sophisticated customer premises switching systems. If your AT&T product is not covered by our warranty, call us toll free at 1 800 222-3111 for advice as to whether we will repair your AT&T product and other repair information, including charges. We, at our option, may replace rather than repair your AT&T product with a new or recondition one of the same or similar design. The repair or replacement will be warranted for 90 days.

This warranty is the **only one** we give on your AT&T product, and it sets forth all our responsibilities regarding your AT&T product. There are **no other express warranties**.

### State Law Rights:

This warranty gives you **specific** legal rights, and you may also have other rights which vary from state to state.

## Maintenance Information

Although your telephone is designed to be maintenance-free, it contains sensitive electronic parts. Treat it with care to ensure best performance.

### Avoid Rough Treatment

Avoid dropping the handset, and **replace it gently** on the telephone after use. The original packaging should be used for protection if you must ship the telephone.

### Cleaning

The hard plastic case of your telephone has a durable finish that should retain its original luster for many years. Clean exposed parts with a soft, slightly damp cloth. To remove stains, use a mild soap. Never use detergents, excess water, treated cloths, harsh cleaning agents or sprays.

## FCC Registration and Repair Information

Your new AT&T product has been registered with the Federal Communications Commission (FCC). This product complies with standards in Part 68 of the FCC Rules. The FCC requires us to provide you with the following information:

### 1. Connection and use with the nationwide telephone network:

An FCC compliant telephone cord and modular plug are provided with this telephone. This telephone is designed to be connected to the telephone network or premises wiring using a compatible modular jack which is Part 68 compliant. See "Installation Instructions in Owners Manual".

This equipment may not be used with Party Line Service or with Coin Telephone Lines.

### 2. Notification to the telephone company:

The FCC requires that upon request of your local telephone company, you provide the following information:

- A. The "line" to which you will connect the telephone equipment (that is, your phone number), and
- B. The telephone equipment's FCC registration number and ringer equivalence number (REN). These numbers are on the back or bottom of your telephone equipment.

The REN is useful to determine how many devices you may connect to your telephone line and still have them ring when your telephone line is called. In most, but not all areas, the sum of all RENs should be 5 or less. You may want to contact your local telephone company.

### 3. Repair instructions:

If it is determined that your telephone equipment is malfunctioning, the FCC requires that it not be used and that it be unplugged from the modular outlet until the problem has been corrected. Repairs to this telephone equipment can be made only by the manufacturer or its authorized agents or by others who may be authorized by the FCC. For repair procedures, follow the instructions outlined under the AT&T Limited Warranty.

### 4. Rights of the telephone company:

If your product is causing harm to the telephone network, the telephone company may temporarily discontinue your telephone service. If possible, they will notify you before they interrupt service. If advance notice isn't practical, you'll be notified as soon as possible. You will be given the opportunity to correct the problem, and you will be informed of your right to file a complaint with the FCC.

Your telephone company may make changes in its facilities, equipment, operations, or procedures that could affect the proper functioning of your AT&T product. If such changes are planned, you will be notified.

### 5. This telephone is compatible with inductively coupled hearing aids.

*The following is applicable if this product has memory dialing.*

### 6. Programming/Testing Emergency Numbers:

Although testing the programming of emergency numbers is not a recommended procedure, if you do make a call to an emergency number:

- A. You must remain on the line and briefly explain the reason for the call before hanging up.
- B. Programming/testing of emergency numbers should be performed in the late afternoon or evening (off-peak hours).

5

## Interference Information: Part 15 of FCC Rules

Some telephone equipment generates, uses and can radiate radio-frequency energy and, if not installed and used properly, may cause interference to radio and television reception.

Your AT&T product has been tested and found to meet the standards for a Class B digital device, as specified in Part 15 of the FCC Rules. These specifications are designed to provide against such interference in a residential installation. However, there is no guarantee that harmful interference will not occur in a particular installation.

If your AT&T product causes interference to radio or television reception when it's in use, you might correct the interference with any one or all of these measures:

- ➡ Where it can be done safely, reorient the receiving television or radio antenna.
- ➡ To the extent possible, relocate the television, radio, or other receiver with respect to the telephone equipment.
- ➡ If your telephone product runs on AC power, plug your product into an AC outlet that's not on the same circuit as one used by your radio or television.

If you need assistance, you can call our National Service Center at 1 800 222-3111.

**The user is cautioned that modifications to this telephone, not expressly approved by AT&T, could void the user's authority to operate the equipment.**

Answer call, 13  
Assigning Intercom Numbers, 9  
Auto Redial, 15

Base of telephone  
to remove, 6  
to reverse, 6

Battery  
battery operation, 4  
to replace, 4  
changing BATTERY display, 10

**Centrex**  
setup, 34  
operation, 35

Clearing number from memory, 23  
Conference calling, 17

Dial mode, 9  
Dial tone (**none**), 30  
Dialing, 13  
Dialing Delay, 23  
Directory card, 21  
Do Not Disturb, 17

Electric power, 4

FCC information, 38  
Flash, 16  
to store in memory, 23

Handset, 5, 6  
handset tab, 6

**INTERCOM** label, 7  
In Case of Difficulty, 30, 31  
Installation  
desk/table, 4  
wall mounting, 6

Intercom, 24-28  
intercom conference calling, 28  
and non-system phones, 32  
room monitoring, 27  
finding your intercom number, 28

Line cords, 4  
Line in use, 12  
Line privacy, 10, 13  
Line selection, 13  
Low Battery, 10  
Lower, 21

Maintenance, 37  
Memory dialing, 20-23  
One-touch, 22  
Two-touch, 22  
Mute, 16

Non-system phones, 32  
Number card, 7

One-Touch dialing, 22  
Other telephones, 32  
Operation during a power failure, 31  
Operation, telephone, 11-19  
Overview of system, i

Paging, 26  
Parts checklist, 2  
Pause (Dialing Delay), 23  
Power cord, 5  
Power Failure, 31  
Privacy, 13  
line privacy, 13  
non-system phones, 32  
Private line, 10  
Problems, 30, 31  
Programming  
intercom extension numbers, 7  
phone numbers in memory, 22  
Pulse dialing, 16

Quick Reference, back cover  
Quick Reference Card, 2

Redial, 14  
Ringer Equivalence Numbers (REN), 32  
Ringer Volume, 19  
Room monitoring, 27

Safety Information, ii  
Speakerphone, 14  
Speakerphone Volume, 19  
Switching between lines, 15

Tone dialing (Touch-Tone), 16  
Time, setting, 8  
Timer, 18  
Transferring calls, 18  
Troubleshooting, 30, 31  
Two-Touch dialing, 22

Viewing display, 12

Wall mounting, 6  
Warranty, 37